



BUILDING CODE OF AUSTRALIA

1990



PURPOSE OF AMENDMENT

The main purpose of this amendment is to-

- (i) correct general errors and anomalies of an editorial and minor technical nature; and
- (ii) update the Victoria Appendix prior to adoption of the BCA in that State.

Provisions affected by this amendment are:

Preface

Part A1 Definitions

Fire compartment, Storey

Part A3

A3.2 (Class 1, Class 3, Class 6, Class 9, Class 10), A3.3

Specification A1.3 Table 1

AS1428, AS1657,

Specification A2.3

Clauses 1, 2, 3

Specification A2.4

Clause 2

Part C1

C1.8

Part C2

C2.2(a), C2.3(b), C2.4(b), C2.5, C2.6, C2.7(a)(i), C2.12, C2.13

Part C3

C3.2(b), Table C3.3, C3.4(a), C3.5(a)(i),(c)(i), C3.7, C3.11(a)(i),(ii), C3.15

Specification C1.1

Clauses 2.4(a)(i), 2.5(d), 2.7, 3.1(a)-(e), 3.6(a),(b), 3.7, 4.1(a)-(c), 5.1(a)-(c), Table 5

Specification C1.9

Clauses 3(a)(i), 5(a), 6(a), 7(a)(i)

Specification C3.15

Clause 3(b)(i)

Part D1

D1.2(b),(d), D1.3(a),(b), D1.4(f)(i), D1.5, D1.6(a),(b)(ii),(c),(d)(ii),(e), (f)(i),(ii), D1.7(a)(i), D1.11(a)(ii), D1.12(a),(b)(iv), D1.13(a)(ii), D2.3(a),

Part D2

D2.3(c)(i), D2.3(c)(iii), D2.6(a),(b), D2.7(d)(i), D2.13(b), D2.16(b)(i),(e)(i), D2.16(f)(i),(ii), D2.17(b), D2.17(b)(iii),(iv), D2.18, D2.19(a),(b)(i),(iii), D2.21(a),(b)(i),(iii)

Part E1

E1.2(a)-(d),(f)(i), , E1.3(a)(i), E1.3(a)(ii), E1.3(a)(iii), E1.3(b)(i), E1.4(a)(ii), E1.4(b)(ii), E1.4(c), E1.5, Table E1.5

Part E2

Table E2.1, E2.4(a)(ii), E2.5, E2.7(d)

Part E3

E3.4(b)(i),(ii), E3.4(b)(iv)

Part E4

E4.2, E4.4(a)(i),(ii), E4.5(a), E4.5(a),(b), E4.5(d), E4.7(b), E4.8(a)(i),(ii), E4.9, E4.9(a),(b)(ii)

Specification E1.8

Clause 7(c)

Section F Objectives

Part F1(a),(b), Part F1(c), Part F3, Part F4

Part F1

F1.1(a), F1.4(a), F1.5(a),(b),(c), F1.7(d)(i), F1.8(a), F1.10(a)(ii), F1.11(a)

Part F2

F2.2(a), F2.3(b), F(2.3)(b)(ii), Table F2.3, Table F2.3 Notes, F2.4, F2.4(b), Table F2.3, F2.5(b)

Part F3

F3.2(a)

Part F4

F4.2(a),(b),(d)(i), F4.3(a),(b), F4.7(a)(i),(iii)

Part F5

F5.6(a)(ii), F5.6(c)(i)

Part G1

G1.3(a)(i)

Part G2

G2.1(a),(b), G2.1(c)(i), G2.3(a)(i),(ii), G2.4(a)(i),(ii),(iii)

Part G4

G4.3(a)(ii), G4.6(b)(i)

SA Appendix

SA A3.2, SA Table 1, SA B1.3, SA E1.3, SA Spec E1.2 Clause 3.4.3(b), SA Spec E1.2 Clause 5.1, SA Spec E1.2 Clause 8.4.1

Tas Appendix

H112, H114(b), H115(b), H116(b), H117(b)

Victoria Appendix

Rewritten and reissued in full.

CONTENTS

PREFACE

A GENERAL PROVISIONS

- A1 Interpretation
- A2 Acceptance of Design and Construction
- A3 Classifications of Buildings and Structures
- A4 United Buildings

B STRUCTURE

- B1 Structural Provisions
- B2 Demolition

C FIRE RESISTANCE

- C1 Fire Resistance and Stability
- C2 Compartmentation and Separation
- C3 Protection of Openings

D ACCESS AND EGRESS

- D1 Provision for Escape
- D2 Construction Exits
- D3 Access for People with Disabilities

E SERVICES AND EQUIPMENT

- E1 Fire
- E4 Fighting Equipment
- E2 Smoke Control
- E3 Lift Installations
- E4 Emergency Lighting, Exit Signs and Warning Systems
- E5 Maintenance

F HEALTH AND AMENITY

- F1 Damp and Weatherproofing
- F2 Sanitary and Other Facilities
- F3 Room Sizes
- F4 Light and Ventilation
- F5 Noise Transmission and Insulation

G ANCILLARY PROVISIONS

- G1 Minor Structures and Components
- G2 Heating Appliances, Fireplaces, Chimneys and Flues
- G3 Atrium Construction
- G4 Construction in Alpine Areas
- G5 Construction in Bushfire Prone Areas

H SPECIAL USE BUILDINGS

- H1 Theatres, Stages and Public Halls

INDEX

ABBREVIATIONS AND SYMBOLS

APPENDICES

PREFACE

ABOUT THE BCA

The Building Code of Australia (BCA) is produced and maintained by the Australian Uniform Building Regulations Co-ordinating Council (AUBRCC) on behalf of the Commonwealth, State and Territory Governments under the direction of the Local Government Ministers' Conference. The BCA is a uniform set of technical requirements and standards for the design and construction of buildings and other structures throughout Australia.

The basic objective of the BCA is to ensure that acceptable standards of structural sufficiency, fire safety, health and amenity are maintained for the benefit of the community now and in the future. Its requirements are intended to extend no further than is necessary in the public interest, to be cost effective, not needlessly onerous in their application and to be easily understood.

STATE AND TERRITORY VARIATIONS AND ADDITIONS

State and Territory legislation is able to adopt the BCA subject to the variation or deletion of some of the provisions, or the addition of extra provisions to apply in the particular State or Territory concerned. A series of Appendices to the BCA set out the nature of these variations and additions for each State and Territory.

Variations to Clauses and Tables are identified in the margin. Additional Clauses to a Part of the BCA are identified at the end of that Part and in the Section Contents. New Parts and Specifications are identified in the relevant Section Contents.

AMENDMENTS AND FUTURE EDITIONS

This edition of the BCA will remain current for at least 3 years.

Amendments will be issued from time to time as the need arises.

WHAT IS IN THE BCA ?

The BCA sets down the objectives, and, so far as it can, performance requirements and deemed-to-satisfy provisions which apply to the construction of buildings for all classes of occupancy in any part of Australia.

It allows for variations in climate and geological or geographic conditions.

It must however be recognised that a building code cannot cover every issue concerned with the design and construction of buildings. In the case of innovative, complex or unusually hazardous building proposals or other building work beyond the scope of the BCA, legislation may provide for the application to be referred to a Board or Committee of Referees.

The BCA covers those aspects of building which are controlled by legislation such as structure, fire resistance, access and egress, fire-fighting equipment, mechanical ventilation, lift installations, and certain aspects of health and amenity. It does not apply to the technical details of services such as plumbing, electrical services, lifts or moving walkways or to other aspects of design or construction not normally covered by building regulations.

OBJECTIVES OF THE PROVISIONS

Broad statements of intent are included at the beginning of each Section to identify the objectives that the provisions of the Section are intended to achieve.

The Objectives are the basic concepts which apply generally to all buildings and structures. The provisions of each Part of the BCA are accepted by the Authorities as meeting the Objectives.

PERFORMANCE REQUIREMENTS

In some cases the provisions are expressed in performance terms. Accreditation Certificates, test reports or other documentary evidence may be used as evidence that a particular material, design or construction method meets the performance requirements of the BCA.

DEEMED-TO-SATISFY PROVISIONS

Where a provision states that the use of a particular material, component, method of construction or design satisfies a performance requirement of the BCA, that provision does not require its use. An equivalent material, component, method or design may be used if it meets the level of performance prescribed by the provision concerned.

The BCA allows for Standards Mark product certification by Standards Australia to be used as evidence of compliance with particular requirements or Standards.

PROFESSIONAL CERTIFICATION

The BCA allows for certificates from professional consultants to be used as evidence of compliance with particular requirements or standards.

The enabling legislation will determine the extent of the use of professional certification and the procedures for the submission of certificates, reports or other documentation to Approval Authorities as evidence of compliance.

WORDS WITH SPECIAL MEANINGS

The words printed in italics have special meanings and are defined in Clause A1.1.

Definitions and terminology used in the BCA are as far as possible consistent with that used in State and Territory legislation, however where there is any conflict, the requirements of legislation take precedence.

ADMINISTRATIVE ARRANGEMENTS

The BCA is brought into effect by enabling building control legislation in each State and Territory which prescribes or "calls up" the technical requirements which have to be satisfied in order to gain approval.

The enabling legislation consists of an Act of Parliament and subordinate legislation and empowers the regulation of certain aspects of the building process. It also contains the administrative provisions necessary to give effect to the legislation.

Administrative-type matters covered in the enabling or subordinate legislation include-

- Plan submission and approval procedures.

SUPERCEDED

- Issue of building permits.
- Inspections during and after construction.
- Provision of evidentiary certificates.
- Issue of certificates of occupancy or compliance.
- Accreditation or approval of materials or components.
- Review and enforcement of standards.
- Fees and charges.

ADMINISTRATIVE DISCRETIONS

The BCA is drafted with the objective of reducing the need for the building authority to make discretionary decisions.

However, in many cases it is not possible to draft a provision in purely technical terms and an informed judgement is required on the standard which would be suitable in particular circumstances.

Accordingly, in a number of clauses, the BCA requires a particular material or construction method to be "suitable", meaning fit in all relevant respects for its intended purpose and use.

An authority nominated in the administrative provisions retains the right to question "suitability" and differences of opinion are open to appeal.

FURTHER DEVELOPMENT OF THE BCA

The BCA is the first stage in an on-going comprehensive reformulation and simplification of the building regulations which apply in Australia. Part of this process will be the conversion of more of the existing prescriptive requirements to performance/deemed-to-satisfy provisions.

Amendments to the BCA will be made progressively to reflect the results of research and improved technology

COMMENTS

Comments in writing on any matter concerning the text, presentation or further development of the BCA are invited from building and other authorities, industry organisations, professional operatives and the public generally. These should be addressed to-

The Directorate
AUBRCC
Department of Industry, Technology and Commerce
GPO Box 9839
CANBERRA ACT 2601.

AUBRCC

AUBRCC is responsible to the Local Government Ministers' Conference (LGMC). It is established by agreement between the governments of the Commonwealth and the States and Territories with provision for Local Government and building industry representation.

SUPERCEDED

Council - The Council reports to the LGMC on policy, procedures, research priorities and funding arrangements, and comprises the representatives of:

New South Wales	Department of Local Government
Victoria	Department of Planning and Housing
Queensland	Department of Housing and Local Government
Western Australia	Department of Local Government
South Australia	Department of Environment and Planning
Tasmania	Local Government Office
Australian Capital Territory	ACT Administration
Northern Territory	Department of Lands and Housing
ALGA	Australian Local Government Association
Commonwealth	Department of Industry, Technology and Commerce

Directorate - The AUBRCC Directorate is provided by the Commonwealth Department of Industry, Technology and Commerce.

Executive Committee - The AUBRCC Executive Committee consists of the principal building control officer from:

New South Wales	Department of Local Government
Victoria	Department of Planning and Housing
Queensland	Department of Housing and Local Government
Western Australia	Department of Local Government
South Australia	Department of Environment and Planning
Tasmania	Local Government Office
Australian Capital Territory	ACT Administration
Northern Territory	Department of Lands and Housing

and representatives from:

ALGA	Australian Local Government Association
Commonwealth	Department of Industry, Technology and Commerce

Advisers representing the private sector building industry, the Australian Assembly of Fire Authorities and Standards Australia also attend Executive Committee meetings.

Technical Adviser - The CSIRO Division of Building, Construction and Engineering is the technical adviser to AUBRCC.

Members of the following organisations with specialist expertise are included in the membership of Technical Committees:

Ancillary and General Provisions Committee

Department of Planning and Urban Growth, Victoria (chair)

Australian Institute of Building Surveyors (Vic Chapter)

Country Fire Authority, Victoria

Housing Industry Association (Victorian Division)

Institution of Engineers (Australia)

Master Builders Association of Victoria

Metropolitan Fire Brigade, Victoria

Ministry of Housing and Construction, Victoria

SUPERCEDED

Municipal Association of Victoria y

Royal Australian Institute of Architects (Vic Chapter) y

Editorial Committee

AUBRCC Directorate

Department of Planning and Housing, Victoria

Department of Local Government, NSW

Local Government Department, Qld

CSIRO Division of Building, Construction and Engineering

Fire Committee

Department of Local Government, NSW (chair)

ACT Administration

Australian Assembly of Fire Authorities

Australian Institute of Building

Australian Institute of Building Surveyors (NSW Chapter)

Building Owners & Managers Association Ltd.

Institution of Engineers, Australia

National Association of Forest Industries

CSIRO Division of Building, Construction and Engineering

Royal Australian Institute of Architects (NSW Chapter)

Health and Amenity Committee

WA Department of Local Government (chair)

Association of Consulting Engineers, Australia

Housing Industry Association (WA Division)

WA Municipal Association

Master Builders' Association of WA

Royal Australian Institute of Architects (WA Chapter)

WA Building Advisory Committee

Western Australia Fire Brigades Board

Industry Liaison Committee

Representing sectors of the building industry through:

National Building and Construction Council (chair)

Australian Institute of Building

Australian Institute of Building Surveyors

Australian Federation of Construction Contractors

Building Industry Specialist Contractors Organisation of Australia

Building Owners & Managers' Association Ltd.

Housing Industry Association

Master Builders' Construction & Housing Association, Australia

Royal Australian Institute of Architects

Services and Equipment Committee

SA Department of environment and Planning (chair)

Association of Consulting Engineers, Australia
Australian Assembly of Fire Authorities
Australian Local Government Association
Australian Fire Protection Association
Australian Institute of Building
Australian Institute of Building Surveyors (SA Chapter)
Building Owners & Managers' Association Ltd.
Institution of Engineers, Australia
Royal Australian Institute of Architects (SA Chapter)
Structural Committee
Department of Housing and Local Government, Qld (chair)
Association of Consulting Engineers, Australia
Australian Institute of Building
Brick Development Research Institute
Cement and Concrete Association
Concrete Masonry Association
Institution of Engineers, Australia
Queensland Department of Works
Queensland Master Builders' Association
Queensland University of Technology
Timber Research and Development Advisory Council

SECTION A GENERAL PROVISIONS

CONTENTS

A1 Interpretation

- A1.1 Definitions
- A1.2 Adoption of Standards and other references
- A1.3 Referenced Standards, etc
- A1.4 Differences between referenced documents and the BCA
- A1.5 Application of the BCA to a particular State or Territory

A2 Acceptance of Design and Construction

- A2.1 Suitability of materials
- A2.2 Evidence of suitability
- A2.3 Fire-resistance of building elements
- A2.4 Early Fire Hazard Indices

A3 Classification of Buildings and Structures

- A3.1 Principles of classification
- A3.2 Classifications
- A3.3 Multiple classification

A4 United Buildings

- A4.1 When buildings are united
- A4.2 Alterations in a united building

Specifications

- A1.3 Standards Adopted by Reference
- A2.3 Fire-Resistance of Building Elements
- A2.4 Early Fire Hazard Test for Assemblies

Appendices

ACT

- A2.101 Hazardous materials
- A2.102 Drawing practice

PART A1 INTERPRETATION ý

SA A1.1

A1.1 Definitions ý

SA A1.1

Alpine area means land-

- (a) ý likely to be subject to significant snowfalls;
- (b) in New South Wales, ACT or Victoria more than 1200 m above the Australian Height Datum; and
- (c) in Tasmania more than 900 m above the Australian Height Datum.

Alteration, in relation to a building, includes an addition or extension to a building.

Assembly building means a building where people may assemble for-

- (a) ý civic, theatrical, social, political or religious purposes;
- (b) ý educational purposes in a *school*, *early childhood centre*, *preschool*, or the like;
- (c) ý entertainment, recreational or sporting purposes; or
- (d) ý transit purposes.

Atrium means a space within a building that connects 2 or more *storeys*, and-

- (a) ý is wholly or substantially enclosed at the top by a floor or roof (including a glazed roof structure); and
- (b) ý includes any adjacent part of the building not separated by bounding construction in accordance with Part G3; but
- (c) ý does not include a stairwell, rampwell or the space within a *shaft*.

Atrium well means a space in an *atrium* bounded by the perimeter of the openings in the floors or by the perimeter of the floors and the *external walls*.

Automatic, applied to a fire door, smoke door, fire shutter, *smoke-and-heat vent*, *sprinkler system*, alarm system or the like, means designed to operate when activated by a heat, smoke or fire sensing device.

QLD A1.1

Backstage means a space associated with, and adjacent to, a stage in a Class 9b building for scenery, props, equipment, dressing rooms, or the like.

Certificate of Accreditation means a certificate issued by AUBRCC or a State or Territory accreditation authority stating that the properties and performance of a building material or method of construction or design fulfil specific requirements of the BCA.

VIC A1.1

Combustible-

- (a) applied to a material - means *combustible* under AS 1530.1.
- (b) applied to construction or part of a building - means constructed wholly or in part of *combustible* materials.

(See definition of *non-combustible*).

Common wall means a wall that is common to adjoining buildings.

Curtain wall means a non-loadbearing *external wall* that is not a *panel wall*.

QLD A1.1

VIC A1.1

Early childhood centre means a *preschool*, kindergarten or child-minding centre.

Effective height means the height to the floor of the topmost *storey* (excluding the topmost *storey* if it contains only heating, ventilating, lift or other equipment, water tanks or similar service units) from the floor of the lowest *storey* providing direct egress to a road or *open space*.

Exit means-

- (a) √ Any, or any combination of the following if they provide egress to a road or *open space*:
 - (i) √ An internal or external stairway.
 - (ii) √ A ramp complying with Section D.
 - (iii) √ A *fire-isolated passageway*.
 - (iv) √ A doorway opening to a road or *open space*.
- (b) √ A *horizontal exit* or a *fire-isolated passageway* leading to a *horizontal exit*.

External wall means an outer wall of a building which is not a *common wall*.

Fire compartment means-

- (a) √ the total space of a building; or
VIC A1.1
- (b) √ any part thereof separated from the remainder by walls and/or floors each having an FRL not less than that *required* for a *fire wall* for that type of construction and where all openings in the separating construction are protected in accordance with the relevant Part.

Fire-isolated passageway means a corridor, hallway or the like, of *fire-resisting construction*, which provides egress to or from a *fire-isolated stairway* or *fire-isolated ramp* or to a road or *open space*.

Fire-isolated ramp means a ramp within a *fire-resisting* enclosure which provides egress from a *storey*.

Fire-isolated stairway means a stairway within a *fire-resisting shaft* and includes the floor and roof or top enclosing structure.

Fire main means a water service pipe installed within a building or on a building allotment for fire-fighting purposes.

Fire-protective covering means-

- (a) √ 13 mm fire-protective grade plasterboard;
 - (b) √ 12 mm cellulose fibre reinforced cement sheeting;
 - (c) √ 12 mm fibrous plaster reinforced with 13 mm x 13 mm x 0.7 mm galvanised steel wire mesh located not more than 6 mm from the exposed face; or
 - (d) √ other material not less fire-protective than 13 mm fire-protective grade plasterboard,
- fixed in accordance with the normal trade practice for a *fire-protective covering*.

Fire-resistance level (FRL) means the grading periods in minutes determined in accordance with Specification A2.3, for-

- (a) √ *structural adequacy*;
- (b) √ *integrity*; and

(c) *insulation*; ý

and expressed in that order. ý

A dash, for examples 90/-/- or -/-/-, means there is no requirement for an FRL ý for that criterion. ý

Fire-resisting, applied to a *structural member* or other part of a building, means having the FRL *required* for that *structural member* or other part.

Fire-resisting construction means one of the Types of construction referred to in Part C1.

Fire-source feature means-

- (a) ý the far boundary of a road adjoining the allotment;
- (b) ý a side or rear boundary of the allotment; or
- (c) ý an *external wall* of another building on the allotment which is not of Class 10.

Fire wall means a wall that divides a *storey* or building to resist the spread of fire and smoke and has the FRL *required* under Specification C1.1.

Flammability Index means the index number determined under AS 1530.2.

Floor area means-

- (a) ý in relation to a *storey* - the area of that *storey* measured over the enclosing walls (if any) and that part of any *common wall* located within the allotment; and
- (b) ý in relation to a room - the area of the room measured within the finished surfaces of the walls, and includes the area occupied by any cupboard or other built-in furniture, fixture or fitting

Foundation means the ground which supports the building.

SAA1.1

Habitable room means a room used for normal domestic activities, and-

- (a) ý includes a bedroom, living room, lounge room, music room, television room, kitchen, dining room, sewing room, study, playroom, family room and sunroom; but
- (b) ý excludes a bathroom, laundry, water closet, pantry, walk-in wardrobe, corridor, hallway, lobby, photographic darkroom, clothes-drying room, and other spaces of a specialised nature occupied neither frequently nor for extended periods.

Health-care building means-

- (a) ý a public or private hospital;
- (b) ý a nursing home, convalescent home, infirmary or similar institution or home for sick or disabled persons needing full-time nursing care; or
- (c) ý a clinic or day surgery unit where-
 - (i) ý prescribed surgical, medical or endoscopy procedures are performed on people who do not require overnight care as in-patients in a hospital; and
 - (ii) ý the surgical, medical or endoscopy procedures include a potential requirement for general anaesthesia, major regional anaesthesia or intravenous sedation.

SUPERCEDED

Horizontal exit means a *required* doorway between 2 parts of a building separated from each other by a *fire wall* with an FRL as *required* by Specification C1.1.

Hydrant means a fire *hydrant* or plug connected to a *fire main* or to a water main in a public road.

Insulation, in relation to an FRL, means the ability to maintain a temperature on the surface not exposed to the furnace below the limits specified in AS 1530.4.

Integrity, in relation to an FRL, means the ability to resist the passage of flames and hot gases specified in AS 1530.4.

Internal wall excludes a *common wall* or a party wall.

Lightweight construction is-

- (a) *fire-resisting construction* which-
 - (i) *is not in continuous contact with the principal construction that it protects from fire; or*
 - (ii) *is of sheet or board material, plaster, render, sprayed application, or other material similarly susceptible to damage by pressure or abrasion; or*
- (b) *fire-resisting construction* which incorporates or comprises-
 - (i) *concrete containing pumice, perlite, vermiculite, or other soft material; or*
 - (ii) *masonry having a thickness less than 70 mm.*

Loadbearing means intended to resist vertical forces additional to those due to its own weight.

Mezzanine means an intermediate storey within a room.

SA A1.1

Non-combustible-

- (a) *applied to a material - means not deemed **combustible** under AS 1530.1 - Combustibility Tests for Materials; and*
- (b) *applied to construction or part of a building - means constructed wholly of materials that are not deemed **combustible**.*

Open-deck carpark means a carpark in which all parts of the parking *storeys* are cross-ventilated by permanent unobstructed openings in not fewer than 2 opposite or approximately opposite sides, and-

- (a) *where each side that provides ventilation is not less than 1/6 of the area of any other side;*
- (b) *the openings are not less than 1/2 of the wall area of the side concerned.*

QLD A1.1

Open garage means a carport or garage with 2 or more sides substantially open. *ý*

QLD A1.1

Open space means a space on an allotment, or a roof or similar part of a building complying with D2.12, open to the sky and connected directly with a public road.

Open spectator stand means a tiered stand substantially open at the front.

Panel wall means a *non-loadbearing external wall*, in frame or similar construction, that is wholly supported at each *storey*.

SUPERCEDED

Patient care area means a part of a *health-care building* used for the treatment, care, accommodation, recreation, dining and transit of patients.

ACT A1.1

Private garage means-

- (a) ý any garage of a Class 1 building; or
- (b) ý any single *storey* of a building of another Class capable of accommodating not more than 3 vehicles, if there is only one such *storey* in the building.

QLD A1.1

Professional engineer means a person with appropriate experience in the relevant field, being-

- (a) if legislation so requires - a registered *professional engineer* in the relevant discipline; or
- (b) otherwise - a Corporate Member of the Institution of Engineers, Australia.

Public carpark means a building that is used for the parking of motor vehicles but is neither a *private garage* nor used for the servicing of vehicles, other than washing, cleaning or polishing.

Public corridor means an enclosed corridor, hallway or the like which-

- (a) ý serves as a means of egress from 2 or more *sole-occupancy units* to a *required exit* from the *storey* concerned; or
- (b) ý is *required* to be provided as a means of egress from any part of a *storey* to a *required exit*.

Registered Testing Authority means-

- (a) ý the National Building Technology Centre (NBTC);
- (b) ý the CSIRO Division of Building, Construction and Engineering (CSIRO-DBC&E);
- (c) ý an authority registered by the National Association of Testing Authorities (NATA) to test in the relevant field; or
- (d) ý an organisation outside Australia recognized by NATA through a mutual recognition agreement.

Required means required by the BCA.

Resistance to the incipient spread of fire, in relation to a ceiling membrane, means the ability of a ceiling membrane to insulate the space between the ceiling and roof, or ceiling and floor above, to limit the temperature rise of combustibles in this space during the *Standard Fire Test* to 180 K.

Rise in storeys means the greatest number of *storeys* calculated in accordance with C1.2

Sanitary compartment means a room or space containing a toilet fixture, closet pan, soil pan, chemical toilet, or the like.

Sarking-type material means a material such as a reflective foil or other flexible membrane of a type normally used for a purpose such as water proofing, vapour proofing or thermal reflectance.

School includes a primary or secondary *school*, college, university or similar educational establishment.

SUPERCEDED

Self-closing, applied to a door or *window* means equipped with a device which returns the door or *window* to the fully closed and latched position immediately after each manual opening.

Service station means a garage which is not a *private garage* and is for the servicing of vehicles, other than only washing, cleaning or polishing.

Shaft means the walls and other parts of a building bounding-

(a) ý a well, other than an *atrium well*; or

(b) ý a vertical chute, duct or similar passage, but not a chimney or flue.

SA A1.1

Site means the part of the allotment of land on which a building stands or is to be erected.

Smoke-and-heat vent means a vent, located in or near the roof for smoke and hot gases to escape if there is a fire in the building.

Smoke-Developed Index means the index number for smoke developed under AS 1530.3.

Sole-occupancy unit means a room or other part of a building for occupation by one owner, lessee, tenant, or other occupier to the exclusion of any other owner, lessee, tenant, or other occupier.

SA A1.1

Spread-of-Flame Index means the index number for spread of flame under AS 1530.3.

Sprinkler system means a system of *automatic* fire sprinklers complying with E1.5.

Stage means a floor or platform in a Class 9b building on which performances are presented before an audience.

Standard Fire Test means the Fire-resistance Tests of Elements of Building Construction as described in AS 1530.4.

Storey means a space within a building which is situated between one floor level and the floor level next above, or if there is no floor above, the ceiling or roof above, but not-

(a) ý a space that contains only-

(i) ý a lift *shaft*, stairway or meter room; or

(ii) ý a bathroom, shower room, water closet, or other *sanitary compartment*; or

(iii) ý accommodation intended for not more than 3 vehicles; or

(iv) ý a combination of the above; or

VIC A1.1

(b) a *mezzanine*.

Structural adequacy, in relation to an FRL means the ability to maintain stability and adequate *loadbearing* capacity under AS 1530.4.

Structural member means a component or part of an assembly which provides vertical or lateral support to a building or structure.

SUPERCEDED

QLD A1.1

SA A1.1

Swimming pool means any excavation or structure containing water and used primarily for swimming, wading, paddling, or the like, including a bathing or wading pool, or spa.

Window includes a roof light, glass panel, glass block or brick, glass louvre, glazed sash, glazed door, or other device which transmits natural light directly from outside a building to the room concerned when in the closed position.

QLD A1.1

A1.2 Adoption of Standards and other references

The adoption of a Standard, rule, specification or provision included in any document issued by the Standards Association of Australia or other body, does not include a provision-

- (a) ∫ specifying or defining the respective rights, responsibilities or obligations as between themselves of any manufacturer, supplier or purchaser;
- (b) ∫ specifying the responsibilities of any trades person or other building operative, architect, engineer, authority, or other person or body;
- (c) ∫ requiring the submission for approval of any material, building component, form or method of construction, to any person, authority or body other than a person or body empowered under State or Territory legislation to give that approval;
- (d) ∫ specifying that a material, building component, form or method of construction, must be submitted to the Standards Association of Australia or a committee of the Association for expression of opinion; or
- (e) ∫ permitting a departure from the code, rule, specification or provision at the sole discretion of the manufacturer or purchaser, or by arrangement or agreement between the manufacturer and purchaser.

A1.3 Referenced Standards, etc

ACT A1.3

A reference to a document under A1.2 refers to the edition or issue, together with any amendment, listed in Specification A1.3 and only so much as is relevant in the context in which the document is quoted.

A1.4 Differences between referenced documents and the BCA

The BCA overrules in any difference arising between it and any Standard, rule, specification or provision in a document listed in Specification A1.3.

A1.5 Application of the BCA to a particular State or Territory

For application within a particular State or Territory, the BCA comprises-

- (a) Sections A to H; and
- (b) the variations, deletions and additions to Sections A to H applicable to that State or Territory specified in the relevant Appendix.

PART A2 ý ACCEPTANCE OF DESIGN AND CONSTRUCTION

A2.1 Suitability of materials

Every part of a building must be constructed in a proper and workmanlike manner to achieve the *required* level of performance, using materials that are not faulty or unsuitable for the purpose for which they are intended.

A2.2 Evidence of suitability

Subject to A2.3 and A2.4, evidence to support the use of a material, form of construction or design may be-

- (a) ý a report issued by a *Registered Testing Authority*, showing that the material or form of construction has been submitted to the tests listed in the report, and setting out the results of those tests and any other relevant information that demonstrates its suitability for use in the building;
- (b) ý a current *Certificate of Accreditation*;
- (c) ý a certificate from a *professional engineer* or other appropriately qualified person which-
 - (i) ý certifies that a material, design or form of construction complies with the requirements of the BCA; and
 - (ii) ý sets out the basis on which it is given and the extent to which relevant specifications, rules, codes of practice or other publications have been relied upon;
- (d) ý a Standards Mark Certificate issued by Standards Australia; or
- (e) ý any other form of documentary evidence that correctly describes the properties and performance of the material or form of construction and adequately demonstrates its suitability for use in the building,

and any copy of documentary evidence submitted under the BCA, must be a complete copy of the original report or document.

A2.3 Fire-resistance of building elements

The FRL of a *structural member* must be determined in accordance with Specification A2.3.

A2.4 Early Fire Hazard Indices

The Early Fire Hazard Indices of a component or assembly must be determined in accordance with Specification A2.4

ACT A2.101

ACT A2.102

PART A3 *ý* CLASSIFICATIONS OF BUILDINGS AND STRUCTURES

A3.1 Principles of classification

The classification of a building or part of a building is determined by the purpose for which it is designed, constructed or adapted to be used.

A3.2 Classifications

Buildings are classified as follows:

SA A3.2

VIC A3.2

Class 1: a residence which may comprise one or more buildings including any habitable outbuildings which in association constitute-

- (a) *ý* a single dwelling-house, terrace house, townhouse, row house, villa house, or the like, which may be detached or separated by a *common wall*; or
- (b) *ý* a dwelling-house used as a boarding-house, hostel, group house, or the like, in which not more than 12 persons would ordinarily be resident; or
- (c) *ý* a residential building that does not exceed a *rise in storeys* of 3, contains only 2 *sole-occupancy units* located one above the other, and each unit has direct egress to a road or *open space*.

Class 2: a building containing 2 or more *sole-occupancy units* each being a separate dwelling, excluding buildings of Class 1.

NT A3.2

SA A3.2

TAS A3.2

Class 3: a residential building, other than a building of Class 1 or 2, which is a *ý* common place of living for a number of unrelated persons, including-

- (a) a boarding-house, guest house, hostel, or lodging-house; or
- (b) a residential part of an hotel or motel; or
- (c) a residential part of a *school*; or
- (d) accommodation for the aged, disabled or children; or
- (e) a residential part of a *health-care building* which accommodates members of staff.

QLDA3.2(f)

Class 4: a dwelling in a building that is Class 5, 6, 7, 8 or 9 if it is the only dwelling in the building.

Class 5: an office building used for professional or commercial purposes, excluding buildings of Class 6, 7, 8, or 9.

Class 6: a shop or other building for the sale of goods by retail or the supply of services direct to the public, including-

- (a) *ý* an eating room, cafe, restaurant, milk or soft-drink bar; or

- (b) ý a dining room, bar, shop or kiosk part of a hotel or motel; or
- (c) ý a hairdresser's or barber's shop, public laundry, or undertaker's establishment; or
- (d) ý market or sale room, showroom, or *service station*.

Class 7: a building which is-

- (a) ý a *public carpark*; or
- (b) ý for storage, or display of goods or produce for sale by wholesale.

Class 8: a laboratory, or a building in which a handicraft or process for the production, assembling, altering, repairing, packing, finishing, or cleaning of goods or produce is carried on for trade, sale, or gain.

Class 9: a building of a public nature-

- (a) ý Class 9a - a *health-care building*; or
- (b) ý Class 9b - an *assembly building*, and

Class 9a includes a pathology laboratory in a health-care building and **Class 9b** includes a trade workshop, laboratory or the like in a primary or secondary *school*, but excludes any other part of these buildings that are of another Class.

Class 10: a non-habitable outbuilding or structure-

- (a) ý Class 10a - an *open garage, private garage, shed*, or the like; or
- (b) ý Class 10b - a fence, mast, antenna, retaining or free-standing wall, *swimming pool*, or the like.

A3.3 Multiple classification

Each part of a building must be classified separately, and-

- (a) ý where parts have different purposes - if not more than 10% of the *floor area* of a *storey* which is not a laboratory is used for a purpose which is a different classification, the classification applying to the major use may apply to the whole *storey*; and
- (b) ý Classes 9a, 9b, 10a and 10b are separate classifications; and
- (c) ý a reference to-
 - (i) ý Class 9 - is to Class 9a or 9b; and
 - (ii) ý Class 10 - is to Class 10a or 10b.

VIC A3.3(d)

PART A4 UNITED BUILDINGS

A4.1 When buildings are united

Two or more buildings adjoining each other form one united building if they-

- (a) ý are connected through openings in the walls dividing them; and
- (b) ý together comply with all the requirements of the BCA as though they are a single building.

A4.2 Alterations in a united building

If, after *alterations* or any other building work, two or more of the buildings in A4.1 cease to be connected through openings in the dividing walls, each of those buildings not now connected must comply with all requirements for a single building.

SPECIFICATION A1.3 $\dot{\gamma}$ STANDARDS ADOPTED BY REFERENCE

1. Schedule of referenced documents

The Standards and other documents listed in Table 1 are referred to in the BCA.

ACT SPEC A1.3

NSW SPEC A1.3

NT SPEC A1.3

QLD SPEC A1.3

SA SPECA1.3

TAS SPEC A1.3

VIC SPEC A1.3

WA SPEC A1.3

Table 1: SCHEDULE OF REFERENCED DOCUMENTS

No.	Date	Title	BCA Clause(s)
AS 1038		Methods for the analysis and testing of coal and coke	
Part 15	1972	Fusibility of higher rank coal ash and coke ash	Spec C3.15
AS 1170		Minimum design loads on structures (SAA Loading Code)	B1.2
Part 1	1989	Dead and live loads and load combinations	
Part 2	1989	Wind loads	
Part 3	1990	Snow loads	
AS 1191	1985	Acoustics- Method for laboratory measurement of airborne sound transmission loss of building partitions	Spec F5.5
AS 1200	1988	Boilers and pressure vessels (SAA Boiler Code)	G2.2
AS 1221	1989	Fire hose reels	E1.4
AS 1250	1981	The use of steel in structures (SAA Steel Structures Code) Amdt 2, Oct. 1984	Spec A2.3, B1.3
AS 1276	1979	Methods for determination of Sound Transmission Class and Noise Isolation Class of building partitions	F5.2
AS 1288	1989	Glass in buildings - Selection and Installation	B1.3
AS 1349	1986	Bourdon tube pressure and vacuum gauges	Spec E1.2
AS 1428		Design rules for access by the disabled	
Part 1	1988	Regulatory requirements Amdt 1, Jan 1989 Amdt 2, Oct 1989	D3.2, D3.3 F2.4
AS 1529	1974	Code of practice for installation of household-type	G1.3

SUPERCEDED

		hot water supply systems	
AS 1530		Methods for fire tests on building materials components and structures	A1.1 Spec A2.4
Part 1	1984	Combustibility test for materials	
Part 2	1973	Test for flammability of materials	
Part 3	1989	Simultaneous determination of ignitability, flame propagation, heat release and smoke release	Spec A2.4
Part 4	1990	Fire-resistance tests on elements of building construction	Spec A2.4 Spec C3.15
		[Note: Previous test reports under Part 1-1976, Part 3-1982 and Part 4-1975 remain valid. New reports of tests carried out after the date of amendment must relate to the amended Standard]	
AS 1538	1974	Rules for the use of cold-formed steel in structures (SAA Cold-formed Steel Structures Code)	B1.3
AS 1562	1980	Design and installation of metal roofing	B1.3, F1.5
AS 1603	1974	Thermal detectors for fire alarm installations	Spec E1.7
Part 4	1987	Control and indicating equipment Amdt 1, June 1988 Amdt 2, Oct 1989	
Part 6	1987	Fire Alarm Bells	
AS 1639	1990	The design and installation of corrugated fibre-reinforced cement roofing and wall cladding	F1.5
AS 1657	1985	Fixed platforms, walkways, stairways and ladders - Design, construction and installation (SAA Code for Fixed Platforms, Walkways, Stairways and Ladders)	D2.16, D2.17, D2.18, H1.6
AS 1664	1979	Rules for the use of aluminium in structures (SAA Aluminium Structures Code)	B1.3
AS 1668		Rules for the use of mechanical ventilation and air-conditioning in buildings (SAA Mechanical Ventilation and Air-conditioning Code)	
Part 1	1979	Fire precautions in buildings with air-handling systems Amdt 1, Nov. 1979	C3.15, Spec E1.7 Spec E1.8, E2.4, E2.7, Spec E2.3, Spec E2.4, Spec G3.8, Spec H1.2
Part 2	1980	Ventilation requirements	F4.5, F4.11
AS 1670	1986	Automatic fire detection and alarm systems - system design, installation and commissioning Amdt 1, Jan 1987 Amdt 2, March 1988 Amdt 3, June 1988	Spec E1.7, E2.5, E2.7, Spec G3.8, G4.8
AS 1682	1979	Fire dampers	C3.15
AS 1684	1979	Code of practice for construction in timber framing (SAA Timber Framing Code)	B1.3
AS 1691	1985	Rules for the installation of domestic oil-fired appliances (SAA Domestic Oil-fired Appliances Installation Code)	G2.2
AS 1694	1974	Code of practice for physical barriers used in the protection of buildings against subterranean	B1.3

SUPERCEDED

SUPERCEDED

		termites	
AS 1720		Timber structures (SAA Timber Structures Code)	
Part 1	1988	Design methods	B1.3
Part 4	1990	Fire resistance of structural timber	Spec A2.3
AS 1735		Lifts, escalators and moving walks (SAA Lift Code)	
Part 2	1986	Passenger and goods lifts - Electric	Spec C1.8, E3.4
Part 11	1986	Fire-rated landing doors	C3.10
Part 12	1986	Facilities for persons with disabilities	D3.3
AS 1736	1975	Code of practice for pliable roof sarking	F1.6
AS 1757	1989	Concrete roofing tiles	B1.3, F1.5
AS 1860	1976	Code of practice for the installation of particleboard flooring	B1.3
AS 1903	1976	Reflective foil laminate	F1.6
AS 1904	1976	Code of practice for installation of reflective foil laminate in buildings	F1.6
AS 1905		Components for the protection of openings in fire- resistant walls (SAA Fire Door Code)	Spec C3.4, C3.6, D2.22, Spec E1.7
Part 1	1990	Fire-resistant doorsets	
Part 2	1984	Fire-resistant roller shutters	
AS 1926	1986	Fences and gates for private swimming pools Amdt 1, March 1987	G1.1
AS 2049	1989	Terracotta roofing tiles	B1.3, F1.5
AS 2050	1989	Fixing of roofing tiles	B1.3, F1.5
AS 2057	1986	Protection of buildings from subterranean termites - Chemical treatment of soil for buildings under construction	B1.3
AS 2107	1977	Code of practice for ambient sound levels for areas of occupancy within buildings	Spec E1.8
AS 2118	1982	Automatic fire sprinkler systems (SAA Code for Automatic Fire Sprinkler Systems) Amdt 1, Jan. 1983 Amdt 2, Dec. 1985	E1.5, Spec E1.5, Spec G3.8
AS 2121	1979	The design of earthquake resistant buildings (SAA Earthquake Code)	B1.2
AS 2159	1978	Rules for the design and installation of piles (SAA Piling Code)	B1.3
AS 2185	1978	Fibrous plaster products	Spec C1.8
AS 2220	1978	Rules for emergency warning and intercommunication systems for buildings	E4.9, Spec G3.8
AS 2293		Emergency evacuation lighting in buildings	
Part 1	1987	Design and installation	E4.4, E4.8
AS 2327	1980	Composite construction in structural steel and concrete (SAA Composite Construction Code)	Spec A2.3, B1.3
AS 2376		Plastics building sheets	B1.3, F1.5
Part 1	1980	Extruded PVC	
Part 2	1981	Glass fibre reinforced polyester(GRP)	
AS 2419		Fire hydrant installations	

SUPERCEDED

SUPERCEDED

Part 1	1988	System design, installation and commissioning	E1.3 ý
AS 2424	1981	Plastics building sheets - General installation requirements and design of roofing systems ý	B1.3, F1.5 ý
AS2427	1983	Smoke/heat release vents	E2.5 ý
AS2428		Methods of testing smoke/heat release vents	E2.5 ý
AS 2441	1988	Installation of fire hose reels	E1.4 ý
AS 2444	1985	Portable fire extinguishers - Selection and location	E1.6 ý
AS 2665	1983	Smoke/heat venting systems - Design installation and commissioning	C2.3, E2.5, Spec E2.6, Spec G3.8, Spec H1.2
AS 2818	1986	Guide to swimming pool safety	G1.1
AS 2870		Residential slabs and footings	
Part 1	1988	Construction	B1.3, F1.10 ý
AS 2904	1986	Damp-proof courses and flashings	F1.9 ý
AS 2908	1987	Cellulose cement products - Corrugated sheets for roofing and cladding ý	B1.3, F1.5 ý
AS 2918	1987	Domestic solid-fuel burning appliances - Installation ý	G2.2 ý
AS 3600	1988	Concrete Structures	Spec A2.3, B1.3 ý
AS 3666	1989	Air-handling and water systems in buildings - Microbial control	E5.3, F2.7, F4.5 ý
AS 3700	1988	Masonry in Buildings	Spec A2.3, B1.3, F5.5
AISC		Guidelines for assessment of fire resistance of structural steel members	Spec A2.3
ASTM E72-80		Standard method of conducting strength tests of panels for building construction ý	Spec C1.8 ý
ASTM E695-79		Standard method of measuring relative resistance of wall, floor and roof construction to impact loading (1985) ý	Spec C1.8 ý
CSIRO-DBC&E		Special Report - Low Rise Domestic and Similar Framed Structures, ý Part 4 - Supplementary Domestic Buildings for Built-Up Areas ý	B1.3 ý
CSIRO-NBTC		Bulletin 5 - Earth-wall Construction 4th edition - 1987 ý	B1.3 ý
ISO 140		Acoustics- Measurement of sound insulation in buildings and of building elements ý	
Part VI	1978	Laboratory measurements of impact sound insulation of floors	Spec F5.5 ý
	(E)		

SPECIFICATION A2.3 ý FIRE-RESISTANCE OF BUILDING ELEMENTS

1. Scope

This Specification sets out the procedures for determining the FRL of building elements.

2. Rating

A building element meets the requirements of this Specification if-

(a) it is listed in, and complies with Table 1 of this Specification; or

SUPERCEDED

SUPERCEDED

- (b) ý it is identical with a prototype that has been submitted to the *Standard Fire Test*, or an equivalent or more severe test, and the FRL achieved by the prototype is confirmed in a report from a *Registered Testing Authority* which-
 - (i) ý describes the method and condition of test and the form of construction of the tested prototype in full; and
 - (ii) ý certifies that the application of restraint to the prototype complied with the *Standard Fire Test*; or
- (c) ý it differs in only a minor degree from a prototype tested under (b) and the FRL attributed to the building element is confirmed in a report from a *Registered Testing Authority* which-
 - (i) ý certifies that the *structural member* is capable of achieving the FRL despite the minor departures from the tested prototype; and
 - (ii) ý describes the materials, construction and conditions of restraint which are necessary to achieve the FRL; or
- (d) ý it is designed to achieve the FRL in accordance with-
 - (i) ý AS 1250, AS 2327 and AISC Guidelines for Assessment of Fire Resistance of Structural Steel Members if it is a steel or composite structure; or
 - (ii) ý AS 3600 if it is a concrete structure; or
 - (iii) ý AS 1720 Part 4 if it is a solid or glued-laminated timber structure; or
 - (iv) ý AS 3700, subject to Annexure Clause 4, if it is a masonry structure; or
- (e) ý the FRL is determined by calculation based on the performance of a prototype in the *Standard Fire Test* and confirmed in a report in accordance with Clause 3.

3. FRLs determined by calculation

If the FRL of a building element is determined by calculation based on a tested prototype-

- (a) ý the building element may vary from the prototype in relation to-
 - (i) ý length and height if it is a wall; and
 - (ii) ý height if it is a column; and
 - (iii) ý span if it is a floor, roof or beam; and
 - (iv) ý conditions of support; and
 - (v) ý to a minor degree, cross-section and components.
- (b) ý the report must demonstrate by calculation that the building element would achieve the FRL if it is subjected to the regime of the *Standard Fire Test* in relation to-
 - (i) ý *structural adequacy* (including deflection); and
 - (ii) ý *integrity*; and
 - (iii) ý *insulation*; and
- (c) ý the calculations must take into account-
 - (i) ý the temperature reached by the components of the prototype and their effects on strength and modulus of elasticity; and
 - (ii) ý appropriate features of the building element such as support, restraint, cross-sectional shape, length, height, span, slenderness ratio,

SUPERCEDED

reinforcement, ratio of surface area to mass per unit length, and fire protection; and

- (iii) ý features of the prototype that influenced its performance in the *Standard Fire Test* although these features may not have been taken into account in the design for dead and live load; and
- (iv) ý features of the conditions of test, the manner of support and the position of the prototype during the test, that might not be reproduced in the building element if it is exposed to fire; and
- (v) ý the design load of the building element in comparison with the tested prototype.

4. Interchangeable materials

- (a) ý Concrete and plaster - An FRL achieved with any material of Group A, B, C, D or E as an ingredient in concrete or plaster, applies equally when any other material of the same group is used in the same proportions:

Group A: Any portland cement. ý

Group B: Any lime. ý

Group C: Any dense sand. ý

Group D: Any dense calcareous aggregate, including any limestone or any ý calcareous gravel. ý

Group E: Any dense siliceous aggregate, including any basalt, diorite, dolerite, ý granite, granodiorite or trachyte. ý

- (b) ý Perlite and vermiculite - An FRL achieved with either gypsum-perlite plaster or gypsum-vermiculite plaster applies equally for each plaster.

5. Columns covered with lightweight construction

- (a) ý Protection against injury - If the *fire-resisting covering* of a steel column is *lightweight construction*-

- (i) ý the covering must be protected by steel or other suitable material if the column is liable to damage from the movement of vehicles, materials or equipment; and

- (ii) ý the voids must be filled solid with *non-combustible* material to a height of not less than 1.2 m above the floor to prevent indenting if the covering is not in continuous contact with the column; and

- (b) ý Sealing at floor level - A plug of *non-combustible* material must seal all voids at each floor level, including the voids between the column and its covering if-

- (i) ý a steel column extends through 2 or more *storeys*; and

- (ii) ý the *fire-resisting* covering is not in continuous contact with the column.

Table 1: FRLs DEEMED TO BE ACHIEVED BY CERTAIN BUILDING ELEMENTS ý

BUILDING ELEMENT	MINIMUM THICKNESS (mm) OF PRINCIPAL MATERIAL FOR FRL's					ANNEXURE REFERENCE Clause No.
	60/60/60	90/90/90	120/120/120	180/180/180	240/240/240	

WALL

SUPERCEDED

Masonry

Ashlar	-	-	-	-	300	1,2,6,7
Calcium silicate	see 2(d)(iv) of this Specification					4
Concrete	see 2(d)(iv) of this Specification					4
Fired clay (incl terracotta)	see 2(d)(iv) of this Specification					4

Concrete

No-fines	-	-	-	150	170	1,6,7
Prestressed	see 2(d)(ii) of this Specification					
Reinforced	see 2(d)(ii) of this Specification					
Plain	-	-	-	150	170	1,6,7

Solid gypsum blocks

75	90	100	110	125	1,6,7
----	----	-----	-----	-----	-------

Gypsum-perlite or Gypsum vermiculite-plaster

on metal lath and channel (non-loadbearing walls only)	50	50	65	-	-	1,6,8
--	----	----	----	---	---	-------

CONCRETE COLUMN

Concrete	
Prestressed	see 2(d)(ii) of this Specification
Reinforced	see 2(d)(ii) of this Specification

HOT-ROLLED STEEL COLUMN

(incl. a fabricated column) exposed on no more than 3 sides:

Fire protection of

Concrete - Cast in-situ-loadbearing

25	30	40	55	75	9,10,12,13
----	----	----	----	----	------------

non-loadbearing-unplastered

25	30	40	50	65	9, 10,12,13
----	----	----	----	----	-------------

plastered 13 mm-

25	25	30	40	50	1,7,9,10,12,13
----	----	----	----	----	----------------

Gypsum - Cast in-situ

-	-	-	-	50	9,10,12,13
---	---	---	---	----	------------

Gypsum-perlite or Gypsum-vermiculite plaster

sprayed to contour

20	25	35	50	55	1,9,12
----	----	----	----	----	--------

sprayed on metal lath

20	20	25	35	45	1,8,9
----	----	----	----	----	-------

HOT-ROLLED STEEL COLUMN

(incl. a fabricated column) exposed on no more than 3 sides and with column spaces filled:

Fire protection of -

Solid calcium-silicate masonry

50	50	50	50	65	1,3,7,9,10,12,13
----	----	----	----	----	------------------

Solid clay masonry

50	50	50	65	90	1,3,7,9,10,12,13
----	----	----	----	----	------------------

Solid concrete masonry

50	50	50	65	90	1,3,7,9,10,12,13
----	----	----	----	----	------------------

Solid gypsum blocks

50	50	50	50	65	1,3,7,9,10,12,13
----	----	----	----	----	------------------

SUPERCEDED

Hollow terracotta blocks plastered 13 mm	50	50	50	65	90	1,3,7,9,10,11,12,13
HOT-ROLLED STEEL COLUMN (incl. a fabricated column) exposed on no more than 3 sides and with column spaces unfilled:						
Fire protection of -						
Solid calcium-silicate masonry	50	50	50	-	-	1,3,7,9,12,13
Solid clay masonry	50	50	65	-	-	1,3,7,9,12,13
Solid concrete masonry	50	50	65	-	-	1,3,7,9,12,13
Solid gypsum blocks	50	50	50	-	-	1,3,7,9,12,13
Hollow terracotta blocks- plastered 13 mm	50	50	65	-	-	1,3,7,9,11,12,13
	60/-	90/-	120/-	180/-	240/-	
HOT-ROLLED STEEL COLUMN (incl a fabricated column) exposed on 4 sides:						
Fire protection of -						
Concrete - Cast in-situ-loadbearing	25	40	45	65	90	9,10,12,13
non-loadbearing-unplastered	25	30	40	50	65	9,10,12,13
plastered 13 mm	25	25	30	40	50	1,7,9,10,12,13
Gypsum - Cast in-situ	-	-	-	-	50	9,10,12,13
Gypsum-perlite or Gypsum-vermiculite plaster sprayed to contour	25	30	40	55	65	1,9,12
sprayed on metal lath	20	20	30	40	50	1,8,9
HOT-ROLLED STEEL COLUMN (incl. a fabricated column) exposed on 4 sides and with column spaces filled:						
Fire protection of -						
Solid calcium-silicate masonry	50	50	50	65	75	1,3,6,8,9,11,12
Solid clay masonry	50	50	50	75	100	1,3,6,8,9,11,12
Solid concrete masonry	50	50	50	75	100	1,3,6,8,9,11,12
Solid gypsum blocks	50	50	50	65	75	1,3,6,8,9,11,12
Hollow terracotta blocks- plastered 13 mm	50	50	50	75	100	1,3,6,8,9,10,11,12
HOT-ROLLED STEEL COLUMN (incl. a fabricated column) exposed on 4 sides and with column spaces unfilled:						

SUPERCEDED

SUPERCEDED

Fire protection of - Solid calcium-silicate masonry	50	50	50	-	-	1,3,6,8,11,12
Solid clay masonry	50	50	65	-	-	1,3,6,8,11,12
Solid concrete masonry	50	50	65	-	-	1,3,6,8,11,12
Solid gypsum blocks	50	50	50	-	-	1,3,6,8,11,12
Hollow terracotta blocks-plastered 13 mm	50	50	65	-	-	1,3,6,8,10,11,12
	60/60/60	90/90/90	120/120/120	180/180/10	240/240/240	

BEAM

Concrete

Prestressed see 2(d)(ii) of this Specification

Reinforced see 2(d)(ii) of this Specification

Hot-rolled Steel (incl. an open-web joist, girder, truss, etc) exposed on no more than 3 sides:

Fire protection of - Concrete- Cast in-situ	25	30	40	50	65	8,11,12
Gypsum-perlite or Gypsum-vermiculite plaster sprayed to contour	20	25	35	50	55	1,8,11
sprayed on metal lath	20	20	25	35	45	1,7,8
	60/-/-	90/-/-	120/-/-	180/-/-	240/-/-	

Hot-rolled Steel (incl. an open-web joist, girder, truss, etc) exposed on 4 sides:

Fire protection of - Concrete- Cast in-situ	25	40	45	65	90	9,12,13
Gypsum-perlite or Gypsum-vermiculite plaster- sprayed to contour	25	30	40	55	65	1,9,12
sprayed on metal lath	20	20	30	40	50	1,8,9
	60/60/60	90/90/90	120/120/120	180/180/180	240/240/240	

FLOOR, ROOF OR CEILING

Concrete -

Prestressed see 2(d)(ii) of this Specification

Reinforced see 2(d)(ii) of this Specification

ANNEXURE TO TABLE 1

1 MORTAR, PLASTER AND PLASTER REINFORCEMENT

1.1 Mortar for masonry

Masonry units of ashlar, calcium silicate, concrete or fired clay (including terracotta blocks) must be laid in cement mortar or composition mortar complying with the relevant provisions of AS 1475 and AS 1640.

1.2 Gypsum blocks

Gypsum blocks must be laid in gypsum-sand mortar or lime mortar.

1.3 Gypsum-sand mortar and plaster

Gypsum-sand mortar and gypsum-sand plaster must consist of either-

- (a) \dot{y} not more than 3 parts by volume of sand to 1 part by volume of gypsum; or
- (b) \dot{y} if lime putty is added, not more than 2.5 parts by volume of sand to 1 part by volume of gypsum and not more than 5% of lime putty by volume of the mixed ingredients.

1.4 Gypsum-perlite and gypsum-vermiculite plaster

Gypsum-perlite or gypsum-vermiculite plaster must be applied-

- (a) \dot{y} in either one or 2 coats each in the proportions of 1 m³ of perlite or vermiculite to 640 kg of gypsum if the *required* thickness of the plaster is not more than 25 mm; and
- (b) \dot{y} in 2 coats if the *required* thickness is more than 25 mm, the first in the proportions of 1 m³ of perlite or vermiculite to 800 kg of gypsum and the second in the proportions of 1 m³ of perlite or vermiculite to 530 kg of gypsum.

1.5 Plaster of cement and sand or cement, lime and sand

Plaster prescribed in Table 1 must consist of-

- (a) \dot{y} cement and sand or cement, lime and sand; and
- (b) \dot{y} may be finished with gypsum, gypsum-sand, gypsum-perlite or gypsum-vermiculite plaster or with lime putty.

1.6 Plaster reinforcement

If plaster used as fire protection on walls is more than 19 mm thick-

- (a) \dot{y} it must be reinforced with expanded metal lath that-
 - (i) \dot{y} has a mass per unit area of not less than 1.84 kg/m²;
 - (ii) \dot{y} has not fewer than 98 meshes per metre; and
 - (iii) \dot{y} is protected against corrosion by galvanising or other suitable method; or
- (b) \dot{y} it must be reinforced with 13 mm x 13 mm x 0.7 mm galvanised steel wire mesh; and
- (c) \dot{y} the reinforcement must be securely fixed at a distance from the face of the wall of not less than 1/3 of the total thickness of the plaster.

2 ASHLAR STONE MASONRY

Ashlar masonry must not be used in a part of the building containing more than 2 storeys, and must not be of-

- (a) ∫ aplite, granite, granodiorite, quartz dacite, quartz diorite, quartz porphyrite or quartz porphyry;
- (b) ∫ conglomerate, quartzite or sandstone;
- (c) ∫ chert or flint; or
- (d) ∫ limestone or marble.

3 DIMENSIONS OF MASONRY

The thicknesses of masonry of calcium-silicate, concrete and fired clay are calculated as follows:

3.1 Solid units

For masonry in which the amount of perforation or coring of the units does not exceed 25% by volume (based on the overall rectangular shape of the unit) the thickness of the wall must be calculated from the manufacturing dimensions of the units and the specified thickness of the joints between them as appropriate.

3.2 Hollow units

For masonry in which the amount of perforation or coring of the units exceeds 25% by volume (based on the overall rectangular shape of the unit) the thickness of the wall must be calculated from the equivalent thicknesses of the units and the specified thickness of the joints between them as appropriate.

3.3 Equivalent thickness

The equivalent thickness of a masonry unit is calculated by dividing the net volume by the area of one vertical face.

4 APPLICATION OF AS 3700

4.1 AS 3700 Section 7 - General

Walls of calcium-silicate, concrete and fired-clay masonry may be designed for fire-resistance in accordance with Section 7 of AS 3700 subject to the following limitations:

- (a) ∫ The masonry units are from plants within Australia.
- (b) ∫ The values in item (b) of Table 7.3 of AS 3700 are replaced with
 - (b) □ 1800 kg/m³ 55 75 90 110 135 160.
- (c) ∫ Item (c) of Table 7.3 of AS 3700 is deleted.

4.2 AS 3700 Clauses 7.4.4 and 7.6.4

The words "materials of the same generic type" in Clauses 7.4.4 and 7.6.4 of AS 3700 shall have the following meanings:

- (a) ∫ For clay units - clay and shales of the same mineralogy and geological type blended in the same proportions and manufactured by similar processes.
- (b) ∫ For calcium-silicate units and concrete units - aggregates of the same mineralogy, geological type and grading and cementitious materials of the

same type and grade, blended in the same proportions and manufactured by similar processes.

4.3 ý Cavity walls of different materials

If the 2 leaves of a cavity wall are of units of different type, the slenderness ratio is-

- (a) ý if the thickness is determined by Clause 7.4.2(a) of AS 3700, the slenderness ratio of the exposed leaf alone; or
- (b) ý if the thickness is determined by Clause 7.4.2(b) of AS 3700 - the slenderness ratio applicable to the less fire-resistant material (that with the smaller permissible slenderness ratio in Table 7.1 of AS 3700).

5 ý HEIGHT-TO-THICKNESS RATIO OF CERTAIN WALLS

The ratio of height between lateral supports to overall thickness of a wall of ashlar, no-fines concrete, unreinforced concrete, solid gypsum blocks, gypsum-perlite or gypsum-vermiculite plaster on metal lath and channel, must not exceed-

- (a) ý 20 for a *loadbearing* wall; or
- (b) ý 27 for a non-*loadbearing* wall.

6 ý INCREASE IN THICKNESS BY PLASTERING

6.1 ý General

The tabulated thicknesses are those of the principal material. They do not include the thickness of plaster which must be additional to the listed thickness of the material to which it is applied.

6.2 ý Walls

If a wall of ashlar, solid gypsum blocks or concrete is plastered on both sides to an equal thickness, the thickness of the wall for the purposes of Table 1 (but not for the purposes of Annexure Clause 5) may be increased by the thickness of the plaster on one side.

7 ý GYPSUM-PERLITE OR GYPSUM-VERMICULITE PLASTER ON METAL LATH

7.1 ý Walls

In walls fabricated of gypsum-perlite or gypsum-vermiculite plaster on metal lath and channel-

- (a) ý the lath must be securely wired to each side of 19 mm x 0.44 kg/m steel channels (used as studs) spaced at not more than 400 mm centres; and
- (b) ý the gypsum-perlite or gypsum-vermiculite plaster must be applied symmetrically to each exposed side of the lath.

7.2 ý Columns

For the fire protection of steel columns with gypsum-perlite or gypsum-vermiculite on metal lath-

- (a) ý the thickness of the plaster must be measured from the back of the lath;
- (b) ý the lath must be fixed at not more than 600 mm centres vertically to steel furring channels, and-

- (i) ý if the plaster is to be 35 mm thick or more - at least 12 mm clear of the column; or
- (ii) ý if the plaster is to be less than 35 mm thick - at least 6 mm clear of the column; or
- (c) ý the plaster may be applied to self-furring lath with furring dimples to hold it not less than 10 mm clear of the column.

7.3 Beams

For the fire protection of steel beams with gypsum-perlite or gypsum-vermiculite on metal lath-

- (a) ý the lath must be fixed at not more than 600 mm centres to steel furring channels and at least 20 mm clear of the steel; and
- (b) ý the thickness of the plaster must be measured from the back of the lath.

8 EXPOSURE OF COLUMNS AND BEAMS

8.1 Columns

A column incorporated in or in contact on one or more sides with a wall of solid masonry or concrete at least 100 mm thick may be considered to be exposed to fire on no more than 3 sides.

8.2 Beams

A beam, open-web joist, girder or truss in direct and continuous contact with a concrete slab or a hollow block floor or roof may be considered to be exposed to fire on no more than 3 sides.

9 FILLING OF COLUMN SPACES

If steel columns are deemed to have FRLs of more than 120/120/120 or more than 120/-/-, the spaces between the fire-protective material and the steel (and any re-entrant parts of the column itself) must be filled solid with a fire-protective material like concrete, gypsum or grout.

10 HOLLOW TERRACOTTA BLOCKS

The proportion of cored holes or perforations in a hollow terracotta block (based on the overall rectangular volume of the unit) must not exceed-

- | | |
|---|-----|
| (a) ý for blocks up to 75 mm thick | 35% |
| (b) ý for blocks more than 75 mm but not more than 100 mm thick | 40% |
| (c) ý for blocks more than 100 mm | 50% |

11 REINFORCEMENT FOR COLUMN AND BEAM PROTECTION

11.1 Masonry

Masonry of calcium-silicate, fired clay and concrete for the protection of steel columns must have steel-wire or mesh reinforcement in every second course and lapped at the corners.

11.2 Gypsum blocks and hollow terracotta blocks

Gypsum blocks and hollow terracotta blocks for the protection of steel columns must have steel-wire or mesh reinforcement in every course and lapped at corners.

11.3 Structural concrete and poured gypsum

If a steel column or a steel beam is to be protected with structural concrete or poured gypsum-

- (a) \dot{y} the concrete or gypsum must be reinforced with steel-wire mesh or steel-wire binding placed about 20 mm from its outer surface; and
- (b) \dot{y} for concrete or gypsum less than 50 mm thick, the steel wire must be-
 - (i) \dot{y} at least 3.15 mm in diameter; and
 - (ii) \dot{y} spaced at not more than 100 mm vertically; or
- (c) \dot{y} for concrete or gypsum not less than 50 mm thick, the steel wire must be either-
 - (i) \dot{y} of a diameter and spacing in accordance with (b); or
 - (ii) \dot{y} at least 5 mm in diameter and spaced at not more than 150 mm vertically.

11.4 Gypsum-perlite or gypsum-vermiculite plaster sprayed to contour

- (a) \dot{y} If a steel column or steel beam is protected with either gypsum-perlite or gypsum-vermiculite plaster sprayed to contour and the construction falls within the limits of Table 11.4, the plaster must be reinforced with-
 - (i) \dot{y} expanded metal lath complying with 1.6; or
 - (ii) \dot{y} galvanised steel wire mesh complying with 1.6.
- (b) \dot{y} The reinforcement must be placed at a distance from the face of the plaster of at least 1/3 of the thickness of the plaster and must be securely fixed to the column or beam at intervals of not more than the relevant listing in Table 11.4.
- (c) \dot{y} For the purposes of Table 11.4-
 - (i) \dot{y} "vertical" includes a surface at not more than 10o to the vertical;
 - (ii) \dot{y} "horizontal" includes a surface at not more than 10o to the horizontal; and
 - (iii) \dot{y} "underside" means the underside of any horizontal or non-vertical surface.

Table 11.4 REINFORCEMENT OF GYPSUM-PERLITE OR GYPSUM-VERMICULITE PLASTER SPRAYED TO CONTOUR

SURFACE TO BE PROTECTED \dot{y}	REINFORCEMENT REQUIRED IF SMALLER DIMENSION OF SURFACE EXCEEDS (mm)	MAX SPACING OF FIXINGS OF THE MESH TO SURFACE (mm)
Members with I cross-section:		
Vertical-	450	450
Non-vertical-	300	300
Underside-	300	300
Upper side of a horizontal surface-	Not required	
Members with other shapes:		
Vertical-	Any size	450
Non-vertical-	Any size	300
Underside-	Any size	300

Upper side of a horizontal surface-

Not required

12 THICKNESS OF COLUMN AND BEAM PROTECTION

12.1 Measurement of thickness

The thickness of the fire protection to steel columns and steel beams (other than fire protection of gypsum-perlite or gypsum-vermiculite plaster sprayed on metal lath or sprayed to contour) is to be measured from the face or edge of the steel, from the face of a splice plate or from the outer part of a rivet or bolt, whichever is the closest to the outside of the fire-protective construction, except that-

- (a) √ if the thickness of the fire protection is 40 mm or more, rivet heads may be disregarded;
- (b) √ if the thickness of the fire protection is 50 mm or more-
 - (i) √ any part of a bolt (other than a high-tensile bolt) may be disregarded; and
 - (ii) √ a column splice plate within 900 mm of the floor may encroach upon the fire protection by up to a 1/4 of the thickness of the fire protection; and
- (c) √ the flange of a column or beam may encroach by up to 12 mm upon the thickness of the fire protection at right angles to the web if-
 - (i) √ the column or beam is intended to have an FRL of 240/240/240 or 240/-/-;
 - (ii) √ the flange projects 65 mm or more from the web; and
 - (iii) √ the thickness of the edge of the flange (inclusive of any splice plate) is not more than 40 mm.

SPECIFICATION A2.4 √ EARLY FIRE HAZARD TEST FOR ASSEMBLIES

1. Scope

This Specification sets out the procedures for determining the Early Fire Hazard Indices of components and assemblies and their ability to screen their core materials as *required* under Specification C1.1.

2. Form of test

Tests must be carried out in accordance with-

- (a) √ for the determination of the spread-of-flame and smoke-developed indices - AS 1530.3; and
- (b) √ for the determination of the ability to prevent ignition and to screen its core material from free air - AS 1530.4

3. Test specimens

Test specimens must incorporate-

- (a) √ all types of joints; and
- (b) √ all types of perforations, recesses or the like for pipes, light switches or other fittings,

which are proposed to be used for the member or assembly of members in the building.

4. Concession

Clause 3 does not apply to joints, perforations, recesses or the like that are larger than those in the proposed application and have already been tested in the particular form of construction concerned and found to comply with the conditions of test.

5. Smaller specimen permitted

A testing laboratory may carry out the test specified in Clause 2(b) at pilot scale if a specimen (which must be not less than 900 mm x 900 mm) will adequately represent the proposed construction in the building, but the results of that test do not apply to construction larger than limits defined by the laboratory conducting the pilot examination.

SECTION B STRUCTURE

CONTENTS

B1 Structural Provisions

- B1.1 General Requirements
- B1.2 Loads
- B1.3 Construction deemed-to-satisfy

B2 Demolition

No provisions

Appendices

ACT

- B1.101 Notice loading plates
- B1.102 Preservative treatment of timber
- B1.103 Evidence of visual stress grading
- B1.104 Rodent protection
- B1.105 Gypsum plasterboard
- B1.106 Excavation and earth-work
- B1.107 Retaining walls
- B2.101 Precautions during demolition

NSW

- B1.101 Foundations

NT

- Spec B1.2 Loads in cyclonic areas

SA

- B1.101 Foundation assessment
- B2.101 Demolition or removal of asbestos
- B2.102 Deemed to satisfy

WA

- Spec B1.3 Earth Wall Construction
- Spec B1.3 Seismic Construction - Class 1 Buildings

OBJECTIVES

A building must be so designed and constructed that the following objectives are fulfilled:

Part B1 Structural Provisions

All loads, internal actions, material properties and *foundation* conditions that significantly affect structural sufficiency or serviceability must be taken into account in the construction of a building or other structure.

Part B2 Demolition

Procedures and methods of demolition must be adequate to prevent injury to persons and avoid damage to neighbouring property.

PART B1 STRUCTURAL PROVISIONS

B1.1 General Requirements

A building or structure and its materials and components must be capable of sustaining at an acceptable level of safety and serviceability-

- (a) the most adverse combination of loads (including combinations of loads that might result in a potential for progressive collapse); and
- (b) other actions to which they may reasonably be subjected.

B1.2 Loads

The loading requirements of B1.1 are satisfied if the building or structure can resist loads determined in accordance with the following:

NT B1.2(a)

- (a) Dead, live, wind and snow loads: AS 1170.1, AS 1170.2 and AS 1170.3. *ý*

SA B1.2(b)

- (b) Seismic loads: Buildings erected in earthquake areas: AS 2121. *ý*

VIC B1.2(c)

B1.3 Construction deemed-to-satisfy

The requirements of B1.1 for materials and forms of construction are satisfied if they comply with the following:

- (a) Masonry (including masonry-veneer, unreinforced masonry and reinforced masonry): AS 3700.
- (b) Concrete construction (including reinforced and prestressed concrete): AS 3600.
- (c) Steel construction-
 - (i) Steel structures: AS 1250.
 - (ii) Cold formed steel structures: AS 1538.
- (d) Composite steel and concrete: AS 2327.
- (e) Aluminium construction: AS 1664.

QLD B1.3(f)

SA B1.3(f)

VIC B1.3(f)

- (f) Timber construction-
 - (i) Design of timber structures: AS 1720.

SUPERCEDED

- (ii) ý Timber structures located in an area not subject to seismic activity or snow loads, and where the design wind velocity calculated under AS 1170.2 does not exceed 33 m/s: AS 1684.
- (iii) ý In a Class 10a building located in an area in (ii) above with a *floor area* less than 60 m²: CSIRO-DBC&E Special Report- Low Rise Domestic and Similar Framed Structures, Part 4-Supplementary Domestic Buildings for Built-up Areas, Sections I to V.
 - [SA B1.3\(g\)](#)
 - [WA B1.3\(g\)](#)
- (g) ý Footings: Footings for Class 1 and 10a buildings: AS 2870.1
- (h) ý Piling: AS 2159.
 - [VIC B1.3\(i\)](#)
- (i) ý Glass installations: AS 1288.
- (j) ý Protection from termites: Where the building is subject to attack by subterranean termites:
 - (i) ý Physical barriers: AS 1694.
 - [SA B1.3\(j\)\(ii\)](#)
 - (ii) ý Soil treatment: AS 2057.
- (k) ý Roof construction (except in cyclone areas):
 - (i) ý Extruded PVC and glass fibre reinforced polyester (GRP) sheeting: AS 2376, AS 2424.
 - (ii) ý Concrete roofing tiles: AS 1757, AS 2050.
 - (iii) ý Terracotta roofing tiles: AS 2049, AS 2050.
 - [TAS B1.3\(k\)\(iv\)](#)
 - (iv) ý Cellulose fibre reinforced corrugated cement sheets: AS 2908 with safety mesh installed in accordance with AS 2424 Clause 2.3.3. for PVC and GRP sheeting.
 - [ACT B1.3\(k\)\(v\)](#)
 - (v) Metal roofing: AS 1562. ý
 - [TAS B1.3\(k\)\(vi\)](#)
 - [ACT B1.3\(l\)](#)
- (l) Particleboard structural flooring: AS 1860. ý
 - [WA B1.3\(m\)](#)
- (m) Earthwall construction: NBTC Bulletin 5, edition 4, Tables 3.1 and 3.7. ý
 - [SA B1.3\(n\)](#)
 - [VIC B1.3\(n\)\(o\)](#)
 - [WA B1.3\(n\)](#)
 - [ACT B1.102 to B1.107](#)
 - [NSW B1.01](#)
 - [NT SPEC B1.2](#)
 - [SA B1.101](#)

PART B2 DEMOLITION

No BCA provisions

SUPERCEDED

SUPERCEDED

ACT B2.101

SA B2.101, B2.102

***** y

SUPERCEDED

SECTION C FIRE RESISTANCE

CONTENTS

C1 Fire Resistance and Stability

- C1.1 Type of construction required
- C1.2 Calculation of rise in storeys
- C1.3 Buildings of multiple classification
- C1.4 Mixed Types of construction
- C1.5 Two storey Class 2 or 3 buildings
- C1.6 Class 4 parts of buildings
- C1.7 Open spectator stands and indoor sports stadiums
- C1.8 Lightweight construction
- C1.9 Class 1 and 10 buildings
- C1.10 Early Fire Hazard Indices

C2 Compartmentation and Separation

- C2.1 Application
- C2.2 General floor area limitations
- C2.3 Large isolated buildings
- C2.4 Requirements for open spaces and vehicular access
- C2.5 Class 9a buildings
- C2.6 Vertical separation of openings in external walls
- C2.7 Separation by fire walls
- C2.8 Separation of classifications in the same storey
- C2.9 Separation of classifications in different storeys
- C2.10 Separation of lift shafts
- C2.11 Stairways and lifts in one shaft
- C2.12 Separation of equipment
- C2.13 Electricity substations

C3 Protection of Openings

- C3.1 Application of Part
- C3.2 Protection of openings in external walls
- C3.3 Separation of openings in different fire compartments
- C3.4 Acceptable methods of protection
- C3.5 Doorways in fire walls
- C3.6 Sliding fire doors
- C3.7 Protection of doorways in horizontal exits

SUPERCEDED

- C3.8 Openings in fire-isolated exits
- C3.9 Service penetrations in fire-isolated exits
- C3.10 Openings in fire-isolated lift shafts
- C3.11 Bounding construction: Class 2, 3 and 4 buildings
- C3.12 Openings in floors for services
- C3.13 Openings in shafts
- C3.14 Openings for service installations
- C3.15 Installation deemed-to-satisfy

Specifications

- C1.1 Fire-Resisting Construction
- C1.8 Structural Tests for Lightweight Construction
- C1.9 Fire-resistance of Class 1 and 10 Buildings
- C1.10 Early Fire Hazard Indices
- C3.4 Fire Doors, Smoke Doors, Fire Windows and Shutters
- C3.15 Penetration of Walls, Floors and Ceilings by Services

Appendices

ACT

- C3.101 Notices on fire doors and smoke doors

NSW

- C1.101 Hollow glass-block window panels

Qld

- C1.101 Two storey Class 9b buildings

SA

- C2.101 Ancillary use areas in Class 9a buildings ý
- C2.102 Limit on area for ancillary use ý

Tas

- C1.101 Non-combustible roofing

OBJECTIVE

A building must be so designed and constructed that the following objectives are fulfilled:

Part C1 Fire Resistance and Stability

- (a) A building must be constructed so that it is protected from fire in any other building.
- (b) Materials used in the construction must be such that if there is a fire in the building-
 - (i) the spread of fire and the generation of smoke and toxic gases will be minimised;
 - (ii) stability will be maintained for a period at least sufficient for the occupants to escape and to ensure the safety of fire-fighters; and
 - (iii) there will be little risk of collapse onto adjoining property.

Part C2 Compartmentation and Separation

Building compartment size and separating construction must be such that the potential size of a fire and the spread of fire and smoke are limited in order to-

- (a) protect the occupants of one part of a building from the effects of fire elsewhere in the building.
- (b) control the spread of fire to adjoining buildings; and
- (c) facilitate access to the building by fire-fighters.

Part C3 Protection of Openings

Openings must be protected and service penetrations must be fire-stopped to maintain separation and compartmentation.

PART C1 FIRE RESISTANCE AND STABILITY

C1.1 Type of construction required

QLD C1.1(a)

- (a) The minimum Type of *fire-resisting construction* of a building must be that specified in Table C1.1 and Specification C1.1, except as allowed for-
 - (i) certain Class 2 or 3 buildings in C1.5;
 - (ii) Class 4 parts of buildings in C1.6;
 - (iii) *open spectator stands* and indoor sports stadiums in C1.7;
 - (iv) *lightweight construction* in C1.8; and
 - (v) Class 1 and 10 buildings in C1.9.
- (b) Type A construction is the most fire-resistant and Type C the least fire-resistant of the Types of construction.

Table C1.1 TYPE OF CONSTRUCTION REQUIRED

RISE

CLASS OF BUILDING

SUPERCEDED

(in storeys)	2, 3, 9	5, 6, 7, 8
4 OR MORE	A	A
3	A	B
2	B	C
1	C	C

C1.2 Calculation of rise in storeys

(a) \hat{y} The *rise in storeys* is the greatest number of *storeys* at any part of the *external walls* of the building-

(i) \hat{y} above the finished ground next to that part; or

(ii) \hat{y} if part of the *external wall* is on the boundary of the allotment, above the natural ground level at the relevant part of the boundary.

NSW C1.2(b)(i)

(b) \hat{y} A *storey* is not counted if-

(i) \hat{y} it is situated at the top of the building and contains only service units or equipment; or

(ii) \hat{y} it is situated partly below the finished ground and the underside of the ceiling is not more than 1 m above the average finished level of the ground at the *external wall*, or if the *external wall* is more than 12 m long, the average for the 12 m part where the ground is lowest.

(c) \hat{y} In a building of Class 7 or 8, a *storey* that has an average internal height of more than 6 m is counted as-

(i) \hat{y} one *storey* if it is the only *storey* above the ground; or

(ii) \hat{y} 2 *storeys* in any other case.

NSW C1.2(d)

C1.3 Buildings of multiple classification

Subject to C1.4, in a building of multiple classifications, the Type of *fire-resisting construction required* is the Type resulting from the application of Table C1.1 at each *storey* on the basis that-

(a) a classification applying to the particular *storey* applies also to the *storeys* vertically below it; and

(b) the particular *storey* and those vertically below it comprise an entire building.

C1.4 Mixed Types of construction

A building may be of mixed Types of construction if no part of the building is supported by, or vertically over, a part that is of a lower *fire-resistance level*.

C1.5 Two storey Class 2 or 3 buildings

NSW C1.5

A building of Class 2 or 3, or a mixture of these Classes, having a rise of 2 *storeys*, may be of Type C construction if-

(a) \hat{y} each *sole-occupancy unit* and all other parts of the building are served by at least 2 *exits* in addition to any *horizontal exit*; or

- (b) *ý* each *sole-occupancy unit* in the building has its own direct access to a road or *open space* and all other parts of the building are served by at least 2 *exits* in addition to any *horizontal exit*.

C1.6 Class 4 parts of buildings

NSW C1.6

A Class 4 part of a building requires the same FRL for *structural members* and the same construction separating the Class 4 part from the remainder of the building as a Class 2 part in similar circumstances.

C1.7 Open spectator stands and indoor sports stadiums

NSW C1.7

An *open spectator stand* or indoor sports stadium which has only changing rooms, sanitary facilities or the like below the tiered seating, need not comply with the other provisions of this Part if it contains not more than 1 tier of seating and is of Type C and *non-combustible* construction.

C1.8 Lightweight construction

Lightweight construction-

- (a) *ý* must comply with Spec. C1.8 if it is *non-loadbearing* and used in wall systems for use in-
- (i) *ý* *internal walls required to be fire-resisting* bounding *public corridors* or between or bounding *sole-occupancy units*; or
 - (ii) *ý* *lift shafts, stair shafts, passageways and ramps required to be fire-resisting*; or
 - (iii) *ý* *spectator stands, sports stadia, cinemas or theatres, railway or omnibus stations or airport terminals in-*
 - (A) *ý* *lift shafts or stair shafts*; or
 - (B) *ý* *external or internal walls bounding public corridors including fire-isolated passageways and ramps*; and
- (b) *ý* must not be used as protection to a *loadbearing wall, beam or column required to be fire-resisting* in a building having a *rise in storeys* of more than 4-
- (i) *ý* any Class 6, 7, 8 or 9a part of a building; and
 - (ii) *ý* any part below the Class 6, 7, 8 or 9a part.

NSW C1.8(c)

C1.9 Class 1 and 10 buildings *ý*

ACT C1.9

The construction of Class 1 and 10 buildings must comply with Specification C1.9.

C1.10 Early Fire Hazard Indices

VIC C1.10

The Early Fire Hazard Indices of materials and assemblies in Class 2 to 9 buildings must comply with Specification C1.10.

NSW C1.101

QLD C1.101

TAS C1.101

PART C2 COMPARTMENTATION AND SEPARATION

C2.1 Application

VIC C2.1

This Part does not apply to a Class 1 or 10 building or to an *open-deck carpark* or *open spectator stand*.

C2.2 General floor area limitations

- (a) \dot{y} The size of any *fire compartment* or *atrium* in a Class 5, 6, 7, 8 or 9b building must not exceed the relevant maximum *floor area* or volume set out in Table C2.2 except as permitted in C2.3.
- (b) \dot{y} A part of a building which contains only heating, ventilating, or lift equipment, water tanks, or similar service units is not counted in the *floor area* or volume of a *fire compartment* or *atrium* if it is situated at the top of the building.
- (c) \dot{y} In a building containing an *atrium*, the part of the *atrium well* bounded by the perimeter of the openings in the floors and extending from the level of the first floor above the *atrium* floor to the roof covering is not counted in the volume of the *atrium* for the purposes of this clause.

Table C2.2 MAXIMUM SIZE OF FIRE COMPARTMENTS OR ATRIA

		TYPE OF CONSTRUCTION OF BUILDING		
		Type A	Type B	Type C
CLASS 5 or 9b:	max <i>floor area</i> -	8 000 m ²	5 500 m ²	3 000 m ²
	max volume-	48 000 m ³	33 000 m ³	18 000 m ³
CLASS 6, 7, 8	max <i>floor area</i> -	5 000 m ²	3 500 m ²	2 000 m ²
	max volume-	30 000 m ³	21 000 m ³	12 000 m ³

C2.3 Large isolated buildings

The size of a *fire compartment* in a building may exceed that specified in Table C2.2 where-

- (a) \dot{y} the building does not exceed 18 000 m² in *floor area* or exceed 108 000 m³ in volume, if-
- (i) \dot{y} the building is Class 7 or 8, it contains not more than 2 *storeys* and an *open space* complying with C2.4(a) not less than 18 m wide is provided around the building; or
- (ii) \dot{y} the building is of any Class and is protected throughout with a *sprinkler system* and perimeter vehicular access complying with C2.4(b) is provided; or
- (b) \dot{y} the building exceeds 18 000 m² in *floor area* or 108 000 m³ in volume, is protected throughout with a *sprinkler system*, is provided with a perimeter vehicular access complying with C2.4(b) and if-

SUPERCEDED

- (i) \dot{y} the ceiling height of the *fire compartment* is not more than 12 m, it has a smoke exhaust system in accordance with Specification E2.6 or *smoke-and-heat vents* in accordance with E2.5; or
- (ii) \dot{y} the ceiling height is more than 12 m, it has a smoke exhaust system in accordance with Specification E2.6; or
- (c) \dot{y} there is more than one building on the allotment-
 - (i) \dot{y} each building must comply with (a) or (b); or
 - (ii) \dot{y} if the buildings are closer than 6 m to each other they are regarded as one building and collectively must comply with (a) or (b).

C2.4 Requirements for open spaces and vehicular access

- (a) \dot{y} An *open space required* by C2.3 must-
 - (i) \dot{y} be wholly within the allotment except that any road, river, or public place adjoining the allotment, but not the farthest 6 m of it may be included; and
 - (ii) \dot{y} include vehicular access in accordance with (b); and
 - (iii) \dot{y} not be used for the storage or processing of materials; and
 - (iv) \dot{y} not be built upon, except for guard houses and service structures (such as electricity substations and pump houses) which may encroach upon the width of the space if they do not unduly impede fire-fighting at any part of the perimeter of the allotment or unduly add to the risk of spread of fire to any building on an adjoining allotment.
- (b) \dot{y} Vehicular access *required* by this Part-
 - (i) \dot{y} must be capable of providing emergency vehicle access and passage from a public road; and
 - (ii) \dot{y} must have a minimum unobstructed width of 6 m with no part of its furthest boundary more than 18 m from the building and in no part of the 6 m width be built upon or used for any purpose other than vehicular or pedestrian movement; and
 - (iii) \dot{y} must provide reasonable pedestrian access from the vehicular access to the building; and
 - (iv) \dot{y} must be of adequate load bearing capacity and unobstructed height to permit the operation and passage of Fire Brigade vehicles; and
 - (v) \dot{y} where a public road complies with (i), (ii), (iii) and (iv) may serve as the vehicular access or part thereof.

C2.5 Class 9a buildings

In a Class 9a building-

- (a) \dot{y} the size of any *fire compartment* must not exceed 1700 m²;
- (b) \dot{y} *patient care areas*-
 - (i) \dot{y} must be divided into *fire compartments* each with a *floor area* of not more than 1700 m²; and
 - (ii) \dot{y} where the *floor area* exceeds 850 m² must be divided into areas not more than 850 m² by walls with an FRL of not less than 60/60/60; and
 - (iii) \dot{y} where the *floor area* exceeds 425 m² must be divided into areas not more than 425 m² by smoke-proof walls complying with (c); and

SUPERCEDED

SUPERCEDED

- (iv) \dot{y} when divisions of *patient care areas* by *fire-resisting* walls under (i) or (ii) above are not *required*, any smoke proof wall *required* under (iii) above must have an FRL of not less than 60/60/60; and
- (c) \dot{y} a wall *required* to be smoke-proof must-
 - (i) \dot{y} be *non-combustible* and extend to the underside of the floor above or of the roof covering; and
 - (ii) \dot{y} only have doorways which are fitted with smoke doors complying with Specification C3.4 and which do not extend higher than 800 mm from the underside of an imperforate roof covering, floor or ceiling above it; and NSW C2.5(c)(iii)
 - (iii) \dot{y} not incorporate any other opening which is not smoke-proof; and
- (d) \dot{y} *Fire compartments* must be separated from the remainder of the building by *fire walls* and-
 - (i) \dot{y} in Type A construction - floors and roof or ceiling as *required* in \dot{y} Specification C1.1; and \dot{y}
 - (ii) \dot{y} in Type B construction - floors with an FRL of not less than 120/120/120; and
 - (iii) \dot{y} in Type C construction - floors with an FRL of not less than 90/90/90.

C2.6 Vertical separation of openings in external walls

If in a building (other than an *open-deck carpark* or an *open spectator stand*) which is *required* to be of Type A construction and does not have a *sprinkler system*, any part of a *window* or other opening in an *external wall*, (except openings within the same stairway)-

- (i) \dot{y} is above another opening in the *storey* next below; and
 - (ii) \dot{y} its vertical projection falls no further than 450 mm outside the lower opening (measured horizontally),
- the openings must be separated by-
- (a) \dot{y} a spandrel which-
 - (i) \dot{y} is not less than 900 mm in height; and
 - (ii) \dot{y} extends not less than 600 mm above the upper surface of the intervening floor; and
 - (iii) \dot{y} is of *non-combustible* material having an FRL not less than 60/60/60; or
 - (b) \dot{y} part of a *curtain wall* or *panel wall* that complies with (a); or
 - (c) \dot{y} construction that complies with (a) behind a *curtain wall* or *panel wall* and has any gaps packed with a *non-combustible* material that will withstand thermal expansion and structural movement of the walling without loss of seal against fire and smoke; or
 - (d) \dot{y} a slab or other horizontal construction that-
 - (i) \dot{y} projects outwards from the external face of the wall not less than 1100 mm; and
 - (ii) \dot{y} extends along the wall not less than 450 mm beyond the openings concerned; and
 - (iii) \dot{y} is *non-combustible* and has an FRL of not less than 60/60/60; or
 - (e) \dot{y} other construction which is as equally effective as (a), (b), (c) or (d).

SUPERCEDED

C2.7 Separation by fire walls ^ý

NSW C2.7

A part of a building separated from the remainder of the building by a *fire wall* is treated as a separate building if-

- (a) ^ý the *fire wall*-
 - (i) ^ý extends through all *storeys* and spaces in the nature of *storeys* that are common to that part and any adjoining part of the building; and
 - (ii) ^ý is carried through to the underside of the roof covering; and
 - (iii) ^ý has the relevant FRL prescribed by Specification C1.1 for each of the adjoining parts, and if these are different, the greater FRL; and
- (b) ^ý any openings in a *fire wall* comply with Part C3; and
- (c) ^ý timber purlins or other *combustible* material do not pass through or cross the *fire wall*; and
- (d) ^ý where the roof of one of the adjoining parts is lower than the roof of the other part, the *fire wall* extends to the underside of-
 - (i) ^ý the covering of the higher roof, or not less than 6 m above the covering of the lower roof; or
 - (ii) ^ý the lower roof if it has an FRL not less than that of the *fire wall* and no openings closer than 3 m to any wall above the lower roof; or
 - (iii) ^ý the lower roof if its covering is *non-combustible* and the lower part has a *sprinkler system*,
 or the design of the building must otherwise restrict the spread of fire from the lower part to the higher part.

C2.8 Separation of classifications in the same storey

If a building has parts of different classifications located alongside one another in the same *storey*-

- (a) ^ý each building element in that *storey* must have the higher FRL prescribed in Specification C1.1 for that element for the classifications concerned; or
- (b) ^ý the parts must be separated in that *storey* by a *fire wall* with whichever is the greater of-
 - (i) ^ý an FRL of 90/90/90 if the parts are served in any *storey* by the same *public corridor*, public hallway, or the like; or
 - (ii) ^ý the higher FRL prescribed in Specification C1.1 for the classifications concerned.

C2.9 Separation of classifications in different storeys

If parts of different classification are situated one above the other in adjoining *storeys* they must be separated as follows:

- (a) ^ý Type A construction - The floor between the adjoining parts must have an FRL not less than that prescribed in Specification C1.1 for the classification of the lower *storey*.
- (b) ^ý Type B or C construction (applicable only if one of the adjoining parts is of Class 2, 3 or 4) - The underside of the floor (including the sides and underside of any floor beams) must have a *fire-protective covering*.

C2.10 Separation of lift shafts

Lifts connecting more than 2 *storeys*, or more than 3 *storeys* if the building is sprinklered, (other than lifts which are wholly within an *atrium*) must be separated from the remainder of the building by enclosure in a *shaft* in which-

- (a) $\dot{\gamma}$ in a building *required* to be of Type A construction - the walls have the relevant FRL prescribed by Specification C1.1;
- (b) $\dot{\gamma}$ in a building *required* to be of Type B construction- the walls are-
 - (i) $\dot{\gamma}$ in accordance with (a) if the *shaft* is *loadbearing*; or
 - (ii) $\dot{\gamma}$ of *non-combustible* construction if the *shaft* is *non-loadbearing*; and
- (c) $\dot{\gamma}$ openings for lift landing doors and services are protected in accordance with Part C3.

C2.11 Stairways and lifts in one shaft

A stairway and lift must not be in the same *shaft* if either the stairway or the lift is *required* to be in a *fire-resisting shaft*.

C2.12 Separation of equipment

WA C2.12

- (a) $\dot{\gamma}$ A room housing equipment other than as described in (b) must be bound by a wall having an FRL of not less than 120/120/120 if that equipment comprises-
 - (i) $\dot{\gamma}$ lift motors and lift control panels; or
 - (ii) $\dot{\gamma}$ the main electrical switchboard in a building where it supports emergency equipment; or
 - VIC C2.12(a)(iii)
 - (iii) $\dot{\gamma}$ *required* stair pressurising equipment; or
 - (iv) $\dot{\gamma}$ emergency generators or central smoke control plant, except where located in a separate *storey* (or in the topmost *storey*) and separated from the remainder of the building by floor construction having an FRL of 120/120/120 or otherwise adequately separated from the remainder of the building; or
 - (v) $\dot{\gamma}$ boilers; or
 - (vi) $\dot{\gamma}$ batteries; or
 - (vii) $\dot{\gamma}$ sprinkler valve equipment.
- (b) $\dot{\gamma}$ A room housing the following need not comply with (a)-
 - (i) $\dot{\gamma}$ equipment located in a separate *storey* (or in the topmost *storey*) and separated from the remainder of the building by floor construction having an FRL of 120/120/120;
 - (ii) $\dot{\gamma}$ smoke control exhaust fans located in the air stream if they are $\dot{\gamma}$ constructed for high temperature operation in accordance with $\dot{\gamma}$ Specification E2.6; or $\dot{\gamma}$
 - (iii) $\dot{\gamma}$ equipment that is otherwise adequately separated from the remainder of the building.

C2.13 Electricity substations

If an electricity substation is situated within a building-

- (a) it must be separated from any other part of the building by construction having an FRL of not less than 120/120/120; and
VIC C2.13(b)
- (b) ∫ any doorways opening to any other part of the building must be protected with *self-closing* fire doors having an FRL of not less than 120/120/30 ; and
- (c) ∫ electricity supply cables between a main and the substation, and between the substation and the main electrical switchboard, must be enclosed or otherwise protected by construction having an FRL of not less than 120/120/120.
SA C2.101, C2.102

PART C3 PROTECTION OF OPENINGS

C3.1 Application of Part

- (a) ∫ This Part does not apply to-
- (i) ∫ Class 1 or Class 10 buildings; or
 - (ii) ∫ control joints, weep holes and the like in *external walls* of masonry construction and joints between panels in *external walls* of pre-cast concrete panel construction if, in all cases they are not larger than necessary for the purpose; or
 - (iii) ∫ *non-combustible* ventilators for sub-floor or cavity ventilation, if each does not exceed 45 000 mm² in face area and is spaced not less than 2 m from any other ventilator in the same wall.
- (b) ∫ This Part applies to openings in building elements *required* to be *fire-resisting*, including doorways, *windows* (including any associated fanlight) infill panels and fixed or openable glazed areas that do not have the *required* FRL.

VIC C3.1(c)

C3.2 Protection of openings in external walls

Openings in an *external wall* that is *required* to have an FRL must-

NSW C3.2(a)

- (a) be not less from a *fire-source feature* to which it is exposed than-
- (i) ∫ 1 m in a building not more than 1 *storey* in rise; or
 - (ii) ∫ 1.5 m in a building more than 1 *storey* in rise; and
- NSW C3.2(b)
- (b) ∫ be protected in accordance with C3.4 if it is situated less from a *fire-source feature* to which it is exposed than-
- (i) ∫ 3 m from a side or rear boundary of the allotment; or
 - (ii) ∫ 6 m from the far boundary of a road adjoining the allotment; or
 - (iii) ∫ 6 m from another building on the allotment that is not Class 10; and
- (c) ∫ if *required* to be protected under (b), not occupy more than 1/3 of the area of the *external wall* of the *storey* in which it is located unless-
- (i) they are in a Class 9b building used as an *open spectator stand*; or
 - (ii) they face a public road and are located in a *storey* at ground level.

C3.3 Separation of openings in different fire compartments

Unless they are protected in accordance with C3.4, the distance between openings in *external walls* in *fire compartments* separated by a *fire wall* must not be less than that set out in Table C3.3.

Table C3.3 DISTANCE BETWEEN OPENINGS IN DIFFERENT FIRE COMPARTMENTS

ANGLE BETWEEN WALLS γ	MIN. DISTANCE BETWEEN OPENINGS
0° (walls opposite)	6 m
more than 0° to 45°	5 m
more than 45° to 90°	4 m
more than 90° to 135°	3 m
more than 135° to less than 180°	2 m
180° or more	Nil

C3.4 Acceptable methods of protection

- (a) γ Where protection is *required*, doorways, *windows* and other openings must be protected as follows:
- (i) γ Doorways - *external wall*-wetting sprinklers or 60/60/30 fire doors (*self-closing* or *automatic* closing).
 - (ii) γ *Windows* - *external wall*-wetting sprinklers, 60/60/- fire *windows* (*automatic* or permanently fixed in the closed position) or 60/60/- *automatic* fire shutters;
 - (iii) γ Other openings - *external wall*-wetting sprinklers or construction having an FRL not less than 60/60/-.
- (b) γ Fire doors, fire *windows* and fire shutters satisfy (a) if they comply with Specification C3.4.

C3.5 Doorways in fire walls

The aggregate width of openings for doorways in a *fire wall*, which are not part of a *horizontal exit*, must not exceed 1/2 of the length of the *fire wall*, and each doorway must be protected by-

NSW C3.5(a)

VIC C3.5(a)

- (a) γ 2 fire doors or fire shutters, one on each side of the wall, each of which-
- (i) γ has an FRL of not less than 1/2 that *required* by Specification C1.1 for the *fire wall* except that the *insulation* level of each door or shutter may be 30; and
 - (ii) γ is *self-closing* or *automatic* closing if the *automatic* closing device is designed to operate if there is smoke in the part of the building on either side of the *fire wall*; or
- (b) γ a fire door on one side and a fire shutter on the other side of the doorway, each of which complies with (a); or
- NSW C3.5(c)
- VIC C3.5(c)
- (c) a single fire door or fire shutter, that is not a metallic fire shutter, which-

SUPERCEDED

- (i) \dot{y} has an FRL of not less than that *required* by Specification C1.1 for the *fire wall* except that the *insulation* level may be 30; and
- (ii) \dot{y} is *self-closing* or *automatic* closing if the *automatic* closing device is designed to operate if there is smoke in the part of the building on either side of the *fire wall*.

C3.6 Sliding fire doors

NSW C3.6

If a doorway in a *fire wall* is fitted with a sliding fire door which is open when the building is in use-

VIC C3.6(a)

- (a) \dot{y} it must be held open with an electromagnetic device, which when de-activated, allows the door to be fully closed not less than 20 seconds, and not more than 30 seconds, after release; and

VIC C3.6(b)

- (b) \dot{y} thermal or smoke detectors as appropriate must be installed on each side of the doorway in accordance with AS 1905.1; and
- (c) \dot{y} an audible warning device located near the doorway and a red flashing warning light of a suitable intensity on each side of the doorway must be activated when a *required* detector or *sprinkler system* in the part of the building served by the door is activated; and
- (d) \dot{y} signs must be installed on each side of the doorway located directly over the opening stating-

WARNING - SLIDING FIRE DOOR

in capital letters not less than 50 mm high in a colour contrasting with the background.

C3.7 Protection of doorways in horizontal exits

NSW C3.7

A doorway that is part of a *horizontal exit* must be protected by either-

- (a) \dot{y} a single fire door that has an FRL of not less than that *required* by Specification C1.1 for the *fire wall* except that the *insulation* level may be 30; or
- (b) \dot{y} in a Class 7 or 8 building - 2 fire doors, one on each side of the doorway, each with an FRL of not less than 1/2 that *required* by Specification C1.1 for the *fire wall* except that the *insulation* level of each door may be 30.

In all cases each door must be *self-closing* or *automatic*-closing provided the *automatic*-closing operation is initiated by smoke sensing devices located on each side of the *fire wall* not more than 1.5 m horizontal distance from the opening.

Note: Heat sensing devices may be installed if smoke sensors are unsuitable in the ambient atmosphere.

C3.8 Openings in fire-isolated exits

NSW C3.8(a)

- (a) \dot{y} Doorways that open to *fire-isolated stairways*, *fire-isolated passageways* or *fire-isolated ramps*, and are not doorways opening to a road or *open space*, must be protected by 60/60/30 fire doors that are *self-closing*, or *automatic* closing provided the *automatic* closing operation of any door is initiated simultaneously

SUPERCEDED

by a smoke sensing device located not more than 1.5 m horizontal distance from the approach side of the opening.

- (b) *ý* A *window* in an *external wall* of a *fire-isolated stairway*, *fire-isolated passageway* or *fire-isolated ramp* must be protected in accordance with C3.4 if it is within 6 m of, and exposed to-
- (i) *ý* a *fire-source feature*; or
 - (ii) *ý* a *window* or other opening in a wall of the same building, unless they both serve the same fire-isolated enclosure.

C3.9 Service penetrations in fire-isolated exits

WA C3.9

Fire-isolated *exits* must not be penetrated by any services other than-

- (a) *ý* electrical wiring associated with a lighting or pressurisation system serving the *exit*; or
- (b) *ý* ducting associated with the pressurisation system if it-
 - (i) *ý* is constructed of material having an FRL of not less than 120/120/60 where it passes through any other part of the building; and
 - (ii) *ý* does not open into any other part of the building; or
- (c) *ý* water supply pipes for fire services.

C3.10 Openings in fire-isolated lift shafts

- (a) *ý* Doorways - If a lift *shaft* is *required* to be fire-isolated under Part C2, an entrance doorway to that *shaft* must be protected by 60/60/- fire doors that-
 - (i) *ý* comply with AS 1735.11; and
 - (ii) *ý* are set to remain closed except when discharging or receiving *ý* passengers, goods or vehicles. *ý*
- (b) *ý* Lift indicator panels - A lift call panel, indicator panel or other panel in the wall of a fire-isolated lift *shaft* must be backed by construction having an FRL of not less than 60/60/60 if it exceeds 35 000 mm² in area.

C3.11 Bounding construction: Class 2, 3 and 4 buildings

- (a) *ý* A doorway in a Class 2 or 3 building must be protected if it provides access from a *sole-occupancy unit* to-
 - (i) *ý* a *public corridor*, public hallway, or the like; or
 - (ii) *ý* a room not within a *sole-occupancy unit*; or
 - (iii) *ý* the landing of an internal non-*fire-isolated stairway* that serves as a *required exit*; or
 - (iv) *ý* another *sole-occupancy unit*.

NSW C3.11(b) to (e)

- (b) *ý* A doorway in a Class 4 part must be protected if it provides access to any other internal part of the building.
- (c) *ý* Protection for a doorway must be at least-
 - (i) *ý* in a building of Type A construction - a *self-closing* 60/60/30 fire door; and
 - (ii) *ý* in a building of Type B or C construction - a *self-closing*, tight fitting, solid core door, not less than 35 mm thick.

- (d) Other openings in *internal walls* which are *required* to have an FRL to inhibit the lateral spread of fire must not reduce the *fire-resisting* performance of the wall.

QLD C3.11(e)

C3.12 Openings in floors for services

In a building of Type A construction, services passing through a floor must either be installed in *shafts* complying with Specification C1.1 or protected in accordance with C3.14.

C3.13 Openings in shafts

In a building of Type A construction, an opening in a wall providing access to a ventilating, pipe, garbage or other service *shaft* must be protected by-

- (a) ý if it is in a *sanitary compartment* - a door or panel which, together with its frame, is *non-combustible* or has an FRL of not less than 30/30/30; or
- (b) ý a *self-closing* 60/60/30 fire door or hopper; or
- (c) ý an access panel having an FRL of not less than 60/60/30; or
- (d) ý if the *shaft* is a garbage *shaft* - a door or hopper of *non-combustible* construction.

C3.14 Openings for service installations

An electrical, electronic, plumbing, mechanical ventilation, air-conditioning or other service that penetrates a building element (other than an *external wall* or roof) that is *required* to have an FRL for a *resistance to the incipient spread of fire*, must be installed so that the *fire-resisting* performance of the building element is not impaired.

C3.15 Installation deemed-to-satisfy

An installation satisfies C3.14 if-

- (a) ý the method and materials used are identical with a prototype assembly of the service and building element which has achieved the *required* FRL or *resistance to the incipient spread of fire*; or
- (b) ý it complies with (a) except for the *insulation* criteria relating to the service and-
 - (i) ý the service is protected so that *combustible* material cannot be located within 100 mm of it; and
 - (ii) ý it is not located in a *required exit*; or
- (c) ý in the case of ventilating or air-conditioning ducts or equipment the installation is-
 - (i) ý in accordance with AS 1668.1; or
 - (ii) ý the service incorporates *automatic* fire dampers which comply with AS 1682, if AS 1668.1 is not applicable; or
- (d) ý the service is a metal pipe installed in accordance with Specification C3.15 and it-
 - (i) ý penetrates a wall, floor or ceiling, but not a ceiling *required* to have a *resistance to the incipient spread of fire*; and
 - (ii) ý connects not more than 2 *fire compartments*; and

- (iii) ý does not contain a flammable or *combustible* liquid or gas; or
- (e) ý the service is sanitary plumbing installed in accordance with Specification C3.15 and it-
 - (i) ý is of metal or UPVC pipe; and
 - (ii) ý penetrates the floors of a Class 5, 6, 7, 8 or 9b building; and
 - (iii) ý is in *sanitary compartments* which are separated from other parts of the building by walls with the FRL *required* by Specification C1.1 for a stair *shaft* in the building and a *self-closing* 60/60/30 fire door; or
- (f) ý the service is a wire or cable, or a cluster of wires or cables installed in accordance with Specification C3.15 and it-
 - (i) ý penetrates a wall, floor or ceiling, but not a ceiling *required* to have a *resistance to the incipient spread of fire*; and
 - (ii) ý connects not more than 2 *fire compartments*; or
- (g) ý the service is an electrical switch, outlet, or the like, and it is installed in accordance with Specification C3.15.

ACT C3.101

SPECIFICATION C1.1 ý FIRE-RESISTING CONSTRUCTION

1. ý SCOPE

This Specification contains requirements for the *fire-resisting construction* of building elements.

2. ý GENERAL REQUIREMENTS

2.1 Exposure to fire-source features

- (a) ý A part of a building element is exposed to a *fire-source feature* if any of the horizontal straight lines between that part and the *fire-source feature*, or vertical projection of the feature, is not obstructed by another part of the building that-
 - (i) ý has an FRL of not less than 30/-/-; and
 - (ii) ý is neither transparent nor translucent.
- (b) ý A part of a building element is not exposed to a *fire-source feature* if the *fire-source feature* is-
 - (i) ý an *external wall* of another building that stands on the allotment and the part concerned is more than 15 m above the highest part of that *external wall*; or
 - (ii) ý a side or rear boundary of the allotment and the part concerned is below the level of the finished ground at every relevant part of the boundary concerned.
- (c) ý If various distances apply for different parts of a building element-
 - (i) ý the entire element must have the FRL applicable to that part having the least distance between itself and the relevant *fire-source feature*; or
 - (ii) ý each part of the element must have the FRL applicable according to its individual distance from the relevant *fire-source feature*,

but this provision does not override or permit any exemption from Clause 2.2.

2.2 Fire protection for a support of another part

VIC Spec C1.1 2.2

A part of a building that gives direct vertical or lateral support to another part *required* to have an FRL, must-

- (a) have an FRL in respect of *structural adequacy* that is the greater of-
 - (i) that *required* for the part it supports; or
 - (ii) that *required* for the part itself; and
- (b) be *non-combustible* if the part it supports is *required* to be *non-combustible*.

2.3 Lintels

A lintel must have the FRL *required* for the part of the building in which it is situated, unless it does not contribute to the support of a fire door, fire *window* or fire shutter, and-

- (a) √ it spans an opening in-
 - (i) √ a wall of a building containing only one *storey*; or
 - (ii) √ a *non-loadbearing* wall of a Class 2 or 3 building; or
- (b) √ it spans an opening in masonry which is not more than 150 mm thick and-
 - (i) √ not more than 3 m wide if the masonry is *non-loadbearing*; or
 - (ii) √ not more than 1.8 m wide if the masonry is *loadbearing* and part of a solid wall or one of the leaves of a cavity wall.

2.4 Attachments not to impair fire-resistance

- (a) √ A *combustible* material may be used as a finish or lining to a wall or roof, or in a sign, sunscreen or blind, awning, or other attachment to a building element which has the *required* FRL if-
 - (i) √ the material is exempted under Clause 7 of Specification C1.10 or complies with the Early Fire Hazard Indices prescribed in Clause 2 of Specification C1.10; and
 - (ii) √ it is not located near or directly above a *required exit* so as to make the *exit* unusable in a fire; and
 - (iii) √ it does not otherwise constitute an undue risk of fire spread via the facade of the building.
- (b) √ The attachment of a facing or finish, or the installation of ducting or any other service, to a part of a building *required* to have an FRL must not impair the *required* FRL of that part.

2.5 General concessions

- (a) √ **Steel columns** - Except in a *fire wall* or common wall, a steel column need not have an FRL in a building that contains only one *storey*.
- (b) √ **Timber columns** - a timber column may be used in a single *storey* building if:
 - (i) √ in a *fire wall* or common wall the column has an FRL not less than that listed in the appropriate Table 3, 4 or 5; and
 - (ii) √ in any other case the column has an FRL of not less than 30/-/-.

- (c) **Structures on roofs** - A *non-combustible* structure situated on a roof need not comply with the other provisions of this Specification if it only contains one or more of the following:
- (i) **Hot water or other water tanks.**
 - (ii) **Ventilating ductwork, ventilating fans and their motors.**
 - (iii) **Air-conditioning chillers.**
 - (iv) **Window cleaning equipment.**
 - (v) **Lift equipment.**
 - (vi) **Other service units that are *non-combustible* and do not contain *combustible* liquids or gases.**
- (d) **Curtain walls and panel walls** - A requirement for an *external wall* to have an FRL does not apply to a *curtain wall* or *panel wall* which is of *non-combustible* construction and fully protected by *automatic external wall-wetting* sprinklers.
- (e) **Non-combustible materials** - the following materials, though *combustible* or containing *combustible* fibres, may be used wherever the BCA requires a *non-combustible* material:
- (i) **plasterboard;**
 - (ii) **perforated gypsum lath with a normal paper finish;**
 - (iii) **fibrous-plaster sheet conforming to AS 2185 Specification for Fibrous Plaster Products;**
 - (iv) **fibre-reinforced cement sheeting.**

[NSW Spec C1.1 2.5(f)]

2.6 Mezzanine floors: Concession

- (a) This clause does not apply to a Class 9b building that is a spectator stand or audience viewing area accommodating more than 100 persons as calculated according to D1.13.
- (b) A *mezzanine* and its supports need not have an FRL or be *non-combustible* provided-
- (i) the total *floor area* of all the *mezzanines* in the same room does not exceed 1/3 the *floor area* of the room or 200 m², whichever is the lesser; and
 - (ii) the FRL of each wall and column that supports any other part of the building within 6 m of the *mezzanine* is increased by the amount listed in Table 2.6.

Table 2.6 INCREASED FRLs - CONSTRUCTION SURROUNDING MEZZANINES

LEVEL OTHERWISE REQUIRED FOR ANY FRL CRITERION (mins)	INCREASE IN LEVEL TO (not less than):
30	60
60	90
90	120
120	180
180	240

The increase in level applies to each FRL criterion (*structural adequacy, integrity or insulation*) relevant to the building element concerned.

2.7 Enclosure of shafts

Shafts required to have an FRL must be enclosed at the top and bottom by construction having an FRL not less than that *required* for the walls of a non-loadbearing shaft in the same building, except that these provisions need not apply to-

- (a) *the top of a shaft extending beyond the roof covering, other than one enclosing a fire-isolated stairway or ramp; or*
- (b) *the bottom of a shaft if it is non-combustible and laid directly on the ground.*

3. *ý* TYPE A FIRE-RESISTING CONSTRUCTION

3.1 Fire-resistance of building elements

In a building *required* to be of Type A construction-

- (a) *ý* each building element listed in Table 3 and any beam or column incorporated in it, must have an FRL not less than that listed in the Table for the particular Class of building concerned; and
- (b) *ý* *external walls*, common walls and the flooring and floor framing of lift pits must be *non-combustible*; and
- (c) *ý* any *internal wall required* to have an FRL must extend to-
 - (i) *ý* the underside of the floor next above; or
 - (ii) *ý* the underside of a roof complying with Table 3, or, if under Clause 3.5 the roof is not *required* to comply with Table 3, the underside of the *non-combustible* roof covering; or
 - (iii) *ý* a ceiling that is immediately below the roof and has a *resistance to the incipient spread of fire* to the roof space between the ceiling and the roof of not less than 60 minutes; and
- (d) *ý* a *loadbearing internal wall* and a *loadbearing fire wall* (including those that are part of a *loadbearing shaft*) must be of concrete or masonry; and
- (e) *ý* a *non-loadbearing-*
 - (i) *ý* *internal wall required* to be *fire-resisting*; and
 - (ii) *ý* lift, ventilating, pipe, garbage, or similar *shaft* that is not for the discharge of hot products of combustion, *ý* must be of *non-combustible* construction; and *ý*
- (f) *ý* the FRLs specified in Table 3 for an external column apply also to those parts of an internal column that face and are within 1.5 m of a *window* and are exposed through that *window* to a *fire-source feature*.

Table 3 TYPE A CONSTRUCTION: FRL OF BUILDING ELEMENTS *ý*

FRL: (in minutes)				
<i>Structural adequacy / Integrity / Insulation</i>				
CLASS OF BUILDING				
BUILDING ELEMENT	2, 3 or 4 part	5 or 9	6 <i>ý</i>	7 or 8
EXTERNAL WALL (including any column and other building element incorporated therein) or other external building element excluding a roof, where the distance from any <i>fire-source feature</i> to which it is exposed is -				
For <i>loadbearing</i> parts-				
less than 1.5 m	90/ 90/ 90	120/120/120	180/180/180	240/240/240

SUPERCEDED

1.5 to less than 3 m	90/ 60/ 60	120/ 90/ 90	180/180/120	240/240/180
3 or more	90/ 60/ 30	120/ 60/ 30	180/120/ 90	240/180/ 90
For <i>non-loadbearing</i> parts-				
less than 1.5 m	90/ 90/ 90	120/120/120	180/ 180/180	240 /240/240
1.5 to less than 3 m	90/ 60/ 60	120/ 90/ 90	180/ 180/120	240 /240/180
3 m or more	- / - / -	- / - / -	- / - / -	- / - / -
EXTERNAL COLUMN not incorporated in an <i>external wall</i> , where the distance from any <i>fire-source feature</i> to which it is exposed is -				
less than 3 m	90/ - / -	120/ - / -	180/ - / -	240/ - / -
3 m or more	- / - / -	- / - / -	- / - / -	- / - / -
COMMON WALLS and FIRE WALLS -				
	90/ 90/ 90	120/120/120	180/180/180	240/240/240
INTERNAL WALLS-				
<i>Fire-resisting lift and stair shafts-</i>				
<i>Loadbearing</i>	90/ 90/ 90	120/120/120	180/120/120	240/120/120
<i>Non-loadbearing</i>	90/ 90/ 90	120/120/120	120/120/120	120/120/120
Bounding <i>public corridors</i> , public hallways and the like-				
<i>Loadbearing</i>	90/ 90/ 90	120/ - / -	180/ - / -	240/ - / -
<i>Non-loadbearing</i>	60/ 60/ 60	- / - / -	- / - / -	- / - / -
Between or bounding <i>sole-occupancy units-</i>				
<i>Loadbearing</i>	90/ 90/ 90	120/ - / -	180/ - / -	240/ - / -
<i>Non-loadbearing</i>	60/ 60/ 60	- / - / -	- / - / -	- / - / -
Ventilating, pipe, garbage, and like <i>shafts</i> not used for the discharge of hot products of combustion-				
<i>Loadbearing</i>	90/ 90/ 90	120/ 90/ 90	180/120/120	240/120/120
<i>Non-loadbearing</i>	90/ 90/ 90	90/ 90/ 90	120/120/120	120/120/120
OTHER LOADBEARING INTERNAL WALLS; and INTERNAL BEAMS, TRUSSES and COLUMNS-				
	90/ - / -	120/ - / -	180/ - / -	240/ - / -
FLOORS	90/ 90/ 90	120/120/120	180/180/180	240/240/240
ROOFS	90/ 60/ 30	120/ 60/ 30	180/ 60/ 30	240/ 90/ 60
[Note: A dash, for examples 90/ - / - or - / - / -, means there is no requirement for an FRL for that criterion.]				

3.2 Concessions for floors

A floor need not comply with Table 3 if-

- (a) ý it is laid directly on the ground;
- (b) ý in a Class 2, 3, 5 or 9 building, the space below is not a *storey*, does not accommodate motor vehicles, is not a storage or work area, and is not used for any other ancillary purpose;
- (c) ý it is a timber stage floor in a Class 9b building laid over a floor having the *required* FRL and the space below the stage is not used as a dressing room, store room, or the like;

[NSW Spec C1.1 3.2(d)]
- (d) ý it separates 2 *storeys* within the same *sole-occupancy unit* in a Class 2 building; or
- (e) ý it is an open-access floor (for the accommodation of electrical and electronic services and the like)above a floor with the *required* FRL.

SUPERCEDED

3.3 Floor loading of Class 5 and 9b buildings: Concession

If a floor in a Class 5 or 9b building is designed for a live load not exceeding 3 kPa-

- (a) ∫ the floor next above (including floor beams) may have an FRL of 90/90/90; or
- (b) ∫ the roof, if that is next above (including roof beams) may have an FRL of 90/60/30.

3.4 Roof superimposed on concrete slab: Concession

A roof superimposed on a concrete slab roof need not comply with Clause 3.1 as to *fire-resisting construction* if-

- (a) ∫ the superimposed roof and any construction between it and the concrete slab roof are *non-combustible* throughout; and
- (b) ∫ the concrete slab roof complies with Table 3.

3.5 Roof: Concession

A roof need not comply with Table 3 if its covering is *non-combustible* and the building-

- (a) ∫ has a *sprinkler system* installed throughout;
- (b) ∫ has a *rise in storeys* of 3 or less;
- (c) ∫ is of Class 2 or 3; or
- (d) ∫ has an *effective height* of not more than 25 m and the ceiling immediately below the roof has a *resistance to the incipient spread of fire* to the roof space of not less than 60 minutes.

3.6 Rooflights

If a roof is *required* to have an FRL or be *non-combustible*, a rooflight installed in that roof must-

- (a) ∫ have an area not more than 20% of the roof surface; and
- (b) ∫ be not less than 3 m from-
 - (i) ∫ any boundary of the allotment other than the boundary with a road or public place; and
NSW Spec C1.1 3.6(b)(ii)
 - (ii) ∫ any part of the building which projects above the roof unless that part has the FRL *required* of a *fire wall* and any openings in the wall are protected in accordance with C3.4;
 - (iii) ∫ any rooflight in an adjoining *sole-occupancy unit* if the walls bounding the unit are *required* to have an FRL; and
 - (iv) ∫ any rooflight in an adjoining fire-separated section of the building; and
- (c) ∫ if a ceiling with a *resistance to the incipient spread of fire* is *required*, be installed in a way that will maintain the level of protection provided by the ceiling to the roof space.

3.7 Internal columns and walls: Concession

For a building with an *effective height* of not more than 25 m and having a roof without an FRL in accordance with Clause 3.5, in the *storey* immediately below that roof, internal columns other than those referred to in Clause 3.1(f) and *load-bearing internal walls* other than *fire walls* may have-

- (a) ∫ in a Class 2 or 3 building : FRL 60/60/60; or

- (b) \dot{y} in a Class 5, 6, 7, 8 or 9 building-
 - (i) \dot{y} with rise exceeding 3 storeys : FRL 60/60/60
 - (ii) \dot{y} with rise not exceeding 3 storeys : no FRL.

3.8 Open spectator stands and indoor sports stadiums: Concession

In an *open spectator stand* or indoor sports stadium, the following building elements need not have the FRL specified in Table 3 :

- (a) \dot{y} The roof if it is *non-combustible*.
- (b) \dot{y} Columns and *loadbearing* walls supporting only the roof if they are *non-combustible*.
- (c) \dot{y} Any *non-loadbearing* part of an *external wall* less than 3 m-
 - (i) \dot{y} from any *fire-source feature* to which it is exposed if it has an FRL of not less than 60/60/60 and is *non-combustible*; or
 - (ii) \dot{y} from an *external wall* of another *open spectator stand* if it is *non-combustible*.

3.9 Carparks

QLD Spec C1.1 3.9

Table 3.9, instead of Table 3, applies to an *open-deck carpark* and a sprinklered carpark.

BUILDING ELEMENT \dot{y}	FRL
Column or beam- less than 4.5 m from a <i>fire-source feature</i> to which it is exposed	60/ - / -
Wall- less than 3 m from a <i>fire-source feature</i> to which it is exposed	60/60/60
Other steel column- ratio of exposed surface area to mass per unit length not greater than 26 m ² /tonne	- / - / -
Any other column (other than a column supporting only the roof)	60/ - / -
Fire wall or lift or stair shaft	120/120/120
Any other steel floor beam- which is in continuous contact with a concrete floor slab and has a ratio of exposed surface area to mass per unit length of not more than 30 m ² /tonne	- / - / -
Any other floor beam	60/ - / -
Floor slab or vehicle ramp	60/ 60/ 60
Roof and columns supporting only the roof	- / - / -

[Note: A dash, for examples 90/ - / - or - / - / -, means there is no requirement for an FRL for that criterion.]

4. \dot{y} TYPE B FIRE-RESISTING CONSTRUCTION

4.1 Fire-resistance of building elements

In a building *required* to be of Type B construction-

- (a) \dot{y} each building element listed in Table 4, and any beam or column incorporated in it, must have an FRL not less than that listed in the Table for the particular Class of building concerned; and
- (b) \dot{y} the *external walls*, common walls, and the flooring and floor framing in any lift pit, must be *non-combustible*; and

SUPERCEDED

- (c) ý if a stair *shaft* supports any floor or a structural part of it-
 - (i) ý the floor or part must have an FRL of 60/-/- or more; or
 - (ii) ý the junction of the stair *shaft* must be constructed so that the floor or part will be free to sag or fall in a fire without causing structural damage to the *shaft*; and
- (d) ý any *internal wall* which is *required* to have an FRL must extend to-
 - (i) ý the underside of the floor next above if that floor has an FRL of at least 30/30/30; or
 - (ii) ý the underside of a ceiling having a *resistance to the incipient spread of fire* to the space above itself of not less than 60ýminutes; or
 - (iii) ý the underside of the roof covering if it is *non-combustible*, or 450 mm above the roof covering if it is *combustible*, and must not be crossed by timber purlins or other *combustible* material,
 unless the wall bounds a *sole-occupancy unit* in the topmost (or only) *storey* and there is only one unit in that *storey*;
- (e) ý a *loadbearing internal wall* and a *loadbearing fire wall* (including those that are part of a *loadbearing shaft*) must be of concrete or masonry;
- (f) ý a *non-loadbearing internal wall required to be fire-resisting* must be of *non-combustible* construction;
- (g) ý lift, ventilating, pipe, garbage, and similar *shafts* which are not for the discharge of hot products of combustion and not *loadbearing*, must be of *non-combustible* construction in-
 - (i) ý a Class 2, 3 or 9 building; and
 - (ii) ý a Class 5, 6, 7 or 8 building if the *shaft* connects more than 2 *storeys*; and
- (h) ý in a Class 2, 3 or 9 building, except where within the one *sole-occupancy unit*, a floor separating *storeys* or above a space for the accommodation of motor vehicles or used for storage or any other ancillary purpose, must-
 - (i) ý be constructed so that it is at least of the standard achieved by a floor/ceiling system incorporating a ceiling which has a *resistance to the incipient spread of fire* to the space above itself of not less than 60ýminutes; or
 - (ii) ý have a *fire-protective covering* on the underside of the floor, including beams incorporated in it, if the floor is *combustible* or of metal, or has an FRL less than 30/30/30.

Table 4 TYPE B CONSTRUCTION: FRL OF BUILDING ELEMENTS ý

BUILDING ELEMENT	FRL: (in minutes)			
	Structural adequacy / Integrity / Insulation			
	CLASS OF BUILDING			
	2, 3 or 4 part	5 or 9	6	7 or 8
EXTERNAL WALL (including any column and other building element incorporated therein) or other external building element excluding roofs, where the distance from any <i>fire-source feature</i> to which it is exposed is - For <i>loadbearing</i> parts-				
less than 1.5 m	90/ 90/ 90	120/120/120	180/180/180	240/240/240
1.5 to less than 3 m	90/ 60/ 30	120/ 90/ 60	180/120/ 90	240/180/120
3 to less than 9 m	90/ 30/ 30	120/ 30/ 30	180/ 90/ 60	240/ 90/ 60

SUPERCEDED

9.0 to less than 18 m	90/ 30/ -	120/ 30/ -	180/ 60/ -	240/ 60/ -
For <i>non-loadbearing</i> parts-				
less than 1.5 m	90/ 90/ 90	120/120/120	180/ 180/180	240/240/240
1.5 to less than 3 m	90/ 60/ 30	120/ 90/ 60	180/ 120/ 90	240/180/120
3 m or more	- / - / -	- / - / -	- / - / -	- / - / -
EXTERNAL COLUMN not incorporated in an <i>external wall</i> , where the distance from any <i>fire-source feature</i> to which it is exposed is -				
less than 3 m	90/ - / -	120/ - / -	180/ - / -	240/ - / -
3 m or more	- / - / -	- / - / -	- / - / -	- / - / -
COMMON WALLS and FIRE WALLS -				
	90/ 90/ 90	120/120/120	180/180/180	240/240/240
INTERNAL WALLS-				
<i>Fire-resisting lift and stair shafts-</i>				
<i>Loadbearing</i>	90/ 90/ 90	120/120/120	180/120/120	240/120/120
<i>Fire-resisting stair shafts-</i>				
<i>Non-Loadbearing</i>	90/ 90/ 90	120/120/120	120/120/120	120/120/120
Bounding <i>public corridors</i> , public hallways and the like-				
<i>Loadbearing</i>	60/ 60/ 60	120/ - / -	180/ - / -	240/ - / -
<i>Non-loadbearing</i>	60/ 60/ 60	- / - / -	- / - / -	- / - / -
Between or bounding <i>sole-occupancy units-</i>				
<i>Loadbearing</i>	60/ 60/ 60	120/ - / -	180/ - / -	240/ - / -
<i>Non-loadbearing</i>	60/ 60/ 60	- / - / -	- / - / -	- / - / -
OTHER LOADBEARING INTERNAL WALLS; and INTERNAL BEAMS, TRUSSES and COLUMNS-				
	60/ - / -	120/ - / -	180/ - / -	240/ - / -

[Note: A dash, for examples 90/ - / - or - / - / -, means there is no requirement for an FRL for that criterion.]

4.2 Carparks

QLD Spec C1.1 4.2

Table 4.2, instead of Table 4, applies to an *open-deck carpark* and a sprinklered carpark.

Table 4.2 REQUIREMENTS FOR CARPARKS ^y	FRL
BUILDING ELEMENT	
Column or beam- less than 4.5 m from a <i>fire-source feature</i> to which it is exposed	60/ - / -
Wall- less than 3 m from a <i>fire-source feature</i> to which it is exposed	60/60/60
Other steel column- ratio of exposed surface area to mass per unit length not greater than 26 m ² /tonne	- / - / -
Any other column	60/ - / -
Fire wall or lift or stair shaft	120/120/120
Any other steel floor beam- which is in continuous contact with a concrete floor slab and has a ratio of exposed surface area to mass per unit length of not more than 30 m ² /tonne	- / - / -
Any other floor beam	60/ - / -

[Note: A dash, for examples 90/ - / - or - / - / -, means there is no requirement for an FRL for that criterion.]

5. ý TYPE C FIRE-RESISTING CONSTRUCTION

5.1 Fire-resistance of building elements

In a building *required* to be of Type C construction-

- (a) ý a building element listed in Table 5 and any beam or column incorporated in it, must have an FRL not less than that listed in the Table for the particular Class of building concerned;
- (b) ý an *external wall* that is *required* by Table 5 to have an FRL may be considered to have an FRL if the outer part of the wall has the *required* FRL;
- (c) ý a *fire wall* or an *internal wall* bounding a *sole-occupancy unit* or separating adjoining units must comply with Specification C1.8 if it is of *lightweight construction*;
- (d) ý in a Class 2 or 3 building an *internal wall* which is *required* by Table 5 to have an FRL must extend-
 - (i) ý to the underside of the floor next above if that floor has an FRL of at least 30/30/30 or a *fire-protective covering* on the underside of the floor; or
 - (ii) ý to the underside of a ceiling having a *resistance to the incipient spread of fire* to the space above itself of not less than 60 minutes; or
 - (iii) ý to the underside of the roof covering if it is *non-combustible* or 450 mm above the roof covering if it is *combustible* and must not be crossed by timber purlins or other *combustible* material, unless the wall bounds a *sole-occupancy unit* in the topmost (or only) *storey* and there is only one unit in that *storey*; and
- (e) ý except where within the one *sole-occupancy unit*, a floor separating *storeys* in a Class 2, 3 or 9 building, or above a space for the accommodation of motor vehicles or used for storage or any other ancillary purpose, and any column supporting the floor, must-
 - (i) ý have an FRL of at least 30/ 30/ 30; or
 - (ii) ý have a *fire-protective covering* on the underside of the floor including beams incorporated in it and around the column, if the floor or column is *combustible* or of metal.

Table 5 TYPE C CONSTRUCTION: FRL OF BUILDING ELEMENTS ý

BUILDING ELEMENT	FRL: (in minutes)			
	Structural adequacy / Integrity / Insulation			
	CLASS OF BUILDING			
	2, 3 or 4 part	5 or 9	6	7 or 8
EXTERNAL WALL (including any column and other building element incorporated therein) or other external building element excluding a roof, where the distance from any <i>fire-source feature</i> to which it is exposed is -				
less than 1.5 m	90/ 90/ 90	90/ 90/ 90	90/ 90/ 90	90/ 90/ 90
1.5 to less than 3 m	- / - / -	60/ 60/ 60	60/ 60/ 60	60/ 60/ 60
EXTERNAL COLUMN not incorporated in an <i>external wall</i> , where the distance from any <i>fire-source feature</i> to which it is exposed is -				
less than 1.5 m	90/ - / -	90/ - / -	90/ - / -	90/ - / -
1.5 to less than 3 m	- / - / -	60/ - / -	60/ - / -	60/ - / -
COMMON WALLS and FIRE WALLS -	90/ 90/ 90	90/ 90/ 90	90/ 90/ 90	90/ 90/ 90
INTERNAL WALLS-				

Bounding <i>public corridors</i> , public hallways \dot{y} and the like-	60 / 60/ 60	- / - / -	- / - / -	- / - / -
Between or bounding \dot{y} <i>sole-occupancy units</i> -	60/ 60/ 60	- / - / -	- / - / -	- / - / -
Bounding a stair if \dot{y} <i>required to be rated</i> -	60/ 60/ 60	- / - / -	- / - / -	- / - / -

[Note: A dash, for examples 90/ - / - or - / - / -, means there is no requirement for an FRL for that criterion.]

5.2 Carparks

QLD Spec C1.1 5.2

Table 5.2, instead of Table 5, applies to an *open-deck carpark* and a sprinklered carpark.

BUILDING ELEMENT \dot{y}	FRL
Column or beam - less than 1.5 m from a <i>fire-source feature</i> to which it is exposed	60/ - / -
Wall - less than 1.5 m from a <i>fire-source feature</i> to which it is exposed	60/60/60
Other steel column - ratio of exposed surface area to mass per unit length not greater than 26 m ² /tonne	- / - / -
Any other column	60/ - / -
Fire wall or lift or stair shaft	120/120/120
Any other steel floor beam - which is in continuous contact with a concrete floor slab and has a ratio of exposed surface area to mass per unit length of not more than 30 m ² /tonne	- / - / -
Any other floor beam	60/ - / -

[Note: A dash, for examples 90/ - / - or - / - / -, means there is no requirement for an FRL for that criterion.]

SPECIFICATION C1.8 \dot{y} STRUCTURAL TESTS FOR LIGHTWEIGHT CONSTRUCTION

1. \dot{y} Scope

This Specification contains details of the tests to be applied and criteria to be satisfied by non-*loadbearing* wall systems of *lightweight construction*.

2. \dot{y} Definition

Lightweight construction is as defined in A1.1.

3. \dot{y} Application

The tests prescribed in this specification apply to construction other than concrete or masonry, which need not be tested in accordance with this specification if it is designed-

- (a) \dot{y} in accordance with the BCA; and
- (b) \dot{y} to resist, as serviceability loads, the appropriate pressure and impact defined in this Specification, to the extent that such resistance is not provided through compliance with (a).

4. ý **Test methods**

Tests must be carried out in accordance with the following:

- (a) ý **Materials tests** - in accordance with the methods specified for the constituent materials of the construction in the standards adopted by reference in the BCA.
- (b) ý **For resistance to static pressure** - The provisions for testing walls under transverse load in ASTM E72-80, except that the chamber method must not be used.
- (c) ý **For resistance to impact** - The provisions for testing wall systems in ASTM E695-79 (1985), except that-
 - (i) ý the point of impact must be set at 1.5 m above finished floor level or 1.5 m above the part of the specimen that corresponds to finished floor level;
 - (ii) ý the impact bag must be not less than 225 mm in diameter and not more than 260 mm in diameter and have a mass of 27.2 kg (+ 0.1 kg, -0);
 - (iii) ý the mass must be achieved by putting loose, dry sand into the bag and must be adjusted before each series of impact tests; and
 - (iv) ý the method may be used also for walls that depart from the vertical or that are curved and in cases where the impact bag and suspension cannot be vertical at the instant of impact on a concave surface or a surface inclined towards the impact, the height of drop is the net height at the point of impact.
- (d) ý **For resistance to surface indentation** - for all materials irrespective of composition: AS 2185 - Appendix A2, Surface Hardness.
- (e) ý **For resistance of lift shaft construction to repetitive load** - as for 4(b) except that-
 - (i) ý the load must be applied dynamically at a frequency not less than 1 Hz and not more than 3 Hz; and
 - (ii) ý it is sufficient to test one specimen with the pressure applied from the side of the construction on which the lift will operate.

5. ý **Test specimens**

Tests must be carried out on construction in situ or on specimens of the construction in accordance with Clause 4 except that-

- (a) ý test specimens of the construction must be supported at top and bottom (or at each end if tested horizontally) by components identical with, and in a manner identical with, the actual construction; and
- (b) ý the heights of the test specimens (or lengths, if the specimens are tested horizontally) must be identical with the height between those supports in the actual construction.

6. ý **Criteria of compliance**

The following criteria must be adopted to determine compliance with this Specification:

- (a) ý **Material** - Material must comply with the applicable standard adopted by reference in the BCA.

- (b) **Damage** - The construction must not show any crack, penetration or permanent surface-deformation to a depth of more than 0.5 mm or any other non-elastic deformation or fastener failure.
- (c) **Deflection - Static pressure** - Under static pressure the deflection of the construction must not be more than-
 - (i) 1/240th of the height between supports (the span of the construction as tested);
 - (ii) 30 mm; or
 - (iii) 20 mm for lift *shafts* unless the requirements of Clause 15.2(a) of AS 1735.2 are fulfilled.
- (d) **Deflection - Impact** - Under impact the instantaneous deflection of the construction must not be more than-
 - (i) 1/120th of the height between supports (the span of the construction as tested); nor
 - (ii) 30 mm; or
 - (iii) 20 mm for lift *shafts* unless the requirements of Clause 15.2(a) of AS 1735.2 are fulfilled.
- (e) **Surface indentation** - No impression must be more than 5 mm in diameter when tested in accordance with Appendix 2 of AS 2185.

7. **Non-loadbearing wall systems**

Wall systems for use in *non-loadbearing internal walls* that are *required* to be fire resisting bounding *public corridors*, public hallways or the like, between or bounding *sole-occupancy units* must be subjected to the following tests and must fulfil the following criteria:

- (a) The materials tests of Clause 4(a) and the materials properties criteria of Clause 6(a).
- (b) A static test by the imposition of a uniformly distributed load of 0.25 kPa (or its equivalent) in accordance with Clause 4(b) and the damage and deflection criteria of Clauses 6(b) and (c) respectively.
- (c) A dynamic test by the imposition of the impact of the impact bag falling through a height of 100 mm in accordance with Clause 4(c) and the damage deflection criteria of Clauses 6(b) and (d) respectively.
- (d) The surface indentation test of Clause 4(d) and the surface indentation criterion of Clause 6(e).

8. **Wall systems bounding means of egress**

Wall systems bounding means of egress or the like including wall systems for use in *non-loadbearing lift shafts*, *non-loadbearing stair shafts*, *fire-isolated passageways* and *fire-isolated ramps* that are *required* to be *fire-resisting* must be subjected to the following tests and must fulfil the following criteria:

- (a) The materials tests of Clause 4(a) and the materials properties criteria of Clause 6(a).
- (b) A static test by the imposition of a uniformly distributed load (or its equivalent) of 0.35 kPa in accordance with Clause 4(b) and the damage and deflection criteria of Clauses 6(b) and (c) respectively.

- (c) ý A dynamic test by the imposition of the impact of the impact bag falling through a height of 150 mm in accordance with Clause 4(c) and the damage and deflection criteria of Clauses 6(b) and (d) respectively.
- (d) ý The surface indentation test of Clause 4(d) and the surface indentation criterion of Clause 6(e).

9. ý Requirements for certain Class 9b buildings

Wall systems for use in spectator stands, sports stadia, cinemas or theatres, railway or omnibus stations, or airport terminals, in non-*loadbearing*-

(a) ý lift *shafts* or stair *shafts*;

(b) ý external and *internal walls* bounding *public corridors*, public hallways or the like, including fire-isolated and non-*fire-isolated passageways* or ramps,

must be subjected to the following tests and must fulfil the following criteria:

- (i) ý The materials tests of Clause 4(a) and the materials properties criteria of Clause 6(a).
- (ii) ý A static test by the imposition of a uniformly distributed load of 1.0 kPa (or its equivalent) in accordance with Clause 4(b) and the damage and deflection criteria of Clauses 6(b) and (c) respectively.
- (iii) ý A dynamic test by the imposition of the impact of the impact bag falling through a height of 350 mm in accordance with Clause 4(c) and the damage and deflection criteria of Clauses 6(b) and (d) respectively.
- (iv) ý The surface indentation test of Clause 4(d) and the surface indentation criterion of Clause 6(e).

10. Lift shafts

In addition to the requirements of Clauses 8 and 9, wall systems for use in non-*loadbearing* lift *shafts* that are *required* to be *fire-resisting* must be subjected to dynamic test by the imposition of 106 cycles of a uniformly distributed load between 0 and 0.35 kPa (or its equivalent) in accordance with Clause 4(e) and must fulfil the damage criteria of Clause 6(b).

SPECIFICATION C1.9 ý FIRE-RESISTANCE OF CLASS 1 AND 10 BUILDINGS

QLD Spec C1.9

VIC Spec C1.9

1. ý Scope

This Specification sets out the requirements for the construction of Class 1 and 10a buildings to resist the spread of fire.

2. ý External walls of Class 1 buildings

(a) ý Except as permitted by Clause 5 or 6, an *external wall* of a Class 1 building and any openings in that wall, must comply with Clause 3 if-

NSW Spec C1.9 2(a)(i)

- (i) the wall is set back less than 1 m from an allotment boundary other than ý the boundary adjoining a road alignment or other public space; or ý

- (ii) ý the wall is less than 2 m from another building other than a Class 10 building on the same allotment.
- (b) ý The distance from a building to an allotment boundary or another building is the shortest distance measured from the outermost point of the building or buildings concerned.

3. ý **Class 1 buildings: Construction of external walls**

(a) ý *External walls* referred to in Clause 2 must-

- (i) ý if the building is 1 or 2 *storeys* - be of concrete, masonry or masonry-veneer construction in which the external masonry veneer is not less than 90 mm thick or have an FRL of not less than 60/60/60; or
- (ii) ý if the building is more than 2 *storeys* - have an FRL of not less than 60/60/60; and

NSW Spec C1.9 3(b)

(b) ý Openings in *external walls* referred to in Clause 2 must-

- (i) ý be protected with fire *windows* or glass block or other construction with an FRL of at least 60/60/- ; and
- (ii) ý not be fitted with openable *windows*.

4. ý **Class 10a buildings: External walls**

An *external wall* of a Class 10a building, other than an open garage, must be of *non-combustible* construction or lined externally with *non-combustible* material if it is set back less than 1 m from the allotment boundary other than a road alignment or other public space.

5. **Allowable encroachments**

The following-

- (a) ý fascias, gutters, downpipes, *non-combustible* lining of eaves and the like; and
- (b) ý masonry chimney backs, flues, pipes, domestic fuel tanks, cooling or heating appliances or other services;

may encroach into that distance if the distance to the boundary is not reduced to less than 500 mm or the distance between the buildings is not reduced to less than 1ým, unless protected by a wall complying with Clause 3.

6. ý **Exceptions**

Clause 2 does not apply to-

- (a) ý an existing *external wall* that is reclad if the recladding does not reduce the distance to the boundary or building by more than 150 mm; and
- (b) ý light fittings, electricity or gas meters, aerials or antennae;
- (c) ý pergolas or sun blinds; and
- (d) ý unroofed terraces, landings, steps or ramps, not more than 1 m in height.

7. ý **Common walls**

A common wall must-

- (a) ý if it separates Class 1 buildings, or it separates a Class 1 building from a Class 10a building on another allotment-
 - (i) ý have an FRL of not less than 90/90/90; and
 - (ii) ý be of masonry or concrete construction; and
 - (iii) ý extend to the underside of a *non-combustible* roof cladding or not less than 450 mm above a roof with a *combustible* roof cladding; or
- (b) ý if it separates Class 10a buildings on different allotments, be lined with a *non-combustible* material.

8. ý Separating floors

NSW Spec C1.9 8

The underside of a floor separating *sole-occupancy units*, each being a separate domicile and located one above the other, must be lined with *non-combustible* material.

9. ý Sarking-type materials

Any *sarking-type material* used in a Class 1 building must have a *Flammability Index* of not more than 5.

TAS Spec C1.9 101

SPECIFICATION C1.10 EARLY FIRE HAZARD INDICES

1. ý Scope

This Specification sets out requirements in relation to the Early Fire Hazard Indices of materials, linings and surface finishes in buildings.

2. ý Class 2 to 9 buildings: General requirements

Except where superseded by Clause 3 or 4, any material or component used in a Class 2, 3, 5, 6, 7, 8, or 9 building must-

- (a) ý in the case of a sarking-type material, have a *Flammability Index* not more than 5; or
- (b) ý in the case of other materials, have-
 - (i) ý a *Spread-of-Flame Index* not more than 9; and
 - (ii) ý a *Smoke-Developed Index* not more than 8 if the *Spread-of-Flame Index* is more than 5; or
- (c) ý be completely covered on all faces by concrete or masonry not less than 50 mm thick; or
- (d) ý in the case of a composite member or assembly, be constructed so that when assembled as proposed in a building-
 - (i) ý any material which does not comply with (a) or (b) is protected on all sides and edges from exposure to the air;
 - (ii) ý the member or assembly, when tested in accordance with Specification A2.4, has a *Smoke-Developed Index* and a *Spread-of-Flame Index* not exceeding those prescribed in (b); and

- (iii) ý the member or assembly retains the protection in position so that it prevents ignition of the material and continues to screen it from access to free air for a period of not less than 10 minutes.

3. ý **Fire-isolated exits**

In a *fire-isolated stairway*, *fire-isolated passageway*, or *fire-isolated ramp* in a Class 2 to 9 building-

- (a) ý a material, other than a *sarking-type material* used in a ceiling or used as a finish, surface, lining or attachment, must have a-
 - (i) ý *Spread-of-Flame Index* of 0;
 - (ii) ý *Smoke-Developed Index* of not more than 2; and
 - (iii) ý if *combustible*, be attached directly to a *non-combustible* substrate and not exceed 1 mm in finished thickness;
- (b) ý a *sarking-type material* used in the form of an exposed wall or ceiling, or as a finish or attachment thereto, must have a *Flammability Index* of 0.

4. ý **Class 2, 3 and 9 buildings**

A material, other than a *sarking-type material* must if-

- (a) ý in a Class 2, 3, 9a or 9b building, it is used as a finish, surface, lining or attachment to any wall or ceiling in a *public corridor* which is a means of egress to-
 - (i) ý a *required fire-isolated stairway* or an external stairway used instead; or
 - (ii) ý a *required fire-isolated passageway*, or *required fire-isolated ramp*, have a *Spread-of-Flame Index* of 0 and a *Smoke-Developed Index* of not more than 5; or
- (b) ý in a Class 9a building in a patient-care area, it is used as a finish, surface, lining or attachment to a-
 - (i) ý ceiling - have a *Spread-of-Flame Index* of 0 and a *Smoke-Developed Index* of not more than 3; and
 - (ii) ý wall - have a *Spread-of-Flame Index* of not more than 2 and a *Smoke-Developed Index* of not more than 5; and
 - (iii) ý floor - have a *Spread-of-Flame Index* of not more than 3 and a *Smoke-Developed Index* of not more than 5 or a *Spread-of-Flame Index* of 0 and a *Smoke-Developed Index* of not more than 6; or
- (c) ý in a Class 9b building used as a theatre, public hall or the like in the auditorium or audience seating area and associated assembly areas, it is used as a finish, surface, lining or attachment to a-
 - (i) ý ceiling - have a *Spread-of-Flame Index* of not more than 6 and a *Smoke-Developed Index* of not more than 3; and
 - (ii) ý wall - have a *Spread-of-Flame Index* of not more than 6 and a *Smoke-Developed Index* of not more than 5; and
 - (iii) ý floor - have a *Spread-of-Flame Index* of not more than 7 and a *Smoke-Developed Index* of not more than 5; or
- (d) ý in a Class 9b building used as a theatre, public hall or the like, it is used in any part of fixed seating in the audience area or auditorium have a *Spread-of-Flame Index* of 0 and a *Smoke-Developed Index* of not more than 5.

5. ý Materials deemed to comply

A material complies with Clauses 2, 3 or 4 if it is-

- (a) ý plaster, cement render, concrete, terrazzo, ceramic tile or the like; or
- (b) ý a *fire-protective covering*.

6. ý Fire-retardant coatings not acceptable

Paint or fire-retardant coatings must not be used in order to make a substrate comply with a *required Spread-of-Flame Index*, *Smoke-Developed Index* or *Flammability Index*.

7. ý Exempted building parts and materials

The requirements in this Specification for a *Spread-of-Flame Index*, *Smoke-Developed Index* or *Flammability Index* do not apply to-

- (a) ý timber-framed *windows*;
- (b) ý solid timber handrails or skirtings;
- (c) ý timber-faced solid-core or fire doors;
- (d) ý electrical switches, outlets, cover plates or the like;
- (e) ý materials used for-
 - (i) ý roof covering or membranes, or roof insulating material, applied in continuous contact with a substrate;
 - (ii) ý adhesives; or
 - (iii) ý damp-proof courses, flashing, caulking, sealing, ground moisture barriers, or the like;
- (f) ý paint, varnish, lacquer or similar finish, other than nitro-cellulose lacquer;
- (g) ý a clear or translucent rooflight of glass fibre reinforced polyester if-
 - (i) ý the roof in which it is installed forms part of a single *storey* building *required* to be of Type C construction;
 - (ii) ý the material is used as part of the roof covering;
 - (iii) ý it is not prohibited by any other clause of the BCA;
 - (iv) ý it is not closer than 1.5 m from another rooflight of the same type;
 - (v) ý each rooflight is not more than 14 m² in area; and
 - (vi) ý the area of the rooflights per 70 m² of roof surface is not more than 14 m²;

or
- (h) ý the face plates and neck adaptors of supply and return air outlets of air-handling systems;
- (i) ý the face plates or diffuser plates of light fittings and emergency *exit* signs and associated electrical wiring and electrical components; or
- (j) ý any other material that does not significantly increase the hazards of fire.

SPECIFICATION C3.4 \dot{y} FIRE DOORS, SMOKE DOORS, FIRE WINDOWS AND SHUTTERS

1. \dot{y} Scope

This Specification sets out requirements for the construction of fire doors, smoke doors, fire *windows* and fire shutters.

2. \dot{y} Fire doors

A *required* fire door must-

- (a) \dot{y} comply with AS 1905.1; and
- (b) \dot{y} not fail by radiation through any glazed part during the period specified for *integrity* in the *required* FRL.

3. \dot{y} Smoke doors

A *required* smoke door may have one or 2 door leaves and must-

- (a) \dot{y} be side-hung to swing-
 - (i) \dot{y} in the direction of egress; or
 - (ii) \dot{y} in both directions if the path of travel to *exits* is in either direction;
- (b) \dot{y} (i) return to the fully closed position after each manual opening; or
NSW Spec C3.4 3(b)(ii)
 (ii) \dot{y} close *automatically*, if *automatic* operation is initiated by smoke sensing devices located in each side of the doorway not more than 1.5 m horizontal distance from the opening;
- (c) \dot{y} be constructed of solid-core at least 35 mm thick or other suitable material capable of resisting smoke heated to 200°C for 30 minutes;
- (d) \dot{y} be fitted into rebates having a width not less than 12 mm at the edges and top and a clearance of not more than 10 mm between a door leaf and the finished floor or be fitted with smoke seals; and
- (e) \dot{y} if fitted with glazed panels use safety glass as defined in AS 1228 and have a mid-rail or suitable crash bar.

4. \dot{y} Fire shutters

A *required* fire shutter must-

- (a) \dot{y} be a shutter that-
 - (i) \dot{y} is identical with a tested prototype that has achieved the *required* FRL; and
 - (ii) \dot{y} is installed in the same manner and in an opening that is not larger than the tested prototype; and
 - (iii) \dot{y} did not have a rise in average temperature on the side remote from the furnace of more than 140 K during the first 30 minutes of the test; or
- (b) \dot{y} is a steel shutter complying with AS 1905.2 if a metallic fire shutter is not prohibited by C3.5.

5. Fire windows

A *required* fire window must be-

- (a) √ identical in construction with a prototype that has achieved the *required* FRL; and
- (b) √ installed in the same manner and in an opening that is not larger than the tested prototype.

SPECIFICATION C3.15 √ PENETRATION OF WALLS, FLOORS AND CEILINGS BY SERVICES

1. √ Scope

This Specification prescribes materials and methods of installation for services that penetrate walls, floors and ceilings *required* to have an FRL.

2. √ Application

- (a) √ This Specification applies to installations permitted under the BCA as alternatives to systems that have been demonstrated by test to fulfil the requirements of C3.14.
- (b) √ This Specification does not apply to installations in ceilings *required* to have a *resistance to the incipient spread of fire* nor to the installation of piping that contains or is intended to contain a flammable liquid or gas.

3. √ Metal pipes

- (a) √ A metal pipe that is not normally filled with liquid must not penetrate a wall, floor or ceiling within 100 mm of any *combustible* material, and must be constructed of-
 - (i) √ copper alloy or stainless steel with a wall thickness of at least 1 mm; or
 - (ii) √ cast iron or steel (other than stainless steel) with a wall thickness of at least 2 mm.
- (b) √ An opening for a metal pipe must-
 - (i) √ be neatly formed, cut or drilled; and
 - (ii) √ be no closer than 200 mm to any other service penetration; and
 - (iii) √ accommodate only one pipe.
- (c) √ A metal pipe must be wrapped but must not be lagged or enclosed in thermal *insulation* over the length of its penetration of a wall, floor or ceiling unless the lagging or thermal *insulation* fulfils the requirements of Clause 7.
- (d) √ The gap between a metal pipe and the wall, floor or ceiling it penetrates must be fire-stopped in accordance with Clause 7.

4. √ Pipes penetrating sanitary compartments

If a pipe of metal or UPVC penetrates the floor of a *sanitary compartment* in accordance with C3.15(e) of the BCA-

- (a) ý the opening must be neatly formed and no larger than is necessary to accommodate the pipe or fitting; and
- (b) ý the gap between pipe and floor must be fire-stopped in accordance with Clause 7.

5. ý Wires and cables

If a wire or cable or cluster of wires or cables penetrates a floor, wall or ceiling-

- (a) ý the opening must be neatly formed, cut or drilled and no closer than 50 mm to any other service opening; and
- (b) ý the opening must be no larger in cross-sectional area than-
 - (i) ý 2000 mm² if only a single cable is accommodated and the gap between cable and wall, floor or ceiling is no wider than 15 mm; or
 - (ii) ý 500 mm² in any other case; and
- (c) ý the gap between the service and the wall, floor or ceiling must be fire-stopped in accordance with Clause 7.

6. ý Electrical switches and outlets

If an electrical switch, outlet, socket or the like is accommodated in an opening or recess in a wall, floor or ceiling-

- (a) ý the opening or recess must not-
 - (i) ý be located opposite any point within 300 mm horizontally or 600 mm vertically of any opening or recess on the opposite side of the wall; or
 - (ii) ý extend beyond half the thickness of the wall; and
- (b) ý the gap between the service and the wall, floor or ceiling must be fire-stopped in accordance with Clause 7.

7. ý Fire-stopping

- (a) ý **Material:** The material used for the fire-stopping of service penetrations must be concrete, high-temperature mineral fibre, high-temperature ceramic fibre or other material that does not flow at a temperature below 1120°C when tested in accordance with AS 1038.15, and must have-
 - (i) ý demonstrated in a system tested in accordance with C3.15(a) of the BCA that it does not impair the *fire-resisting* performance of the building element in which it is installed; or
 - (ii) ý demonstrated in a test in accordance with (e) that it does not impair the *fire-resisting* performance of the test slab.
- (b) ý **Installation:** Fire-stopping material must be packed into the gap between the service and wall, floor or ceiling in a manner, and compressed to the same degree, as adopted for testing under Clause 7(a)(i) or (ii).
- (c) ý **Hollow construction:** If a pipe penetrates a hollow wall (such as a stud wall, a cavity wall or a wall of hollow blockwork) or a hollow floor/ceiling system, the cavity must be so framed and packed with fire-stopping material that the material is-
 - (i) ý installed in accordance with 7(b) to a thickness of 25 mm all round the service for the full length of the penetration; and

SUPERCEDED

- (ii) ý restrained, independently of the service, from moving or parting from the surfaces of the service and of the wall, floor or ceiling.
- (d) ý **Recesses:** If an electrical switch, socket, outlet or the like is accommodated in a recess in a hollow wall or hollow floor/ceiling system-
 - (i) ý the cavity immediately behind the service must be framed and packed with fire-stopping material in accordance with 7(c); or
 - (ii) ý the back and sides of the service must be protected with refractory lining board identical with and to the same thickness as that in which the service is installed.
- (e) ý **Test:** The test to demonstrate compliance of a fire-stopping material with this Specification must be conducted as follows:
 - (i) ý The test specimen must comprise a concrete slab not less than 1 m square and not more than 100 mm thick, and appropriately reinforced if necessary for *structural adequacy* during manufacture, transport and testing.
 - (ii) ý The slab must have a hole 50 mm in diameter through the centre and the hole must be packed with the fire-stopping material.
 - (iii) ý The slab must be conditioned in accordance with AS 1530.4.
 - (iv) ý Two thermocouples complying with AS 1530.4 must be attached to the upper surface of the packing each about 5 mm from its centre.
 - (v) ý The slab must be tested on flat generally in accordance with Section 10 of AS 1530.4 and must achieve an FRL of 60/60/60 or as otherwise *required*.

SECTION D ACCESS AND EGRESS

CONTENTS

D1	Provision for Escape
D1.1	Application
D1.2	Number of exits required
D1.3	When fire-isolated exits are required
D1.4	Exit travel distances
D1.5	Distance between alternative exits
D1.6	Dimensions of exits
D1.7	Travel via fire-isolated exits
D1.8	External stairways
D1.9	Travel by non-fire-isolated stairways or ramps
D1.10	Discharge from exits
D1.11	Horizontal exits
D1.12	Non-required stairways, ramps or escalators
D1.13	Number of persons accommodated
D1.14	Measurement of distances
D1.15	Method of measurement
D2	Construction of Exits
D2.1	Application of Part
D2.2	Fire-isolated stairways and ramps
D2.3	Non-fire-isolated stairways and ramps
D2.4	Separation of rising and descending stair flights
D2.5	Open access ramps and balconies
D2.6	Smoke lobbies
D2.7	Installations in exits and paths of travel
D2.8	Enclosure of space under stairs and ramps
D2.9	Width of stairways
D2.10	Pedestrian ramps
D2.11	Fire-isolated passageways
D2.12	Roof as open space
D2.13	Treads and risers
D2.14	Landings
D2.15	Thresholds
D2.16	Balustrades
D2.17	Handrails

SUPERCEDED

- D2.18 Fixed platforms, walkways, stairways and ladders
- D2.19 Doorways and doors
- D2.20 Swinging doors
- D2.21 Operation of latch
- D2.22 Re-entry from fire-isolated exits

D3 Access for People with Disabilities

- D3.1 Application of Part
- D3.2 Access to buildings
- D3.3 Parts of buildings to be accessible
- D3.4 Concessions

Specifications

- D1.12 Non-required Stairways, Ramps and Escalators

Appendices

ACT

- D1.101 Notices on fire isolated stairs
- D2.101 Stairs serving small areas
- D2.102 Minimum size of doorways
- D2.103 Paving surfaces in public areas

NSW

- D3.101 Car parking

SA

- D1.101 Class 9b buildings: notice indicating number of persons

Vic

- D1.101 Exits from plant rooms and lift motor rooms

Tas

- Spec D2.21 Operation of latch

OBJECTIVE

A building must be so designed and constructed that the following objectives are fulfilled:

Part D1 Provision for Escape

There must be adequate means of escape in the case of fire or other emergency from all parts of the building to a place of safety.

Part D2 Construction of Exits

- (a) √ Stairways, ramps and passageways must be such as to provide safe passage for the users of the building.
- (b) √ Stairways, ramps, floors and balconies, and any roof to which people normally have access, must have bounding walls, balustrades or other barriers where necessary to protect users from the risk of falling.
- (c) √ Vehicle ramps and any floor to which vehicles have access must have kerbs or other barriers where necessary to provide protection to pedestrians and to the structure of the building.

Part D3 Access for People with Disabilities

Reasonable provision must be made in the design of a building, having regard to its use and location, to facilitate access and circulation by people with disabilities.

PART D1 PROVISION FOR ESCAPE

D1.1 Application

ACT D1.1

This Part does not apply to-

- (a) √ Class 1 or 10 buildings; or
- (b) √ the internal parts of a *sole-occupancy unit* in a Class 2 or 3 building.

D1.2 Number of exits required

- (a) √ **All buildings** - Every building must have at least one *exit* from each *storey*.
- (b) √ **Class 2 to 8 buildings** - In addition to any *horizontal exit*, not less than 2 *exits* must be provided from the following:
 - (i) √ Each *storey* if the building has a *rise in storeys* of more than 6 or an *effective height* of more than 25 m.
 - (ii) √ A Class 2 or 3 building subject to C1.5.
- (c) √ **Basements** - In addition to any *horizontal exit*, not less than 2 *exits* must be provided from any *storey* if egress from that *storey* involves a vertical rise within the building of more than 1.5 m, unless-
 - (i) √ the area of the *storey* is not more than 50 m²; and
 - (ii) √ the distance of travel from any point on the floor to a single *exit* is not more than 20 m.

- (d) **Class 9 buildings** - In addition to any *horizontal exit*, not less than 2 *exits* must be provided from the following:
- (i) *Each storey* if the building has a *rise in storeys* of more than 6 or an *effective height* of more than 25 m.
 - (ii) *Any storey* which includes a *patient care area* in a Class 9a building.
 - (iii) *Each storey* in a Class 9b building used as an *early childhood centre*.
 - (iv) *Each storey* in a primary or secondary *school* with a rise of 2 or more *storeys*.
 - (v) *Any storey or mezzanine* that accommodates more than 50 persons, calculated under D1.13.
- (e) **Exits from divided patient care areas:** In a Class 9a building, at least one *exit* must be provided from every part of a *storey* which has been divided in accordance with C2.5.
- (f) **Exits in open spectator stands:** In an *open spectator stand* containing more than one tier of seating, every tier must have not less than 2 stairways or ramps, each forming part of the path of travel to not less than 2 *exits*.

VIC D1.2(g)

D1.3 When fire-isolated exits are required

- (a) **Class 2 and 3 buildings:** Every *required exit* must be fire-isolated unless it connects not more than-
- (i) 3 consecutive *storeys* in a Class 2 building; or
 - (ii) 2 consecutive *storeys* in a Class 3 building,
- and one extra *storey* may be included if it is only for the accommodation of motor vehicles or for other ancillary purposes.
- (b) **Class 5 to 9 buildings:** Every *required exit* must be fire-isolated unless-
- (i) in a Class 9a building - it does not connect more than 2 consecutive *storeys* and does not connect *fire compartments* in *patient care areas*; or
 - (ii) it is part of an *open spectator stand*; or
 - (iii) in any other case, it does not connect more than 2 consecutive *storeys* or 3 consecutive *storeys* if the building has a *sprinkler system* installed throughout.

ACT D1.3(c)

WA D1.3(c)

D1.4 Exit travel distances

- (a) **Class 2 and 3 buildings:**
- (i) The entrance doorway of any *sole-occupancy unit* must be not more than 6 m from an *exit* or from a point from which travel in different directions to 2 *exits* is available; and
 - (ii) no point on the floor of a room which is not in a *sole-occupancy unit* must be more than 20 m from an *exit* or from a point at which travel in different directions to 2 *exits* is available.

SUPERCEDED

NSW D1.4(a)(iii)

- (b) ý **Class 4 parts:** The entrance doorway to any Class 4 part must be not more than 6 m from an *exit* or a point from which travel in different directions to 2 *exits* is available.
- (c) ý **Class 5 to 9 buildings:** Subject to (d), (e) and (f)-
 - (i) ý no point on a floor must be more than 20 m from an *exit*, or a point from which travel in different directions to 2 *exits* is available, in which case the maximum distance to one of those *exits* must not exceed 40 m; and
- WA D1.4(c)(ii)
- (ii) ý in a Class 5 or 6 building, the distance to a single *exit* serving a *storey* at the level of access to a road or *open space* may be increased to 30 m.
- (d) ý **Class 9a buildings:** In a *patient care area* in a Class 9a building-
 - (i) ý no point on the floor must be more than 12 m from a point from which travel in different directions to 2 of the *required exits* is available; and
 - (ii) ý the maximum distance to one of those *exits* must not be more than 30 m from the starting point.
- (e) ý **Open spectator stands:** The distance of travel to an *exit* in a Class 9b building used as an *open spectator stand* must be not more than 60 m.
- (f) ý **Assembly buildings:** In a Class 9b building other than a *school* or *early childhood centre*, the distance to one of the *exits* may be 60 m if-
 - (i) ý the path of travel from the room concerned to that *exit* is through another area which is a corridor, hallway, lobby, ramp or other circulation space; and
 - (ii) ý the room is smoke-separated from the circulation space by construction having an FRL of not less than 60/60/60 with every doorway in that construction protected by a tight fitting self-closing solid-core door not less than 35 mm thick; and
 - (iii) ý the maximum distance of travel does not exceed 40 m within the room and 20 m from the doorway to the room through the circulation space to the *exit*.

D1.5 Distance between alternative exits

NSW D1.5

Exits that are *required* as alternative means of egress must be distributed as uniformly as practicable within or around the *storey* served such that the exits or entrance to the *exits* are;

- (a) ý not less than 9 m apart; and
- (b) ý not more than-
 - (i) ý 45 m apart in a Class 2 or 3 building or a *storey* containing a *patient care area* in a Class 9a building ; or
 - (ii) ý 60 m apart in all other cases.

D1.6 Dimensions of exits

In a *required exit* or path of travel to an *exit*-

- (a) ý the unobstructed height throughout must be not less than 2 m; and

SUPERCEDED

SUPERCEDED

QLD D1.6(b)

- (b) ý if the *storey* or *mezzanine* accommodates not more than 100 persons, the unobstructed width except for doorways must be not less than-
- (i) ý 1 m; or
 - (ii) SA D1.6(b)(ii)
- (c) ý if the *storey* or *mezzanine* accommodates more than 100 persons but not more than 200 persons, the aggregate width, except for doorways, must be as *required* by (b) plus 250 mm for each 25 persons (or part) in excess of 100; and
- (d) ý if the *storey* or *mezzanine* accommodates more than 200 persons, the aggregate width, except for doorways, must be increased to-
- (i) ý 2 m plus 500 mm for every 60 persons (or part) in excess of 200 persons if egress involves a change in floor level by a stairway or ramp with a gradient steeper than 1 in 12; or
 - (ii) ý in any other case, 2 m plus 500 mm for every 75 persons (or part) in excess of 200; and
- (e) ý in an *open spectator stand* which accommodates more than 2000 persons the aggregate width except for doorways must be increased to 17 m plus a width (in metres) equal to the number in excess of 2000 divided by 600; and
- SA D1.6(f)
- (f) ý a doorway must be not less than-
- (i) ý in *patient care areas* - 1.6 m wide or 1.25 m if it is a *horizontal exit*; or
 - (ii) ý in areas used by students in a *school* - 870 mm wide; or
 - (iii) ý the width of *exit required* by (b), (c), (d) or (e), minus 250 mm, or
 - (iv) NSW D1.6(f)(iv)
 - (iv) ý in any other case except where it opens to a *sanitary compartment* or bathroom - 750 mm wide; and
- (g) ý the width of a *required exit* must not diminish in the direction of travel to a road or *open space*.

D1.7 Travel via fire-isolated exits

- (a) ý A doorway from a room must not open directly into a stairway, passageway or ramp that is *required* to be fire-isolated unless it is from-
- (i) ý a public lobby, corridor, hallway, or the like; or
 - (ii) ý a *sole-occupancy unit* occupying all of a *storey*; or
 - (iii) ý a *sanitary compartment*, airlock or the like.
- (b) ý Each *fire-isolated stairway* or *fire-isolated ramp* must provide independent egress from each *storey* served and discharge-
- (i) ý directly, or by way of its own *fire-isolated passageway*, to a road or *open space*; or
 - (ii) ý into a *storey* or space within the confines of the building that is enclosed for no more than 1/3 of its perimeter and used only for pedestrian movement, car parking, or the like, to a point where an unimpeded path of travel not further than 20 m is available to a road or *open space*.

SUPERCEDED

NSW D1.7(b)(iii)

- (c) ý If more than 2 access doorways, not from a *sanitary compartment* or the like, open to a *required fire-isolated exit* in the same *storey*-
 - (i) ý a smoke lobby in accordance with D2.6 must be provided; or
 - (ii) ý the *exit* must be pressurised in accordance with E2.7.
- (d) ý A ramp must be provided at any change in level less than 600 mm in a *fire-isolated passageway* in a Class 9 building.

D1.8 External stairways

An external stairway may serve as a *required exit* instead of a *fire-isolated stairway* in a building with an *effective height* of not more than 25 m if the stairway (including any connecting access bridges) is of *non-combustible* construction throughout, and-

- (a) ý if any part of the stairway is exposed to, and less than 6 m from, a *window*, doorway or the like in an *external wall* of the building served by the stairway-
 - (i) ý the stairway must be enclosed for its full height above the lowest level of the *window* or doorway by *non-combustible* construction with an FRL of not less than 60/60/60; and
 - (ii) ý no *window* or the like in the enclosing walls of the stairway must be within 6 m if it is unprotected, or 3 m if it is protected in accordance with C3.4, of any *window*, doorway or the like in the *external walls* of the building; or
- (b) ý if any part of the stairway is exposed to, and less than 6 m but more than 3 m from, a *window*, doorway or the like in an *external wall* of the building, the *window*, doorway or the like must be protected in accordance with C3.4.

D1.9 Travel by non-fire-isolated stairways or ramps

- (a) ý A *non-fire-isolated stairway* or *ramp* serving as a *required exit* must provide a continuous means of travel by its own flights of stairs and landings from every *storey* served to the level at which egress to a road or *open space* is provided.
- (b) ý In a Class 2, 3 or 4 building, the distance between the doorway of a room or *sole-occupancy unit* and the point of egress to a road or *open space* by way of any *required* stairway or ramp that is not fire-isolated must not exceed-
 - (i) ý 30 m in a building of Type C construction; or
 - (ii) ý 60 m in all other cases.
- (c) ý In a Class 5 to 9 building, the distance from any point on a floor to a point of egress to a road or *open space* by way of a *required non-fire-isolated stairway* or ramp must not exceed 80 m.
- (d) ý In a Class 2, 3 or 9a building, a *required non-fire-isolated stairway* or ramp must discharge at a point not more than-
 - (i) ý 15 m from a doorway providing egress to a road or *open space* or from a *fire-isolated passageway* leading to a road or *open space*; or
 - (ii) ý 30 m from one of 2 such doorways or passageways if travel to each of them from the stairway or ramp is in opposite or approximately opposite directions.
- (e) ý In a Class 5 to 8 or 9b building, a *required non-fire-isolated stairway* or ramp must discharge at a point not more than-

SUPERCEDED

- (i) √ 20 m from a doorway providing egress to a road or *open space* or from a *fire-isolated passageway* leading to a road or *open space*; or
 - (ii) √ 40 m from one of 2 such doorways or passageways if travel to each of them from the stairway or ramp is in opposite or approximately opposite directions.
- (f) √ If 2 or more *exits* are *required* and are provided by means of internal non-*fire-isolated stairways* or non-*fire-isolated ramps*, each *exit* must-
- (i) √ provide separate egress to a road or *open space*; and
 - (ii) √ be suitably smoke-separated from each other at the level of discharge.

D1.10 Discharge from exits

- (a) √ An *exit* must not be blocked at the point of discharge and where necessary, suitable barriers must be provided to prevent vehicles from blocking the *exit*, or access to it.
- (b) √ If a *required exit* leads to an *open space*, the path of travel to the road must have an unobstructed width throughout of not less than-
- (i) √ the minimum width of the *required exit*; or
 - (ii) √ 1 m, √
- whichever is the greater. √
- (c) √ If an *exit* discharges to *open space* that is at a different level than the public road to which it is connected, the path of travel to the road must be by-
- (i) √ a ramp or other incline having a gradient not steeper than 1:8 at any part, or not steeper than 1:14 if *required* by Part D3; or
 - (ii) √ except if the *exit* is from a Class 9a building, a stairway complying with the BCA.
- (d) √ The discharge point of alternative *exits* must be located as far apart as practical.
- (e) √ In a Class 9b building which is an *open spectator stand* that accommodates more than 500 persons, a *required* stairway or *required* ramp must not discharge to the ground in front of the stand.
- (f) √ In a Class 9b building containing an auditorium which accommodates more than 500 persons, not more than 2/3 of the *required* width of *exits* must be located in the main entrance foyer.

D1.11 Horizontal exits

Horizontal exits must-

- (a) √ not be counted as *required exits*-
- (i) √ between *sole-occupancy units*; or
 - (ii) √ in a Class 9b building used as an *early childhood centre*, primary or secondary *school*; and
- (b) √ not comprise more than 50% of the number of *required exits* from any part of a *storey* which has been divided by a *fire wall*; and
- (c) √ have a clear area on each side of the *fire wall* to accommodate the total number of persons (calculated under D1.13) from both parts of the *storey*, of not less than-

SUPERCEDED

SUPERCEDED

- (i) 2.5 m² per patient in a Class 9a building; and
- (ii) 0.5 m² per person in any other case.

D1.12 Non-required stairways, ramps or escalators

An escalator, moving walkway or non-*required non-fire-isolated stairway* or pedestrian ramp-

- (a) \dot{y} must not be used in a *patient care area* in a Class 9a building; and
- (b) \dot{y} may connect any number of *storeys* if it is-
 - (i) \dot{y} in an *open spectator stand* or indoor sports stadium; or
 - (ii) \dot{y} in a carpark or an *atrium*; or
 - (iii) \dot{y} outside a building; or
 - VIC D1.12(b)(iv)
 - (iv) \dot{y} in a Class 5 or 6 building that is sprinklered throughout, where the escalator, walkway, stairway or ramp complies with Specification D1.12; and
- (c) \dot{y} except where permitted in (b) must not connect more than-
 - (i) \dot{y} 3 *storeys* if each of those *storeys* is provided with a *sprinkler system* throughout; or
 - (ii) 2 *storeys*, \dot{y} provided that in each case, those *storeys* must be consecutive, and one of \dot{y} those *storeys* is situated at a level at which there is direct egress to a road or \dot{y} *open space*; and \dot{y}
- (d) \dot{y} except where permitted in (b) or (c), must not connect, directly or indirectly, more than 2 *storeys* at any level in Class 5, 6, 7, 8 or 9 building and those *storeys* must be consecutive.

D1.13 Number of persons accommodated

The number of persons accommodated in a *storey*, room or *mezzanine* must be determined with consideration to the purpose for which it is used and the layout of the floor area by-

- (a) \dot{y} calculating the sum of the numbers obtained by dividing the floor area of each part of the *storey* by the number of square metres per person listed in Table D1.13 according to the use of that part, excluding spaces set aside for-
 - (i) \dot{y} lifts, stairs, ramps and escalators, corridors, hallways, lobbies and the like; and
 - (ii) \dot{y} service ducts and the like, *sanitary compartments* or other ancillary uses; or
- (b) \dot{y} reference to the seating capacity in an *assembly building* or room; or
- (c) \dot{y} any other suitable means of assessing its capacity.

NSW Table D1.13

NT Table D1.13

TAS Table D1.13

Table D1.13 AREA PER PERSON ACCORDING TO USE

TYPE OF USE \dot{y}	m ² per person
-----------------------	---------------------------

SUPERCEDED

Art gallery, exhibition area, museum	4	
Bar, cafe, church, dining room	1	
Board room	2	
Boarding House	15	
Computer room	25	
Court room -judicial area	10	
-public seating	1	
Dance floor	0.5	
Dormitory -for children	5	
-for adults	10	
Early childhood centre	4	
Factory - (a) machine shop, fitting shop or like place for cutting, for cutting, grading, finishing or fitting of metals or glass, except in the fabrication of structural steelwork or manufacture of vehicles or bulky products	5	
(b) areas used for fabrication and processing other than those in (a)	50	
(c) a space in which the layout and natural use of fixed plant or equipment determine the number of persons who will occupy the space during working hours		Area per person determined by the use of the or equipment
Garage - public	30	
Gymnasium	3	
Hostel, hotel, motel, guest house	15	
Indoor sports stadium - arena	10	
Kiosk	1	
Kitchen, laboratory, laundry	10	
Library -reading space	2	
-storage space	30	
Office, including one for typewriting or document copying	10	
Patient care areas	10	
Plant Room for -ventilation, electrical or other service units	30	
-boilers or power plant	50	
Reading Room	2	
Restaurant	1	
School - general classroom	2	
- multi-purpose hall	1	
- staff room	10	
- trade and practical area -primary	4	
-secondary		As for workshop
Shop - space for sale of goods-		
(a) at a level entered direct from the open air or any lower level	3	
(b) all other levels	5	
Showroom - display area, covered mall or arcade	5	
Skating rink, based on rink area	1.5	
Spectator stand, audience viewing area:		
-standing viewing area	0.3	
-removable seating	1	

SUPERCEDED

SUPERCEDED

-fixed seating (number of seats)	
-bench seating (450 mm/person)	
Storage space	30
Swimming pool, based on pool area	1.5
Switch room, transformer room	30
Telephone exchange - private	30
Theatre and public halls	1.2
Theatre dressing room	4
Transport terminal	2
Workshop - for maintenance staff	30
- or manufacturing processes	As for Factory

D1.14 Measurement of distances

The nearest part of an *exit* means in the case of-

- (a) \hat{y} a *fire-isolated stairway, fire-isolated passageway, or fire-isolated ramp*, the nearest part of the doorway providing access to them;
- (b) \hat{y} a *non-fire-isolated stairway*, the nearest part of the nearest riser;
- (c) \hat{y} a *non-fire-isolated ramp*, the nearest part of the junction of the floor of the ramp and the floor of the *storey*;
- (d) \hat{y} a doorway opening to a road or *open space*, the nearest part of that doorway;
- (e) \hat{y} a *horizontal exit*, the nearest part of the doorway.

D1.15 Method of measurement

The following rules apply:

- (a) \hat{y} In the case of a room that is not a *sole-occupancy unit* in a Class 2 or Class 3 building or a Class 4 part, the distance includes the straight-line measurement from any point on the floor of the room to the nearest part of a doorway leading from it, together with the distance from that part of the doorway to the single *required exit* or point from which travel in different directions to 2 *required exits* is available.
- (b) \hat{y} Subject to (d), the distance from the doorway of a *sole-occupancy unit* in a Class 2 or Class 3 building or a Class 4 part is measured in a straight line to the nearest part of the *required single exit* or point from which travel in different directions to 2 *required exits* is available.
- (c) \hat{y} Subject to (d), the distance between *exits* is measured in a straight line between the nearest parts of those *exits*.
- (d) \hat{y} Only the shortest distance is taken along a corridor, hallway, external balcony or other path of travel that curves or changes direction.
- (e) \hat{y} If more than one corridor, hallway, or other internal path of travel connects *required exits*, the measurement is along the path of travel through the point at which travel in different directions to those *exits* is available.
- (f) \hat{y} If a wall (including a demountable *internal wall*) that does not bound-
 - (i) \hat{y} a room; or
 - (ii) \hat{y} a corridor, hallway or the like,causes a change of direction in proceeding to a *required exit*, the distance is measured along the path of travel past that wall.

SUPERCEDED

- (g) If permanent fixed seating is provided, the distance is measured along the path of travel between the rows of seats.

NSW D1.15(h)

VIC D1.15(h)

ACT D1.101

SA D1.101

VIC D1.101

PART D2 CONSTRUCTION EXITS

D2.1 Application of Part

ACT D2.1

WA D2.1

Except for D2.13 and D2.16, this Part does not apply to-

- (i) a Class 1 or Class 10 building; or
- (ii) the internal parts of a *sole-occupancy unit* in a Class 2 or Class 3 building or a Class 4 part.

D2.2 Fire-isolated stairways and ramps

A stairway or ramp (including any landings) that is *required* to be within a *fire-resisting shaft* must be constructed-

- (a) \hat{y} of *non-combustible* materials; and
- (b) \hat{y} so that if there is local failure, it will not cause structural damage to, or impair the fire-resistance of, the *shaft*.

D2.3 Non-fire-isolated stairways and ramps

In a building having a rise of more than 2 *storeys*, *required* stairs and ramps (including landings and any supporting structural members) which are not *required* to be within a *fire-resisting shaft*, must be constructed according to D2.2, or only of-

- (a) \hat{y} reinforced or prestressed concrete; or
- (b) \hat{y} steel in no part less than 6 mm thick; or
- (c) \hat{y} timber that-
 - (i) \hat{y} has a finished thickness of not less than 44 mm; and
 - (ii) \hat{y} has an average density of not less than 800 kg/m³ at a moisture content of 12%; and
 - (iii) \hat{y} has not been joined by means of glue unless it has been laminated and glued with resorcinol formaldehyde or resorcinol phenol formaldehyde glue.

D2.4 Separation of rising and descending stair flights

If a stairway serving as an *exit* is *required* to be fire-isolated-

- (a) \hat{y} there must be no direct connection between-
 - (i) \hat{y} a flight of stairs rising from a *storey* below the lowest level of access to a road or *open space*; and
 - (ii) \hat{y} a flight of stairs descending from a *storey* above that level; and

- (b) ŷ any construction that separates or is common to the rising and descending flights of stairs must be *non-combustible* and have an FRL of not less than 60/60/60.

D2.5 Open access ramps and balconies

Where an open access ramp or balcony forms part of a *required exit*, it must-

- (a) ŷ have ventilation openings to the outside air which-
- (i) ŷ have a total unobstructed area not less than the floor area of the ramp or balcony; and
 - (ii) ŷ are evenly distributed along the open sides of the ramp or balcony; and
- (b) ŷ not be enclosed on its open sides above a height of 1 m except by an open grille or the like having a free air space of not less than 75% of its area.

D2.6 Smoke lobbies

A smoke lobby *required* by D1.7 must-

- (a) ŷ have a floor area not less than 6 m²; and
- (b) ŷ be separated from the occupied areas in the *storey* by walls which are impervious to smoke, and-
- (i) ŷ have an FRL of not less than 60/60/- (which may be fire-protective grade plasterboard, gypsum block with set plaster, face brickwork, glass blocks or glazing); and
 - (ii) ŷ extend from slab to slab, or to the underside of a ceiling with a *resistance to the incipient spread of fire* of 60 minutes which covers the lobby; and
 - (iii) ŷ construction joints between the top of the walls and the floor slab, roof or ceiling must be smoke sealed with intumescent putty or other suitable material; and
- (c) ŷ at any opening from the occupied areas, have smoke doors complying with Clause 3 of Specification C3.4 except that the smoke sensing device need only be located on the approach side of the opening; and
- (d) ŷ be pressurised as part of the *exit* if the *exit* is *required* to be pressurised under E2.2.

D2.7 Installations in exits and paths of travel

- (a) ŷ Access to service *shafts* and services other than to fire-fighting or detection equipment as permitted in Section E, must not be provided from a *fire-isolated stairway, passageway or ramp*.
- (b) ŷ An opening to any chute or duct conveying hot products of combustion must not be located in any part of a *required exit* or any corridor, hallway, lobby or the like leading to a *required exit*.
- (c) ŷ Gas or other fuel services must not be installed in a *required exit*.
- NSW D2.7(d)
- WA D2.7(d)
- (d) ŷ Services or equipment must not be installed in a *required exit* or in any corridor, hallway, lobby or the like leading to a *required exit* if it comprises-
- (i) ŷ electricity meters, distribution boards or ducts; or
 - (ii) ŷ central telecommunications distribution boards or equipment; or

(iii) ∫ electrical motors or other motors serving equipment in the building, unless it is enclosed by *non-combustible* construction or a fire-protective covering.

D2.8 Enclosure of space under stairs and ramps

- (a) ∫ **Fire-isolated stairways and ramps** - If the space below a *required fire-isolated stairway* or ramp is within the fire-isolated *shaft*, it must not be enclosed to form a cupboard or similar enclosed space.
- (b) ∫ **Non-fire-isolated stairways and ramps** - The space below a *required non-fire-isolated stairway* (including an external stairway) or *ramp* must not be enclosed to form a cupboard or other enclosed space unless-
- (i) ∫ the enclosing walls and ceilings have an FRL of not less than 60/60/60; and
- (ii) ∫ any access doorway to the enclosed space is fitted with a self-closing 60/60/30 fire door.

D2.9 Width of stairways

- (a) ∫ The *required* width of a stairway must-
- (i) ∫ be measured clear of all obstructions such as handrails, projecting parts of balustrades, and the like; and
- (ii) ∫ extend without interruption, except for ceiling cornices, to a height not less than 2 m vertically above a line along the nosings of the treads or the floor of the landing.
- (b) ∫ A *required* stairway that exceeds 2 m in width is counted as having a width of only 2 m unless it is divided by a balustrade or handrail continuous between landings and each division is less than 2 m wide.

ACT D2.9(c)

D2.10 Pedestrian ramps

- (a) ∫ A *fire-isolated ramp* may be substituted for a *fire-isolated stairway* if the construction enclosing the ramp and the width and ceiling height comply with the requirements for a *fire-isolated stairway*.
- (b) ∫ A ramp serving as a *required exit* must have a gradient not steeper than-
- (i) ∫ 1:12 in *patient care areas* in a Class 9a building; or
- (ii) ∫ that *required* by Part D3 if applicable; or
- (iii) ∫ 1:8 in any other case.
- (c) ∫ The floor surface of a ramp must have a non-slip finish.

D2.11 Fire-isolated passageways

A *fire-isolated passageway* must be enclosed by walls, floors, and ceilings of *non-combustible* construction with an FRL of-

- (a) ∫ if the passageway discharges from a *fire-isolated stairway* or *ramp* - not less than that *required* for the stairway or ramp *shaft*; or
- (b) ∫ in any other case - not less than 60/60/60.

D2.12 Roof as open space

If an *exit* discharges to a roof of a building, the roof must-

- (a) \dot{y} have an FRL of not less than 120/120/120; and
- (b) \dot{y} not have any rooflights or other openings within 3 m of the path of travel of persons using the *exit* to reach a road or *open space*.

D2.13 Treads and risers

- (a) \dot{y} A stairway must be suitable to provide safe passage in relation to the nature, volume and frequency of likely usage.
- (b) \dot{y} A stairway in any building (including a Class 1 or 10 building and a *sole-occupancy unit* in a Class 2 or 3 building or Class 4 part) satisfies (a) if it has-
 - (i) \dot{y} not more than 18 or less than 2 risers in each flight, except in a Class 9a building subject to D1.7(d); and
 - (ii) \dot{y} going (G), riser (R) and quantity (2R + G) in accordance with Table D2.13;
 - (iii) \dot{y} goings and risers that are constant throughout; and
 - (iv) \dot{y} risers which do not have any openings that would allow a 125 mm sphere to pass through between the treads; and
 - ACT D2.13(b)(v)
 - (v) \dot{y} treads which have a non-slip finish or a suitable non-skid strip near the edge of the nosings; and
 - (vi) \dot{y} treads of solid construction (not mesh or other perforated material) if the stairway is more than 10 m high or connects more than 3 *storeys*; and
 - (vii) \dot{y} in a Class 9 building - not more than 36 successive risers without a change in direction of at least 30°; and
 - (viii) in a curved stairway that is part of a *required exit* - an internal radius of not less than twice the width of the stair and does not incorporate stepped quarter landings; and
 - (ix) \dot{y} notwithstanding (b)(iii) a stairway in a Class 1 or 10 building or in a *sole-occupancy unit* of a Class 2 or 3 building or a Class 4 part may contain a combination of uniform and tapered treads.

NSW Table D2.13

VIC Table D2.13

Table D2.13 RISER AND GOING DIMENSIONS (mm)

	RISER (R)		GOING (G) ^(b)		QUANTITY (2R+G)	
	Max	Min	Max	Min	Max	Min
Public stairs	180	115	355	280	700	550
Private stairs ^(a)	190	115	355	240	700	550

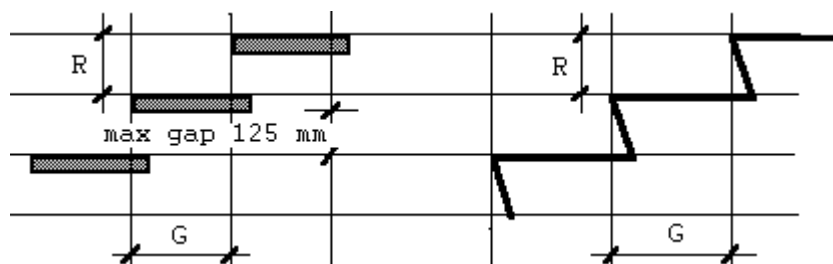

Note: (a) Private stairs are-

SUPERCEDED

- (i) stairs in a Class 1 or 10 building;
 - (ii) stairs in a *sole-occupancy unit* in a Class 2 building or Class 4 part; and
 - (iii) in any building, stairs which are not part of a *required exit* and to which the public do not normally have access.
- (b) The going in tapered treads (as in a curved or spiral stair) is measured-
- (i) 270 mm in from the outer side if the flight is less than 1 m wide;
 - (ii) 270 mm from each side if the flight is 1 m wide or more, and must not be less than 50 mm at the narrow end.
-

D2.14 Landings

In a stairway-

- (a) landings having a maximum gradient of 1:50 may be used in any building to limit the number of risers in each flight and each landing must-
- (i) be not less than 750 mm long measured 500 mm from the inside edge of the landing; and
 - (ii) have a non-slip finish throughout or a suitable non-skid strip near the edge of the landing where it leads to a flight of stairs below; and
- (b) in a Class 9a building-
- (i) the area of any landing must be sufficient to move a stretcher, 2 m long and 600 mm wide, at a gradient not more than the gradient of the stairs, with at least one end of the stretcher on the landing while changing direction between flights; or
 - (ii) the stair must have a change of direction of 180°, and the landing a clear width of not less than 1.6 m and a clear length of not less than 2.7 m.

D2.15 Thresholds

The threshold of a doorway must not incorporate a step or ramp at any point closer to the doorway than the width of the door leaf unless-

- (a) in *patient care areas* in a Class 9a building, the door sill is not more than 25 mm above the finished floor level to which the doorway opens; or
- (b) in other cases-
- (i) the doorway opens to a road, *open space* or external balcony; and
 - (ii) the door sill is not more than 190 mm above the finished surface of the ground, balcony, or the like, to which the doorway opens.

D2.16 Balustrades

ACT D2.16(a)

- (a) Except as provided in (h), a continuous balustrade must be provided along the side of any stairway or ramp, or any corridor, hallway, balcony, access bridge or the like, if-
- (i) it is not bounded by a wall; and
 - (ii) the change in level is more than 15 mm, or 5 risers in the case of a stairway, from the floor or ground surface beneath,
- except at the perimeter of a stage, rigging loft, loading dock, an area accessible only to maintenance staff, or the like.

SUPERCEDED

- (b) ý A *required* balustrade must prevent, as far as practicable-
 - (i) ý children climbing over or through it; and
 - (ii) ý persons accidentally falling from the floor; and
 - (iii) ý objects which might strike a person at a lower level accidentally falling from the floor surface.
- (c) ý In low risk areas such as *fire-isolated stairways*, *fire-isolated ramps* or external stairways that are provided instead of *fire-isolated stairways*, other areas used exclusively for emergency purposes and other stairways and ramps (including access bridges and landings) where the change in level is not more than 3ým, a balustrade satisfies (b) if-
 - (i) ý the balustrade has a height of not less than 865 mm above the nosings of the stair treads and the floor of the landing, access bridge or the like; and
 - (ii) ý the space between balusters or the width of any opening in the balustrade (including any openable *window* or panel) is not more than 300 mm except where the space between rails or the height of any opening is not more than 420 mm.
- (d) ý At balconies where the change in level is not more than 3 m, a balustrade satisfies (b) if-
 - (i) ý it has a height of not less than 1 m above the balcony floor; and
 - (ii) ý the space between balusters or the width of any opening in the balustrade is not more than 125 mm except where the space between rails or the height of the opening is not more than 125 mm.
- (e) ý In stairways and ramps (including access bridges and landings) where the change in level is more than 3 m, a balustrade satisfies (b) if-
 - (i) ý it has a height of not less than 865 mm above the nosings of the stair treads and the floor of the landing, balcony, corridor, hallway, access bridge or the like; and
 - (ii) ý the space between balusters or the width of any opening in the balustrade (including any openable *window* or panel) is not more than 125 mm except where the space between rails or the height of the opening is not more than 125 mm; and
 - (iii) ý all parts of the balustrade more than 150 mm and less than 760 mm from the floor or nosings are vertical or otherwise do not provide a toe-hold.
- (f) ý At balconies where the change in level is more than 3ým, a balustrade satisfies (b) ý if-
 - (i) ý it has a height of not less than 1 m above the balcony floor; and
 - (ii) ý the space between balusters or the width of any opening in the balustrade is not more than 125 mm except where the space between rails or the height of the opening is not more than 125 mm; and
 - (iii) ý all parts of the balustrade more than 150 mm and less than 760 mm from the floor or nosings are vertical or otherwise do not provide a toe-hold; and
 - (iv) ý it does not have any openings more than 100 mm wide within 150 mm of the floor level.
- (g) ý A balustrade or other barrier in front of fixed seating in a *mezzanine* or balcony in a Class 9b building satisfies (b) if it complies with (d), or-

SUPERCEDED

SUPERCEDED

- (i) √ it is not less than 700 mm in height above the floor of the *mezzanine* or balcony and a horizontal projection extends not less than 1 m outwards from the top of the balustrade; and
 - (ii) √ the space between balusters or the width of any opening in the balustrade is not more than 125 mm except where the space between rails or the height of the opening is not more than 125 mm.
- (h) √ In machinery rooms, boiler houses, lift-motor rooms, plant-rooms and the like, balustrades to fixed platforms, walkways, stairways and ladders that are intended to provide safe means of access and safe working at places normally used by operating, inspection, maintenance and service personnel, must comply with AS 1657.

WA D2.16(i)

D2.17 Handrails

- (a) √ Suitable handrails must be provided where necessary to assist and provide stability to persons using a ramp or stairway.
- (b) √ Except for handrails referred to in (d), handrails satisfy (a) if they are-
- (i) √ located along at least one side of the ramp or flight of stairs; and
 - (ii) √ located along each side if the total width of the stairway or ramp is 2 m or more; and
 - (iii) √ not more than 2 m apart in the case of intermediate handrails; and
 - (iv) √ in a Class 9b building used as a primary *school*, fixed at a height of not less than 865 mm with a second rail fixed at a height of not less than 700 mm; and
 - (v) √ in any other case, fixed at a height of not less than 865 mm above the nosings of stair treads and the floor surface of the ramp, landing, or the like; and
 - (vi) √ continuous between stair flight landings and have no obstruction on or above them that will tend to break a hand-hold.

SA D2.17(c)

- (c) √ Handrails in a Class 9a building must be provided along at least one side of every passageway or corridor used by patients, and must be-
- (i) √ fixed not less than 50 mm clear of the wall; and
 - (ii) √ where practicable, continuous for their full length.
- (d) √ In machinery rooms, boiler houses, lift-motor rooms, plant-rooms and the like, handrails to fixed platforms, walkways, stairways and ladders that are intended to provide safe means of access and safe working at places normally used by operating, inspection, maintenance and service personnel, satisfy (a) if they comply with AS 1657.

D2.18 Fixed platforms, walkways, stairways and ladders

QLD D2.18

In machinery rooms, boiler houses, lift-motor rooms, plant-rooms and the like, fixed platforms, walkways, stairways and ladders that are intended to provide safe means of access, egress and safe working at places normally used by operating, inspection, maintenance and service personnel, must comply with AS 1657.

SUPERCEDED

D2.19 Doorways and doors

A doorway serving as a *required exit*, forming part of a *required exit*, or in *patient care areas* of a Class 9a building-

- (a) \dot{y} must not be fitted with a revolving door; and
- (b) \dot{y} must not be fitted with a roller shutter or tilt-up door unless-
 - (i) \dot{y} it serves a Class 6, 7 or 8 building or part with a floor area not more than 200 m²; and
 - (ii) \dot{y} the doorway is the only *required exit* from the building or part; and
 - (iii) \dot{y} it is held in the open position while the building or part is lawfully occupied; and
- WA D2.19(c)
- (c) \dot{y} must not be fitted with a sliding door unless-
 - (i) \dot{y} it leads directly to a road or *open space*; and
 - (ii) \dot{y} the door may be opened manually under a force of not more than 110 N; and
- (d) \dot{y} if fitted with a door which is power-operated-
 - (i) it must be able to be opened by hand under a force of not more than 110 N if there is a malfunction or failure of the power source; or
 - NSW D2.19(d)(ii)
 - (ii) it must open *automatically* if there is a power failure or on the activation of a fire or smoke alarm anywhere in the part served by the door.

D2.20 Swinging doors

A swinging door in a *required exit* or forming part of a *required exit*-

- (a) \dot{y} must not encroach-
 - (i) \dot{y} at any part of its swing by more than 500 mm on the *required* width of a *required* stairway, passageway or ramp, including the landings; and
 - (ii) \dot{y} when fully open, by more than 100 mm on the *required* width of the *required exit*, and

the measurement of encroachment in each case is to include door handles or other furniture or attachments to the door;
- (b) \dot{y} must swing in the direction of egress unless-
 - (i) \dot{y} it serves a building or part with a floor area not more than 200 m², it is the only *required exit* from the building or part and it is fitted with a device for holding it in the open position; or
 - (ii) \dot{y} it serves a *sanitary compartment* or airlock (in which case it may swing in either direction); and
- (c) \dot{y} must not otherwise impede the path or direction of egress.

D2.21 Operation of latch ý

NT D2.21

QLD D2.21

TAS D2.21

VIC D2.21

A door in a *required exit*, forming part of a *required exit* or in the path of travel to a *required exit* must be readily openable without a key from the side that faces a person seeking egress, by a single hand action on a single device which is located between 900 mm and 1.2 m from the floor, unless-

- (a) ý it serves a vault, strong-room, or the like; or
- (b) ý it serves only, or is within-
 - (i) ý a *sole-occupancy unit* in a Class 2 or 3 building or a Class 4 part; or
 - (ii) ý a *sole-occupancy unit* with a floor area not more than 200 m² in a Class 5, 6, 7 or 8 building; or
 - (iii) ý a space which is otherwise inaccessible to persons at all times when the door is locked; or
- (c) ý it serves a bank or other occupancy where special arrangements for security are necessary and it can be immediately unlocked-
 - (i) ý by operating a fail-safe control switch, not contained within a protective enclosure, to actuate a device to unlock the door; or
 - (ii) ý by hand by a person or persons, specifically nominated by the owner, properly instructed as to the duties and responsibilities involved and available at all times when the building is lawfully occupied so that persons in the building or part may immediately escape if there is a fire or other emergency; or
- (d) ý it is fitted with a fail-safe device which *automatically* unlocks the door upon the activation of any *sprinkler system* or smoke or thermal detector system installed throughout the building;

ACT D2.21(e),(f)

SA D2.21(e)

D2.22 Re-entry from fire-isolated exits

Doors must not be locked from inside a *fire-isolated stairway*, *fire-isolated ramp* or *fire-isolated passageway* enclosure to prevent re-entry to the *storey* or room it serves in-

- (a) ý a Class 9a building; or
- (b) ý a building more than 25 m in *effective height* unless all the doors are *automatically* unlocked by a fail-safe device upon the activation of a fire alarm, and-
 - (i) ý at least at every fourth *storey* the doors are not able to be locked and a sign is fixed on it stating that re-entry is available; or
 - (ii) ý an intercommunication system, or an audible or visual alarm system, operated from within the enclosure is provided near the doors and a sign is fixed adjacent to it explaining its purpose and method of operation.

ACT D2.101 to D2.103

PART D3 ACCESS FOR PEOPLE WITH DISABILITIES ý

SA PART D3

D3.1 Application of Part ý

NSW D3.1

This Part applies to all Class 3, 5, 6, 7, 8 and 9 buildings.

D3.2 Access to buildings

WA D3.2

Access for people with disabilities must be provided to buildings as set out in Table D3.2 by means of a continuous path of travel in accordance with AS 1428.1-

- (a) ý from a road boundary of the allotment;
- (b) ý from any carpark space on the allotment (whether within or outside the building)-
 - (i) ý that is set aside for people with disabilities using the building; or
 - (ii) ý if there are no carpark spaces set aside for them, from any carpark area that serves the building; and
- (c) ý from any other building on the allotment to which access for people with disabilities is *required*.

ACT D3.2(d)

NSW Table D3.2

Table D3.2 REQUIREMENTS FOR ACCESS FOR PEOPLE WITH DISABILITIES

CLASS OF BUILDING ý	ACCESS REQUIREMENTS
Class 3	
(a) Common areas of buildings that are required to be accessible	the entrance floor and to all public areas on every floor
(b) If the building contains-	To and within-
more than 10 units up to 49 units	one sole-occupancy unit
more than 49 but not more than 99	2 sole-occupancy units
more than 99 units	3 sole-occupancy units
(c) If accommodation is provided for more than 10 persons other than in <i>sole-occupancy</i> units-	
up to 49 beds	2 beds
more than 49 but not more than 99	4 beds
more than 99	6 beds
[Note: For the purposes of this Table, a double bed counts as 1 bed]	
Class 5 and 6 ý	To and within the entrance floor if its <i>floor area</i> is more than 500 m ²
Class 7 ý	To and within the entrance floor if the total <i>floor area</i> of the building is more than 3000 m ² .

SUPERCEDED

Class 8 ý	To and within the entrance floor if the total <i>floor area</i> of the building, excluding any part used as a laboratory, is more than 1000 m ² .
And Class 5, 6, 7 and 8 ý	To and within any floor if irrespective of <i>floor area</i> , the floor is not more than 190 mm at the point of entrance above or below the adjacent finished ground level; and within any other floor to which vertical access by way of a ramp, step ramp or kerb ramp complying with AS 1428.1 or a passenger lift is provided
Class 9a ý	To and within all areas normally accessible to the public, patients or staff.
Class 9b- An assembly building not being a school or an early childhood centre ý	To and within every room that accommodates more than 100 persons, and if fixed seating is provided, not less than 1 wheelchair space for each 200 seats, or part, with a minimum of 2 spaces; and within any other floor to which vertical access by way of a ramp, step ramp or kerb ramp complying with AS 1428.1, or passenger lift is provided.
A school ý	To every room if no alternative similar facilities to those provided in that room are accessible elsewhere in the school.
An early childhood centre ý	To and within every room used by children.

[Note: The calculation of *floor area* and the number of persons accommodated is in accordance with D1.13.]

D3.3 Parts of buildings to be accessible

- (a) ý Access for people with disabilities must be provided-
- (i) ý from the doorway at the entrance floor providing access to any *sanitary compartment required* for the use of people with disabilities; and
 - (ii) ý to areas normally used by the occupants, excluding any plantroom, commercial kitchen, cleaners' store room, maintenance accessway, rigging loft, or the like.
- (b) ý A path of travel providing *required* access must not include a stairway, turnstile, revolving door, escalator or other impediment which would prevent a person in a wheelchair using it.
- (c) ý Access, finishes and fittings, including passageways, ramps, step ramps or kerb ramps, passenger lifts, signs, doorways and other parts of the building *required* by this Part must comply at least with the provisions of AS 1428.1, excluding any references within that Standard to AS 1735.12.

WA D3.3(d)

D3.4 Concessions

It is not necessary to provide access for people with disabilities to-

- (a) ý more than 30% of the public space in a restaurant, cafe, bar, function room, or the like, in a Class 6 or Class 9b building; or
- (b) ý a *mezzanine*; or

SUPERCEDED

[WA D3.4(c)]

(c) a space not regarded as a *storey* by definition; or

[NSW D3.4(d)]

(d) more than 1 car parking space for each 100 spaces in a *public carpark*; or

(e) any area if access would be inappropriate because of the particular purpose for which the area is used.

[NSW D3.10]

SPECIFICATION D1.12 *ý* NON-REQUIRED STAIRWAYS, RAMPS AND ESCALATORS

1. *ý* Scope

This Specification contains the requirements to allow *non-required* stairways, ramps or escalators to connect any number of *storeys* in a Class 5 or 6 building. The requirements do not apply in an *atrium* or outside a building.

2. *ý* Requirements

An escalator, moving walkway or *non-required non-fire-isolated stairway* or pedestrian ramp will comply with the requirement of Clause D1.12(b)(iv) if it is constructed as follows:

- (a) *ý* the escalator, walkway, stairway or ramp is bounded by a *shaft* of:
 - (i) *ý* construction with an FRL of not less than 120/120/120. *Lightweight construction* must comply with Specification C1.8; or
 - (ii) *ý* glazed construction with an FRL of not less than 60/60/30 and protected by a wall wetting system in accordance with Clause 2.4 of Specification G3.8.
- (b) *ý* the *shaft* must directly connect only 2 *storeys*.
- (c) *ý* rising and descending escalators, walkways, stairways and ramps within one *shaft* must be separated by construction with an FRL of not less than 60/60/60.
- (d) *ý* openings into the *shaft* must be protected by fire doors with an FRL not less than 60/60/30.
- (e) *ý* when a fire door is closed the floor or any covering over the floor beneath the fire door must not be *combustible*.
- (f) *ý* fire doors must be fitted with smoke seals and the assembly must be tested in accordance with AS 1530.4.
- (g) *ý* fire doors must be:
 - (i) *ý* closed and locked for security reasons; or
 - (ii) *ý* held open and be *automatic* closing.
- (h) *ý* smoke detectors must be installed on both sides of the opening, not more than 1.5 m horizontal distance from the opening.
- (i) *ý* in the closed position, fire doors must be openable on a single hand downward action or horizontal pushing action on a single device within the *shaft* and by key only from outside the *shaft*.

- (j) a warning sign must be displayed where it can readily be seen outside the *shaft* near all fire doors opening to the *shaft*. The sign must comply with the details and dimensions of Figure D2.

Figure D2 WARNING SIGN FOR NON-REQUIRED STAIRWAY, RAMP OR ESCALATOR

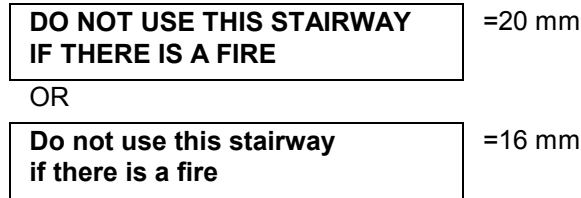

- (k) all doors opening into the *shaft* must be within 20 m of a *required exit*.
- (l) signs showing the direction of the nearest *required exit* must be installed where they can be readily seen.
- (m) materials attached to any wall, ceiling or floor within the *shaft* must have a *Spread-of-Flame Index* of 0 and a *Smoke-Developed Index* of not more than 5.
- (n) emergency lighting must be installed in the *shaft* in accordance with Part E4.4.
- (o) no step or ramp may be closer to the threshold of the doorway than the width of the door leaf.

***** y

SECTION E SERVICES AND EQUIPMENT

CONTENTS

E1 Fire Fighting Equipment

- E1.1 Application of Part
- E1.2 Fire mains and water supply services
- E1.3 Fire hydrants
- E1.4 Hose reels
- E1.5 Sprinklers
- E1.6 Portable fire extinguishers
- E1.7 Fire and smoke alarms
- E1.8 Fire control centres
- E1.9 Fire precautions during construction
- E1.10 Provision for special hazards

E2 Smoke Control

- E2.1 Smoke control
- E2.2 Exclusion of smoke from fire-isolated exits
- E2.3 Natural smoke venting
- E2.4 Air-handling systems
- E2.5 Smoke-and-heat vents
- E2.6 Smoke exhaust systems
- E2.7 Pressurisation systems

E3 Lift Installations

- E3.1 Application of Part
- E3.2 Stretcher facility in lifts
- E3.3 Warning against use of lifts in fire
- E3.4 Emergency lifts

E4 Emergency Lighting, Exit Signs and Warning Systems

- E4.1 Application of Part
- E4.2 Emergency lighting requirements
- E4.3 Measurement of distance
- E4.4 Design and operation of emergency lighting
- E4.5 Exit signs
- E4.6 Direction signs
- E4.7 Class 2 and 3 buildings and Class 4 parts: Exemptions

SUPERCEDED

- E4.8 Design and operation of exit signs ý
- E4.9 Emergency warning and intercommunication systems ý

E5 Maintenance

- E5.1 Application ý
- E5.2 Safety Installations ý
- E5.3 Mechanical Ventilation and Warm Water Systems ý

Specifications

- E1.2 Fire Mains and Water Supply Services ý
- E1.5 Fire Sprinkler Systems ý
- E1.7 Fire Detection and Alarm Systems ý
- E1.8 Fire Control Centres ý
- E2.4 Air-handling Systems ý
- E2.6 Smoke Exhaust Systems ý

Appendices

ACT

- E5.101 Maintenance deemed-to-satisfy ý
- E5.102 Maintained items ý
- E5.103 Logbooks ý

Qld

- E101 Protection of Electrical Supply to Essential Services

Vic

- Spec E2.101 Lift smoke lobbies

OBJECTIVE

A building must be so designed and constructed that the following objectives are fulfilled:

Part E1 Fire Fighting Equipment

Having regard to the size and use of the building and its Type of construction, adequate inbuilt and external fire protection services must be provided to-

- (a) ŷ restrict fire growth to the compartment of origin;
- (b) ŷ facilitate the fighting of fire to minimise damage to the building and its contents; and
- (c) ŷ prevent fire spread to adjoining buildings or allotments.

Part E2 Mechanical Ventilation and Smoke Control

Air-handling systems installed in a building must-

- (a) ŷ provide suitable air for the health and safety of the occupants; and
- (b) ŷ incorporate adequate measures to minimise the spread of smoke in the event of fire to escape paths from the building, to other compartments remote from the fire and to assist access by the attending Fire Brigade.

Part E3 Lift Installations

Suitable lifts must be provided in tall buildings, having regard to the nature of any emergency-

- (a) ŷ to assist in the evacuation of the occupants; and
- (b) ŷ to facilitate access by fire-fighting and other emergency personnel.

Part E4 Emergency Lighting, Exit Signs and Warning Systems

- (a) ŷ Emergency lighting and *exit* signs must be provided where necessary to facilitate safe egress in an emergency upon failure of the normal lighting.
- (b) ŷ Suitable warning and communication systems must be provided where necessary to alert occupants of any emergency, initiate *automatic* counter measures and summon emergency personnel.

Part E5 Maintenance

Equipment, installations and components critical to the safety of the building or the occupants must be adequately maintained in such condition that will enable their proper performance.

PART E1 FIRE FIGHTING EQUIPMENT

E1.1 Application of Part

This Part does not apply to a Class 1 or Class 10 building.

E1.2 Fire mains and water supply services

A *fire main* and water supply system for fire-fighting purposes must-

NSW E1.2(a)

SA E1.2(a)

- (a) $\dot{\gamma}$ comply with Specification E1.2; and
- (b) $\dot{\gamma}$ connect all *required hydrants*, hose reels, water storage tanks and *sprinkler systems*; and
- (c) $\dot{\gamma}$ be augmented by fixed on-site fire pumps or water storage tanks if the water supply is not sufficient to provide the *required* pressure and flow quantities; and
- (d) $\dot{\gamma}$ incorporate water storage tanks if the building has an *effective height* of more than 25 m; and
- (e) $\dot{\gamma}$ incorporate a booster assembly suitably located and with connections for use by the attending Fire Brigade if-
 - (i) $\dot{\gamma}$ *required* to be augmented by fixed on-site fire pumps, suction or elevated tanks; or

VIC E1.2(e)(ii)

(ii) more than 6 external *hydrants* are *required* at ground level; or

(iii) the *floor area* of any *fire compartment* exceeds 2000 m²; and

SA E1.2(f)

- (f) $\dot{\gamma}$ in a building with an *effective height* more than 75 m, have-
 - (i) $\dot{\gamma}$ connections in each *hydrant* rising main for a Fire Brigade portable relay boost pump spaced at not more than 50 m in the height of the rising main; and
 - (ii) $\dot{\gamma}$ a clear level space not less than 1 m wide and 2 m² in *floor area* adjacent to each connection; and
 - (iii) $\dot{\gamma}$ a fire service relay pump exhaust outlet at each connection.

VIC E1.2(g)

E1.3 Fire hydrants

(a) $\dot{\gamma}$ One or more *hydrants* must be provided-

- (i) $\dot{\gamma}$ if the building has a *floor area* more than 500 m² but not more than 1000 m² and the main entrance to the building is more than 90 m from an external *hydrant*; or
- (ii) $\dot{\gamma}$ if the building has a *floor area* more than 1000 m² and any part of the floor of the building is more than 60 m from an external *hydrant*; and
- (iii) $\dot{\gamma}$ on each level if the building contains more than 4 *storeys* of Class 2 or more than 3 *storeys* of Class 3 to 9, except that an internal *hydrant* may serve a *sole-occupancy unit* of not more than 2 *storeys* or a *sole-occupancy unit* with a *mezzanine* if the *hydrant* is located at the level of egress from that *sole-occupancy unit*; and
- (iv) $\dot{\gamma}$ at the level of the roof if the building has a rise of more than 6 *storeys*, except in the case of an *open spectator stand*, a roof having a pitch of more than 10° or a roof of a plantroom or other subsidiary structure on the roof.

SA E1.3(b)

(b) External *hydrants* must-

SUPERCEDED

- (i) \acute{y} be located not more than 20 m unobstructed distance from hard standing access for a fire pump appliance; and
- (ii) \acute{y} have 2 outlets on every stand-pipe or pillar *hydrant*; and
- (iii) \acute{y} be located not closer than 6 m from a building unless protected from it with a wall having an FRL of not less than 90/90/30 extending at least 2 m each side and 3 m above the *hydrant* outlets.

ACT E1.3(b)(iv),(b)(v)

SA E1.3(c)

VIC E1.3(c)

(c) \acute{y} Internal *hydrants* must be located-

- (i) \acute{y} so that every point on the floor is within a 6 m spray of water from the nozzle end of a fully extended 30 m length of hose; and
- (ii) \acute{y} on the floor not more than 4 m from a *required exit*, or in a *required* stairway, passageway or ramp so as not to encroach on the *required* width of the *exit*.

SA E1.3(d)

(d) *Hydrants* serving the ground floor of a building may be replaced by external *hydrants*.

SA E1.3(e)

(e) Except where superseded by the BCA, *hydrant* installations must comply with AS 2419.1.

WA E1.3(f)

E1.4 Hose reels

Hose reels must be installed in buildings as listed in Table E1.4, and must-

(a) \acute{y} not be located-

- (i) \acute{y} within a fire-isolated *exit*; or
- (ii) \acute{y} so that the hose will need to pass through doorways fitted with fire or smoke doors, except doorways referred to in C2.13, C3.11 or C3.13, and doorways in walls *required* by C2.12; and

(b) \acute{y} be located-

- (i) \acute{y} not more than 4 m from a *required exit* on each floor of the building (including the ground floor) and adjacent to any *hydrants required* within the building; and
- (ii) \acute{y} so that the nozzle end of a fully extended fire hose fitted to the reel and laid to avoid any partitions or other physical barriers will reach every part of the floor; and

(c) \acute{y} serve only the floor on which they are located except that a hose reel may serve a *sole-occupancy unit* of not more than 2 *storeys*, or a *sole-occupancy unit* with a *mezzanine*, if the hose reel is located at the level of egress from that *sole-occupancy unit*; and

(d) \acute{y} serve Class 4 parts of any building *required* to have hose reels; and

(e) \acute{y} comply with AS 1221 and AS 2441.

SUPERCEDED

NSW Table E1.4

NT Table E1.4

Table E1.4 REQUIREMENTS FOR FIRE HOSE REELS ^ý

OCCUPANCY ^ý	FIRE HOSE REELS REQUIRED
Class 2 ^ý	if more than 3 residential <i>storeys</i> contained
Class 3 ^ý	if more than 2 residential <i>storeys</i> contained
Class 5, 6, 7 or 8	(a) if more than 500 m ² total building <i>floor area</i> or b) if more than 3 <i>storeys</i> contained
Class 9a ^ý	all buildings
Class 9b	(a) ^ý if more than 300m ² total building <i>floor area</i> or (b) if more than 2 <i>storeys</i> contained
AND	
All Classes	wherever a <i>hydrant</i> is <i>required</i> in the building

E1.5 Sprinklers

A *sprinkler system* must-

- (a) be installed in buildings as listed in Table E1.5; and
- (b) comply with Specification E1.5.

NT Table E1.4

TAS Table E1.4

VIC Table E1.4

Table E1.5 REQUIREMENTS FOR SPRINKLERS ^ý

OCCUPANCY	WHEN SPRINKLERS ARE REQUIRED ^(b)
Occupancies of excessive hazard ^(a)	in <i>fire compartments</i> with- (a) a <i>floor area</i> of more than 2000 m ² ; or (b) a volume more than 12 000 m ³
Class 6	in <i>fire compartments</i> with- (a) a <i>floor area</i> of more than 3500 m ² ; or (b) a volume more than 21 000 m ³ .
Theatres, Stages & Public Halls	see Part H.1
Atrium construction	see Part G.3
All Classes except <i>open-deck carparks</i>	in buildings more than 25 m in <i>effective height</i> .
Carparks, other than <i>open-deck carparks</i>	(a) if accommodating more than 40 vehicles; or (b) if incorporating structural steel members with an FRL less than 60/ -/ - .
Note:	(a) Occupancies of excessive fire hazard are- (i) Ordinary Hazard Group III Special (ii) Extra High Hazard, Categories I, II, III and IV, as specified in AS 2118, Section 2 (b) See C2.3 for requirements for sprinklers in large isolated buildings

E1.6 Portable fire extinguishers

TAS E1.6

Portable fire extinguishers containing an extinguishing agent suitable for the risk being protected must be installed in accordance with AS 2444 in all buildings, except for water-type extinguishers in a-

- (a) Class 2 building; or
- (b) building or part of a building served by a fire hose reel.

E1.7 Fire and smoke alarms

ACT E1.7

NT E1.7

QLD E1.7

TAS E1.7

A suitable *automatic* fire and smoke detection and alarm system complying with Specification E1.7 must be installed in-

- (a) a Class 9a building; and
- (b) a Class 3 building accommodating more than 20 residents used as-
 - (i) the residential part of a *school*; or
 - (ii) accommodation for the aged, children or people with disabilities.

VIC E1.7.1

E1.8 Fire control centres

A fire control centre facility in accordance with Specification E1.8 must be provided in-

- (a) all buildings with an *effective height* of more than 25 m; and
- (b) a Class 6, 7, 8 or 9 building with a total *floor area* more than 18 000 m².

E1.9 Fire precautions during construction

In a building under construction-

- (a) not less than one fire extinguisher to suit Class A, B and C fires and electrical fires must be provided at all times on each *storey* adjacent to each *required exit* or temporary stair or *exit*; and
- (b) after the building has reached an *effective height* of 12 m-
 - (i) the *required hydrants* and hose reels must be operational in at least every *storey* that is covered by the roof or the floor structure above, except the 2 uppermost *storeys*; and
 - (ii) any *required* booster connections must be installed.

E1.10 Provision for special hazards

Suitable additional provision must be made if special problems of fighting fire could arise because of-

- (a) the nature or quantity of materials stored, displayed or used in a building or on the allotment; or
- (b) the location of the building in relation to a water supply for fire-fighting purposes.

PART E2 SMOKE CONTROL

E2.1 Smoke control

(a) Buildings must be provided with a system designed to control smoke or remove smoke as listed in Table E2.1.

NSW E2.1(b)

(b) Notwithstanding the requirements of Table E2.1, an air-handling plant which supplies air to more than one *storey* or *fire compartment* in a building *required* to have a *fire-isolated stairway* must comply with E2.4.

NSW Table E2.1

SA Table E2.1

Table E2.1 REQUIREMENTS FOR SMOKE CONTROL	
OCCUPANCY	SYSTEM
Class 1 & 10 buildings	No requirement
Buildings with a total <i>floor area</i> less than 500 m ²	No requirement
<i>Open deck carparks</i>	No requirement
<i>Open spectator stands</i>	No requirement
Class 2, 3 or 4 buildings:	No requirement within <i>sole-occupancy units</i> unless supplied by a central air-handling system in which case E2.4 shall apply.
Single <i>storey</i> buildings or the top floor of multi- <i>storey</i> buildings not exceeding 25 m in <i>effective height</i> where in each case the <i>floor area</i> of each <i>fire-compartment</i> or <i>storey</i> does not exceed 1000 m ²	(a) natural smoke venting in accordance with E2.3; or (b) air-handling systems in accordance with E2.4; or (c) roof vents in accordance with E2.5; or (d) smoke exhaust system in accordance with E2.6
Single <i>storey</i> buildings or the top floor of multi- <i>storey</i> buildings not exceeding 25 m in <i>effective height</i> where in each case the <i>floor area</i> of each <i>fire compartment</i> or <i>storey</i> exceeds 1000 m ²	(a) air handling systems in accordance with E2.4; or (b) roof vents in accordance with E2.5; or (c) smoke exhaust system in accordance with E2.6
Multi- <i>storey</i> buildings having an <i>effective height</i> not exceeding 25 m and where the <i>floor area</i> of any <i>fire-compartment</i> or <i>storey</i> does not exceed 1000 m ²	(a) natural smoke venting in accordance with E2.3; or (b) air handling systems in accordance with E2.4
Multi- <i>storey</i> buildings having an <i>effective height</i> exceeding 25 m or where the <i>floor area</i> of any <i>fire-compartment</i> or <i>storey</i> exceeds 1000 m ²	Air handling systems in accordance with E2.4
Enclosed shopping malls exceeding 40 m in length and shops which have a <i>floor area</i> exceeding 500 m ² opening on to enclosed malls.	Smoke exhaust systems in accordance with E2.6
Shops not exceeding 500 m ² opening on to enclosed malls.	No requirement
A building containing an <i>atrium</i> .	Smoke exhaust system in accordance with the provisions of Part G3
Theatres, Stages and Public Halls	Smoke exhaust systems in accordance with Part H1

E2.2 Exclusion of smoke from fire-isolated exits ^ý

WA E2.2

Buildings must be provided with means of excluding smoke from fire isolated *exits* as listed in Table E2.2.

NSW Table E2.2

Table E2.2 MEANS OF EXCLUDING SMOKE FROM FIRE-ISOLATED EXITS ^ý	
EXIT TYPE ^ý	REQUIREMENT
<i>A required fire-isolated stairway serving any storey above an effective height of 25 m</i>	Either- (a) a pressurisation system in accordance with E2.7; or (b) open access ramps or balconies in accordance with D2.5
<i>A required fire-isolated stairway serving 3 or more below ground storeys</i>	
<i>A required fire-isolated ramp or fire- isolated passageway having a path of travel more than 60 m along it to a road or open space</i>	
<i>A required fire-isolated stairway serving an atrium</i>	A pressurisation system in accordance with E2.7

Note: A below ground *storey* is one that is partially or wholly below ground and is not counted in the *rise in storeys* in accordance with C1.2

E2.3 Natural smoke venting

Windows, doors, panels, or the like, provided to control the movement of smoke must-

- (a) be in accordance with Part F4; and
- (b) be as evenly distributed as practicable; and
- (c) be readily openable, except that where *windows*, panels or the like are provided on the ground level *storey*, they need only be shatterable.

E2.4 Air-handling systems

WA E2.4

Air-handling systems-

- (a) ^ý serving more than one *fire compartment* must operate:
 - (i) ^ý in accordance with AS 1668.1; or
 - (ii) ^ý in accordance with Specification E2.4; or
- (b) ^ý serving a single *storey* or *fire compartment* only, must operate in accordance with Specification E2.4.

SA E2.4(c)

VIC E2.4(c)

E2.5 Smoke-and-heat vents ^ý

WA E2.5

Required smoke-and-heat vents may be a combination of permanently open, or *automatically* opening units in accordance with AS 2427 and AS 2428.

The smoke venting system must comply with AS 2665 except that-

- (a) ^ý draught curtains may divide the space below the roof into compartments with area of not more than 1 500 m²; and
- (b) ^ý all *automatic* roof vents within the same roof compartment must open at the same time; and

- (c) *automatic* operation of roof vents must be initiated by either:
- (i) *a sprinkler system* if it is installed throughout the building; or
 - (ii) *a fire detection and alarm system* which complies with Specification E1.7;
or
 - (iii) *smoke detectors* spaced not more than 30 m apart and 15 m from any draught curtain and with not less than one detector for each 500 m²; or
 - (iv) *rate of rise heat detectors* spaced not more than 15 m apart and 7.5 m from any draught curtain and with not less than one detector for each 250 m² of *floor area*; or
 - (v) *within a Class 7 or Class 8 building* the fusible link operation of any one unit.

E2.6 Smoke exhaust systems

A *required* smoke exhaust system must comply with Specification E2.6.

E2.7 Pressurisation systems

WA E2.7

A *required* pressurisation system must-

- (a) *not serve more than one fire-isolated exit*; and
- (b) *not form part of any other air-handling system*; and
- (c) *comply with AS 1668.1, except that-*
 - (i) *the requirement for a 50 Pa pressure differential across each door when all doors are closed does not apply*; and
 - (ii) *in a smoke control system complying with Specification E2.4, the air velocity at the door does not apply to non-fire doors, and*
 - (iii) *must not have in the stairway, ramp or passageway openable windows or other openable devices (other than necessary doorways, pressure-controlled relief louvres and windows openable by a key)*; and
- (d) *be actuated by smoke detectors located near each stairway door in accordance with Specification E1.7 and any other smoke detectors installed in accordance with AS 1670 or AS 1668.1.*

NSW E2.7(e),(f)

SA E2.7(e)

VIC Spec E2.101

PART E3 LIFT INSTALLATIONS

E3.1 Application of Part

This Part does not apply to Class 1 or Class 10 buildings.

E3.2 Stretcher facility in lifts

- (a) *If passenger lifts are installed in any building with an effective height of more than 12 m, each floor served by these lifts must have at least one lift with a stretcher facility in accordance with (b).*

- (b) *ý* A lift *required* to have a stretcher facility by E3.2(a) or E3.4(b)(iii) must accommodate a raised stretcher with a patient lying on it horizontally by providing a clear space 600 mm wide x 2000 mm long x 1200 mm high above the floor level.

E3.3 Warning against use of lifts in fire

A warning sign must-

- (a) *ý* be displayed where it can be readily seen-
- (i) *ý* near every call button for a passenger lift or group of lifts throughout a building; except
 - (ii) *ý* a small lift such as a dumb-waiter or the like that is for the transport of goods only; and
- (b) *ý* comply with the details and dimensions of Figure E3.3 and consist of-
- (i) *ý* incised, inlaid or embossed letters on a metal, wood, plastic or similar plate securely and permanently attached to the wall; or
 - (ii) *ý* letters incised or inlaid directly into the surface of the material forming the wall.

Figure E3.3 WARNING SIGN FOR PASSENGER LIFTS *ý*

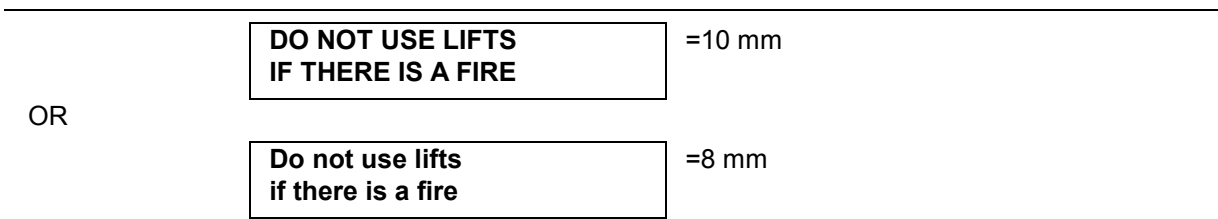

E3.4 Emergency lifts *ý*

NSW E3.4(a)

- (a) *ý* One or more lifts capable of becoming an emergency lift to serve each floor served by the lifts in the building must be installed in-
- (i) *ý* a building which has an *effective height* of more than 25 m; and
 - (ii) *ý* a Class 9a building in which *patient care areas* are located above a level with direct egress to a road or *open space*.

- (b) *ý* An emergency lift *required* by (a) must-

WA E3.4(b)(i)

- (i) *ý* comply with AS 1735.2; and
- (ii) *ý* have a rating of at least 600 kg if the building has an *effective height* of more than 75 m; and
- (iii) *ý* be of sufficient size to take a stretcher facility in accordance with E3.2(b); and
- (iv) *ý* in a Class 9a building serving a *patient care area* have the following minimum dimensions, measured clear of all obstructions, including handrails, etc.

Minimum depth of car	2280 mm <i>ý</i>
Minimum width of car	1600 mm <i>ý</i>
Minimum floor to ceiling height	2300 mm <i>ý</i>

Minimum door height 2100 mm

Minimum door width 1300 mm

NSW E3.4(c) to (e)

PART E4 *ý* EMERGENCY LIGHTING, EXIT SIGNS AND WARNING SYSTEMS

E4.1 *ý* Application of Part

This Part does not apply to Class 1 or 10 buildings.

E4.2 *ý* Emergency lighting requirements

An emergency lighting system must be installed-

- (a) *ý* in every *fire-isolated stairway, fire-isolated ramp or fire-isolated passageway*; and
- (b) *ý* in every *storey* of a Class 5, 6, 7, 8 or 9 building where the *storey* has a *floor area* more than 300 m²-
 - (i) *ý* in every passageway, corridor, hallway, or the like, that is part of the path of travel to an *exit*; and
 - (ii) *ý* in any room having a *floor area* more than 100 m² that does not open to a corridor or space that has emergency lighting or to a road or *open space*; and
 - (iii) *ý* in any room having a *floor area* more than 300 m²; and
- (c) *ý* in every passageway, corridor, hallway, or the like, having a length of more than 6 m from the entrance doorway of any *sole-occupancy unit* in a Class 2 or 3 building or Class 4 part to the nearest doorway opening directly to-
 - (i) *ý* a *fire-isolated stairway, fire-isolated ramp or fire-isolated passageway*; or
 - (ii) *ý* an external stairway serving instead of a *fire-isolated stairway* under D1.8; or
 - (iii) *ý* an external balcony leading to a *fire-isolated stairway, fire-isolated ramp or fire-isolated passageway*; or
 - (iv) *ý* a road or *open space*; and
- (d) *ý* in every *required non-fire-isolated stairway*; and
- (e) *ý* in a *sole-occupancy unit* in a Class 5, 6 or 9 building if-
 - (i) *ý* the *floor area* of the unit is more than 300 m²; and
 - (ii) *ý* an *exit* from the unit does not open to a road or *open space* or to an external stairway, passageway, balcony or ramp, leading directly to a road or *open space*; and
- (f) *ý* in every room or space to which there is public access in every *storey* in a Class 6 or 9b building if-
 - (i) *ý* the *floor area* in that *storey* is more than 300 m²; or
 - (ii) *ý* any point on the floor of that *storey* is more than 20 m from the nearest doorway opening directly to a stairway, ramp, passageway, road or *open space*; or

- (iii) $\dot{\gamma}$ egress from that *storey* involves a vertical rise within the building of more than 1.5 m, or any vertical rise if the *storey* concerned does not admit sufficient light; or
 - (iv) $\dot{\gamma}$ the *storey* provides a path of travel from any other *storey required* by (i), (ii) or (iii) to have emergency lighting; and
- (g) $\dot{\gamma}$ in a Class 9a building-
- (i) $\dot{\gamma}$ in every passageway, corridor, hallway, or the like, serving a ward area or patient treatment room; and
 - (ii) $\dot{\gamma}$ in *patient care areas* having a *floor area* of more than 120 m²; and
- (h) $\dot{\gamma}$ in every *required* fire control centre.

E4.3 Measurement of distance

Distances, other than vertical rise, must be measured along the shortest path of travel whether by straight lines, curves or a combination of both.

E4.4 Design and operation of emergency lighting

- (a) $\dot{\gamma}$ Every emergency lighting system must-
- (i) $\dot{\gamma}$ be *automatic* in operation; and
 - (ii) $\dot{\gamma}$ provide sufficient illumination without undue delay for safe evacuation of all areas of the building where it is *required*; and
 - (iii) $\dot{\gamma}$ if it is a central system, be suitably protected from damage by fire.
- (b) $\dot{\gamma}$ Emergency lighting in accordance with AS 2293.1 satisfies (a).

SA E4.4(c)

E4.5 Exit signs

An *exit* sign must be clearly visible to persons approaching the *exit*, and must be installed on, above or adjacent each-

- (a) $\dot{\gamma}$ door providing direct egress from a *storey* to-
- (i) $\dot{\gamma}$ an enclosed stairway, passageway or ramp serving as a *required exit*;
 - (ii) $\dot{\gamma}$ an external stairway, passageway or ramp serving as a *required exit*; and
 - (iii) $\dot{\gamma}$ an external access balcony leading to a *required exit*;
- (b) $\dot{\gamma}$ door from an enclosed stairway, passageway or ramp at every level of discharge to a road or *open space*;
- (c) $\dot{\gamma}$ *horizontal exit*; and
- (d) $\dot{\gamma}$ door serving as, or forming part of, a *required exit* in a *storey required* to be provided with emergency lighting in accordance with E4.2.

E4.6 Direction signs

If an *exit* is not readily apparent to persons occupying or visiting the building then *exit* signs with directional arrows must be installed in appropriate positions in corridors, hallways, lobbies, and the like, indicating the direction to a *required exit*.

E4.7 Class 2 and 3 buildings and Class 4 parts: Exemptions

E4.5 does not apply to-

- (a) ý a Class 2 building in which every door referred to is clearly and legibly labelled on the side remote from the *exit* or balcony-
 - (i) ý with the word "EXIT" in capital letters 25 mm high in a colour contrasting with that of the background; or
 - (ii) ý by some other suitable method; and
- (b) ý an entrance door of a *sole-occupancy unit* in a Class 2 or 3 building or a Class 4 part.

E4.8 Design and operation of exit signs

- (a) ý Every *required exit* sign must-
 - (i) ý be clear and legible and have letters and symbols of adequate size; and
 - (ii) ý be illuminated at a level sufficient for it to be clearly visible at all times when the building is occupied by any person having the right of legal entry to the building; and
 - (iii) ý be installed so that if the normal power supply fails, emergency ý illumination is provided to the sign; and ý
 - (iv) ý if illuminated by an emergency lighting system incorporating wiring and a power source, comply with E4.4.
- (b) ý *Exit* signs in accordance with AS 2293.1 satisfy (a).

NSW E4.8(c),(d)

E4.9 Emergency warning and intercommunication systems ý

QLD E4.9

An emergency warning and intercommunication system complying where applicable with AS 2220 must be installed-

- (a) ý in a building with an *effective height* of more than 25 m; and
- (b) ý in a Class 3 building having a *rise in storeys* of more than 2 and used as-
 - (i) ý the residential part of a *school*; or
 - (ii) ý accommodation for the aged, children or people with disabilities; and
- (c) ý in a Class 9a building having a *floor area* of more than 1000 m² or a *rise in storeys* of more than 2, except that a discrete alert and evacuation tone may be employed to minimize patient trauma; and
- (d) ý in a Class 9b building-
 - (i) ý used as a *school* and having a *rise in storeys* of more than 3; or
 - (ii) ý used as a theatre, public hall, or the like, having a *floor area* more than 1000 m² or a *rise in storeys* of more than 2.

PART E5 MAINTENANCE

TAS Part E5

E5.1 Application

This Part does not apply to a Class 1 or Class 10 building.

E5.2 Safety Installations

ACT E5.2

NT E5.2

Safety installations in buildings must be adequately maintained.

E5.3 Mechanical Ventilation and Warm Water Systems

NSW E5.3

Mechanical ventilation and warm water systems must be maintained in accordance with AS 3666.

ACT E5.101 to E5.103

QLD E101

SPECIFICATION E1.2 FIRE MAINS AND WATER SUPPLY SERVICES

NSW Spec E1.2

SA Spec E1.2

1. Scope

This Specification refers to *fire mains* and water supply services for fire-fighting equipment in buildings.

2. General requirements

A *fire main* must-

- (a) be capable of supplying water at the flow rates and pressures necessary for the satisfactory operation of the *required* fire-fighting equipment; and
- (b) not be used for other than fire-fighting purposes, except a *fire main* serving only hose reels which may be connected to a metered supply if-
 - (i) the *required* flow rate and pressure can be maintained at the most hydraulically disadvantaged hose reel;
 - (ii) the water meter and street supply to the allotment have a nominal diameter of not less than 32 mm;
 - (iii) water supply pipework reticulation arrangements comply with Figure 2; and
 - (iv) any system valve which can isolate flow in the *fire main* is secured in the open position by a padlocked metal strap and has attached an engraved non-ferrous metal tag with 8 mm upper case wording:

FIRE SERVICE VALVE-

CLOSE ONLY TO SERVICE FIRE HOSE REELS.

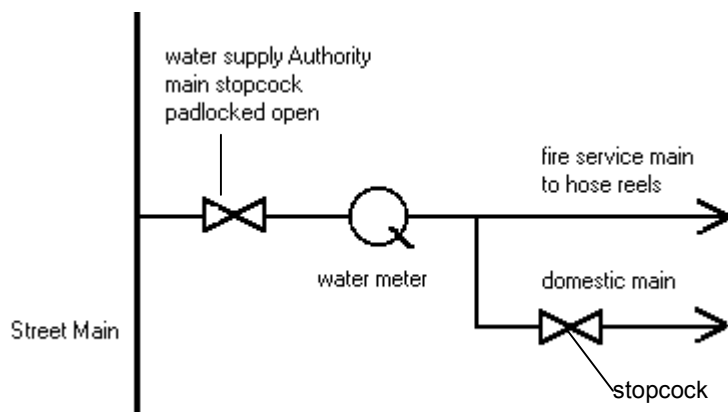
Figure 2 WATER SUPPLY RETICULATION: COMBINED SERVICES

3. Fixed on site fire pumps

Fixed on site fire pumps must-

- (a) comprise a minimum of 2 pumps, except in a Class 2, 3 or 5 building one pump may be used if the building-
- (i) has an *effective height* of not more than 25 m; and
 - (ii) contains *fire compartments* not more than 2000 m² in *floor area*; and
- VIC Spec E1.2 3(b)
- (b) be located in a room or enclosure which has an FRL of not less than 120/120/60 and is-
- (i) within the building; or
 - (ii) external within 6 m of the building but not closer than 6 m to any *fire-source feature*.

4. Booster connections and cabinets

(a) Each booster inlet connection must-

- (i) allow a *fire main* to be pressurised without the need to manually operate valves; and
- (ii) if fitted with a pressure gauge, the gauge must comply with AS 1349, and have a full scale reading of not less than 25% more than the pressure to which the system has been hydrostatically tested.

(b) Cabinets where provided must be located-

- (i) at the *external wall* of a building if they are within sight of the main entrance and for Class 6, 7, 8 or 9b buildings, separated from the building by construction having an FRL of not less than 120/120/60 for not less than 2 m each side of and above the top of the cabinet; or
- (ii) remote from the building if they are at the boundary of the allotment, within sight of the main entrance to the building, adjacent to the principal vehicular access to the allotment and located not less than 10 m from the *external wall* of any building; or
- (iii) in any other suitable position.

- (c) ŷ If the booster inlet connection is housed in a cabinet, a permanent fade and water resistant plan, equal to photo-engraved anodized aluminium, must be displayed in a prominent position within the cabinet, showing the following information:
- (i) ŷ the layout of the building and adjacent streets; and
 - (ii) ŷ the layout of the fire *hydrant* system reticulation, with supply authority street mains and size, location of street and allotment *hydrants*, fire hose reels, booster connections, street and allotment isolating and non-return valves, pumps and tanks; and
 - (iii) ŷ the operational discharge pressure and pressure at zero flow of any pump installed in the system; and
 - (iv) ŷ the capacity of any tank connected to the system; and
 - (v) ŷ the height of the highest *hydrant* outlet above the lowest booster inlet connection; and
 - (vi) ŷ the year of installation of the system.
- (d) ŷ Provision must be made for the drainage of water from within a booster cabinet by-
- (i) ŷ standing the cabinet on legs with a 50 mm clearance to a concrete plinth; and
 - (ii) ŷ sloping the floor not less than 75 mm from the rear of the cabinet to drainage weepholes at the front or to the outside.

[WA Spec E1.2 5](#)

SPECIFICATION E1.5 FIRE SPRINKLER SYSTEMS

1. ŷ **Scope**

This specification sets out requirements for the design and installation of *automatic fire sprinkler systems*.

2. ŷ **Adoption of AS 2118**

[ACT Spec E1.5 2](#)

An *automatic fire sprinkler system* must comply with AS 2118 subject to this Specification.

3. ŷ **Provisions of AS 2118 not to apply**

[NT Spec E1.5 3](#)

[VIC Spec E1.5 3](#)

The following provisions of AS 2118 do not apply: ŷ

- (a) Clause 1.2.20 - definition of a "fire door".
- (b) Clause 3.6 - "Maintenance".

4. **Interpretation**

A reference in AS 2118 to-

- (a) ŷ an "inferior wall" - means an *external wall required* to have an FRL and which incorporates openings; and

(b) ý a "fire door" - means a fire door complying with Specification C3.4.

5. ý Definition of a sprinklered building

Notwithstanding AS 2118, a building or a part of a building is deemed to be sprinklered if-

- (a) ý in the case of a whole building, the building complies with Section C and is sprinklered throughout; or
- (b) ý in the case of a part of a building-
 - (i) ý the part is sprinklered throughout and fire-separated from the ý unsprinklered part in accordance with Part C2; and ý
 - (ii) ý any opening in the fire separating construction between the sprinklered and unsprinklered part is protected in accordance with Part C3.

6. ý Exemptions

If a building or part of a building is *required* to be sprinklered throughout, then the exemptions in clause 3.3.3 of AS 2118 apply, except where protection of openings is specified by that clause, the protection must be by means of a fire door in accordance with Part C3.

7. ý Fast response sprinklers

Fast response sprinklers may be installed only if they have been tested for the type of application proposed and it is demonstrated that the protection provided will not be less than that provided by an installation complying with AS 2118.

8. ý Sprinkler valve enclosures

Sprinkler alarm valves must be located in a secure enclosure or room of adequate size, and-

- (a) ý where the valves are located within a building, the enclosure and *required* access to it, which must be from a door opening onto a public place, must be separated from all other parts of the building by construction which has an FRL of not less than 120/120/120; and
- (b) ý where the valves are located external to a building, the enclosure must not be located closer than 6ým to it, unless-
 - (i) ý a wall having an FRL of not less than 90/90/90 is between the enclosure and the building; and
 - (ii) ý the wall extends to the full height and not less than 2 m each side of the enclosure; and
 - (iii) ý an entry door to the building is located no further than 6 m from the enclosure.

9. ý Water supply

Notwithstanding AS 2118, the water supply to a *required sprinkler system* must be not less than-

- (a) ý Grade III for buildings not more than 25 m *effective height*; and

- (b) ý Grade I for buildings of more than 25 m *effective height*, except that if only a part of the building is *required* to be sprinklered, the grade of supply may be reduced to-
- (i) ý Grade II for each part being Class 6 or Class 9, or a Class 6 or Class 9 part together with a part used as a *public carpark*; and
 - (ii) ý Grade III if only a part of the building is *required* to be sprinklered and it is a part used as a *public carpark*.

SPECIFICATION E1.7 ý FIRE DETECTION AND ALARM SYSTEMS

QLD Spec E1.7

1. ý Scope

This Specification describes the installation and operation of fire detection and alarm systems, which may also be utilised to operate a smoke control system within a building.

2. ý Adoption of AS 1670

A fire detection and alarm system must comply with AS 1670 subject to this Specification.

3. ý Purpose

The purpose of a fire detection and alarm system is to-

- (a) ý warn the occupants of a fire within the building; and
- (b) ý alert the local Fire Brigade; and
- (c) ý activate any installed *automatic* smoke control system.

4. ý Connection to other warning devices

In addition to AS 1670, a fire detection system must be connected to-

- (a) ý any emergency warning and intercommunication system *required* by Part E4; or
- (b) ý auxiliary warning devices strategically located throughout the premises on every floor if no emergency warning and intercommunication system is *required*.

5. ý Class 9a buildings

In a Class 9a building, a fire detection and alarm system must-

- (a) ý where-
 - (i) ý more than 20 bed patients are accommodated, be installed throughout the building and be connected to a fire station in accordance with the requirements of the appropriate fire authority; or
 - (ii) ý more than 6, but less than 21 bed patients are accommodated, be installed throughout the building but need not be connected to a fire station; or
 - (iii) ý 6 or less bed patients are accommodated, incorporate single station smoke detectors connected to consumer power mains and be located in all paths of egress and sleeping areas; and

SUPERCEDED

- (b) ŷ have type "A" rate of rise heat detectors installed throughout the building, except-
 - (i) ŷ in a sprinklered building; or
 - (ii) ŷ those areas where smoke detectors are installed; and
- SA Spec E1.7 5(c)
- (c) ŷ have smoke detectors installed in-
 - (i) ŷ *patient care areas* and the path of egress from each such area to a public space; and
 - (ii) ŷ other areas as necessary for effective smoke control; and
 - (d) ŷ incorporate break glass manual fire alarms in paths of egress so that no point on a floor is more than 30 m from such an alarm point.

6. ŷ **Location of smoke detectors**

Smoke detectors must be-

NSW Spec E1.7 6(a)

- (a) ŷ wherever possible, surface mounted and outside air-handling ducts, unless a point sampling system with maximum sensitivity level of 0.5% smoke obscuration per metre is used; and
- (b) ŷ located at natural collection points for hot smoke having regard to the ceiling geometry and its effects on the migratory path; and
- (c) ŷ situated not more than 1.5 m horizontal distance from smoke doors or fire doors; and
- (d) ŷ of the photo-electric type if installed within ducts or atmospheres contaminated with dust particles less than 1 m in size and other particles likely to operate an ionization type detector.

7. ŷ **Threshold Levels**

- (a) ŷ Sampling systems must comply with AS 1670, with response times and alarm thresholds maintained at minimum levels and no alarm delay permitted on the highest alarm threshold utilised.
- (b) ŷ The setting of alarm threshold levels for addressable detectors used within intelligent systems must not exceed the sensitivity levels nominated in-
 - (i) ŷ AS 1668.1; and
 - (ii) ŷ AS 1603 and AS 1603 Parts 4 and 6.

SPECIFICATION E1.8 FIRE CONTROL CENTRES

1. ŷ **Scope**

This Specification describes the construction and content of *required* fire control centres or rooms.

2. ŷ **Purpose and content**

A fire control centre or room must-

- (a) ŷ provide an area from which fire fighting operations or other emergency procedures can be directed or controlled; and

SUPERCEDED

- (b) ý contain controls, panels, telephones, furniture, equipment and the like associated with the *required* fire services in the building; and
- (c) ý not be used for any purpose other than the control of-
 - (i) ý fire fighting activities; and
 - (ii) ý other measures concerning the safety or security of the building occupants.

3. ý **Location of fire-control centre or room**

A fire control centre or room must be so located in a building that egress from any part of its floor, to a public road or *open space*, does not involve changes in level which in aggregate exceed 300 mm.

4. ý **Construction**

SA Spec E1.8 4

A fire-control centre in a building more than 50 m in *effective height* must be in a separate room where-

- (a) ý the enclosing construction is of concrete, masonry or the like, sufficiently impact resistant to withstand the impact of any likely falling debris, and with an FRL of not less than 120/120/120; and
- (b) ý any material used as a finish, surface, lining or the like within the room complies with the requirements of Specification C1.10 for *fire-isolated stairways*; and
- (c) ý services, pipes, ducts and the like that are not directly *required* for the proper functioning of the fire control room do not pass through it; and
- (d) ý openings in the walls, floors or ceiling which separate the room from the interior of the building are confined to doorways, ventilation and other openings for services necessary for the proper functioning of the facility.

5. ý **Protection of openings**

Openings permitted by clause 4 must be protected as follows:

- (a) ý Openings for *windows*, doorways, ventilation, service pipes, conduits and the like, in an *external wall* of the building that faces a public road or *open space*, must be protected in accordance with Part C3 as applicable.
- (b) ý Openings in the floors, ceilings and *internal walls* enclosing a fire control room must, except for doorways, be protected in accordance with Part C3, as appropriate.
- (c) ý A door opening in the *internal walls* enclosing a fire-control room, must be fitted with a self closing 120/120/30 smoke sealed fire door.
- (d) ý Openings associated with natural or mechanical ventilation must-
 - (i) ý not be made in any ceiling or floor immediately above or below the fire control room; and
 - (ii) ý be protected by a 120/120/- fire damper if the opening is for a duct through a wall *required* to have an FRL, other than an *external wall*.

6. ý Exit doors

- (a) ý *Required* doors to a fire control room must open into the room, be lockable and located so that persons using escape routes from the building will not obstruct or hinder access to the room.
- (b) ý The fire control room must be accessible via two paths of travel-
- (i) ý one from the front entrance of the building; and
 - (ii) ý one direct from a public place or *fire-isolated passageway* which leads to a public place and has an FRL of not less than 120/120/120.

7. ý Size and contents

- (a) ý A fire control room must contain not less than-
- (i) ý a Fire Indicator Panel and necessary control switches and visual status indication for all *required* fire pumps, smoke control fans and other *required* fire safety equipment installed in the building; and
 - (ii) ý a telephone directly connected to an external telephone exchange; and
 - (iii) ý a blackboard or whiteboard not less than 1200 mm wide x 1000 mm high; and
 - (iv) ý a pin up board not less than 1200 mm wide x 1000 mm high; and
 - (v) ý a raked plan layout table of size not less than the plans to be laid out upon the table, and plans of the structural, architectural, electrical, mechanical, lift and fire service details which may be stored beneath the plan layout table or within other suitable storage facility located in the room.

WA Spec E1.8 7(a)(vi)

- (b) ý In addition, a fire control room may contain-
- (i) ý master emergency control panels, lift annunciator panels, remote switching controls for gas or electrical supplies and emergency generator backup; and
 - (ii) ý building security, surveillance and management systems if they are completely segregated from all other systems.
- (c) ý A fire-control room must-
- (i) ý have a *floor area* of not less than 10 m² and the length of any internal side must be not less than 2.5 m; and
 - (ii) ý if only the minimum prescribed equipment is installed - have a net floor area of not less than 8 m² with a clear space of not less than 1.5 m² in front of the Fire Indicator Panel; and
 - (iii) ý if additional equipment is installed - have an additional area of not less than 2 m² net floor area for each additional facility and a clear space of not less than 1.5 m² in front of each additional control or indicator panel, and the area *required* for any path of travel through the room to other areas must be provided in addition to the requirements (ii) and (iii).

8. ý Ventilation and power supply

A fire control room must be ventilated by-

- (a) ý natural ventilation from a *window* or doorway in an *external wall* of the building which opens directly into the fire control room from a roadway or *open space*; or

- (b) ý a pressurisation system that only serves the fire control room, and-
- (i) ý is installed in accordance with AS 1668.1 as though the room is a *fire-isolated stairway*; and
 - (ii) ý is activated *automatically* by operation of the fire alarm or *sprinkler system* installed in the building and manually by an over-riding control in the room; and
 - (iii) ý provides a flow of fresh air through the room of not less than 30 air changes per hour when the system is operating and any door to the room is open; and
 - (iv) ý has fans, motors and ductwork that form part of the system but not contained within the fire-control room protected by enclosing construction with an FRL of not less than 120/120/120; and
 - (v) ý has any electrical supply to the fire-control room or equipment necessary for its operation connected to the supply side of the main disconnection switch for the building and electrical service cables of MIMS (copper) cable with copper conductors or otherwise suitably fire-protected, and no openable devices other than necessary doorways, pressure controlled relief louvres and *windows* that are openable by a key, must be constructed in the fire control room.

9. ý Sign

The external face of the door to the fire control room must have a sign with the words-

FIRE CONTROL ROOM

in letters of not less than 50 mm high and of a colour which contrasts with that of the background.

10. ý Lighting

Emergency lighting in accordance with Part E4 must be provided in a fire control room, except that an illumination level of not less than 400 lux must be maintained at the surface of the plan table.

11. ý Equipment not permitted within a fire control centre or room

An internal combustion engine, pumps, sprinkler control valves, pipes and pipe fittings must not be located in a fire control centre or room, but may be located in rooms accessed through the fire control centre or room.

12. ý Ambient Sound Level

The ambient sound level within the fire control centre or room measured when all fire safety equipment is operating in the manner in which it operates in an emergency, must not exceed 65 dB(A), when determined in accordance with AS 2107.

SPECIFICATION E2.4 AIR-HANDLING SYSTEMS

NSW Spec E2.4

WA Spec E2.4

1. Scope

This Specification describes the performance and operation of air-handling systems used to control smoke.

2. Central air-handling systems

The central air-handling system supplying air to more than one *storey* or *fire compartment* may be utilised for smoke control if it complies with A.S 1668.1 with respect to standards of equipment and installation but is modified to meet the following conditions-

- (a) additional smoke control dampers must be introduced into the smoke exhaust and fresh air supply ductwork-
 - (i) in such a manner so that the fire integrity of the building is not compromised; and
 - (ii) to achieve a pressure of not less than 20 Pa in all other *storeys* and *fire compartments* above the pressure on the fire affected *storey* or *fire compartment*; and
- (b) the smoke control system must-
 - (i) close any smoke damper to the supply air serving the fire affected *storey* or *fire compartment*; and
 - (ii) open any smoke damper to a smoke exhaust duct or relief opening which will relieve smoke to outside the building from the fire affected *storey* or *fire compartment*; and
 - (iii) have a fail safe operation which will close all supply and open all smoke relief or exhaust dampers; and
- (c) in a common fan assisted smoke *shaft*, sufficient air from other *storeys* or other sources must be mixed with the hot smoky gases to limit the temperature at the exhaust fan to less than 200°C for a heat output as nominated in Specification E2.6 Fig 2.

3. Individual air-handling units on each floor

Where an air-handling system supplies air to a single *storey* or fire-compartment-

- (a) the air-handling unit on the fire-affected *storey* or *fire compartment* must stop; and
- (b) the air-handling units on all other *storeys* or *fire compartments* must supply full fresh air to those *storeys* or *fire compartments*; and
- (c) the fire-affected *storey* or *fire compartment* must be relieved or exhausted to outside the building,

to achieve not less than 20 Pa positive pressure in all other *storeys* and *fire compartments* above the pressure in the fire affected *storey* or *fire compartment*.

4. Actuation of smoke control system

The smoke control system must be *automatic* in operation and actuated by-

- (a) smoke detectors located adjacent to each *required exit* and return air path on each floor in accordance with Specification E1.7; and
- (b) by any other suitable fire alarm system, including a *sprinkler system*, installed within the building.

SPECIFICATION E2.6 SMOKE EXHAUST SYSTEMS

NSW Spec E2.6

WA Spec E2.6

1. Scope

This Specification describes the performance and method of operation of smoke exhaust systems in buildings which are designed to-

- (a) remove smoke from within the building using ducted or roof mounted exhaust fans; or
- (b) in a shopping centre complex or mall, remove smoke from within pedestrian malls to maintain for as long as possible a tenable escape path for the occupants.

2. Fan capacity

Fan systems must have at least an exhaust capacity in accordance with Figure 2. \dot{V}

Figure 2 SMOKE EXHAUST RATE

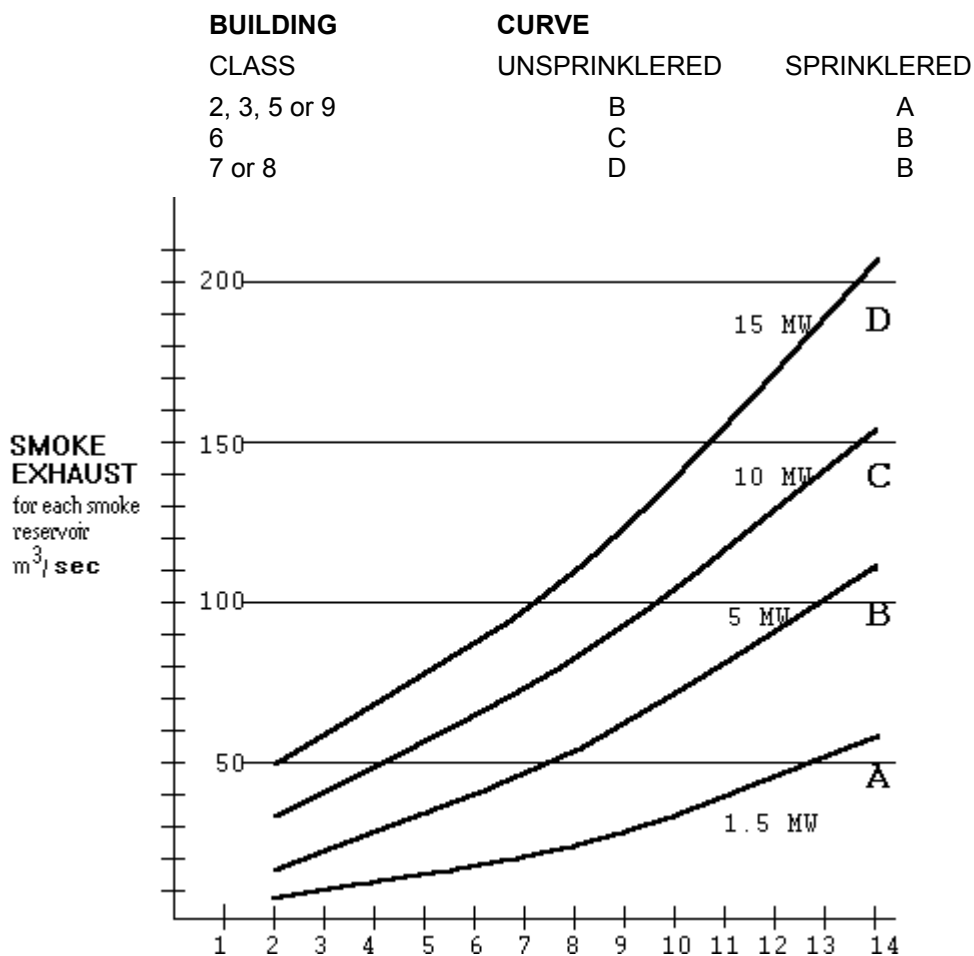

SUPERCEDED

HEIGHT - to underside of smoke layer (metres) \dot{y}

(To be not less than 2.1 m above all floor levels within the compartment) \dot{y}

3. \dot{y} **Compartmentation at ceiling level**

The *storey* or room at ceiling level-

- (a) \dot{y} must be divided into compartments not more than 1500 m² in area by draught curtains in accordance with AS 2665; and
- (b) \dot{y} in a shopping centre complex or mall, must have-
 - (i) \dot{y} draught curtains or *non-combustible*, toughened safety glass or wired glass bulkheads that extend not less than 1 m beneath any imperforate ceiling; or
 - (ii) \dot{y} a smoke reservoir of not less than 500 mm deep, and containing a smoke exhaust fan,
across the full width of the mall to divide it into lengths of not more than 40 m.

4. \dot{y} **Location of fans and discharge**

Exhaust fans must be located so as not to cause undue turbulence, and-

- (a) \dot{y} in a shopping centre complex or mall-
 - (i) \dot{y} not more than 20 m from the end of the complex or mall and spaced not more than 40 m apart; and
 - (ii) \dot{y} not at a mall intersection unless there is an open area where the ceiling is raised not less than 2 m above the ceiling in the mall; and
 - (iii) \dot{y} at natural collection points for the hot smoky gasses within each smoke compartment having regard to the ceiling geometry and its effect on the migratory path of the smoke;
- (b) \dot{y} in other buildings be located so that each fan must not serve more than one 1500 m² smoke compartment; and
ACT Spec E2.6 4(c) to 4(f)
- (c) \dot{y} discharge directly to the outside and in a manner that will not spread fire or smoke to adjacent *fire compartments* or buildings.

5. \dot{y} **Make-up air**

Low level fresh air inlet openings or doors must be sized to provide adequate low velocity fresh air make up to satisfy the exhaust performance of the installed smoke exhaust fans, care being exercised in the number and location of such openings and their disturbance of the smoke layer due to turbulence created by the incoming air.

6. \dot{y} **Operation of fans**

All smoke exhaust fans must start sequentially and be activated by the operation in the area served by the fan of-

- (a) \dot{y} a *sprinkler system*;
- (b) \dot{y} a fire detection and alarm system which complies with Specification E1.7; or
- (c) \dot{y} a detector system comprising-

- (i) ý smoke detectors spaced not more than 30 m apart and 15 m from any draught curtain, bulkhead or wall and not less than one detector for each 500 m² of *floor area*; or
 - (ii) ý rate of rise heat detectors spaced not more than 15 m apart and 7.5 m from any draught curtain, bulkhead or wall and with not less than one detector for each 250 m² of *floor area*; and
 - (iii) ý not less than 2 detectors located on opposite sides of each fan inlet; and
NSW Spec E2.6 6(d), 6(e)
- (d) ý in a shopping centre complex or mall - optical smoke detectors spaced no more than 20 m apart and not more than 10 m from the end of the mall and any wall, bulkhead or draught curtain.

7. ý Protection of wiring

NSW Spec E2.6 7

Power supply wiring for roof-mounted exhaust fans must be MIMS (copper) cable or otherwise suitably fire-protected where it passes through other *storeys* and might be affected by fire remote from the floor served by the plant.

8. ý Resistance to high temperatures

If not adequately shielded from the airflow-

- (a) all parts of exhaust fans and other equipment *required* to operate in a smoke laden environment; and
- (b) parts of the building *required* to be smoke-resisting, must be capable of withstanding a temperature of 200°C for a period of not less than 1 hour.

SECTION F HEALTH AND AMENITY

CONTENTS

F1 Damp and Weatherproofing

- F1.1 Drainage ý
- F1.2 Building on land subject to dampness ý
- F1.3 Drainage of land surrounding buildings ý
- F1.4 Weatherproofing of roofs and walls ý
- F1.5 Roof coverings deemed-to-satisfy ý
- F1.6 Pliable roof sarking ý
- F1.7 Water proofing of wet areas in buildings ý
- F1.8 Damp-proof courses and mortars ý
- F1.9 Acceptable damp-proof courses ý
- F1.10 Damp-proofing of floors on the ground ý
- F1.11 Provision of floor wastes ý

F2 Sanitary and Other Facilities

- F2.1 Facilities in residential buildings ý
- F2.2 Calculation of number of occupants and fixtures ý
- F2.3 Facilities in Class 3 to 9 buildings ý
- F2.4 Facilities for people with disabilities ý
- F2.5 Construction of sanitary compartments ý
- F2.6 Interpretation: Urinals and washbasins ý
- F2.7 Warm water installations ý

F3 Room Sizes

- F3.1 Height of rooms ý
- F3.2 Reduced height permissible ý

F4 Light and Ventilation

- F4.1 Provision of natural light ý
- F4.2 Methods and extent of natural lighting ý
- F4.3 Natural light borrowed from adjoining room ý
- F4.4 Artificial lighting ý
- F4.5 Ventilation of rooms ý
- F4.6 Natural ventilation ý
- F4.7 Ventilation borrowed from adjoining room ý
- F4.8 Restriction on position of water closets and urinals ý

SUPERCEDED

- F4.9 Airlocks ý
- F4.10 Sub-floor ventilation ý
- F4.11 Public carpark ý

F5 Noise Transmission and Insulation

- F5.1 Application of Part
- F5.2 Sound Transmission Class: Interpretation
- F5.3 Sound insulation of floors between units
- F5.4 Sound insulation of walls between units
- F5.5 Walls between a bathroom, laundry or kitchen and a habitable room in adjoining unit ý
- F5.6 Soil and waste pipes to be separated ý
- F5.7 Isolation of pumps ý

Specifications

- F5.2 STC Ratings for Building Elements ý
- F5.5 Impact Sound - Test of Equivalence ý

Appendices

ACT

- F1.101 Shower and bath enclosures ý
- F3.101 Carparking facilities ý
- F4.101 Level of artificial lighting ý
- F4.102 Artificial lighting of stairways and ramps ý
- F4.103 Flyscreening ý
- Spec F1.1 Stormwater Drainage ý
- Spec F1.7 Shower and Bath Enclosures ý

NSW

- F3.101 Minimum floor areas ý
- F3.102 Increased floor area required ý
- F3.101 Certain floor area to be disregarded ý

Qld

- F1.102 Flashings to narrow spaces ý
- F101 Rodent Protection and Birdproofing ý

SA

- F2.101 Locker and change rooms for employees ý
- F3.101 Sizes of bathrooms and shower rooms ý
- F3.102 Sizes of water closets ý
- F6 Rodent protection ý

SUPERCEDED

SUPERCEDED

Tas

- F2.101 Urinals ý
- F2.102 Building containing earth closet ý
- F2.103 Slop-hoppers ý
- F4.101 Fixed natural ventilation ý

Vic

- F1.7.1 Waterproofing deemed-to-satisfy
- F2.101 First aid rooms
- F3.101 Children's service centres - Size of rooms
- Part F6 Thermal Insulation
- Spec F1.7.1 Waterproofing Deemed-to-Satisfy

OBJECTIVE

A building must be so designed and constructed that the following objectives are fulfilled:

Part F1 Damp and Weatherproofing

Suitable drainage, damp and weatherproofing must be provided where necessary to prevent-

- (a) moisture or damp affecting the stability of the building; and
- (b) the creation of any unhealthy or dangerous condition; and
- (c) undue damage to adjoining property.

Part F2 Sanitary and Other Facilities

Adequate toilet and washing facilities must be provided for the occupants of a building, having regard to its use and size.

Part F3 Room Sizes

The ceiling height of rooms and other spaces within a building must be adequate for their use and purpose.

Part F4 Light and Ventilation

Light and ventilation within a building must be adequate for the occupants, having regard to the use or purpose of the building.

Part F5 Noise Transmission

VIC Part F5

Adequate insulation against noise transmission must be provided to minimise undue disturbance to neighbouring occupants.

SA Part F6

VIC Part F6

PART F1 DAMP AND WEATHERPROOFING

F1.1 Drainage

ACT F1.1

The construction of a drainage system and the position and manner of discharge of a stormwater drain must not-

- (a) result in the entry of water into a building; or
- (b) affect the stability of a building; or
- (c) create any unhealthy or dangerous condition on the *site* or within the building.

F1.2 Building on land subject to dampness

One or more of the following measures must be carried out if it is warranted by the dampness of the building *site*:

- (a) ý The subsoil must be adequately drained.
- (b) ý The ground under the building must be regraded or filled and provided with outlets to prevent accumulation of water.
- (c) ý The surface of the ground under the building must be covered with a suitable damp-resisting material.

F1.3 Drainage of land surrounding buildings

A suitable system of drainage must be provided if paving, excavation or any other work on an allotment will cause undue interference with the existing drainage of rainwater falling on the allotment whether the existing drainage is natural or otherwise.

F1.4 Weatherproofing of roofs and walls

Roofs and *external walls* (including openings around *windows* and doors) must be so constructed as to prevent rain or dampness penetrating to the inner parts of a building, unless it is-

- (a) ý a Class 7, 8 or 10 building and in the particular case there is no necessity for compliance; or
- (b) ý a garage, tool shed, *sanitary compartment*, or the like, forming part of a building used for other purposes; or
- (c) ý *an open spectator stand or open-deck carpark.*

F1.5 Roof coverings deemed-to-satisfy

A roof complies with F1.4 if it is covered with-

- (a) ý concrete roofing tiles that comply with AS 1757 and are fixed, except in cyclonic areas, in accordance with AS 2050, as appropriate; or
- (b) ý terracotta roofing tiles that comply with AS 2049 and are fixed, except in cyclonic areas, in accordance with AS 2050; or
- (c) ý corrugated cellulose fibre reinforced cement sheeting that complies with AS 2908 and installed in accordance with AS 1639; or
- (d) ý metal sheet roofing without transverse laps that complies with AS 1562; or
- (e) ý plastic sheet roofing designed and installed in accordance with AS 2376 and AS 2424.

TAS F1.5(f)

F1.6 Pliable roof sarking

Pliable roof sarking used under roof or wall coverings must comply and be fixed in accordance with-

- (a) ý AS 1736; or
- (b) ý AS 1903 and AS 1904.

F1.7 Water proofing of wet areas in buildings

QLD F1.7

SA F1.7

The following parts of a building must be impervious to water: ý

SUPERCEDED

- (a) ý In any building - the floor surface or substrate in a shower enclosure, or within 1.5 m measured horizontally from a point vertically below the shower fitting, if there is no enclosure.
- (b) ý In a Class 3, 5, 6, 7, 8 or 9 building - the floor surface or substrate in a bathroom or shower room, slop hopper or sink compartment, laundry or *sanitary compartment* which is used in common by the occupants.
- (c) ý In a Class 1, 2 or 3 building or Class 4 part - the floor of those rooms fitted with a floor waste in accordance with F1.11.
- (d) ý The wall surface or substrate-
 - (i) ý of a shower enclosure, or if the shower is not enclosed, within 1.5 m and exposed to a shower fitting, to a height of 1.8 m above the floor; and
 - (ii) ý immediately adjacent or behind a bath, trough, basin, sink, or similar fixture, to a height of 300 mm above the fixture if it is within 75 mm of the wall.
- (e) ý The junction between the floor and wall if the wall and floor are *required* to be impervious to water.
- (f) ý The junction between the wall and fixture if the wall is *required* to be impervious to water.

VIC F1.7.1

F1.8 Damp-proof courses and mortars ý

SA F1.8

Except in a building that is exempt from weatherproofing under F1.4, moisture from the ground must be prevented from reaching-

- (a) the lowest floor timbers and the walls above the lowest floor joists; and
- (b) the walls above the damp-proof course; and
- (c) the underside of a suspended floor constructed of a material other than timber, and the supporting beams or girders.

F1.9 Acceptable damp-proof courses

SA F1.9

A damp-proof course must consist of-

- (a) ý a material that complies with AS 2904; or

NSW F1.9(b)

- (b) ý suitable termite shields placed on piers; or
- (c) ý other suitable material.

F1.10 Damp-proofing of floors on the ground

If a floor of a room is laid on the ground or on fill-

- (a) ý moisture from the ground must be prevented from reaching the upper surface of the floor and adjacent walls by-

SA F1.10(a)(i)

- (i) ý the insertion of a vapour barrier in accordance with AS 2870.1; or
 - (ii) ý other suitable means; except
- (b) ý damp-proofing need not be provided if-

SUPERCEDED

- (i) ý the building is exempt from weatherproofing under F1.4; or
- (ii) ý the floor is the base of a stair, lift or similar *shaft* which is adequately drained by gravitation or mechanical means.

F1.11 Provision of floor wastes

QLD F1.11

- (a) ý In a Class 1, 2 or 3 building or Class 4 part, a floor waste or floor waste gully must be provided in any of the following rooms where that room is located above another *sole-occupancy unit*:
 - (i) A room containing a closet pan.
 - (ii) A bathroom.
 - (iii) A laundry.
- (b) ý The draining of the floor to a shower recess incorporating a floor waste satisfies the requirement of (a).

ACT F1.101, Spec F1.1

QLD F1.102

PARTF2 SANITARY AND OTHER FACILITIES

F2.1 Facilities in residential buildings

Sanitary and other facilities for Class 1, 2 and 3 buildings and for Class 4 parts of buildings must be provided in accordance with Table F2.1.

ACT Table F2.1(Class 3)

SA Table F2.1(Class 3)

VIC Table F2.1(Class 1)

Table F2.1 PROVISION OF SANITARY AND OTHER FACILITIES IN RESIDENTIAL BUILDINGS

CLASS OF BUILDING	MINIMUM FACILITIES REQUIRED
Class 1	(a) a kitchen sink and facilities for the preparation and cooking of food; (b) ý a bath or shower; (c) ý clothes washing facilities, comprising at least one washtub and space in the same room for a washing machine or wash copper; and (d) ý a closet pan and washbasin If any of these facilities are detached from the main building, they must be set aside for the exclusive use of the occupants of the Class 1 building.

SUPERCEDED

Class 2 ý	<p>Within each <i>sole-occupancy unit</i>-</p> <ul style="list-style-type: none">(a) ý a kitchen sink and facilities for the preparation and cooking of food;(b) ý a bath or shower; and(c) a closet pan and washbasin; and <p>For each building-</p> <ul style="list-style-type: none">(a) ý a separate laundry for each 4 <i>sole-occupancy units</i>, or part, without its own clothes washing facilities comprising at least one washtub and space for a washing machine or wash copper;(b) ý clothes drying facilities comprising-<ul style="list-style-type: none">(i) ý clothes lines or hoists with not less than 7.5 m of line per <i>sole-occupancy unit</i>; or(ii) ý one heat-operated drying cabinet or appliance for each 4 <i>sole-occupancy units</i>, or part, without its own drying facilities; and <p>Facilities for employees-</p> <p>if the building contains more than 10 <i>sole-occupancy-units</i>, or a group of Class 2 buildings on the one allotment contains, in total, more than 10 <i>sole-occupancy units</i> - a closet pan and washbasin in a compartment or room at or near ground level and accessible to employees without entering a <i>sole-occupancy unit</i>.</p>
------------------	--

Class 3 ý	<p>Facilities for residents-</p> <p>For each building or group of buildings-</p> <ul style="list-style-type: none">(a) ý a bath or shower; and(b) ý a closet pan and washbasin, <p>For each 10 residents for whom private facilities are not provided, except that-</p> <ul style="list-style-type: none">(c) ý if one urinal is provided for each 25 males up to 50 and one additional urinal for each additional 50 males or parts thereof, <p>one closet pan for each 12 males may be provided.</p> <p>Facilities for employees - see Clause F2.3. ý</p> <p>Note: These facilities need not be situated within the building. ý</p>
------------------	--

Class 4 ý	<p>For each <i>sole-occupancy unit</i>-</p> <ul style="list-style-type: none">(a) ý a kitchen sink and facilities for the preparation and cooking of food;(b) ý a bath or shower;(c) ý a closet pan and washbasin;(d) ý clothes washing facilities, comprising a washtub and space in the same room for a washing machine or wash copper; and(e) ý a clothes line or hoist, or space for a heat-operated drying cabinet or similar appliance for the exclusive use of the occupants.
------------------	--

F2.2 ý **Calculation of number of occupants and fixtures**

- (a) ý The number of persons accommodated must be calculated according to D1.13 if it cannot be more accurately determined by other means.
- (b) ý Unless the premises are used predominantly by one sex, sanitary facilities must be provided on the basis of equal numbers of males and females.

F2.3 ý **Facilities in Class 3 to 9 buildings**

- (a) ý Sanitary facilities must be provided in Class 3, 5, 6, 7, 8 and 9 buildings in accordance with Table F2.3.
- (b) ý A *health care building* must be provided with-

SUPERCEDED

- (i) one kitchen or other suitable facility for the preparation and cooking or reheating of food including a kitchen sink and washbasin; and
 - (ii) laundry facilities for the cleansing and drying of linen and clothing or suitable facilities for holding and dispatch or treatment of soiled linen and clothing, sanitary towels and the like and the receipt and storage of clean linen.
- (c) An *early childhood centre* must be provided with-
- (i) one kitchen with facilities for preparation of and cooking food for infants including a kitchen sink and space for a refrigerator; and
 - (ii) if the centre accommodates children younger than 2 years old, a laundry facility comprising a washtub and space in the same room for a washing machine or wash copper.

SA Table F2.3

VIC Table F2.3

Table F2.3 SANITARY FACILITIES IN CLASS 3, 5, 6, 7, 8 AND 9 BUILDINGS										
Class of Building	User	Max Number Served by-								
		Closet Fixture(s)			Urinal(s)			Washbasin(s)		
		1	2	Each Extra	1	2	Each Extra	1	2	Each Extra
3,5,6 and 9 other than schools	Employees									
	Males	20	40	20	25	50	50	30	60	30
	Females	15	30	15				30	60	30
7 and 8	Employees									
	Males	20	40	20	25	50	50	20	40	20
	Females	15	30	15				20	40	20
6-Department stores, shopping centres	Patrons									
	Males	1200	2400	1200	600	1200	1200	600	1200	1200
	Females	300	600	1200				600	1200	1200
6-Restaurants cafes, bars	Patrons									
	Males	100	300	200	50	100	*50	50	200	200
	Females	25	50	**50				50	150	200
* Where the number of male patrons exceeds 250, not less than 5 urinals must be provided plus one additional urinal for every additional 100 males in excess of 250										
** Where the number of female patrons exceeds 250, not less than 6 closet fixtures must be provided plus one additional closet fixture for every 100 females in excess of 250										
9a- Health-care buildings	Patients-									
	Males	-	16	8				8	16	8
	Females	-	16	8				8	16	8
- Other facilities	(i)	One shower for each 8, or part, patients or inmates.								
	(ii)	One island-type plunge bath in each <i>storey</i> containing a <i>patient care area</i>								

SUPERCEDED

9b - <i>Schools</i> √	Employees-									
	Males	20	40	20	20	45	30	30	60	30
	Females	5	20	15				30	60	30
	Students-									
	Males	30	70	70	30	70	35	20	40	40
	Females	10	20	20				20	40	40
9b- <i>Early childhood centres</i>	Children-		30	15					30	15
Other facilities √	(a) One bath or shower-bath must be provided									
	(b) √ If the centre accommodates children under 2 years of age a bench type baby bath must be provided									
9b- Sporting venues, theatres, cinemas, art galleries or the like	Participants									
	Males	20	40	20	10	20	10	10	20	10
	Females	10	20	10				10	20	10
Other facilities √	One shower for each 10, or part, participants.									
	Spectators √ or patrons √									
	Males	250	500	500	100	200	100	150	300	150
	Females	75	150	75				150	300	150
9b- Churches, √ chapels or the like √	Patrons									
	Males	300	800	500	200	400	200	250	500	250
	Females	150	300	150				250	500	250
9b- Public halls, function rooms, or the like	Patrons									
	Males	100	300	200	50	100	*50	50	200	200
	Females √	25	50	**50				50	150	200
* √	Where the number of male patrons exceeds 250, not less than 5 urinals must be provided plus one additional urinal for every additional 100 males in excess of 250.									
** √	Where the number of female patrons exceeds 250, not less than 6 closet fixtures must be provided plus one additional closet fixture for every 100 females in excess of 250.									

Notes:

Urinals - a urinal need not be provided if the number of males employed is less than 10.

Unisex facility - Instead of separate facilities for each sex, if not more than 10 persons are employed, a unisex facility may be provided comprising one closet pan, one washbasin and means for the disposal of sanitary towels;

Combined facilities - if the majority of employees are of one sex, not more than 2 employees of the other sex may share toilet facilities if -

(a) √ facilities for females include adequate means for the disposal of sanitary towels; and

(b) √ the facilities are separated by means of walls, partitions and doors to afford privacy.

Use of public facilities - sanitary facilities for employees need not be separate from those *required* for public use in a Class 6 or 9b building, other than a *school* or *early childhood centre*.

Sanitary facilities for public - sanitary facilities need not be provided for the public in -

(i) √ a Class 6 building used as department store or shopping centre if the building accommodates less than 600 persons; or

(ii) √ a Class 6 building used as restaurant, cafe, bar, public hall, function room or the like if the building accommodates not more than 20 persons; or

SUPERCEDED

SUPERCEDED

(iii) \dot{y} a Class 9b building used as a sporting venue, theatre, cinema, museum, art gallery or the like if the number of spectators or patrons is not more than 100.

For females - adequate means of disposal of sanitary towels must be provided.

Health-care buildings - in *patient care areas* where each area is provided with its own facilities - closet pans, washbasins and showers as set out in Table F2.3 need not be provided.

F2.4 Facilities for people with disabilities \dot{y}

WA F2.4

(a) \dot{y} Sanitary facilities must be provided in accordance with Table F2.4 in every Class 3, 5, 6, 7, 8 and 9 building that is *required* by Part D3 to be accessible to people with disabilities.

(b) \dot{y} The construction and layout of all facilities provided in accordance with Table F2.4 must comply with AS 1428.1.

NSW TABLE F2.4

SA TABLE F2.4

Table F2.4 SANITARY FACILITIES FOR PEOPLE WITH DISABILITIES \dot{y}

CLASS OF BUILDING	MINIMUM FACILITY FOR USE BY PEOPLE WITH DISABILITIES
Class 3 - In every <i>sole-occupancy unit</i> to which access for people with disabilities is <i>required</i> -	
(a) \dot{y} one closet pan and washbasin; and	
(b) \dot{y} one shower.	
Class 5, 6, 7, 8 and 9 buildings with <i>floor area</i> more than 500 m ² and	
Class 3 if accommodation is other than in <i>sole-occupancy units</i> or other parts of the building are <i>required</i> to be accessible-	
FACILITIES REQUIRED BY F2.3	MINIMUM NUMBER FOR USE BY PEOPLE WITH DISABILITIES
Closet pans plus urinals-	
1 - 100	(a) one unisex facility; or (b) one closet pan and washbasin for each sex.
101 - 200	(a) 2 unisex facilities; or (b) one closet pan and washbasin for each sex and one unisex facility
More than 200	(a) 2 unisex facilities or one closet pan and washbasin for each sex and one unisex facility; and (b) one additional unisex facility or one closet pan and washbasin for each sex for each additional 100 facilities normally <i>required</i> .
Adequate facilities for the disposal of sanitary towels must be provided	
Baths or showers	one shower or shower-bath for each 10 or part, but not less than one for use by both sexes.

F2.5 Construction of sanitary compartments

(a) \dot{y} Partitions - Other than in an *early childhood centre*, *sanitary compartments* must have doors and partitions that must separate adjacent compartments and extend-

(i) \dot{y} from floor level to the ceiling in the case of a unisex facility; or

(ii) \dot{y} to a height of not less than 1500 mm above the floor if primary *school* children are the principal users; or

(iii) \dot{y} 1800 mm above the floor in all other cases.

WA F2.5(b),(c)

(b) * * * * * \dot{y}

QLD F2.5(c),(d)

VIC F2.5(c)

F2.6 Interpretation: Urinals and washbasins

- (a) ý A urinal may be-
- (i) ý an individual stall or wall-hung urinal;
 - (ii) each 600 mm length of a continuous urinal trough; or
 - (iii) ý a closet pan used in place of a urinal.
- (b) ý A washbasin may be-
- (i) ý an individual basin; or
 - (ii) ý a part of a hand washing trough served by a single water tap.

F2.7 Warm Water Installations

NSW F2.7

Warm water installations in nursing homes, institutions and health care buildings etc., must be installed in accordance with AS 3666.

TAS F2.101 to F2.103

SA F2.101

VIC F2.101

PART F3 ROOM SIZES ý

F3.1 Height of rooms ý

VIC F3.1

Minimum ceiling heights are:

- (a) ý Class 1, 2, or 3 buildings, or Class 4 parts-
- (i) ý *habitable room* excluding a kitchen - 2.4 m;
 - (ii) ý kitchen, laundry, or the like - 2.1 m;
 - (iii) ý corridor or passageway - 2.1 m.
- (b) ý Class 5, 6, 7 and 8 buildings -
- (i) ý generally, except as allowed in (a), (b)(ii) and (e), - 2.4 m;
 - (ii) ý corridor, passageway, or the like - 2.1 m.
- (c) ý Class 9a buildings-
- (i) ý *patient care area* - 2.4 m;
 - (ii) ý operating theatre or delivery room - 3.0 m;
 - (iii) ý treatment room, clinic, waiting room, passageway, corridor, or the like - 2.4 m.
- (d) ý Class 9b buildings-
- (i) ý *school* classroom or other *assembly building* or part that accommodates not more than 100 persons - 2.4 m;
 - (ii) ý theatre, public hall or other *assembly building* or part that accommodates more than 100 persons - 2.7 m.
- (e) ý Ancillary and other spaces-

- (i) ý bathroom, shower room, water closet, toilet room, airlock, tea preparation room, pantry, store room, garage, carparking area, or the like, in any building - 2.1 m;
- (ii) ý commercial kitchens - 2.4 m.

F3.2 Reduced height permissible

ACT F3.2

These heights may be reduced if the reduction does not unduly interfere with the proper functioning of the room in-

- (a) attic rooms; or
- (b) rooms with a sloping ceiling or projection below ceiling line; or
- (c) other non-*habitable rooms* or spaces.

NSW F3.101 to F3.103

ACT F3.101

SA F3.101, F3.102

VIC F3.101

PART F4 LIGHT AND VENTILATION

F4.1 Provision of natural light

Natural lighting must be provided in:

- (a) ý **Class 1 and 2 buildings and Class 4 parts** - to all *habitable rooms*.
- (b) ý **Class 3 buildings** - to all bedrooms and dormitories.
- (c) ý **Class 9a buildings** - to all rooms used for sleeping purposes.

VIC F4.1(d)

- (d) ý **Class 9b buildings** - to all general purpose classrooms in primary or secondary *schools* and all playrooms or the like or the use of children in an *early childhood centre*.

F4.2 Methods and extent of natural lighting

Direct natural lighting must be provided by *windows* that-

- (a) ý have an aggregate light transmitting area measured excluding framing members, glazing bars or other obstructions of not less than 10% of the *floor area* of the room; and
- (b) ý face a court or other space open to the sky or an open verandah, *open garage* or the like; and
- (c) ý in a Class 1 building, are in a wall not less than a horizontal distance of 1 m from any boundary of an adjoining allotment that they face; and
- (d) ý are not less than a horizontal distance from any adjoining allotment or a wall of the same building or another building on the allotment that they face, that is the greater of-
 - (i) ý in a Class 2, 3 or 9 building or a Class 4 part - 1 m; and
 - (ii) ý in a *patient care area* or other room used for sleeping purposes in a Class 9a building - 3 m; and

- (iii) 50% of the square root of the exterior height of the wall in which the *window* is located, measured in metres from its sill.

SA F4.2(e)

F4.3 Natural light borrowed from adjoining room

Natural lighting to a room in a Class 1 or 2 building or a Class 4 part or in a *sole-occupancy unit* of a Class 3 building, may come through a glazed panel or opening from an adjoining room (including an enclosed verandah) if-

- (a) \hat{y} in a Class 2 or 3 building or a Class 4 part, both rooms are within the same *sole-occupancy unit* or the enclosed verandah is on common property; and
- (b) \hat{y} the glazed panel or opening has an area of not less than 10% of the *floor area* of the room to which it provides light; and
- (c) \hat{y} the adjoining room has *windows* with an aggregate light transmitting area of not less than 10% of the combined *floor areas* of both rooms,

and the areas specified in (b) and (c) may be reduced as appropriate if direct natural light is provided from another source.

F4.4 Artificial lighting

Artificial lighting must be provided-

- (a) \hat{y} in *required* stairways, passageways, and ramps by means of separate electrical wiring circuits from the main switchboard for the exclusive use of the stairway or ramp; and
- (b) \hat{y} if natural lighting *required* by F4.2 is not available.

NSW F4.4(c)

WA F4.4(c)

F4.5 Ventilation of rooms

- (a) \hat{y} A *habitable room*, office, shop, factory, workroom, *sanitary compartment*, bathroom, shower room, laundry and any other room occupied by a person for any purpose must have adequate flow-through or cross-ventilation and air quality, including sufficient air-changes and fresh air quantities.

- (b) \hat{y} Provision of either-

- (i) \hat{y} natural ventilation complying with F4.6; or

NSW F4.5(b)(ii)

- (ii) \hat{y} a mechanical ventilation or air-conditioning system complying with AS 1668.2 and AS 3666

satisfies (a).

VIC F4.5(b)(iii)

ACT F4.5(c)

F4.6 Natural ventilation

Required natural ventilation must be provided by permanent *windows*, openings, doors or other devices which can be opened-

- (a) with an aggregate opening or openable size not less than 5% of the *floor area* of the room *required* to be ventilated; and
- (b) open to-

NSW F4.6(b)(i)

- (i) ý a court, or space open to the sky; or
- (ii) ý an open verandah, *open garage*, or the like.

F4.7 Ventilation borrowed from adjoining room

Natural ventilation to a room may come through a *window*, opening, ventilating door or other device from an adjoining room (including an enclosed verandah) if both rooms are within the same *sole-occupancy unit* or the enclosed verandah is common property, and-

- (a) ý in a Class 1 or 2 building, a *sole-occupancy unit* of a Class 3 building or a Class 4 part of a building-
 - (i) ý the room to be ventilated is not a *sanitary compartment*; and
 - (ii) ý the *window*, opening, door or other device has a ventilating area of not less than 5% of the *floor area* of the room to be ventilated; and
 - (iii) ý the adjoining room has a *window*, opening, door or other device with a ventilating area of not less than 5% of the combined *floor areas* of both rooms; and
- (b) ý in a Class 5, 6, 7, 8 or 9 building-
 - (i) ý the *window*, opening, door or other device has a ventilating area of not less than 10% of the *floor area* of the room to be ventilated, measured not more than 3.6 m above the floor; and
 - (ii) ý the adjoining room has a *window*, opening, door or other device with a ventilating area of not less than 10% of the combined *floor areas* of both rooms; and
- (c) ý the ventilating areas specified in (a) and (b) may be reduced as appropriate if direct natural ventilation is provided from another source.

F4.8 Restriction on position of water closets and urinals

A room containing a closet pan or urinal must not open directly into-

- (a) ý a kitchen or pantry; or
- (b) ý a public dining room or restaurant; or
- (c) ý a dormitory in a Class 3 building; or

VIC F4.8(d)

- (d) ý a room used for public assembly; or
- (e) ý a workplace normally occupied by more than one person.

F4.9 Airlocks

If a room containing a closet pan or urinal is prohibited under F4.8 from opening directly to another room-

- (a) ý in a Class 1 building, a *sole-occupancy unit* in a Class 2 or 3 building or in a Class 4 part-
 - (i) ý access must be by an airlock, hallway or other room; or
 - (ii) ý the room containing the closet pan or urinal must be provided with mechanical exhaust ventilation; and

- (b) ý in a Class 5, 6, 7, 8 or 9 building (which is not an *early childhood centre*, *primary school* or *open spectator stand*)-
- (i) ý access must be by an airlock, hallway or other room with a *floor area* of not less than 1.1 m² and fitted with *self-closing* doors at all access doorways; or
 - (ii) ý the room containing the closet pan or urinal must be provided with mechanical exhaust ventilation and the doorway to the room adequately screened from view.

F4.10 Sub-floor ventilation

TAS F4.10

- (a) ý Suitable provision must be made to prevent undue deterioration of the lowest floor of a building because of dampness, other conditions on the allotment or the design of the building.
- (b) ý The requirements of (a) are satisfied if-

ACT F4.10(b)(i)

NSW F4.10(b)(i)

VIC F4.10(b)(i)

- (i) an adequately cross-ventilated space is provided between the underside of the floor, if it suspended, and the ground surface; or
- (ii) an impervious cover is provided over the ground surface beneath the building; or
- (iii) the floor members are suitably treated.

F4.11 Public carparks

Every storey of a *public carpark*, except an *open-deck carpark*, must have-

- (a) a system of ventilation complying with AS 1668.2; or
- (b) a suitable system of permanent natural ventilation.

ACT F4.11(c)

ACT F4.101 to F4.104

TAS F4.101

WA F4.12

PART F5 NOISE TRANSMISSION AND INSULATION ý

VIC Part F5

F5.1 Application of Part ý

ACT F5.1

QLD F5.1

This Part applies to all Class 2 and Class 3 buildings.

F5.2 Sound Transmission Class: Interpretation

A form of construction *required* to have a certain Sound Transmission Class (STC) must-

- (a) ý have the *required* value determined under AS 1276; or
- (b) ý comply with Specification F5.2; or

(c) \dot{y} be supported by evidence of its STC under A2.2.

F5.3 \dot{y} Sound insulation of floors between units

WA F5.3

A floor separating *sole-occupancy units* must have an STC not less than 45.

F5.4 \dot{y} Sound insulation of walls between units

A wall must have an STC not less than 45 if it separates-

- (a) \dot{y} *sole-occupancy units* ; or
- (b) \dot{y} a *sole-occupancy unit* from a plant room, lift *shaft*, stairway, *public corridor*, hallway or the like.

F5.5 \dot{y} Walls between a bathroom, laundry or kitchen and a habitable room in adjoining unit

- (a) \dot{y} A wall separating a bathroom, laundry or kitchen in one *sole-occupancy unit* from a *habitable room* (other than a kitchen) in an adjoining unit must-
 - (i) \dot{y} have an STC of not less than 50;
 - (ii) \dot{y} provide a satisfactory level of *insulation* against impact sound; and
 - (iii) \dot{y} not incorporate a duct which reduces the STC of the wall to less than 50.
- (b) \dot{y} A wall satisfies (a)(i) and (a)(ii) if it is-
 - (i) \dot{y} in accordance with Table F5.5;
 - (ii) \dot{y} for other than masonry, in 2 or more separate leaves without rigid mechanical connection except at their periphery; or
 - (iii) \dot{y} identical with a prototype that is no less resistant to the transmission of impact sound when tested in accordance with Specification F5.5 than a wall listed in Table F5.5.

Table F5.5 CONSTRUCTION OF WALLS TO REDUCE IMPACT SOUND \dot{y}

CAVITY BRICKWORK-

Two leaves 90 mm brick masonry with-

- (i) all joints filled solid with mortar;
 - (ii) an air space not less than 40 mm between the leaves; and
 - (iii) the leaves connected only by ties in accordance with AS 3700.
-

SINGLE LEAF BRICKWORK

110 mm thick brick masonry with-

- (i) each face rendered 13 mm thick;
 - (ii) 50 mm x 12 mm thick timber battens at not more than 610 mm centres fixed to each face but not recessed into the render;
 - (iii) one layer of 12 mm thick softboard nailed to the battens; and
 - (iv) 6 mm thick medium density hardboard adhesive-fixed to the softboard.
-

CONCRETE BLOCKWORK-

190 mm thick concrete block masonry with-

- (i) \dot{y} each face of the blocks fitted with 50 mm x 50 mm timber battens, spaced at not more than 610 mm centres, screw-fixed into resilient plugs with rubber inserts;

- (ii) $\dot{\gamma}$ the space between the battens completely filled with mineral or glass wool blanket or batts not less than 50 mm thick; and
- (iii) $\dot{\gamma}$ the outer face of the battens finished with plasterboard not less than 10 mm thick or other material with a mass per unit area not less than 7.3 kg/m^2 .

F5.6 Soil and waste pipes to be separated

If a soil or waste pipe, including a pipe that is embedded in or passes through a floor, serves or passes through more than one *sole-occupancy unit*-

- (a) $\dot{\gamma}$ the pipe must be separated from the rooms of any *sole-occupancy unit* by construction with an STC not less than-
 - (i) $\dot{\gamma}$ 45 if the adjacent room is a *habitable room* (other than a kitchen);
 - (ii) $\dot{\gamma}$ 30 if the adjacent room is a kitchen or any other room; and
- (b) $\dot{\gamma}$ a door or panel providing access to the pipe must not open into any *habitable room* (other than a kitchen); and
- (c) $\dot{\gamma}$ an access door or panel in any other part must be firmly fixed so as to overlap the frame or rebate of the frame by not less than 10 mm, be fitted with a sealing gasket along all edges and constructed of-
 - (i) $\dot{\gamma}$ wood, particleboard or blockboard not less than 38 mm thick; or
 - (ii) $\dot{\gamma}$ compressed fibre reinforced cement sheeting not less than 9 mm thick; or
 - (iii) $\dot{\gamma}$ other suitable material with a mass per unit area not less than 24.4 kg/m^2 .

F5.7 Isolation of pumps

A flexible coupling must be used at the point of connection between the service pipes in a building and any circulating or other pump.

QLD F101

SA F6.101

VIC Part F6

SPECIFICATION F5.2 $\dot{\gamma}$ STC RATINGS FOR BUILDING ELEMENTS

1. $\dot{\gamma}$ Scope

This Specification lists the Sound Transmission Class ratings for some common forms of construction.

2. $\dot{\gamma}$ Construction deemed-to-satisfy

The forms of construction listed in Table 2 are considered to have the STC stated in that Table if installed as follows:

- (a) $\dot{\gamma}$ **Masonry** - Units must be laid with all joints filled solid, including those between the masonry and any adjoining construction.
- (b) $\dot{\gamma}$ **Concrete slabs** - Joints between concrete slabs and any adjoining construction must be filled solid.
- (c) $\dot{\gamma}$ **Plasterboard** -
 - (i) $\dot{\gamma}$ if one layer is *required* under this Specification, it must be screw-fixed to the studs with joints staggered on opposite faces;

SUPERCEDED

- (ii) if 2 layers are *required*, the first layer must be fixed according to (i) and the second layer must be fixed to the first layer with nails, screws or adhesive so that the joints do not coincide with those of the first layer;
 - (iii) joints between sheets or between sheets and any adjoining construction must be taped and filled solid; and
 - (iv) fire-protective grade plasterboard must be the special grade manufactured for use in *fire-resisting construction*.
- (d) **Steel studs and perimeter members** -
- (i) the section of steel must be not less than 0.6 mm thick;
 - (ii) studs must be not less than 63 mm in depth unless another depth is listed in the Table;
 - (iii) studs must be fixed to steel top and bottom plates of sufficient depth to permit secure fixing of the plasterboard; and
 - (iv) all steel members at the perimeter of the wall must be securely fixed to the adjoining structure and bedded in resilient compound or the joints must be caulked so that there are no voids between the steel members and the wall.

CONSTRUCTION	STC (not less than)
WALLS	
Clay brickwork-	
(a) 230 mm thick in one or more leaves and with a mass per unit area of not less than 290 kg/m ²	45
(b) 110 mm thick rendered 13 mm thick on both sides with a mass per unit area of the unrendered wall being not less than 190 kg/m ²	45
(c) 110 mm thick, of semi-dry-pressed bricks and rendered 13 mm on one side, the mass per unit area of the unrendered wall being not less than 215 kg/m ²	45
(d) 110 mm thick, of extruded brick and rendered 13 mm on one side, the mass per unit area of the unrendered wall being not less than 180 kg/m ²	45
Concrete brickwork- 110 mm thick with a mass per unit area of not less than 195 kg/m ²	45
Concrete blockwork-	
(a) 190 mm thick with a mass per unit area of not less than 215 kg/m ²	45
(b) 140 mm thick, the wall thickness of the blocks being not less than 44 mm and with -	
(i) 50 mm x 50 mm timber battens spaced at not more than 610 mm centres screw-fixed on one face of the blocks into resilient plugs with rubber inserts between battens and the wall;	
(ii) the face of the battens clad with 13 mm thick standard plasterboard; and	
(iii) a mass per unit area of the whole system of not less than 220 kg/m ²	45
Concrete-	
(a) In-situ concrete- 125 mm thick and with a density of not less than 2200 kg/m ³	45
(b) In-situ concrete- 100 mm thick and with a density of not less than 2500 kg/m ³	45
(c) Precast concrete- 100 mm thick and without joints:	45
Steel stud walling-	
(a) with 2 layers of 16 mm thick fire-protective grade plasterboard fixed to each face:	45

SUPERCEDED

(b) ý with-	
(i) ý 1 layer of 13 mm thick fire-protective grade plasterboard fixed to one face, and before fixing, 50 mm thick mineral or glass wool blanket or batts stapled to the back of each sheet so that the sheet is completely covered; and	
(ii) ý 2 layers of 13 mm thick fire-grade plasterboard fixed to the other face:	45
(c) ý with-	
(i) ý 1 layer of 16 mm fire-protective grade plasterboard fixed to one face;	
(ii) ý 50 mm thick mineral or glass wool blanket or batts wedged firmly between the studs; and	
(iii) ý 2 layers of fire-protective grade plasterboard fixed to the other face, the inner layer being 16 mm thick and the outer layer being 13 mm	45
(d) ý with 2 layers of 13 mm plasterboard on both sides of 75 mm studs	45
<hr/>	
FLOORS-	
Concrete-	
(a) ý In-situ concrete slab- 125 mm thick and with a density of not less than 2200 kg/m ³	45
(b) ý in-situ concrete slab- 100 mm thick and with a density of not less than 2500 kg/m ³	45
(c) Pre-cast concrete slab- 100 mm thick and without joints	45
Timber - comprising-	
(a) ý timber joists not less than 175 mm x 50 mm;	
(b) ý 75 mm thick mineral or glass wool blanket or batts cut to fit tightly between joists and laid on 10 mm thick plasterboard fixed to underside of joists;	
(c) ý 25 mm thick mineral or glass wool blanket or batts laid over entire floor, including tops of joists before flooring is laid; and	
(d) ý tongued-and-grooved boards not less than 19 mm thick, secured to 75 mm x 50 mm battens; and	
(e) ý the assembled flooring laid over the joists, but not fixed to them, with the battens lying between the joists	45
<hr/>	
DUCTS OR OTHER CONSTRUCTION SEPARATING SOIL AND WASTE PIPES FROM UNITS	
Masonry- not less than 90 mm thick	30
Plasterboard- 2 layers of plasterboard-	
(a) ý each 10 mm thick, fixed to timber studs not less than 75 mm x 50 mm and spaced at not more than 400 mm centres	30
(b) ý each 13 mm thick, one on each side of steel studs not less than 50 mm deep and spaced at not more than 400 mm centres	30
<hr/>	

SPECIFICATION F5.5 ý **IMPACT SOUND - TEST OF EQUIVALENCE**

1. ý **Scope**

This specification describes a method of test to determine the comparative resistance of walls to the transmission of impact sound.

2. ý **Construction to be tested**

(a) ý The test is conducted on a specimen of prototype wall construction and on a specimen of one or other of the constructions specified in Table F5.5.

- (b) ý The testing of a construction specified in Table F5.5 need not be repeated for subsequent comparisons provided complete records of the results, the test equipment and the technique of testing are kept so that identical equipment can be employed and an identical technique can be adopted in the testing of specimens of prototype wall construction.

3. ý Method

- (a) ý The wall constructions to be compared must be tested in a laboratory complying with AS 1191.
- (b) ý A horizontal steel platform 510 mm x 460 mm x 10 mm thick must be placed with one long edge in continuous and direct contact with the wall to be tested on the side of the wall on which the impact sound is to be generated.
- (c) ý A tapping machine complying with ISO 140/VI-1978 (E) must be mounted centrally on the steel platform.
- (d) ý The sound transmission through the wall must be determined in accordance with AS 1191 except that the tapping machine as mounted on the steel platform must be used as the source of sound.
- (e) ý The impact sound pressure levels measured in the receiving room must be converted into normalized levels using a reference equivalent absorption area of 10 m².

SECTION G ANCILLARY PROVISIONS

CONTENTS

G1 Minor Structures and Components

- G1.1 Swimming pools
- G1.2 Refrigerated chambers, strong-rooms and vaults
- G1.3 Access to household-type hot water supply systems

G2 Heating Appliances, Fireplaces, Chimneys and Flues

- G2.1 General requirements
- G2.2 Installation of appliances
- G2.3 Open fireplaces deemed-to-satisfy
- G2.4 Incinerator rooms

G3 Atrium Construction

- G3.1 Atriums affected by this Part
- G3.2 Dimensions of atrium well
- G3.3 Separation of atrium by bounding walls
- G3.4 Construction of bounding walls
- G3.5 Construction at balconies
- G3.6 Separation at roof
- G3.7 Means of egress from atriums
- G3.8 Fire and smoke control systems in buildings containing atriums

G4 Construction in Alpine Areas

- G4.1 Application of Part
- G4.2 Walls bounding or separating units
- G4.3 External doorways
- G4.4 Emergency lighting
- G4.5 External ramps
- G4.6 Discharge of exits
- G4.7 External trafficable structures
- G4.8 Fire-fighting services and equipment
- G4.9 Fire orders

G5 Construction in Bushfire Prone Areas

- No Provisions y

Specifications ý

G3.8 Fire and Smoke Control Systems in Buildings containing Atriums

Appendices

ACT

G1.101 Dividing fences
G1.102 Flammable liquid stores
G1.103 Awning and projections
G1.104 Garbage facilities
G2.101 Boilers
G2.102 Chimneys and flues

Qld

Part G101 Awnings and Balconies
Part G102 Certain Attachments

SA

Part G5 Construction in Bushfire Risk Areas
Part G6 Dangerous Substances Storerooms
Part G7 Access for Maintenance
Part G8 Miscellaneous Provisions

Tas

Part G101 Projections Over Ways

Vic

G1.101 Children's services centres - Outdoor play space

OBJECTIVE

This Section contains more specific requirements for particular parts of buildings or structures.

Parts of buildings and structures must be so designed and constructed that the following objectives, in addition to those listed for Sections B, C, D, E and F where relevant, are fulfilled:

Part G1 Minor Structures and Components

G1.1 Swimming Pools

- (a) Suitable means for the disposal of water and drainage must be provided to a *swimming pool*.
- (b) Access by unsupervised young children to *swimming pools* must be restricted.

TAS G1.1(c)

G1.2 Refrigerated chambers, strong rooms and vaults

TAS G1.2

Refrigerated, cooling chambers, strong rooms and vaults or the like, that are capable of accommodating a person must have adequate safety measures to facilitate escape and for alerting persons outside the chamber or vault in the event of an emergency.

G1.3 Household-type water heaters

Household-type hot water systems must be adequately supported, able to be drained and be accessible.

Part G2 Heating Appliances, Fireplaces, Chimneys and Flues

Heating appliances, fireplaces, chimneys and flues must be adequately constructed or separated to prevent-

- (a) ignition of nearby parts of the building; or
- (b) escape or discharge of smoke to the inside of the building or to adjacent *windows*, ventilation inlets or the like.

Part G3 Atrium Construction

The construction of an *atrium* must not unduly increase the danger to occupants from fire or smoke.

Part G4 Construction in Alpine Areas

Additional safety measures must be provided in *alpine areas* in view of the increased difficulties in fighting fire and maintaining access and means of egress in snow or ice conditions.

SA Part G5 TO Part G8

TAS Part G101

PART G1 MINOR STRUCTURES AND COMPONENTS

G1.1 Swimming pools

NT G1.1

SA G1.1

WA G1.1

(a) **Drainage** : A *swimming pool* must have suitable means of drainage. ý

NSW G1.1(b)

(b) ý **Safety fencing** : A *swimming pool* associated with a Class 1, 2 or 3 building, with a depth of water more than 300 mm must have suitable barriers or safety fencing in accordance with AS 2818 and AS 1926 to restrict access by young children to the immediate pool surrounds.

ACT G1.1(c) to (e)

QLD G1.1(c)

TAS G1.1(c) to (i)

G1.2 Refrigerated chambers, strong-rooms and vaults ý

TAS G1.2

(a) ý A refrigerated or cooling chamber which is of sufficient size for a person to enter must-

- (i) ý have a door which is in an opening with a clear width of not less than 600 mm and a clear height of not less than 1.5 m; and
- (ii) ý at all times, be able to be opened from inside without a key.

(b) ý A strong room or a vault in a building must have-

- (i) ý internal lighting controllable only from within the room; and
- (ii) ý a pilot light located outside the room but controllable only by the switch for the internal lighting.

(c) ý A refrigerated or cooling chamber, strong room or vault must have a suitable alarm device located outside but controllable only from within the chamber, room or vault.

G1.3 Access to household-type hot water supply systems

(a) ý A household-type hot water system which is installed in a building must-

- (i) ý be supported on construction sufficient to carry the total mass at full capacity; and
- (ii) ý be positioned to enable adequate access for operation, maintenance and removal; and
- (iii) ý have a safe-tray and waste for any overflow if it is in a roof space or otherwise concealed.

(b) ý Installation of a household-type hot water system in accordance with AS 1529 satisfies (a).

ACT G1.101 TO G1.104

QLD G101, G102

VIC G1.101

PART G2 $\dot{\gamma}$ HEATING APPLIANCES, FIREPLACES, CHIMNEYS AND FLUES

G2.1 $\dot{\gamma}$ General requirements

A chimney or flue must be constructed-

- (a) $\dot{\gamma}$ to withstand the temperatures likely to be generated by the appliance to which it is connected; and
- (b) $\dot{\gamma}$ so that the temperature of the exposed faces will not reach a level that would cause damage to nearby parts of the building; and
- (c) $\dot{\gamma}$ so that hot products of combustion will not-
 - (i) $\dot{\gamma}$ escape through the walls of the chimney or flue; and
 - (ii) $\dot{\gamma}$ discharge in a position that will cause fire to spread to nearby *combustible* materials or allow smoke to penetrate through nearby *windows*, ventilation inlets, or the like; and
- (d) $\dot{\gamma}$ in such a manner as to prevent rainwater penetrating to any part of the interior of the building.

G2.2 $\dot{\gamma}$ Installation of appliances

The installation of a stove, heater or similar appliance in a building must comply with:

- (a) $\dot{\gamma}$ Domestic oil-fired appliances - Installation: AS 1691.
- (b) $\dot{\gamma}$ Domestic solid-fuel burning appliances - Installation: AS 2918.
- (c) $\dot{\gamma}$ SAA Boiler Code: AS 1200.

ACT G2.2(d),(e)

G2.3 $\dot{\gamma}$ Open fireplaces deemed-to-satisfy

An open fireplace, or solid-fuel burning appliance in which the fuel-burning compartment is not enclosed, satisfies G2.1 if it has-

- (a) $\dot{\gamma}$ a hearth constructed of stone, concrete, masonry or similar *non-combustible* material so that-
 - (i) $\dot{\gamma}$ it extends not less than 300 mm beyond the front of the fireplace opening and not less than 150 mm beyond each side of that opening; and
 - (ii) $\dot{\gamma}$ it extends beyond the limits of the fireplace or appliance not less than 300 mm if the fireplace or appliance is free-standing from any wall of the room; and
 - (iii) $\dot{\gamma}$ its upper surface does not slope away from the grate or appliance; and
 - (iv) $\dot{\gamma}$ *combustible* material situated below the hearth but not below that part *required* to extend beyond the fireplace opening or the limits of the fireplace is not less than 155 mm from the upper surface of the hearth;
- (b) $\dot{\gamma}$ walls forming the sides and back of the fireplace up to not less than 300 mm above the underside of the arch or lintel which-
 - (i) $\dot{\gamma}$ are constructed in 2 separate leaves of solid masonry not less than 180 mm thick, excluding any cavity; and
 - (ii) $\dot{\gamma}$ do not consist of concrete block masonry in the construction of the inner leaf;

- (c) ∫ walls of the chimney above the level referred to in (b)-
- (i) ∫ constructed of masonry units with a net volume, excluding cored and similar holes, not less than 75% of their gross volume, measured on the overall rectangular shape of the units, and with an actual thickness of not less than 100 mm; and
 - (ii) ∫ lined internally to a thickness of not less than 12 mm with rendering consisting of 1 part cement, 3 parts lime, and 10 parts sand by volume, or other suitable material; and
- (d) ∫ suitable damp-proof courses or flashings to maintain weatherproofing.

ACT G2.3(e)

G2.4 Incinerator rooms

- (a) ∫ If an incinerator is installed in a building any hopper giving access to a charging chute must be-
- (i) ∫ *non-combustible*; and
 - (ii) ∫ gas-tight when closed; and
 - (iii) ∫ designed to return to the closed position after use; and
 - (iv) ∫ not attached to a chute that connects directly to a flue unless the hopper is located in the open air; and
 - (v) ∫ not located in a *required exit*.
- (b) ∫ A room containing an incinerator must be separated from other parts of the building by construction with an FRL of not less than 60/60/60.

ACT G2.101, G2.102

PART G3 ATRIUM CONSTRUCTION

G3.1 Atriums affected by this Part

This Part does not apply to an *atrium* which-

- (a) ∫ connects only 2 *storeys*; or
- (b) ∫ connects only 3 *storeys* if-
 - (i) ∫ each *storey* is provided with a *sprinkler system* throughout; and
 - (ii) ∫ one of those *storeys* is situated at a level at which there is direct egress to a road or *open space*.

G3.2 Dimensions of atrium well

An *atrium well* must have a width throughout the well that is able to contain a cylinder having a horizontal diameter of not less than 6 m.

G3.3 Separation of atrium by bounding walls

An *atrium* must be separated from the remainder of the building at each *storey* by bounding walls set back not more than 3.5 m from the perimeter of the *atrium well* except in the case of the walls at no more than 3 consecutive *storeys* if-

- (a) ∫ (i) one of those *storeys* is at a level at which direct egress to a road or *open space* is provided; and

- (b) the sum of the floor areas of those *storeys* that are contained within the *atrium* is not more than the maximum area that is permitted in Table C2.2.

G3.4 Construction of bounding walls

Bounding walls must-

- (a) have an FRL of not less than 60/60/60, and-
- (i) extend from the floor of the *storey* to the underside of the floor next above or to the underside of the roof; and
 - (ii) have any door openings protected with *self-closing* or *automatic* 60/60/30 fire doors; or
- (b) be constructed of fixed toughened safety glass, or wired safety glass in *non-combustible* frames, with-
- (i) any door openings fitted with a *self-closing* smoke door complying with Specification C3.4;
 - (ii) the walls and doors protected with wall-wetting systems in accordance with Specification G3.8; and
 - (iii) a fire barrier with an FRL of not less than 60/60/30 installed in any ceiling spaces above the wall.

G3.5 Construction at balconies

If a bounding wall separating an *atrium* from the remainder of the building is set back from the perimeter of the *atrium well*, a balustrade that is imperforate and *non-combustible*, and not less than 1 m high must be provided.

G3.6 Separation at roof

VIC G3.6

The roof of an *atrium* need not have the FRL prescribed in Specification C1.1 if-

- (a) part of the remainder of the building is higher than the *atrium*, and, if within 6 m vertically and 3 m horizontally of the *atrium* roof-
- (i) that part has an FRL of not less than 120/120/120; and
 - (ii) any opening in that part is protected in accordance with C3.4; or
- (b) the roof structure and membrane is protected by a *sprinkler system*).

NSW G3.6(c)

G3.7 Means of egress from atriums

All areas within an *atrium* must have access to at least 2 *exits*.

G3.8 Fire and smoke control systems in buildings containing atriums

- (a) Suitable provision for *sprinkler systems*, smoke control, fire detection and alarm systems, and emergency warning and intercommunication systems must be provided in a building containing an *atrium*.
- (b) Compliance with Specification G3.8 satisfies (a).

PART G4 CONSTRUCTION IN ALPINE AREAS

G4.1 Application of Part

This Part applies to any building constructed in an *alpine area* and overrules other provisions of this Code.

G4.2 Walls bounding or separating units

In a Class 2 or 3 building of Type C construction, a *loadbearing internal wall* bounding a *sole-occupancy unit* or separating adjoining units need not be of concrete or masonry.

G4.3 External doorways

- (a) √ A door fitted to an external doorway which may be subject to the build-up of snow must-
- (i) √ only be capable of opening inwards; and
 - (ii) √ be marked "OPEN INWARDS" on the inside face of the door in letters not less than 75 mm high and in a colour contrasting with that of the background; and
 - (iii) √ if it serves a corridor or stairway, be positioned in an alcove or recess so that it does not hinder egress.
- (b) √ An alcove or recess with-
- (i) √ no horizontal dimension less than twice the width of the door; and
 - (ii) √ the door positioned to open against a wall such that the distance from any part of its swing to the nearest point of entry of the stairway or corridor is not less than the width of the door,
- is deemed to satisfy Clause (a)(iii).
- TAS G4.3(c)
- (c) √ Every threshold of an external doorway must not be less than 900 mm above the finished ground level adjacent to the doorway.

G4.4 Emergency lighting

In a Class 2, 3, 5, 6, 7, 8 or 9 building, a system of emergency lighting must be installed in accordance with Part E4-

- (a) √ in every stairway (other than those within a *sole-occupancy unit*;
- (b) √ in every *public corridor*, public hallway or the like leading to an *exit*;
- (c) √ externally above every doorway opening to a road or *open space*; and
- (d) √ in any *storey* of the building if illumination sufficient for safe egress will not be available under conditions of emergency.

G4.5 External ramps

An external ramp serving as an *exit* must have a gradient not steeper than 1 in 12.

G4.6 Discharge of exits

- (a) √ Buildings must be constructed so that snow or ice is not deposited on the allotment, any adjoining allotment, road or public space in a location or manner that will-
- (i) √ significantly obstruct a means of egress from any building to the road or *open space*; or
 - (ii) √ otherwise endanger people.
- (b) √ Construction satisfies (a) when-
- (i) √ if any part of an *external wall* is more than 3.6 m above the natural ground level - the distance of that part from a boundary other than a road alignment is not less than 2.5 m plus 100 mm for each 300 mm or part by which that part of the wall exceeds a height of 3.6 m; and
 - (ii) √ if an *exit* doorway discharges into a court between wings of a building - the wings are not less than 6 m apart; and
 - (iii) √ if an *exit* doorway is opposite a barrier which is more than 900 mm above the threshold of the doorway - the threshold is at a distance from that barrier of not less than twice the height of the barrier or 6 m, whichever is the lesser.

G4.7 External trafficable structures

External stairways, ramps, access bridges or other trafficable structures must have-

- (a) √ a floor surface that consists of steel mesh or other suitable material if it is used as a means of egress; and
- (b) √ any *required* balustrade constructed so that its sides are not less than 75% open.

G4.8 Fire-fighting services and equipment

Every Class 2, 3, 5, 6, 7, 8 and 9 building must have-

- (a) √ a manually operated fire alarm system with call-points complying with AS 1670; and
- (b) √ fire hose reels and *hydrants* installed in accordance with Part E1.

G4.9 Fire orders

TAS G4.9

Every Class 2, 3 or 9 building must display a notice clearly marked "FIRE ORDERS" in suitable locations near the main entrance and on each *storey*, explaining-

- (i) √ the method of operation of the fire alarm system and the location of all call-points;
- (ii) √ the location and methods of operation of all fire-fighting equipment;
- (iii) √ the location of all *exits*; and
- (iv) √ the procedure for evacuation of the building.

PART G5 CONSTRUCTION IN BUSHFIRE PRONE AREAS

No BCA Provisions

SA G5.101

SPECIFICATION G3.8 FIRE AND SMOKE CONTROL SYSTEMS IN BUILDINGS CONTAINING ATRIUMS

1. SCOPE

This Specification sets out the requirements for the design and operation of systems of fire and smoke control in buildings containing an *atrium*.

2. AUTOMATIC FIRE SPRINKLER SYSTEM

2.1 General requirement

A *sprinkler system* complying with AS 2118 must be installed in every building containing an *atrium*, except where varied or superseded by this Specification.

2.2 Roof protection

A roof of an *atrium* which does not have the FRL prescribed in Specification C1.1 or Part C2 must be protected by *automatic* sprinklers arranged to wet both the covering membrane and supporting structure if the roof is-

- (a) less than 12 m above the floor of the *atrium* or the floor of the highest *storey* where the bounding construction is set back more than 3.5 m from the *atrium well* if a Class 2, 3, 5 or 9 part of a building is open to the *atrium*; or
- (b) less than 20 m above the floor of the *atrium* or the floor of the highest *storey* where the bounding construction is set back more than 3.5 m from the *atrium well* if a Class 6, 7 or 8 part of a building is open to the *atrium*,

and the temperature rating of sprinkler heads providing roof protection must be within the range 79°C - 100°C.

2.3 Atrium floor protection

The floor of the *atrium* must be protected by sprinklers with-

- (a) the use of sidewall pattern sprinkler heads together with overhead sprinklers where dictated by the dimensions of the *atrium*; and
- (b) sprinkler heads of the fast response type, installed with suitable *non-combustible* heat collector plates of 200 mm minimum diameter to ensure activation by a rising fire plume.

2.4 Sprinkler systems to glazed walls

2.4.1 Location of protection

Where an *atrium* is separated from the remainder of the building by walls or doors incorporating glazing, a wall wetting system with suitable *non-combustible* heat collector plates of 200 mm diameter must be provided to protect the glazing as follows:

- (a) On the *atrium* side of the glazing - to all glazed walls which are set back more than 3.5 m from the *atrium well*.
- (b) On the *atrium* side of the glazing - to all glazed walls which are not set back, or are set back 3.5 m or less, from the *atrium well*, for all levels which are less than-

SUPERCEDED

- (i) ý 12 m above the floor of an *atrium* or the floor of the highest *storey* where the bounding wall is set back more than 3.5 m from the *atrium well* if a Class 2, 3, 5 or 9 part of the building is open to the *atrium*; or
 - (ii) ý 20 m above the floor of an *atrium* or the floor of the highest *storey* where the bounding wall is set back more than 3.5 m from the *atrium well* if a Class 6, 7 or 8 part of the building is open to the *atrium*.
- (c) ý On the side of the glazing away from the *atrium well* - to all glazing forming part of bounding wall at each *storey*.

2.4.2 Sprinkler head location

Sprinklers must be located in positions allowing full wetting of the glazing surfaces without wetting adjacent sprinkler heads.

2.4.3 Head rating and response time

Sprinkler heads must be of the fast response type and have a maximum temperature rating of 74°C.

2.4.4 Water discharge rate

The rate of water discharge to protect glazing must be not less than-

- (a) ý on the *atrium* side of the glazing-
 - (i) ý 0.25 L/s.m² where glazing is not set back from the *atrium well*; or
 - (ii) ý 0.167 L/s.m² where glazing is set back from the *atrium well* ; and
- (b) ý on the side away from the *atrium well* - 0.167 L/s.m².

2.4.5 Water supply

In addition to that of the basic sprinkler protection for the building, the water supply to *required* wall wetting systems must be of adequate capacity to accommodate the following on the *atrium* side of the glazing:

- (a) ý Where the bounding walls are set back less than 3.5 m from the *atrium well* - wall wetting of a part not less than 6 m long for a height of not less than-
 - (i) ý 12 m above the floor of an *atrium* or the floor of the highest *storey* where the bounding wall is set back more than 3.5 m from the *atrium well* if a Class 2, 3, 5 or 9 part of the building is open to the *atrium*; or
 - (ii) ý 20 m above the floor of an *atrium* or the floor of the highest *storey* where the bounding wall is set back more than 3.5 m from the *atrium well* if a Class 6, 7 or 8 part of the building is open to the *atrium*; and
- (b) ý Where the walls are set back 3.5 m or more from the *atrium well* - wetting of a part not less than 12 m long on one *storey*.

2.5 Stop valves

- (a) ý Basic sprinkler and wall wetting systems protecting a building containing an *atrium* must be provided with easily accessible and identified stop valves.
- (b) ý Sprinkler and wall wetting systems must be provided with independent stop valves.
- (c) ý Sprinkler heads protecting the roof of the *atrium* must be provided with a stop valve.
- (d) ý Stop valve to wall wetting and roof sprinklers may be of the gate type.

- (e) ŷ All sprinkler and wall wetting stop valves must be monitored to detect unauthorised closure.

3. ŷ SMOKE CONTROL SYSTEM

3.1 General requirements

Except where varied or superseded by this Specification, mechanical air-handling systems in a building containing an *atrium* must comply with AS 1668.1.

3.2 Operation of atrium mechanical air-handling systems

Mechanical air-handling systems serving an *atrium* must be designed to operate so that during a fire-

- (a) ŷ smoke contamination of all paths of travel along balconies to *required exits* within an *atrium* does not exceed, over a period of 60 seconds, a concentration of 1 in 100 when compared with test smoke at its source and a maximum optical density of 0.01 per metre in any case;
- (b) ŷ smoke exhaust fans serving the *atrium* are only activated when smoke enters the *atrium*;
- (c) ŷ central plant systems do not use the *atrium* as a return air path;
- (d) ŷ central plant systems which use return air paths remote from the *atrium*-
- (i) ŷ cycle to the full outside air mode;
 - (ii) ŷ stop supply air to the fire affected *storey* or *fire compartment*; and
 - (iii) ŷ continue to fully exhaust the fire affected *storey* or *fire compartment* and reduce the exhaust from other *storeys* or *fire compartments* by at least 75%;
- WA Spec G3.8 3.2(d)(iv)
- (e) ŷ fans performing relief or exhaust duty from the *atrium* stop normal operation; and
- (f) ŷ floor by floor, or unitary, air-handling plant serving a single *fire compartment* or *storey*-
- (i) ŷ ceases normal operation in the fire affected *storey* or *fire compartment*; and
- NSW Spec G3.8 3.2(f)(ii)
- (ii) commences full relief or exhaust from that fire affected *storey* or *fire compartment*;
- WA Spec G3.8 3.2(f)(iii)

3.3 Activation of smoke control system ŷ

NSW Spec G3.8 3.3

The smoke control system must be activated by-

- (a) operation of an *automatic* fire alarm;
- (b) operation of a manual break-glass fire alarm;
- (c) operation of the *sprinkler system*; or
- (d) a manual start switch,

and all controls for the smoke control system must be located in the fire control room, or emergency control centre, (if any) or adjacent to the sprinkler control valves or incorporated in the Fire Indicator Board.

3.4 Smoke exhaust system

A smoke exhaust system serving an *atrium* must be designed on the basis of-

- (a) \dot{y} the *sprinkler system* limiting the size of a fire to-
- (i) \dot{y} a heat output of 1.5 MW and perimeter of 7.5 m if a Class 2, 3, 5 or 9 part of the building is open to the *atrium*; or
 - (ii) \dot{y} a heat output of 5 MW and perimeter of 12 m if a Class 6, 7 or 8 part of the building is open to the *atrium*;
- (b) \dot{y} a smoke plume reaching a level 3 m above the highest *storey* having a path of travel to a *required exit* along a balcony bounding the *atrium well*, and not less than-
- (i) \dot{y} 12 m above the floor of an *atrium* or the floor of the highest *storey* where the bounding wall is set back more than 3.5 m from the *atrium well* if a Class 2, 3, 5 or 9 part of the building is open to the *atrium*; or
 - (ii) \dot{y} 20 m above the floor of an *atrium* or the floor of the highest *storey* where the bounding construction is set back more than 3.5 m from the *atrium well* if a Class 6, 7 or 8 part of the building is open to the *atrium*; and
- (c) \dot{y} the smoke exhaust system discharging smoke at a rate of not less than that shown in Figure 3.4 for the appropriate height of smoke plume and fire size-
- (i) \dot{y} from the top of the *atrium*; or
 - (ii) \dot{y} horizontally where calculations of wind velocity induced pressure profiles for the building verify that the exhaust system will operate effectively for all wind directions.

Figure 3.4 SMOKE EXHAUST RATE

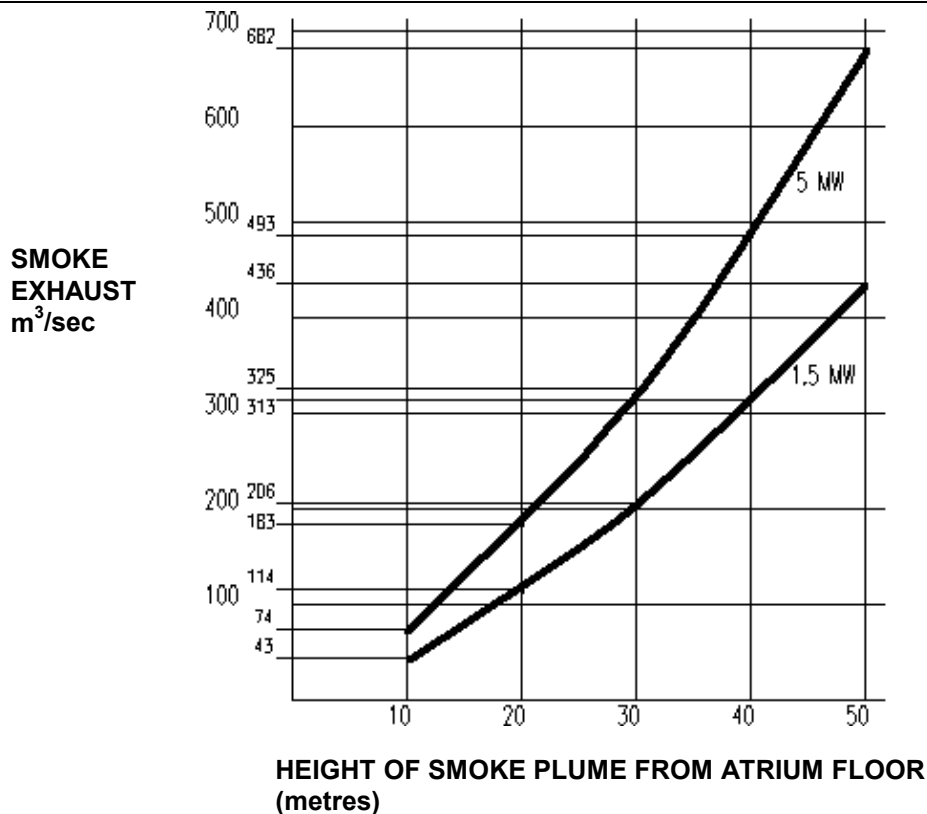

3.5 Upward air velocity

Notwithstanding 3.4(c), the average upward air velocity in the *atrium*, due to the *required* smoke exhaust quantity must-

- (a) \dot{v} be not less than 0.2 m/s at any level over an 18 m height above the floor of the *atrium*; and
- (b) \dot{v} not exceed the following maximum velocities in *atriums* of constant cross sectional plan area-
 - (i) \dot{v} for occupancy classification qualifying for 1.5 MW fire size - 3.5 m/s.
 - (ii) \dot{v} for occupancy classifications qualifying for 5 MW fire size - 5 m/s.

3.6 Exhaust fans

- (a) \dot{v} Smoke exhaust must be provided by fans capable of continuous and *required* operation for a period of not less than 2 hours when handling exhaust gases at 200°C.
- (b) \dot{v} Where a Class 2, 3 or 9 part of a building adjoins an *atrium*, the *atrium* must be provided with a minimum of 3 fans each capable of 50% of the total *required* smoke exhaust capacity.
- (c) \dot{v} *Atriums* other than those referred to in (b) must be provided with a minimum of 2 fans each capable of 50% of the total *required* smoke exhaust capacity.

3.7 Smoke and heat vents

Notwithstanding Clause 3.6, *automatic* vents complying with AS 2665 may be used, except where a Class 6 part of a building adjoins the *atrium*, in lieu of exhaust fans provided that-

- (a) \dot{v} the height from the *atrium* floor to the bottom of the highest vent is not more than 12 m; and
- (b) \dot{v} the vents are fitted with a remote manual operation switch located adjacent to the sprinkler control valves or incorporated in the Fire Indicator Board.

3.8 Make-up air supply

- (a) \dot{v} Uniformly distributed make-up air must be provided to the *atrium* exhaust system from outside the *atrium* at or near the lowest *storey* level, together with relief air from non-fire *storeys*.
- (b) \dot{v} A discharge volume sufficient to maintain a velocity of not less than 0.1 m/s towards the *atrium well* must be provided on all *storeys* where bounding wall is set back from the *atrium well*.

NSW Spec G3.8(c)

4. \dot{v} FIRE DETECTION AND ALARM SYSTEM

4.1 General requirements

Except where superseded by this Specification, *automatic* fire detection and alarm systems in a building containing an *atrium* must comply with AS 1670.

4.2 Smoke detection system

Smoke detection within an *atrium*-

SUPERCEDED

NSW Spec G3.8 4.2(a)

- (a) γ must be provided within all outside intakes and at individual floor return air intakes of all pressurisation and air-handling systems to initiate *automatic* fire mode operation, and where applicable, the restart facilities *required* by AS 1668.1;
- (b) γ must operate within the sensitivity range from 0.01 to 0.5% obscuration per metre with compensation for external airborne contamination as necessary;
NSW Spec G3.8 4.2(c)
- (c) γ must sample air within the *atrium* and in *storeys* where the bounding wall is set back more than 3.5 m from the *atrium well*;
- (d) γ must be calibrated to compensate for smoke dilution where sampling occurs within return air path common to more than one room; and
NSW Spec G3.8 4.2(e)
- (e) γ may incorporate beam type detectors to sense smoke in an *atrium* in a Class 5, 6, 7 or 8 building with an effective height of not more than 25 m if-
 - (i) γ the beam detectors are located at intervals of not more than 3 *storeys*; and
 - (ii) γ arranged to scan at 90 degrees orientation to adjacent beam units.

4.3 γ Smoke detection in spaces separated from the atrium by bounding walls

Smoke detection systems must be located at all return and relief air openings associated with the building air-handling systems and be-

- (a) γ of the sampling type system as *required* in 4.2; or
- (b) γ of the point type optical smoke detector.

4.4 γ Alarm systems

- (a) γ A break-glass fire alarm point must be provided at each door to a *fire-isolated stairway*, *fire-isolated ramp*, or fire-isolated passage.
- (b) γ A staged alarm must be provided where an air sampling type smoke detection system is provided for the *atrium*, and must operate as follows:
 - (i) γ Alert building management when abnormal smoke levels of 0.03% obscuration per metre are detected.
 - (ii) γ Initiate a second alarm to management and start all smoke control systems including pressurisation of escape routes when smoke levels of 0.07% obscuration per metre are detected.
 - (iii) γ Automatically call the Fire Authority, activate the emergency warning and intercommunication systems, and de-activate all plant not necessary for fire safety within the building when smoke levels of 0.09% obscuration per metre are detected.
- (c) γ Beam and point type smoke detectors *required* must simultaneously operate all functions referred to above and activate at the level set out in AS 1668.1.

5. γ EVACUATION WARNING AND INTERCOMMUNICATION SYSTEM

All buildings containing an *atrium* must be provided with an emergency warning and intercommunication system which-

SUPERCEDED

- (a) ŷ complies with AS 2220; and
- (b) ŷ incorporates visible warning signs that-
 - (i) ŷ operate upon the "action" signal; and
 - (ii) ŷ display the words "EVAC AREA" in red with letters conforming with the requirements of Part E4 for *exit* signs.

6. ŷ STANDBY POWER SYSTEM

If a *required* path of travel to an *exit* is within an *atrium*, safety systems, including *sprinkler system* and *hydrant* pumps, air handling systems, alarms, warning and communication systems, and emergency lighting circuits, must be connected to a standby power supply that-

- (a) ŷ is additional to that *required* under other provisions of this Code and may take the form of one or more emergency generator sets, provided that such supply is capable of starting and taking the *required* electrical load within a period of 30ŷseconds from the time normal power supply fails;
- (b) ŷ *automatically* energises the emergency power system if there is a mains failure when the smoke control system is activated in accordance with 3.3;
- (c) ŷ is separated from the remainder of the building by an enclosure with an FRL of at least 120/120/120 and connected to the *required* emergency systems by means of suitable *fire-resisting* cabling; and
- (d) ŷ is capable of fully *automatic* operation and of running unattended for a minimum of 2 hours from the time an alarm is given.

NSW Spec G3.8 6(e)

7. ŷ SYSTEM FOR EXCLUDING SMOKE FROM FIRE-ISOLATED EXITS

- (a) ŷ *Required* fire-isolated *exits* in a building containing an *atrium* must be protected from the entry of smoke in accordance with E2.2.

NSW Spec G3.8 101

***** ŷ

SECTION H SPECIAL USE BUILDINGS

CONTENTS

H1 Theatres, Stages and Public Halls

- H1.1 Application of Part ý
- H1.2 Separation and smoke control ý
- H1.3 Proscenium wall construction ý
- H1.4 Seating area ý
- H1.5 Exits from theatre stages ý
- H1.6 Access to platforms and lofts ý

Specifications

- H1.2 Smoke Control Systems for Theatres ý
- H1.3 Construction of Theatres with Proscenium Walls ý

Appendices

NT

- Part H101 Food Premises
- Part H102 Premises to be Used for Activities Involving Skin Penetrations
- Part H103 Mortuaries

Qld

- Part H101 Workplaces ý
- Part H102 Stables ý
- Part H103 Kiosks ý
- Part H104 Premises Used for Lead Processing ý
- Part H105 Workplaces Involving Asbestos ý
- Part H106 Workplaces Involving Spray Painting ý
- Part H107 Foundaries and Abrasive Blasting ý
- Part H108 Detention Centres ý

Tas

- H1.101 Movable Seating ý
- Part H101 Workplaces ý
- Part H102 Food Premises ý
- Part H103 Dining Rooms and Bar Rooms ý
- Part H104 Bottle Shops at Licensed Premises ý
- Part H105 Accommodation Facilities ý
- Part H106 Meat Premises ý

SUPERCEDED

Part H107	Dairies
Part H108	Pharmacies
Part H109	Hospitals and Nursing Homes
Part H110	Premises Used for Activities Involving Skin Penetration
Part H111	Dental Surgeries and Chiropractors' Premises
Part H112	Mortuaries
Part H113	Foundaries
Part H114	Premises for Manufacturing or Processing of Glass Reinforced Plastics
Part H115	Premises for Production or Processing of Isocyanates
Part H116	Premises for Electro-Plating, Electro-Polishing, Anodising or Etching
Part H117	Premises for Lead Processing
Part H118	Booths for Spray Painting or Spray Coating
Part H119	Electricity Distribution Substations
Part H120	Premises for Manufacture or Storage of Dangerous Goods
Part H121	Hairdresser's Premises

SUPERCEDED

OBJECTIVE

This Section contains more specific requirements for particular special use buildings. Special use buildings must be so designed and constructed that the following objectives, in addition to those listed for Sections B, C, D, E and F where relevant, are fulfilled.

Part H1 Theatres, Stages and Public Halls

The audience seating area and egress routes of a Class 9b building used as a theatre, public hall, or the like, must be protected against fire and smoke from any fire occurring on stage, in *backstage areas* or in rigging lofts.

TAS Part H101 to H121

PART H1 THEATRES, STAGES AND PUBLIC HALLS ý

QLD H1.1

H1.1 Application of Part

This Part applies to every enclosed Class 9b building or part of a building which-

- (a) has a stage and any *backstage area* with a total floor area of more than 200 m²; or
- (b) has a stage with an associated rigging loft.

Clause H1.4 also applies to both open and enclosed Class 9b buildings.

H1.2 Separation and smoke control

A theatre, public hall or the like must-

- (a) ý have a smoke control system in accordance with Specification H1.2 and a *sprinkler system* in accordance with Specification E1.5; or
- (b) ý have the stage, *backstage area* and accessible under-*stage* area separated from the audience by a proscenium wall and have a mechanical exhaust system in accordance with H1.3.

H1.3 Proscenium wall construction

A proscenium wall and mechanical exhaust system *required* by H1.2(b) must comply with Specification H1.3.

H1.4 Seating area

In a seating area-

- (a) ý the gradient of the floor surface must not be steeper than 1 in 8, or the floor must be stepped so that-
 - (i) ý a line joining the nosings of consecutive steps does not exceed an angle of 30° to the horizontal;
 - (ii) ý the height of each step in the stepped floor is not more than 600 mm; and
 - (iii) ý the height of any opening in such a step is not more than 125 mm;

- (b) ý if an aisle divides the stepped floor and the difference in level between any 2 consecutive steps-
 - (i) ý exceeds 230 mm but not 400 mm - an intermediate step must be provided in the aisle;
 - (ii) ý exceeds 400 mm - 2 equally spaced intermediate steps must be provided in the aisle; and
 - (iii) ý the going of intermediate steps must be not less than 270 mm and such as to provide as nearly as practicable equal treads throughout the length of the aisle; and
- (c) ý the clearance between rows of fixed seats used for viewing performing arts, sport or recreational activities must be not less than-
 - (i) ý 300 mm if the distance to an aisle is not more than 3.5 m; or
 - (ii) ý 500 mm if the distance to an aisle is more than 3.5 m.

H1.5 Exits from theatre stages

- (a) ý The path of travel to an *exit* from a *stage* or performing area must not pass through the proscenium wall if the *stage* area is separated from the audience area with a proscenium wall.
- (b) ý *Required exits* from *backstage* and *under-stage* areas must be independent of those provided for the audience area.

H1.6 Access to platforms and lofts

A stairway that provides access to a service platform, rigging loft, or the like, must comply with AS 1657.

NT H101 to H103

QLD H101 to H108

TAS H1.101, H101 to H120

SPECIFICATION H1.2 ý SMOKE CONTROL SYSTEMS FOR THEATRES

1. ý Scope

This Specification contains the requirements for the design and operation of smoke control systems for theatres, public halls, or the like, to comply with H1.2.

2. ý Application of AS 1668.1

Except where superseded by this Specification, mechanical air-handling systems must comply with AS 1668.1 where relevant.

3. ý Design principles

The smoke control system must be designed on the basis of-

- (a) ý a sprinkler controlled fire having a perimeter of 12 m; and
- (b) ý the provision of a smoke reservoir so that-
 - (i) ý the lowest level of the smoke in the reservoir is more than 2.5 m above the floor level of the highest tier of seating; and

- (ii) \dot{V} the lowest level of the smoke layer in the reservoir is more than 1 m above the lowest point of the smoke enclosure.

4. \dot{V} Construction of smoke reservoir

The construction forming a smoke reservoir must be *non-combustible*;

5. \dot{V} Exhaust rates

The system must exhaust smoke at a rate not less than that shown in Figure 5-

- (a) \dot{V} from above the stage - for a 5 MW fire and the relevant height between the lowest level of the smoke layer in the smoke reservoir and the stage floor; or
 (b) \dot{V} if the smoke reservoir above the stage is smoke separated from the audience area - for a 1.5 MW fire and the relevant height between the lowest level of the smoke layer in the reservoir and the lowest part of the floor in the audience area.

Figure 5 SMOKE EXHAUST RATE

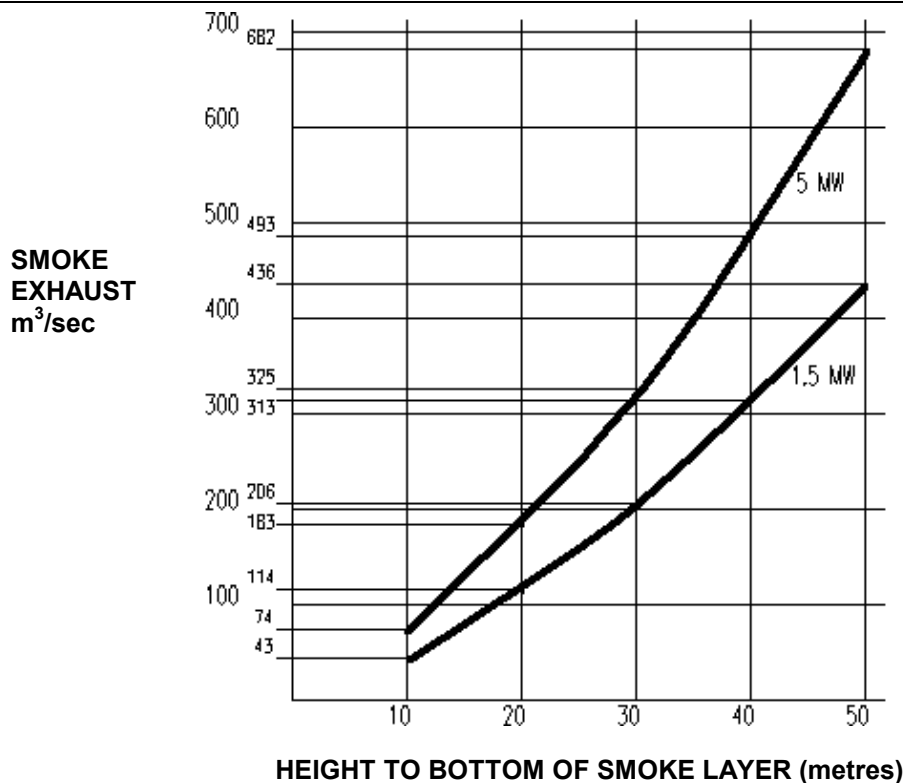

6. \dot{V} Exhaust fans

The smoke exhaust system must comprise-

- (a) \dot{V} not less than 3 exhaust fans-
- (i) \dot{V} each capable of 50% of the total *required* smoke exhaust capacity; and
 - (ii) \dot{V} capable of continuous operation for a period of not less than 2 hours when handling exhaust gases at 200°C; and
 - (iii) \dot{V} two exhaust fans must run initially with the third fan starting *automatically* if one of the either fans fails to operate but capable of simultaneous operation with the other two by manual control; or
- (b) \dot{V} *automatic smoke-and-heat vents* in accordance with AS 2665 if-

- (i) √ no rigging loft is constructed;
- (ii) √ the height from the *stage* floor to the highest part of the ceiling is not more than 12 m; and
- (iii) √ the vents have a remote manual operating switch at a location normally used by the *stage* manager.

7. √ Controls

The smoke control system must-

- (a) √ be actuated by the operation of-
 - (i) √ the *sprinkler system*;
 - (ii) √ an *automatic* fire alarm system or manual break-glass fire alarm where provided; and
 - (iii) √ a manual start switch at the location normally used by the *stage* manager and adjacent to an *exit* from the audience seating area; and
- (b) √ for all valves controlling the *sprinkler system* heads over the *stage* area have clearly marked tamper switches connected to a monitoring panel at the location normally used by the stage manager.

8. √ Make-up air supply

Make-up air must be available-

- (a) √ at or near the lowest part of the audience seating area;
- (b) √ at a low level around the perimeter of the audience seating areas; or
- (c) √ from the normal air-conditioning system if it does not disturb the rising plume of smoke being exhausted or the smoke layer in the smoke reservoir.

SPECIFICATION H1.3 √ CONSTRUCTION OF THEATRES WITH PROSCENIUM WALLS

1. √ Scope

This Specification contains the requirements for the construction of proscenium walls and mechanical ventilation for theatres, public halls, or the like.

2. √ Separation of stage areas, etc

- (a) √ Dressing rooms, scene docks, property rooms, workshops, associated store rooms and other ancillary areas must be-
 - (i) √ located on the stage side of the proscenium wall; and
 - (ii) √ separated from corridors and the like by construction having an FRL of not less than 60/60/60, and if of *lightweight construction*, complying with Specification C1.8.
- (b) √ The *stage* and *backstage* must be separated from other parts of the building other than the audience seating area by construction having an FRL of not less than 60/60/60, and if of *lightweight construction*, complying with Specification C1.8.
- (c) √ Any doorway in the construction referred to in paragraphs (a) and (b) must be protected by a *self-closing* 60/60/30 fire door.

3. ý Proscenium wall construction

A proscenium wall must-

- (a) ý extend to the underside of the roof covering or the underside of the structural floor next above; and
- (b) ý have an FRL of not less than 60/60/60, and if of lightweight construction, comply with Specification C1.8.

4. ý Combustible materials not to cross proscenium wall

Timber purlins or other *combustible* material must not pass through or cross any proscenium wall.

5. ý Protection of openings in proscenium wall

Every opening in a proscenium wall must be protected-

- (a) ý at the principal opening, by a curtain in accordance with Clause 6 which is-
 - (i) ý capable of closing the proscenium opening within 35 seconds either by gravity slide or motor assisted mechanisms;
 - (ii) ý operated by a system of *automatic* heat activated devices, manually operated devices or push button emergency devices; and
 - (iii) ý able to be operated from either the *stage* side or the audience side of the curtain; and
- (b) ý at any doorway in the wall, by a *self-closing* 60/60/30 fire door.

6. ý Proscenium curtains

A curtain *required* by Clause 5 must be-

- (a) ý a fire safety curtain-
 - (i) ý made of *non-combustible* material;
 - (ii) ý capable of withstanding a pressure differential of 0.5 kPa over its entire surface area; and
 - (iii) ý so fitted that when fully lowered it inhibits the penetration of smoke around the perimeter of the opening, from the *stage*; or
- (b) ý a curtain-
 - (i) ý having a Spread-of-Flame Index not greater than 0 and a Smoke-Developed Index not greater than 3; and
 - (ii) ý protected by a deluge system of open sprinklers installed along the full width of the curtain.

7. ý Mechanical ventilation

Every *stage* must have a system of mechanical ventilation with sufficient capacity to exhaust an amount of air whichever is the greater of-

- (a) ý 5 000 L/s; or
- (b) ý the sum of-
 - (i) ý 10 L/s.m² of the performing area of the *stage*;
 - (ii) ý 20 L/s.m² of the remaining area of the *stage*; and
 - (iii) ý 20 L/s.m² of the area of the rigging loft.

SUPERCEDED

*****ý

SUPERCEDED

INTRODUCTION

The ACT Appendix has been prepared by ACT Building Control and forms part of the Building Code of Australia (BCA) as adopted in the ACT.

The Appendix sets out variations and additions made to the provisions of the BCA which are considered necessary for the effective application of the Code in the ACT, and together with the BCA, its provisions are deemed to be appropriate and acceptable standards and requirements for the purpose of approval of plans under the Building Act.

The ACT Building Manual continues to have effect until its replacement by the BCA by amendment to the Building Act.

During this transition period, designers, builders and owners will be able to complete building projects in progress in accordance with the Building Manual and plan the design and construction of new projects in accordance with the BCA and ACT Appendix.

A modification of any of the requirements and standards set out in the BCA and ACT Appendix may be sought by application to the Modification Advisory Committee of ACT Building Control.

The Committee considers the application and provides advice to the Building Controller on whether in a specific instance, a particular requirement or standard should not apply and/or should be modified by an alternative and acceptable provision.

The Building Act provides that where an application for approval of plans has been refused, an appeal against the decision can be made by application for review by the ACT Administrative Appeals Tribunal.

CONTENTS

This Appendix contains the BCA provisions that have been varied and additional provisions for application in the Australian Capital Territory as follows:

A - GENERAL PROVISIONS

ACT A1.1	Definitions
ACT A1.3	Referenced Standards, etc.
ACT A2.101	Hazardous materials
ACT A2.102	Drawing practice

B - STRUCTURE

ACT B1.3	Construction deemed-to-satisfy
ACT B1.101	Floor loading notice
ACT B1.102	Preservative treatment of timber
ACT B1.103	Evidence of visual stress grading
ACT B1.104	Rodent protection
ACT B1.105	Gypsum plasterboard

- ACT B1.106 Excavation and earth-work ý
- ACT B1.107 Retaining walls ý
- ACT B2.101 Precautions during demolition ý

C - FIRE RESISTANCE

- ACT C1.9 Class 1 and 10 buildings
- ACT C3.101 Notices on fire doors and smoke doors

D -ACCESS AND EGRESS

- ACT D1.1 Application
- ACT D1.3 Fire isolated exits from basements
- ACT D1.101 Notices on fire isolated stairs
- ACT D2.9 Width of stairs
- ACT D2.13 Treads and risers
- ACT Table D2.13 Riser and Going Dimensions ý
- ACT D2.16 Balustrades
- ACT D2.21 Operation of latch
- ACT D2.101 Stairs serving small areas
- ACT D2.102 Minimum size of doorways
- ACT D2.103 Paving surfaces in public areas
- ACT D3.2 Access to buildings

E - SERVICES AND EQUIPMENT ý

- ACT E1.3 Fire hydrants
- ACT E1.7 Fire and smoke alarms
- ACT E2.4 Air handling systems
- ACT Specification E1.5 Fire Sprinkler Systems
- ACT Specification E2.6 Smoke Exhaust Systems
- ACT E5.2 Maintenance requirements
- ACT E5.101 Maintenance deemed-to-satisfy
- ACT E5.102 Maintained Items
- ACT E5.103 Logbooks

F - HEALTH AND AMENITY

- ACT F1.1 Drainage
- ACT F1.101 Shower and bath enclosures
- ACT F3.101 Carparking facilities
- ACT F4.101 Level of artificial lighting
- ACT F4.102 Artificial lighting of stairways and ramps
- ACT F4.103 Flyscreening

ACT Specification F1.1 Stormwater Drainage. ý

ACT Specification F1.101 Shower and Bath Enclosures ý

G - ANCILLARY PROVISIONS

ACT G1.1 Swimming pools

ACT G1.101 Dividing fences

ACT G1.102 Flammable liquid stores

ACT G1.103 Awnings and projections

ACT G1.104 Garbage facilities

ACT G2.2 Installation of appliances

ACT G2.3 Open fireplaces deemed-to-comply

ACT G2.101 Boilers

ACT G2.102 Chimneys and flues

SECTION A GENERAL PROVISIONS ý

PART A1 INTERPRETATION

Insert in A1.1 the following definitions:

ACT A1.1 Definitions

Private garage means-

(a) ý any garage of a Class 1 building;

(b) ý any single *storey* of a building of another Class capable of accommodating not more than 3 vehicles, if there is only one such *storey* in the building; or

(c) ý any separate single *storey* garage building serving another building.

Delete A1.3 and insert ACT A1.3 as follows:

ACT A1.3 Referenced Standards, etc.

A reference to a document under A1.2 is a reference to that document as listed in Specification A1.3 as amended, superseded or replaced from time to time and applying at the date of application for approval of plans for the building work.

Insert in Specification A1.3 the following:

ACT Specification A1.3		Standards Adopted by Reference ý
No.	Title ý	Clause(s)
AS 1000	The International System of Units (SI) and its application	ACT A2.102
AS 1100	Technical drawing	ACT A2.102
AS 1141	Methods for sampling and testing aggregates	
Part 41	Laboratory Polishing of aggregate using the horizontal bed machine	ACT D2.13 ACT D2.104
AS 1200	Boilers and pressure vessels	ACT G2.101

SUPERCEDED

AS 1254	UPVC pipes and fittings for storm or surface water applications	ACT Spec. F1.1
AS 1375	Industrial fuel-fired appliances	ACT G2.2 ACT G2.102
AS 1397	Sheet steel and strip- Hot-dipped zinc-coated or aluminium/zinc coated	ACT B1.3
AS 1445	Hot-dipped zinc-coated or aluminium/ zinc-coated steel sheet- 76 mm pitch corrugated	ACT B1.3
AS 1680	Code of practice for interior lighting and the visual environment	ACT F4.101
AS 1691	Rules for the installation of domestic oil- fired appliances (SAA Domestic Oil-fired Appliances Installation Code)	ACT G2.3 ACT G2.102
AS 1692	Tanks for flammable and combustible liquids	ACT G2.2
AS 1851	Maintenance of fire protection equipment	ACT Table E5.101
AS 1940	The storage and handling of flammable and combustible liquids	ACT G2.102
AS 2566	Plastics pipelaying design	ACT Spec. F1.1
AS 2589	The application and finishing of gypsum plasterboard in framed dwelling construction	ACT B1.105
AS 2601	The demolition of structures (SAA Demolition Code)	ACT B2.101
AS 2890	Off-street parking	ACT D3.2
AS 3666	Air handling and water systems in buildings - microbial control	ACT Table E5.101
	ACT Asbestos Removal Manual	ACT A2.101
	NOHSC Code of Practice for the safe removal of Asbestos	ACT A2.101
	SAA MH2 Metric data for building designers	ACT A2.102
	NSW Timber Marketing Act 1977 and NSW Timber Marketing Regulations 1979	ACT B1.102

PART A2 \dot{y} ACCEPTANCE OF DESIGN AND CONSTRUCTION

Add ACT A2.101 as follows:

ACT A2.101 Hazardous Materials

Asbestos-based materials: The removal of asbestos-based materials in any form or in any mixture thereof, or any material containing loose asbestos including asbestos fluff insulation, asbestos sheeting, lagging, fire protection and the like, must be carried out in accordance with-

- (a) \dot{y} the Code of Practice for the Safe Removal of Asbestos, August 1988 published by the National Occupational Health and Safety Commission; and
- (b) \dot{y} the ACT Asbestos Removal Manual.

Add ACT A2.102 as follows:

ACT A2.102 Drawing Practice

Drawings of buildings or parts of buildings for the purpose of the BCA and ACT Appendix must conform with AS 1000, AS 1100 and SAA MH2 as appropriate.

SUPERCEDED

SECTION B STRUCTURE

PART B1 STRUCTURAL PROVISIONS

Delete B1.3(k)(v) and (l) and insert the following:

ACT B1.3 Construction deemed-to-satisfy

(k) **Roof construction:**

(v) **Metal** - AS 1562, AS 1397 and AS 1445.

(l) **Particleboard structural flooring** - Where used in a building for flooring, particleboard must comply with AS 1860 except that-

- (i) contrary to Rule 2, Class 1 Flooring Grade particleboard flooring may be used in bathrooms, toilets and laundries in accordance with F1.7;
- (ii) contrary to Rule 4, sub-floor ventilation must be in accordance with ACT F4.10; and
- (iii) contrary to Rules 3.1, 3.2 and 7.1, only Class 1 Flooring Grade may be used for platform flooring in situations where particleboard is exposed to the weather during construction.

Add ACT B1.101 as follows:

ACT B1.101 Floor loading notice

In a Class 5, 6, 7, 8 or 9 building, where a floor or part of a floor of a building has been designed in accordance with AS 1170.1 to sustain a uniformly distributed live load exceeding 3 kPa, a notice in the form shown hereunder and indicating the actual loadings for which the floor has been structurally designed must be conspicuously and permanently posted in a position adjacent to such floor or such part of a floor.

<p>DESIGNED FLOOR LOADING</p> <p>Distributedkilograms per square metre</p> <p>Concentratedkilograms</p>

Note: The lettering of such notice must be embossed or cast into a metal tablet not less than 225 mm square and located not less than 1 m above floor level.

Add ACT B1.102 as follows:

ACT B1.102 Preservative treatment of timber

Treated timber is to be of the standard *required* by the NSW Timber Marketing Act 1977 and NSW Timber Marketing Regulations 1979.

Add ACT B1.103 as follows:

ACT B1.103 Evidence of visual stress grading

A certificate certifying that a timber member has been visually graded in accordance with Rule 1.5.1 of AS 1684 after erection and signed by:

- (a) an authorised officer of the Wood Technology Division, Forestry Commission of NSW; or

(b) ý an authorised officer of the Department of Forestry, Australian National University,
is evidence of that fact.

Add ACT B1.104 as follows:

ACT B1.104 Rodent protection

Suitable barriers must be installed in all buildings to prevent the entry of rodents and other vermin into concealed roof spaces, wall cavities, underfloor areas and the like.

Add ACT B1.105 as follows:

ACT B1.105 Gypsum plasterboard

Gypsum plasterboard applied to walls and ceilings must comply with AS 2589.

Add B1.106 as follows:

ACT B1.106 Excavation and earthwork

All excavations and backfilling must be carried out in a safe manner, with adequate provision made for shoring, compaction and drainage.

Add ACT B1.107 as follows:

ACT B1.107 Retaining walls

Retaining walls must be provided whenever soil conditions so require to resist pressures from retained materials, surcharge loads and retained water.

PART B2 DEMOLITION

Add ACT B2.101 as follows:

ACT B2.101 Precautions during demolition

Demolition must be carried out-

- (a) ý in accordance with AS 2601; and
- (b) ý in such a manner and with such adequate safety precautions so as to protect the public.

SECTION C FIRE RESISTANCE

PART C1 FIRE RESISTANCE AND STABILITY

Delete C1.9 and insert ACT C1.9 as follows:

ACT C1.9 Class 1 and 10 buildings

The construction of Class 1 and 10 buildings must comply with Specification C1.9 except that the *external walls* of Class 10a buildings are exempt from the requirements of Clause 4 of Specification C1.9 if-

- (a) ý the building is an open carport, pergola, unroofed terrace or the like; or

- (b) ŷ the building is separated from any other building on the site by-
 - (i) ŷ an open space 2 m in width; or
 - (ii) ŷ a *common wall* with an FRL of not less than 90/90/90.

PART C3 PROTECTION OF OPENINGS

Add ACT C3.101 as follows:

ACT C3.101 Notices on fire doors and smoke doors

- (a) ŷ Except in a Class 1 building or a door serving a *sole-occupancy unit* in a Class 2 or 3 building, every *required* fire door or smoke door must have a notice displayed in a conspicuous position on the face of the door as follows:
 - (i) ŷ in the case of a *self-closing* fire door or smoke door-

<p>FIRE DOOR (or SMOKE DOOR) - KEEP CLOSED Persons who interfere with the operation of this door are guilty of an offence under the Fire Brigade Act.</p>
--

- (ii) in the case of a fire door or smoke door incorporating a magnetic hold/release device-

<p>FIRE DOOR (or SMOKE DOOR) ON MAGNETIC HOLD/RELEASE - DO NOT PREVENT CLOSING Persons who interfere with the operation of this door are guilty of an offence under the Fire Brigade Act.</p>
--

- (b) ŷ In any notice displayed in accordance with (a)-
 - (i) ŷ the words FIRE DOOR, SMOKE DOOR, KEEP CLOSED, ON MAGNETIC HOLD/RELEASE DEVICE, DO NOT PREVENT CLOSING must be in letters not less than 20 mm in height;
 - (ii) ŷ all other letters and figures in the remainder of the notice must be not less than 3 mm in height; and
 - (iii) ŷ the notice must be clearly legible with lettering of a colour contrasting with the background embossed or cast into a permanent plate securely and permanently fixed to the door.

SECTION D ACCESS AND EGRESS

PART D1 PROVISION FOR ESCAPE

Delete D1.1 and insert ACT D1.1 as follows:

ACT D1.1 Application

This Part applies to-

- (a) ŷ all buildings except Class 10 buildings; and
- (b) ŷ Class 1 buildings and within *sole-occupancy units* of Class 2 and Class 3 buildings - only in the case of:

D1.6(f)(iv) - Dimensions of *exits*.

Insert D1.3(c) as follows:

ACT D1.3 Fire isolated exits from basements

- (c) √ Basements- At least one *required* stairway must be fire-isolated, and-
- (i) √ if more than 2 *exits* are *required*, all *required* stairways except one must be fire-isolated; and
 - (ii) √ if the basement is used for the repair or accommodation of motor vehicles, all *required* stairways must be fire-isolated.

Add ACT D1.101 as follows:

ACT D1.101 Notices in fire-isolated stairs

- (a) √ Every *fire-isolated stairway* must have a notice displayed in a conspicuous position at the landing on each *storey* level to the effect of the following:
- (b) √ In any notice displayed in accordance with (a)-
- (i) √ the words "OFFENCES RELATING TO FIRE STAIRS" must be in letters

OFFENCES RELATING TO FIRE STAIRS

Under the Fire Brigade Act it is an offence to:

1. √ Place anything in this stairway or any associated passageway leading to the exterior of the building which may impede the free passage of persons;
2. √ Interfere with or cause obstruction or impediment to the normal operation of fire doors providing access to this stairway;
3. √ Remove, damage or otherwise interfere with this notice.

not less than 20 mm in height;

- (ii) √ all other letters and figures in the remainder of the notice must be not less than 3 mm in height; and
- (iii) √ the notice must be clearly legible with lettering of a colour contrasting with the background embossed or cast into a permanent plate securely and permanently fixed to the wall.

PART D2 CONSTRUCTION OF EXITS

Delete D2.1 and insert ACT D2.1 as follows:

ACT D2.1 Application

Except for D2.9, D2.13, D2.15(b), D2.16, D2.17(a) and (b), and ACT D2.102, this Part does not apply to-

- (a) √ a Class 1 or Class 10 building; or
- (b) √ the internal parts of a *sole-occupancy unit* in a Class 2 or Class 3 building, or a Class 4 part.

Add ACT D2.9(c) as follows:

ACT D2.9 Width of stairs and corridors

- (c) √ The width of a *required* stairway and a corridor must be not less than 850 mm.

Delete D2.13(b)(v) and insert ACT D2.13(b)(v) as follows:

ACT D2.13 Treads and risers

(b) \dot{y} (v) treads which have a non-slip finish or a suitable non-slip strip near the edge of the nosings that meet the requirements of AS 1141.41, excluding clauses 10(g) to 10(k), and a minimum polished frictional value of not less than 45;

Delete Table D2.13 and insert ACT Table D2.13 as follows:

ACT Table D2.13 RISER AND GOING DIMENSIONS						
	RISER (R)		GOING (G) ^(b) \dot{y}		QUANTITY 2R+G	
	Max	Min	Max	Min \dot{y}	Max	Min
Public stairs	190	115	355	250	700	550 \dot{y}
Private stairs	190	115	355	240	700	550 \dot{y}

Note: (a) *Private stairs are-*

- (i) \dot{y} stairs in a Class 1 or 10 building;
- (ii) \dot{y} stairs in a *sole-occupancy unit* in a Class 2 building or Class 4 part; and
- (iii) \dot{y} in any building, stairs which are not part of a *required exit* and to which the public do not normally have access.

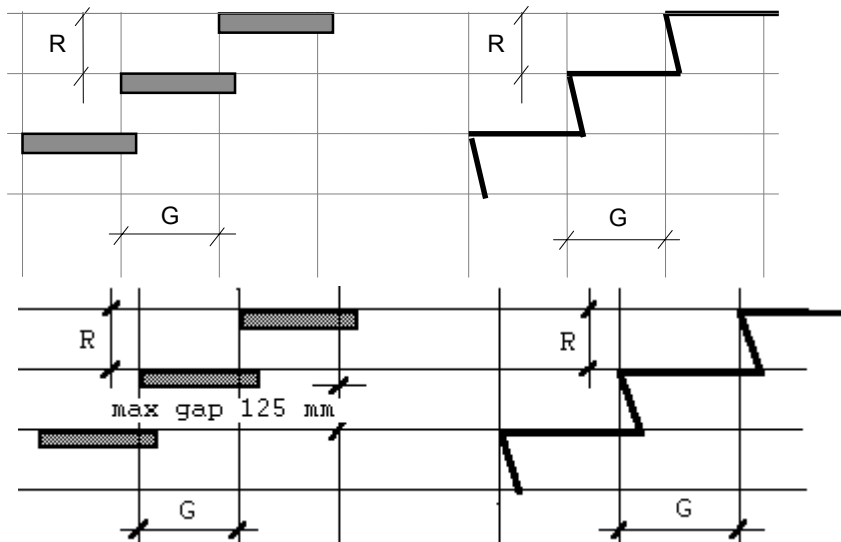

Note: (b) The going in tapered treads (as in a curved or spiral stair) is measured-

- (i) \dot{y} 270 mm in from the outer side if the flight is less than 1 m wide;
- (ii) \dot{y} 270 mm from each side if the flight is 1 m or more wide, and must be not less than 50 mm at the narrow end.

Delete D2.16(a) and insert ACT D2.16(a) as follows:

ACT D2.16 Balustrades

(a) \dot{y} In a Class 1, 2, 3, 4, 5, 6 or 9 building and a Class 7 building used as a *public carpark*, a continuous balustrade must be provided along the side of any stairway or ramp, or any corridor, hallway, balcony, access bridge, trafficable roof, or the like, to which access is provided as set out in D2.16(d) and (f), if-

- (i) \dot{y} it is not bounded by a wall; and

SUPERCEDED

- (ii) √ the change in level is more than 1 m, or 5 risers in the case of a stairway, from the floor or ground surface beneath, except at the perimeter of a *stage*, rigging loft, loading dock, an area accessible only to maintenance staff, or the like.

Add ACT D2.21(e) and (f) as follows:

ACT D2.21 Operation of latch

- (e) √ a lever handle type latch is *required* for special purpose areas, such as spray paint areas, laboratories and assembly buildings
- (f) √ a door serving as an *exit* in a Class 9b building, except schools, *early childhood centres*, preschool and religious buildings, must in addition to the requirements of D2.21, where the opening provides egress from a *storey* or room deemed to accommodate more than 100 persons in accordance with Table D1.13, be fastened by suitable panic bolts or other suitable fastenings which must:
 - (i) √ be placed not less than 900 mm and not more than 1100 mm above the floor level; and
 - (ii) √ permit the door to yield to normal pressure when applied in the direction of egress.

Add ACT D2.101 as follows:

ACT D2.101 Stairs serving small areas

A stair, in a Class 1 building, within a *sole-occupancy unit* in a Class 2 building or Class 4 part, providing access to a mezzanine, attic, storeroom or similar small area which does not exceed 50 m² in *floor area* need not meet the requirements of Part D2 provided the-

- (a) √ minimum head room clearance is at least 2 m;
- (b) √ minimum unobstructed width is at least 750 mm;
- (c) √ minimum width of the going at the midway point of the width of stair is at least 230 mm; and
- (d) √ riser/going relationship conforms with an acceptable stairslope appropriate for its use.

Add ACT D2.102 as follows:

ACT D2.102 Minimum size of doorways

In a Class 1 building and a *sole-occupancy unit* in a Class 2 or 3 or Class 4 part of a building, a doorway must be not less than 600 mm wide if it provides access to a-

- (a) √ bathroom, shower room or water closet; or
- (b) √ pantry, storeroom, or the like.

Add ACT D2.103 as follows:

ACT D2.103 Paving surfaces in public areas

Paving and floor surfaces in public areas, such as colonnades, arcades and entrance lobbies, must have a non-slip finish which meets the requirements of AS 1141.41, excluding clauses 10(g) to 10(k), and as a minimum polished frictional value of not less than 40.

SUPERCEDED

PART D3 ACCESS FOR PEOPLE WITH DISABILITIES

Add ACT D3.2(d) as follows:

ACT D3.2 Access to buildings

(d) \dot{y} a carparking space set aside for people with disabilities satisfies D3.4 if it complies with AS 2890.1.

SECTION E SERVICES AND EQUIPMENT

PART E1 FIRE-FIGHTING EQUIPMENT

Add ACT E1.3(b)(iv) and (v) as follows:

ACT E1.3 Fire hydrants

- (b) \dot{y} (iv) be located to suit ACT Fire Brigade operation procedures and must not be more than 90 m from any part of a building; and
- (v) \dot{y} have a copper-alloy wheel operated valve designed to open by a counter-clockwise rotation and fitted with "Storz" type couplings suitable for connection to ACT Fire Brigade equipment.

Delete E1.7 and insert ACT E1.7 as follows:

ACT E1.7 Fire and smoke alarms

A suitable fire and smoke alarm system complying with Specification E1.7 must be installed in:

- (a) \dot{y} a Class 2 building containing more than 3 residential *storeys* and containing 20 or more *sole-occupancy units*.
- (b) \dot{y} a Class 3 building-
- (i) \dot{y} of more than 2 *storeys* and which provides sleeping accommodation for more than 12 persons in other than the ground *storey*;
 - (ii) \dot{y} where the *floor area* of the building exceeds 1000 m² and where the entrance doorway of any *sole-occupancy unit* is more than 6 m from a road or *open space*; or
 - (iii) \dot{y} provides accommodation for the aged, children or people with disabilities;
- (c) \dot{y} every Class 5 or 6 building and any Class 4 part therein:
- (i) \dot{y} where the building is of more than 3 *storeys*; or
 - (ii) \dot{y} where the *floor area* of the building exceeds 1000 m²;
- (d) \dot{y} every Class 7 or 8 building and any Class 4 part therein:
- (i) \dot{y} where the building is of more than 3 *storeys*; or
 - (ii) \dot{y} where the *floor area* of the building exceeds 1500 m²;
- (e) \dot{y} every Class 9a building; and
- (f) \dot{y} every Class 9b building-
- (i) \dot{y} where the building provides accommodation for 500 persons or more, calculated in accordance with Table D1.13, in any *storey*; or

- (ii) \dot{y} where the building provides accommodation for 100 persons or more, calculated in accordance with Table D1.13, in other than the ground storey.

ACT SPECIFICATION E1.5 FIRE SPRINKLER SYSTEMS

Substitute clause 2 with:

2. \dot{y} Adoption of AS 2118

In addition to the requirements of AS 2118, all sprinkler valve rooms and enclosures containing boosters must be locked and keyed to the ACT Fire Brigade Sprinkler Master Key System.

ACT SPECIFICATION E 2.6 SMOKE EXHAUST SYSTEMS

Substitute clause 4(c) and add 4(d), (e) and (f) as follows:

4. \dot{y} Location of exhaust outlets

- (c) \dot{y} discharge directly to the outside through suitable terminal fittings-
 - (i) \dot{y} positioned at least 5 m from any openable *window*, air intake opening or boundary with an adjoining site; and
 - (ii) \dot{y} at least 2 m above any road surface, pavement level, public space, open balcony or the like and if less than 3 m directed at a minimum angle of 30° above the horizontal,
or otherwise in a manner that will not spread fire or smoke to adjacent *fire-compartments* or buildings;
- (d) \dot{y} outlets must be designed and constructed to take into account under all conditions of normal operation the effects of wind, adjacent structures and other factors so that the exhaust capacity of fans is not reduced below the requirements of figure 2 of this Specification;
- (e) \dot{y} exhaust air deemed to be obnoxious in accordance with the AS 1668.2 must be discharged to the outside of the building in accordance with the rule 3.11.2 of AS 1668.2; and
- (f) \dot{y} external openings for fresh air and outside air intake located-
 - (i) \dot{y} at least 2 m above finished ground level of any road surface, pavement level, public space, open balcony or the like; and
 - (ii) at least 600 mm above finished ground level in any other case,
satisfies the requirements of rules 2.1.1 of AS 1668.1 and 3.2 of AS 1668.2.

PART E5 MAINTENANCE OF SAFETY INSTALLATIONS

Delete E5.2 and insert ACT E5.2 as follows:

ACT E5.2 Maintenance requirements

Safety installations in buildings must be adequately maintained in good order by adequate inspections, testing procedures and maintenance work.

Add ACT E5.101 as follows:

ACT E5.101 Maintenance deemed-to-satisfy

Maintenance inspections, testing, procedures and maintenance work carried out in accordance with ACT E5.102, ACT E5.103 and ACT Table E5.101 satisfies ACT E5.2.

Add ACT E5.102 as follows:

ACT E5.102 Maintained items

The inspection, testing and maintenance in good working order must be carried out:

- (a) ý in accordance with ACT Table E5.101;
- (b) ý by a person who is competent to carry out the inspection, testing and maintenance;
- (c) ý recorded and accounted for in a log book in accordance with ACT E5.103; and
- (d) ý in the following cases:
 - (i) ý *required automatic* fire doors, fire *windows* and fire shutters;
 - (ii) ý *a required fire main or hydrant*;
 - (iii) ý a lift installation;
 - (iv) ý *a required* emergency lighting installation;
 - (v) ý *a required automatic* fire sprinkler installation;
 - (vi) ý parts of an air-handling system that are subject to E2.4, E2.5 and E2.7;
 - (vii) ý *a required* smoke exhaust system;
 - (viii) ý *a required automatic* fire detection and alarm installation.
 - (ix) ý *a required* emergency warning and intercommunication system.

Add ACT E5.103 as follows:

ACT E5.103 Logbooks

A logbook *required* by ACT E5.102 must:

- (a) ý be kept in a suitable fire-resistant location when not in actual use and be accessible for inspection at all reasonable times; and
- (b) ý record for each of the maintained items, whether or not other records are *required* by any applicable Australian Standard;
 - (i) ý the date of the inspection or test;
 - (ii) ý the identity of the person making the inspection or test;
 - (iii) ý the identity of the maintained item inspected or tested;
 - (iv) ý whether the maintained item was in good working order; and
 - (v) ý if the maintained item was not in good working order, any remedial work carried out, completed and inspected or tested; and
 - (vi) ý the result of the inspection or test.
- (c) ý be retained by the owner for checking for such a period so that for any maintained item the record of the two previous inspections will be available at any time; and
- (d) ý contain all relevant documents pertaining to the approval granted pursuant to the provisions of the Building Act.

SUPERCEDED

Add ACT Table E5.101 as follows:

ACT Table E5.101 SCHEDULE OF MAINTAINED ITEMS

Item to be inspected or tested	Nature of inspection and/or test	Frequency of inspection
Opening protection		
A fire door, fire <i>window</i> and fire shutter where any such element is <i>required</i> to be installed in the particular opening concerned.	Operate and inspect for compliance with the provisions of Section C	AS 1851.7
Egress		
(a) <i>Exits</i> and paths of travel including doors and doorways, <i>exit</i> signs.	Inspect to ensure compliance Sections D and E.	Monthly
(b) <i>Required</i> handrails and balustrades.	Inspect for compliance with the requirements of ACT D2.16 and D2.17.	Annually
(c) Arrangements for safe egress in buildings with special security provisions.	Inspect to ensure the requirements of ACT D2.21 are being complied with.	Weekly
(d) Fail-safe release locking devices.	Inspection and testing to ensure the devices operate effectively.	Weekly
Signs		
(a) Signs concerning use of lifts in the event of fire and fire doors and stairs.	Inspect for legibility and installation in compliance with Figure E3.3	Annually
(b) <i>Exit</i> signs illumination		
Internally illuminated signs	Check that the lamp fitted matches the prescribed lamp rating marked on the sign fitting and in the logbook.	AS 2293.2
Externally illuminated signs	Check that illumination is not less than <i>required</i> by E4.	AS 2293.2
Emergency lighting		
<i>Required</i> emergency lighting	Inspect and maintain in accordance with the requirements of AS 2293.2.	AS 2293.2
Fire-fighting equipment		
(a) <i>Required</i> fire mains with associated valves, pumps, booster connections and the like	As prescribed in AS 1851.3as though the maintained item is <i>required</i> by that Standard as a wet-pipe and booster system.	AS 1851.3 & 4 as <i>required</i> .
(b) <i>Required</i> portable fire extinguishers.	<i>Required</i> portable fire extinguishers as prescribed in AS 1851.1.	AS 1851.1
(c) <i>Required</i> fire hose reels.	<i>Required</i> fire hose reels as prescribed in AS 1851. 2.	AS 1851.2
(d) <i>Required</i> hydrants.	As prescribed in AS 1851.4as though they are <i>required</i> by the Standard, to the extent that the provisions of that rule can be applied.	AS 1851.4
Sprinklers		
(a) <i>Required</i> sprinkler installations.	As prescribed in AS 1851.3	AS 1851.3
(b) Plans of risk and emergency instructions.	Inspect for presence and legibility to comply with the provisions of rule 8.3, 8.4 and 8.5of AS 2118.	AS 1851.3

SUPERCEDED

SUPERCEDED

Air-handling systems		
(a) Fans, dampers, filter controls and other air handling equipment.	As prescribed in AS 1851.2	AS 1851.6
(b) Cooling towers, evaporative condensers, warm water storage and spa pools.	Inspect and check for bacterial concentrations associated with Legionnaires disease.	Quarterly-AS 3666
Smoke exhaust systems		
(a) Fan capacities and operation.	As prescribed in AS 1851.2	AS 1851.6
(b) Compartmentation.	As prescribed in AS 2665.	Quarterly
(c) Location of fans and discharge.	As prescribed in ACT Specification E2.6.	Quarterly
Automatic fire alarms		
(a) <i>Required automatic</i> fire alarms.	As prescribed in rule 214 of AS 1670 as appropriate.	AS 1851.8 <i>and</i>
(b) <i>Special situations and precautions and outdoor applications.</i>	Inspect for compliance with rules 2.4.4, 3.3.7 and 5.5 of AS 1670 as the case may require.	AS 1851.8 <i>and</i>
(c) <i>Tubular and pressure wave systems.</i>	Inspect for compliance with rule 3.4(b) of AS 1670.	AS 1851.8
(d) <i>Protection of lines of wire with melting elements.</i>	Inspect for compliance with rule 3.5(e) of AS 1670.	AS 1851.8
(e) <i>Compartmentation of roofs and ceilings.</i>	Ascertain for compliance with rule 4.6 of AS 1670.	AS 1851.8
(f) <i>Loss of power to master alarm-actuating device.</i>	Test for (simulated) loss of power and compliance with rule 2.5.8 of AS 1670.	AS 1851.8
(g) <i>Self-resetting current-limiting device for storage batteries.</i>	Operate and inspect for proper operation and compliance with rule 2.7.2 of AS 1670.	AS 1851.8
(h) <i>Clearances</i>	Inspect for compliance with rule 2.10.8 of AS 1670.	AS 1851.8
Lifts		
Lifts and associated equipment for operation in event of emergency.	Operate under simulated emergency conditions and check for compliance with the provisions of E3.4.	AS 1735
Fire protection - structure		
Compartmentation and fire protection of structural members.	Ascertain that any work performed or any occurrence, accidental or otherwise, has not resulted in any reduction in the fire-resistance rating or other fire protection provision of any part of the building installed as <i>required</i> by the BCA and ACT Appendix.	Annually

SECTION F HEALTH AND AMENITY

PART F1 DAMP AND WATERPROOFING

Delete F1.1 and insert ACT F1.1 as follows:

ACT F1.1 Drainage

- (a) ý The construction of a drainage system and the position and manner of discharge of a stormwater drain must not-
- (i) ý result in the entry of water into a building;
 - (ii) ý affect the stability of a building; or
 - (iii) ý create any unhealthy or dangerous condition on the site or within a building.
- (b) ý Stormwater drainage satisfies (a) if it is designed in accordance with ACT Specification F1.1 and-
- (i) ý where the *site* is provided with a stormwater main tie or a connection to a gutter or stormwater channel, any stormwater drain provided is connected to and discharged at that tie or connection; except that,
 - (ii) ý any paving, building or structure with a surface or roof area less than 40 m² from which rainwater is discharged at any point greater than 3 m from any boundary of the *site*, in a manner which avoids a concentrated flow of runoff, need not be connected to a stormwater tie, gutter or channel; and
 - (iii) ý underground stormwater drains may be omitted provided stormwater drainage and runoff is collected and channelled to the point of discharge by suitable gutters, channels, paving of adequate dimension and falls and with suitable sumps and connections.

Add ACT F1.101 as follows:

ACT F1.101 Shower and bath enclosures

Shower and bath enclosures must comply with ACT Specification F1.101.

Add ACT Specification F1.1 as follows:

ACT SPECIFICATION F1.1 STORMWATER DRAINAGE

1. ý Scope

This specification describes the design and method of installation of stormwater systems.

2. ý Design standards

The gutter and downpipe sizes specified in clause 3 are deemed to be adequate for-

- (a) ý eaves, gutters and downpipes - a 20 year Average Recurrence Interval (ARI) rainfall intensity over a 5 minute duration of 137 mm/hour,
- (b) ý internal box gutters and downpipes - 1 in 100 year rainfall intensity over a 5 minute period of 194 mm/hour.

3. Gutter and downpipe sizes

Gutters and downpipes satisfy the design standards in clause 2 if they provide-

- (a) internal box gutters - 200 mm² per m² of roof area served;
 - (b) eaves gutters - 150 mm² per m² of roof area served;
 - (c) downpipes serving internal box gutters - 100 mm² per m² of roof area served; and
 - (d) downpipes serving eaves gutters - 70 mm² per m² of roof area served,
- and where gutter overflows for the discharge of stormwater are provided in box gutters and concealed eaves gutters where otherwise there would be a danger of internal flooding of the building.

4. Construction of stormwater drains

- (a) Suitable stormwater drains, gutters or channels must be provided to convey the water collected in accordance with Part F1 to the point of discharge.
- (b) Stormwater drainage lines construction must be:
 - (i) of brick, stone, concrete, vitreous clay (VC), unplasticised poly vinyl chloride (UPVC), fibre reinforced concrete (FRC), glass reinforced plastic (GRP), high density polyethylene (HDPE) conforming with AS 1254;
 - (ii) with internal diameter not less than 90 mm;
 - (iii) with regular falls and at a depth of not less than 300 mm below the finished ground level, or in the case of UPVC pipes, in accordance with AS 2566;
 - (iv) with area in cross-section of not less than 25 mm² per m² area served;
 - (v) where pipes exceed 150 mm internal diameter, with inspection openings or pits at each junction; and
 - (vi) with junctions made so that the upstream angle is not greater than 60°.
- (c) Stormwater drainage systems must provide separate drainage of each *site* to the point of discharge.
- (d) Where within or external to any building:
 - (i) oil, grease, petrol or liquid trade waste discharges onto an area drained by a stormwater system, a suitable interceptor trap must be installed and maintained in the stormwater drain before the tie with the stormwater main, gutter or channel;
 - (ii) interceptor traps so installed must be constructed such that:
 - (A) they are aerially disconnected from the inside of any building and ventilated to the outer air; and
 - (B) they are accessible for inspection and cleansing purposes.
- (e) Where ground or surface water is discharged into the stormwater main, the drainage system must trap silt at a location before the point of discharge to the stormwater main, gutter or channel.
- (f) Where the floor level of a *storey* has been constructed below the natural ground level or where a raising main is provided to discharge stormwater to the stormwater tie-
 - (i) suitable pumping facilities and/or overflow pumps may be *required* to prevent the entry of water into the building;

- (ii) direct drainage of basements into8: the stormwater main is not permitted; and
- (iii) ý floor washdown water is to be pumped up to a level above the overflow relief gully and directed to the sewer main.

5. ý Ground levels

- (a) ý The finished ground level under the building must be, unless other provisions have been made to prevent water entering that area, levelled and graded so as to prevent pooling of water under the building.
- (b) ý The level of ground floors is to be such that the lowest floor waste; fitting is a minimum of 150 mm above the level of the overflow relief gully (ORG) and the ORG level must be a minimum of 50 mm above a sewage overflow path in the case that the area surrounding the ORG is paved, or 150 mm above the overflow path if not paved.

Add ACT Specification F1.101 as follows:

ACT SPECIFICATION F1.101 ý SHOWER AND BATH ENCLOSURES

1. ý Scope

This specification describes the method of construction of shower and bath enclosures.

2. ý Construction

- (a) ý Shower and bath enclosures must be lined with impervious materials, constructed to prevent leaks and to ensure that moisture is prevented from adversely affecting the substrata and supporting structure.
- (b) ý The shower base must be-
 - (i) ý secured and adequately supported;
 - (ii) ý provided with watertight joints and adequate flashings;
 - (iii) ý turned up at least 100 mm behind the wall lining where constructed of non-corrosive sheet metal; and
 - (iv) ý completed with an appropriate finish and graded to the outlet.

PART F2 SANITARY AND OTHER FACILITIES

Insert in Table F2.1 as follows:

ACT Table F2.1 Provision of sanitary and other facilities

Class 3: Add (d) as follows:

- (d) ý additional sanitary facilities to meet the needs of visitors to common rooms, dining rooms or similar areas of Class 3 buildings must be provided, consisting of:
 - (i) ý for females, one water closet for every 100 residents, or part thereof, to a maximum of 4 water closets;
 - (ii) ý for males, one water closet and one urinal stall for every 200 residents, or part thereof, to a maximum of 2 water closets and two urinal stalls; and

- (iii) √ wash basins adjacent to every water closet and urinal stall, in the proportion of one wash basin to every two water closet pans and one wash basin for every two urinal stalls, or parts thereof.

PART F3 ROOM SIZES

Delete F3.2 and insert ACT F3.2 as follows:

ACT F3.2 Reduced height permissible

- (a) √ The heights of rooms may be reduced if the reduction does not unduly interfere with the proper functioning of the room in-
 - (i) √ attic rooms;
 - (ii) √ rooms with a sloping ceiling or projection below ceiling line; or
 - (iii) √ other rooms or spaces.
- (b) √ A reduced height of not less than 2 m and extending over not more than 20% of the *floor area* of the room, satisfies (a).

Add ACT F3.101 as follows:

ACT F3.101 Carparking facilities

The design and layout of carparking facilities in buildings and surface carparks including parking spaces and aisle dimensions, parking arrangements, vehicle turning paths and ramp gradients, access driveways and approaches, queuing areas and headroom clearances must comply with AS 2890.1.

PART F4 LIGHT AND VENTILATION

Add ACT F4.5(c) as follows:

ACT F4.5 Ventilation of rooms

- (c) √ kitchen exhaust hoods, exhaust fans and ducts from hotplates and wall ovens, installed to remove air laden with grease generated by cooking must be constructed of *non-combustible* materials in accordance with AS 1668 and be ducted to the outside air at a safe point of discharge.

Delete F4.10(b)(i) and insert ACT F4.10(b)(i) as follows:

ACT F4.10 Sub-floor ventilation

- (b) √ (i) an adequately cross-ventilated space is provided of not less than 200 mm in depth between the lowest part of the floor, if suspended, and the ground surface, and evenly distributed openings in the *external walls* with an unobstructed area of not less than 2100 mm² per metre of the total perimeter of the subfloor area.

Add ACT F4.11(c) as follows:

ACT F4.11 Public carparks

- (c) √ the requirements of AS 1668 Part 2 may be modified to operate at 40% of the *required* air flow rate when the building is occupied if:

SUPERCEDED

- (i) ∫ the exhaust system is capable of extracting air at a rate of at least 10 litres per m² of *floor area*;
- (ii) ∫ a carbon monoxide (CO) monitoring system is installed which adjusts the mechanical exhaust air flow rate to maintain a CO level at less than 50 ppm;
- (iii) ∫ the CO monitoring system is provided with an audio and visible alarm to warn drivers and to indicate when the level of CO exceeds 50 ppm;
- (iv) ∫ the CO monitoring system is powered similar to an emergency lighting system; and
- (v) ∫ a manual override is provided to the control system.

Add ACT F4.101 as follows:

ACT F4.101 Level of artificial lighting

Where artificial lighting is installed in a building:

- (a) ∫ the artificial lighting satisfies ACT F4.4 if it complies with AS 1680;
- (b) ∫ a reference to "mounting height" in AS 1680 is, for the purposes of this subclause, a reference to the height measured from floor level to the centre of the light source.

Add ACT F4.102 as follows:

ACT F4.102 Artificial lighting of stairways and ramps

Except in a Class 1, Class 10 or Class 4 part of a building or within a *sole-occupancy unit* in a Class 2 or 3 building, artificial lighting in stairways and ramps (including landings) and internal corridors must-

- (a) ∫ have a minimum value of 30 lux at floor level; and
- (b) ∫ be provided by means of separate electrical wiring circuits from the main switchboard for the exclusive use of the stairway or ramp.

Add ACT F4.103 as follows:

ACT F4.103 Flyscreening

Flyscreening must be provided-

- (a) ∫ except in Class 10 buildings - to all permanent ventilation openings;
- (b) ∫ in Class 1, 2 and Class 4 parts of buildings - to external openable *windows* in-
 - (i) ∫ water closets, bathrooms containing water closet pans; and
 - (ii) ∫ laundries and kitchens;
- (c) ∫ in Class 3, 5, 6, 7, 8 and 9 buildings - to external openable *windows*, doors and other openings to-
 - (i) ∫ water closets, toilet rooms, laundries, bathrooms and shower rooms; and
 - (ii) ∫ kitchens and dining rooms; and
- (d) ∫ by means of-
 - (i) ∫ flyscreen mesh fitted over the entire area of opening;
 - (ii) ∫ tight fitting *self-closing* or *automatic* doors; or
 - (iii) ∫ a mechanically operated air curtain or other suitable device.

SUPERCEDED

PART F5 NOISE TRANSMISSION AND INSULATION

Delete F5.1 and insert ACT F5.1 as follows:

ACT F5.1 Application

This Part applies to-

- (a) √ Class 2 and 3 buildings; and
- (b) √ the installation of domestic air-conditioners, spa and swimming pool pumps, heaters and filter units, associated with Class 1, 2, 3 and 10 buildings.

SECTION G ANCILLARY PROVISIONS

PART G1 MINOR STRUCTURES AND COMPONENTS

Add ACT G1.1(c), (d) and (e) as follows:

ACT G1.1 Swimming Pools

- (c) √ Indoor or outdoor permanent bathing, wading and swimming pools must-
 - (i) √ where the capacity of the pool exceeds 10 m³-
 - (A) √ be of the recirculation type in which the water circulation is maintained through the pool by pumps, the water drawn from the pool being clarified and disinfected before being returned to the pool;
 - (B) √ have an outlet sump with antivortex cover or grating and have a skimming weir or overflow gutter or channel at high water level; and
 - (C) √ have means of egress provided in the form of ladders, steps in the floor of the pool or a ramp;
 - (ii) √ pools must be capable of being completely emptied and any discharge or overflow and pool backwash filter must be connected to the sewer drainage system;
 - (iii) √ pools must be watertight with smooth surfaces of non-absorbent, non-slip material, light in colour and with rounded corners to facilitate cleaning;
 - (iv) √ any surrounding concourses must be graded away from the pool;
 - (v) √ diving boards must-
 - (A) √ have a non-slip surface;
 - (B) √ up to 1 m above water level, be only installed where the depth for diving is not less than 2600 mm; and
 - (C) √ over 1 m and up to 3 m above water level, be only installed where the depth for diving is not less than 3000 mm.
- (d) √ Pools in or forming part of buildings other than Class 1 buildings-
 - (i) √ where in any part of the pool the depth is less than 1500 mm, the floor grade must not exceed a slope of 1 in 20;
 - (ii) √ permanent signs must be displayed on the side of the pool showing the depth in 300 mm intervals at the deep and shallow ends.
- (e) √ Luminaires and fixed electrical appliances such as filter pumps located in the pool area must be permanently connected except where it is necessary to

SUPERCEDED

remove such equipment for servicing, connection may be made with a water resistant plug socket located-

- (i) ý at a height of not less than 450 mm above the maximum water level or above the coping of the pool; or
- (ii) ý for an above-ground pool, at a height of not less than 450 mm above ground level, at a distance not less than 1 m from the water's edge.

Add ACT G1.101 as follows:

ACT G1.101 Dividing fences

A dividing fence erected on or near the boundary between two adjoining parcels of land, means, for the purposes of the *Dividing Fences Act*-

- (a) ý a basic urban fence if a timber paling fence of a height of 1.5 m above finished ground level and consisting of-
 - (i) ý reinforced spade-end precast concrete posts spaced at 2.4 m;
 - (ii) ý 75 x 50 mm hardwood rail located at top and bottom of fence and bolt fixed to posts; and
 - (iii) ý 100 x 12 mm hardwood palings nailed to rails.
- (b) ý a basic rural fence if a wire fence of a height of 1.2 m above finished ground level and consisting of:
 - (i) ý Intermediate post - steel line posts spaced at 4 m intervals.
Strainer post - hardwood post spaced at 40 m intervals with hardwood bracing at corners.
 - (ii) ý 3 mm galvanised steel wire at top and bottom and at intermediate of fence; and
 - (iii) ý 1060 mm wide x 40 mm mesh size galvanised wire netting.

Add ACT G1.102 as follows:

ACT G1.102 Flammable liquids stores

The construction of storage facilities for the keeping of flammable liquids and dangerous goods as defined under the provisions of the Dangerous Goods Act must comply with-

- (a) ý all other relevant provisions of the BCA and ACT Appendix; and
- (b) ý the relevant rules of AS 1940, except that if the separation distance prescribed in Tables 3.1, 3.2 and 4.4 cannot be met, a screen wall with an FRL of at least 120/120/120 and having the prescribed distance should be provided so as to prevent the spread of fire.

Add G1.103 as follows:

ACT G1.103 Awnings and projections

Every awning, projection or the like, attached to, or supported from a building other than a Class 1 or 10 building must-

- (a) ý comply with B1.1;
- (b) ý have all supporting members constructed of *non-combustible* material or be lined on the underside with non-combustible material;

SUPERCEDED

SUPERCEDED

- (c) ŷ if it has a roof, be covered with *non-combustible* or fire-retardant material which is impervious to moisture;
- (d) ŷ if projecting over a boundary onto or over unleased land-
 - (i) ŷ in no part be less than 2.7 m above finished pavement or finished ground level;
 - (ii) ŷ be set back not less than 750 mm from any kerb or the edge of any place accessible to vehicles; and
 - (iii) ŷ where the height to the underside of the awning is at least 3.8 m above finished pavement or ground level, the awning may align with, but not project beyond, the kerb or the edge of any place accessible to vehicles; and
- (e) ŷ not have any signs or other attachments projecting lower than 2.3 m above the finished pavement or ground surface.

Add ACT G1.104 as follows:

ACT G1.104 Garbage facilities

- (a) ŷ An allotment with up to seven Class 1 buildings must be provided with individual domestic garbage bin storage spaces, or one or more bin enclosures-
 - (i) ŷ with at least one garbage bin space with minimum dimension of 600 mm wide x 600 mm deep x 700 mm high for each building or each *sole-occupancy unit* within the building;
 - (ii) ŷ located in a position accessible at all times by waste collectors and immediately adjacent to a suitable vehicular roadway.
- (b) ŷ An allotment with more than seven Class 1 buildings and every Class 2 to 9 building must be provided with one or more enclosed storage areas to accommodate one or more commercial waste containers-
 - (i) ŷ with a hard-paved floor area graded to a sump connected to the sewer and with a water tap to facilitate cleaning and with an apron graded 1:20 to the access road; and
 - (ii) ŷ located in a position accessible at all times to motorised waste compaction vehicles from a suitable roadway; and
 - (iii) ŷ with minimum dimensions to suit any of the following waste containers as necessary:

No. of Containers	Container size	Enclosure dimension (internal)
1 ŷ	1.5 m	3 m x 2.3 m x 1.8 m high
2 ŷ	1.5 m	5 m x 2.3 m x 1.8 m high
1	2.3 m	3 m x 3 m x 1.8 m high
2	2.3 m	5 m x 3 m x 1.8 m high
1 ŷ	3 m	3 m x 4 m x 1.8 m high

Note: ŷ The selection of the size of waste container will depend on the anticipated amount of waste generated from the building and may be determined in accordance with guidelines prepared by City Engineering Section, Department of Urban Services.

- (c) Where storage space for a motorised waste compaction vehicle is provided in a building, that space must have-

SUPERCEDED

SUPERCEDED

- (i) ý dimensions of at least 3.6 m wide x 9.0 m length x 3.8 m minimum height clearance;
 - (ii) ý a floor surface-
 - (A) ý with gradient in any direction not exceeding 1 in 20;
 - (B) ý capable of withstanding the loads imposed during the operation of a motorised waste compaction vehicle; and
 - (iii) ý suitable access roadways, ramps and turning areas providing access to the storage area.
- (d) ý A roadway in the form of a through laneway or cul-de-sac with turning area satisfies ACT G5.101(a)(b) and (c) if it-
- (i) ý withstands the loads imposed during the operation of a motorised waste compaction vehicle; and
 - (ii) ý provides-
 - (A) ý a minimum width of 4.5 m for a one-way straight road or 5 m for a cul-de-sac;
 - (B) ý a minimum internal radius of 8.5 m;
 - (C) ý a minimum inside radius on all curves of 10 m; and
 - (D) ý a maximum gradient of 1 in 8.

PART G2 ý HEATING APPLIANCES, FIREPLACES, CHIMNEYS AND FLUES

Add ACT G2.2(d) and (e) as follows:

ACT G2.2 Installation of appliances

- (d) ý An industrial fuel-fired appliance: AS 1375;
- (e) ý storage tanks and other associated fittings: AS 1692, as applicable for tanks in category 1 only.

Add ACT G2.3(e) as follows:

ACT G2.3 Open fireplaces deemed to comply

- (e) ý in the case of a solid-fuel burning appliance in which the fuel burning compartment is not enclosed-
 - (i) ý a flue constructed of cast iron, cellulose fibre reinforced cement not less than 9.5 mm thick, galvanised steel not less than 1.2 mm thick or such other material of at least equivalent strength and durability, installed in accordance with Section 6 of AS 1691, as though it is a flue connected to an oil heating appliance;
 - (ii) ý the heat producing appliance installed to allow ample air circulation and ventilation;
 - (iii) ý footings and floor structures strengthened as necessary for the imposed load of the fireplace so as to maintain structural adequacy; and
 - (iv) roof penetrations for flues treated in such a manner so as to not impair the structural adequacy of the roof and to be weatherproof.

SUPERCEDED

Add ACT G2.101 as follows:

ACT G2.101 Boilers

- (a) ý A boiler to which AS 1200 applies, must be provided with a flue and both must be installed in accordance with the relevant rules of the appropriate Standard.
- (b) ý In relation to any boiler or furnace installed within or forming part of a building:
 - (i) ý every part of a floor under or within a distance of 1800 mm from a boiler or furnace must be constructed of materials having an FRL of 120/120/120;
 - (ii) ý every part of a wall within a distance of 1800 mm and every part of a ceiling or roof above and within a distance of 1800 mm from any boiler or furnace must be of non-combustible material; and
 - (iii) ý where the heating unit is self-insulated the provisions of clause ý G2.101(b)(ii) need not apply. ý

Add ACT G2.102 as follows:

ACT G2.102 Chimneys and flues

- (a) ý A flue must not be used to convey the hot products of combustion from more than one appliance or fireplace except in the case of-
 - (i) ý boilers referred to in ACT G2.101 where AS 1200 permits otherwise;
 - (ii) ý oil-fired appliances referred to in ACT G2.2, where AS 1691, AS 1375, or AS 1940 permits otherwise; or
 - (iii) ý open fireplaces and solid-fuel burning appliances referred to in G2.2 where AS 2918 permits otherwise.

INTRODUCTION ý

The New South Wales BCA Appendix includes variations from the requirements of the June 1990 edition of the Building Code of Australia (BCA).

CONTENTS ý

This Appendix contains the BCA provisions that have been varied and additional provisions for application in New South Wales, as follows:

A - GENERAL PROVISIONS

NSW Specification A1.3 Standards Adopted by Reference.

B - STRUCTURE

NSW B1.101 Foundations

C - FIRE RESISTANCE

NSW C1.2 Calculation of rise in storeys
NSW C1.5 Two storey Class 2 or 3 buildings
NSW C1.6 Class 4 parts of buildings
NSW C1.7 Open spectator stands and indoor sports stadiums
NSW C1.8 Lightweight construction
NSW C1.101 Hollow glass-block window panels
NSW C2.5 Class 9a buildings
NSW C2.7 Separation by fire walls
NSW C3.2 Protection of openings in external walls
NSW C3.5 Doorways in fire walls
NSW C3.6 Sliding fire doors
NSW C3.7 Protection of doorways in horizontal exits
NSW C3.8 Openings in fire-isolated exits
NSW C3.11 Bounding construction: Class 2, 3 and 4 buildings
NSW Specification C1.1 Fire-resisting Construction. ý
NSW Specification C1.9 Fire-resistance of Class 1 and 10 Buildings. ý
NSW Specification C3.4 Fire Doors, Smoke Doors, Fire Windows and ý Shutters.

D - ACCESS AND EGRESS

NSW D1.4 Exit travel distances
NSW D1.5 Distance between alternative exits
NSW D1.6 Dimensions of exits

SUPERCEDED

NSW D1.7	Travel via fire-isolated exits ý
NSW Table D1.13	Area per person according to use ý
NSW D1.15	Method of measurement ý
NSW Table D2.13	Riser and going dimensions. ý
NSW D2.19	Doorways and doors ý
NSW D3.1	Application of Part ý
NSW D3.2	Access to buildings ý
NSW D3.4	Concessions ý
NSW D3.101	Car parking ý

E - SERVICES AND EQUIPMENT

NSW E1.2	Fire mains and water supply services
NSW Table E1.4	Requirements for fire hose reels
NSW E2.1	Smoke control
NSW Table E2.2	Means of excluding smoke from fire-isolated exits
NSW E2.7	Pressurisation systems
NSW E3.4	Emergency lifts
NSW E4.8	Design and operation of exit signs
NSW E5.3	Mechanical ventilation and warm water systems
NSW Specification E1.2	Fire Mains and Water Supply Services.
NSW Specification E1.7	Fire Detection and Alarm Systems.
NSW Specification E2.4	Air Handling Systems.
NSW Specification E2.6	Smoke Exhaust Systems.

F- HEALTH AND AMENITY

NSW F1.9	Acceptable damp-proof courses ý
NSW Table F2.4	Sanitary facilities for people with disabilities ý
NSW F2.7	Warm water installations ý
NSW F3.101	Minimum floor areas ý
NSW F3.102	Increased floor area required ý
NSW F3.103	Certain floor area to be disregarded ý
NSW F4.4	Artificial lighting ý
NSW F4.5	Ventilation of rooms ý
NSW F4.6	Natural ventilation ý
NSW F4.10	Sub-floor ventilation ý

G - ANCILLARY PROVISIONS

NSW G1.1	Swimming pools
NSW G3.6	Separation at roof
NSW Specification G3.8	Fire and Smoke Control Systems in Buildings Containing Atriums.

SUPERCEDED

SECTION A GENERAL PROVISIONS

PART A1 INTERPRETATION

NSW SPECIFICATION A1.3 \dot{y} STANDARDS ADOPTED BY REFERENCE

In Table 1, insert additional Specifications, as follows:

NSW Table 1: SCHEDULE OF REFERENCED DOCUMENTS

No.	Date	Title	BCA Clause(s)
Ministerial Specification No.2			
		Hollow Glass-block Window Panels	NSW C1.101
Ministerial Specification No.10			
		Fire Mains, Certain Water Service Pipes, Hydrants, Hose Reels and Water Supply	NSW E1.2

SECTION B STRUCTURE

PART B1 STRUCTURAL PROVISIONS

Insert NSW B1.101 as follows:

NSW B1.101 Foundations

Bearing pressures on the foundation of a building must not exceed the values specified in Table B1.101 unless higher pressures are justified by a geotechnic foundation investigation.

Table B1.101 ALLOWABLE BEARING PRESSURES

Foundation	Allowable bearing pressures (kPa)
Made ground	0-300
Soft clay or loam	100
Confined wet sand	150
Medium clay or sandy clay	200
Hard dry clay or dense sand	300
Soft shale	400
Weathered rock or medium shale	600
Shale rock at 600 mm from the boundary	1000
Shale rock at the boundary	650
Soft sandstone, free from defects to a depth of 450 mm and with a total seam thickness not exceeding 20 mm for the next 450 mm of depth, where the footing is 900 mm or more from the boundary	1300
Soft sandstone, free from defects to a depth of 450 mm and with a total seam thickness not exceeding 20 mm for the next 450 mm of depth,	

where the footing is at the boundary	850
Medium sandstone, free from defects to a depth of 600 mm and with a total seam thickness not exceeding 20 mm for the next 600 mm of depth, where the footing is 1200 mm or more from the boundary	2100
Medium sandstone, free from defects to a depth of 600 mm and with a total seam thickness not exceeding 20 mm for the next 600 mm of depth, where the footing is at the boundary	1400
Hard sandstone, free from defects to a depth of 900 mm and with a total seam thickness not exceeding 20 mm for the next 900 mm of depth, where the footing is 1800 mm or more from the boundary	3200
Hard sandstone, free from defects to a depth of 900 mm and with a total seam thickness not exceeding 20 mm for the next 900 mm of depth, where the footing is at the boundary	2100
Hard igneous rock free from gas holes	4300
Massive crystalline bed rock	8500

SECTION C FIRE RESISTANCE

PART C1 FIRE RESISTANCE AND STABILITY

Delete C1.2(b)(i) and insert NSW C1.2(b)(i) and (d), as follows:

NSW C1.2 Calculation of rise in storeys

(b) \hat{y} A *storey* is not counted if-

(i) \hat{y} it is situated at the top of the building and contains only heating, ventilating or lift equipment, water tanks, or similar service units or equipment; or

(d) \hat{y} A *mezzanine*, or two or more *mezzanines* at or near the same level in a building and having an aggregate *floor area* which is more than $\frac{1}{3}$ of the *floor area* of the room are regarded as a *storey* in that part of the building in which they are situated.

Delete C1.5 and insert NSW C1.5 as follows:

NSW C1.5 Two storey Class 2 or 3 buildings

A building of Class 2 or 3, or a mixture of these Classes, having a *rise* of 2 *storeys*, may be of Type C construction if-

(a) \hat{y} each *sole-occupancy unit* and all other parts of the building are served by at least 2 *exits*; or

(b) \hat{y} each *sole-occupancy unit* in the building has its own direct access to a road or *open space* and all other parts of the building are served by at least 2 *exits*.

Delete C1.6 and insert NSW C1.6 as follows:

NSW C1.6 Class 4 parts of buildings

A Class 4 part of a building *requires* the same FRL for building elements, and the same construction separating the Class 4 part from the remainder of the building, as a Class 2 part in similar circumstances.

Delete C1.7 and insert NSW C1.7 as follows:

NSW C1.7 Open spectator stands and indoor sports stadiums

- (a) *ý* An *open spectator stand* or indoor sports stadium which has only changing rooms, sanitary facilities or the like below the tiered seating, need not comply with the other provisions of this Part if it contains not more than one tier of seating and is of Type C and *non-combustible* construction.
- (b) *ý* In (a), one tier of seating means numerous rows of tiered seating incorporating cross-overs but within one viewing level.

Add NSW C1.8(c) as follows:

NSW C1.8 Lightweight construction

- (c) *ý* Subclause (b) does not apply to any Class 6 part that is for use as-
- (i) *ý* a cafe or restaurant;
 - (ii) *ý* a tea room, coffee or milk bar; or
 - (iii) *ý* a hairdresser's shop; or
 - (iv) *ý* a shop of any other kind, the normal functioning and servicing of which would not represent undue risk of damage to the *lightweight construction* of any beam, column or wall.

Add NSW C1.101 as follows:

NSW C1.101 Hollow glass-block window panels

Window panels of hollow glass-blocks installed in an opening *required* to be protected by fire *windows* or construction having an FRL of 60/60/ - , must comply with Ministerial Specification No.2.

PART C2 COMPARTMENTATION AND SEPARATION

Delete C2.5(c)(iii) and insert NSW C2.5(c)(iii) as follows:

NSW C2.5 Class 9a buildings

- (c) *ý* (iii) not incorporate any other opening which is not smoke-proof other than an opening for smoke control in accordance with Part E2; and

Delete lead-in to C2.7 and insert NSW C2.7 lead-in as follows:

NSW C2.7 Separation by fire walls

A part of a building separated from the remainder of the building by a *fire wall* is treated as a separate building for the purposes of Sections C, D and E, if-

PART C3 PROTECTION OF OPENINGS

Delete C3.2(a) and (b) and insert NSW C3.2(b) as follows:

NSW C3.2 Protection of openings in external walls

- (a) *ý* (deleted);
- (b) *ý* be protected if not located in a *storey* at or near ground level in accordance with C3.4 if it is situated less from a *fire-source feature* to which it is exposed than-

SUPERCEDED

- (i) 3 m from a side or rear boundary of the allotment;
- (ii) 6 m from the far boundary of a road adjoining the allotment; or
- (iii) 6 m from another building on the allotment that is not Class 10; and

Delete C3.5(a) and (c), and insert NSW C3.5(a) and (c) as follows:

NSW C3.5 Doorways in fire walls

- (a) two fire doors or fire shutters, one on each side of the doorway, each of which-
 - (i) has an FRL of not less than 1/2 that *required* by Specification C1.1 for the *fire wall*; and
 - (ii) is *self-closing*, or *automatic* with the closing operation initiated by the activation of-
 - (A) a smoke detector installed in accordance with AS 1670 located on each side of the *fire wall* not more than 1.5 m horizontal distance from the opening; and
 - (B) any other suitable fire alarm system, including a *sprinkler system* in either *fire-compartment* separated by the *fire wall*;
- (c) a single fire door or fire shutter, that is not a metallic fire shutter, which-
 - (i) has an FRL of not less than that *required* by Specification C1.1 for the *fire wall*; and
 - (ii) is *self-closing*, or *automatic* with the closing operation initiated by the activation of-
 - (A) a smoke detector installed in accordance with AS 1670 located on each side of the *fire wall* not more than 1.5 m horizontal distance from the opening; and
 - (B) any other suitable fire alarm system, including a *sprinkler system* in either *fire-compartment* separated by the *fire wall*; and

Delete C3.6 and insert NSW C3.6 as follows:

NSW C3.6 Sliding fire doors

If a doorway in a *fire wall* is fitted with a sliding fire door which is open when the building is in use-

- (a) it must be held open with an electro-magnetic device, which when de-activated by-
 - (i) thermal or smoke detectors as appropriate installed in accordance with AS 1905.1; and
 - (ii) by any other suitable fire alarm system, including a *sprinkler system* installed within the building, allows the door to be fully closed not less than 20 seconds, and not more than 30 seconds, after release; and
- (b) in the event of a power failure to the door - the door must fail safe in the closed position in accordance with (a);
- (c) an audible warning device must be located near the doorway and a red flashing warning light of a suitable intensity on each side of the doorway must be activated in conjunction with the operation of the fire door when a *required* detector or *sprinkler system* in either *fire-compartment* separated by the *fire wall* is activated; and

SUPERCEDED

SUPERCEDED

- (d) ý signs must be installed on each side of the doorway located directly over the opening stating-

"WARNING - SLIDING FIRE DOOR"

in capital letters not less than 50 mm high in a colour contrasting with the background.

Delete C3.7 and insert NSW C3.7 as follows:

NSW C3.7 Protection of doorways in horizontal exits

- (a) ý A doorway that is part of a *horizontal exit* must be protected by either-
- (i) ý a single fire door that has an FRL of not less than that *required* by Specification C1.1 for the *fire wall* except that the *insulation* level need not exceed 30; or
 - (ii) ý in a Class 7 or 8 building - two fire doors, one on each side of the doorway, each with an FRL of not less than 1/2 that *required* by Specification C1.1 for the *fire wall* except that the *insulation* level of each door need not exceed 30.
- (b) ý In all cases, each door must be-
- (i) ý *self-closing* or *automatic* with the *automatic* closing operation initiated by the activation of-
 - (A) ý a smoke detector installed in accordance with AS 1670 located on each side of the *fire wall* not more than 1.5 m horizontal distance from the opening; and
 - (B) ý any other suitable fire alarm system, including a *sprinkler system* in either *fire-compartment* separated by the *fire wall*; and

Delete C3.8(a) and insert NSW C3.8(a) as follows:

NSW C3.8 Openings in fire-isolated exits

- (a) ý Doorways that open to *fire-isolated stairways*, fire-isolated passageways or fire-isolated ramps and are not doorways opening to a road or *open space* must be protected by 60/60/30 fire doors that-
- (i) ý are *self-closing* or *automatic* with the *automatic* closing operation initiated by the activation of-
 - (A) ý a smoke detector installed in accordance with AS 1670 located not more than 1.5 m horizontal distance from the approach side of the opening; and
 - (B) ý any other suitable fire alarm system, including a *sprinkler system*, installed within the building.

Delete C3.11(b), (c) and (d), and insert NSW C3.11(b), (c), (d) and (e), as follows:

NSW C3.11 Bounding construction: Class 2, 3 and 4 buildings

- (b) ý A doorway in a Class 2 or 3 building must be protected if it provides access from a room not within a *sole-occupancy unit* to-
- (i) ý a *public corridor*, public hallway, or the like; or
 - (ii) ý the landing of an internal non-*fire-isolated stairway* that serves as a *required exit*.

SUPERCEDED

SUPERCEDED

- (c) ý A doorway in a Class 4 part must be protected if it provides access to any other internal part of the building;
- (d) ý Protection for a doorway must be at least-
 - (i) ý in a building of Type A construction - a *self-closing* 60/60/30 fire door; and
 - (ii) ý in a building of Type B or C construction - a *self-closing*, tight fitting, solid core door, not less than 35 mm thick.
- (e) ý Other openings in *internal walls* which are *required* to have an FRL to inhibit the lateral spread of fire must not reduce the *fire-resisting* performance of the wall.

NSW SPECIFICATION C1.1 ý FIRE-RESISTING CONSTRUCTION

After 2.5(e), add (f) as follows:

2.5 ý General concessions

- (f) ý For the purposes of (a), a building that contains 2 *storeys* in some of its parts and 1 *storey* only in its remaining parts is deemed to contain 1 *storey* if the sum of the *floor areas* of the upper *storeys* of its 2 *storey* parts does not exceed-
 - (i) ý 1/8 of the sum of the *floor areas* of the 1 *storey* parts;
 - (ii) ý in the case of a building to which one of the maximum *floor areas* specified in Table C2.2 is applicable - 1/10 of that area; or
 - (iii) ý in the case of a building to which two or more of the maximum *floor areas* specified in Table C2.2 is applicable - 1/10 of the lesser of those areas, whichever is the lesser.

Delete 3.2(d) and insert new (d) as follows:

3.2 ý Concessions for floors

- (d) ý it is within the same *sole-occupancy unit* in a Class 2 or 3 building or Class 4 part.

Delete 3.6(b)(ii) and insert new (b)(ii) as follows:

3.6 ý Rooflights

- (b) ý (ii) any part of the building which projects above the roof unless that part has the FRL *required* of a *fire wall* and any openings in that part of the wall for 6 m vertically above the roof light are protected in accordance with C3.4;

NSW SPECIFICATION C1.9 ý FIRE-RESISTANCE OF CLASS 1 AND 10 BUILDINGS

Delete 2(a)(i) and insert new (a)(i) as follows:

2. ý External walls of Class 1 buildings

- (a) ý (i) the wall is set back less than 900 mm from an allotment boundary other than the boundary adjoining a road alignment or other public space; or

Delete 3(b):

3. ý Class 1 buildings: Construction of external walls

(b) (deleted). ý

Delete clause 8 and insert new clause 8 as follows: ý

8. ý Separating floors

The underside of a floor separating *sole-occupancy units*, each being a separate domicile and located one above the other, must be lined with a *fire protective covering*.

NSW SPECIFICATION C3.4 ý FIRE DOORS, SMOKE DOORS, FIRE WINDOWS AND SHUTTERS

Delete subparagraph 3(b)(ii) and insert new 3(b)(ii) as follows:

3. ý Smoke doors

- (b) ý (ii) close *automatically* with the *automatic* closing operation initiated by smoke detectors in accordance with AS 1670 located on each side of the doorway not more than 1.5 m horizontal distance from the opening; and
- (iii) ý in the event of a power failure to the door - the door must fail-safe in the closed position.

SECTION D ACCESS AND EGRESS

PART D1 PROVISION FOR ESCAPE

Add NSW D1.4(a)(iii) as follows:

NSW D1.4 Exit travel distances

- (a) ý (iii) The distance from the entrance doorway of a *sole-occupancy unit* to a single *exit* serving the *storey* at the level of access to a road or *open space* may be increased to 20 m.

Delete D1.5 and insert NSW D1.5 as follows:

NSW D1.5 Distance between alternative exits

Exits that are *required* as alternative means of egress must-

- (a) ý be distributed as uniformly as practicable within or around the *storey* served and in positions where unobstructed access to at least 2 *exits* is readily available from all points on the floor including lift lobby areas;
- (b) ý be not less than-
- (i) 9 m apart in Class 2, 3 and 9 buildings; or
- (ii) ý 6 m apart in all other cases; and
- (c) ý be not more than-
- (i) ý 45 m apart in a Class 2 or 3 building or a *storey* containing a *patient care area* in a Class 9a building; and

- (ii) γ 60 m apart in all other cases; and
- (d) γ be located so that alternative paths of travel do not converge such that they become less than 6 m apart.

Delete D1.6(f)(iv) and insert NSW D1.6(f)(iv) as follows:

NSW D1.6 Dimensions of exits

- (f) γ (iv) in any other case - 750 mm wide; and

Add NSW D1.7(b)(iii) as follows:

NSW D1.7 Travel via fire-isolated exits

- (b) γ (iii) into a pedestrian colonnade that-
 - (A) γ immediately adjoins a road or *open space*;
 - (B) γ extends along the length of the allotment;
 - (C) γ has an unobstructed height of not less than 3.2 m throughout;
 - (D) γ is fully open along the side that adjoins the road or *open space* for an unobstructed height of not less than 3.2 m; and
 - (E) γ provides an unimpeded path of travel from the point of discharge to the road or *open space* of not more than 6 m.

Substitute the reference to "Shop" and "Showroom" in Table D1.13 as follows:

NSW Table D1.13 AREA PER PERSON ACCORDING TO USE

TYPE OF USE	m ² per person
Shop - space for sale of goods including arcades, through-site links, covered malls and the like-	
(a) at a level entered direct from the open air or at any lower level	3
(b) all other levels	5
Showroom - display area	5

Insert NSW D1.15(h) as follows:

NSW D1.15 Method of measurement

- (h) γ In the case of a non-*fire-isolated stairway* or ramp, the distance is measured along a line connecting the nosings of the treads, or the slope of the ramp, together with the distance connecting those lines across any intermediate landings.

PART D2 CONSTRUCTION OF EXITS

Delete Table D2.13 and insert NSW Table D2.13 as follows:

NSW Table D2.13 RISER AND GOING DIMENSIONS

	RISER (R)		GOING (G) ^(b)		QUANTITY 2R+G	
	Max	Min	Max	Min	Max	Min
Public stairs	190	115	355	250	700	550

Private stairs ^(a)	190	115	355	240	700	550
-------------------------------	-----	-----	-----	-----	-----	-----

Note: (a) *Private stairs* are-

- (i) \dot{y} stairs in a Class 1 or 10 building;
- (ii) \dot{y} stairs in a *sole-occupancy unit* in a Class 2 building or Class 4 part; and
- (iii) \dot{y} in any building, stairs which are not part of a *required exit* and to which the public do not normally have access.

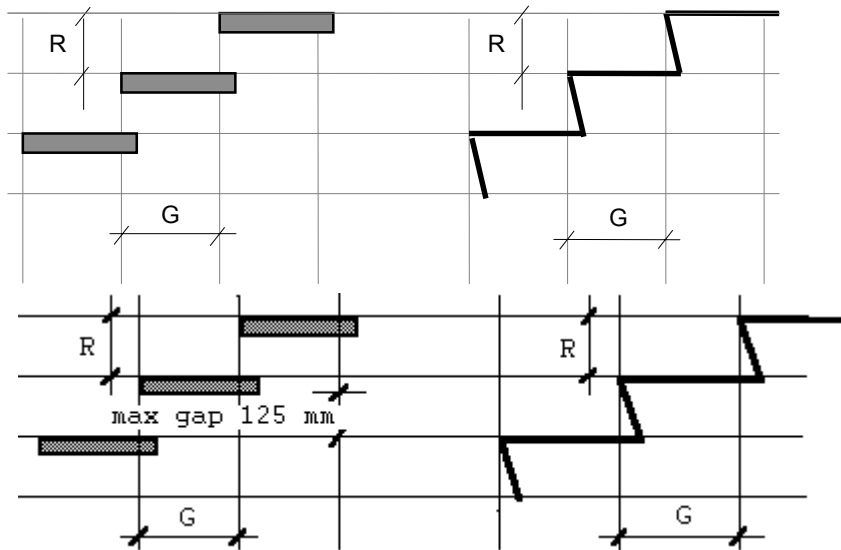

Note: (b) The going in tapered treads (as in a curved or spiral stair) is measured-

- (i) \dot{y} 270 mm in from the outer side if the flight is less than 1 m wide;
- (ii) \dot{y} 270 mm from each side if the flight is 1 m or more wide, and must be not less than 100 mm at the narrow end.

Delete D2.19(d)(ii) and insert NSW D2.19(d)(ii) as follows:

NSW D2.19 Doorways and doors

- (d) \dot{y} (ii) it must open *automatically* if there is a power failure to the door or on the activation of a fire or smoke alarm anywhere in the *fire-compartment* served by the door.

PART D3 ACCESS FOR PEOPLE WITH DISABILITIES

Delete D3.1 and insert NSW D3.1 as follows:

NSW D3.1 Application of Part

This Part applies to all Class 3, 5, 6, 7, 8, 9 and 10 buildings.

Delete D3.2(a) and (b) and insert NSW D3.2(a) and (b) as follows:

NSW D3.2 Access to buildings

- (a) ý from the alignment of the road adjoining the *site* of the building;
- (b) ý from any carpark space on the allotment (whether within or outside the building); and

In Table D3.2, substitute provisions for Class 3 buildings and *early childhood centres*, and add provisions for Class 10 buildings, as follows:

Table D3.2 ý REQUIREMENTS FOR ACCESS FOR PEOPLE WITH DISABILITIES

CLASS OF BUILDING ý	ACCESS REQUIREMENTS
Class 3	
(a) Common areas of buildings that are <i>required</i> to be accessible	To and within the public areas on the entrance floor and to every floor containing a <i>sole-occupancy unit</i> or accommodation <i>required</i> to be accessible.
(b) If the building contains-	To and within
up to 49 units	one <i>sole-occupancy unit</i> .
more than 49 but not more than 99	2 <i>sole-occupancy units</i> .
more than 99 units	3 <i>sole-occupancy units</i> .
(c) If accommodation is provided for more than 10 persons other than in <i>sole-occupancy units</i> -	
up to 49 beds	2 beds.
more than 49 but not more than 99	4 beds.
more than 99	6 beds.
Note: For the purposes of this Table, a double bed counts as 1 bed.	
An <i>early childhood centre</i>	To and within every room used by children and staff.
Class 10	To and within any area containing facilities such as showers and water closets for people with disabilities.

Delete D3.4(d) and insert NSW D3.4(d) as follows:

NSW D3.4 Concessions

- (d) ý in a building not containing a passenger lift where access is *required* to the entrance floor but not to the other levels, a *required* stair must comply with Rule 10 of AS 1428.1.

Add NSW D3.101 as follows:

NSW D3.101 Car parking

Car parking spaces for people with disabilities must-

- (a) ý be provided at the rate of one car parking space for each 100 spaces, or part thereof, in the following circumstances:
 - (i) ý a public car park *required* to be accessible; or
 - (ii) ý a Class 3 building which contains an accessible *sole-occupancy unit* or accommodation; or

- (iii) $\dot{\gamma}$ a car parking area on the same allotment as a building *required* to be accessible; and
- (b) $\dot{\gamma}$ comply with AS 1428.1; and
- (c) $\dot{\gamma}$ comply with (a) and (b) unless a parking service is provided and direct access to the car parking spaces by the general public or occupants is not permitted.

SECTION E SERVICES AND EQUIPMENT

PART E1 FIRE FIGHTING EQUIPMENT

Delete E1.2(a) and insert NSW E1.2(a) as follows:

NSW E1.2 Fire mains and water supply services

(a) $\dot{\gamma}$ comply with Ministerial Specification No.10;

Delete Table E1.4 and insert NSW Table E1.4 as follows:

NSW Table E1.4 REQUIREMENTS FOR FIRE HOSE REELS

OCCUPANCY	FIRE HOSE REELS REQUIRED-
Class 2	if more than 3 residential <i>storeys</i> contained.
Class 3	if more than 2 residential <i>storeys</i> contained.
Class 5, 6, 7 or 8	(a) in any <i>storey</i> with <i>floor area</i> more than 500 m ² ; or (b) if more than 3 <i>storeys</i> contained.
Class 9a	all buildings.
Class 9b	(a) in any <i>storey</i> with <i>floor area</i> more than 300 m ² or (b) if more than 2 <i>storeys</i> contained.
AND All Classes	wherever a <i>hydrant</i> is <i>required</i> in the building.

PART E2 SMOKE CONTROL

Delete E2.1(b) and insert NSW E2.1(b) as follows:

NSW E2.1 Smoke control

(b) $\dot{\gamma}$ Notwithstanding the requirements of Table E2.1, an air-handling system which supplies air to more than one *fire-compartment* in a building *required* to have a *fire-isolated stairway* must comply with E2.4.

Delete Table E2.1 and insert NSW Table E2.1 as follows:

NSW Table E2.1 REQUIREMENTS FOR SMOKE CONTROL

OCCUPANCY	REQUIREMENT
Class 1 & 10 buildings: Open deck car parks: Open deck stands: Buildings with a total <i>floor area</i> less than 500 m ² :	No requirement
Class 2, 3 or 4 buildings:	No requirement within <i>sole-occupancy units</i> unless supplied by a central air-handling

SUPERCEDED

	system in which case E2.4 shall apply.
Single <i>storey</i> buildings, or the top <i>storey</i> of multistorey buildings not exceeding 25 m in <i>effective height</i> where in each case the <i>floor area</i> of each <i>fire-compartment</i> does not exceed 1000 m ² :	(a) Natural smoke venting in accordance with E2.3; or (b) air-handling systems in accordance with E2.4; or (c) roof vents in accordance with E2.5; or (d) smoke exhaust systems in accordance with E2.6.
Single <i>storey</i> buildings, or the top <i>storey</i> of multistorey buildings not exceeding 25 m in <i>effective height</i> where in each case the <i>floor area</i> of each <i>fire-compartment</i> exceeds 1000 m ² :	(a) Air-handling systems in accordance with E2.4; or (b) roof vents in accordance with E2.5; or (c) smoke exhaust systems in accordance with E2.6.
Multistorey buildings having an <i>effective height</i> not exceeding 25 m and where the <i>floor area</i> of any <i>fire-compartment</i> does not exceed 1000 m ² :	(a) Natural smoke venting in accordance with E2.3; or (b) air-handling systems in accordance with E2.4.
Multistorey buildings having an <i>effective height</i> exceeding 25 m or where the <i>floor area</i> of any <i>fire-compartment</i> exceeds 1000 m ² :	Air-handling systems in accordance with E2.4.
Enclosed shopping malls exceeding 40 m in length and shops which have a <i>floor area</i> exceeding 500 m ² opening on to enclosed malls.	Smoke exhaust systems in accordance with E2.6.
Shops not exceeding 500 m ² opening on to enclosed malls:	No requirement.
A building containing an <i>atrium</i> :	Smoke exhaust systems in accordance with Part G3.
Theatres, stages and public halls:	Smoke exhaust systems in accordance with Part H1.

Delete Table E2.2 and insert NSW Table E2.2 as follows:

NSW Table E2.2 † **MEANS OF EXCLUDING SMOKE FROM FIRE-ISOLATED EXITS**

EXIT TYPE	REQUIREMENT
<p>A required fire-isolated stairway, fire-isolated ramp and fire-isolated passageway serving any storey above an <i>effective height</i> of 25 m.</p> <p>A required fire-isolated stairway, fire-isolated ramp and fire-isolated passageway serving 3 or more below ground storeys.</p> <p>A required fire-isolated ramp or fire-isolated passageway having a path of travel more than 60 m along it to a road or <i>open space</i>.</p>	<p>Either-</p> <p>(a) a pressurisation system in accordance with E2.7; or</p> <p>(b) open access ramps or balconies in accordance with D2.5.</p>
A required fire-isolated stairway serving an <i>atrium</i> .	A pressurisation system in accordance with E2.7

Note:

A below ground *storey* is one that is partially or wholly below ground and is not counted in the *rise in storeys* in accordance with C1.2.

Add NSW E2.7(e) and (f) as follows:

NSW E2.7 Pressurisation systems.

- (e) ŷ not have an electrical motor located in the air stream unless it is of a design such that in the event of burn out of the motor, the emission of smoke is inhibited; and
- (f) ŷ have tubing associated with pressure sensing devices in copper, and orifices in the pressurised area protected by perforated metal guards.

PART E3 ŷ LIFT INSTALLATIONS

Delete E3.4(a) and insert NSW E3.4(a) and (c) as follows:

NSW E3.4 Emergency lifts

- (a) ŷ An emergency lift must be installed in-
 - (i) ŷ a building which has an *effective height* of more than 25 m; and
 - (ii) ŷ a Class 9a building in which *patient care areas* are located above a level with direct egress to a road or *open space*.
- (c) ŷ In a building *required* to have an emergency lift, each *storey* must be served-
 - (i) ŷ in any case - by at least 1 passenger lift that is an emergency lift; and
 - (ii) ŷ in the case of a building that contains 2 or more passenger lifts - by at least 2 passenger lifts that are emergency lifts;
- (d) ŷ The emergency lifts referred to in subclause (c)(ii) must be contained in at least 2 separate lift *shafts*.
- (e) ŷ In calculating the number of passenger lifts contained in a building, any lift that is wholly contained within an *atrium* is disregarded;
- (f) ŷ An emergency lift must be supplied with electricity by wiring that-
 - (i) ŷ is connected to the mains supply side of the mains disconnection switch of the electrical wiring system for the building;
 - (ii) consists of copper-sheathed mineral-insulated cable or a suitable equivalent; and
 - (iii) ŷ together with all emergency power wiring, associated switch-boards, control panels, junction boxes and the like, is enclosed in construction having an FRL of at least 60/60/30;

PART E4 ŷ EMERGENCY LIGHTING, EXIT SIGNS AND WARNING SYSTEMS

Add NSW E4.8(c) as follows:

NSW E4.8 Design and operation of exit signs

- (c) ŷ A warning sign must be clearly displayed on the side of a final *exit* door facing the road or *open space* which reads as follows-

EMERGENCY EXIT KEEP CLEAR AT ALL TIMES

in lettering 100 mm high and 10 mm thick, and in a colour contrasting with the background.

(d) ¶ Paragraph (c) does not apply to a main entry door.

PART E5 MAINTENANCE

Note: Maintenance provisions are contained in NSW Ordinance 70.

Delete E5.3:

NSW E5.3 Mechanical ventilation and warm water systems

(deleted).

Delete Specification E1.2:

NSW Specification E1.2 ¶ FIRE MAINS AND WATER SUPPLY SERVICES

(deleted).

Note: Ministerial Specification No.10 is adopted in NSW in place of Specification E1.2.

NSW SPECIFICATION E1.7 ¶ FIRE DETECTION AND ALARM SYSTEMS

Delete paragraph 6(a) and insert new paragraph as follows:

6. ¶ Location of smoke detectors

(a) ¶ wherever possible, surface mounted at the return air inlet and spill air or relief air path outside the air handling system ducts, unless a point sampling system with maximum sensitivity level of 0.5% smoke obscuration is used; and

Delete Specification E2.4 and insert NSW Specification E2.4 as follows:

NSW SPECIFICATION E2.4 ¶ AIR HANDLING SYSTEMS

1. ¶ Scope

This Specification describes the performance and operation of air-handling systems used to control smoke.

2. ¶ Central air-handling systems

The installed central air-handling system may be utilised for smoke control if it complies with AS 1668.1 with respect to standards of equipment, performance and installation, and-

(a) ¶ additional air-control dampers are introduced into the return air and supply air ductwork at each *fire-compartment*-

(i) ¶ to stop the supply air to the fire-affected *fire-compartment*;

(ii) ¶ to enable exhaust or relief of smoke from the fire-affected *fire-compartment*; ¶

(iii) ¶ to achieve not less than 20 Pa positive pressure in all non-fire-affected *fire-compartments*, above the pressure in the fire-affected *fire-compartment*;

- (iv) ý which have a fail-safe operation that closes all supply air air-control dampers and fully opens all return air and relief air air-control dampers; and
 - (v) ý in such a manner that the fire integrity of the building is not compromised; and
- (b) ý in a common fan assisted smoke *shaft*, sufficient air from other *fire-compartments* or other sources must be mixed with the hot gases to limit the temperature at the smoke spill fan to less than 200°C for a heat output as nominated in Specification E2.6, Figure 2.

3. ý **Air handling units serving a single fire-compartment**

- (a) ý Where an air handling system serves a single *fire-compartment*-
- (i) ý the air-handling system serving the fire-affected *fire-compartment* must stop;
 - (ii) ý the air-handling systems serving all non-fire-affected *fire-compartments* must supply full fresh air to those *fire-compartments*; and
 - (iii) ý the fire-affected *fire-compartment* must be exhausted or relieved to outside the building, to achieve not less than 20 Pa positive pressure in all non-fire-affected *fire-compartments*, above the pressure in the fire-affected *fire-compartment*, and
 - (iv) ý the air-control dampers must have a fail-safe operation that closes fresh air and recycle air dampers and fully opens all smoke exhaust and relief dampers;
 - (v) ý a motor driving a fan used to exhaust smoke, if mounted in the air stream, must have any integral high temperature cutouts electrically isolated;
 - (vi) ý all wiring to air handling plant, essential control circuits and detector circuits must be in accordance with AS 1668.1; and
 - (vii) ý the location of fresh air intake openings and smoke exhaust and relief openings must be positioned such that fresh air supplied to non-fire-affected compartments is not likely to be contaminated with smoke.
- (b) ý Where an air-handling system serves a single *fire-compartment* and uses a *shaft* or duct common to other *fire-compartments* for the supply of outside air and/or exhaust of smoke, those elements common to more than one compartment must comply with 2(b) and the relevant provisions of AS 1668.1.

4. ý **Activation of smoke control system**

The smoke control system must be *automatic* in operation and-

- (a) ý must be activated by smoke detectors located adjacent to each *required exit* and each return air and relief air path on each floor in accordance with Specification E1.7; and
- (b) ý where arranged to initiate an alarm signal from each floor separately, may be activated by any other fire alarm system, including a *sprinkler system*, installed in the building.

NSW SPECIFICATION E2.6 SMOKE EXHAUST SYSTEMS

Delete clause 1 and insert new clause as follows:

1. ý Scope

This specification describes the performance and method of operation of smoke exhaust systems in buildings using ducted or roof mounted exhaust fans which are designed to-

- (a) ý remove smoke from within the building; and
- (b) ý in a shopping centre complex or mall, remove smoke from within pedestrian malls to maintain for as long as possible a tenable escape path for the occupants.

Substitute 6(d) and add 6(e) as follows:

6. ý Operation of fans

- (d) ý in a shopping centre complex or mall - optical smoke detectors complying with Specification E1.7 spaced not more than 20 m apart and not more than 10 m from the end of the mall and any wall, bulkhead or draught curtain; and
- (e) ý detectors referred to in (c) must comply with Specification E1.7.

Substitute clause 7 with:

7. ý Protection of wiring

Power supply wiring to exhaust fans, essential control and detector circuits must be in accordance with AS 1668.1.

SECTION F HEALTH AND AMENITY

PART F1 DAMP AND WEATHERPROOFING

Delete F1.9(b) and insert NSW F1.9(b) as follows:

NSW F1.9 Acceptable damp-proof courses

- (b) ý suitable termite shields placed on piers or on masonry walls that extend no higher than the underside of the lowest floor timbers; or

PART F2 SANITARY AND OTHER FACILITIES

Substitute requirements for Class 3 *sole-occupancy units*, and Baths or showers, in Table F2.4 as follows:

NSW TABLE F2.4 SANITARY FACILITIES FOR PEOPLE WITH DISABILITIES

CLASS OF BUILDING	MINIMUM FACILITY FOR USE BY PEOPLE WITH DISABILITIES
Class 3- In every <i>sole-occupancy unit</i> to which access for people with disabilities is <i>required</i> -	(a) one closet pan and washbasin; and (b) one shower.
Baths or showers	one shower for each 10 or part, but not less than one for use by both sexes.

Delete F2.7:

NSW F2.7 Warm water installations

(deleted).

PART F3 ROOM SIZES

Add NSW F3.101 as follows:

NSW F3.101 Minimum floor areas

Minimum *floor areas* are:

Class 1, 2 or 3 buildings, or Class 4 parts- a *habitable* room, excluding a fully-enclosed kitchen-

(a) \dot{y} if the dwelling house or *sole-occupancy unit* contains only one such room - 12 m²; or

(b) \dot{y} if it contains more than one such room - 7.5 m².

Add NSW F3.102 as follows:

NSW F3.102 Increased floor area required

Where instead of a fully-enclosed kitchen, an alcove or other space within a *habitable* room is provided for the preparation and cooking of food, the minimum *floor area* of that room must be increased by 3 m².

Add Nsw F3.103 as follows:

NSW F3.103 Certain floor area to be disregarded

In calculating the *floor area* of a room for the purpose of this clause, the *floor area* of any part of the room that is less than 1500 mm in height is disregarded.

PART F4 LIGHT AND VENTILATION

Insert F4.4(c) as follows:

NSW F4.4 Artificial lighting

(c) \dot{y} an artificial lighting system in accordance with AS1680 satisfies (a) and (b).

Delete F4.5(b)(ii) and insert NSW F4.5(b)(ii) as follows:

NSW F4.5 Ventilation of rooms

(b) \dot{y} (ii) a mechanical ventilation or air-conditioning system complying with AS 1668.2;

Delete F4.6(b)(i) and insert NSW F4.6(b)(i) as follows:

NSW F4.6 Natural ventilation

(b) \dot{y} (i) a suitably sized court, or space open to the sky; or

Delete F4.10(b)(i) and insert NSW F4.10(b)(i) as follows:

NSW F4.10 Sub-floor ventilation

- (b) ∫ (i) the sub-floor space is cross-ventilated by means of evenly distributed openings in the walls forming part of the base structure having an unobstructed area of not less than 2100 mm²/m at the *external wall* and the space has a minimum depth of 200 mm in every part; or

SECTION G ANCILLARY PROVISIONS

PART G1 MINOR STRUCTURES AND COMPONENTS

Delete G1.1(b):

NSW G1.1 Swimming pools

- (b) ∫ (deleted).

PART G3 ATRIUM CONSTRUCTION

Delete G3.6(a)(ii) and insert NSW G3.6(a)(ii) and (c) as follows:

NSW G3.6 Separation at roof

- (a) (ii) ∫ any opening in that part is protected in accordance with C3.4; and
(c) ∫ the roof is-
- (i) ∫ not less than 3 m from any boundary of the allotment other than the boundary adjoining a road or *open space*; and
 - (ii) ∫ of *non-combustible* construction, excepting glazing, plastic roofing or the like complying with Specification C1.10.

NSW SPECIFICATION G3.8 ∫ FIRE AND SMOKE CONTROL SYSTEMS IN BUILDINGS CONTAINING ATRIUMS

Substitute 3.2(f)(ii) with:

3.2 ∫ Operation of atrium mechanical air handling systems

- (f) ∫ (ii) commences full relief or exhaust from that fire-affected compartment or *storey* where the system has provision for relief or exhaust.

Substitute 3.3 with:

3.3 ∫ Activation of smoke control system

The smoke control system must be activated by-

- (a) ∫ operation of an *automatic* fire alarm;
- (b) ∫ operation of a manual break-glass fire alarm;
- (c) ∫ operation of the *sprinkler system*; or
- (d) ∫ A manual start switch,

and all controls for the smoke control system except (b) must be located in the fire control room, or emergency control centre, (if any), or adjacent to the sprinkler control valves, or incorporated in the Fire Indicator Board.

Add 3.8(c) as follows:

3.8 ý Make-up air supply

- (c) ý The requirements of (a) are satisfied if make-up air is provided to the *atrium* exhaust system by-
- (i) ý relief air from non-fire *storeys* together with;
 - (ii) ý openings directly from the outside air to the *atrium* and located as close as practical to the lowest level of the *atrium*;
 - (iii) ý ducts from the outside air to the *atrium* which deliver air as close as practical to the lowest level of the *atrium*, and where passing through any part of the building other than the *atrium*, must have an FRL of at least 60/60/60 for occupancy classifications qualifying for 1.5 MW fire size in Figure 2 of Specification E2.6, or 120/120/120 otherwise; or
 - (iv) ý a combination of direct openings and ducts, and so located to prevent as much as possible the recirculation of exhaust air and smoke.

Substitute 4.2(a), (c) and (e) with:

4.2 ý Smoke detection system

- (a) ý must be provided within all outside intakes and at individual floor return air intakes of all air handling systems to initiate *automatic* fire mode operation, and where applicable, the restart facilities *required* by AS1668.1;
- (c) ý must incorporate point sampling or optical type smoke detection so as to detect the presence of smoke within the *atrium well* and in *storeys* where the bounding wall is set back more than 3.5 m from the *atrium well*;
- (e) ý must incorporate beam type detectors to sense smoke in an *atrium well* and be-
- (i) ý located at intervals of not more than 3 *storeys*; and
 - (ii) ý arranged to scan at 90o orientation to adjacent beam units.

Add 6(e) as follows:

6. ý Standby power system

- (e) ý The requirements of (a) and (b) are satisfied by any one of the following power supply systems:
- (i) ý A single medium-voltage supply taken from an electricity substation situated within, or adjacent to, the building concerned where the power supply to the substation consists of two or more high-voltage cables each taking electricity from separate transformers.
 - (ii) ý Two or more medium-voltage supplies each taking electricity from separate electricity substations situated-
 - (A) ý outside the building concerned; and
 - (B) ý at a suitable distance away from each other.
 - (iii) ý A single medium-voltage supply taken from an electricity substation together with an electricity generating plant capable of generating a medium-voltage supply.

Add clause 101 as follows:

101. RESISTANCE TO HIGH TEMPERATURES

If not adequately shielded from the airflow-

- (a) ý all parts of exhaust fans and other equipment *required* to operate in a smoke laden environment; and
- (b) ý parts of the building *required* to be smoke-resisting, must be capable of withstanding a temperature of 200°C for a period of not less than 1 hour.

SECTION H SPECIAL USE BUILDINGS

Note: Part H1 and other relevant parts of the Code are likely to be varied in NSW following the completion of the consolidation of the NSW *Theatres and Public Halls Regulation*.

INTRODUCTION

This Appendix contains variations and additions to the BCA provisions which are considered necessary for the effective application of the Code in the Northern Territory.

CONTENTS

A - GENERAL PROVISIONS

NT Specification A1.3 Standards Adopted by Reference. ý

NT A3.2 Classifications ý

B - STRUCTURE

NT B1.2 Loads ý

NT Specification B1.2 Loads in Cyclonic Areas. ý

D - ACCESS AND EGRESS

NT D1.13 Number of persons accommodated ý

NT D2.21 Operation of latch ý

E - SERVICES AND EQUIPMENT

NT E1.4 Hose reels ý

NT E1.5 Sprinklers ý

NT Specification E1.5 Fire Sprinkler Systems. ý

NT E1.7 Fire and Smoke Alarms ý

NT E5.2 Maintenance Requirements ý

G - ANCILLARY PROVISIONS

NT G1.1 Swimming pools

H - SPECIAL USE BUILDINGS

NT Part H101 FOOD PREMISES

NT H101.1 Application of Part ý

NT H101.2 Floors, walls and ceilings ý

NT H101.3 Pests and contaminants ý

NT H101.4 Washbasins ý

NT H101.5 Sinks ý

NT H101.6 Installation of equipment and fittings ý

NT H101.7 Drains ý

NT H101.8 Concealment of pipes ý

NT H101.9 Storage of materials and equipment ý

SUPERCEDED

NT H101.10 Separation of work place ý

NT H101.11 Offensive material and trade waste ý

NT H101.12 Mechanical ventilation of kitchens ý

NT Specification NT H101.13 Installation of Exhaust Fans and Rangehoods ý

NT Part H102 ý PREMISES TO BE USED FOR ACTIVITIES INVOLVING SKIN PENETRATION

NT H102.1 Application of Part ý

NT H102.2 Sanitary facilities ý

NT H102.3 Washbasins ý

NT Part H103 ý MORTUARIES

NT H103.1 Application of Part ý

NT H103.2 Layout of mortuary ý

NT H103.3 Construction of body preparation room ý

NT H103.4 Water supply and sewerage ý

SECTION A ý GENERAL PROVISIONS

PART A1 INTERPRETATION ý

NT Specification A1.3 Standards Adopted by Reference. ý

Insert in Table 1 of Specification A1.3 the following:

NT Table 1 SCHEDULE OF REFERENCED DOCUMENTS

No	Date	Title	BCA Clause(s)
AS 1170		Minimum design loads on structures	
Part 2	1989	Wind forces	NT Spec B1.2
AS 1668		Rules for the use of mechanical ventilation and air-conditioning in buildings (SAA Mechanical Ventilation and Air-conditioning Code)	
Part 1	1979	Fire precautions in buildings with air-handling systems	
		Amdt 1, Nov. 1979	NT H101.12
AS 1851		Maintenance of fire protection equipment	NT E5.2
Part 1	1985	Portable fire extinguishers.	
Part 2	1988	Fire hose reels.	
Part 3	1985	Automatic fire sprinkler systems.	
Part 4	1988	Fire hydrant installations.	
Part 5	1981	Automatic smoke/heat venting systems.	
Part 6	1983	Management procedures for maintaining the fire precaution features of air handling systems.	
Part 7	1984	Fire resistant door sets.	
Part 8	1987	Automatic fire detection and alarm systems.	

PART A3 $\dot{\gamma}$ CLASSIFICATION OF BUILDINGS AND STRUCTURES

Delete the definition of Class 3 in A3.2 and insert the following:

NT A3.2 $\dot{\gamma}$ Classifications

Class 3: a residential building, other than a building of Class 1 or 2, which is a common place of living for a number of unrelated persons, including-

- (a) $\dot{\gamma}$ a boarding-house, guest house, hostel or lodging house;
- (b) $\dot{\gamma}$ a residential part of a *school*;
- (c) $\dot{\gamma}$ accommodation for the aged, disabled or children;
- (d) $\dot{\gamma}$ a residential part of a *health-care building* which accommodates members of staff; and
- (e) $\dot{\gamma}$ budget transient (backpackers) dormitory accommodation.

SECTION B STRUCTURE

PART B1 $\dot{\gamma}$ STRUCTURAL PROVISIONS

Delete B1.2(a) and insert NT B1.2(a) as follows:

NT B1.2 $\dot{\gamma}$ Loads

- (a) $\dot{\gamma}$ Dead, live and wind loads: AS 1170.1 and AS 1170.2 and in accordance with NT Specification B1.2.

NT SPECIFICATION B1.2 LOADS IN CYCLONIC AREAS

1. $\dot{\gamma}$ Scope

This specification contains requirements for the design of buildings in cyclonic areas.

2. $\dot{\gamma}$ Design

The design of a building must, where *required*, comply with the provision of AS 1170.2 so that-

- (a) $\dot{\gamma}$ As a minimum requirement for residential building design in Region C, terrain category 21/2 with velocity multipliers equal to the average of those given in Table 3.2.5.2 of AS 1170.2 for categories 2 and 3 are used where a terrain roughness normally in category 3 may be subject to deterioration in extreme winds.
- (b) $\dot{\gamma}$ for the purpose of determining internal pressures in accordance with AS 1170.2, all *window* openings whether glazed or not, are regarded as potential dominant openings unless suitable protection against debris penetration is provided;
- (c) $\dot{\gamma}$ external doors are regarded as potential dominant openings unless the doors and their fixings are shown to be adequate to resist wind loading,
- (d) $\dot{\gamma}$ protection of an opening is adequate for the purposes of this requirement where it can be shown capable of resisting a 4kg mass having 100mm x 50mm impacting cross-section striking at any angle at a velocity of 15 m/s without affecting internal design pressures.

3. ý Roof Construction

- (a) ý Roof Cladding- For the purpose of this specification, roof cladding shall not be considered to be bracing for a roof unless it is fixed in such a manner as to act as a braced diaphragm under the combined effects of uplift, repeated loadings and diaphragm action.
- (b) ý Test for strength- Metal roofing and its fitments should be capable of withstanding without failure, the test application of 10 000 cycles of working load from zero to that maximum at a rate of 3 Hz, followed by a static load test of 1.8 times the working load.

4. ý Masonry Veneer Construction

Masonry veneer construction must be designed so that the structural framing, to which a masonry veneer wall is tied, will ensure the stability of the masonry veneer.

SECTION D ACCESS AND EGRESS ý

PART D1 PROVISION FOR ESCAPE

NT D1.13 Number of persons accommodated

Delete the provision for a Dormitory in Table D1.13 and insert the following-

NT Table D1.13 AREA PER PERSON ACCORDING TO USE

TYPE OF USE	m ² per person
Dormitory- for children	5
for adults	10
for budget transient accommodation	2.5*

*subject to the provision of adequate ventilation and fire egress.

PART D2 CONSTRUCTION OF EXITS

Delete D2.21 and insert NT D2.21 as follows:

NT D2.21 Operation of latch

A door in a *required exit*, forming part of a *required exit* or in the path of travel to a *required exit* must be readily openable without a key from the side that faces a person seeking egress, by a single hand downward action or horizontal pushing action on a single device which is located between 900 mm and 1.2 m from the floor, unless-

- (a) ý it serves a vault, strongroom, *sanitary compartment*, or the like;
- (b) ý it serves only, or is within-
- (i) ý a *sole-occupancy unit* in a Class 2 or 3 building or a Class 4 part;
 - (ii) ý a *sole-occupancy unit* in a Class 5, 6, 7 or 8 building with a *floor area* not more than 200 m²; or
 - (iii) ý a space which is otherwise inaccessible to persons at all times when the door is locked;
- (c) ý it serves a bank or other occupancy where special arrangements for security are necessary and it can be immediately unlocked-
- (i) ý by operating a fail-safe control switch, not contained within a protective enclosure, to actuate a device to unlock the door; or

SUPERCEDED

- (ii) ý by hand by a person or persons, specifically nominated by the owner, properly instructed as to the duties and responsibilities involved and available at all times when the building is lawfully occupied so that person in the building or part may immediately escape if there is a fire or other emergency; or
- (d) ý it is fitted with a fail-safe device which *automatically* unlocks the door upon the activation of any *sprinkler system* or smoke or thermal detector system installed throughout the building.

SECTION E SERVICES AND EQUIPMENT

PART E1 FIRE-FIGHTING EQUIPMENT

NT E1.4 Hose reels

Delete the provision for Class 3 buildings in Table E1.4 and insert the following:

NT Table E1.4 REQUIREMENTS FOR FIRE HOSE REELS

OCCUPANCY	WHEN FIRE HOSE REELS REQUIRED
Class 3 ý	(a) if more than 2 residential <i>storeys</i> contained; or (b) ý if in dormitory accommodation- designed to accommodate more than 12 people.

NT E1.5 Sprinklers

Insert provisions for Class 9a buildings in Table E1.5 as follows:

NT Table E1.5 REQUIREMENTS FOR SPRINKLERS

OCCUPANCY	WHEN SPRINKLERS ARE REQUIRED
Class 9a	if more than one <i>storey</i> .

Delete clause 3 of Specification E1.5 and insert NT Specification E1.5, clause 3 as follows:

NT SPECIFICATION E1.5 FIRE SPRINKLER SYSTEMS

3. ý Provisions of AS 2118 not to apply

Clause 1.2.20 of AS 2118 (definition of fire door) does not apply.

Delete E1.7 and insert NT E1.7 as follows:

NT E1.7 Fire and smoke alarms

- (a) ý A suitable *automatic* fire and smoke alarm system complying with Specification E1.7 must be installed in-
 - (i) ý a Class 3 building accommodating more than 20 residents used as-
 - (A) ý a special accommodation house, home for the aged, children, or the like;
 - (B) ý the residential part of a school; or
 - (C) ý budget transit accommodation; and
 - (ii) ý a Class 9a building with more than 20 bed patients.

SUPERCEDED

SUPERCEDED

- (b) ý A suitable single station fire detector must be installed in each *habitable room* and path of travel to an *exit* in a Class 3 building accommodating less than 20 persons used as budget transient dormitory accommodation.

PART E5 MAINTENANCE OF SAFETY INSTALLATIONS

Delete E5.2 and insert NT E5.2 as follows:

NT E5.2 Maintenance Requirements

Safety installations in buildings must be maintained in accordance with the requirements of the following Australian Standards as appropriate:

- AS 1851.1 Portable fire extinguishers.
- AS 1851.2 Fire hose reels.
- AS 1851.3 Automatic fire sprinkler systems.
- AS 1851.4 Fire hydrant installations.
- AS 1851.5 Automatic smoke/heat venting systems.
- AS 1851.6 Management procedures for maintaining the fire precaution features of air handling systems.
- AS 1851.7 Fire resistant door sets
- AS 1851.8 Automatic fire detection and alarm systems.

SECTION G ANCILLARY PROVISIONS ý

PART G1 MINOR STRUCTURES AND COMPONENTS

NT G1.1 Swimming pools

Delete G1.1.

SECTION H SPECIAL USE BUILDINGS ý

Insert NT Part H101 as follows:

NT PART H101 FOOD PREMISES

NT H101.1 Application of Part

- (a) ý This part applies to all premises, rooms, compartments, or places used for the sale, preparation, packing, storing, handling, serving, supplying or conveying for sale of food.
- (b) ý This part does not apply to tents, buildings or other structures used temporarily for serving meals to the public at any fair, show, race meeting or other public sports, games or amusements.

NT H101.2 Floors, walls and ceilings

- (a) ý Each floor, wall and ceiling of the premises must have a surface that is-
- (i) ý durable, rigid, impervious to water, non-absorbent, non-toxic and smooth enough to be easily cleaned; and
 - (ii) ý free from cracks, crevices and other defects.

SUPERCEDED

SUPERCEDED

- (b) ý If the floor is subject to wet cleaning by hosing down or if activities are carried out where liquids are discharged on to the floor, the floor must be graded to trapped floor waste outlets connected to a drainage installation.
- (c) ý Each wall must be free from skirtings, architraves, picture rails or other ledges that could provide lodgement for dirt.
- (d) ý All angles between the walls and the floor must be coved to permit easy cleaning.
- (e) ý All angles between walls and all joints in walls must be sealed.
- (f) ý All walls and ceilings must be finished in light colour.
- (g) ý Subclauses (a), (b), (c), (d), (e) and (f) do not apply to areas used only by customers and they do not apply to walls and ceilings in a premises or place-
 - (i) ý used for the storage or display for sale of food that is wholly enclosed in protective packages;
 - (ii) ý used for the storage for sale of fruit and vegetables; or
 - (iii) ý in which all food for sale is completely enclosed and otherwise protected from contamination by processing plants, other appliances, or other means.

NT H101.3 Pests and contaminants

- (a) ý The exterior of a food premises must be constructed to exclude pests and contaminants.
- (b) ý Premises which are provided with-
 - (i) ý fly proof, external *windows* and *self-closing*, fly-proof doors, or
 - (ii) ý if customers are served outside the premises through an opening, an appliance for the elimination of flies and mechanical ventilation adequate to exhaust air through the opening at a rate of not less than 5 litres per second for each square metre of opening,satisfy (a) as it applies to insects.

NT H101.4 Washbasins

Each premises or place for preparation or storage of food for sale must be provided with not less than one washbasin, supplied with hot and cold water, in or within reasonable proximity of those areas where the nature of the activities performed is such that hands are likely to be a source of contamination of food.

NT H101.5 Sinks

- (a) ý Each premises must be provided with a double bowl sink or tub of stainless steel supplied with-
 - (i) ý hot and cold water; and
 - (ii) ý an integral drainer on at least one side.
- (b) ý If a sink is installed within 300 mm of a vertical adjacent surface it must be fitted with an integral flashing to that vertical, adjacent surface to a height of not less than 150 mm.

NT H101.6 Installation of equipment and fittings

- (a) ý Each item of equipment or fitting in a premises which is not capable of being moved easily must be installed-
 - (i) ý so that the area underneath the item can be easily cleaned; or
 - (ii) ý on a solid base or plinth constructed of impervious material similar to the flooring material.
- (b) ý A plinth must be-
 - (i) ý not less than 75 mm high;

SUPERCEDED

- (ii) ý finished to a smooth even surface and rounded at exposed edges to facilitate cleaning;
- (iii) ý coved at intersections with floor and walls.

NT H101.7 Drains

A grease trap or an untrapped opening connected directly with a drain or sewer, must not be installed in a room used for preparation, processing, packing or storing of food.

NT H101.8 Concealment of pipes

Where practicable service pipes should be concealed beneath the surface of walls, floors, or ceilings, otherwise pipes are to be fixed clear of the wall, floor, or ceiling, at such distance as to facilitate cleaning.

NT H101.9 Storage of materials and equipment

Separate areas for the storage of fuel, cleaning compounds and general maintenance equipment must be provided so as to prevent the contamination of the product in the event of a spillage or any other form of breakdown.

NT H101.10 Separation of work place

Food premises must not have direct communication with a room containing sanitary facilities, sleeping quarters, laundry, bathroom or garage or a room where animals are housed.

NT H101.11 Offensive material and trade waste

If offensive material or trade waste is stored, a separate area must be provided which-

- (a) ý is easily cleanable;
- (b) ý is graded to drain to a suitable drainage system; and
- (c) ý has available a supply of water under pressure.

NT H101.12 Mechanical ventilation of kitchens

Where, in a kitchen serving an eating house, accommodation facility or take-away food store, cooking or extensive heating which emits greasy vapours is done, a mechanical ventilating exhaust system must be provided in accordance with AS 1668 Parts 1 and 2, and NT Specification H101.12.

NT SPECIFICATION H101.12 ý INSTALLATION OF EXHAUST FANS AND RANGEHOODS

1. ý Scope

This specification describes the installation of exhaust fans, range hoods and the like *required* for the removal of heat, smoke and cooking vapours from a building.

2. ý Wall Type

A wall type hood in a food preparation area must be-

- (a) ý mounted not less than 1.8 m in height above the finished floor level and not less than 150 mm in horizontal length beyond the perimeter of the appliance which it serves, measured from the internal edge of the grease gutter of the hood;
- (b) ý provided with a condensation gutter around the base of the hood, graded to a 25-30 mm brass cleaning screw; and
- (c) ý fixed to the surfaces to which it is attached so as to form a dust and vermin proof seal.

3. ý **Island Type Hoods**

An island type hood must-

- (a) ý extend not less than 300 mm in horizontal length beyond the perimeter of the appliance which it serves, measured from the exterior edge of the appliance to the inside edge of the grease gutter of the hood; and
- (b) ý fixed to the surfaces to which it is attached so as to form a dust and vermin proof seal.

4. ý **Filtration**

- (a) ý Unless otherwise *required*, a mechanical ventilating exhaust system must be provided with a means of grease filtration unless installed over appliances the products of which are largely heat or water vapour.
- (b) ý A filter must be-
 - (i) ý of *non-combustible* material easily removable for cleaning purposes;
 - (ii) ý fitted with a removable drip tray to the underside of the filter; and
 - (iii) ý fitted at the exhaust openings of the hood which it serves.

Insert NT Part H102 as follows:

NT PART H102 ý PREMISES TO BE USED FOR ACTIVITIES INVOLVING SKIN PENETRATION

NT H102.1 Application of Part

This part applies to premises for tattooing, ear-piercing, acupuncture and like activities.

NT H102.2 Sanitary facilities

- (a) ý Sanitary facilities for customers must be provided and must include not less than-
 - (i) ý one water closet; and
 - (ii) ý one washbasin
- (b) ý Sanitary facilities must be separated from the workroom by-
 - (i) ý an air lock with *self-closing* entry door; or
 - (ii) ý a *self-closing* door.

NT H102.3 Washbasins

The area in which skin penetration is done must be provided with-

- (a) ý one wash basin for each 10, or part of 10 employees; and
- (b) ý an adequate supply of hot and cold water controlled by foot-operated or elbow-operated taps.

Insert NT Part H103 as follows:

NT PART H103 ý MORTUARIES

NT H103.1 Application of Part

This Part applies to any premises used for storage or preparation for burial, cremation or disposal by other means, of bodies of deceased persons.

NT H103.2 Layout of mortuary

- (a) ý A mortuary may be integral with the remainder of a building but must be separated physically from all public areas of that building.

SUPERCEDED

- (b) ý Each mortuary at which bodies are prepared for burial, cremation or other disposal must be provided with a body preparation room-
 - (i) ý capable of being isolated from the remainder of the premises; and
 - (ii) ý having a *floor area* not less than 10 m².
- (c) ý A vehicle reception area or garage must be provided adjacent to and with direct access to the storage room or body preparation room to ensure that the transfer of uncoffined bodies is screened from public view.
- (d) ý Access to toilet and shower facilities from any other part of the mortuary premises must be only by way of an air lock.

NT H103.3 Construction of body preparation room

- (a) ý The floor must be-
 - (i) ý of impervious material with a smooth, unbroken surface; and
 - (ii) ý uniformly graded to a floor drain.
- (b) ý All walls and partitions must be of concrete or masonry with a smooth, unbroken finish for ease of cleaning.
- (c) ý All joints between the floor, walls, partitions, ceiling, ventilation grilles, fittings, pipework, *windows* and light fittings must be sealed with impervious material for ease of cleaning.
- (d) ý All joints between the floor and walls or partitions must be coved for ease of cleaning.
- (e) ý The body preparation room must be provided with at least one washbasin, fitted with elbow or foot-operated taps, and an adequate supply of hot and cold water.
- (f) ý The body preparation room must be provided with refrigerated storage facilities-
 - (i) ý with sufficient capacity for the storage of at least two adult bodies; and
 - (ii) ý capable of maintaining an internal temperature between 1°C and 5°C.

NT H103.4 Water supply and sewerage

Each mortuary with a body preparation room must be connected to-

- (a) ý a permanent water supply with a physical discontinuity between the water supply and all equipment, appliances, fittings and areas in the mortuary; and
- (b) a water carriage sewerage system.

INTRODUCTION ý

This Appendix contains variations and additions to the BCA provisions which are considered necessary for the effective application of the Code in Queensland and shall be treated as amendments to the Code.

CONTENTS ý

This Appendix contains the BCA provisions that have been varied and additional provisions for application in Queensland, as follows:

A - GENERAL PROVISIONS

- Qld A1.1 Definitions
- Qld A3.2 Classifications
- Qld Specification A1.3 Standards Adopted by Reference.

B - STRUCTURE

- Qld B1.3 Construction deemed-to-satisfy

C - FIRE RESISTANCE

- Qld C1.1 Type of construction required
- Qld C1.101 Two storey Class 9b buildings
- Qld C3.11 Bounding construction: Class 2, 3 and 4 buildings
- Qld Specification C1.1 Fire-Resisting Construction. ý
- Qld Specification C1.9 Fire-Resistance of Class 1 and 10a Buildings. ý

D - ACCESS AND EGRESS

- Qld D1.6 Dimensions of exits
- Qld D2.18 Fixed platforms, walkways, stairways and ladders
- Qld D2.21 Operation of latch

E - SERVICES AND EQUIPMENT

- Qld E1.7 Fire detection and alarm systems
- Qld E4.9 Emergency warning and intercommunication systems

Qld Part E101 ý PROTECTION OF ELECTRICAL SUPPLY TO ESSENTIAL SERVICES

- Qld E101.1 Definition of essential services
- Qld E101.2 Protection of essential services
- Qld Specification E1.7 Fire Detection and Alarm Systems.

F - HEALTH AND AMENITY

- Qld F1.7 Water proofing of wet areas in buildings

SUPERCEDED

- Qld F1.11 Provision of floor wastes ý
- Qld F1.102 Flashings to narrow spaces ý
- Qld F2.5 Construction of sanitary compartments ý
- Qld F5.1 Application of Part ý

Qld Part F101 RODENT PROTECTION AND BIRDPROOFING

- Qld F101.1 Protection from rodents ý
- Qld F101.2 Birdproofing of buildings ý

G - ANCILLARY PROVISIONS

- Qld G1.1 Swimming pools

Qld Part G101 AWNINGS AND BALCONIES

- Qld G101.1 General provisions
- Qld G101.2 Special provisions over roads
- Qld G101.3 Relaxation
- Qld G101.4 Movable awnings and sun shades over roads

Qld Part G102 CERTAIN ATTACHMENTS

- Qld G102.1 The attachments concerned
- Qld G102.2 Steel to be protected
- Qld G102.3 Height above roads
- Qld G102.4 Drainage from ventilating equipment
- Qld G102.5 Protection from lightning
- Qld G102.6 Construction
- Qld G102.7 Exemption: Certain structures
- Qld G102.8 Prevention of falls from buildings and structures

H - SPECIAL USE BUILDINGS ý

- Qld H1.1 Application of Part

Qld Part H101 WORKPLACES

- Qld H101.1 Application of Part
- Qld H101.2 Objectives
- Qld H101.3 Floor surfaces
- Qld H101.4 Floor drainage
- Qld H101.5 Floor coverings
- Qld H101.6 Lighting
- Qld H101.7 Floor area and air space
- Qld H101.8 Dining rooms
- Qld H101.9 Dressing rooms
- Qld H101.10 Drinking water
- Qld H101.11 First aid

Qld Part H102 STABLES

- Qld H102.1 Construction of stables

SUPERCEDED

Qld Part H103 KIOSKS

Qld H103.1 Construction of kiosks

Qld Part H104 PREMISES USED FOR LEAD PROCESSING

Qld H104.1 Application of Part

Qld H104.2 Objectives

Qld H104.3 Sole use of area

Qld H104.4 Floor surfaces and drainage

Qld H104.5 Installations of fittings and fixtures

Qld H104.6 Interiors

Qld H104.7 Washing facilities including showers

Qld H104.8 Dressing rooms

Qld H104.9 Dining rooms

Qld H104.10 Exhaust systems

Qld Part H105 WORKPLACES INVOLVING ASBESTOS

Qld H105.1 Application of Part

Qld H105.2 Objectives

Qld H105.3 Construction requirements

Qld H105.4 Installation of fitting and fixtures

Qld H105.5 Exhaust systems

Qld Part H106 WORKPLACES INVOLVING SPRAY PAINTING

Qld H106.1 Application of Part

Qld H106.2 Objectives

Qld H106.3 Requirements for booths

Qld H106.4 Requirements of booths

Qld H106.5 Exhaust systems

Qld Part H107 FOUNDRIES AND EXPLOSIVE BLASTING

Qld H107.1 Application of Part

Qld H107.2 Objectives

Qld H107.3 Requirements for blasting chambers

Qld H107.4 Exhaust systems for blasting chambers

Qld H107.5 Requirements for foundry areas

Qld H107.6 Washing facilities including showers

Qld Part H108 DETENTION CENTRES

Qld H108.1 Application of Part

Qld H108.2 Objectives

Qld H108.3 Fire-resistance and stability

Qld H108.4 Bounding construction

Qld H108.5 Early Fire Hazard Indices

Qld H108.6 Fire doors, smoke doors, fire windows and shutters

Qld H108.7 Number of exits required

Qld H108.8 Exit travel distances

SUPERCEDED

Qld H108.9	Doorways and doors
Qld H108.10	Swinging doors
Qld H108.11	Operation of latch
Qld H108.12	Access for people with disabilities
Qld H108.13	Hose reels
Qld H108.14	Smoke control

SECTION A GENERAL PROVISIONS ý

PART A1 INTERPRETATION

In A1.1 vary definitions as follows:

Qld A1.1 Definitions

Insert *Awning*:

Awning - In Qld Part G101, awning includes a light metal structure which is cantilevered or otherwise supported from the building.

Insert Detention Centre:

Detention Centre means a building in which persons are securely detained by means of the built structure including a prison, remand centre, juvenile detention centre, watch house or psychiatric detention centre.

Insert *Ground level*:

Ground level, for the purposes of Qld E1.7 and Qld E4.9, means the floor of the lowest *storey* providing direct egress to a road or *open space*.

Substitute *Open garage*:

Open garage-

- (a) ý means a carport or garage that is open and without doors along the full length of at least two sides and for at least one-third of the total perimeter of the carport or garage; and
- (b) ý includes an awning or balcony capable of sheltering a motor vehicle.

Substitute *Open space*:

Open space means-

- (a) ý a space on an allotment, or a roof or similar part of a building complying with D2.12, open to the sky and connected directly with a public road; and
- (b) ý in the case of *detention centres*, includes a fenced enclosure, open to the sky (except for mesh cover) having a horizontal dimension of at least 6 m in every direction.

Substitute *Professional engineer*:

Professional Engineer means a person who is-

- (a) ý a registered *professional engineer* under the Queensland *Professional engineers Act 1929-1975*; and

SUPERCEDED

SUPERCEDED

- (b) ý competent to practice in the design and construction of the relevant building work.

Substitute *Swimming pool*:

Swimming pool means any excavation or structure containing water and used for swimming, wading, paddling, or the like, including a bathing or wading pool or spa, but does not include a dam or tank normally used for rural purposes, or a watercourse or the like.

Insert *Workplace*:

Workplace means any premises for the performance of work by employees or self-employed persons, including-

- (a) any area within the immediate vicinity of such premises where gear, plant, equipment or materials to be used in that work are kept; and
- (b) any building, structure, bridge, wharf, road or way on or within such premises or in the immediate vicinity.

PART A3 ý CLASSIFICATION OF BUILDINGS AND STRUCTURES

In A3.2 add paragraph (f) to the definition of a Class 3 building as follows:

Qld A3.2 Classifications

- (f) ý a residential part of a *Detention centre* for the accommodation of the inmates of the centre.

Insert in Table 1 of Specification A1.3 additional standards as follows:

QLD SPECIFICATION A1.3 ý STANDARDS ADOPTED BY REFERENCE

Qld Table 1 ý SCHEDULE OF REFERENCED DOCUMENTS

No.	Date	Title	BCA clause(s)
AS 1076		Code of practice for selection, installation and maintenance of electrical apparatus and associated equipment for the use in explosive atmospheres (other than mining operations).	Qld H106.4 Qld H107.3
Part 1	1977	Basic requirements	
Part 3	1977	Apparatus with type of protection "d" - Flame proof enclosure	
Part 6	1977	Apparatus with type of protection "e"- Increased safety	
Part 7	1977	Apparatus with type of protection "n" - Non-sparking apparatus	
Part 8	1977	Apparatus with type of protection "s" - Special protection	
Part 13	1977	Installation and maintenance requirements for instrumentation	
AS 1136		Low voltage switchgear and control gear assemblies.	
Part 1	1988	General requirements	Qld E101.2

SUPERCEDED

SUPERCEDED

		Amdt 1- March 1989	
AS 1680	1976	Code of practice for interior lighting and the visual environment	Qld H101.6
AS 2208	1978	Safety glazing materials for use in buildings (human impact considerations)	Qld H106.4 Qld H107.3
AS 2381		Electrical equipment for explosive atmospheres - selection, installation and maintenance	Qld H106.4 Qld H107.3
Part 7	1989	Intrinsic safety	
Part 10	1989	Equipment in combustible dust (Class II) areas Amdt 1 - July 1989	
AS 2626	1983	Industrial safety belts and harness-Selection, use and maintenance	Qld G102.8
AS 3000	1986	Electrical installations - Buildings, structures and premises Amdt 2 - December 1987 Amdt 3 - July 1988 Amdt 4 - July 1989	Qld E101.1
Queensland Department of Forestry Pamphlet No 5 - Queensland Building Timbers and Specifications for their Use.			Qld B1.3

SECTION B STRUCTURE

PART B1 STRUCTURAL PROVISIONS

Delete B1.3(f) and insert Qld B1.3(f) as follows:

Qld B1.3 Construction deemed-to-satisfy

(f) ý Timber Construction:

- (i) ý Design of timber structures: AS1720.
- (ii) ý Timber in a Class 10a building in an area where the design wind velocity calculated under AS1170.2 does not exceed 33 m/s, with *floor area* less than 60 m²: CSIRO - DBC & E Special Report - Low Rise Domestic and Similar Framed Structures, Part 4 - Supplementary Domestic Buildings for Built-up Areas, Sections I to V.
- (iii) ý Timber use for structural purposes: a species scheduled for the appropriate conditions of use in Table IV in Queensland Department of Forestry Pamphlet No 5 - Queensland Building Timbers and Specifications for their Use.

SECTION C FIRE RESISTANCE

PART C1 FIRE RESISTANCE AND STABILITY

Delete C1.1(a) and insert Qld C1.1(a) as follows:

Qld C1.1 Type of construction required

- (a) ý The minimum Type of *fire-resisting construction* of a building must be that specified in Table C1.1, except as allowed for-
 - (i) ý certain Class 2 or 3 buildings in C1.5;
 - (ii) ý *open spectator stands* and indoor sports stadiums in C1.7;

SUPERCEDED

SUPERCEDED

- (iii) *lightweight construction* in C1.8;
- (iv) *Class 1 and 10 buildings* in C1.9; and
- (v) *certain Class 9b buildings* in Qld C1.101.

After C1.10 add Qld C1.101 as follows:

Qld C1.101 Two Storey Class 9b buildings

A Class 9b building for the assembly of the members of the Girl Guides Association of Queensland, the Scout Association of Australia or similar organisations, or a *school* building, having a *rise* of 2 *storeys*, may be of Type B construction for the first *rise* in *storey* to the underside of the floor of the upper *storey* and of Type C construction for the second *rise* in *storey* if-

- (a) *a ceiling having a resistance to the incipient spread of fire* to the space above itself of not less than 60 minutes is installed in all enclosed areas for the first *rise* in *storey*.
- (b) *any exposed beams supporting the ceiling specified in (a)* must have an FRL of at least 60/-/-.
- (c) *every enclosed room on the second rise in storey* has a *floor area* less than 250 m²;
- (d) *the building* has a total *floor area* less than 1600 m²;
- (e) *the building* is located 3 m or more from any *fire-source feature*;
- (f) *all required stairways* lead directly to a road or *open space* or terminating (in the case of an internal stairway) within 3 m of a doorway leading directly to a road or *open space*; and
- (g) *every enclosed internal passageway on the second rise in storey* is no longer than 12 m.

PART C3 PROTECTION OF OPENINGS

After C3.11(d) add Qld C3.11(e) as follows:

Qld C3.11 Bounding construction: Class 2, 3 and 4 buildings

- (e) *Doorways and other openings in external walls* of a Class 2 or 3 building that-
 - (i) *bound an external public balcony or the like which serves as a means of egress* from 2 or more *sole-occupancy units* to a *required exit*; or
 - (ii) *bound the landing of a required non-fire isolated stairway*; and
 - (iii) *are located in the only path of travel from another sole-occupancy unit to a required exit* must be-
 - (A) *protected in accordance with C3.4*; or
 - (B) *located at least 1.5 m above the floor*.

Vary Specification C1.1 as follows:

Qld Specification C1.1 FIRE RESISTING CONSTRUCTION

Substitute clause 3.9 with:

3.9 Carparks: Concessions

Table 3.9 applies to a carpark instead of Table 3.

SUPERCEDED

Substitute clause 4.2 with:

4.2 ý Carparks: Concession

Table 4.2 applies to a carpark instead of Table 4.

Substitute clause 5.2 with:

5.2 ý Carparks: Concession

Table 5.2 applies to a carpark instead of Table 5.

Delete Specification C1.9 and insert Qld Specification C1.9 as follows:

QLD SPECIFICATION C1.9 ý FIRE-RESISTANCE OF CLASS 1 AND 10A BUILDINGS

1. ý Scope

This Specification sets out the requirements for the construction of Class 1 and 10a buildings to resist the spread of fire.

2. ý External walls of Class 1 buildings

(a) ý Except where permitted in clause 6 and 2(b), *external walls* of-

- (i) ý a single detached Class 1 building erected on or within 1.5 m of a side or rear boundary of the allotment; or
- (ii) ý a Class 1 building not included in (i) erected on or within 1.5 m of a side or rear boundary of the allotment, other than the boundary of a lot in a group title resubdivision, must have-
- (iii) ý an FRL of not less than 60/60/60. This requirement is met if the outer part of the wall has the *required* FRL; and
- (iv) ý no openings if the horizontal distance measured along the line of sight between the nearest part of the opening and the boundary is less than 1.5 m in accordance with Figure 2.

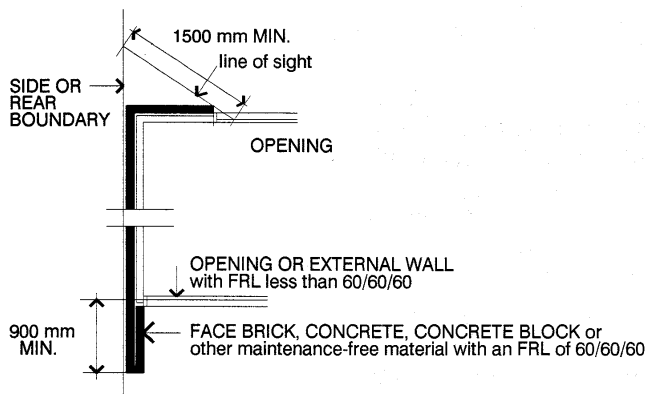

FIGURE 2
LIMITATIONS ON OPENINGS IN EXTERNAL WALLS NEAR BOUNDARIES

(b) ý An *external wall* does not *require* an FRL if-

- (i) ý the horizontal distance measured along the line of sight between that part of the *external wall* and the boundary is at least 1.5 m; or
- (ii) ý a nib wall is provided at least 900 mm long, constructed of maintenance free materials having an FRL of not less than 60/60/60, in accordance with Figure 2.

(c) ý *External walls* of a Class 1 building that are less than the distances specified in Table 2 from another building, other than a Class 10a building on the same

SUPERCEDED

allotment, must have an FRL of not less than 60/60/60. This requirement is met when the outer part of the wall has the *required* FRL.

- (d) \dot{y} Openings in *external walls* referred to in (c) must-
- (i) \dot{y} not be openable; and
 - (ii) \dot{y} be protected with fire windows or glass block or other construction with an FRL of at least 60/60/ - .

Table 2 \dot{y} MINIMUM DISTANCE BETWEEN EXTERNAL WALLS OR OPENINGS OF CLASS 1 BUILDINGS FROM OTHER BUILDINGS

Angle between <i>external walls</i> or openings	Minimum distance between <i>external walls</i> or openings of Class 1 buildings from other buildings (metres)
0° (walls opposite)	3
more than 0° to 45°	2.5
more than 45° to 90°	2
more than 90° to 135°	1.5
more than 135° to 180°	1
180° or more	nil

3. \dot{y} External walls of Class 10a buildings

External walls of a Class 10a building, excluding an *open garage*, within 750 mm of a side or rear boundary must have an FRL of not less than 60/60/60 and be without openings. The requirement for the FRL is met when the outer part of the wall has the *required* FRL.

4. \dot{y} External walls of open garages

Where an *open garage* has an external weatherproof wall within 750 mm of a side or rear boundary, the wall must have an FRL of not less than 60/60/60 and be without openings. The requirement for the FRL is met when the outer part of the wall has the *required* FRL.

5. \dot{y} Allowable encroachments

The following-

- (a) \dot{y} fascias, gutters, downpipes, *non-combustible* lining of eaves, and the like; and
- (b) \dot{y} masonry chimney backs, flues, pipes, domestic fuel tanks, cooling or heating appliances, or other services, may encroach into the distances specified in clauses 2, 3 and 4, if the distance to the boundary is not reduced to less than 500 mm or the distance between buildings is not reduced to less than 1 m, or if protected by a wall complying with clause 2.

6. \dot{y} Exceptions

Clause 2 does not apply to-

- (a) \dot{y} an existing *external wall* that is reclad, if the recladding does not reduce the distance to the boundary by more than 150 mm;
- (b) \dot{y} light fittings, electricity or gas meters, aerials or antennae;
- (c) \dot{y} pergolas or sun blinds; and
- (d) \dot{y} unroofed terraces, landings, steps or ramps, not more than 1 m in height.

7. \dot{y} Common walls

If a *common wall* separates Class 1 buildings, or separates a Class 1 building from a Class 10a building on another allotment, or separates Class 10a buildings on different allotments, it must-

- (a) \dot{y} have an FRL of not less than 90/90/90;

SUPERCEDED

SUPERCEDED

- (b) ý if it is of *lightweight construction* as specified in C1.8(a), comply with Specification C1.8; and
- (c) ý extend to the underside of a *non-combustible* roof covering, or not less than 450 mm above a roof with a *combustible* covering;

8. ý Separating floors

Except where the floor has an FRL of at least 60/60/60, the ceiling under a floor separating *sole-occupancy units*, each being a separate domicile and located one above the other, must have a *resistance to the incipient spread of fire* to the space between the ceiling and the floor of not less than 60 minutes.

7. ý Sarking-type materials

Any *sarking-type material* used in a Class 1 building must have a Flammability Index of not more than 5.

SECTION D ACCESS AND EGRESS

PART D1 PROVISION FOR ESCAPE

Delete D1.6(b) and (c) and insert Qld D1.6(b) and (c) as follows:

Qld D1.6 Dimensions of exits

- (b) ý If the *storey* or mezzanine accommodates not more than 100 persons, the unobstructed width, except for doorways must be not less than-
 - (i) ý 1 m; or
 - (ii) ý 2 m in a passageway from a *ward area*;
- (c) ý If the *storey* or mezzanine accommodates more than 100 persons and not more than 200 persons, the aggregate unobstructed width, except for doorways, must be not less than-
 - (i) ý 1 m plus 250 mm for each 25 persons (or part) in excess of 100; or
 - (ii) ý 2 m in a passageway from a *ward area*.

Add Qld D2.18(b) as follows:

Qld D2.18 Fixed platforms, walkways, stairways and ladders

- (b) ý Where any person is *required* to work on brittle roofing, being-
 - (i) ý any roofing not capable of passing the impact test outlined in AS 2424; or
 - (ii) ý fibre cement roofing, terracotta tiles or concrete tiles,a temporary or permanent walkway or other safe working platform complying with AS 1657 must be provided.

Delete the lead-in of D2.21 and insert lead-in as follows:

Qld D2.21 Operation of latch

A door in a *required exit*, forming part of a *required exit* or in the path of travel to a *required exit* must be readily openable without a key from the side that faces a person seeking egress, by a single hand downward action or horizontal pushing action on a single device which is located between 900 mm and 1.2 m from the floor, unless-

SECTION E SERVICES AND EQUIPMENT

PART E1 FIRE-FIGHTING EQUIPMENT

Delete E1.7 and insert Qld E1.7 as follows:

Qld E1.7 Fire detection and alarm systems

A suitable *automatic* fire detection and alarm system complying with Qld Specification E1.7 must be installed in -

- (a) \dot{y} each *storey* if the building has a *rise* of more than 6 *storeys*;
- (b) \dot{y} a Class 2 building if residential units are more than 3 *storeys* above the *ground level* and the building contains more than 20 dwelling units;
- (c) \dot{y} a Class 3 building -
 - (i) \dot{y} if rooms for residential use are more than 2 *storeys* above the *ground level*; or
 - (ii) \dot{y} in a special accommodation house or home for the aged, children, poor, sick or physically or mentally disabled persons or the like; or the residential part of a *school*, accommodating more than 10 persons at a level above *ground level*; and
- (d) \dot{y} a Class 9a building -
 - (i) \dot{y} if more than 20 patients are accommodated in wards or bedrooms; or
 - (ii) \dot{y} in a clinic or day surgery, having areas where surgical procedures are performed more than 2 *storeys* above the *ground level* or more than 1 *storey* above the *ground level*, if such *storey* has a *floor area* more than 500 m².

PART E4 EMERGENCY LIGHTING, EXIT SIGNS AND WARNING SYSTEMS

Delete E4.9 and insert Qld E4.9 as follows:

Qld E4.9 Emergency warning and intercommunication systems

- (a) \dot{y} An emergency warning and intercommunication system complying with AS 2220 must be installed in-
 - (i) \dot{y} a building with an *effective height* of more than 25 m; or
 - (ii) a Class 5, 6, 7, 8 or 9 building with a total *floor area* more than 18 000 m².
- (b) \dot{y} If (a) does not apply, a manually operated electric fire alarm complying with Qld Specification E1.7 must be installed in-
 - (i) \dot{y} a Class 5 building if-
 - (A) \dot{y} the total *floor area* is more than 500 m²; or
 - (B) \dot{y} the building is more than 3 *storeys* above the *ground level*;
 - (ii) \dot{y} a Class 6 building if the retail space-
 - (A) \dot{y} has a total *floor area* of more than 500 m²; or
 - (B) \dot{y} is more than 2 *storeys* above the *ground level*;
 - (iii) \dot{y} a Class 8 building if -
 - (A) \dot{y} the total *floor area* is more than 1500 m²;
 - (B) \dot{y} the building is more than 1 *storey* above the *ground level* and the total *floor area* is more than 1000 m²;

SUPERCEDED

- (C) the building is more than 3 *storeys* above the *ground level*; or
- (iv) \dot{y} a Class 9b building if -
 - (A) \dot{y} more than 100 persons may be assembled in a *storey* above *ground level*; or
 - (B) \dot{y} more than 500 persons may be assembled in the building.

Add Qld Part E101 as follows:

PART E101 \dot{y} PROTECTION OF ELECTRICAL SUPPLY TO ESSENTIAL SERVICES

Qld E101.1 Definition of essential services

In this Part, essential services has the meaning given in AS 3000 and includes such services as smoke control systems, emergency lifts, emergency lighting and emergency warning and intercommunication systems.

Qld E101.2 Protection of essential services

Where essential services are *required* in a building, the electricity supply to the building must be connected to a main switchboard which must-

- (a) \dot{y} contain switchgear and protection devices that will prevent loss of supply to the essential services in the event of a fault condition; and
- (b) \dot{y} contain an essential services section in accordance with Form 3 of AS 1136.

Delete Specification E1.7 and insert Qld Specification E1.7 as follows:

QLD SPECIFICATION E1.7 \dot{y} FIRE DETECTION AND ALARM SYSTEMS

1. \dot{y} Scope

This Specification describes the installation and operation of fire detection and alarm systems that may be *required* in a building, or that may be utilised to operate smoke control systems or devices.

2. \dot{y} Purposes

The purpose of a fire detection, emergency warning, or inter-communication system in a building is to-

- (a) \dot{y} detect outbreak of fire;
- (b) \dot{y} warn occupants of an emergency;
- (c) \dot{y} activate any installed *automatic* device or smoke control system;
- (d) \dot{y} provide communication between floors to assist evacuation and fire control; and
- (e) \dot{y} alert the local fire brigade.

3. \dot{y} Adoption of Australian Standard

- (a) \dot{y} An *automatic* fire detection and alarm system must comply with AS 1670.
- (b) \dot{y} In addition to AS 1670, or AS 2118 in the case of an Automatic Fire Sprinkler System-
 - (i) \dot{y} any emergency warning and intercommunication system *required* by Qld E4.9 must be interfaced to the fire alarm; or
 - (ii) \dot{y} if an emergency warning and intercommunication system is not *required*, auxiliary warning devices clearly audible or visual throughout every floor must be provided; and

SUPERCEDED

SUPERCEDED

- (iii) ý in a Class 9a building a discrete alert and evacuation tone may be utilised to minimise patient trauma.

4. ý Thermal Detectors

Detectors must be Type "A" normal temperature duty heat detectors throughout the building, except -

- (a) ý in a sprinklered building;
- (b) ý type "B", type "C", type "D", type "E" detectors may be utilised where recommended by Appendix A of AS 1670; or
- (c) ý those areas where smoke detectors are *required*.

5. ý Smoke Detectors

Smoke detectors must be utilised-

- (a) ý in a Class 3 building, in-
 - (i) ý each sleeping area;
 - (ii) ý corridors leading to sleeping areas; and
 - (iii) ý all rooms (except *sanitary compartments*) opening directly to a sleeping area;
- (b) ý in a Class 9a building, in-
 - (i) ý each *ward area* or room which may be occupied by a sleeping, sedated or dependant patient;
 - (ii) ý the path of egress from each *ward area* or room in (i) to a public space;
 - (iii) ý all rooms (except *sanitary compartments*) opening directly to each *ward area* or room in (i); and
 - (iv) ý to other areas necessary for effective smoke control; and
- (c) ý as *required* to activate an *automatic* device.

6. ý Manually Operated Electric Fire Alarm Systems

A manually operated fire alarm system must include-

- (a) ý a signal that is clearly audible or visible throughout every floor of the building (a signal complying with clause 2.2 of AS 2220 satisfies this paragraph); and
- (b) ý manual call-points on each *storey* or mezzanine positioned to be clearly visible, readily accessible, and located in a path of travel to an *exit*; and must -
 - (i) ý be installed in accordance with clause 2.5 of AS 1670 where applicable; and
 - (ii) ý be interfaced to any *automatic* fire alarm that is connected to a fire control station; or
 - (iii) ý if not connected to a fire control station, each manual call-point must be clearly marked as indicated below showing the telephone number for the fire authority in the locality.

NOT CONNECTED TO A FIRE BRIGADE. IN CASE OF FIRE PHONE

7. Location

Manual call points must be located not more than-

- (a) ý for Class 2, 3 or 4 buildings - 20 m from the entrance doorway of any *sole-occupancy unit*;
- (b) ý for Class 5, 6, 7, 8 and 9b buildings - 20 m travel distance from any point on the floor; and
- (c) ý for Class 9a buildings -
 - (i) ý 12 m from any point of the floor of a *ward area*; or

SUPERCEDED

SUPERCEDED

- (ii) ý 6 m from the entrance doorway of any room which may be occupied by a sleeping, sedated or dependant patient.

SECTION F HEALTH AND AMENITY

PART F1 DAMP AND WEATHERPROOFING

Delete F1.7 and insert Qld F1.7 as follows:

Qld F1.7 Water proofing of wet areas in buildings

The following parts of a building must be impervious to water:

- (a) ý In any building - the floor surface or substrate in a shower enclosure, or within 1.5 m measured horizontally from a point vertically below the shower fitting, if there is no enclosure;
- (b) In any building - the floor surface or substrate in a bathroom or shower room, slop hopper or sink compartment, laundry or *sanitary compartment* except for a *sanitary compartment* in a Class 1, 2 or 10 building.
- (c) ý The wall surface or substrate -
 - (i) ý of a shower enclosure, or if the shower is not enclosed, within 1.5 m and exposed to a shower fitting, to a height of 1.8 m above the floor;
 - (ii) ý immediately adjacent or behind a bath, trough, basin, sink, or similar fixture, to a height of 300 mm above the fixture if it is within 75 mm of the wall; or
 - (iii) ý of a *sanitary compartment* except for a *sanitary compartment* in a Class 1, 2 or 10 building.
- (d) ý The junction between the floor and wall if the wall and floor are *required* to be impervious to water.
- (e) ý The junction between the wall and fixture if the wall is *required* to be impervious to water.

Delete F1.11 and insert Qld F1.11 as follows:

Qld F1.11 Provision of floor wastes

In a Class 1, 2, 3 or 4 building, the floor of each bathroom and laundry in a *sole-occupancy unit* which is located at any level above another *sole-occupancy unit* must be graded to permit drainage to a floor waste gully.

Add Qld F1.102 as follows:

Qld F1.102 Flashings to narrow spaces

Spaces between buildings on adjoining sites which are narrower than 600 mm must be sealed off and flashed over to prevent the entrance of weather and vermin.

PART F2 SANITARY AND OTHER FACILITIES

After F2.5(b), add Qld F2.5(c) and (d) as follows:

Qld F2.5 Construction of sanitary compartments

- (c) ý **Entrances** - *Sanitary compartments* must -

SUPERCEDED

SUPERCEDED

- (i) ý other than in an early childhood centre or unisex facility, have separate entrances for the sexes to ensure privacy; and
 - (ii) ý in the case of external facilities, the entrance must be screened.
- (d) ý **Doors** - Every door to a *sanitary compartment* must-
- (i) ý be capable of being fastened from the inside;
 - (ii) ý swing clear of the closet pan; and
 - (iii) ý in the case of a fully enclosed *sanitary compartment*-
 - (A) ý open outwards;
 - (B) ý slide; or
 - (C) ý be readily removable from the outside, unless there is a clear space of at least 1.2 m between the doorway and any other obstruction within the *sanitary compartment* measured at right angles to the doorway.

PART F5 NOISE TRANSMISSION AND INSULATION

Delete F5.1 and insert Qld F5.1 as follows:

Qld F5.1 Application of Part

This Part applies to-

- (a) ý Class 1 buildings separated by a *common wall* or located one above another; and
- (b) ý all Class 2 and 3 buildings.

Add Part F101 as follows:

QLD PART F101 ý RODENT PROTECTION AND BIRDPROOFING

Qld F101.1 Protection from rodents.

For protection from rodents refer to the *Plague Prevention Regulations*.

Qld F101.2 Birdproofing of buildings.

Class 1, 2, 3 and 4 buildings must be designed to prevent the entry of birds to the roof and other enclosed spaces.

SECTION G ANCILLARY PROVISIONS

PART G1 MINOR STRUCTURES AND COMPONENTS

After G1.1(b), add Qld G1.1(c) as follows:

Qld G1.1 Swimming pools

- (c) ý Electrical conductor: Where an in-ground swimming or spa pool is constructed with metallic reinforcing, the means for attaching an electrical conductor to the reinforcing must-
 - (i) ý be incorporated at the time of construction;
 - (ii) ý be positioned for use without causing damage to the pool;

SUPERCEDED

SUPERCEDED

- (iii) \dot{y} be in accordance with the requirements of the relevant statutory electricity supply authority; and
- (iv) \dot{y} where the connecting facility is below *ground level*, have its location clearly marked on the structure or shown on approved plans.

Add Qld Part G101 as follows:

QLD PART G101 AWNINGS AND BALCONIES

Qld G101.1 General provisions.

An *awning* or balcony must not be constructed as part of any building unless-

- (a) \dot{y} structural calculations for the *awning* or balcony and handrails, and for their attachment to the building are submitted before the plans, drawings and specifications of the structure are approved;
- (b) \dot{y} the roof (if any) of the balcony, or of the *awning*, and the floor of the balcony, are impervious to water and have a suitable system of drainage;
- (c) \dot{y} the FRL of the floor of the balcony is at least equal to that *required* for the floor of the building which gives access to the balcony;
- (d) \dot{y} the balcony is provided with means of egress *required* by the provisions of Part D; and
- (e) \dot{y} in a building which is unsprinklered and of Type A or B construction, except a building of Class 1 or Class 10, if any part of an opening in the *external wall* of a *storey* next above the *awning* is;
 - (i) \dot{y} in the plane of the wall to which the *awning* is attached; and
 - (ii) \dot{y} vertically above any part of the *awning*, the *awning* must be of *non-combustible* construction or, if of *combustible* construction, must be separated from the opening above by construction complying with the provisions of C2.6 as though the *awning* were an opening, and the building was of Type A construction.

Qld G101.2 Special provisions over roads.

- (a) \dot{y} An *awning* or balcony must not be constructed over a road unless-
 - (i) \dot{y} it is cantilevered or otherwise entirely supported from the building;
 - (ii) \dot{y} it has a continuous lining or soffit and is constructed throughout of *non-combustible* material, except that battens of timber may be used for fixing linings;
 - (iii) \dot{y} it is set back at least 250 mm from the kerb at a height of not less than 3 m above the level of the kerb; and
 - (iv) \dot{y} the *awning* is, or the roof (if any) and the floor of the balcony are impervious to water and suitably drained so that water will not drop on to the road.
- (b) \dot{y} An *awning* erected over a road must-
 - (i) \dot{y} not be designed or constructed for use as a balcony;
 - (ii) \dot{y} provide reasonable continuity between adjoining *awnings* and adequate protection of the footway beneath from the weather;
 - (iii) \dot{y} not detract from the amenity of the area of its location; and
 - (iv) \dot{y} have a fascia of a depth not exceeding 600 mm.

Qld G101.3 Relaxation

The requirements of Qld G101.2 may be relaxed if special conditions apply and suitable alternatives are implemented.

SUPERCEDED

Qld G101.4 Movable awnings and sun shades over roads

A moveable *awning* or sun shade must not be constructed or attached to any building or to any balcony or fixed *awning* of a building over any road unless-

- (a) √ the *awning* or sun shade, when fully lowered, is everywhere at least 2150 mm above the footpath except that a flap of canvas or similar material may extend a further 150 mm towards the footway;
- (b) √ no part of the *awning* or sun shade overhangs the kerb or comes within 250 mm of it;
- (c) √ all steel or iron work in the *awning* or sun shade is suitably protected against corrosion;
- (d) √ the *awning* is securely fastened in a manner that will prevent danger, obstruction or inconvenience in any road by swaying or flapping in the wind;
- (e) √ the *awning* or sun shade may be rolled up, folded up or removed (together with any brackets or other devices for supporting the sun shade from its hangings or fastenings) by the occupier of the premises to which it is attached.

Add Qld Part G102 as follows:

QLD PART G102 CERTAIN ATTACHMENTS

Qld G102.1 The attachments concerned

A structure which is a clock, showcase, architectural projection, bridge, gangway, portico, cornice, hoarding, sky-sign, aerial, antenna, flagpole, mast, tower, lantern, gargoyle, cathead, crane, chimney, flue or duct, installation or machine for cleaning windows, or any structural or ventilating attachment to a building, or a tunnel which is ancillary to a building or other structure must not be erected unless the requirements of this clause are satisfied.

Qld G102.2 Steel to be protected

All steel or iron work of every aerial, antenna or flagpole must be suitably protected against corrosion.

Qld G102.3 Height above roads

A structure referred to in Qld G102.1 that is to overhang a road must be erected so that-

- (a) √ being a hoarding, none of its parts overhangs the footway at a height less than 2.5 m above the footway;
- (b) √ being any other such structure, none of its parts overhangs the footway at a height less than 3 m above the footway.

Qld G102.4 Drainage from ventilating equipment

Ventilating equipment must not be constructed over any road unless suitable drainage from that equipment is provided.

Qld G102.5 Protection from lightning

The structure must be suitably protected from lightning.

Qld G102.6 Construction

The structures referred to in Qld G102.1 must be-

- (a) √ constructed of suitable fire resisting materials; and
- (b) √ constructed so that they may be removed at any time without causing the building of which they are a part to become structurally unsafe and without causing a reduction in the *required* FRL of any *structural member* of the building.

Qld G102.7 Exemption: Certain structures

This Part does not apply to a non-*loadbearing* aerial, antenna, flagpole, mast or tower, which is detached from a building or other structure and is not more than 10 m in height or which is attached to a building or other structure and is not more than 2.5 m in height.

Qld G102.8 Prevention of falls from buildings or structures

Where a person is exposed to the hazard of falling from a building or structure while cleaning or maintenance work is being carried out-

- (a) √ a work system designed to prevent such falls must be used;
- (b) √ where safety belt anchorage points are used they must be positioned on the building or structure so that a lifeline or safety harness may be attached before proceeding to a point where it is possible to fall; and
- (c) √ anchorage points for the attachment of safety harnesses must comply with AS 2626.

SECTION H SPECIAL USE BUILDINGS**PART H1 THEATRES, STAGES AND PUBLIC HALLS**

Delete H1.1 and insert Qld H1.1 as follows:

Qld H1.1 Application of Part

This Part applies to every enclosed Class 9b building which-

- (a) √ is not a *school* assembly, church or community hall, and has a *stage* and *backstage* area with a total *floor area* of more than 200m²;
- (b) √ is a *school* assembly, church or community hall and has a *stage* and *backstage* area with a total *floor area* of more than 300 m²; or
- (c) √ has a *stage* with an associated rigging loft.

Add Qld Part H101 as follows:

QLD PART H101 WORKPLACES**Qld H101.1 Application of Part**

This Part applies to every building or part of a building to be used as a *workplace*, except for a project under construction.

Qld H101.2 Objectives

Workplaces must be designed and constructed to provide suitable standards of health and safety for employees.

Qld H101.3 Floor surfaces

- (a) √ Floor surfaces must be designed to prevent slips, trips, and falls, and in particular, all floors must have an even slip-resistant surface, without obstructions which might create tripping or stumbling hazards.
- (b) √ Where the nature of the work process is such that spillage or washdown is likely to occur, floors must be-
 - (i) √ finished with a surface impervious to the liquids likely to be spilt or used for cleaning; and
 - (ii) √ sealed to all joining walls with an impervious seal, in such a way that the seal is concavely rounded, and continued up all joining walls for a minimum of 75 mm.

Qld H101.4 Floor drainage

- (a) √ Where the nature of the work process is such that spillage or washdown is likely to occur, floors must be graded to drain off liquids in accordance with the following:
- (i) √ Wash or hose-down areas: 1:25.
 - (ii) √ Wet or mop-down areas: 1:50.
- (b) √ Wherever practicable, drains must be installed to intercept liquid at spillage points, to prevent the spread of liquids over the floor surface.
- (c) √ Where the effluent from drains is likely to be offensive, it must be intercepted by suitable deodorising tanks.

Qld H101.5 Floor coverings

- (a) √ Floor coverings that prevent slips, trips and falls must be provided. In particular, all standing working positions of employees must be covered with either-
- (i) √ wood, rubber, linoleum, resilient types of plastic tiles;
 - (ii) √ suitable compositions containing asphalt, rubber, cork, magnesite; or
 - (iii) √ other semi-resilient, thermally non-conductive materials.
- (b) √ If spillage of liquids may occur where an employee is *required* to work, slip resistant continuous matting must be provided. The matting must be non-liquid absorbing, and allow liquids to pass through it.
- (c) √ Where any floor covering or matting is in localised sections, the coverings must be as thin as practicable, with edges sloped to the main floor.

Qld H101.6 Lighting

Lighting from natural and/or artificial sources to the standard appropriate for the nature of, location and times at which work is performed, must be provided in accordance with AS 1680.

Qld H101.7 Floor area and air space

- (a) √ **Requirements for workplace area and space:** Working area and air space adequate to allow suitable standards of health and safety for each employee must be provided.
- (b) √ **Requirements of workplace area:** An area of 2.3 m² free of any encumbrance for each employee satisfies (a).
- (c) √ **Variation of required area:** *Required workplace* area as specified in (b) may be varied in accordance with any guidelines that may be set in the Code of Practice - *Workplace Amenities*, produced by the Division of Accident Prevention. Where any uncertainty exists, the Local Authority must consult with the Division of Accident Prevention. The process for variation of *workplace* area is set out in the Standard Building By-laws.

Qld H101.8 Dining rooms

- (a) √ **Requirements for dining facilities:** Dining facilities must be provided where the nature of work performed does not allow an employee to eat at or in their work station or in their work area, in safe and hygienic conditions.
- Where provided, dining facilities must be designed and located so that both people and food are kept free of contamination.
- (b) √ **Requirements of dining facilities:** Where dining facilities are *required* by (a), a dining room must be provided at every *workplace*, except-
- (i) √ for five or less employees, a dining area may be provided;

SUPERCEDED

(ii) $\dot{\gamma}$ for shops situated in a shopping complex, one dining room may be used to satisfy the requirements of all the shops in the complex. The dining room area must be based on the total employees of all the shops in the complex.

For fifteen or less employees, all of the same sex, a dining room may be combined with a dressing room.

(c) $\dot{\gamma}$ **Requirements of dining areas:** A dining area must provide adequate facilities for-

(i) $\dot{\gamma}$ washing and cleaning of utensils; and

(ii) $\dot{\gamma}$ storage of utensils, free of dust and vermin.

(d) $\dot{\gamma}$ **Requirements of dining rooms:** A dining room or meal place must have all the provisions of a dining area, in addition to the following:

(i) $\dot{\gamma}$ tables providing 600 mm table length per employee;

(ii) $\dot{\gamma}$ a refrigerator;

(iii) $\dot{\gamma}$ dishwashing sink with draining board and reticulated hot and cold water; and

(iv) $\dot{\gamma}$ facilities for the storage of foodstuffs, free of dust and vermin.

(e) $\dot{\gamma}$ **Dining room size:** The size of a dining facility must be calculated on the basis of the maximum number of employees using it at any one time. The area *required* for each employee is set out in the following Table.

Number of employees	Area required
6 to 12 employees	11 m ²
additional employees up to 25	an additional 0.92 m ²
additional employees thereafter	an additional 0.75 m ²

Qld H101.9 Dressing rooms

(a) $\dot{\gamma}$ **Requirements for dressing rooms:** Where the nature of work requires employees to change in and out of apparel specific to that work, a dressing room for each sex must be provided.

(b) $\dot{\gamma}$ **Requirements of dressing rooms:**

(i) $\dot{\gamma}$ Dressing rooms must be set apart from workrooms, and as near as practicable to *sanitary compartments* and washing facilities.

(ii) $\dot{\gamma}$ Where the clothing of an employee may become wet while engaged in work, a room equipped with drying appliances must be provided adjoining a dressing room.

(iii) $\dot{\gamma}$ A combined dining-dressing room must conform with the requirements of Qld H101.8 in addition to the requirements of this Part.

(iv) $\dot{\gamma}$ A dressing room must be furnished with the following:

(A) $\dot{\gamma}$ a locker for each employee;

(B) $\dot{\gamma}$ protective hanging space for clothing;

(C) $\dot{\gamma}$ seating accommodation;

(D) $\dot{\gamma}$ mirrors and shelving; and

(E) $\dot{\gamma}$ a couch, pillow and blanket.

(c) $\dot{\gamma}$ **Dressing room area:** For the purpose of dressing room design and layout, the following dimensions and sizes are set out.

(i) The minimum unencumbered *floor area* of a dressing room must be 1.8 m², and in additional unencumbered area per employee as set out below:

Type of work	Area
Sedentary or semi-sedentary	0.37 m ²
Light to medium and clean	0.46 m ²

SUPERCEDED

SUPERCEDED

Heavy, hot or dirty ý

0.65 m²

- (ii) ý Lockers must be not less than 300 mm wide and 450 mm deep.
- (iii) ý Passages between facing lockers must be at least 1500 mm wide, or with lockers on one side only at least 900 mm wide.

Qld H101.10 Drinking water

- (a) ý **Requirement for drinking water:** An adequate supply of clean wholesome drinking water must be provided at every *workplace*.
- (b) ý **Requirements of drinking water points:** Drinking water must-
 - (i) ý in situations where workers are likely to be exposed to heat stress or dehydration, be in a readily accessible position; and
 - (ii) ý not be located in a *sanitary compartment*.
- (c) ý **Drinking fountains:** Where there are more than ten employees, drinking fountains should be provided in the following numbers, wherever practicable.

11 to 40 employees:	1
each additional 40 (or part thereof):	1 additional.

Qld H101.11 First aid

- (a) ý **Requirement for first aid:** When the number of employees at any one time exceeds 200, a casualty room, not less than 11 m² in area, dedicated to first aid must be provided.
- (b) ý **Requirements of casualty rooms:** A casualty room must:
 - (i) ý be located as near as practicable to workrooms; and
 - (ii) ý contain:
 - (A) ý a basin washing point
 - (B) ý a stainless steel sink with reticulated hot and cold water, trap connected to waste drainage; and
 - (C) ý be clearly signed on each door with 'FIRST AID', and the name of the nurse or attendant on duty.

Add Qld Part H102 as follows:

QLD PART H102 STABLES

Qld H102.1 Construction of stables

A building used for the keeping of animals and enclosed on 3 or more sides must have-

- (a) ý a suitably drained stable floor constructed of concrete or masonry which is impervious to moisture;
- (b) ý every room, other than a store room, constructed over or adjoining the stable, separated from the stable by walls or floor or both, as the case may be, of masonry or concrete which is impervious to moisture; and
- (c) ý a suitable manure container constructed of impervious material and fitted with covers provided adjacent to the stable.

SUPERCEDED

Add Qld Part H103 as follows:

QLD PART H103 KIOSKS

Qld H103.1 Construction of kiosks

- (a) $\dot{\gamma}$ For the purposes of this clause, kiosk means a stall or a compartment enclosed by walls, which the public does not enter, and which is used for the sale or distribution of goods or services.
- (b) $\dot{\gamma}$ A kiosk must not be erected unless-
- (i) $\dot{\gamma}$ it is situated at least 1.5 m from a road or, if it is constructed as a compartment enclosed by walls, it may be situated at a lesser suitable distance;
 - (ii) $\dot{\gamma}$ it is in an arcade or, if it is not in an arcade, it must have minimum ceiling height of 2400 mm;
 - (iii) $\dot{\gamma}$ every internal dimension is 1 m or more;
 - (iv) $\dot{\gamma}$ it has a *floor area* of at least 1.5 m² if it is to be occupied by one person, or of at least 2 m² per person if it is to be occupied by 2 or more persons; and
 - (v) $\dot{\gamma}$ it has ventilation in accordance with F4.5.

Add Qld Part H104 as follows:

QLD PART H104 PREMISES USED FOR LEAD PROCESSING

Qld H104.1 Application of Part

This Part is applicable to every building or part of a building in which lead processes are carried out, other than a project under construction. The requirements of this Part are in addition to the more general requirements for *workplaces*.

Qld H104.2 Objectives

Areas in *workplaces* used for lead processing must be designed and constructed to prevent lead contamination of employees or the environment.

Qld H104.3 Sole use of area

Areas used for lead processing must not be used for any other purpose.

Qld H104.4 Floor surfaces and drainage

All floors must be:

- (a) $\dot{\gamma}$ finished with a smooth impervious surface;
- (b) $\dot{\gamma}$ graded and drained to permit flushing with water; and
- (c) $\dot{\gamma}$ sealed to all joining walls with an impervious seal, continued up all joining walls for a minimum of 75 mm.

Qld H104.5 Installation of fittings and fixtures

All plant fittings and fixtures must be designed and installed to allow the floor underneath to be cleaned by water or suction cleaning.

Qld H104.6 Interiors

The *workplace* interior, including wall linings, ceilings, roof structure and other structure must:

- (a) $\dot{\gamma}$ have smooth, impervious surfaces;
- (b) $\dot{\gamma}$ be designed, as far as practicable, to avoid projections or surfaces which may collect dust.

Qld H104.7 Washing facilities including showers

Washing and showering facilities must have hot and cold water, and be provided in the following numbers-

- (a) √ one wash basin for every 5 persons (or part thereof); and
- (b) √ one shower for every 8 persons (or part thereof).

Qld H104.8 Dressing rooms

- (a) √ Dressing rooms must not be combined with a dining room.
- (b) √ The provision of lockers or compartments must allow the separate storage of protective clothing and work clothing.

Qld H104.9 Dining rooms

- (a) √ A dining facility must not be located in any area where any compound of lead, mercurial or arsenical preparation or any other poisonous substance is used, manufactured, produced or stored.

Qld 104.10 Exhaust systems

- (a) √ Any area exposed to a process causing dust must be served by an exhaust system capable of collecting all such dust.
- (b) √ Pots, containers or furnaces for processing lead must be connected to an exhaust system capable of safely and effectively collecting all dust, fumes or gases generated in the process.

Such an exhaust system must provide an airflow at any working opening of at least 1 m/s for fumes and gases, and 2.5 m/s for dust collection, measured across the plane of the opening.

Add Qld Part H105 as follows:

QLD PART H105 WORKPLACES INVOLVING ASBESTOS

Qld H105.1 Application of Part

This Part is applicable to every building or part of a building in which asbestos is present √ and capable of giving off dust. √

The requirements of this Part are in addition to the more general requirements for √ *workplaces*. √

Qld H105.2 Objectives

Workplaces using, producing, or containing asbestos must be designed and constructed to prevent the discharge of asbestos dust into the atmosphere.

Qld H105.3 Construction requirements

The interior of any building used for any process involving asbestos, must:

- (a) √ have smooth, impervious surfaces;
- (b) √ be designed, as far as practicable, to avoid projections or surfaces which may collect dust; and
- (c) √ be equipped with a vacuum cleaning system, including filters and a central collection point, designed and constructed to prevent the entry of asbestos from the vacuum system into the atmosphere.

Qld H105.4 Installation of fittings and fixtures

All plant fittings and fixtures must be designed and installed to allow cleaning by vacuum system or other method, to prevent the entry of asbestos dust into the atmosphere.

Qld 105.5 Exhaust systems

Any area exposed to a process causing dust must be served by an exhaust system that prevents the entry of asbestos dust into the atmosphere.

Add Qld Part H106 as follows:

QLD PART H106 $\dot{\gamma}$ WORKPLACES INVOLVING SPRAY PAINTING**Qld H106.1 Application of Part**

This Part is applicable to every building or part of a building in which spray painting or spray coating takes place, except for a project under construction.

The requirements of this Part are in addition to the more general requirements for *workplaces*.

Qld H106.2 Objectives

Workplaces involving spray painting must be designed and constructed to-

- (a) $\dot{\gamma}$ ensure the safety of operators;
- (b) $\dot{\gamma}$ prevent the occurrence and spread of fire; and
- (c) prevent the entry of impurities into the atmosphere.

Qld H106.3 Requirements for booths

(a) $\dot{\gamma}$ A booth is *required* for spray painting or coating, except where:

- (i) $\dot{\gamma}$ all other activity within 12 m is separated from the spray painting by a *non-combustible* wall;
- (ii) $\dot{\gamma}$ the work is performed in an open workroom and:

(A) the work performed is minor spotting and touching up, for not more than 90 minutes in any one day; or

(B) for not more than 15 minutes in any 2 hour period, and not involving lead or silica based paints.

(b) The ventilation facilities of the workroom in which a booth is located must allow free entrance of air into the booth.

Qld H106.4 Requirements of booths

Booths must-

- (a) $\dot{\gamma}$ be entirely constructed or internally lined with metal or other durable *non-combustible* material;
- (b) $\dot{\gamma}$ have a smooth impervious, *non-combustible* floor surface, extending at least 900 mm beyond the entrance to the booth;
- (c) $\dot{\gamma}$ have an emergency *exit* permitting rapid egress, consisting of a door or panel opening outward, situated as far as possible from the normal means of entry, and marked with an EXIT sign;
- (d) $\dot{\gamma}$ be constructed so that windows are fitted with glass complying with AS 2208, in fixed metal sashes; and
- (e) $\dot{\gamma}$ have electrical installations which comply with AS 2381 and AS 1076.

Qld 106.5 Exhaust systems

A booth must be provided with an exhaust ventilation system which-

SUPERCEDED

- (a) ý provides uniform air movement of 0.5 m/s in the zone of the spray operator. This may be reduced to 0.3 m/s where only electrostatic spray painting equipment is used; and
- (b) ý prevents air from the booth entering into the general workspace.

Add Qld Part H107 as follows:

QLD PART H107 FOUNDRIES AND ABRASIVE BLASTING

Qld H107.1 Application of Part

This Part is applicable to every building or part of a building in which foundry operations or abrasive blasting take place, except for a project under construction.

The requirements of this Part are in addition to the more general requirements for *workplaces*.

Qld H107.2 Objectives

Foundries and *workplaces* involving abrasive blasting must be designed and constructed to-

- (a) ý provide suitable standards of safety for employees; and
- (b) ý prevent the discharge of impurities into the atmosphere.

Qld H107.3 Requirements for blasting chambers

Blasting chambers must-

- (a) ý be entirely constructed or internally lined with metal or other durable *non-combustible* material;
- (b) ý minimise dust settlement, and prevent the escape of dust.
- (c) ý be constructed so that windows are fitted with glass complying with AS 2208 in fixed metal sashes;
- (d) ý have an emergency *exit* permitting rapid egress, consisting of a door or panel opening outward, situated as far as possible from the normal means of entry, and marked with an EXIT sign;
- (e) ý be fitted with interlocking doors to prevent blasting while doors are open; and
- (f) ý have electrical installations which comply with AS 2381 and AS 1076.

Qld 107.4 Exhaust systems for blasting chambers

A blasting chamber must be provided with an exhaust ventilation system which-

- (a) ý provides minimum air movement of 0.4 m/s in the direction of extraction. This may be reduced to 0.3 m/s for down-draught air flow chambers;
- (b) ý prevents air extracted from the chamber entering into the general workspace; and
- (c) ý filters and cleans extracted air to ensure the removal of all contaminants.

Qld H107.5 Requirements of foundry areas

- (a) ý Every floor in a foundry must be even, *non-combustible* material, and at a uniform level wherever practicable.
- (b) ý Pit furnaces and pouring pits must be covered by a substantial grating at the point at which metal is removed.
- (c) ý Cooling racks and all fixed sources of heat must be provided, wherever practicable, with ventilation by means of flues extending to open air.

Qld H107.6 Washing facilities including showers

Washing and showering facilities must have hot and cold water, and be provided on the following basis:

- (a) √ one wash basin for every 5 persons (or part thereof); and
- (c) √ one shower for every 8 persons (or part thereof).

Add Qld Part H108 as follows:

QLD PART H108 DETENTION CENTRES**Qld H108.1 Application of Part**

This part applies to those parts of a *detention centre* used for residential accommodation (Class 3), in which the occupants are not permitted free movement within or egress from the building. The BCA applies to *detention centres* except where otherwise specified in this Part.

Qld H108.2 Objectives

The occupants of *detention centres* must be protected against fire and smoke without mitigating the security *required of detention centres*.

Qld H108.3 Fire-resistance and stability

The provisions of C1.5 do not apply to the Class 3 parts of *detention centres*.

Qld H108.4 Bounding construction

The provisions of C3.11 apply except that-

- (a) √ the doors need not be *self-closing*; and
- (b) √ the doors need not comply with C3.11(c)(ii) if Qld H108.14 is complied with.

Qld H108.5 Early Fire Hazard Indices

Note: Special requirements on early fire hazard indices in *detention centres* are under preparation in Queensland.

Qld H108.6 Fire doors, smoke doors, fire windows and shutters

The provisions of clause 3 of Specification C3.4 apply except that doors need not-

- (i) √ swing in the direction of egress;
- (ii) √ return to the fully closed position after each opening; or
- (iii) √ close *automatically*.

Qld H108.7 Number of exits required

The provisions of D1.2 apply except that the Class 3 parts of *detention centres* are not subject to C1.5.

Qld H108.8 Exit travel distances

- (a) √ The provisions of D1.4 do not apply to the Class 3 parts of *detention centres*.
- (b) √ The entrance doorway of a *sole-occupancy unit* must be not more than 30 m from an *exit* or a point from which travel in different directions to two *exits* is available, in which case the maximum distance to one of those *exits* must not exceed 40 m.

Qld H108.9 Doorways and doors

In the Class 3 parts of *detention centres*, a doorway serving as a *required exit*, or forming part of a *required exit* may be fitted with a roller shutter or tilt-up door provided that-

- (a) √ it may be opened, without mechanical assistance, manually under a force of not more than 110 N; or

- (b) ý if it is a mechanically operated door, it contains a personnel doorway complying with D1.6.

Qld H108.10 Swinging doors

Class 3 parts of *detention centres* must comply with D2.20 except that doors need not swing in the direction of egress.

Qld H108.11 Operation of latch

A door in a *required exit*, forming part of a *required exit* or in the path of travel to a *required exit* must be-

- (a) ý readily openable without a key from the side that faces a person seeking egress, by a single hand action on a single device which is located between 900 mm and 1.2 m from the floor; or
- (b) ý capable of being unlocked by hand by a person or persons, specifically nominated by the owner, properly instructed as to the duties and responsibilities involved and available at all times when the building is lawfully occupied so that persons in the building or part may be escorted to *open space* or other place of safety if there is a fire or other emergency.

Qld H108.12 Access for people with disabilities

It is not necessary for the Class 3 parts of *detention centres* to comply with the provisions of Part D3.

Qld H108.13 Hose reels

- (a) ý Hose reels must comply with the provisions of AS1221 and AS2441 except that hosereel cabinets may be lockable.
- (b) ý Hosereels must be provided in every Class 3 part of a *detention centre*.

Qld H108.14 Smoke control

Where doors do not comply with C3.11(c)(ii) or where openings do not comply with C3.11(d), then a system of mechanical smoke extraction must be provided to the corridor, hallway, room, or non-*fire-isolated stairway* serving as a *required exit*, to which the *sole-occupancy unit* has access.

INTRODUCTION

This Appendix contains variations and additions to the provisions of the June 1990 edition of the Building Code of Australia (BCA) which are considered necessary for the effective application of the Code in South Australia.

These variations and additions are to be treated as amendments to the BCA and apply to the construction or alteration of all buildings requiring approval under the Building Act.

CONTENTS

Provisions of the BCA that have been varied and additional provisions applicable in South Australia are as follows:

A - GENERAL PROVISIONS

- SA A1.1 Definitions y
- SA A3.2 Classifications y
- SA Specification A1.3 Standards Adopted by Reference y

B - STRUCTURE

- SA B1.2 Loads y
- SA B1.3 Construction deemed-to-satisfy y
- SA B1.101 Foundation assessment and footing design y
- SA B2.101 Rules for demolition y

C - FIRE RESISTANCE

- SA C2.101 Ancillary use areas in Class 9a buildings y
- SA C2.102 Limit on area for ancillary use y

D - ACCESS AND EGRESS

- SA D1.6 Dimensions of exits y
- SA D1.101 Occupancy limits y
- SA D2.17 Handrails y
- SA D2.21 Operation of latch y

SA Part D3 ACCESS FOR PEOPLE WITH DISABILITIES

- SA D3.1 Application of Part y
- SA D3.2 Access to buildings y
- SA D3.3 Doorways to rooms with closet fixtures y
- SA D3.4 Identification of access facility y
- SA D3.5 Concessions y

E - SERVICES AND EQUIPMENT ^ý

- SA E1.2 Fire mains and water supply services
- SA E1.3 Fire hydrants
- SA E2.4 Air handling systems
- SA E2.7 Pressurisation systems
- SA E4.4 Design and operation of emergency lighting
- SA Specification E1.8 Fire Control Centres.

F - HEALTH AND AMENITY

- SA F1.7 Water proofing of wet areas in buildings
- SA F1.8 Damp-proof courses
- SA F1.9 Acceptable damp-proof courses
- SA F1.10 Damp-proofing of floors on the ground
- SA Table F2.1 Provision of Sanitary and Other Facilities in Residential Buildings.
- SA Table F2.3 Sanitary Facilities in Class 3, 5, 6, 7, 8 and 9 Buildings.
- SA Table F2.4 Sanitary Facilities for People with Disabilities.
- SA F2.101 Locker and change rooms for employees
- SA F3.101 Sizes of bathrooms and shower rooms
- SA F3.102 Sizes of water closets
- SA F4.2 Methods and extent of natural lighting

SA Part F6 RODENT PROTECTION

- SA F6.101 Minimum separation between buildings

G - ANCILLARY PROVISIONS ^ý

- SA G1.1 Swimming pools and spas

SA Part G5 CONSTRUCTION FOR BUSHFIRE AREAS

- SA G5.101 Buildings in bushfire risk areas
- SA G5.102 Construction deemed-to-comply

SA Part G6 DANGEROUS SUBSTANCES STOREROOMS

- SA G6.101 Flammable liquids storerooms
- SA G6.102 No storerooms in Class 1, 2, 3, 4, 5 and 9 buildings
- SA G6.103 Storerooms in Class 6, 7 and 8 buildings
- SA G6.104 Self-contained and isolated storerooms
- SA G6.105 Storerooms for Class 6 and Class 8 dangerous substances
- SA G6.106 Interpretation

SA Part G7 ACCESS FOR MAINTENANCE

- SA G7.101 Application of Part
- SA G7.102 Provision of access deemed to satisfy

SA Part G8 MISCELLANEOUS PROVISIONS

SA G8.101	Application of Part
SA G8.102	Buildings containing stables, manure pits or pigsties
SA G8.103	Protection against lightning
SA G8.104	Attachments to buildings
SA G8.105	Operating theatres
SA G8.106	Detached incinerators
SA G8.107	Access for vehicles used in fire fighting
SA G8.108	Kitchen exhaust hoods

SECTION A GENERAL PROVISIONS ý

PART A1 INTERPRETATION

SA A1.1 Definitions

Insert in A1.1 before specific definitions the following:

Definitions in the South Australian *Building Act 1971* and *Building Regulations 1990*, are invoked by the calling up of this Code.

Insert before "Alpine Area" the following:

Allotment means site.

After the definition of "Mezzanine" insert the following:

Minister's Specification means a Specification issued by the Department of Local Government with the approval of the Minister, containing details which satisfy the performance requirements of the regulation or clause of the same number.

Delete the definition of "Site" and substitute with:

Site has the meaning defined in the *Building Act 1971*.

After the definition of "Sole-occupancy unit" insert the following:

Spa means a water retaining structure that has a facility for heating the water in it and injecting air bubbles or jets of turbulent water.

Delete the definition of "Swimming pool" and substitute:

Swimming pool includes an excavation or structure capable of being filled with water to a depth of more than 300 mm, and intended primarily for swimming or other aquatic activity.

PART A3 CLASSIFICATION OF BUILDINGS AND STRUCTURES

SA A3.2 Classifications

Class 1: Delete paragraph (b) and substitute-

(b) ý a dwelling-house used as a boarding house or the like in which not more than 5 persons are accommodated for fee or reward or other valuable consideration.

Substitute the lead-in to the definition of Class 3 with:

Class 3: a residential building, other than a building of Class 1 or 2, in which 6 or more persons are accommodated for fee or reward or other valuable consideration, including-

Delete Specification A1.3 and substitute SA Specification A1.3 as follows:

SA Specification A1.3 Standards adopted by reference

The Standards and other documents listed in SA Table 1 are referred to in this Code and/or the State Administrative regulations and variations.

SA Table 1 SCHEDULE OF REFERENCED DOCUMENTS

No	Date	Title	BCA Clause(s)
AS 1038		Methods for the analysis and testing of coal and coke	
Part 15	1972	Fusibility of higher rank coal ash and coke ash.	Spec C3.15
AS 1157		Methods of testing materials for resistance to fungal growth	
Part 11	1978	Resistance of rubbers and plastics to surface fungal growth.	SA F1.10
AS 1169	1982		
		Minimising of combustion hazards arising from the medical use of flammable anaesthetic agents.	SA G8.108
AS 1170		Minimum design loads on structures (SAA Loading Code)	SA B1.3
Part 1	1989	Dead and live loads	
Part 2	1989	Wind forces	
AS 1191	1985	Acoustics - Method for laboratory measurement of airborne sound transmission loss of building partitions	Spec F5.5
AS 1200	1988	Boilers and pressure vessels (SAA Boiler Code)	G2.2
AS 1221	1989	Fire hose reels	E1.4
AS 1250	1981	The use of steel in structures (SAA Steel Structures Code) Amdt 2-1984	Spec A2.3 SA B1.3
AS 1276	1979	Methods of determination of sound transmission class and noise isolation class of building partitions	F5.2
AS 1288	1989	Glass in buildings - Selection and installation	SA B1.3

SUPERCEDED

AS 1349	1986	Bourdon tube pressure and vacuum gauges	Spec E1.2
AS 1428		Design rules for access by the disabled	
Part 1	1988	Regulatory requirements	SA D3.2 SA D3.3 F2.5
AS 1529	1974	Code of practice for the installation of household-type hot water supply systems	G1.3
AS 1530		Methods of fire tests on building materials components and structures	A1.1 Spec A2.4
Part 1	1984	Combustibility test for materials	
Part 2	1973	Test for flammability of materials	
Part 3	1990	Test for early fire hazard properties of materials	Spec A2.4
Part 4	1990	Fire-resistance tests on elements of building construction Note: Previous test reports under Part 1-1976, Part 3-1982 and Part4-1975 remain valid.	Spec A2.4 Spec C3.15
AS 1538	1974	Rules for the use of cold-formed steel in structures (SAA Cold-formed Steel Structures Code)	SA B1.3
AS 1562	1980	Design and installation of metal roofing	SA B1.3, F1.5
AS 1603	1974	Thermal detectors for fire alarm installations	Spec E1.7
Part 4	1987	Control and indicating equipment Amdt 1-1988	
Part 6	1987	Fire alarm bells	
AS 1639	1974	Code of practice for design and installation of corrugated asbestos cement roofing. Amdt 1-1974	F1.5
AS 1657	1985	Rules for fixed platforms, walkways, stairways and ladders	D2.18,H1.6
AS 1664	1979	Rules for the use of aluminium in structures (SAA Aluminium Structures Code)	SA B1.3
AS 1668		Rules for the use of mechanical ventilation and air-conditioning in buildings (SAA Mechanical Ventilation and Air-conditioning Code)	
Part 1	1979	Fire precautions in buildings with air-handling systems. Amdt 1-1979	C3.15 Spec, E1.7 Spec E1.8, E2.4, E2.7 Spec E2.3, Spec E2.4 Spec G3.8, Spec H1.2
Part 2	1980	Ventilation requirements	F4.5, F4.11
AS 1670	1986	Automatic fire alarm installations (SAA Code for Automatic Fire Alarm Installations) Amdt 1-1987, 2-1988, 3-1988	Spec E1.7, E2.5, E2.7Spec, G3.8 G4.8
AS 1682	1979	Fire dampers	C3.15
AS 1684	1979	Code of practice for construction in timber framing (SAA Timber Framing Code)	SA B1.3
AS 1691	1975	Rules for the installation of domestic oil-fired appliances (SAA Domestic Oil-fired Appliances Installation Code)	G2.2
AS 1694	1974	Code of practice for physical barriers used in the protection of buildings against subterranean termites	SA B1.3

SUPERCEDED

SUPERCEDED

AS 1720		Rules for the use of timber in structures (SAA Timber Engineering Code)	SA B1.3
AS 1735		Design, installation, testing and operation of lifts, escalators and moving walks (SAA Lift Code)	
Part 2	1986	Passenger and goods lifts - Electric	Spec C1.8, E3.4
Part 11	1986	Fired-rated landing doors	E3.10
Part 12	1986	Facilities for persons with disabilities	D3.3
AS 1736	1975	Code of practice for pliable roof sarking	F1.6
AS 1757	1989	Concrete roofing tiles	SA B1.3, F1.5
AS 1768	1983	Lightning Protection	SA G8.103
AS 1860-	1976	Code of practice for the installation of particleboard flooring	SA B1.3
AS 1903	1976	Reflective foil laminate	F1.6
AS 1904	1976	Code of practice for installation of reflective foil laminate in buildings. Amdt 1-1979	F1.6
AS 1905		Components for the protection of openings in fire-resistant walls. (SAA Fire Door Code)	Spec C3.4 C3.6, D2.22 Spec E1.7
Part 1	1990	Fire-resistant doorsets	
Part 2	1984	Fire resistant roller shutters	
AS 1926	1986	Fences and gates for private swimming pools Amdt 1-1987	SA G1.1
AS 1940	1982	SAA flammable and combustible liquids code	SA G6.102
AS 2049	1989	Terra cotta roofing tiles	SA B1.3, F1.5
AS 2050	1989	Fixing of roofing tiles	SA B1.3, F1.5
AS 2057	1986	Soil treatment of buildings under construction for protection against subterranean termites	SA B1.3
AS 2107	1977	Code of practice for ambient sound levels for areas of occupancy within buildings	Spec E1.8
AS 2118	1982	Automatic fire sprinkler systems (SAA Code for Automatic Fire Sprinkler Systems) Amdt 1-1983, 2-1985	E1.5 Spec E1.5 Spec G3.8
AS 2121	1979	The design of earthquake resistant buildings (SAA Earthquake Code)	SA B1.3
AS 2159	1978	Rules for the design and installation of piles (SAA Piling Code)	SA B1.3
AS 2185	1978	Fibrous plaster products	Spec C1.8
AS 2220	1978	Rules for emergency warning and intercommunication systems for buildings	E4.9, Spec G3.8
AS 2293		Emergency evacuation lighting in buildings	
Part 1	1987	Design and installation	E4.4, E4.8
AS 2327	1980	Composite construction in structural steel and concrete SA B1.3 (SAA Composite Construction Code)	Spec A2.3
AS 2376		Plastics building sheets	SA B1.3, F1.5
Part 1	1980	Extruded PVC	
Part 2	1981	Glass fibre reinforced polyester (GRP)	
AS 2419		Fire hydrant installations	
Part 1	1988	System design installation and commissioning	E1.3

SUPERCEDED

SUPERCEDED

AS 2424	1981	Plastics building sheets - General installation requirements and design of roofing systems	SA B1.3, F1.5
AS 2427	1983	Smoke/heat release vents	E2.5
AS 2428		Methods of testing smoke/heat release vents	E2.5
Part 1	1983	Determination of resistance to leakage during rain	
Part 2	1983	Determination of ability to open under wind loading	
Part 3	1981	Determination of operating characteristics	
Part 4	1981	Determination of effect of flame contact	
Part 5	1983	Determination of discharge coefficient and effective aerodynamic area	
Part 6	1981	Determination of ability to operate under snow loading	
AS 2441	1988	Installation of fire hose reels	E1.4
AS 2444	1985	Portable fire extinguishers - selection and location	E1.6
AS 2601	1983	SAA demolition code	SA B2.102
AS 2626	1983	Industrial safety belts and harnesses -Selection, use and maintenance	SA G7.101
AS 2665	1983	Smoke/heat venting systems	C2.3, E2.5 Spec E2.6 Spec G3.8, Spec H1.2
AS 2818	1986	Guide to swimming pool safety	SA G1.1
AS 2867	1986	Farm structures - General requirements for structural design	SA B1.3
AS 2870		Residential slabs and footings	
Part 1	1988	Construction	SA B1.3, SA F1.10
AS 2904	1986	Damp-proof courses and flashings	SA F1.9
AS 2908	1987	Cellulose cement products - corrugated sheets for roofing and cladding	SA B1.3, F1.5
AS2918	1987	Domestic solid fuel burning appliances - installation	G2.2
AS 3600	1988	Concrete structures	Spec A2.3, SA B1.3
AS 3666	1989	Air handling and water systems in buildings	E5.3, F2.7, F4.5
AS 3700	1989	SAA Masonry Code	Spec A2.3 SA B1.3, F5.5
AISC		Guidelines for the assessment of fire resistance of structural steel members	Spec A2.3
ASTM D 1922-67(1978)		Test method for propagation tear resistance of plastic film and thin sheeting by pendulum method.	SA F1.10
ASTM D 3345-74(1980)		Method of laboratory evaluation of wood and other cellulosic materials for resistance to termites.	SA F1.10
ASTM E 72-80		Standard method of conducting strength tests of panels for building construction.	Spec C1.8
ASTM E 154-68(1979)		Methods of testing materials for use as vapour barriers under concrete slabs and as groundcover in crawl spaces.	SA F1.10
ASTM E 695-79(1985)		Standard method of measuring relative resistance of wall, floor and roof construction to impact loading.	Spec C1.8
CSIRO-DBC&E		Special Report - Low rise domestic and similar framed structures-	SA B1.3
		Part 4 - Supplementary domestic buildings for built-up areas	

SUPERCEDED

CSIRO-NBTC Bulletin 5 - Earth wall construction 4th Edition 1987.	SA B1.3
CSIRO-DBC&E Method for the determination of the penetration resistance to falling aggregate.	SA F1.10
ISO 140 Acoustics - Measurement of sound insulation in buildings and of building elements-	Spec F5.5
Part 4-1978(E) Laboratory measurements of impact sound insulation of floors.	

SECTION B STRUCTURES

PART B1 STRUCTURAL PROVISIONS

SA B1.2 Loads

Delete paragraph (b) and insert the following:

(b) $\dot{\gamma}$ a building-

- (i) $\dot{\gamma}$ with a vertical height of 12 m or more above the adjoining ground surface to the underside of the ceiling or roof cladding (as the case may be), bounding the topmost *storey*, but excluding any lift machine room; or
- (ii) $\dot{\gamma}$ that is a post-disaster or essential facility building that needs to function immediately following an earthquake, including hospitals, power stations, telecommunications stations, broadcasting and television stations, State Emergency Control Stations, Fire Service Stations, Police Stations, and other like buildings,

must comply with AS 2121, except that-

- (iii) $\dot{\gamma}$ the minimum total horizontal earthquake force to be resisted by the building, as defined in rule 6.2.1. of the Standard, will be at least 0.01 W instead of 0.02 W; and
- (iv) $\dot{\gamma}$ the seismic zone applicable to a locality is the seismic zone set out in the Building Regulations 1990 for the relevant Council area.

SA B1.3 Construction deemed-to-satisfy

Delete paragraph 9f) and substitute:

(f) $\dot{\gamma}$ Timber Construction-

- (i) $\dot{\gamma}$ Design of timber structures: AS 1720 or AS 1684;
- (ii) $\dot{\gamma}$ in a Class 10 building where the design wind velocity calculated under AS 1170.2 does not exceed 33 m/s, with a *floor area* less than 60 m²:
CSIRO-DBC&E Special Report - Low Rise Domestic and Similar Framed Structures, Part 4 - Supplementary Domestic Buildings for Built-up Areas, Sections I to V.

Delete paragraph (g) and insert the following:

(g) $\dot{\gamma}$ Footings: AS 2870.1, AS 3600 or AS 2121.

SUPERCEDED

Delete paragraph (j)(ii) and substitute:

- (j) ý (ii) Soil Treatment: AS 2057 except that the requirement for the contractor responsible to provide the duplicate copy or the certificate for the treatment to the Local Government building inspector does not apply.

After paragraph (m) add the following:

- (n) ý Structures for Primary Production purposes in Rural Areas: AS 2867

After clause B1.3 insert the following:

SA B1.101 Foundation assessment

- (a) ý Subject to (c), *foundation* characteristics of a *site* that affect the design and construction of a building or structure on that *site* must be assessed on the basis of-
- (i) ý well established local knowledge and experience of *foundation* conditions in the vicinity of the *site*; or
 - (ii) ý tests on the *foundation* materials.
- (b) ý A *site* of a building or structure having a rise not exceeding 2 *storeys* assessed in accordance with AS 2870.1 is to be taken to have been assessed in accordance with (a).
- (c) ý *Foundation* assessment is not *required* for any of the following buildings or structures-
- (i) ý assembled or partly assembled transportable buildings supported on stumps or piers;
 - (ii) ý timber framed buildings constructed in accordance with AS 1648;
 - (iii) ý steel framed buildings having a *floor area* of less than 500 m²;
 - (iv) ý Class 10a buildings having a *floor area* of less than 500 m².
 - (v) ý *swimming pools*, water tanks and retaining walls, having a height not greater than 3 m, and designed to resist an external loading equivalent to that of a non-cohesive granular material of a density of 2000 kg/m³.

PART B2 DEMOLITION

Insert SA B2.101 and SA B2.102, as follows:

SA B2.101 Demolition or removal of asbestos

The demolition of, or removal of asbestos from, a building or structure must be carried out in such a way that it does not affect the health and safety of-

- (a) ý any occupant of the building or structure;
- (b) ý a member of the public; or
- (c) ý a person performing the demolition or removal.

SA B2.102 Deemed-to-satisfy

The demolition of, or removal of asbestos from, a building or structure that is carried out in accordance with the Occupational Health Safety and Welfare Act 1986 and AS 2601 satisfies the requirements of SA B2.101.

SUPERCEDED

SECTION C FIRE RESISTANCE

PART C2 COMPARTMENTATION AND SEPARATION

After clause C2.12 insert SA C2.101 and C2.102, as follows:

SA C2.101 Ancillary use areas in class 9a buildings

A *patient care area* in a Class 9a building must be separated from an ancillary use area by smoke sealed construction having an FRL of not less than 120/120/120, except-

- (a) ∫ kitchen, including related storage and food preparation areas within a single storey building that -
 - (i) ∫ does not exceed 70 m² in *floor area*;
 - (ii) ∫ has at least one *external wall* with a *window* not less than 2 m²; and
 - (iii) ∫ is separated from the *patient care area* by smoke sealed construction having an FRL of not less than 60/60/60;
 - (b) ∫ a hyperbaric facility that is separated from the *patient care area* and any ancillary use area by smoke sealed construction having an FRL not less than 60/60/60;
 - (c) ∫ a staff common room or dining room having no cooking appliances and which does not exceed 35 m² *floor area*; and,
 - (d) ∫ a storage room which does not exceed 10 m² *floor area*;
- provided that any ancillary use area exceeding 5 m² *floor area* and not *required* to be separated by *fire-resisting construction* must have a close fitting 35 mm thick solid core door fitted with a non-hold open door closer.

SA C2.102 Limit on area for ancillary use

The total *floor area* of all non-fire isolated ancillary use areas permitted by SA C2.101 must not exceed 10% of the *floor area* of the *fire compartment* in which they are located.

SECTION D ACCESS AND EGRESS

PART D1 PROVISIONS FOR ESCAPE

After paragraph D1.6 (b)(ii) insert SA D1.6(b)(iii), delete D1.6 (f) and substitute SA D1.6(f), as follows:

SA D1.6 Dimensions of exits

- (b) ∫ (iii) except that a stairway from a *patient care area* may be reduced to 1.3 m wide, provided that any *fire-isolated passageway* from the base of that stairway has a minimum clear width of 2 m;
- (f) ∫ a doorway must be not less than-
 - (i) ∫ in *patient care areas*-
 - (A) ∫ 1.2 m wide generally; or

SUPERCEDED

- (B) ý 1.5 m wide in a passageway or corridor; or
- (C) ý 1020 mm wide opening into a *fire-isolated stairway*, a *fire-isolated passageway* or an *open space*;
- (ii) ý in areas used by students in a *school* - 870 mm wide;
- (iii) ý the width of *exit required* by (b), (c), (d) or (e), minus 250 mm; or
- (iv) ý in any other case except where it opens into a *sanitary compartment* or bathroom - 750 mm wide; and

After clause D1.13 insert SA D1.101 as follows:

SA D1.101 ý Class 9b buildings: notice indicating number of persons

A Class 9b building that is *required* to be licensed under the *Places of Public Entertainment Act 1913*, or the *Liquor Licensing Act 1985*, and has a space that accommodates more than 50 persons determined in accordance with D1.13, must not be occupied unless a conspicuous and permanent notice has been posted adjacent to that space that-

- (a) ý indicates the maximum number of persons to be accommodated in such a space, as determined in accordance with Table D1.13;
- (b) ý has lettering of not less than 15 mm in height, embossed cast or engraved into a tablet of not less than 200 mm x 80 mm; and
- (c) ý is located not less than 2 m above floor level.

PART D2 CONSTRUCTION OF EXITS

Delete D2.17(c) and substitute SA D2.17(c) as follows:

SA D2.17 ý Handrails

- (c) ý In a *patient care area* of a class 9a building, handrails must be provided to both sides of all passageways, ramps and stairways in accordance with AS 1428.1

After paragraph D2.21(d) insert "or" and SA D2.21 (e) as follows:

SA D2.21 ý Operation of latch

- (e) ý adjacent to the door there must be readily recognisable breakout facilities in the form of-
 - (i) ý a door key in a glass fronted container clearly marked "Break glass in event of Fire"; or
 - (ii) ý a push-out glazed panel not less than 400 mm wide and 1200 mm high with instructions on how to remove the panel clearly marked-
"EMERGENCY ESCAPE PANEL - PUSH OUT".

Delete Part D3 and insert SA Part D3 as follows:

SA PART D3 ACCESS FOR PEOPLE WITH DISABILITIES

SA D3.1 ý Application of Part

This Part applies to all Class 3, 5, 6, 7, 8 and 9 buildings and to certain Class 1 and 2 buildings where expressly referred to.

SUPERCEDED

SA D3.2 Access to buildings

Access for people with disabilities must be provided through the principal or other entrance to and within buildings as set out in SA Table D3.2 by means of a continuous accessible path of travel in accordance with AS 1428.1-

- (a) y from the boundary of the *site*;
- (b) y from any car park space on the *site* (whether within or outside the building)-
 - (i) y that is set aside for people with disabilities using the building; or
 - (ii) y if there are no carparking spaces set aside for them, from a carpark area that serves the building; and
- (c) y from any other building on the *site* to which access for people with disabilities is *required*.

Note: The term 'or other' means the acceptable methods by which access provisions may be varied.

SA Table D3.2 y REQUIREMENTS FOR ACCESS FOR PEOPLE WITH DISABILITIES

CLASS OF BUILDING y	ACCESS REQUIREMENTS
Class 1 and 2, Whenever 20 or more <i>sole-occupancy units</i> of Class 1, 2 or both are constructed on a <i>site</i>	To and within- one <i>sole-occupancy unit</i> or 5% of the <i>sole-occupancy units</i> whichever is the greater number.
Class 3-	To and within- one <i>sole-occupancy unit</i> or 5% of the <i>sole-occupancy units</i> , whichever is the greater number; and To and within one dormitory if dormitories are involved
Class 5, 6, 7, 8, 9a and 9b-	To and within- all areas normally used by the occupants but excluding any plantroom, maintenance area, storeroom or the like.
Class 5, 6, 7, 8, 9a and 9b- Where fixed seating is provided in an <i>assembly building</i> not being a <i>school</i> -	To and within- all areas normally used by the occupants but excluding any plantroom, maintenance area, storeroom or the like. not less than 1 wheelchair space for every 200 seats or part thereof, with a minimum provision of 2 spaces.

Note: For the purposes of this Table, the term "to and within" a building includes those parts, elements, equipment and facilities such as ramps, handrails, grabrails, doorways, circulation spaces, glazing, door controls, lifts, sanitary facilities, controls and floor surfaces as embraced by AS 1428.1, excluding any references within that Standard to AS 1735.12.

SA D3.3 Doorways to rooms with closet fixtures

Notwithstanding other provisions, the clear opening of every doorway to any room with closet fixtures in sole-occupancy u/1nits of a Class 2 or 3 building must be not less than 760 mm in width.

SA D3.4 Identification of access facility

Signs incorporating the international symbol of access in accordance with AS 1428.1 must identify the following:

- (a) ý access entrance and lifts in Class 3 and 9 buildings; and
- (b) ý sanitary facilities in Class 3, 5, 6, 7, 8, 9a and 9b buildings.

SA D3.5 Concessions

It is not necessary to provide access for people with disabilities-

- (a) ý to more than 30% of the public space in a restaurant, cafe, bar, function room, or the like, in a Class 6 or Class 9b building;
- (b) ý to a *mezzanine floor* or other space not regarded as a *storey* by definition;
- (c) ý to more than 1 car parking space for each 100 spaces in a *public carpark*;
- (d) ý to any area if access would be inappropriate because of the particular purpose for which the area is used; or
- (e) ý to the whole of a Class 5, 6, 7 and 8 building if one or more *storeys* in the building is provided with access and access facilities as specified in SA Table D3.2, and parts of those *storeys* are *approved* for the purposes of a disabled person having business in that building.

SECTION E SERVICES AND EQUIPMENT ý

PART E1 FIRE FIGHTING EQUIPMENT

Delete E1.2(a) and insert SA E1.2(a), and delete E1.2(f), as follows:

SA E1.2 Fire mains and water supply services

A *fire main* and water supply system for fire-fighting purposes must-

- (a) ý comply with SA Specification E1.2;
- (f) ý (deleted).

Delete E1.3(b), (c), (d) and (e):

SA E1.3 Fire hydrants

- (b) deleted.
- (c) deleted.
- (d) deleted.
- (e) deleted.

PART E2 SMOKE CONTROL

Delete Table E2.1 and insert SA Table E2.1 as follows:

SA Table E2.1 REQUIREMENTS FOR SMOKE CONTROL

BUILDING	SYSTEM
Class 1 & 10 buildings:	No requirement
Class 2, 3 or 4 buildings:	No requirement within <i>sole-occupancy units</i> unless supplied by a central system in which case E2.4 shall apply.
Buildings with a total <i>floor area</i> less than	No requirement.

SUPERCEDED

500 m ² : Open deck car parks: Open deck stands:	
Single storey buildings, or the top storey of multistorey buildings not exceeding 25 m in <i>effective height</i> where in each case the <i>floor area</i> of each storey does not exceed 1000 m ² .	(a) Natural smoke venting in accordance with E2.3; or (b) air-handling systems in accordance with E2.4; or (c) roof vents in accordance with E2.5; or (d) smoke exhaust systems in accordance with E2.6.
Single storey buildings, or the top storey of multistorey buildings not exceeding 25 m in <i>effective height</i> where in each case the <i>floor area</i> of each storey exceeds 1000 m ² .	(a) Air-handling systems in accordance with E2.4; or (b) roof vents in accordance with E2.5; or (c) smoke exhaust systems in accordance with E2.6.
Multistorey buildings having an <i>effective height</i> not exceeding 25 m and where the <i>floor area</i> of any storey does not exceed 1000 m ² :	(a) Natural smoke venting in accordance with E2.3; or (b) air-handling systems in accordance with E2.4.
Multistorey buildings having an <i>effective height</i> exceeding 25 m or where the <i>floor area</i> of any storey exceeds 1000 m ² :	Air-handling systems in accordance with E2.4.
Enclosed shopping malls exceeding 40 m in length and shops which have a <i>floor area</i> exceeding 500 m ² opening on to enclosed malls.	Smoke exhaust systems in accordance with E2.6.
Shops not exceeding 500 m ² opening on to enclosed malls:	No requirement.
A building containing an <i>atrium</i> :	Smoke exhaust systems in accordance with Part G3.
Theatres, stages and public halls:	Smoke exhaust systems in accordance with Part H1.

Add SA E2.4(c) as follows:

SA E2.4 Air handling systems

(c) \dot{y} in buildings exceeding 25 m in height, must operate in accordance with Specification E2.4.

Add SA E2.7(e) as follows:

SA E2.7 Pressurisation systems

(e) \dot{y} be *automatically* actuated by any fire sprinkler or fire detection system installed in the building.

PART E4 \dot{y} EMERGENCY LIGHTING, EXIT SIGNS AND WARNING SYSTEMS

Add SA E4.4(c) as follows:

SA E4.4 Design and operation of emergency lighting

(c) \dot{y} where self contained *exit* and emergency lights require power supply from the consumer mains then such power must be supplied from a separate circuit.

SUPERCEDED

Note: See following page for SA Specification E1.2.

Delete Specification E1.7 clause 5(c) and insert SA Specification E1.7 clause 5(c) as follows:

SA Specification E1.7 FIRE DETECTION AND ALARM SYSTEMS

(c) utilise smoke detectors-

- (i) of the photo-optical type in *patient care areas* used for sleeping;
- (ii) of alternate ionisation type and photo-optical type in corridors and other paths of egress; and
- (iii) in other areas as necessary for effective smoke detection.

Delete lead-in to clause 4 of Specification E1.8 and insert SA Specification E1.8 clause 4, lead-in as follows:

SA Specification E1.8 FIRE-CONTROL CENTRES

4. Construction

A fire-control centre must be in a separate room where-

SA SPECIFICATION E1.2 FIRE FIGHTING EQUIPMENT

CONTENTS

- 1.0 SCOPE**
- 2.0 DEFINITIONS**
- 3.0 SYSTEM DESIGN**
 - 3.1 General
 - 3.2 Water Supply
 - 3.3 Hydraulic Design
 - 3.4 Location of Hydrants Protecting Buildings
 - 3.5 Location of Hydrants Protecting Designated Open Areas
 - 3.6 Fire Mains
 - 3.7 Hose Connections
 - 3.8 Pipework Design
 - 3.9 Water Supply & Fire Pump Capacity
- 4.0 ANCILLARY EQUIPMENT**
 - 4.1 Hydrant Pump Systems
 - 4.2 Hydrant Cabinets
 - 4.3 Hydrants
- 5.0 FIRE SERVICE BOOSTER**
 - 5.1 General

- 5.2 Arrangement of Fire Service Booster Connection ý
- 5.3 Location ý
- 5.4 Booster Assembly Connections Valves and Fittings ý
- 5.5 Notices of Pressures ý
- 5.6 Boosters Connected in Series with Building Pumps ý
- 5.7 Information to be Displayed in the Cabinet ý
- 5.8 Drainage ý

6.0 PIPING VALVES AND FITTINGS ý

- 6.1 General ý
- 6.2 Pipework Supports ý
- 6.3 Fire Rating of Pipework and Supports ý
- 6.4 Valves ý
- 6.5 Pressure Gauges ý

7.0 HOSE REEL FIRE MAINS ý

- 7.1 General ý
- 7.2 Inadequate Street Water Supply ý
- 7.3 Fire Hose Reel Pump ý
- 7.4 Fire Hose Reel Mains ý
- 7.5 Fire Hose Reel Water Storage Tank ý
- 7.6 The Number of Hose Reels Required to Operate ý
- 7.7 Fire Hose Reels Incorporated in a Hydrant System ý

8.0 TESTING ý

- 8.1 General ý
- 8.2 Pre-Test Preparation of the System ý
- 8.3 Hydrostatic Test ý
- 8.4 Commissioning Tests ý
- 8.5 Record of Test Results ý

APPENDIX

APPENDIX A - List of Reference Documents

1.0 SCOPE ý

This Specification sets out the requirements for the design, installation testing and commissioning of fire *hydrant* and *fire main* systems within buildings and properties.

2.0 DEFINITIONS ý

For the purpose of the Specification, the following definitions apply.

Approved and Approval means approved by, or the approval of, the Regulatory Authority.

Branch means a tapering connection fitted at the end of a delivery hose to allow a nozzle to be fitted to create a jet of water.

SUPERCEDED

Branch Hydrant means a pillar *hydrant* that cannot be accessed by a fire service pump appliance, and because of this limitation, is required to have an outlet pressure provided by the *hydrant* system, suitable for operation of the fire service equipment to be connected to it.

C.F.S. means the South Australian Country Fire Service.

Feed Hydrant means a pillar *hydrant* or fire plug that can be accessed by a fire service pump appliance to within 20 m of its location, used to supply water to the pump appliance that can increase the distribution pressure of the water to that suitable for the fire fighting equipment deployed.

Fire Fighting Tip means a device which has replaced the traditional branch/ nozzle arrangement, used to create a jet or spray of water, generally incorporating a valve to vary and stop the flow rate of water through the tip.

Fire Plug means a below ground *hydrant* valve that a standard S.A.M.F.S. or C.F.S. standpipe can be connected to for the purpose of drawing water from an underground main.

Fire Service Booster means an arrangement of inlet connections, *hydrants*, valves and non return valves, in compliance with Section 4, of the Specification that will enable the attending Fire Service to draw water from a tank or source external to the building and inject this into the fire *hydrant* system to either supplement or replace any flow rates provided by the system.

Flowing Pressure means the static gauge pressure reading achieved at the outlet of a *hydrant* or standpipe when the outlet is discharging the specified flow rate.

Fire Hydrant means an above ground *hydrant* valve or an underground fire plug directly connected to a fire/water main that provides a valved outlet to permit a controlled supply of water to be taken from the pipeline for firefighting.

Hydrant Valve means a valve controlling water flow rate from an outlet that has provision for attachment of a fire hose.

Pillar Hydrant means an above ground fire *hydrant* comprising single or multiple *hydrant* valves. The Pillar is a rising pipe fed from an underground *fire main* that terminates at the *hydrant* valve(s).

Regulatory Authority means the Authority nominated in the South Australian Building Regulations, or where not specified therein, a Minister of the Crown, a government department or other public authority having power to issue regulations orders, or other instructions, having the force of law in respect of any subject covered by the Specification.

S.A.M.F.S. means the South Australian Metropolitan Fire Service.

Specification means this Specification, SA Specification E1.2.

Standpipe means a 50 mm nominal bore pipe with captive lugs and gasket for attachment to an underground fire plug that has 2 X 65 mm diameter outlets for the connection of fire hose.

Tank Feed means a *hydrant* landing valve or a 140 mm diameter valved hose connection fitted to a tank or pipework fed directly from a tank.

Water Supply Authority means the Engineering and Water Supply Department of South Australia (E.& W.S.) or other appropriate authority external to E.& W.S. supply areas.

SUPERCEDED

3.0 SYSTEM DESIGN

3.1 General

The number of fire *hydrants required* depends upon the size of the building and the accessibility of such by the fire service. When external fire *hydrants* and plugs are accessible to a fire appliance, such feed *hydrants* will not require the higher pressures *required* for a branch *hydrant*.

Fire *hydrants* and *fire mains* must be installed in accordance with the requirements of the Regulatory Authority.

The fire *hydrant* and *fire main* reticulation must be a wet pipe system that has its supply valve open and water pressure within it maintained at all times.

3.2 Water supply

3.2.1 Acceptable Sources of Water Supply

Singly or in combination, any of the following permanent water sources are acceptable for a fire *hydrant* and *fire main* installation:

- (a) Towns Mains.
- (b) Private reservoirs or tanks as *approved*.
- (c) Rivers, lakes, dams, bores or sea water as *approved*.

Any corrosive nature and/or contamination by foreign particles of the source of water supply must be adequately addressed by the system design so as not to inhibit the satisfactory operation of the *hydrant* installation.

3.2.2 Capacity of an Acceptable Source of Supply

The capacity of an acceptable source of water supply for a fire *hydrant* or *fire main* system must be such that it will supply the system for a period of not less than 4 hours.

NOTE: The water supply source will usually be located external to the site where the building is erected.

Where a fire *hydrant* system is part of a combined *hydrant* and *sprinkler system*, the source of water supply must additionally cater for the flow rate requirements of the *sprinkler system* that must be:

- (a) for the duration specified in AS 2118; and
- (b) at the *required* flow rate determined by the sprinkler hazard.

For the purpose of this clause, the *required* sprinkler flow rate is the flow rate *required* at the most hydraulically advantaged part of the *sprinkler system*.

Where fire hose reels form a part of the fire *hydrant* or fire *hydrant* and *sprinkler system*, additional fire hose reel water flow rates and storage need not be provided for their operation.

3.3 Hydraulic design

3.3.1 General

When the fire *hydrant* system is discharging the *required* water flow rate at the *required* number of hydraulically disadvantaged *hydrants*, the pressure at each of these *hydrants* must be within the *required* range (see clause 3.9.2). Under these conditions, the velocity in the system pipework must not exceed 3.7 m/s.

3.3.2 Water Hammer Pressures

The designer must make due allowances for water hammer by incorporating adequate pipe thrust and anchor devices within the system. ✓

Water hammer may occur due to pump starting and stopping plus fire authority boosting and flow rate regulation when using the system for fire fighting. ✓

All thrust and anchor devices must be to the approval of the Regulatory Authority and to the satisfaction of the water supply authority. ✓

3.3.3 Maximum Hydraulic Friction Loss

The *hydrant* or combined *hydrant* and sprinkler pipework system must be designed so that:

- (a) ✓ the hydraulic friction loss does not exceed 150 kPa when the *required* maximum flow rate to the most hydraulically disadvantaged *hydrant* outlets occurs; and
- (b) ✓ the maximum hydraulic friction loss permitted occurs between the most hydraulically disadvantaged *hydrant* outlet and:
 - (i) ✓ in the case of a *fire main* equipped with a fire authority booster, the booster inlet connections; or
 - (ii) ✓ where a fire authority booster assembly is not fitted, the point where the *fire main* enters the *site*.

3.4 ✓ Location of hydrants protecting buildings

3.4.1 Internal Hydrants

Hydrants must be accessible to fire fighting personnel and be:

- (a) ✓ within each *required fire-isolated stairway, fire-isolated ramp or fire-isolated passageway*; or
- (b) ✓ where the building has no *fire-isolated stairway, fire-isolated ramp or fire-isolated passageway*, within the tenanted space and within 4 m of a *required exit* serving it; and
- (c) ✓ so that any point on a floor of a building is within reach of a 10 m hose stream issuing from a fire fighting tip at the end of a 30 m length of hose connected to the *hydrant* outlet; and
- (d) ✓ so that the location of *internal walls*, partitions, doorways, storage racking, stored goods and any other obstructions which could restrict the passage of hose throughout the building or area to be protected, do not compromise the requirements of subclause (c);
- (e) in accordance with Figure 1, except that;
- (f) ✓ in buildings that have a rise of not more than two *storeys*, and the ground floor of *multistorey* buildings, external *hydrants* in accordance with clause 3.4.3 may be used in lieu of internal *hydrants*.

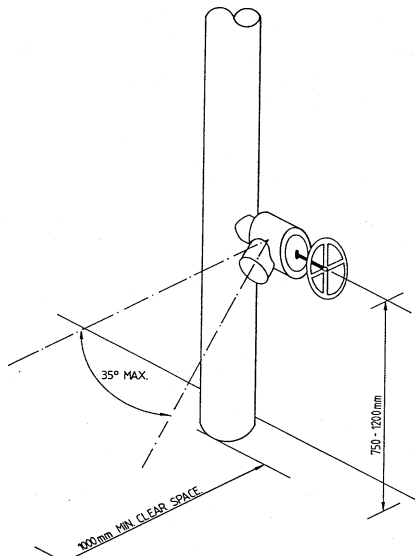

FIGURE 1
HYDRANT LOCATION

3.4.2 Roof Hydrants

Roof *hydrants* must be located so that every part of the roof of the building including any subsidiary structure or item of plant is within reach of a hose stream in accordance with the requirements of clause 3.4.1 for internal *hydrants*.

3.4.3 External Hydrants

Feed *hydrants* located external to the building must have 2 outlets and be located so that:

- (a) \forall any point on a floor of a building is within reach of a 10 m hose stream issuing from a fire fighting tip at the end of a 60 m length of hose connected to a fire appliance fed by the external *hydrant*;

except that:

- (b) \forall They are not closer than 6 m to the building, except that where a wall having a FRL of 90/90/30 extends at least 2 m each side of and 3 m above each *hydrant* outlet and is part of the *external wall* of the building, or lies between the building and the *hydrant*, then the *hydrant* may be located closer to the building or mounted on the outer face of the wall.(see Figure 2).

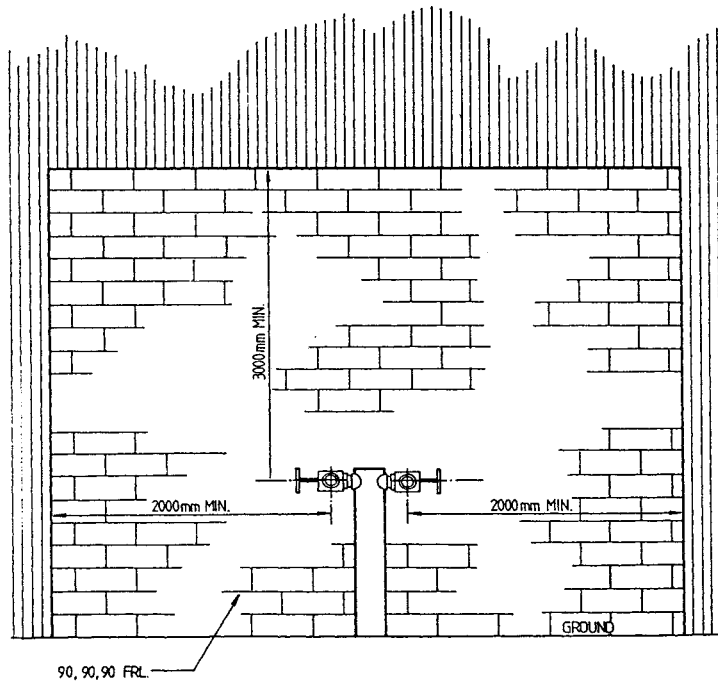

FIGURE 2 $\dot{\gamma}$
PROTECTION AGAINST RADIANT HEAT $\dot{\gamma}$

- (c) $\dot{\gamma}$ They must not be obstructed by parking, or loading and unloading of vehicles, and where necessary are protected from mechanical damage by bollards or other *approved* means.
- (d) $\dot{\gamma}$ For the purpose of subclauses (a) and (b), the distance from the point of hose connection to the nominated point is taken as the most direct hose route when the *storey* to be protected provides horizontal access to the *hydrant*. In other cases, this distance is to be measured along the path followed by the stairway or ramp. For a stairway, the path is taken as a line along the nosings of the treads.
- (e) $\dot{\gamma}$ Where they are installed by a water supply authority on a street main, they may be taken into consideration as external feed *hydrants*, provided that such pillar *hydrants* or standpipes connected to fire plugs comply with the flow rate and pressure requirements of clauses 3.9.1 and 3.9.2 respectively. (see Figure 3).

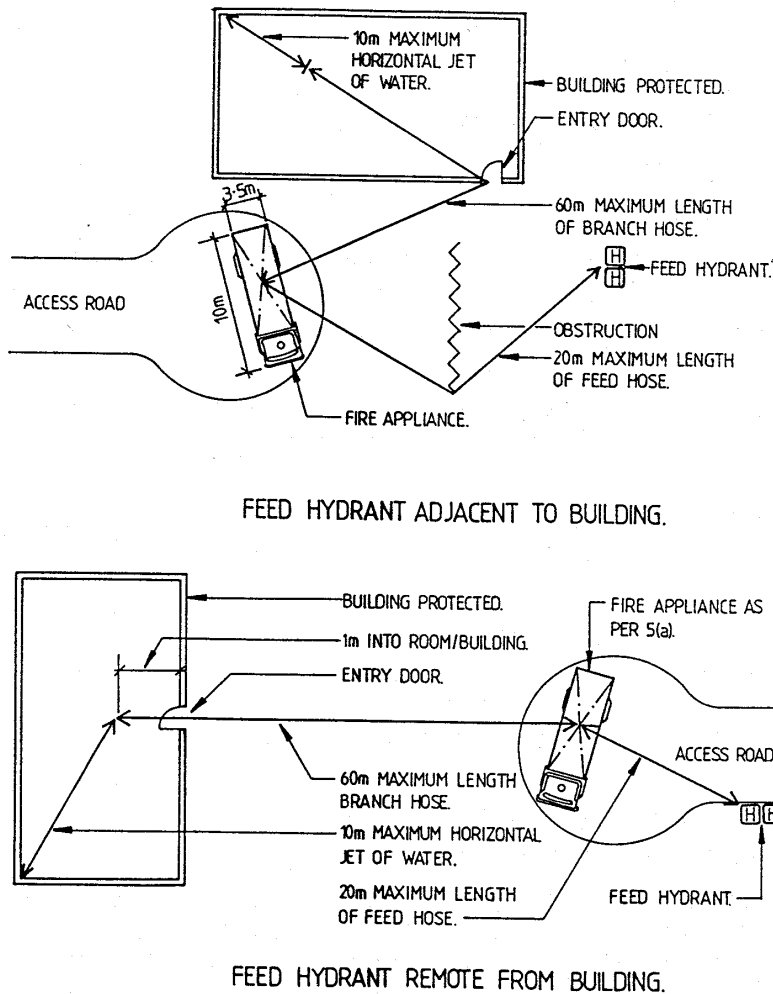

FIGURE 3
TWO EXAMPLES OF FEED HYDRANT LOCATIONS
 (which comply with the requirements of this Specification)

3.5 ý Location of hydrants protecting designated open areas

Where the Regulatory Authority requires protection of open areas due to the nature ý of combustibles stored on the *site* external to the building, the number of external ý *hydrants required* to operate must be in accordance with Table 3.9. ý

For the purposes of this clause, the nominated building areas in Table 3.9 must be ý taken as the open areas which require protection. ý

Hydrant locations must be in accordance with clause 3.4.3 except that a 90 m length ý of hose may be used. ý

3.6 ý Fire mains

3.6.1 Nominal Diameter of a Fire Main

The *fire main* must be of a nominal diameter not less than:

- (a) 100 mm; and
- (b) 150 mm where the *effective height* of the building exceeds 25 m; and
- (c) 80 mm for any branch pipe connection serving a single *hydrant* outlet,

except that where the *fire main* only serves fire hose reels it may have a nominal diameter of not less than:

- (d) 32 mm; and
- (e) 25 mm for any branch pipe connection serving a single fire hose reel.

3.7 Hose connections

Hydrant outlets must have hose connections of not less than 65 mm nominal diameter and must be compatible with the equipment used by the local Fire Authority.

3.8 Pipework design

3.8.1 External Pipework

External Pipework must be located underground as far as practicable (see Section 6). Where it is not possible to install pipework underground, approval must be sought from the Regulatory Authority and be acceptable to the E & W.S. (or other relevant water supply authority). Provision must be made to protect above ground pipework and any supporting structure from fire, mechanical damage and where applicable freezing.

3.8.2 Internal Pipework

Where fire *hydrant* mains are installed within a building, all pipework and its supports must be protected from the effects of fire by either a *sprinkler system* in compliance with A.S. 2118 or a fire rated construction having a FRL of 90/90/90 except that for the purpose of this clause, steel pipework is deemed to satisfy the FRL requirement for the *fire main* (ie, only its supports need to be protected).

3.9 Water supply & fire pump capacity

3.9.1 Flow Rate

3.9.1.1 General: Fire *hydrant* systems must be designed for the simultaneous operation of the *required* number of most hydraulically disadvantaged *hydrants* in accordance with Clause 3.9.1.2.

The outlet of each *required hydrant* must be capable of discharging not less than 10 L/s while maintaining an outlet pressure in accordance with Clause 3.9.2.

Where more than one building or fire-compartment on a *site* is provided with a *hydrant* service, the minimum flow rate for the *hydrant* service must be not less than that *required* for the building or fire-compartment having the largest area. Where monitors or other such fire fighting devices are installed, except where such equipment comprises fire hose reels in accordance with A.S. 1221, the water supply for such equipment must be additional to the fire *hydrant* requirements.

3.9.1.2 Number of Hydrants - Required to Discharge Simultaneously: The number of *hydrants required* to discharge simultaneously must be determined in accordance with Table 3.9.

3.9.2 Pressure

3.9.2.1 Pressure at Operating Hydrants: The unassisted towns main water supply to a fire *hydrant* installation must be capable of maintaining a pressure at the outlets of each of the *required* number of most hydraulically disadvantaged *hydrants*, when simultaneously discharging the *required* flow rate, within the following limits:

- (a) for internal *hydrants*, not less than 350 kPa at 10L/s.

SUPERCEDED

- (b) \dot{y} for external pillar *hydrants*, used as feed *hydrants*, which are not more than 20 m unobstructed access from a fire service pump appliance, not less than 250 kPa at 10 L/s.
- (c) \dot{y} for external fire plugs, used as feed *hydrants*, which are not more than 20 m unobstructed access from a fire service pump appliance, not less than 200 kPa at 10 L/s from the outlet of a standpipe "set in" to the plug.

TABLE 3.9 \dot{y} REQUIRED NUMBER OF HYDRANTS TO DISCHARGE SIMULTANEOUSLY ACCORDING TO BUILDING CLASSIFICATION AND TOTAL FLOOR AREA

Building Classification	Floor Area m ²	No. of Hydrants \dot{y}	Minimum Total Flow Rate (L/s)
2,3,5 & 9	>500 ≤1000	1	10
2,3,5 & 9	>1000 ≤5000	2	20
6,7&8	>500 ≤5000	2	20
All Classes Sprinklered	>5000 ≤10 000	2	20
All Classes Unsprinklered	>5000 ≤10 000	3	30
All Classes	>10 000	1 additional <i>hydrant</i> @10 L/s for each additional 5000 m ² or part thereof	

- (d) \dot{y} for all *hydrants* a maximum flowing pressure of 1200 kPa with a maximum pressure of 1300 kPa at zero flow rate.

3.9.2.2 Fixed on Site Fire Pumps: If the acceptable source of water supply cannot achieve the minimum flow rate and pressure requirements of Clause 3.9.2.1 at all times, then fixed on *site* fire pumps must be installed in accordance with Section 4 of this Specification. The pumps must achieve the following performance at the *required* number of most hydraulically disadvantaged Branch *hydrants*:

- (a) \dot{y} not less than 350 kPa at 10 L/s; and
- (b) \dot{y} not less than 700 kPa or more than 1200 kPa at 5 L/s; and
- (c) \dot{y} the maximum *hydrant* outlet water pressure at zero flow rate while the pump is operating must not exceed 1300 kPa,

except that,

- (d) \dot{y} where the building classification is a 2,3,5 or 9, and has a *effective height* of no more than 12.5 m and is fitted with a booster connection in accordance with Section 5 of this Specification then no pump is *required*: and
- (e) \dot{y} where the building classification is a 2,3,5 or 9 and has a rise of more than 12.5 m and less than 25 m then only a single diesel pumpset in accordance with Section 4 of this Specification is *required*.

3.9.2.3 Fire Service Booster: All buildings equipped with an on-*site* pump or water storage facility, must be equipped with a fire service booster in accordance with Section 5 of this Specification.

3.9.2.4 Towns Mains Design Pressure: Calculations for system design which are based upon the pressure of a towns main at the allotment boundary must be-

- (a) \dot{y} that which the E. & W.S. considers will be maintained for 95% of the time; or

SUPERCEDED

- (b) \dot{y} that which the E. & W.S. considers applicable as a minimum pressure obtained or calculated from its records; or
- (c) \dot{y} in the absence of satisfactory records 67% of the maximum static pressure for major Metropolitan areas and 50% of the maximum static pressure for Country areas.

NOTE: \dot{y} S.A.M.F.S. usually requires a E & W.S. flow test graph of the water supply main, at time of building application, when it gives Council an opinion.

3.9.3 \dot{y} Hydrant and fire main installations required to incorporate a pump suction tank or elevated storage

3.9.3.1 Required On Site Storage: On-site water storage is *required*-

- (a) \dot{y} where the source of water supply is unable to achieve the *required* flow rate; and
- (b) \dot{y} where the building has an *effective height* in excess of 25 m; or
- (c) \dot{y} where the street water supply main is capable of providing the *required* flow and the water supply authority requires the installation of a break tank, then the tank must have a useable water storage capacity of not less than 20 m³.

Such *required* water storage must maintain the maximum *required* flow rate, for a period of not less than 30 minutes.

3.9.3.2 Additional Tank Capacity: Where it can be demonstrated that 30 minutes on *site* water storage is an insufficient time for the fire authority to set up a temporary water supply to the building from an alternative source, due to the geographic location of the *site* or the limited resources available to the fire authority, then it may be necessary to increase the water storage for the additional time *required* to facilitate the setting up of such a temporary supply.

Where no alternative water supply is available, the tank capacity must be sufficient to maintain the maximum *required* flow rate for up to a maximum of 4 hours.

Where the *fire main* installation serves a combined sprinkler and *hydrant* system then the tank must provide the necessary additional water storage for the sprinkler installation as determined by A.S. 2118.

3.9.3.3 Fire Authority Tank Connections: Suitable connections as *approved* by the Regulatory authority must be provided to enable the fire authority to access the contents of any *required* storage tank. Unless otherwise *approved*, such connections must be located within the booster enclosure.

In S.A.M.F.S. areas tank connections will generally comprise 140 mm diameter \dot{y} connections for outlet static pressures of -30 to +250 kPa. \dot{y}

In S.A.M.F.S. areas where the pressure at the tank outlet exceeds 250 kPa at the \dot{y} *required* flow rate and in all C.F.S. areas, tank outlets must comprise not less than 2 \dot{y} x 65 mm diameter connections. \dot{y}

In areas subject to a fire response from both the C.F.S. and the S.A.M.F.S , both 140 \dot{y} mm and 65 mm diameter connections may be *required* as determined by the \dot{y} Regulatory Authority. \dot{y}

Pipework connecting the tank to the *required* fire service connections must have a nominal diameter of not less than 100 mm and must be not less than 150 mm nominal diameter where a 140 mm diameter valved outlet is fitted.

SUPERCEDED

3.9.4 Effective Capacity of Storage

When establishing the effective capacity of a tank, the reduction in volume due to any *required* E. & W.S. air break at the top of the tank, the location of the outlet and any vortex that may occur at low water levels must be deducted from the gross tank capacity.

NOTE: For further design information on this subject refer to AS 2118.

3.9.5 Pressure /Reducing Stations

Pressure reducing valves must only be used with specific approval from the regulatory authority.

Where pressure reducing valves, are used to achieve the pressure limits of clause 3.9.2, they must:

- (a) be duplicated at each location to permit removal of either valve for servicing; and
- (b) if boosting from a fire authority pump appliance reverses the direction of flow, be fitted with a bypass which will *automatically* permit such reverse flow.

4.0 ANCILLARY EQUIPMENT

4.1 Hydrant pump systems

Installed pumpsets must comply with AS 2419 and any additional requirements of this Specification.

4.1.1 Controllers

Each pump installed in a *hydrant* or combined *hydrant* and *sprinkler system* must individually be capable of:

- (a) *automatic* start by remote sensing; and
- (b) manual start at the pump and F.I.P./other location; and
- (c) manual stop at the pump and F.I.P./other location; and
- (d) other modes of control as *approved*.

The *required automatic* on/off control arrangements for the pumpsets, including any necessary remote control and indication must be to the approval of the Regulatory Authority and in accordance with the operational requirements of the Fire Service.

4.1.2 Pumpsets

Pumpsets must provide the *required* pressure and flow rate at the *hydrant* outlet(s).

Where one pumpset is *required* to be installed it must have a compression ignition driver. Where two pumpsets are *required* to be installed, each pump must achieve the total system performance *required* and at least one pump must have a compression ignition driver. Alternatively, three pumpsets may be installed, of which at least two must have a compression ignition driver and any two pumps must achieve the total system performance *required*.

4.1.3 Pump Rooms

All fire pumps and control equipment must be located within a weatherproof room. Where the room is located within a building it must be fire rated in accordance with the requirements of the Regulatory Authority.

Pump Rooms may be located below ground level or in other locations where specifically *approved* by the Regulatory Authority.

4.2 Hydrant cabinets

Where fire *hydrant* cabinets are installed, they must be suitably identified, be of sufficient size to contain all equipment, be accessible to the user without the need of a key of any type and only contain equipment used for fire fighting.

4.3 Hydrants

4.3.1 Hydrant Valves

All outlets, except those located within a cabinet must be fitted with a non-ferrous cap and chain.

4.3.2 Location of Hydrant Valve Outlets

Hydrant valve outlets must be located between 750 mm and 1200 mm above floor *level*.

Outlets must lie in a plane between horizontal and facing down at an angle of 35° to the horizontal. (see Figure 1).

4.3.3 Clearances Around Hydrant Valves

Hydrant valves must be installed with a 300 mm clearance around the outlet for coupling spanners.

A clearance of not less than 100 mm must be provided all around the valve operating wheel. Where anti-vandal oval key spindles are fitted, a clearance of 300 mm will be *required* to rotate the key.

A clearance of not less than 1 m in front of and along the horizontal centre line of the outlet, must be provided to permit a connected fire hose to be run in a sweeping curve from the hydrant to the floor, so that the hose does not kink because the radius of curvature is too small.

5.0 FIRE SERVICE BOOSTER

5.1 General

A Fire Service booster connection must be provided where-

- (a) pumps or tanks are installed in accordance with clause 3.9.2.3; or
- (b) more than 6 external *hydrants* are *required*; or
- (c) the *floor area* of any fire-compartment exceeds 2000 m²; or
- (d) *required* by the Regulatory Authority;

except that in a building with a rise of not more than 2 *storeys* above the highest level at which external *hydrants* are located, where the area of any floor is not more than 2000 m² and where external *hydrant* protection is provided in accordance with this specification, a booster need not be provided.

5.2 Arrangement of a fire service booster connection

5.2.1 Access and Arrangement

Where a booster inlet connection is *required*, to which a fire authority pump appliance may be connected to supply

water to the installed *hydrants* or combined *hydrant* and *sprinkler* system, it must be generally arranged as shown in Figure 4 and be located no more than 20 m from fire service pump appliance vehicular access.

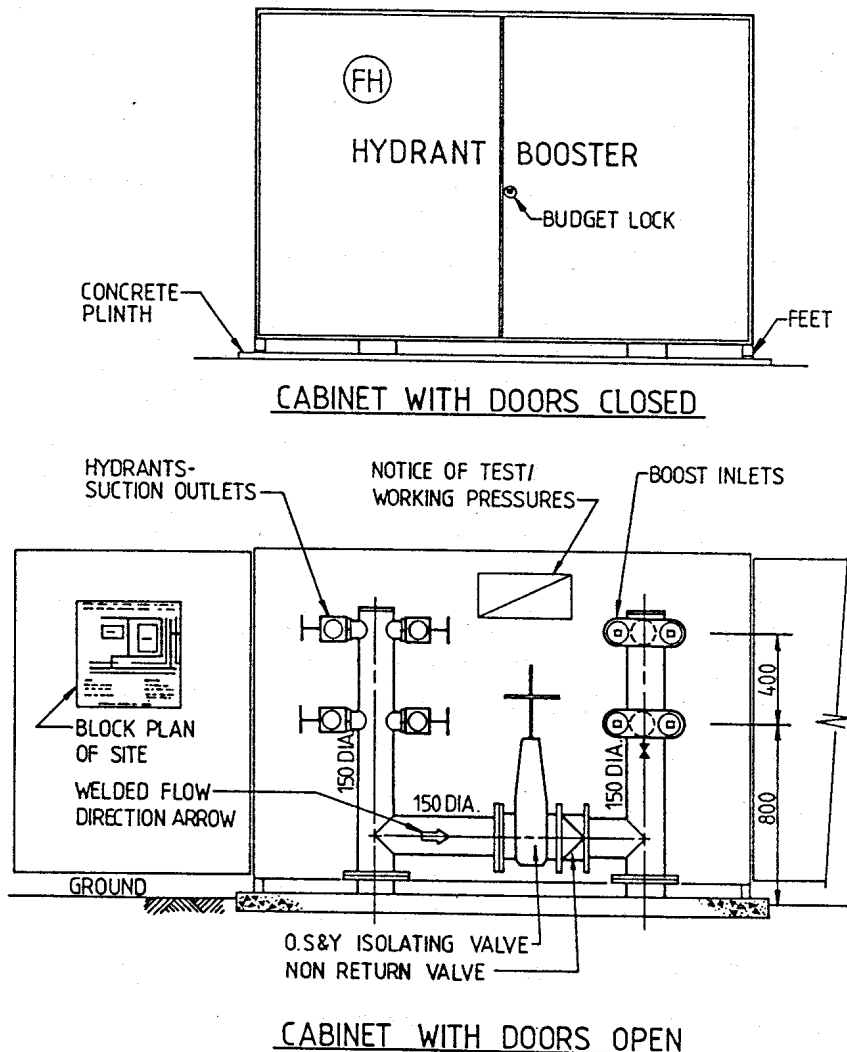

FIGURE 4
TYPICAL BOOSTER ARRANGEMENT DETAILS

5.2.2 Cabinet

The equipment must be installed within a weatherproof cabinet which must-

- (a) \hat{y} be of sufficient size to contain all valves, gauges, couplings and pipework, while providing a minimum clearance of 300 mm around all couplings and valve wheels, except for *hydrant* valve wheels where such clearances must be not less than 100 mm; and
- (b) \hat{y} be fitted with a door or doors each of which must be:
 - (i) \hat{y} a lift off panel no larger than 1500 mm high by 1200 mm wide, weighing not more than 50 kg and fitted with not less than two "D" handles near the top of the panel; or
 - (ii) \hat{y} side hung swing doors with each door fitted with non ferrous hinges and a device capable of securing the door in not less than a 90° open position.

- (iii) ŷ be secured shut by means of a lock openable by a square taper, or other key carried by the local Fire Authority.
- (c) ŷ be identified by a fade resistant sign either affixed or painted on its doors or panels with 75 mm high upper case lettering in a contrasting colour to that of the background stating:
 - (i) ŷ "HYDRANT BOOSTER" ; or ŷ "SPRINKLER BOOSTER"; or ŷ "HYDRANT AND SPRINKLER BOOSTER": or ŷ "COMBINED HYDRANT AND SPRINKLER BOOSTER" ŷ as appropriate, where the cabinet contains only the necessary inlet connections to permit water to enter and boost the fire systems installed; and
 - (ii) ŷ where the cabinet contains fire *hydrant* outlets in addition to the inlet connections, "FH" within a circular line, of inside diameter 100 mm, of the same thickness and colouring as the lettering. See Figure 4 for further information.

5.3 ŷ LOCATION

Boosters must be located:

- (a) ŷ within, or affixed to, the *external wall* of the building; and
 - (i) ŷ within sight of the main entrance to the building; and
 - (ii) where the building or a part of the building is of Class 6,7b, 8 or 9b occupancy be separated from the building by construction having a FRL not less than 120/120/120 for a distance of not less than 2 m each side of and 3 m above the upper hose connections in the booster assembly; or
- (b) ŷ remote from the building; and
 - (i) ŷ at the boundary of the *site*; and
 - (ii) ŷ adjacent to the principal vehicular access to the *site*; and
 - (iii) ŷ located not less than 10 m from the *external wall* of any building; and
 - (iv) ŷ within sight of the main entrance of the building; or
- (c) ŷ in a position *approved* by the Regulatory Authority which satisfies the operational requirements of the Fire Service.

5.4 ŷ Booster assembly connections, valves and fittings

5.4.1 Location of Equipment

The booster assembly must have:

- (a) ŷ all 65 mm diameter inlet and *hydrant* connections located at a height between 600 mm and 1200 mm above ground level; and
- (b) ŷ any 140 mm diameter female suction connection located at a height between 450 mm and 600 mm above ground level; and
- (c) ŷ all isolation valve wheels located at a height between 100 mm and 1800 mm above ground level; and
- (d) ŷ where the *fire main* passes through the cabinet, an arrow welded onto the surface of the pipe, indicating the direction of water flow through the assembly;
- (e) ŷ where not installed within a cabinet all connections protected with non ferrous caps and chains.

A typical booster arrangement is shown in Figure 4.

5.4.2 Non Return Valves

Where the *fire main* passes through the booster cabinet, a non-return valve must be installed within the booster cabinet, on the upstream side of the booster inlets and downstream of any *hydrant* outlets located within the cabinet.

5.4.3 Isolating Valves

Isolating valves must be provided-

- (a) \hat{y} where the *fire main* passes through the cabinet located on the upstream side of the main check valve prior to the booster inlet connection and downstream of any *hydrant* outlet connection within the cabinet (see Figure 4); and
- (b) \hat{y} where a booster assembly is connected to:
 - (i) \hat{y} a rising main which provides a water static pressure greater than 40 kPa. at the lowest booster inlet; or
 - (ii) \hat{y} a system which has additional water supply connections, then additional valves must be fitted which will isolate the booster inlets from the system.

5.4.4 Booster Inlet Connections

Each inlet connection forming a part of a booster assembly must permit a *fire main* to be pressurised without the need to operate valves; and

- (a) \hat{y} must have a nominal diameter of 65 mm and be suitable for the connection of fire hose carried by the Fire Authority; and
- (b) \hat{y} must be fitted with not less than a 100 mm diameter pressure gauge.

5.4.5 Number of Booster Inlets Required

Where a booster is connected to:

- (a) \hat{y} a *fire main* having a nominal diameter of 100 mm, a minimum of two inlets must be provided; and
- (b) \hat{y} a *fire main* having a nominal diameter greater than 100 mm, it must be provided with:
 - (i) \hat{y} a minimum of four inlets for a system requiring a flow rate of not more than 50 L/s; and
 - (ii) \hat{y} an additional two inlets for each 25 L/s or part thereof for a *required* flow rate in excess of 50 L/s; and
 - (iii) \hat{y} a maximum of 8 inlets; and
 - (iv) \hat{y} where the *required* flow rate exceeds 100 L/s, additional booster locations must be provided, so that when operating simultaneously the combined capacity of the boosters is capable of supplying not less than the total *required* flow rate; and
 - (v) \hat{y} where a combined sprinkler and *hydrant* system is installed, the *required* flow rate must be the sum of the *required hydrant* and sprinkler flows rates.

5.4.6 Number of Hydrant Outlets Required

The number of *hydrant* outlets *required* must be equal to the number of *required* booster inlets in accordance with clause 5.4.5.

Unless specifically *approved* by the Regulatory Authority, all *hydrant* connections must be located within the booster cabinet.

Where *hydrant* outlet connections are permitted external to the cabinet they must be sited no more than 8 m from the cabinet and be accessible by a fire service pump appliance.

For the purpose of this clause, a fire plug must not be counted as a fire *hydrant* outlet.

5.5 γ Notice of pressures

A fade resistant engraved sign must be fixed in a prominent position within the cabinet or where no cabinet is *required* on the assembly, with the following wording in 25 mm high upper case lettering in a colour contrasting with that of the background stating:

"SAFE WORKING PRESSURE (*) kPa"; and

"SYSTEM TESTED TO (*) kPa"

* insert the appropriate pressures on the sign.

5.6 γ Boosters connected in series with building pumps

Where the booster is connected in series with the building fire pumps, the following additional provisions must be made:

- (a) γ a full flow rate bypass with non return valve, of equal diameter to that of the incoming *fire main* must be connected between the pump suction and pump discharge pipe/manifold.
- (b) γ a 150 mm diameter pressure gauge, which will indicate the pressure in the pump discharge pipe/manifold, must be located in the booster.
- (c) γ an engraved sign must be affixed adjacent to the pressure gauge and comprise of white lettering on a red background with the following wording:

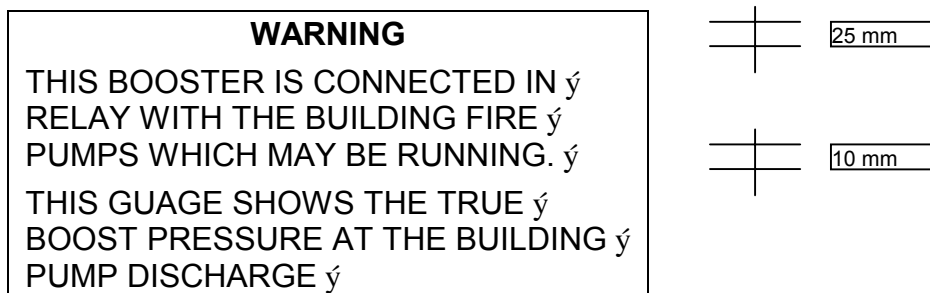

5.7 γ Information to be displayed in the cabinet

A permanent fade and water resistant plan of the building, *site* and adjoining roads, see Figure 5, equal to photo-engraved anodized aluminium must be fixed to the inside face of a cabinet side hung swing door, or where lift off panels are utilised, in a prominent position within the cabinet or where no cabinet is *required* on the assembly, which details the following information for the Fire Authority:

- (a) γ The layout of the building and adjacent streets.
- (b) γ The layout of the fire *hydrant* system reticulation, including:
 - (i) γ supply authority street mains;
 - (ii) γ the nominal size of all water mains shown;
 - (iii) γ location and number of *hydrants*;

- (iv) ý location of fire hose reels;
- (v) ý location of booster connections;
- (vi) ý location of all isolating and non-return valves;
- (vii) ý location of pumps and tanks.

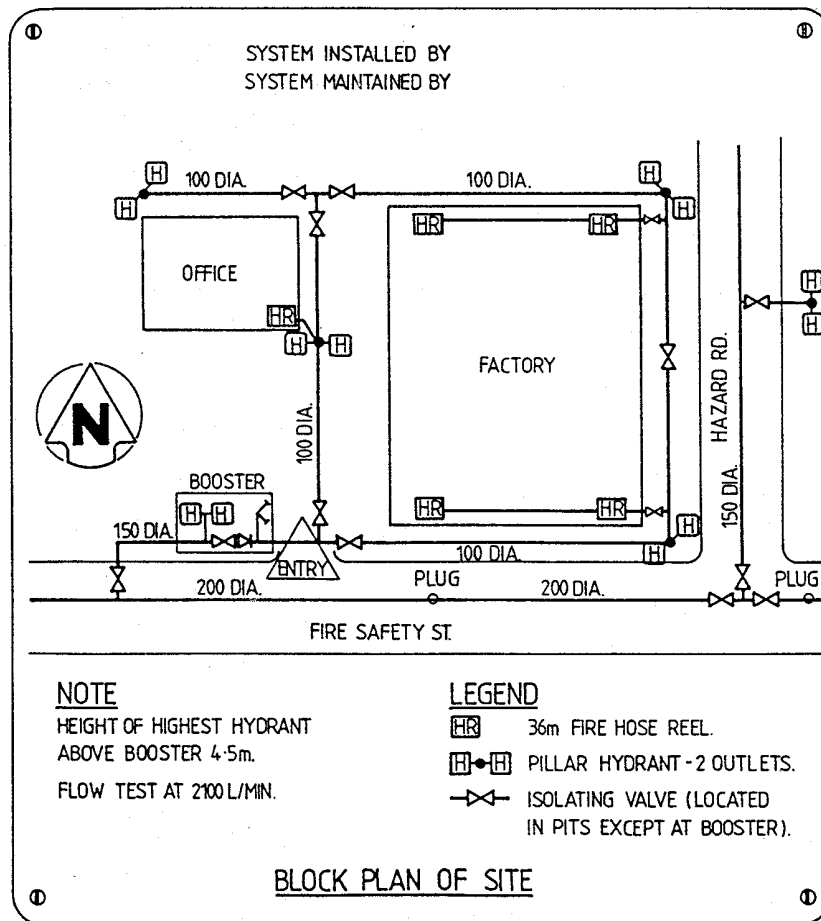

FIGURE 5
TYPICAL SITE PLAN

- (c) ý The following information (in metric units):
- (i) ý the operational discharge pressure and pressure at zero flow rate of any pump installed in the system;
 - (ii) ý the capacity of any tank connected to the system;
 - (iii) ý the height of the highest *hydrant* outlet above the lowest booster inlet connection; and
 - (iv) the year of installation of the system, the name of the contractor who installed the system and the name of the organization responsible for the maintenance of the system.

5.8 ý Drainage

Provision for the drainage of water from within a *required* booster cabinet must be made as follows:

- (a) cabinets remote from the building must be mounted on legs standing on a 150 mm thick concrete plinth, to provide a 50 mm space between the bottom edge of the cabinet and the concrete plinth; or
- (b) where the cabinet is built into an *external wall* of a building, it must have a sloping floor of not less than 75 mm from the rear of the cabinet to weepholes at the front.

6.0 PIPING VALVES AND FITTINGS

6.1 General

All pipework valves and fittings must be manufactured and installed to the approval of the Regulatory Authority and be to the satisfaction of the water supply authority.

6.2 Pipework supports

Support of fire *hydrant* and *fire main* pipework must be in accordance with A.S. 2118 clause 7.15, as though the sprinkler pipework specified were fire *hydrant* or *fire main* pipework.

6.3 Fire rating of pipework and supports

Where the pipework may be exposed to fire in a building which is not sprinklered then the pipe supports must be fire rated to achieve an FRL of 90/90/90 or other measures must be taken to prevent its early collapse when exposed to fire.

Where copper pipework may be exposed to fire in a building which is not sprinklered then the pipe must be fire rated to achieve an FRL of 90/90/90.

6.4 Valves

6.4.1 Hydrant Valves

All *hydrant* valves incorporated within the installation must-

- (a) be of copper alloy construction; and
- (b) be operated by a counter clockwise rotating wheel; and
- (c) have a coupling suitable for the connection of fire hose carried by the Fire Authority.

6.4.2 Isolating Valves

Isolating valves must be, full flow outside screw and yoke wheel gate valves or *approved* butterfly valves closed by clockwise rotation of the wheel, and-

- (a) be secured in the open position by means of a padlock or padlocked leather strap; and
- (b) have affixed to the valve body or strap, a plate inscribed with the words "FIRE MAIN VALVE - SECURE OPEN" in 8 mm high upper case lettering.

6.5 Pressure gauges

Pressure gauges installed within a fire *hydrant* or *fire main* system must-

- (a) comply with AS 1349 -Bourdon Tube Pressure and Vacuum Gauges;
- (b) have a full scale reading of not less than 25% more than the system hydrostatic test pressure which occurred at the point where the gauge is located; and
- (c) be fitted with a gauge cock to permit removal, servicing or testing of the gauge.

7.0 HOSE REEL FIRE MAINS

7.1 General

Hose reels fed by *fire mains* connected to street water supply must be installed as *required* by the Regulatory Authority.

7.2 Inadequate street water supply

Where a building requires fire hose reels, but does not require *hydrants* and where the water supply is unable to meet the pressure and flow rate requirements of the hose reels, then a fixed on-*site* fire pump must be installed and fed from a tank.

7.3 Fire hose reel pump

The fire pump must be self priming and have a capacity to supply water at a flow rate and pressure necessary to provide a flow rate of not less than 0.45 L/s at each hose reel *required* to operate.

The pump must operate *automatically* upon the operation of any fire hose reel, except that, where all hose reels are located external to the building, subject to approval by the Regulatory Authority, the requirement for an *automatic* pump start may be waived, provided the pump is located within 10 m of the hose reel and adjacent to each reel a prominent sign is affixed with white letters on a red background, stating:

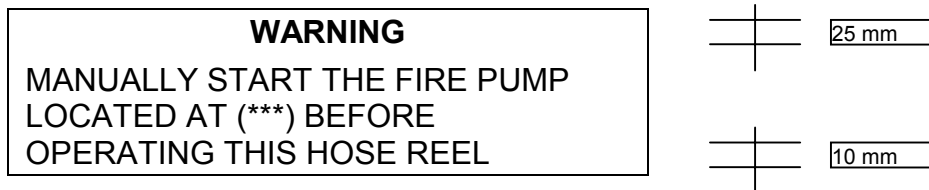

7.4 Fire hose reel mains

Where fire hose reels only are installed, then the main serving such hose reels may be unprotected copper.

7.5 Fire hose reel water storage tank

Where *required*, the storage tank must have a usable capacity of not less than 2000 litres.

7.6 Number of hose reels required to operate

Where more than one hose reel is installed, the system must be designed to provide the *required* flow rate at each of the two most hydraulically disadvantaged hose reels when they are operated simultaneously.

7.7 Fire hose reels incorporated in a hydrant system

Where fire hose reels are fed from a fire *hydrant* system, no additional storage capacity is *required* to be incorporated in any tank serving the *hydrants* for operation of the fire hose reels.

Where a dedicated fire hose reel branch main is taken from a fire *hydrant* system main to serve one or more hose reels and that branch main has a nominal diameter greater than 25 mm, then an isolation valve must be provided at the connection point into the *hydrant* main.

The valve must be strapped and padlocked in the open position.

8.0 TESTING

8.1 General

The tests detailed in this section must be conducted at commissioning time and at other times thereafter as *required* by the Regulatory Authority.

8.2 Pre-test preparation of the system

Upon completion of the fire *hydrant* and *fire main* installation, all trapped air within the system must be removed and the system fully flushed to remove any debris which may have accumulated within the system during construction of the installation.

8.3 Hydrostatic test

All pipework must be tested to not less than 1800 kPa or 1.5 times the highest operational pressure to which the system will be subjected in accordance with clause 8.4 to achieve the *required* flow rate.

The test must be applied for a duration of 2 hrs to the satisfaction of the Regulatory Authority.

In multi-storey buildings, where the highest operational pressure exceeds 1200 kPa, each pressure zone must be tested separately by applying a pressure of not less than 1050 kPa at the *hydrant* outlet which has the least hydrostatic pressure ie. usually the highest point in each zone.

8.4 Commissioning tests

The following tests must be carried out upon completion of the installation and satisfactory hydrostatic testing in accordance with clause 8.3.

8.4.1 Systems which DO NOT Incorporate a Booster Pump or Tank

The *required* number of most hydraulically disadvantaged *hydrants* must be operated at the minimum *required* outlet pressure and the resultant flow rate recorded.

Where more than one external pillar *hydrant* is installed, a single outlet from each of the *required* most hydraulically disadvantaged *hydrants* must each produce a flow of 10 litres per second under test.

8.4.2 Systems which Incorporate a Booster

When the booster inlet is connected to a S.A.M.F.S. or C.F.S. pump appliance, a boost pressure must be applied sufficient to achieve the *required* flow rate at the *required* number of most hydraulically disadvantaged *hydrants* while maintaining a pressure of not less than 700 kPa at the most hydraulically disadvantaged *hydrant* outlet.

The *required* pressure at the booster inlet to achieve this performance must not exceed the designed working pressure of the system as displayed within the booster cabinet.

Where the booster effectively connects the fire appliance in series with the building pumps, an additional test will be carried out:

With one pump operating, the most hydraulically disadvantaged *hydrant* must discharge water at an outlet pressure of 700k Pa and the resultant flow rate recorded. While maintaining this recorded flow rate, the system will be boosted to achieve a *hydrant* outlet pressure of 1000 kPa, at which time, the pressure indicated on the gauge of the booster assembly inlet and that indicated on the building pump

discharge pressure gauge (also located within the booster cabinet) must be recorded.

The pressure indicated on the building pump discharge pressure gauge to achieve this performance, must not exceed the designed working pressure of the system as displayed within the booster cabinet.

NOTE: The additional 300 kPa safety margin which occurs with a complying system is necessary as over pressurisation of such type of systems, due to flow rate variations, is likely.

8.4.3 Systems Which Incorporate a Pump

When each *required* pump or pump group is separately operated, the *required* number of most hydraulically disadvantaged *hydrants* must discharge at an outlet pressure of 700 kPa, and the flow rate recorded.

At this pressure the recorded flow rate must be not less than 50% of the *required* flow rate. In addition, these *hydrants* will also be tested at the minimum *required* outlet pressure of 350 kPa and the resultant flow rate recorded.

Furthermore, the system will be tested at zero flow rate condition, when each *required* pump or pump group is separately operated, and the resultant pressure will be recorded. The outlet pressure of the most hydraulically advantaged *hydrant* must not exceed 1300 kPa.

8.4.4 Systems Which Incorporate a Tank

Where a tank is incorporated within a system and the tank is equipped with a connection for a S.A.M.F.S. or C.F.S. pump appliance, then:

A pump appliance must be connected to the tank outlet and a boost pressure must be applied to the system to achieve the *required* flow rate at the *required* number of most hydraulically disadvantaged *hydrants* at a discharge pressure of not less than 700 kPa at the most hydraulically disadvantaged *hydrant* outlet.

8.5 Record of test results

Where the Regulatory Authority requires the building to have a Fire Safety Log Book, the recorded results of the flow rate tests nominated in this Section must be included in the book, endorsed by a recognized authority as appropriate.

APPENDIX A

LIST OF REFERENCE DOCUMENTS

The following documents are pertinent to the design of a fire *hydrant* system and may be used as reference material. However, they do not form a part of this Specification unless specifically nominated.

Australian Standards

AS 1074	Steel tubes and tubulars threaded or suitable for threading with pipe threads of Whitworth form.
AS 1159	Polyethylene (polythene) pipe for pressure applications.
AS 1221	Fire hose reels.
AS 1281	Cement mortar lining of steel pipes and fittings.
AS 1342	Copper tubes for water gas and sanitation.
AS 1349	Bourdon tube pressure and vacuum gauges.

SUPERCEDED

- AS 1477 Unplasticized PVC (UPVC) pipes and fittings for pressure applications (metric units).
- Part 1: UPVC pipes for pressure applications.
 - Part 2: Moulded UPVC fittings for pressure applications.
 - Part 3: Fabricated UPVC FITTINGS for pressure applications.
 - Part 4: Post-formed UPVC bends for pressure applications.
 - Part 5: Solvent-welding joints for UPVC pressure pipes and fittings.
 - Part 6: Rubber ring joints for UPVC pressure pipes and fittings.
- AS 1516 The cement mortar lining of pipes in-situ.
- AS 1572 Copper and copper alloys - Seamless tubes for engineering purposes.
- AS 1579 Arc welded steel pipes for water and gas.
- AS 1724 Cast grey iron pressure pipes and fittings with bolted gland joints.
- AS 1769 Welded stainless steel tubes for plumbing applications.
- AS 1835 Tubes for pressure purposes - Seamless steel.
- AS 1836 Tubes for pressure purposes - Welded steel.
- AS 1851 Maintenance of fire protection equipment.
- Part 4: Fire hydrant installations.
- AS 1873 Explosive-powered hand-held fastening tools, fasteners and explosive charges.
- AS 1940 SAA Flammable and Combustible Liquids Code.
- AS 2032 Code of practice for installation of UPVC pipe systems.
- AS 2033 Installation of polythene pipe systems.
- AS 2118 SAA Code for Automatic Fire Sprinkler Systems.
- AS 2200 Design charts for water supply and sewerage.
- AS 2280 Centrifugally cast ductile iron pressure pipes.
- AS 2441 Installation of fire hose reels.
- AS 2544 Grey iron pressure pipes and fittings.
- AS 2700 Colour standards for general purposes.
- AS 2792 Fire hose - Delivery layflat.
- AS 2941 Fixed fire protection installation - Pumpset systems.
- AS 3000 SAA Wiring Rules.

British Standards

- BS 3974 Pipe Supports.
- Part 1: Pipe hangers slider and roller type supports.

SUPERCEDED

SECTION F HEALTH AND AMENITY

Add objectives for SA Part F6 as follows:

SA PART F6 RODENT PROTECTION

The formation of narrow spaces between buildings, or a building and the boundary, must be avoided to limit the possibility of litter buildup and subsequent rodent infestation.

PART F1 DAMP AND WEATHERPROOFING

Delete F1.7 and insert SA F1.7 as follows:

SA F1.7 Water proofing of wet areas in buildings

- (a) ý A laundry, bathroom, shower facility, water closet or room containing a shower facility or a sanitary fixture such as a handbasin, vanity bowl, urinal, bidet, cleaner's sink, slop sink, pan sink, sterilizer, potato peeler or any other similar fixture must have-
- (i) ý a floor surface that is impervious and drained to prevent the accumulation of water on it;
 - (ii) ý a wall surface that is impervious;
 - (iii) ý 8:impervious joints between the floor and wall surfaces; and
 - (iv) ý in the case of a shower facility, impervious joints between adjacent walls.
- (b) ý In group shower facilities the water from the floor of one shower facility must not flow over the floor of another shower facility.
- (c) ý The enclosure under every built-in bath must be ventilated and have an impervious floor graded to an outlet discharging over an adjacent floor, except where the bath is
- (i) ý situated on the ground floor of a building and is suspended in accordance with E&WS Sanitary Plumbing and Drainage Directions; and
 - (ii) ý that floor of the building is provided with underfloor ventilation in ý accordance with clause F4.10. ý
- (d) ý Every in-situ bath must have impervious surfaces and construction.
- (e) ý Where a bench top containing an inset sanitary fixture or any sanitary fixture abuts a wall surface -
- (i) ý the wall surface must be impervious; and
 - (ii) ý the joint between the sanitary fixture or bench top and the wall surface must be impervious.
- (f) ý Compliance with Minister's Specification SA F1.7 is compliance with this clause.

Delete F1.8 and F1.9 and insert SA F1.8 and SA F1.9, as follows:

SA F1.8 Damp-proof courses

Except in a building that is exempt from weatherproofing under F1.4, moisture from the ground must be prevented from reaching -

- (a) ý the lowest floor timbers and the walls above the lowest floor joists;

- (b) ý any part of a masonry wall; and,
- (c) ý the underside of a suspended floor constructed of a material other than timber, and the supporting beams or girders.

SA F1.9 Acceptable damp-proof courses

- (a) ý Every damp-proof course *required* must-
 - (i) ý be impervious to the passage of water; and
 - (ii) ý exhibit long term resistance to degradation by dissolved salts in ý groundwater. ý
- (b) ý The following damp-proof courses are deemed-to-satisfy the requirements of (a):
 - (i) ý embossed black polyethylene film of high impact resistance and low slip, with a nominal thickness of 0.5 mm prior to embossing, and meeting the requirements of clause 7.6 of AS 2904; or
 - (ii) ý polyethylene coated metal, that has an aluminium core of not less than 0.1 mm thick, is coated both sides with bitumen adhesive enclosed in polyethylene film of not less than 0.1 mm thick on each face, and has a nominal total thickness of not less than 0.5 mm prior to embossing; or,
 - (iii) ý bitumen impregnated materials of not less than 2.5 mm thickness, that meet the requirements of clause 7.5 of AS 2904, when used in walls not higher than 7.8 m above the level of the damp-proof course; or
 - (iv) ý other suitable material.

Delete F1.10(a)(i) and insert SA F1.10(a)(i) as follows:

SA F1.10 Damp-proofing of floors on the ground

- (a) ý (i) the insertion of a vapour barrier in accordance with AS 2870.1 that has the following qualities-
 - (A) ý Permeability not greater than 0.02 g/Ns.
 - (B) ý Durability:
 - (B1) Resistance to biological decay in accordance with AS 1157;
 - (B2) Resistance to termite attack in accordance with ASTM D 3345-74;
 - (C) ý Resistance to Damage:
 - (C1) Puncture resistance test to ASTM E154. Resistance should be no less than 200 N and 'stretch' no less than 43 mm;
 - (C2) Tear strength to ASTM D1922 with a minimum strength of 8 N in any direction;
 - (C3) Falling aggregate impact test to the CSIRO method with maximum permeance of 0.02 g/Ns after testing; or

PART F2 SANITARY AND OTHER FACILITIES

In Table F2.1 substitute the section dealing with Class 3 buildings with:

SA Table F2.1 PROVISION OF SANITARY AND OTHER FACILITIES IN RESIDENTIAL BUILDINGS

CLASS OF BUILDING	MINIMUM FACILITIES REQUIRED
Class 3	<p>Facilities for residents-</p> <p>For each building or group of buildings-</p> <p>(a) √ a bath or shower; and</p> <p>(b) √ a closet pan and washbasin,</p> <p>for each 8 residents for whom private facilities are not provided, except that-</p> <p>(c) √ if one urinal is provided for each 25 males up to 50 and one additional urinal for each additional 50 males or parts thereof, one closet pan for each 12 males may be provided.</p> <p>Facilities for employees - see F2.3.</p>

Note: These facilities need not be situated within the building.

Delete Table F2.3 and insert SA Table F2.3 as follows:

SA Table F2.3 √ SANITARY FACILITIES IN CLASS 3, 5, 6, 7, 8 AND 9 BUILDINGS

Class of Building	User	Max Number Served by-								
		Closet Fixture(s)			Urinal(s)			Washbasin(s)		
		1	2	Each Extra	1	2	Each Extra	1	2	Each Extra
3,5,6,7,8 and 9 other than schools	Employees									
	Males	15	35	20	25	50	25	15	30	15
	Females	15	30	15				15	30	15
6-Department stores, shopping centres	Patrons									
	Males	1200	2400	1200	600	1200	1200	600	1200	1200
	Females	300	600	1200				600	1200	1200
6-Restaurants cafes, bars, public halls, function rooms	Patrons									
	Males	100	300	200	50	100	*50	50	200	200
	Females	25	50	**50				50	150	200
		* Where the number of male patrons exceeds 250, not less than 5 urinals must be provided plus one additional urinal for each additional 100 males in excess of 250								
		** Where the number of female patrons exceeds 250, not less than 6 closet fixtures must be provided plus one additional closet fixture for each 100 females in excess of 250								
9a- Health-care buildings	Patients-									
	Males	-	16	8				8	16	8
	Females	-	16	8				8	16	8
		Other facilities: One bath or shower for each 8 patients or part thereof.								

SUPERCEDED

9b - <i>Schools not being early childhood centres</i>	Employees-										
	Males	15	35	20	25	50	25	15	30	15	
	Females	5	20	15				15	30	15	
	Students-										
	Males	30	70	70	30	70	35	20	40	40	
	Females	10	20	20				20	40	40	
9b- <i>Early childhood centres</i>	Children-	10	20	10				10	20	10	
9b- Sporting venues, theatres, cinemas, art galleries or the like	Participants										
	Males	20	40	20	10	20	10	10	20	10	
	Females	10	20	10				10	20	10	
	Other facilities: One shower for each 10, or part, participants.										
	Spectators ^ý or patrons ^ý										
	Males	250	500	500	100	200	100	150	300	150	
Females	75	150	75				150	300	150		
9b- Churches, ^ý chapels or the like ^ý	Patrons										
	Males	300	800	500	200	400	200	250	500	250	
	Females	150	300	150				250	500	250	

Notes:

- 1 **Urinals** - a urinal need not be provided where less than 10 males are employed.
- 2 **Unisex Facilities** - Instead of separate facilities for each sex, if not more than 6 persons are employed a unisex facility may be provided, comprising one closet pan, one washbasin, and means for disposal of sanitary towels.
- 3 In a building of more than one *storey* -
 - (a) ^ý where more than 50 persons are employed in a single *storey* ,sanitary facilities must be provided on that *storey*.
 - (b) sanitary facilities must not be more than 1 *storey* away from any work area.
- 4 **Use of public facilities** - Sanitary facilities for employees need not be separate from those required for public use in a Class 6 or 9b building other than a *school* or *early childhood centre*.
- 5 Sanitary facilities for the Public need not be provided in -
 - (a) ^ý a Class 6 building used as a department store or shopping centre if the building ^ý accommodates less than 600 persons; or ^ý
 - (b) ^ý a Class 6 building used as a restaurant, cafe, bar, public hall, function room or like building if the building accommodates less than 20 persons; or
 - (c) ^ý a Class 9b building used as a sporting venue, theatre, cinema, museum, art gallery or like building if the number of spectators or patrons accommodated is less than 100.
- 6 For females, adequate facilities for the disposal of sanitary napkins must be provided.
- 7 **Health Care Buildings** - in determining the numbers of facilities required, it is not necessary to include any person in a ward or bedroom which contains its own closet pan, washbasin and shower ensuite.

SA Table F2.4 SANITARY FACILITIES FOR PEOPLE WITH DISABILITIES

Table F2.4 is varied as follows:

- 1 by deleting the words "with a *floor area* more than 500 m² " that appear after the words "Class 5, 6, 7, 8 or 9 buildings"; and
- 2 by appending the following Note to the Table-

Note: The unisex water closet is recommended in areas used by the general public, eg. shopping centres, hotels, and the like where a disabled person may be accompanied by an attendant of the opposite sex. This type of toilet facility should be a public facility located so that access to it does not necessitate traversing an area reserved for one sex only.

After Table F2.4 insert SA F2.101 as follows:

SA F2.101 Locker and change rooms for employees

In a Class 6, 7, 8 or 9 building, the following facilities must be provided-

- (a) √ Where a change of clothing is not *required* as a consequence of employment, space for the installation of lockers at the rate of 0.4 m² per person (such space being either a locker room or within a common room or lunch room); or
- (b) √ Where a change of clothing is *required* as a consequence of employment, separate change rooms for each sex, being not less than 0.7 m² per person, and showers at the following rates-
 - (i) √ In a Class 8 building, one shower for every 10 or less persons; or
 - (ii) √ In a Class 6, 7 or 9 building, one shower for every 15 or less persons.

After F3.2 insert SA F3.101 as follows:

SA F3.101 Sizes of bathrooms and shower rooms

- (a) √ **Basic minimum requirements-** A bathroom or shower in any Class of building must have a *floor area* as follows:
 - (i) √ Bathroom - at least 2.2 m²;
 - (ii) √ Bathroom containing a bath and a shower that is not above the bath - at least 2.8 m²;
 - (iii) √ Shower room - at least 1.1 m²;
 but it is not necessary to increase the *floor area* of a bathroom or shower room to accommodate a washbasin.
- (b) √ **Additional facilities in residential buildings-** In a Class 1 or Class 4 building, or in a *sole-occupancy unit* in a Class 2 or 3 building, where a bathroom or shower room is designed to accommodate a closet pan or clothes washing facilities, the *floor areas* prescribed in (a) must be increased for each such facility as follows -
 - (i) √ closet pan - 0.7 m²;
 - (ii) √ washing machine and washtub - 1.1 m²;
- (c) √ **Health care buildings** - Notwithstanding (a), in a Class 9a building-
 - (i) √ a bathroom *required* to contain an island or peninsula type plunge bath must be not less than 3000 mm x 3000 mm in *floor area*; and

- (ii) ý a shower room in a nursing home must comply with clause 13.4 of AS 1428 and have a minimum *floor area* of 1500 mm x 2400 mm; or
 - (iii) ý At least one shower room per floor in a private hospital must comply with clause 13.4 of AS 1428 and have a minimum *floor area* of 1500 mm x 2400 mm.
- (d) ý **Multiple facilities in one room** - Where a bathroom or shower room contains multiple facilities intended to permit more than one person to use the area simultaneously, a bath or shower must be enclosed within a separate partitioned compartment not smaller than that *required* by (a), and be constructed in accordance with F2.5.

SA F3.102 Sizes of water closets

- (a) ý A water closet in any Class of building must have a width of at least 810 mm, and a *floor area* of-
- (i) ý at least 1.1 m² where it only contains a closet pan; or
 - (ii) ý at least 1.4 m² where it contains a closet pan and a washbasin.

After F4.2(d) insert SA F4.2(e) as follows:

SA F4.2 Methods and Extent of Natural Lighting

- (e) ý in a playroom of an *early childhood centre*, have an aggregate light transmitting area, measured excluding frames, glazing bars or other obstructions of not less than 12.5% of the *floor area* of the playroom.

After Part F5 add SA Part F6 as follows:

PART SA F6 ý RODENT PROTECTION

SA F6.101 Minimum separation between buildings

Every part of an *external wall* of a building must be no less than 600 mm from-

- (a) ý the *external wall* of any other building on the same *site*; or
- (b) any boundary of the *site*, unless that wall is on or abutting that boundary, unless the space between external columns is not infilled.

SECTION G ý ANCILLARY PROVISIONS

OBJECTIVES

Insert the following after the objective of Part G4:

SA PART G5 ý CONSTRUCTION FOR BUSHFIRE RISK AREAS

Class 1, 2 or 3 buildings must be constructed so as to reduce the risk of early ignition by embers from a bushfire.

SA PART G6 DANGEROUS SUBSTANCES STOREROOMS

Dangerous substance storerooms must be constructed so as to reduce the risk to life safety and property damage.

SA PART G7 ACCESS FOR MAINTENANCE

Where a building exceeds the reach of a normal ladder, provision must be made for safe access for minor maintenance and *window* cleaning.

SA PART G8 MISCELLANEOUS PROVISIONS

A collection of miscellaneous regulations basically associated with Health and Amenity that are not covered elsewhere.

Delete G1.1 and insert SA G1.1 as follows:

SA G1.1 Swimming pools and spas

- (a) *Drainage*: A *swimming pool* or spa must have suitable means of drainage.
- (b) *Safety Fencing*: A *swimming pool* or spa, unless enclosed within a building, must have suitable barriers or safety fencing in accordance with AS 2818 and AS 1926 to restrict access by young children to the immediate pool surrounds as described in clause 9.2.3 or 9.2.4 of AS 2818 on any residential *site*.
- (c) *Pump Intakes*: A *swimming pool* or spa must have all pump intakes of such dimensions or protected so as to prevent any part of a child being trapped by suction, and-
 - (i) there must be at least two intakes not less than 800 mm apart, and any intake, other than a skimmer box, must-
 - (A) feed below any skimmer basket; and
 - (B) have a permanently fixed protective cover through which water can flow that is designed so that it cannot be blocked with any part of a body; and
 - (ii) a primary intake that is a surface skimmer must comply with clause 13 of AS 2818; and
 - (iii) the cover of a surface skimmer must be lockable in the closed position to exclude children.
- (d) *Spas*: In addition to the above requirements, a spa must-
 - (i) be assembled and installed so that the user is not exposed to any toxic material under normal conditions of use; and
 - (ii) have a maximum depth of water not exceeding 1100 mm, and a maximum depth of water above any seat not exceeding 600 mm, measured from the midpoint of the operating range of the skimmer, or the top of the overflow rim if there is no skimmer; and
 - (iii) be finished in such a manner that no part constitutes an abrasion or entanglement hazard to the user, and every horizontal surface is slip resistant.

Insert SA Part G5 after Part G4 as follows:

SA PART G5 ý CONSTRUCTION FOR BUSHFIRE RISK AREAS

SA G5.101 Buildings in bushfire risk areas

(a) ý A Class 1, 2 or 3 building in a bushfire risk area must comply with the following minimum standards to reduce the risk of early ignition by embers in the event of a bushfire-

- (i) ý the floor and *underfloor area* must be constructed so as to avoid ignition of the floor or floor supports by the impingement of flame, or the entry or lodgement of sparks and embers;
- (ii) ý all *external walls* must be designed and constructed so as to prevent the entry of sparks or embers, and must not incorporate any siding, cladding or glazing of PVC or similar thermoplastic material;
- (iii) ý all external *windows*, doors, apertures and vents must be designed and protected so as to prevent the entry of sparks and embers;
- (iv) ý the roof covering and roof space must be protected from ignition and the entry of sparks and embers;
- (v) ý every post or column supporting the building, or a verandah, carport, deck or similar structure forming part of, or attached to, the building, must be protected against ignition by ember build-up against that post or column; and
- (vi) ý all external pipework for mains water and gas services must be protected against damage by fire.

(b) ý compliance with Minister's Specification SA G5.101 is deemed-to-satisfy (a).

SA PART G6 ý DANGEROUS SUBSTANCES STOREROOMS

SA G6.101 Flammable liquids storerooms

A room intended to be used for storing flammable liquids must be sited, constructed and ventilated in such a way that there is no risk to the life or safety of the occupants of the building or structure in which the room is to be situated, or to the public generally.

SA G6.102 No storerooms in Class 1, 2, 3, 4, 5 and 9 buildings

A room in a Class 1, 2, 3, 4, 5 or 9 building must not be constructed as a storeroom for flammable liquids.

SA G6.103 Storerooms in Class 6,7 and 8 buildings

A room to be constructed in a Class 6, 7 or 8 building as a storeroom for flammable liquids must be sited, constructed and ventilated in accordance with AS 1940.

SA G6.104 Self-contained and isolated storerooms

A self-contained and isolated room intended to be used as a storeroom for flammable liquids must be sited, isolated, constructed and ventilated in accordance with AS 1940.

SA G6.105 ý Storerooms for class 6 and class 8 dangerous substances

A design for a room intended to be used as a storeroom for *class 6 substances* or *class 8 substances* must be referred to the Department of Labour for an opinion as to its suitability for the proposed use. A written opinion on its suitability must accompany the application for *approval* under the Act.

SA G6.106 ý Interpretation

For the purposes of this Part -

Class 6 substance means a class 6 substance within the meaning of the *Code*;

Class 8 substance means a class 8 substance within the meaning of the *Code*;

flammable liquid means a class 3 substance within the meaning of the *Code*; and

Code means the *Australian Code for the Transport of Dangerous Goods by Road and Rail*, published in the Commonwealth of Australia Gazette No.P8, 9 April, 1984.

SA PART G7 ACCESS FOR MAINTENANCE

SA G7.101 ý Application of the Part

Where any part of a *window* in a building other than a Class 1 or 10 building is more than 5.5 m above ground level, provision must be made for safe access to the external surface of the *window* for minor maintenance and cleaning.

SA G7.102 ý Provision of access deemed to satisfy

The requirements of SA G7.101 are satisfied if access is provided by any of the following methods-

- (a) ý by means of a movable gantry; or
- (b) ý by means of reversible pivoting sashes each of which has catches that secure the sash in either the normal or reversed position and give visual indication that the *window* is secure, provided that where a *window* sill is less than 900 mm above floor level, safety anchorages are provided; or
- (c) ý by means of safety harness, having all anchorages -
 - (i) ý designed and installed in accordance with AS 2626; and
 - (ii) ý constructed of *approved* corrosion resistant metal; or
- (d) ý by means of opening sashes, in which case the maximum reach to the farthest part of the *window* must not exceed 500 mm upwards or 1 m sideways or downwards and provided that where the *window* sill is less than 900 mm above floor level, safety anchorages are provided; or
- (e) ý by means of ledges, sunhoods or balconies-
 - (i) ý that have a width of not less than 500 mm, a cross fall not greater than 1 in 12 and a handrail that conforms to AS 1657; or
 - (ii) ý that are equipped with safety anchorages; or
- (f) ý by other means *approved* by the Department of Labour.

SA PART G8 MISCELLANEOUS PROVISIONS

SA G8.101 ý Application of Part

The following miscellaneous provisions apply to all classes of buildings.

SA G8.102 Buildings containing stables, manure pits or pigsties

A building that is a stable or a pigsty, or contains a manure pit, must-

- (a) ŷ have a floor that is constructed of a suitable impervious material and is drained; and
- (b) ŷ have impervious walls, unless the Council approves otherwise; and
- (c) ŷ in the case of a manure pit, be fitted with suitable covers.

SA G8.103 Protection against lightning

A building that exceeds 10 m height must be assessed for vulnerability to lightning strike in accordance with clause 2.5 of AS 1768, and if that building accumulates a Risk Index greater than 12 in that assessment, it must be protected in accordance with AS 1768.

SA G8.104 Attachments to buildings

- (a) ŷ An attachment to a building that is in the nature of a balcony or awning, bridge, gangway, hoarding or trade sign, sky sign, mast, flagpole, tower, aerial or antenna, lantern, cathead, crane, chimney, flue or duct, or an installation for cleaning and maintenance access must-
 - (i) ŷ have all metal parts of corrosion resistant metal, or other metal suitably protected;
 - (ii) ŷ not overhang any street boundary at a height less than 2.5 m above the footpath, or 4 m above the roadway; and
 - (iii) ŷ be provided with drainage to prevent rain water or condensate falling onto or running across the footpath.
- (b) ŷ A balcony or awning that overhangs a street boundary-
 - (i) ŷ must not extend closer than 450 mm to the kerb of the roadway; and,
 - (ii) ŷ must be constructed of *non-combustible* materials throughout, except that timber battens may be used to support the soffit lining.

SA G8.105 Operating theatres

An operating theatre and any room ancillary to the operating theatre must-

- (a) ŷ comply with the provisions of AS 1169;
- (b) ŷ have a floor and walls impervious to a height of 1800 mm above the floor; and
- (c) ŷ where used for operations on humans, have finishes complying with the requirements of the Health Commission.

SA G8.106 Detached incinerators

A detached incinerator must be situated so that no part of that incinerator is less than 2 m from any boundary of the *site*, and every other building or structure on the *site*, or such greater distance as may be *required* in any area under the *Country Fires Act 1989*.

SA G8.107 Access for vehicles used in fire fighting

- (a) ŷ A Class 2, 3, 5, 6, 7, 8 or 9 building must have at least one *exit* accessible for vehicles used in fire fighting.
- (b) ŷ An *exit* is accessible for the purposes of (a) if it is no more than 8 m from-
 - (i) ŷ a street boundary; or
 - (ii) ŷ a space on the *site* that is accessible from a street, unobstructed except for a gate, and is not more than 20 m from a hydrant on the *site*.

SA G8.108 Kitchen exhaust hoods

- (a) ý Kitchen exhaust hoods and exhaust ducts must be provided in a kitchen of a commercial kind in a Class 3, 5, 6, 7, 8 or 9 building to remove steam and fumes from all stoves, ovens, fryers and other like cooking appliances.
- (b) ý A kitchen exhaust hood and exhaust duct complies with (a) if it is constructed in accordance with AS 1668 and the metal used is not less than-
 - (i) ý 1.2 mm thick if of carbon steel; or
 - (ii) 0.9 mm thick if of stainless steel.

INTRODUCTION

The Tasmania BCA Appendix includes variations from the requirements of the July 1990 edition of the Building Code of Australia (BCA) and additional requirements resulting from the consolidation in Tasmania of all building-related regulations into the BCA.

The variations from the requirements of the BCA apply to the construction or alteration of all buildings in Tasmania and the extra requirements apply to all workplaces and special-use buildings.

CONTENTS

This Appendix contains the BCA provisions that have been varied and additional provisions for application in Tasmania, as follows:

A - GENERAL PROVISIONS

Tas A3.2	Classifications
Tas Specification A1.3	Standards Adopted by Reference

B - STRUCTURE

Tas B1.3	Construction deemed-to-satisfy
----------	--------------------------------

C - FIRE RESISTANCE

Tas C1.9	Class 1 and 10 buildings
Tas C1.101	Non-combustible roofing
Tas Specification C1.9	Fire-resistance of Class 1 and 10 Buildings.

D - ACCESS AND EGRESS

Tas Table D1.13	Area per person according to use
Tas D2.21	Operation of latch

E - SERVICES AND EQUIPMENT

Tas E1.5	Sprinklers
Tas E1.6	Portable fire extinguishers
Tas E1.7	Fire and smoke alarms

Tas Part E5 Maintenance of Safety Installations

F - HEALTH AND AMENITY

Tas F1.5	Roof covering deemed-to-satisfy
Tas F2.101	Urinals
Tas F2.102	Buildings containing earth closets
Tas F2.103	Slop-hoppers
Tas F4.10	Sub-floor ventilation

SUPERCEDED

Tas F4.101 Fixed natural ventilation

G - ANCILLARY PROVISIONS

Tas G1.1 Swimming pools

Tas G1.2 Refrigerated chambers, strong rooms and vaults

Tas G4.3 External doorways

Tas G4.9 Fire Orders

Tas Part G101 PROJECTIONS OVER WAYS

Tas G101.1 Construction and location of projections over ways

Tas G101.2 Protection of ways

H - SPECIAL USE BUILDINGS ^ý

Tas H1.101 Movable seating

Tas Part H101 WORKPLACES

Tas H101.1 Application of Part

Tas H101.2 Floor area

Tas H101.3 Floor surfaces

Tas H101.4 Floor drainage

Tas H101.5 Floor covering

Tas H101.6 Overhead clearance

Tas H101.7 Lighting

Tas H101.8 Ventilation

Tas H101.9 Toilet facilities

Tas H101.10 Hand washing facilities

Tas H101.11 Shower facilities

Tas H101.12 Change rooms

Tas H101.13 Dining rooms

Tas H101.14 Rest rooms

Tas H101.15 First aid and health

Tas Part H102 FOOD PREMISES

Tas H102.1 Application of Part

Tas H102.2 Definitions

Tas H102.3 Floors, walls and ceilings

Tas H102.4 Food store

Tas H102.5 Pests and contaminants

Tas H102.6 Washbasins

Tas H102.7 Glass washing apparatus

Tas H102.8 Sinks

Tas H102.9 Installation of equipment and fittings

Tas H102.10 Drains

Tas H102.11 Concealment of pipes

Tas H102.12 Storage of materials and equipment

SUPERCEDED

SUPERCEDED

Tas H102.13	Separation of work place
Tas H102.14	Offensive material and trade waste
Tas H102.15	Mechanical ventilation of kitchens
Tas H102.16	Dairy produce

Tas Part H103 DINING ROOMS AND BAR ROOMS

Tas H103.1	Application of Part
Tas H103.2	Number of persons accommodated
Tas H103.3	Access
Tas H103.4	Sanitary facilities
Tas H103.5	Insect proofing
Tas H103.6	Separation from other areas

Tas Part H104 BOTTLE SHOPS AT LICENSED PREMISES

Tas H104.1	Application of part
Tas H104.2	Drive-in bottle shops

Tas Part H105 ACCOMMODATION FACILITIES

Tas H105.1	Application of part
Tas H105.2	Definitions
Tas H105.3	Floor area of bedrooms
Tas H105.4	Eating areas
Tas H105.5	Cooking areas
Tas H105.6	Sanitary facilities in suites and flats
Tas H105.7	Sanitary facilities in individual caravan sites
Tas H105.8	Communal sanitary facilities
Tas H105.9	Laundry facilities
Tas H105.10	Floors of sanitary and laundry facilities
Tas H105.11	Insect proofing
Tas H105.12	Doors on accommodation facilities

Tas Part H106 MEAT PREMISES

Tas H106.1	Application of Part
Tas H106.2	Australian Code of Practice for Construction and Equipment of Abattoirs
Tas H106.3	Walls
Tas H106.4	Ceilings
Tas H106.5	Floors
Tas H106.6	Kerbs
Tas H106.7	Lighting
Tas H106.8	Sanitary facilities
Tas H106.9	Ventilation
Tas H106.10	Doors
Tas H106.11	Windows
Tas H106.12	Rodent and vermin proofing
Tas H106.13	Drainage

SUPERCEDED

SUPERCEDED

Tas H106.14	Rendering facilities
Tas H106.15	Hanging room
Tas H106.16	By-products processing areas
Tas H106.17	Storage of waste offal
Tas H106.18	Storage of hides and skins
Tas H106.19	Boning rooms
Tas H106.20	Amenities for employees
Tas H106.21	Amenities for inspectors
Tas H106.22	Store rooms
Tas H106.23	Chillers and freezers

Tas Part H107 DAIRIES

Tas H107.1	Application of Part
Tas H107.2	General
Tas H107.3	Size of dairy house
Tas H107.4	Walls
Tas H107.5	Floors
Tas H107.6	Ceilings
Tas H107.7	Passageway between milking shed and dairy house
Tas H107.8	Entry doors to dairy house
Tas H107.9	Ventilation
Tas H107.10	Insect proofing
Tas H107.11	Drains

Tas Part H108 PHARMACIES

Tas H108.1	Application of Part
Tas H108.2	Definition
Tas H108.3	Pharmacy premises
Tas H108.4	Dispensary
Tas H108.5	Security of dispensary

Tas Part H109 HOSPITALS AND NURSING HOMES

Tas H109.1	Application of Part
Tas H109.2	Floor area of wards
Tas H109.3	Floors and walls
Tas H109.4	Grab rails
Tas H109.5	Insect proofing
Tas H109.6	Water temperature

Tas Part H110 PREMISES USED FOR ACTIVITIES INVOLVING SKIN PENETRATION

Tas H110.1	Application of Part
Tas H110.2	Sanitary facilities
Tas H110.3	Washbasins

SUPERCEDED

Tas Part H111 DENTAL SURGERIES AND CHIROPRACTORS' PREMISES

- Tas H111.1 Application of Part
- Tas H111.2 Waiting room
- Tas H111.3 Floor, walls and ceiling

Tas Part H112 MORTUARIES

- Tas H112.1 Application of Part
- Tas H112.2 Layout of mortuary
- Tas H112.3 Construction of body preparation room
- Tas H112.4 Water supply and sewerage

Tas Part H113 FOUNDRIES

- Tas H113.1 Application of Part
- Tas H113.2 General
- Tas H113.3 Cupola charging platform
- Tas H113.4 Deep moulds and pits
- Tas H113.5 Pot furnaces

Tas Part H114 PREMISES FOR MANUFACTURING OR PROCESSING OF GLASS REINFORCED PLASTICS

- Tas H114.1 Application of Part
- Tas H114.2 Separation from other buildings
- Tas H114.3 Rise in storeys
- Tas H114.4 Maximum floor areas
- Tas H114.5 Required exits
- Tas H114.6 Hand laminating and spray depositing
- Tas H114.7 Ventilation
- Tas H114.8 Smoke and heat roof vents

Tas Part H115 PREMISES FOR PRODUCTION OR PROCESSING OF ISOCYANATES

- Tas H115.1 Application
- Tas H115.2 Areas of workplaces
- Tas H115.3 Separation from other areas and buildings
- Tas H115.4 Rise in storeys
- Tas H115.5 Maximum floor areas
- Tas H115.6 Required exits
- Tas H115.7 Bulk store for polyols and isocyanates
- Tas H115.8 Curing rooms

Tas Part H116 PREMISES FOR ELECTRO-PLATING, ELECTRO-POLISHING, ANODISING OR ETCHING

- Tas H116.1 Application of Part
- Tas H116.2 Floors
- Tas H116.3 Height of plating area
- Tas H116.4 Air space

SUPERCEDED

Tas H116.5 Ceiling construction

Tas Part H117 PREMISES FOR LEAD PROCESSING

Tas H117.1 Application of Part

Tas H117.2 Floors

Tas H117.3 Height of lead processing areas

Tas H117.4 Air space and floor space

Tas H117.5 Interior of lead processing areas

Tas H117.6 Dust collection

Tas H117.7 Isolation of certain processes

Tas H117.8 Drying room shelves

Tas H117.9 Washing facilities

Tas H117.10 Change rooms

Tas Part H118 BOOTHS FOR SPRAY PAINTING OR SPRAY COATING

Tas H118.1 Application of Part

Tas H118.2 Structure of booths

Tas H118.3 Emergency exits

Tas H118.4 Doors

Tas H118.5 Exhaust systems

Tas H118.6 Ducts or flues of spray-bake booths

Tas Part H119 ELECTRICITY DISTRIBUTION SUBSTATIONS

Tas H119.1 Application

Tas H119.2 Building-type substations

Tas Part H120 PREMISES FOR MANUFACTURE OR STORAGE OF DANGEROUS GOODS

Tas H120.1 Application of Part

Tas H120.2 Interpretation

Tas H120.3 Class of dangerous goods

Tas H120.4 Premises for storage of dangerous goods

Tas H120.5 Workrooms

Tas H120.6 Automatic sprinkler systems

Tas Part H121 HAIRDRESSER'S PREMISES

Tas H121.1 Application of Part

Tas H121.2 Size of operating section

Tas H121.3 Premises in a residence

Tas H121.4 Sanitary facilities

Tas H121.5 Lighting

SUPERCEDED

SECTION A GENERAL PROVISIONS ý

PART A3 ý CLASSIFICATION OF BUILDINGS AND STRUCTURES

Tas A3.2 Classifications

Replace the classification for Class 3 as follows:

Class 3: a residential building, other than a building of Class 1 or 2, which is a common place of living for a number of unrelated persons, including-

- (a) ý a boarding-house, guest house, hostel, or lodging-house;
- (b) ý a residential part of an hotel or motel;
- (c) ý a residential part of a *school*;
- (d) ý accommodation for the aged, disabled or children;
- (e) ý a residential part of a *health-care building* which accommodates members of staff; and
- (f) ý a building for which an accommodation licence is *required* under the *Licensing Act 1976*.

TAS SPECIFICATION A1.3 ý STANDARDS ADOPTED BY REFERENCE

Insert in Table 1 the following:

AS 1596-1983	The storage and handling of liquefied petroleum gases.	Tas H120.4
AS 1680-1976	Code of practice for interior lighting and the visual environment.	Tas H101.6
AS 1940-1988	The storage and handling of flammable and combustible liquids.	Tas H120.4
AS 2022-1983	Anhydrous ammonia- storage and handling.	Tas H120.4
AS 2187	Explosives- storage, transport and use.	
Part 1-1984	Storage and land transport.	Tas H120.4
AS 2430	Classification of hazardous areas	Tas H120.5
Part 1-1987	Explosive gas atmospheres.	
Part 2-1986	Combustible dusts.	
Part 3-1987	Specific occupancies.	
AS 2507-1984	The storage and handling of pesticides.	Tas H120.4
AS 2714-1984	The storage and handling of hazardous chemical materials - Class 5.2 substance - Organic peroxides.	Tas H120.4
AS 2927-1987	The storage and handling of liquefied chlorine gas.	Tas H120.4
ASTM D3018-79a	Class A asphalt shingles surfaced with mineral granules.	Tas B1.3, Tas F1.5
Australian Code of Practice for Construction and Equipment of Abattoirs, 1986		Tas H106.2
Australian Code of Practice for Dairy Factories, 1986		Tas H102.16
Minister for Health: Rules and Specifications for Mechanical Ventilation of Kitchens, No 1 of 1976		Tas H102.15
HEC Substation Design and Construction Manual		Tas H119.1, Tas H119.2

SECTION B STRUCTURE

PART B1 STRUCTURAL PROVISIONS

Tas B1.3 Construction deemed-to-satisfy

After B1.3(k)(v) insert (vi) as follows:

- (vi) ý Asphalt shingles: ASTM D3018-79a, Type A.

SECTION C FIRE RESISTANCE

PART C1 FIRE RESISTANCE AND STABILITY

After C1.10 insert Tas C1.101 as follows:

Tas C1.101 Non-combustible roofing

- (a) ý Except as set out in (b) and (c), the roofs of all Class 2, 3, 4, 5, 6, 7, 8 and 9 buildings must be covered with-
 - (i) ý metal sheeting or tiles;
 - (ii) ý slates;
 - (iii) ý terracotta or cement roofing tiles;
 - (iv) ý cement fibre sheeting or shingles;
 - (v) ý asphalt shingles except on buildings with a *rise in storeys* exceeding 2;
 - (vi) ý built-up roofing covered with *non-combustible* material; or
 - (vii) ý concrete, granolithic, terrazzo, cement mortar, or other similar *non-combustible* materials.
- (b) ý Subject to B1.1, PVC and GRP sheeting may be used as a roof covering or roof light if the plastic sheeting is not within 1.5 m of any dividing wall or party wall, or does not extend to any *external wall* which is within 1.5 m of an allotment boundary unless the wall is carried up to form a parapet extending above the highest part of the roof immediately behind it to a height of at least 450 mm; and-
 - (i) ý the area of roof covered by plastic sheeting does not exceed 15% of the total area of the roof; or
 - (ii) ý the plastic sheeting forms the roof or canopy over a balcony, *verandah*, car port, covered way, *swimming pool*, barbecue area or similar open structure which is attached to a Class 2, 3, 4, 5, 6, 7, 8 or 9 building with *rise in storeys* not exceeding 3.
- (c) ý The roof of a farm building may be covered with a *combustible* material if it complies with Specification C1.9, clauses Tas 101(c) and (d), for Classes 1 and 10 buildings.

TAS SPECIFICATION C1.9 $\dot{\gamma}$ FIRE-RESISTANCE OF CLASS 1 AND 10 BUILDINGS

After clause 9 insert clause Tas 101 as follows:

Tas 101 Roofing

- (a) $\dot{\gamma}$ Except as set out in (b) and (c), the roofs of all Class 1 and 10 buildings must be covered with-
- (i) $\dot{\gamma}$ metal sheeting or tiles;
 - (ii) $\dot{\gamma}$ slates;
 - (iii) $\dot{\gamma}$ terracotta or cement roofing tiles;
 - (iv) $\dot{\gamma}$ cement fibre sheeting or shingles;
 - (v) $\dot{\gamma}$ asphalt shingles except on buildings with *rise in storeys* exceeding 2;
 - (vi) $\dot{\gamma}$ built-up roofing covered with *non-combustible* material; or
 - (vii) $\dot{\gamma}$ concrete, granolithic, terrazzo, cement mortar, or other similar *non-combustible* materials.
- (b) $\dot{\gamma}$ Subject to B1.1, PVC and GRP sheeting may be used as a roof covering or roof light if the plastic sheeting is not within 1 m of any dividing wall or party wall, or does not extend to any *external wall* which is within 1 m of an allotment boundary, unless the wall is carried up to form a parapet extending above the highest part of the roof immediately behind it to a height of at least 450 mm; and-
- (i) $\dot{\gamma}$ the roof covering or roof light is over a garage, workshop or conservatory which is part of or appurtenant to a Class 1 building, and the area covered by the plastic sheeting does not exceed 40 m²; or
 - (ii) $\dot{\gamma}$ the sheeting is a roof or canopy over a balcony, *verandah*, carport, covered way, *swimming pool*, barbecue area, or similar open structure, which is attached to a Class 1 or 10 building.
- (c) $\dot{\gamma}$ On any land zoned Rural (except Rural Residential) in the Municipality's or City's sealed Planning Scheme or Effective Interim Order, if a Class 1 or 10 building or a farm building is situated at a distance not less than shown in Tas Table 101, the roof of that building may be covered with a *combustible* material.

Tas TABLE 101 LOCATIONS OF BUILDINGS THAT MAY HAVE COMBUSTIBLE ROOFS

Building	Minimum Distance (m) from-		
	Wooden Building	Other Building	Allotment Boundary
Class 1 or 10	30	15 $\dot{\gamma}$	30
Farm Building	15	8 $\dot{\gamma}$	15

- (d) $\dot{\gamma}$ Where in accordance with (c) a roof is covered with wood shingles or shakes over a *combustible* roof or ceiling, the shingles or shakes must be underlaid with a material having a *Flammability Index* not greater than 2.

SECTION D ACCESS AND EGRESS

PART D1 PROVISION FOR ESCAPE

In Table D1.13, delete references to-

Bar, cafe, church, dining room	1
Kitchen, laboratory, laundry	10

and insert references as follows:

Tas TABLE D1.13 AREA PER PERSON ACCORDING TO USE	
TYPE OF USE ý	m ² per person
Bar room	0.5
Cafe, church, dining room	1
Kitchen, bar service area, food service area	10
Laboratory, laundry	10

PART D2 CONSTRUCTION OF EXITS

Delete D2.21 and insert Tas D2.21 as follows:

Tas D2.21 Operation of latch

Except in the case of a door which is within or serves only-

- (a) ý a *sole-occupancy unit* in a Class 2 or 3 building or a Class 4 part;
- (b) ý a *sole-occupancy unit* in a Class 5, 6, 7 or 8 building with a *floor area* not more than 200 m²;
- (c) ý a space which is otherwise inaccessible to persons at all times when the door is locked; or
- (d) ý a vault, strongroom, *sanitary compartment*, or the like, the latch or fastening device on any door which is in a *required exit*, forms part of a *required exit* or is in a path of travel to a *required exit* must comply with Tas Specification D2.21.

TAS SPECIFICATION D2.21 OPERATION OF LATCH

1. ý Scope

This Specification contains-

- (a) ý details of the types of fastening devices suitable for use on a door in a *required exit*, forming part of a *required exit* or in the path of travel to a *required exit*; and
- (b) ý the method of use of those fastening devices.

2. ý Latches or fastening devices

Latches or fastening devices must be of Type A, Type B or Type C, and must be readily operable without a key from the side that faces a person seeking egress, as follows:

- (a) ý A Type A fastening device must be fitted to the face of a door at a height not less than 900 mm and not more than 1.2 m above the floor, and must enable the door to be opened by a single hand thrust on a horizontal bar.
- (b) ý A Type B fastening device must have either a lever handle or a striking plate and must be fixed to a door at a height not less than 900 mm and not more than 1.2 m

SUPERCEDED

above the floor, to enable the door to be opened with a single-handed downward action on the lever or horizontal push on the plate.

- (c) \dot{y} For a door serving an occupancy for which special arrangements for security are necessary, unless the door can be unlocked by hand as *required* by clause 3, a Type C fastening device must be fitted incorporating-
- (i) \dot{y} a fail-safe electric device by which the door may be unlocked by manual operation of a lever-type or toggle-type electric control switch located at a height of not less than 900 mm and not more than 1.2 m above the floor, and not housed in a protective enclosure; or
 - (ii) \dot{y} a fail-safe electric device for *automatic* operation immediately on activation of any *automatic* fire *sprinkler system* or *automatic* detection and alarm system installed in the building.

3. \dot{y} Exemption

A fastening for a door serving an occupancy for which special arrangements for security are necessary, need not comply with the requirements of clause 2 if the door and any other door, shutter or grille in the path of travel, can be immediately unlocked by hand by a person or persons, specifically selected by the owner, properly instructed as to the duties and responsibilities involved and available at all times when the building is lawfully occupied so that persons in the building or part may escape if there is a fire or other emergency.

4. \dot{y} Fittings

A door handle or other fitting to be used on Type A, Type B or Type C fastening devices must be made and fitted in such a way that, when installed and in use, it will not catch the clothing or person of anybody seeking egress through the door.

5. \dot{y} Accredited fastening devices

Any latch or door fastening device which is included in the list published in the Tasmanian Government Gazette of accredited fastenings for doors in *required exits* complies with this Specification and only those latches or fastening devices may be used on a door in a *required exit*, forming part of a *required exit* or in the path of travel to a *required exit*.

SECTION E SERVICES AND EQUIPMENT

OBJECTIVES

Delete Objectives for Part E5:

TAS PART E5 MAINTENANCE

(deleted).

PART E1 FIRE FIGHTING EQUIPMENT

Delete Table E1.5 and insert Tas Table E1.5 as follows:

Tas TABLE E1.5 REQUIREMENTS FOR SPRINKLERS

OCCUPANCY \dot{y}	WHEN SPRINKLERS ARE REQUIRED ^(b)
Occupancies of excessive hazard ^(a)	in <i>fire compartments</i> with- (a) a <i>floor area</i> of more than 2000 m ² ; or

SUPERCEDED

SUPERCEDED

	(b) a volume more than 10 000 m ³ .
Class 6 ý	in <i>fire compartments</i> with- (a) ý a <i>floor area</i> of more than 3500 m ² ; or (b) ý a volume more than 21 000 m ³ .
Atrium construction ý	see Part G3.
Theatres, stages and public halls	see Part H1.
All Classes except <i>open-deck carparks</i>	in buildings more than 25 m in <i>effective height</i> .
Carparks, other than <i>open-deck carparks</i>	(a) if accommodating more than 19 vehicles; (b) ý if incorporating structural steel members with an FRL less than 60/ -/ - ; or (c) ý if more than 6 m below the level of the ground.
Note:	(a) Occupancies of excessive fire hazard are- (i) Ordinary Hazard Group III Special. (ii) ý Extra High Hazard, Categories I, II, III and IV, as specified in AS 2118, Section 2. (b) ý See C2.3 for requirements for sprinklers in large isolated buildings.

Delete E1.6:

Tas E1.6 Portable fire extinguishers

(deleted).

Delete E1.7 and insert Tas E1.7 as follows:

Tas E1.7 Fire and smoke alarms

A suitable *automatic* fire and smoke alarm system complying with Specification E1.7 must be installed in-

- (a) ý a building exceeding 14 m in height measured from the ground floor, except a Class 2 building that-
 - (i) ý is under 18 m in height so measured, or
 - (ii) ý has a *floor area* of not more than 465 m²;
- (b) ý a Class 3 building which-
 - (i) ý is used as a special accommodation house, home for the aged, children or people with disabilities which is more than one *storey* or which accommodates more than 12 residents; or
 - (ii) ý is the residential part of a *school*;
- (c) ý a Class 5 building or Class 6 building having an aggregate *floor area* of more than 1000 m²;
- (d) ý a Class 6 building in which-
 - (i) ý furniture is sold; and
 - (ii) ý the parts used for the storage, display, and sale of furniture have an aggregate *floor area* of more than 550 m²;
- (e) ý a Class 7 building having a *floor area* of more than 550 m² in which furniture is stored;
- (f) ý a Class 8 building in which a hazardous process, as defined in the *General Fire Regulations 1975* is used and in which more than 25 persons are employed;
- (g) ý a Class 9a building;
- (h) ý a Class 9b building which is a *school* or *early childhood centre* or a creche which-
 - (i) ý is of more than 1 *storey*, or

SUPERCEDED

SUPERCEDED

- (ii) ý has a *storey* with a *floor area* more than 390 m²; and
- (i) ý a Class 9b building which is a regular theatre.

Delete Part E5:

TAS PART E5 MAINTENANCE

(Deleted).

SECTION F HEALTH AND AMENITY

PART F1 DAMP AND WEATHERPROOFING

Insert Tas F1.5(f) as follows:

Tas F1.5 Roof covering deemed-to-satisfy

(f) ý asphalt shingles that comply with ASTM D3018-79a, Type A.

PART F2 SANITARY FACILITIES

After F2.6 insert Tas F2.101 as follows:

Tas F2.101 Urinals

(a) ý Slab and stall type urinals

- (i) ý The floor in front of a slab or stall type urinal must be surfaced with suitable impervious material for a width of not less than 1.5 m and must be graded to the urinal channel and the remainder of the floor must be of the same or other impervious material graded to drain to a trapped outlet.
- (ii) ý A step may be installed in front of a slab or stall type urinal where structural or other constraints make such installation necessary.
- (iii) ý Where a step is installed it must be surfaced with suitable impervious material and must be graded to the urinal channel and the remainder of the floor must be of the same or other suitable material graded to drain to a trapped outlet.
- (iv) ý The surfacing referred to in (i) must be of sufficient thickness to cover the channel edge of the urinal by not less than 25 mm.

(b) ý Wall-hung urinals

- (i) ý A wall to which a wall-hung urinal is fixed must be surfaced with impervious material extending from the floor to 50 mm above the top of the urinal and at least 225 mm on each side of the urinals.
- (ii) ý The floor in a room in which a wall-hung urinal is installed must be surfaced with impervious material extending at least 400 mm beyond the front of the urinal and at least 225 mm on each side of the urinal and graded to drain over impervious material to a trapped outlet.

(c) ý **Framed buildings** - A room containing a urinal, if it has timber or steel framed walls must have the impervious flooring continued up the walls to a height of not less than 100 mm.

(d) ý **Provision for hosing down** - A tap for hosing down purposes must be provided in every urinal compartment.

SUPERCEDED

SUPERCEDED

- (e) $\dot{\gamma}$ **Non-flushed urinals** - Urinals not flushed with water are subject to the same rules as earth closets.

After Tas F2.101 insert Tas F2.102 as follows:

Tas F2.102 Buildings containing earth closets

- (a) $\dot{\gamma}$ For the purposes of this regulation, "earth closet" includes-
- (i) $\dot{\gamma}$ a deep pit;
 - (ii) $\dot{\gamma}$ an incinerating latrine;
 - (iii) $\dot{\gamma}$ a chemical closet; and
 - (iv) $\dot{\gamma}$ a humus closet.
- (b) $\dot{\gamma}$ Earth closets must be in a building not containing *habitable rooms* or used for the manufacture or storage of food and must be separated from any other part of the building by walls, floors, and ceilings impervious to moisture.
- (c) $\dot{\gamma}$ An earth closet must not be within 1.8 m of a building containing an *habitable room*.
- (d) $\dot{\gamma}$ Where there is a removable pan the floor where the pan stands for an area at least twice that of the base of the cabinet must be covered with smooth concrete or other impervious material.
- (e) $\dot{\gamma}$ In addition to complying with this section earth closets must comply as far as practicable with all requirements for water closets.

After Tas F2.102 insert Tas F2.103 as follows:

Tas F2.103 Slop-hoppers

Not less than one slop-hopper must be provided on any *storey* of a Class 9a building containing wards or bedrooms.

PART F4 LIGHT & VENTILATION

Delete F4.10 and insert Tas F4.10 as follows:

Tas F4.10 Sub-floor ventilation

- (a) $\dot{\gamma}$ Suitable provisions for sub-floor ventilation and cross-ventilation must be made if the lowest floor of a building is of timber construction.
- (b) $\dot{\gamma}$ The requirements of (a) are satisfied if-
- (i) $\dot{\gamma}$ a space not less than 200 mm high, between the ground and the underside of the lowest floor member, is provided;
 - (ii) $\dot{\gamma}$ vents, formed by air-bricks, gratings or open purpends not wider than 10 mm, and having a total area not less than 1/700 of the *floor area* enclosed by the exterior foundation walls, are fixed in the exterior walls;
 - (iii) $\dot{\gamma}$ openings having a total area of 1/350 of *floor area* enclosed by interior foundation walls, are located in interior walls; and
 - (iv) $\dot{\gamma}$ vents or openings in exterior and interior foundation walls are placed below the damp-proof course and distributed to prevent pockets of dead air where possible.
- (c) $\dot{\gamma}$ The space and areas of vent opening *required* in (b) may be reduced if-
- (i) $\dot{\gamma}$ an impervious cover is provided over the ground surface beneath the building;
or
 - (ii) $\dot{\gamma}$ the floor timbers are suitably treated.

SUPERCEDED

SUPERCEDED

After F4.11 insert Tas F4.101 as follows:

Tas F4.101 Fixed natural ventilation

(a) $\dot{\gamma}$ Except if mechanical ventilation or air-conditioning is provided, in rooms and areas listed in Tas Table F4.101, a fixed opening, of aggregate size not less than that shown in the Table, must be provided in addition to any adjustable opening.

TABLE F4.101 FIXED NATURAL VENTILATION

Building Class	Room to be ventilated	Size of fixed opening/floor area
2, 3 and 4	(i) Common stairways	1/500
	(ii) Communal laundries	1/500
7	(i) Rooms for storage of polluting or noxious substances	1/350
8	All rooms	1/500*
9a	Store rooms	1/500
9b	(i) Assembly halls in <i>schools</i>	1/250
	(ii) Workshops in <i>schools</i>	1/250
Other than Class 1 or Class 10	(i) Pantries for food preparation rooms	1/500
	(ii) Washrooms	1/500*
	(iii) <i>Sanitary compartments</i>	1/350*
	(iv) Locker, meal and changerooms	1/500*
	(v) Boiler rooms	1/500*
	(vi) Plant, machinery rooms	1/250*
	(vii) Electrical switchboard rooms	1/250*
	(viii) Battery Rooms (other than lead acid)	1/500*
*Note:	Not less than half of the fixed natural ventilation must be provided as high in the room as possible but not less than 2 above the floor.	
*Note:	Not less than half of the fixed natural ventilation must be provided as high in the room as possible but not less than 2 above the floor.	

(b) $\dot{\gamma}$ Fixed natural ventilation may be provided by means of-

- (i) $\dot{\gamma}$ openings in walls, clear of obstructions other than louvres or grilles; or
- (ii) $\dot{\gamma}$ ceiling ventilators, including skylights and roof ventilators.

(c) $\dot{\gamma}$ Where a fixed ventilation opening is associated with a duct, that duct must have a clear open way at least twice the *required* area of the opening.

(d) $\dot{\gamma}$ Openings for fixed natural ventilation must be placed so as to let air out and, if the air entering by or around doors or by other openings is insufficient for adequate ventilation, additional openings for the entry of air must be provided.

SECTION G ANCILLARY PROVISIONS

OBJECTIVES

PART G1 MINOR STRUCTURES AND COMPONENTS

G1.1 Swimming pools

Insert Tas Objective (c) as follows:

- (c) *Swimming pools* must be designed and constructed to provide for the health and safety of swimmers and others.

G1.2 Refrigerated chambers, strong rooms and vaults

Delete Objective and insert Tas Objective as follows:

- (a) *All refrigerated or cooling chambers* must be constructed so that stored products will not be contaminated.
- (b) *Refrigerated or cooling chambers, strong rooms or vaults which are capable of accommodating a person*, must have adequate safety measures to facilitate escape and for alerting persons outside the chamber in the event of an emergency.

Add Objectives for Tas Part G101 as follows:

TAS PART G101 PROJECTIONS OVER WAYS

- (a) *Projections over ways* must not pose a danger to persons using the way nor to adjoining buildings.
- (b) *Roofs of buildings and attachments to buildings* must not allow stormwater to reach the way except by way of a drain.
- (c) *Excavations* must be protected to prevent any part of a way from subsiding into them.
- (d) *Footings of a building* must not project on to a way except if they are at sufficient depth.

PART G1 MINOR STRUCTURES AND COMPONENTS

Add Tas G1.1(c), (d), (e), (f), (g), (h) and (i) as follows:

Tas G1.1 Swimming pools

- (c) *Swimming pools* for the use of the public, a club, or an association, or in connection with Class 3,5, 6, 7, 8 or 9 buildings must-
- (i) *be constructed of durable materials with smooth finishes;*
- (ii) *have sides vertical;*
- (iii) *in that part of the pool where the water depth is not more than 1.5 m, have the bottom or floor slope not steeper than 1 vertical to 15 horizontal;*
- (iv) *have the depth of water marked clearly and conspicuously on each side of the pool (at the shallow end and at the deep end);*
- (v) *not have diving boards installed where the water depth is less than 3.5 m;*

SUPERCEDED

- (vi) $\dot{\gamma}$ have scum-gutters with opening not less than 150 mm if they are to provide hand-holds; and
 - (vii) $\dot{\gamma}$ have the floor or bottom of the pool, except for the guide lines, of such colours that the light reflectance is not less than 60%.
- (d) $\dot{\gamma}$ For a public *swimming pool* or pool in which competitions are held-
- (i) $\dot{\gamma}$ all steps into the pool must be recessed;
 - (ii) $\dot{\gamma}$ fittings must not project into the water area;
 - (iii) $\dot{\gamma}$ piping must not be bracketed to the sides to provide hand-holds;
 - (iv) $\dot{\gamma}$ surrounding concourses must be provided not less than 2 m wide, with a suitable non-slip surface, graded away from the pool and drained to waste; and
 - (v) $\dot{\gamma}$ dressing rooms with sanitary accommodation must be so located that bathers pass through that accommodation enroute to the *swimming pool*.
- (e) $\dot{\gamma}$ If the volume of a *swimming pool* exceeds 15 m³-
- (i) $\dot{\gamma}$ an adequate water recirculation, disinfection and filtration system must be installed;
 - (ii) $\dot{\gamma}$ the inlet and outlet openings in a *swimming pool* for the purpose of water recirculation must be so located that water movement is continuous from inlet to outlet;
 - (iii) $\dot{\gamma}$ inlet and outlet openings must be covered by gratings or grilles;
 - (iv) $\dot{\gamma}$ outlet opening gratings or grilles must be at least 4 times the area of the discharge pipes;
 - (v) $\dot{\gamma}$ recirculation of water in a *swimming pool* must be so designed that the pool contents are recirculated not less than once in the period shown in Tas Table G1.1(e); and
 - (vi) $\dot{\gamma}$ water filtration rates must not exceed 12 250 L/m² of sand filter bed per hour, or an equivalent rate in other filter media.

Tas TABLE G1.1(e) RECIRCULATION OF WATER IN SWIMMING POOLS

Pool Type $\dot{\gamma}$	Period
Outdoor Swimming Pool	6 hours
Indoor Swimming Pool	4 hours
Wading Pool	2 hours

- (f) $\dot{\gamma}$ Chlorine and chlorination equipment must be stored in an area or room separate from any part of the premises used by the public.
- (g) $\dot{\gamma}$ A chlorination room-
- (i) $\dot{\gamma}$ must be built or shielded to avoid penetration by direct sunlight;
 - (ii) $\dot{\gamma}$ must not be in direct or indirect contact with any ventilation system serving any other part of the building;
 - (iii) $\dot{\gamma}$ must be located to avoid transfer of heat from any boiler or furnace;
 - (iv) $\dot{\gamma}$ must be provided with ventilation within 300 mm from the floor and 300 mm from the ceiling in the ratio, in each location, of not less than 1/150 of its *floor area*;
 - (v) $\dot{\gamma}$ must be provided with a clear glass window of such size and in such a position as will enable the operator working in any position inside the room to be observed from the outside;

SUPERCEDED

SUPERCEDED

- (vi) ý must be provided with a door opening outwards and fitted with such fastenings as will ensure that the door can be opened easily from the outside or the inside without the use of a key while the operator is in the room; and
- (vii) ý must be provided with a cabinet of the "break-the-glass" type on the outside, near to the door, for the purpose of holding a gas-mask intended for use in rescue work.
- (h) ý Where no other suitable sanitary accommodation is provided sanitary facilities must be provided in accordance with Tas Table G1.1(h).

Tas TABLE G1.1(h) SANITARY FACILITIES AT SWIMMING POOLS

	Maximum Number Served by -					
	Closet Fixtures		Urinals		Wash Basins	
	1	Each Extra	1	Each Extra	1	Each Extra
Males	60	60	60	60	60	60
Females	40	40			60	60

- (i) ý Where no other suitable shower facilities are provided, showers must be provided so that each shower serves up to 40 persons.

Delete G1.2 and insert Tas G1.2 as follows:

Tas G1.2 Refrigerated chambers, strong rooms and vaults

- (a) ý A refrigerated chamber or cooling chamber installed in premises for storage of food must comply with the requirements for that premises, and must have-
 - (i) ý internal and external panels adhered directly to the insulating core material to form an integral wall section with tight fitting edges resistant to penetration by liquids;
 - (ii) ý every joint caulked with a water-resistant, flexible sealer and finished in such a manner as to prevent migration of liquids into the core;
 - (iii) ý every intersection of walls with floors and walls with walls coved with a radius not less than 25 mm;
 - (iv) ý exposed slot-head screws or open-headed pop rivets filled with sealer;
 - (v) ý service pipes and conduits concealed in floors, walls or ceilings, if practicable, or fixed on brackets to provide clearances of not less than 25 mm between the pipe and a wall and 100 mm between the pipe and a floor;
 - (vi) ý fittings not fixed over exposed pipes nor in a position to make difficult the cleaning of the pipe and surrounding area;
 - (vii) ý rat proof construction, and any inaccessible spaces between the low temperature room and surrounding walls, ceilings and fixtures proof against rats and vermin.
 - (viii) floors graded, as shown in Tas Table G1.2(a)(viii), to drains located outside the chamber as near as practicable to the door opening; and

Tas TABLE G1.2(a)(viii) ý FLOOR DRAINAGE OF REFRIGERATED OR COOLING CHAMBERS

	FLOOR SLOPE
Active chillers	not less than 1:50 ý
Other chambers	not less than 1:100 ý

- (ix) drainage from cooling units within the chamber constructed in accordance with Tas Table G1.2(a)(ix), draining to a trapped outlet located outside the chamber.

SUPERCEDED

Tas TABLE G1.2(a)(ix) DRAINAGE FROM COOLING UNITS WITHIN REFRIGERATED CHAMBERS

Wall-mounted cooling units -

drain water must be contained and removed by either a wall-mounted channel or a spoon drain located under the coil.

Floor-mounted cooling units -

drain water must be confined by kerbs, of a height not less than 150 mm, and directed to a trapped drain outlet.

Ceiling-mounted cooling units -

drain water must be confined by suitable insulated drip trays directly connected to the drainage system.

- (b) ý A refrigerated chamber or cooling chamber which is of sufficient size for a person to enter must have-
- (i) ý an escape door with a clear width not less than 600 mm and a clear height not less than 1.5 m and able to be opened from inside without a key;
 - (ii) ý a pilot light or illuminated sign clearly indicating the position of each escape door;
 - (iii) ý an external continuous or intermittent warning light or a buzzer bell, operated by chains or illuminated buttons suspended or fixed inside the chamber near each door, and positioned near each door so as to be visible or audible at a constantly manned place.
 - (iv) ý an indicator lamp positioned outside the chamber which is illuminated when the interior lights of the chamber are switched on by a switch conveniently located inside the chamber.
- (c) ý A strong room or vault in a building must have-
- (i) ý internal lighting controllable only from within the room or vault;
 - (ii) ý a pilot light located outside the room or vault but controllable only by the switch for the internal lighting; and
 - (iii) ý a suitable alarm device located outside but controllable only from within the chamber, room or vault.
- (d) ý Doors of refrigerated chambers, cooling chambers, strong rooms or vaults which are operated electrically or pneumatically must be capable of being opened by hand.

PART G4 CONSTRUCTION IN ALPINE AREAS

Delete G4.3(b):

Tas G4.3 External doorways

(b) (deleted).

Delete G4.9:

Tas G4.9 Fire orders

(deleted).

SUPERCEDED

After Part G5 insert Tas Part G101 as follows:

TAS PART G101 PROJECTIONS OVER WAYS

Tas G101.1 Construction and location of projections over ways

(a) ý In this Part the following meanings apply:

Awning means a cover projecting from a building to provide shelter or shade for people outside the building.

Balcony means a permanent projection from a building, designed to be walked, stood or sat on, and which is not roofed.

Kerb-line means the line of the carriageway edge of the kerb or, where there is no kerb, the line of the carriageway edge of the kerb if there was one.

Verandah means a permanent, roofed projection from a building, designed to be walked, stood or sat on. ý

Way includes a public road, street, alley or footpath. ý

(b) ý Every bridge connecting buildings over a way must be of *non-combustible* material.

(c) ý Every *awning* and balcony which projects over a way must be supported entirely from the building to which it is attached.

(d) ý A *verandah* must not project over a way.

(e) ý Every part of a building which projects over a way must comply with Tas Table G101.1.

Tas TABLE G101.1 PROJECTIONS OVER WAYS

Heights above ground or footpath level

<i>Awnings</i>	2.7 m
Shades or sunblinds (when not in use), signs, lamps or the like	2.4 m
Other projections	3.0 m

Maximum Distance of projection over a way

Awnings-

(i) ý <i>non-combustible</i>	not beyond a line 450 mm from the plumb of the kerb-line
(ii) <i>combustible</i>	1.0 m

Balconies

1.0 m

Other projections-

(i) ý in streets more than 15 m wide	900 mm
(ii) ý in streets not more than 15 m wide	600 mm

Note :

(i) ý A door, gate, window, sash, or shutter is not deemed to open outwards unless, when open to its utmost extent, some part of it projects beyond the boundary line of the way

(ii) ý The total width of all the oriel windows and turrets projecting onto a way in any wall of any storey of a building, taken together, must not exceed 3/5 of the length of that wall on the level of that storey

(f) ý Any *combustible awning* which projects over away must not extend to within 1.5 m of an adjoining building.

After Tas G101.1 insert Tas G101.2 as follows:

Tas G101.2 Protection of ways

(a) ý Every roof of a building, and every *verandah*, balcony, or other similar projection or projecting window must be so designed and built as to prevent stormwater from it from dropping on, running over, or seeping under any way.

SUPERCEDED

SUPERCEDED

- (b) ý The roof of any *awning* that extends more than 1.0 m over a *way* must be drained to a down pipe.
- (c) ý Down-pipes from *awnings*-
 - (i) ý must not project beyond the boundary of a *way*; and
 - (ii) ý must be of steel or provided with a protective cover to a height of 2 m from the path.
- (d) ý Any excavation must be protected, by shoring or otherwise, as necessary to prevent subsidence into the excavation of any part of a *way* adjoining it.
- (e) ý Footings must not extend beyond the boundary of a *way* other than as shown in Tas Table G101.2.

Tas TABLE G101.2 PROJECTION OF FOOTINGS

Depth of top of footing below ground level	Maximum permissible projection
Less than 1.3 m	Nil
1.3 m to 3.0 m	450 mm
Exceeding 3.0 m	750 mm

SECTION H SPECIAL USE BUILDINGS

OBJECTIVES

Insert Objectives for Tas Part H101 as follows:

Tas Part H101 Workplaces

Every workplace must be constructed in a manner that will provide for the safety, health and welfare of workers using that workplace.

Insert Objectives for Tas Part H102 as follows:

Tas Part H102 Food Premises

Each building or part of a building used as food premises must be able to be used in such a manner that food products do not become contaminated.

Insert Objectives for Tas Part H103 as follows:

Tas Part H103 Dining Rooms and Bar Services

Dining rooms and bar rooms must provide for the comfort, convenience and health of customers.

Insert Objectives for Tas Part H104 as follows:

Tas Part H104 Bottle Shops at Licensed Premises

Bottle shops, with adequate storage facilities, must provide for display of goods for sale and for shelter of customers.

Insert Objectives for Tas Part H105 as follows:

Tas Part H105 Accommodation Facilities

Accommodation facilities must provide for the comfort, convenience and security of travellers.

SUPERCEDED

SUPERCEDED

Insert Objectives for Tas Part H106 as follows:

Tas Part H106 Meat Premises

Meat premises must be constructed in such a manner that-

- (a) contamination of edile products can be avoided;
- (b) the premises can be easily cleaned; and
- (c) suitable amenities are provided for employees and inspectors.

Insert Objectives for Tas Part H107 as follows:

Tas Part H107 Dairies

Dairies must be constructed in such a manner that contamination of milk can be avoided.

Insert Objectives for Tas Part H108 as follows:

Tas Part H108 Pharmacies

Pharmacies must be able to be secured against entry and the interior must be able to be supervised by a pharmacist.

Insert Objectives for Tas Part H109 as follows:

Tas Part H109 Hospitals and Nursing Homes

Hospitals and nursing homes must be able to be easily cleaned and must have adequate space for patients.

Insert Objectives for Tas Part H110 as follows:

Tas Part H110 Premises for Activities Involving Skin Penetration

Premises for activities involving skin penetration must provide for cleanliness of staff and comfort of customers.

Insert Objectives for Tas Part H111 as follows:

Tas Part H111 Dental Surgeries and Chiropractors' Premises

Dental surgeries and chiropractors' premises must be able to be easily cleaned and must have a waiting room for patients.

Insert Objectives for Tas Part H112 as follows:

Tas Part H112 Mortuaries

Mortuaries must be constructed in a manner that will ensure the health of staff and the general public.

Insert Objectives for Tas Part H113 as follows:

Tas Part H113 Foundries

Foundries must provide for the comfort and safety of workers on the premises.

Insert Objectives for Tas Part H114 as follows:

Tas Part H114 ý Premises for Manufacture or Processing of Glass-reinforced Plastic

Premises for manufacture or processing of glass-reinforced plastic must-

SUPERCEDED

SUPERCEDED

- (a) ŷ provide for the safety and comfort of workers; and
- (b) ŷ be constructed in a manner that will avoid the spread of fire within the building and to other buildings.

Insert Objectives for Tas Part H115 as follows:

Tas Part H115 ŷ Premises for the Production or Processing of Isocyanates

Premises for the production or processing of isocyanates must-

- (a) ŷ provide for the safety and comfort of workers; and
- (b) ŷ be constructed in a manner that will avoid the spread of fire within the building and to other buildings.

Insert Objectives for Tas Part H116 as follows:

Tas Part H116 ŷ Premises for Electro-plating, Electro-Polishing, Anodising or Etching

Premises for electro-plating, electro-polishing, anodising or etching must-

- (a) ŷ provide for the safety and comfort of workers; and
- (b) ŷ be constructed in a manner that will prevent the escape of liquids and atmospheric contaminants to other areas of the building.

Insert Objectives for Tas Part H117 as follows:

Tas Part H117 Premises for Lead Processing

Premises for lead processing must-

- (a) ŷ provide for the safety and comfort of workers; and
- (b) ŷ be constructed in a manner that will minimise the lodgement of dust and must be capable of being flushed with water.

Insert Objectives for Tas Part H118 as follows:

Tas Part H118 Booths for Spray-painting or Spray-Coating

Booths for spray-painting or spray-coating must-

- (a) ŷ be constructed of *non-combustible* materials;
- (b) ŷ have adequate means of escape; and
- (c) ŷ have suitable means of extracting harmful fumes from the booth.

Insert Objectives for Tas Part H119 as follows:

Tas Part H119 Electricity Distribution Substations

Building-type electricity distribution substations must be housed in buildings that are tamper-proof, vermin-proof and weatherproof, and have adequate means of escape.

Insert Objectives for Tas Part H120 as follows:

Tas Part H120 ŷ Premises for Manufacture or Storage of Dangerous Goods

Premises for manufacture or storage of dangerous goods must-

- (a) ŷ provide for the safety and comfort of workers in the premises; and
- (b) ŷ be constructed so as not to be a danger to other people or buildings.

SUPERCEDED

Insert Objectives for Tas Part H121 as follows:

Tas Part H121 Hairdresser's Premises

Hairdresser's premises must be of adequate size and amenity.

PART H1 THEATRES, STAGES AND PUBLIC HALLS

After H1.6 insert Tas H1.101 as follows:

Tas H1.101 Movable seating

Buildings with movable seating for the audience or spectators must comply with H1.4 for all designed seating layouts.

After Part H1 insert Tas Part H101 as follows:

PART TAS H101 WORKPLACES

Tas H101.1 Application of Part

This Part is applicable to every building or part of a building used as a workplace to which the *Industrial Safety, Health and Welfare (Administrative and General) Regulations 1979* apply.

Tas H101.2 Floor area

- (a) \checkmark The *floor area* of each office must be 7 m² or sufficient to provide 4 m² for each occupant, whichever is the greater.
- (b) \checkmark Each floor plan dimension of and room which is a workplace must be greater than 2.5 m.

Tas H101.3 Floor surfaces

- (a) \checkmark Every floor in a work place must have an even, unbroken slip-resistant surface, free from holes, indentations, projections or other obstructions that might create tripping or stumbling hazards.
- (b) \checkmark Where the nature of the process is such that spillage of liquids is likely to occur, or where it is necessary for the floors to be cleansed with water or other liquids-
 - (i) \checkmark the floors must be surfaced with materials that are impervious to the penetration of liquids likely to be spilt or used in the process of cleaning; and
 - (ii) \checkmark the joints between the floors and the walls must be sealed with an impervious material and finished in such a manner that the joint is concavely rounded.

Tas H101.4 Floor drainage

- (a) \checkmark Floors in a workplace must be graded to drain off liquids which must be carried away and disposed of by means of open paved channels, covered drains or pipes.
- (b) \checkmark Floors graded as shown in Tas Table H101.4 satisfy (a).

Tas TABLE H101.4 SLOPES OF FLOORS FOR DRAINAGE

Wash (or hose-down) areas	1:25
Wet (or mop-down) areas	1:50
Dry areas	1:100

- (c) Where the effluent from drains is likely to be offensive it must be intercepted by suitable deodorising tanks.

SUPERCEDED

- (d) √ Wherever practicable, drains to carry off spilt liquids should be planned so that the liquids are intercepted close to the point of spillage and not allowed to spread over the working surface of the floor.

Tas H101.5 Floor covering

- (a) √ Where workers stand in substantially the one location while working on a floor of brick, metal, stone or other similar material, those floors or sections thereof, must be covered with-
- (i) √ wood, rubber, linoleum, resilient types of plastic tiles;
 - (ii) √ suitable compositions containing asphalt, rubber, cork, magnesite; or
 - (iii) √ other semi-resilient, thermally non-conductive materials on which the workers may stand.
- (b) √ Fixed coverings for local sections of floors must be inset flush with the main floor.

Tas H101.6 Overhead clearance

Pipes, fixtures and similar objects running above a passage or walkway must be fixed at √ a height to provide a clear distance not less than 2.1 m measured from the floor to the √ lowest part of the object. √

Tas H101.7 Lighting √

Workplaces must be designed so that artificial lighting can, without structural alteration, √ be made to comply with AS 1680. √

Tas H101.8 Ventilation

- (a) √ Every workplace must be ventilated to remove offensive gases, vapours, fumes, dust or other airborne impurities.
- (b) √ The discharge from mechanical ventilation must be constructed to prevent recirculation of the impurities.

Tas H101.9 Toilet facilities

- (a) √ Where practicable, toilet facilities must be located in the same building as the workplace or change room that they serve.
- (b) √ Toilet facilities which are not located in the same building as the workplace they serve must-
- (i) √ be sited within the boundary of the premises;
 - (ii) √ be housed in a fully roofed and clad building;
 - (iii) √ be located at a distance not greater than 100 m from any workplace they serve; and
 - (iv) √ have provided, at every entrance doorway giving direct access to the interior of the building, a full length door fitted with a suitable locking device.
- (c) √ Every closet must be fitted with a door capable of being fastened on the inside.

Tas H101.10 Hand washing facilities

- (a) √ Hand washing facilities must be located in change rooms or in wash rooms accessible to change rooms and must be placed where they can be conveniently used by persons before eating meals and after using toilet facilities.
- (b) √ Where hand washing facilities are located in a change room, the *floor area* allowed for the change room must be increased by the area *required* for the washing equipment and its use.
- (c) √ Hand washing facilities include wash basins, wash troughs and circular ablution fountains.

SUPERCEDED

Tas H101.11 Shower facilities

- (a) Where the work engaged upon is such that a change of clothing is necessary, showers with hot and cold running water must be provided at the rate of not less than shown in Tas Table H101.11.

Tas TABLE H101.11 SHOWERS IN WORK PLACES

Hot, arduous or dirty industries :	1 for every 15 employees
Light, clean industries :	1 for every 25 employees

- (b) Shower rooms must be located immediately adjacent to change rooms and urinal facilities, but urinal facilities may be provided in male shower rooms.
- (c) Separate and distinct shower accommodation must be provided for male and female employees.

Tas H101.12 Change rooms

Where change rooms are *required* by the *Industrial Safety, Health and Welfare (Administration and General) Regulations*, they must comply with Tas Table H101.12.

Tas TABLE H101.12 CHANGE ROOMS

Minimum area of room-	
for each person requiring to change clothes:	0.5 m ²
for each person not requiring to change clothes:	0.3 m ²
Minimum free floor space-	
between lockers facing one another:	1.5 m ²
between locker face and a wall:	1.0 m ²
free floor area:	2.0 m ²

Tas H101.13 Dining rooms

- (a) In any work place which is a factory or shop a dining area or dining room must be provided as set out in Tas Table H101.13.

Tas TABLE H101.13 DINING AREAS AND DINING ROOMS

<p>For 10 or less employees: a suitable dining area separate from any working area:</p> <p>Dining areas must be provided with adequate and hygienic facilities for the washing of eating utensils and for the storage of utensils where they will be protected from dust or vermin.</p>
<p>For more than 10 employees: a conveniently located dining room separate from any work room or work area:</p> <p>Dining Rooms must be equipped with a dishwashing sink supplied with hot and cold water, draining board and cupboards in which foodstuffs and crockery can be stored free from dust and vermin, except that the provision of running water shall not apply where a reticulated water service cannot be made available.</p>
<p>NOTE: Where up to 15 persons of the same sex are employed, a combined change room/dining room may be provided.</p>

- (b) In buildings to be used as offices, there must be provided on each storey, in a location accessible to all tenants, an area containing a dishwashing sink supplied with hot and cold water, cupboard storage for food stuffs and utensils, and facilities for boiling water. Such areas must not be located in toilets, wash-rooms, or change rooms.

Tas H101.14 Rest rooms

Where 20 or more females are employed, a separate rest room, with convenient access to sanitary accommodation, must be provided in accordance with Tas Table H101.14.

SUPERCEDED

Tas TABLE H101.14 FLOOR AREAS OF REST ROOMS

m ² of floor area	6	9	12	15	Each extra 3
Max. number of females served:	100	200	300	400	200

NOTE: Where a first aid room or health centre is provided the rest room may be adjacent to it or part of it.

Tas H101.15 First aid rooms and health centres

Unless *required* otherwise under *Industrial Safety, Health and Welfare (Administration and General) Regulations 1979-*

- (a) \dot{y} in every workplace, other than a shop or office, where the number of employees working on the premises exceeds 300 at any time, a self-contained health centre must be provided, at ground level if practicable, with *floor area* not less than 45 m², which includes-
- (i) \dot{y} treatment room with a *floor area* of at least 14 m²;
 - (ii) \dot{y} separate waiting room;
 - (iii) \dot{y} separate recovery room;
 - (iv) \dot{y} separate combined office and consulting room;
 - (v) \dot{y} toilet with air lock and washbasin with clean, hot and cold, running water;
 - (vi) \dot{y} store room or adequate storage cupboards; and
 - (vii) \dot{y} walls, floors and ceilings impervious to moisture, easy to clean, free from cracks, ledges and sharp angles and finished in a light colour.
- (b) \dot{y} In every workplace where the number of employees exceeds 150 at any time and where a health centre has not been provided, a first aid room must be provided, suitably located with convenient access, readily accessible to sanitary accommodation, having a *floor area* not less than 14 m² and clearly marked "FIRST AID".

After Tas Part H101 insert Tas Part H102 as follows:

TAS PART H102 FOOD PREMISES

Tas H102.1 Application of part

- (a) \dot{y} This part applies to all premises, rooms, compartments or places used in relation to the manufacture, preparation, storage, packing, carriage or delivery of food for sale and to which the following apply-
- (i) \dot{y} *Public Health (Food Hygiene) Regulations, 1977;*
 - (ii) \dot{y} *Dairy Produce Regulations 1971;* or
 - (iii) \dot{y} *Licensing Act 1976.*
- (b) \dot{y} Premises to which this Part applies include, but are not limited to-
- (i) \dot{y} bakehouses;
 - (ii) \dot{y} bar service areas;
 - (iii) \dot{y} premises for boning, curing, canning, mincing, pre-packing or other similar process of preparation of meat for sale;
 - (iv) \dot{y} butcher's shops;
 - (v) \dot{y} eating houses and tea shops;
 - (vi) \dot{y} fish shops;
 - (vii) \dot{y} kitchens in eating houses, restaurants, guest-houses, motels and hotels;

SUPERCEDED

SUPERCEDED

- (viii) rooms for processing, manufacturing, packing, etc of dairy products, ice blocks, ices, meat-for-sale, shell-fish, or other fish;
 - (ix) small goods factories;
 - (x) take-away-food stores; and
 - (xi) breweries and wineries.
- (c) This part does not apply to-
- (i) boarding houses or the like classified as Class 1 buildings; or
 - (ii) tents, buildings or other structures used temporarily for serving meals to the public at any fair, show, race meeting or other public sports, games or amusements.

Tas H102.2 Definitions

In this part, words and meanings as defined in *the Public Health(Food Hygiene) Regulations 1977*, the *Dairy Produce Regulations 1971*, and *Licensing Act 1976* apply.

Tas H102.3 Floors, walls and ceilings

- (a) Each floor, wall and ceiling of the premises must have a surface that is -
- (i) durable, rigid, impervious to water, non-absorbent, non-toxic and smooth enough to be easily cleaned; and
 - (ii) free from cracks, crevices and other defects.
- (b) If the floor is subject to wet cleaning by hosing down or if activities are carried out where liquids are discharged on to the floor, the floor must be graded to trapped floor waste outlets connected to a drainage installation.
- (c) Each wall must be free from skirtings, architraves, picture rails or other ledges that could provide lodgement for dirt.
- (d) All angles between the walls and the floor must be coved to permit ease of cleaning.
- (e) All angles between walls and all joints in walls must be sealed.
- (f) All walls and ceilings must be finished in light colour, and if painted, must be washable.
- (g) Sub-clauses (a), (b), (c), (d), (e) and (f) do not apply to areas used only by customers and they do not apply to walls and ceilings in a premises or place-
- (i) used for the storage or display for sale of food that is wholly enclosed in protective packages;
 - (ii) used for the storage for sale of fruit and vegetables; or
 - (iii) in which all food for sale is completely enclosed and otherwise protected from contamination by processing plants, other appliances, or other means.

Tas H102.4 Food store

Every eating house must have a dry-food store.

Tas H102.5 Pests and contaminants

- (a) The exterior of a food premises must be constructed to exclude pests and contaminants.
- (b) Premises which are provided with-
- (i) fly-proof, external windows and *self-closing* fly proof doors, or
 - (ii) if customers are served outside the premises through an opening, an appliance for the elimination of flies and mechanical ventilation adequate to exhaust air through the opening at a rate of not less than 5 litres per second for each square metre of opening, satisfies (a) as it applies to insects.

SUPERCEDED

Tas H102.6 Washbasins

Each premises or place for preparation or storage of food for sale must be provided with not less than one washbasin, supplied with hot and cold water, in or within reasonable proximity of those areas where the nature of the activities performed is such that hands are likely to be a source of contamination of food.

Tas H102.7 Glass washing apparatus

Every bar service area must have a suitable glass washing apparatus in accordance with Circular 330/110, dated 22 May 1984, from the Minister for Health.

Tas H102.8 Sinks

- (a) Each premises must be provided with a double bowl sink or tub of stainless steel supplied with-
- (i) hot and cold water; and
 - (ii) an integral drainer on at least one side.
- (b) If a sink is installed adjacent to a wall or other vertical surface, it must be fitted with an integral flashing to that wall or vertical surface to a height of not less than 150 mm.
- (c) The sink must be provided with an integral surround not less than 150 mm wide except on sides with an integral flashing as in (b).

Tas H102.9 Installation of equipment and fittings

- (a) Each item of equipment or fitting in a premises which is not capable of being moved easily must be installed-
- (i) so that the area underneath the item can be easily cleaned; or
 - (ii) on a solid base or plinth constructed of impervious material similar to the flooring material.
- (b) A plinth must be-
- (i) not less than 75 mm high;
 - (ii) finished to a smooth even surface and rounded at exposed edges to facilitate cleaning;
 - (iii) coved at intersections with floor and walls.

Tas H102.10 Drains

A grease trap, a gully trap or an untrapped opening connected directly with a drain or sewer, must not be installed in a room used for preparation, processing, packing or storing of food for sale.

Tas H102.11 Concealment of pipes

Where practicable, service pipes should be concealed beneath the surface of walls, floors, or ceilings, otherwise, pipes are to be fixed clear of the wall, floor, or ceiling, at such distance as to facilitate cleaning.

Tas H102.12 Storage of materials and equipment

Separate areas for the storage of fuel, cleaning compounds and general maintenance equipment must be provided so as to prevent the contamination of the product in the event of a spillage or any other form of breakdown.

Tas H102.13 Separation of work place

A room where food for sale is to be processed, manufactured, prepared, deposited, treated, stored or packed, must not have direct communication with a room containing sanitary facilities, living quarters, laundry, bathroom or garage or a room where animals are housed.

Tas H102.14 Offensive material and trade waste

If offensive material or trade waste is stored, a separate area must be provided which-

- (a) ý is paved and easily cleanable;
- (b) ý is graded to drain to a suitable drainage system;
- (c) ý is fitted with metal racks capable of holding storage receptacles not less than 300 mm above the paved area; and
- (d) ý has available a supply of water under pressure.

Tas H102.15 Mechanical ventilation of kitchens

Where cooking or extensive heating which emits greasy vapours is done in a kitchen serving an eating house, accommodation facility or take-away food store, a mechanical ventilating exhaust system must be provided in accordance with Rules and Specifications for Mechanical Ventilation of Kitchens (No 1 of 1976) under the *Public Health Act 1962*.

Tas H102.16 Dairy produce

(a) ý Definition:

Dairy produce means milk, cream, butter, cheese, condensed milk, ice-cream and any other product of milk and includes margarine and dairy blend.

(b) ý Premises designed and constructed in compliance with the Australian Code of Practice for Dairy Factories satisfy the special requirements of this code for premises to be used for the manufacture of *dairy produce*.

After Tas Part H102 insert Tas Part H103 as follows:

TAS PART H103 DINING ROOMS AND BAR ROOMS

Tas H103.1 Application of Part

This Part applies to-

- (a) ý dining rooms in eating houses as covered by the *Public Health (Food Hygiene) Regulations 1977*; and
- (b) ý dining rooms and bar rooms (excluding bar service areas) in licensed premises covered by the *Licensing Act 1976*.

Tas H103.2 Number of persons accommodated

- (a) ý The number of diners in a dining room, or customers in a bar room, for whom *exits* and sanitary facilities are provided, must be calculated on the basis of-
 - (i) ý one diner for each 1 m² of *floor area* of the dining room; and
 - (ii) ý one customer for each 0.5 m² of *floor area* of the bar room.
- (b) ý The *floor areas*, for the purpose of (a), do not include any part-
 - (i) ý used as a dance floor;
 - (ii) ý used by a band, orchestra or group of persons providing entertainment for diners; or
 - (iii) ý set aside for display or serving food or drink, which must be calculated separately.

Tas H103.3 Access

Every dining room and family bar room must have at least one access that is not through a bar room other than a family bar.

Tas H103.4 Sanitary facilities

- (a) ý Separate sanitary facilities for males and females must be provided in close proximity to each dining room and bar room in licensed premises.
- (b) ý Access to sanitary facilities from a dining room or family bar room must be not only through a bar room.

Tas H103.5 Insect proofing

- (a) ý Subject to sub-clause (b) every opening window of a dining room must be fitted with an efficient, insect-proof window screen, and every exterior doorway giving access to a dining room must be fitted with an efficient, insect-proof, *self-closing* door.
- (b) ý A dining room, lounge and entrance hall, or other area adjacent thereto, which is fitted with appliances for the elimination of flies and insects, by electricity or otherwise, satisfies (a).

Tas H103.6 Separation from other areas

A dining room must not have direct opening to sanitary facilities, living quarters, a laundry, bathroom or garage or a room where animals are housed.

After Tas Part H103 insert Tas Part H104 as follows:

TAS PART H104 BOTTLE SHOPS AT LICENSED PREMISES

Tas H104.1 Application of Part

This part is applicable to drive-in bottle shops at premises licenced under the *Licensing Act 1976* to sell liquor.

Tas H104.2 Drive-in bottle shops

A drive-in bottle shop must-

- (a) ý be attached to or adjacent to licenced premises;
- (b) ý have storage area, display area and refrigeration facilities; and
- (c) ý provide protection from rain for persons when purchasing liquor or inspecting the range of liquor offered for sale from that bottle shop.

Add Tas Part H105 as follows:

TAS PART H105 ACCOMMODATION FACILITIES

Tas H105.1 Application of Part

- (a) ý This Part applies to every form of accommodation facility for travellers covered by the *Licensing Act 1976* and *Tourism Act 1977*.
- (b) ý The accommodation facilities include those classified by the Commissioner for Licensing as international hotels, tourist hotels, local hotels, motels, guest houses, serviced apartments, holiday flats, holiday cabins, hostels, residential camps, caravan parks and camping grounds.

Tas H105.2 Definitions ý

Common Suite means a *bedroom* with sanitary facilities attached to that *bedroom*. ý

Executive Suite means at least one *bedroom*, one private lounge room, and sanitary ý facilities attached to the suite. ý

Family Suite means at least two *bedrooms* and sanitary facilities attached to the suite. ý

Bedroom means a room for sleeping and includes a dormitory. ý

SUPERCEDED

Single Occupancy Unit means a room, suite or cabin designed to be occupied by one or more persons travelling together.

Tas H105.3 Floor area of bedrooms

- (a) ý For accommodation facilities, other than holiday cabins, hostels and residential camps, the *floor area* of the only *bedroom* or main *bedroom*-
 - (i) ý in a *single occupancy unit*, for which a separate lounge room or living room is not provided, or
 - (ii) ý in an *executive suite*, must be not less than 6 m² for each person to be accommodated in that *bedroom*.
- (b) ý The *floor area* of any other *bedroom* must be not less than 4 m² for each person to be accommodated in that *bedroom*, or 6 m², whichever is the greater.
- (c) ý For the purposes of (a) and (b) the area occupied by-
 - (i) ý a bathroom or toilet attached to a *bedroom*; or
 - (ii) ý an entry passageway to a *bedroom*, must not be included in the area of a *bedroom*.

Tas H105.4 Eating areas

- (a) ý Dining rooms, where provided in accommodation facilities, for travellers must comply with the requirements of Tas Part H103.
- (b) ý An eating area must be provided in each *single occupancy unit* for which meals are provided for consumption in the unit or in which occupants prepare their own meals.
- (c) ý A communal eating room must be provided in each hostel or residential camp with space equivalent to 1 m² for each person who can be accommodated in that hostel or residential camp.

Tas H105.5 Cooking areas

- (a) ý Kitchens, attached to dining rooms or in which meals are prepared and cooked for delivery to guests or for sale to customers, must comply with the requirements of Tas Part H102.
- (b) ý Each serviced apartment and holiday flat must be provided with a cooking area with space for-
 - (i) ý food storage;
 - (ii) ý a refrigerator; and
 - (iii) ý free standing stove or wall oven and cooking top or equivalent.
- (c) ý Each holiday cabin must be provided with space for -
 - (i) ý food storage; and
 - (ii) ý an appliance for cooking.
- (d) ý Each hostel and residential camp must be provided with space for-
 - (i) ý sufficient appliances for cooking;
 - (ii) ý refrigeration; and
 - (iii) ý food storage.
- (e) ý Each cooking area must be provided with an adequate supply of potable hot and cold water.

Tas H105.6 Sanitary facilities in suites and flats

Each suite and holiday flat must be provided, within the suite or flat, with sanitary facilities which include-

- (a) ý a bath or shower or both, together or separate;

SUPERCEDED

(b) ý a water closet; and

(c) ý a washbasin.

Tas H105.7 Sanitary facilities at individual caravan sites

Where provided at individual caravan sites sanitary facilities must include a shower cubicle, water closet and a washbasin.

Tas H105.8 Communal sanitary facilities

(a) ý Communal sanitary facilities must be provided for travellers accommodated in a local hotel or guest house in accordance with Table F2.1, and must be situated-

(i) ý conveniently in relation to the travellers' *bedrooms* for which the units are provided; and

(ii) ý in such a position as to be capable of being entered from within the premises.

(b) ý Separate communal sanitary facilities must be provided for travellers of each sex accommodated in holiday cabins, hostels, residential camps, caravan parks or camping grounds in accordance with Tas Table H105.8

(c) ý For male travellers one third of closet pans may be replaced by urinals.

(d) ý In calculating the numbers of facilities to be provided under (a) and (b) the following must not be included in the communal sanitary facilities to be provided for travellers-

(i) ý those provided for use by the proprietor, his family and his employees; or

(ii) ý those provided for the sole use by persons occupying accommodation or caravan sites with sanitary facilities attached.

(e) ý Washbasins may be installed in a separate communal area for each sex.

(f) ý Where communal toilets are located in a building separate from communal washing facilities, washbasins must be installed in the toilet building at the rate of one washbasin for each three toilets in the building.

(g) ý Communal sanitary facilities for females must have adequate means for disposal of sanitary towels.

Tas TABLE H105.8 COMMUNAL SANITARY FACILITIES FOR TRAVELLERS

Holiday cabins, hostels, residential camps, caravan parks or camping grounds-		
Max. Number of Males or Females Served by:	1	Each Extra
Closet Fixture(s)	10	15
Wash Basin(s)	10	15
Shower	10	15

Tas H105.9 Location of facilities

(a) ý In a hostel or residential camp, communal sanitary facilities must be situated-

(i) ý at a distance no greater than 100 m from the travellers' *bedrooms* or dormitories in the hostel or residential camp in respect of which the units are provided; and

(ii) ý in such a position as to be capable of being entered from within the hostel or residential camp premises.

(b) ý At holiday cabins, communal sanitary facilities must be situated conveniently in relation to the cabins for which the units are provided, being in no case more than 100 m or less than 6 m from any of those holiday cabins.

(c) ý In a caravan park the communal sanitary facilities must be situated-

(i) ý at a distance no greater than 100 m and no less than 6 m from any caravan site; and

SUPERCEDED

- (ii) ý in such a position as to be entered from within the park.
- (d) ý In camping grounds the communal sanitary facilities must be situated-
 - (i) ý conveniently in relation to that area of the camping ground on which caravans may be parked or tents erected; and
 - (ii) ý in such a position as to be entered from within the camping ground.

Tas H105.10 Doors and windows on communal facilities

- (a) ý Every external doorway giving direct access to the interior of a building containing a sanitary facility or a laundry, or a group of sanitary facilities or laundries must be provided with a full-length door fitted with a suitable locking device.
- (b) ý A doorway giving access to a bathroom, shower-cubicle, or toilet closet within a building containing communal sanitary facilities must be provided with a door of such size as to allow for adequate space to be left open between the top and bottom of the door and the head of the doorway and the floor respectively, whilst still ensuring the privacy of the user.
- (c) ý Each door referred to in (b) must be fitted with a suitable means of fastening to ensure the privacy of the user and must be capable of being opened from the outside in an emergency.
- (d) ý Every window serving a sanitary facility must be glazed with obscured glass.

Tas H105.11 Laundry facilities

- (a) ý Communal laundry facilities must be provided for other than international hotels at the rate shown in Tas Table H105.11 for use by occupants for whom individual laundry units have not been provided.
- (b) ý A water supply must be capable of providing ample hot and cold, potable water to the unit.
- (c) ý A laundry unit must include space for-
 - (i) ý one washing machine;
 - (ii) ý one wash trough; and
 - (iii) ý one ironing board or ironing table.
- (d) ý Drying units for washed clothes must be provided with space for-
 - (i) ý 6 m of clothes line; or
 - (ii) ý one heater dryer for each laundry unit.

Tas TABLE H105.11 NUMBERS SERVED BY LAUNDRY UNITS

Units served	One Laundry unit serves	Each Extra Laundry unit serves
Suites in hotels, motels or guest houses:	10 ý	30
<i>Bedrooms</i> in hotels or guesthouses but not in suites	15 ý	50
Holiday flats or holiday cabins: ý	10	30
Sites in Caravan Parks or camping grounds:	20 ý	50
Travellers in hostels or residential camps:	60 ý	150

Note: In calculating the number of communal units to be provided those *single occupancy units* with attached laundry units need not be included.

Tas H105.12 Floors of sanitary facilities and laundry facilities

The floor of a building or part of a building containing communal sanitary facilities or communal laundry facilities must-

- (a) ý have an impervious, smooth, non-slip surface which must be continued up all walls to a height of 150 mm above floor level;

SUPERCEDED

SUPERCEDED

- (b) ý have the junctions between the floor and walls coved for easy cleaning;
- (c) ý be graded to a floor waste; and
- (d) ý not be painted.

Tas H105.13 ý Insect proofing

Every accommodation facility must be rendered insect-proof by the fitting of-

- (a) ý an insect-proof screen on at least one openable window in each room and every fireplace in that unit; and
- (b) ý a *self-closing* insect-proof door to every outside door way of that unit.

Tas H105.14 ý Doors on accommodation facilities

- (a) ý An external door to a *bedroom*, suite or dormitory must be-
 - (i) ý fitted with a suitable locking device; and
 - (ii) ý capable of being locked from inside the *bedroom*, suite or dormitory.
- (b) ý Every internal door in an accommodation facility must be fitted with latching device capable of being opened from either side in an emergency.

After Tas Part H105 insert Tas Part H106 as follows:

TAS PART H106 MEAT PREMISES

Tas H106.1 ý Application of Part

This Part is applicable to abattoirs, slaughter houses, poultry abattoirs, game-meat processing works and pet food works licenced under the *Meat Hygiene Act 1985*.

Tas H106.2 ý Australian Code of Practice for Construction and Equipment of Abattoirs

Premises built in accordance with the requirements of the Australian Code of Practice for Construction and Equipment of Abattoirs will be deemed to comply with this Part.

Tas H106.3 ý Walls

- (a) ý The walls of meat premises must be constructed so that-
 - (i) ý the internal surface of walls and the surface of all support pillars or posts are constructed of a suitable light coloured smooth impervious, non-toxic material which is easy to clean and disinfect, to a height of at least 1.8 m from the upper surface of the flooring but must be to a greater appropriate height if the slaughtering, dressing, and processing are to be carried out above this height;
 - (ii) ý internal surfaces of walls have a light coloured smooth continuous surface that is rust resistant, and resistant to or protected from impact damage and not readily subject to chipping, flaking or crazing;
 - (iii) ý all joints and interior angles formed by the junction of wall to wall must be sealed and the angles must be coved for easy cleaning.
- (b) ý The inside surface of walls built on plinths must be flush with the inside surface of the plinth.

Tas H106.4 ý Ceilings

- (a) ý Where a ceiling is provided it must be-
 - (i) ý sufficiently clear of the roof to allow inspection and servicing;
 - (ii) ý at a height from the upper surface of the flooring to permit and allow for the slaughtering and processing procedures to be performed in an hygienic manner;

SUPERCEDED

SUPERCEDED

- (iii) ý constructed of smooth, rigid, light coloured materials; and
- (iv) ý properly finished around the perimeter so as to exclude insects, vermin and dust.

(b) ý Where ceilings are not provided-

- (i) ý the internal roof surfaces must be capable of easy cleaning;
- (ii) ý equipment and fittings must be installed in a manner which facilitates easy cleaning of the internal roof surfaces; and
- (iii) ý the junction of the roof to the walls must be so constructed and finished as to exclude insects, vermin, and dust.

Tas H106.5 Floors

- (a) ý The floors of meat premises must be constructed of suitable heavy duty, impervious, non-toxic material which is easy to clean and disinfect and must have surfaces which will minimize the risk of slipping.
- (b) ý Floors must be evenly graded to a floor waste or outlet of minimum diameter 100 mm fitted with P or S-shaped traps.
- (c) ý All floor to wall and floor to kerb junctions must be coved for easy cleaning.

Tas H106.6 Kerbs

A kerb must be at least 300 mm high and where concrete is used for kerbing, it must be trowelled to an even, impervious surface.

Tas H106.7 Lighting

- (a) ý Adequate natural or artificial lighting which does not distort colours should be provided throughout the establishment.
- (b) ý The intensity of light provided should be in accordance with AS 1680.
- (c) ý Light bulbs and fixtures suspended over meat in any stage of preparation should be of a safety type or otherwise protected to prevent contamination of meat and meat products in case of breakage.

Tas H106.8 Sanitary facilities

- (a) ý Meat premises must be provided with ready access to toilet and hand washing facilities.
- (b) ý Any toilet must not be in direct communication with any processing area;
- (c) ý All human sewage effluent must be kept entirely separate from trade wastes and trade effluent drainage lines within the plant.
- (d) ý An appropriate number of washbasins, operated by means of a foot pedal or by other suitable means, must be installed throughout the plant with hot and cold running water to provide warm water at every basin while slaughtering or processing is in progress.

Tas H106.9 Ventilation

- (a) ý Meat premises must be ventilated adequately to prevent excessive heat, steam, and condensation and to ensure that the air of premises is not contaminated with odours, dust, vapour, or smoke.
- (b) ý Mechanical ventilation must be capable of producing more than 4 air changes per hour.
- (c) ý Air intakes must be located so as to avoid the intake of air contaminated with dust or odours.
- (d) ý Where a roof mounted cooling system discharges into a room, the discharge must not be located over edible products.

SUPERCEDED

Tas H106.10 Doors

The doors and doorways of meat premises must be constructed so that-

- (i) √ doors are provided on all external doorways;
- (ii) √ doorways, passageways, or openings through which products are transferred by rail, trolley or conveyor are of such a width that the products do not touch walls or door jambs;
- (iii) √ all door jambs and doors are smoothly finished and constructed of impervious rust-resistant materials; and
- (iv) √ all external doorways are fitted with *self-closing*, rust-resistant screen doors or fitted with suitable devices to prevent the entry of insects and vermin into the meat premises.

Tas H106.11 Windows

(a) √ All windows in meat premises must-

- (i) √ be constructed of smoothly finished rust-resistant material;
- (ii) √ be fitted flush to the inside walling to prevent projection of the interior sills where possible;
- (iii) √ be fitted with whole panes;
- (iv) √ where capable of being opened, be fitted with effective rust-resistant screens (capable of easy removal for cleaning) to exclude insects and vermin; and
- (v) √ be of a non-opening type where they face an area which produces noxious odours.

(b) √ Internal sills must slope at an angle of 45 degrees.

Tas H106.12 Rodent and vermin proofing

Buildings must be constructed so as to be rodent and vermin proof.

Tas H106.13 Drainage

(a) √ Drainage lines must be-

- (i) √ trapped with P or S shaped traps;
- (ii) √ properly vented to the outside air; and
- (iii) √ equipped with effective rodent screens.

(b) √ Drainage lines must be not less than 200 mm in internal diameter where used for paunch and stomach contents, and not less than 100 mm in internal diameter where used for other than paunch and stomach contents.

(c) √ Floor drainage must be directed to a save-all or other suitable means of removing solids and suspended fats which must-

- (i) √ not be located within the immediate vicinity of an edible area; and
- (ii) √ be constructed with paved and drained surrounds and be capable of being readily cleaned.

(d) √ Drainage lines from toilet bowls and urinals-

- (i) √ must not be connected with other drainage lines within the plant;
- (ii) √ must discharge into a suitable sewerage or effluent system; and
- (iii) √ must be located so that if leakage develops, it will not affect the product, material used in association with the product, or equipment.

(e) √ Spoon drains on slaughter floors must-

- (i) √ be provided to follow the course of the dressing rail; and
- (ii) √ be connected to drainage lines at suitable places.

SUPERCEDED

- (f) √ Spoon drains or floors graded to strategically located outlets must be provided in processing rooms.
- (g) √ Box channel drains-
 - (i) √ may be used in processing rooms provided the channel directs drainage to suitably located drainage lines;
 - (ii) √ must be covered by a grating;
 - (iii) √ must have coving at the junction of the base and upright of the drain; and
 - (iv) √ must not be excessively deep.
- (h) √ Drainage lines in upstairs processing departments must be arranged so that traps and lines do not pass through edible meat departments at the lower level.
- (i) √ In a poultry abattoir, a catchpit, capable of excluding feathers from any drain or sewer, must be provided.

Tas H106.14 Rendering facilities

- (a) √ Buildings housing plant or equipment for rendering inedible products, other than those using dry rendering methods, must be located not less than 27 m from any building in which animals are slaughtered or dressed, or in which meat or material used in association with meat is treated or stored.
- (b) √ Milling, bagging, bulk storage and load-out operations associated with rendering must be separate from edible product departments.
- (c) √ Hand washing facilities must be provided, where dead stock is handled.

Tas H106.15 Hanging room

- (a) √ Where it is intended to hold carcasses in meat premises and where a chiller is not provided in those premises, the premises must be provided with a hanging room to store the maximum number of carcasses to be held or to be slaughtered in any one day.
- (b) √ The hanging room referred to in (a) must be so constructed that it is part of the slaughtering works, complies with the general requirements of Tas H106.23 is in direct communication with the slaughtering floor, has ventilation or cooling facility to ensure that the temperature will not rise above 16° Celsius, and has sufficient rail length and space to allow each carcass to hang freely without contacting adjacent carcasses or walls.

Tas H106.16 By-Products processing areas

- (a) √ The by-products processing area must be in an area separated by a wall from the slaughter floor and from all areas handling inedible material.
- (b) √ The by-products processing areas and the area for the processing of edible fats must conform to the same construction requirements as for the meat premises.

Tas H106.17 Storage of waste offal

- (a) √ Meat premises must be provided with a room for the temporary storage of waste offal, condemned or inedible meat and other waste materials.
- (b) √ The room referred to in (a) must-
 - (i) √ be capable of handling one day's waste;
 - (ii) √ be readily accessible from the slaughtering and dressing area;
 - (iii) √ be provided with a doorway leading directly to the exterior of the meat premises, for the purpose of readily removing waste materials and condemned or inedible materials from the room.

SUPERCEDED

Tas H106.18 Storage of hides and skins

- (a) √ Hides and skins which are temporarily held in meat premises while awaiting removal, must be held in a room or shed completely separated by a wall from the slaughter floor, edible products processing area, and inedible products processing area.
- (b) √ The storage place must have an impervious floor properly graded, drained and kerbed.
- (c) √ Proper facilities must be provided in or adjacent to the hide and skin room or shed for the storage of salt and other items used in the curing, treatment, and storage of hides and skins.

Tas H106.19 Boning rooms

Boning rooms must have refrigeration units of sufficient capacity to maintain the room area at a temperature no higher than 10° Celsius.

Tas H106.20 Amenities for employees

Change rooms and sanitary facilities must be provided at premises for employees so that-

- (a) √ access to the amenities is achieved without employees from edible products processing area having to pass through waste products areas or employees from waste products areas having to pass through edible products processing areas;
- (b) √ all internal ledges are sloped downwards at an angle of not less than 45° to the horizontal.
- (c) √ the rooms are ventilated to provide a minimum of 4 air changes per hour;
- (d) √ the fresh air intake is located so that air is not contaminated and air introduced by mechanical equipment is filtered to exclude dust and vermin.

Tas H106.21 Amenities for inspectors

In meat premises licenced as an abattoir-

- (a) √ change rooms, showers and toilets must be provided for inspectors at the meat premises separate from the amenities provided for employees;
- (b) √ office accommodation for inspectors must be provided-
 - (i) √ separate from office accommodation provided for the persons engaged in the management of the meat premises;
 - (ii) √ with *floor area* not less than 9 m²; and
 - (iii) √ with linear dimensions not less than 2 m; and
- (c) √ where there are two or more inspectors accommodated at a meat premises, a dining area of suitable size must be provided in a room other than the dining area provided for employees.

Tas H106.22 Store rooms

- (a) √ Rooms for the storage of packaging material must not have air connection with rooms utilised for the storage of cleaning compounds, chemicals and other like materials.
- (b) √ Where the cleaning materials store adjoins the slaughter floor or other edible department, the opening must be fitted with a full-height, *self-closing* door.

Tas H106.23 Chillers and freezers

A chiller or freezer for edible products must be constructed so that it complies with general requirements of Tas G1.2 and also must be constructed so that-

- (a) √ it is located in association with an edible products processing area;
- (b) √ it has sufficient space available to accommodate the product of one day's kill in such a manner that the cooling air flow is able to contact all surfaces of the product;

SUPERCEDED

- (c) ý the load area associated with chillers and freezers must be provided with a protective *awning*.

After Tas Part H106 insert Tas Part H107 as follows:

TAS PART H107 DAIRIES

Tas H107.1 Application of Part

This Part is applicable to every dairy as covered by the *Dairy Produce Regulations 1971*.

Tas H107.2 General

A dairy must include -

- (a) ý a milking shed; and
(b) ý a dairy house or suitable refrigerated tank.

Tas H107.3 Size of dairy house

The *floor area* of a dairy house must be not less than 12 m².

Tas H107.4 Walls

- (a) ý The heights of the walls of milking shed and dairy house must be not less than 2.4 m from the floor to the top of the walls.
(b) ý The walls of the milking shed and dairy house must be constructed of durable materials.
(c) ý Timber must not be used within 1 m of the floor.
(d) ý Where any walls of the milking shed and dairy house are of other than concrete or masonry construction-
(i) ý the walls must be carried on top of a plinth of concrete or other suitable material to a height of not less than 150 mm; and
(ii) ý the joint between the plinth and the inner lining material must be sealed with a suitable sealant.
(e) ý All interior concrete or masonry surfaces of the milking shed and dairy house must be-
(i) ý rendered smooth to a minimum height of 1 m above floor level; and
(ii) ý sealed or painted with a suitable paint.
(f) ý The inner side of the walls of the dairy house must be finished so as not to afford lodgment for dust, dirt, birds or vermin.

Tas H107.5 Floors

The floors of the milking shed and dairy house must be-

- (a) ý constructed of an impervious, durable material; and
(b) ý so graded that the washings will run into suitable drains.

Tas H107.6 Ceiling

- (a) ý A ceiling must be provided to the dairy house.
(b) ý The ceiling must-
(i) ý have a smooth, rigid surface that is free from cracks, crevices, and other defects;
(ii) ý be constructed in a manner that offers the least possible lodgement for dust and flies and other insects;
(iii) ý be finished in a light colour; and
(iv) ý be washable.

SUPERCEDED

Tas H107.7 Passage-way between milking shed and dairy house

- (a) ŷ Subject to (c), where a milking shed and dairy house are constructed under the same roof, they must be separated by not less than 1 m.
- (b) ŷ For the purposes of (a) the separation space must be-
- (i) ŷ walled on each side from the floor to a height level with the top of the milking shed walls on the side adjacent to the milking shed and to the roof on the side adjacent to the dairy house; and
 - (ii) ŷ ventilated in such a manner that there is at least 0.5 m² of ventilation at each end of the passage.
- (c) ŷ Notwithstanding (a), a milking shed and dairy house may be constructed under the same roof without a passage-way separating them provided there is no doorway or other opening between the dairy house and the milking shed, other than an opening *required* for pipes connected to a milking machine.

Tas H107.8 Entry doors to dairy house

Entry doors to a dairy house must-

- (a) ŷ be *self-closing*; and
- (b) ŷ located not less than 1 m from a milking shed or a cow yard.

Tas H107.9 Ventilation

Natural cross ventilation of the dairy house must be by -

- (a) ŷ openable windows of at least 1.2 m² in area; and
- (b) ŷ openings, not less than 250 mm long and 150 mm high, and not more than 300 mm above the floor arranged in equal parts in two *external walls*.

Tas H107.10 Insect proofing

All external openings in a dairy house must be fitted with fine insect-proof screens.

Tas H107.11 Drains

- (a) ŷ Any washings or drainings from the milking shed, dairy house or cow yard must, where practicable, be carried away in an impervious drain for a distance of not less than 9 m from the milking shed and dairy house.
- (b) ŷ A manure sump must not be installed in a drain referred to in (a) at a distance of less than 9 m from the dairy house.
- (c) ŷ A drain must not lead directly into a sewer, unless it is effectively trapped.

After Tas Part H107 insert Tas Part H108 as follows:

TAS PART H108 PHARMACIES

Tas H108.1 Application of Part

This Part applies to all pharmacies to which the *Pharmacy Regulations 1966* apply.

Tas H108.2 Definition

In this Part the following meaning applies-

Dispensary means the room or area within a pharmacy or other premises which a registered pharmaceutical chemist uses for the compounding or dispensing of prescriptions, medicines or drugs.

Tas H108.3 Pharmacy premises

- (a) ŷ Each *premises* used as a pharmacy must have-

SUPERCEDED

- (i) ý a dispensary for the compounding or dispensing of drugs and for the storage of material used in dispensing;
 - (ii) ý space for the storage of narcotic substances and poisons as *required* by the *Poisons Regulations 1975*;
 - (iii) ý a place for unpacking containers or cases and goods; and
 - (iv) ý a room for storing merchandise not used in dispensing.
- (b) ý A pharmacy may have an area set aside for retailing merchandise that is not compounded or dispensed.

Tas.H108.4 Dispensary

- (a) ý A *dispensary* must be located-
- (i) ý within a pharmacy in a position to enable a person in the dispensary to supervise the dispensary, storage areas for narcotic substances and poisons, the entrances to unpacking areas and areas for storing other substances, and the retail area; and
 - (ii) ý separate from any place where goods are unpacked or where general merchandise, not used in dispensing, is stored.
- (b) ý Each *dispensary* must be provided with-
- (i) ý a sink and drainage board of impervious material moulded or manufactured in one piece;
 - (ii) ý a reticulated supply of hot and a cold water capable of providing to the sink adequate quantities of water for dispensing purposes; and
 - (iii) ý space for a dispensing bench with a working area not less than 1.4 m².

Tas H108.5 Security of dispensary

- (a) ý Every *dispensary* and enclosure set aside for the storage of narcotic substances and poisons must be able to be secured against entry.
- (b) ý If a *dispensary* is located in a pharmacy that is capable of being secured against entry at all times while the dispensary is not in use, then the dispensary is deemed to be secured against entry.

After Tas Part H108 insert Tas Part H109 as follows:

TAS PART H109 HOSPITALS AND NURSING HOMES

Tas H109.1 Application of Part

This Part applies to every hospital or nursing home.

Tas H109.2 Floor area of wards

The *floor area* of each ward must be sufficient to provide not less than-

- (a) ý 9 m² in a one-bed ward; or
- (b) ý 7.5 m² for each patient accommodated in any other ward.

Tas H109.3 Floor and walls

- (a) ý All floors and walls must have a smooth impervious and non-toxic finish.
- (b) ý The junctions between floors and walls must be coved for ease of cleaning.
- (c) ý In operating theatres, all junctions of walls with walls and of walls with ceilings must be coved.

SUPERCEDED

Tas H109.4 Grab rails

Every toilet closet, bath and shower alcove for use by patients must be fitted with grab rails.

Tas H109.5 Insect proofing

Each external opening must be fly-screened except where the openings are fitted with *self-closing* doors or with doors provided with suitable insect repellent devices.

Tas H109.6 Water temperature

The temperature of water supplied to baths and showers for patients must not exceed 50°C.

Add Tas Part H110 as follows:

TAS PART H110 ý PREMISES USED FOR ACTIVITIES INVOLVING SKIN PENETRATION

Tas H110.1 Application of Part ý

This part applies to premises for tattooing, ear-piercing, acupuncture and like activities, ý covered by the *Public Health (Skin Penetration) Regulations 1978*. ý

Tas H110.2 Sanitary facilities

- (a) ý Sanitary facilities for customers must be provided and must include not less than-
- (i) ý one water closet; and
 - (ii) ý one washbasin
- (b) ý Sanitary facilities must be separated from the workroom by-
- (i) ý an air lock with *self-closing* entry door; or
 - (ii) ý a *self-closing* door.

Tas H110.3 Washbasins

The area in which skin penetration is done must be provided with-

- (a) ý one washbasin for each 10, or part of 10 employees; and
- (b) ý an adequate supply of hot and cold water controlled by foot-operated or elbow-operated taps.

After Tas Part H110 insert Tas Part H111 as follows:

TAS PART H111 ý DENTAL SURGERIES AND CHIROPRACTORS' PREMISES

Tas H111.1 Application of Part

This Part applies to premises to be used-

- (a) as a dental surgery and covered by the *Dental Regulations 1983*; or
- (b) ý in the practice of chiropractic and covered by the *Chiropractors Regulations 1984*.

Tas H111.2 Waiting room

Each dental surgery and chiropractor's premises must have a separate waiting room.

Tas H111.3 Floor, walls, and ceiling

The floor, walls and ceiling of a dentist's surgery and each room used in conjunction with that surgery or in a chiropractor's premises must be finished with materials which enable easy cleaning and disinfecting.

After Tas Part H111 insert Tas Part H112 as follows:

TAS PART H112 MORTUARIES

Tas H112.1 Application of Part

This Part applies to any premises used for the storage or preparation for burial, cremation or disposal by other means, of bodies of deceased persons.

Tas H112.2 Layout of mortuary

- (a) ý A mortuary may be integral with the remainder of a building but must be separated physically from all public areas of that building.
- (b) ý Each mortuary at which bodies are prepared for burial, cremation or other disposal must be provided with a body preparation room-
 - (i) ý capable of being isolated from the remainder of the premises; and
 - (ii) ý having a *floor area* not less than 10 m².
- (c) ý A vehicle reception area or garage must be provided adjacent to and with direct access to the storage room or body preparation room to ensure that the transfer of uncoffined bodies is screened from public view.
- (d) ý Access to toilet and shower facilities from any other part of the mortuary premises must be only by way of an air lock.

Tas H112.3 Construction of body preparation room

- (a) ý The floor must be-
 - (i) ý of impervious material with a smooth, unbroken surface; and
 - (ii) ý uniformly graded to a floor drain.
- (b) ý All walls and partitions must be of concrete or masonry with a smooth, unbroken finish for ease of cleaning.
- (c) ý All joints between the floor, walls, partitions, ceiling, ventilation grilles, fittings, pipework, windows and light fittings must be sealed with impervious material for ease of cleaning.
- (d) ý All joints between the floor and walls or partitions must be coved for ease of cleaning.
- (e) ý The body preparation room must be provided with at least one washbasin, fitted with elbow or foot-operated taps, and an adequate supply of hot and cold water.
- (f) ý The body preparation room must be provided with refrigerated storage facilities-
 - (i) ý with sufficient capacity for the storage of at least two adult bodies; and
 - (ii) ý capable of maintaining an internal temperature between 1° and 5°C.

Tas H112.4 Water supply and sewerage

Each mortuary with a body preparation room must be connected to-

- (a) ý a permanent water supply with a physical discontinuity between the water supply and all equipment, appliances, fittings and areas in the mortuary; and
- (b) ý a water carriage sewerage system.

After Tas Part H112 insert Tas Part H113 as follows:

TAS PART H113 FOUNDRIES

Tas H113.1 Application of Part

This Part is applicable to every building or premises in which foundry operations are undertaken as covered by *the Industrial Safety, Health and Welfare (Administrative and General) Regulations 1979*.

Tas H113.2 General

- (a) √ Every floor in a foundry must be level and, in places other than where molten metal is poured, must be composed of concrete or similar material or wooden blocks.
- (b) √ Every part of a foundry must be not less than 4.2 m high-
 - (i) √ where a ceiling is provided, measured from the floor to the ceiling; or
 - (ii) √ where a ceiling is not provided, measured from the floor to the lowest part of the roof.
- (c) √ All roof lights in a foundry must be fitted with wired glass or protected by means of wire netting fitted under the underside.

Tas H113.3 Cupola charging platform

- (a) √ The floors of cupola charging platforms must be-
 - (i) √ of heavy timber or non-slip steel plate;
 - (ii) √ securely fixed in position; and
 - (iii) √ level.
- (b) √ All parts of the cupola charging platform must be covered by a roof not less than 3 m above the platform.
- (c) √ A cupola charging platform must have-
 - (i) √ a wall, not less than 1 m high, measured from the floor of the platform, constructed to surround the platform; and
 - (ii) √ the sides between the top of the wall and the roof suitably waterproofed and ventilated.
- (d) √ A properly constructed access stair or ramp must be provided to give access to every cupola charging platform and must comply with AS 1657.

Tas H113.4 Deep moulds and pits

Deep moulds or pits, for permanent use-

- (a) √ must be lined with bricks, concrete, or other suitable material in such a manner as to provide adequate reinforcement and to keep the pit or mould in a dry condition; and
- (b) √ must be securely fenced by means of a wall of adequate construction, railings or chains and stanchions raised, in each case, to a height not less than 1 m above the surface of the surrounding floor.

Tas H113.5 Pot furnaces

Where pot furnaces are below ground level the pit must be covered by a substantial grating at the point at which metal is removed from the furnace, and must at all other points be securely fenced as in Tas H113.4(b).

After Tas Part H113 insert Tas Part H114 as follows:

TAS PART H114 ý PREMISES FOR MANUFACTURE OR PROCESSING OF GLASS REINFORCED PLASTICS

Tas H114.1 Application of Part

This Part is applicable to every building in which glass reinforced plastics are manufactured or processed as covered by the *Industrial Safety, Health and Welfare (Administrative and General) Regulations 1979*.

Tas H114.2 Separation from other buildings

A building for manufacture or processing of glass fibre plastics must be-

- (a) ý separated from other buildings or parts of an occupancy by means of impervious walls with FRL at least 120/120/120; or
- (b) ý separated from all other buildings by a clear space of not less than 6 m.

Tas H114.3 Rise in storeys

The building must be of single *storey* construction.

Tas H114.4 Maximum floor areas

The *floor area* of any building or *fire-separated section* must not exceed the relevant maximum *floor area* set out in Tas Table H114.4.

Tas TABLE H114.4 ý MAXIMUM FLOOR AREA (m²) OF BUILDINGS FOR MANUFACTURE OR PROCESSING OF GLASS REINFORCED PLASTICS OR ISOCYANATES

	Type of construction of building-		
	Type A	Type B	Type C
Not Sprinklered	1500	1200	1000
Sprinklered	6000	5000	3000

Tas H114.5 Required exits

- (a) ý Each *fire-separated section* of a building which is a work place must have at least two *exits* for escape purposes and the number and location of the *exits* must be such that any point on the floor is not be further than 20 m from one of the *exits*.
- (b) ý Only *exits* with vertically hinged swinging doors maybe considered as *exits* for the purposes of this clause.

Tas H114.6 Hand laminating and spray depositing

The walls and floors of areas to be used for hand laminating and spray depositing must be constructed of *non-combustible* materials.

Tas H114.7 Ventilation

- (a) ý Mechanical or natural ventilation must be via low-level, exhaust ducting in a wall and a fixed, open, floor-level, fresh-air inlet ducting in the opposite wall such as to ensure a cross flow of the ventilation air over the complete working area.
- (b) ý Mechanical ventilation must provide not less than 6 air changes per hour.
- (c) ý The ventilation fan and exhaust ducting must be arranged in such a manner as to-
 - (i) ý produce a negative pressure within any exhaust ducting within the work place so that a leak in the ducting will not vent exhaust air back to the work place; and

SUPERCEDED

- (ii) ý vent the exhaust air to the atmosphere so as to prevent recirculation of that exhaust air.

Tas H114.8 Smoke and heat roof vents

Each *fire-separated section* must be provided with *automatic* smoke and heat roof vents.

After Tas Part H114 insert Tas Part H115 as follows:

TAS PART H115 ý PREMISES FOR PRODUCTION OR PROCESSING OF ISOCYANATES

Tas H115.1 Application of Part ý

This Part is applicable to every building in which an isocyanate industry is undertaken as ý covered by the *Industrial Safety, Health and Welfare (Administrative and General) ý Regulations 1979*. ý

Tas H115.2 Areas of work places

Work places in which an isocyanate industry is carried on must be divided into the following divisional areas-

- (a) ý Administration and staff amenities.
- (b) ý Workshop.
- (c) ý Bulk stores.
- (d) ý Curing room.
- (e) ý Processing plant.
- (f) ý Raw materials plant.
- (g) ý Manufacture.

Tas H115.3 Separation from other areas and buildings

- (a) ý Each of the divisional areas *required* by Tas H115.2 other than the administration and staff amenities building, must be-
 - (i) ý separated from each of the other divisional areas by means of an impervious wall with FRL not less than 120/120/120; or
 - (ii) ý separated from all other buildings by a clear space of not less than 6 m.
- (b) ý Notwithstanding the distance requirements of (a) bulk stores of polyols and bulk stores of isocyanates must comply with the requirements of the *Dangerous Goods Regulations 1976*.

Tas H115.4 Rise in storeys

The building must be of single *storey* construction.

Tas H115.5 Maximum floor areas

The *floor area* of any building or *fire-separated section* must not exceed the area shown in Tas Table H114.4.

Tas H115.6 Required exits

- (a) ý Every building or divisional area of a work place must have not less than 2 *exits* for escape purposes.
- (b) ý The number and location of the *exits* must be such that any point on the floor is not more than 20 m from one of the *exits*.
- (c) ý Only *exits* with vertically hinged swinging doors may be considered as *exits* for the purposes of this clause.

SUPERCEDED

Tas H115.7 Bulk stores for polyols and isocyanates

- (a) A bulk store for polyols must be constructed from *non-combustible* materials and have a smooth impervious concrete floor and it must protect the polyols from direct exposure to the sun's radiation.
- (b) A bulk store for isocyanates must-
- (i) be constructed from *non-combustible* materials, have a smooth impervious concrete floor, and must protect the isocyanate containers from direct exposure to the sun; and
 - (ii) if it is used for storage of either TDI or HDI and is not an open sided building, be fitted with mechanical ventilation so that the TLV is not exceeded at any time provided that the ventilation must provide not less than 6 air changes and hour.
- (c) The area around both a polyol bulk store and an isocyanate bulk store must be bunded, the bund or bunds must ensure separation of the polyol and isocyanate areas and each bund must have a capacity of 10% more than the storage capacity of the largest tank it protects.

Tas H115.8 Curing room

The curing room for the storage of newly produced flexible polyurethane foam must be constructed of *non-combustible* materials with a smooth impervious concrete floor and fitted *automatic* fire vents in the roof.

After Tas Part H115 insert Tas Part H116 as follows:

TAS PART H116 PREMISES FOR ELECTRO-PLATING ELECTRO-POLISHING, ANODISING OR ETCHING

Tas H116.1 Application of Part

This Part is applicable to every building where any of the processes of electro-plating, electro-polishing, anodising or etching are undertaken, as covered by the *Industrial Safety, Health and Welfare (Administrative and General) Regulations 1979*.

Tas H116.2 Floors

The floor of every plating area must be-

- (a) so graded as to-
- (i) permit easy flushing with water; and
 - (ii) prevent liquids from flowing from the area into other parts of the work place; and
- (b) chemically resistant to the solutions used in the process.

Tas H116.3 Height of plating area

Every part of a plating area must be not less than 2.7 min height-

- (a) measured from the floor to the ceiling if a ceiling is provided; or
- (b) measured from the floor to the lowest part of the roof if a ceiling is not provided.

Tas H116.4 Air space

In every plating area there must be not less than 14 m³ of air space for each person employed and, in the calculation of such space, the height taken into account must not exceed 4.2 m.

Tas H116.5 Ceiling construction

The ceiling of a plating area must be so constructed as to prevent, so far as is practicable, atmospheric contaminants from escaping into rooms or work places, situated above the level of the ceiling.

After Tas Part H116 insert Tas Part H117 as follows:

TAS PART H117 PREMISES FOR LEAD PROCESSING

Tas H117.1 Application of Part

This Part is applicable to every building in which lead processes are used, as covered by the *Industrial Safety, Health and Welfare (Administrative and General) Regulations 1979*.

Tas H117.2 Floors

- (a) The floor of every work place where a lead process is used must be-
- (i) so constructed of concrete or other suitable material as to be smooth and impervious to fluids; and
 - (ii) graded and properly drained to permit flushing with water.
- (b) The material of which the floor is constructed must be applied to the walls to a height of not less than 75 mm in such a fashion that the angle between the walls and the floor is coved for easy cleaning.

Tas H117.3 Height of lead processing areas

Every part of a lead processing area must be not less than 2.7m in height-

- (a) where a ceiling is provided, measured from the floor to the ceiling; or
- (b) where a ceiling is not provided, measured from the floor to the lowest part of the roof.

Tas H117.4 Air space and floor space

- (a) In every lead processing area there must be not less than 14 m³ of air space for each person employed therein, and in the calculation of such space the maximum height taken must be not greater than 4.2 m; and
- (b) total floor space for the persons employed in such area, exclusive of space used for storage, must be not less than 3.3 m³ for each person so employed.

Tas H117.5 Interior of lead processing areas

- (a) The inner surfaces of the walls of every lead processing area must be of a smooth material impervious to fluids and must not contain any projections on which dust may lodge; and
- (b) the interior construction of the ceiling or roof must, so far as is practicable, be such that dust will not settle on it.

Tas H117.6 Dust collection

Any areas in which dust-forming lead materials are manipulated, moved or treated must be served by a mechanical exhaust ventilation system capable of safely and effectively collecting all dust.

Tas H117.7 Isolation of certain processes

Where any process of pasting of electric accumulator plates or drying of paste plates, or melting down of pasted plates or of formation with tacking in the electric accumulator industry or of manipulation of dry oxide of lead, is to be carried on in the same room as any other lead process, the processes of pasting, drying, melting, formation or manipulation must be isolated from one another and from any other lead process-

SUPERCEDED

- (a) ý by a partition extending from the floor to the ceiling in the case of a room having a ceiling not more than 3.6 m in height, or to a height of 2.7 m in any other case; or
- (b) ý by some other suitable method.

Tas H117.8 Drying room shelves

The racks or shelves provided in any drying room must not be more than 2.6 m from the floor nor more than 650 mm in width except that, in the case of racks or shelves set or drawn from both sides, the total width must not exceed 1.3 m.

Tas H117.9 Washing facilities

Washing facilities served with running hot and cold water for the use of all employees engaged in a lead process must be provided consisting of-

- (a) ý one washbasin for each 5 employees, or part thereof; and
- (b) ý one shower bath for each 8 employees, or part thereof.

Tas H117.10 Change rooms

In every work place in which lead is processed there must be provided two suitable furnished change rooms for the use of employees as follows-

- (a) ý one of the change rooms must be used for taking off, storing, and putting on of the street clothing of employees;
- (b) ý the other of the change rooms must be used for the taking off, storing, and putting on of overalls and other clothing worn in any work room;
- (c) ý each change room must be so constructed and situated as to prevent the entry into the room of dust or fumes generated in a workroom; and
- (d) ý each change room must be in close proximity to the washing facilities *required* in Tas H117.9.

After Tas Part H117 insert Tas Part H118 as follows:

TAS PART H118 ý BOOTHS FOR SPRAY PAINTING OR SPRAY COATING

Tas H118.1 Application of Part

This Part is applicable to every building in which spray painting or spray coating is undertaken, as covered by *the Industrial Safety, Health and Welfare (Administrative and General) Regulations 1979*.

Tas H118.2 Structure of booths

- (a) ý Booths must be constructed entirely of, or entirely lined with, metal or other suitable, durable, *non-combustible* material.
- (b) ý Floors of booths must be of even, unbroken concrete, or where this is impracticable, the floor under the booth and to a distance of at least 1 m beyond the entrance of the booth must be covered over with metal or other *non-combustible* material.
- (c) ý Windows in booths must be in fixed metal sashes and must be of wired or reinforced glass or other suitable materials.
- (d) ý The interior surfaces of booths must be smooth finished.

Tas H118.3 Emergency exits

- (a) ý Booths located in basements or in confined spaces and every room booth must be provided with an emergency *exit* situated as far as practicable from the normal means of entry to the booth.
- (b) ý No work area of a room booth must be at a distance greater than 6 m from an *exit*.

SUPERCEDED

SUPERCEDED

- (c) ý The emergency *exit* must consist of a door or panel so constructed as to be easily opened in an outward direction to permit rapid egress from the booth to a place of safety.
- (d) ý Each emergency *exit* must be marked with an *exit* sign.

Tas H118.4 Doors

- (a) ý Where swinging doors are fitted to any booth they must be made to open outwards and where sliding doors are fitted, a supplementary outward opening door for personnel must be provided, located as far as practicable from the sliding doors;
- (b) ý Roller shutter doors must not be fitted except when used as a secondary *exit* for vehicles or other large objects.

Tas H118.5 Exhaust systems

- (a) ý Each spray booth must be connected to an exhaust system.
- (b) ý Every spray booth having an internal volume more than 42 m³ and in which material having a flammable content is sprayed, must be provided with an individual exhaust duct.
- (c) ý Ducts must be extended to such a height above the eaves of the work place and the point of discharge must be so located as to prevent the discharged air from re-entering the work place.
- (d) ý Exhaust ducts must not be erected within 230 mm of *combustible* material unless effectively insulated.
- (e) ý The termination of all exhaust ducts delivering to the outside atmosphere must be protected from the detrimental effects of weather and fire hazards from any source and must be arranged so as not to constitute a nuisance in the neighbourhood.
- (f) ý The ventilation of a work room, in which a spray booth is erected, must allow free entrance of air into the booth.
- (g) ý Contaminated air from a spray booth must not infiltrate a workroom.

Tas H118.6 Ducts or flues of spray-bake booths

Ducts or flues from a gas or oil burner used in the heat exchanger of a spray-bake booth-

- (a) ý must discharge at a vertical distance not less than 2.3 m above the intake; and
- (b) ý must be insulated.

After Tas Part H118 insert Tas Part H119 as follows:

TAS PART H119 ý ELECTRICITY DISTRIBUTION SUBSTATIONS

Tas H119.1 Application of Part

This Part is applicable to every surface building type electricity distribution substation as defined in the Hydro Electric Commission's "Substation Design and Construction Manual".

Tas H119.2 Building-type substations

A building Type electricity distribution substation which complies with the building construction requirements of the Hydro-Electric Commission's "Substation Design and Construction Manual" satisfies this Part.

SUPERCEDED

After Tas Part H119 insert Tas Part H120 as follows:

TAS PART H120 ý PREMISES FOR MANUFACTURE OR STORAGE OF DANGEROUS GOODS

Tas H120.1 Application of Part

This Part applies to every building used for the manufacture or storage of explosives, flammable liquids or dangerous goods covered by the *Dangerous Goods Act 1976*.

Tas H120.2 Interpretation

The words "dangerous goods", "explosive" and "flammable liquid" have the same meaning as in the *Dangerous Goods Act 1976*.

Tas H120.3 Class of dangerous goods

The classification of dangerous goods will be as prescribed in the *Dangerous Goods Regulations 1990*.

Tas H120.4 Premises for storage of dangerous goods

Buildings for the storage of dangerous goods must comply with:

- (a) ý Class 1 explosives: AS 2187.1.
- (b) ý Class 3 flammable liquids: AS 1940.
- (c) ý Pesticides: AS 2507.
- (d) ý Liquefied petroleum gas: AS 1596.
- (e) ý Anhydrous ammonia: AS 2022.
- (f) ý Chlorine: AS 2927.
- (g) ý Organic peroxides: AS 2714.

Tas H120.5 Workroom

A workroom for industrial or commercial use of dangerous goods (other than for the use of Class 1 explosives, Class 2 flammable gas, Class 3 flammable and *combustible* liquids, or the production of power), must-

- (a) ý be located in accordance with AS 2430, Parts 1, 2 and 3, from any ignition source;
- (b) ý have all doors opening outwards;
- (c) ý have passages of escape clear of machinery or other plant; and
- (d) ý be ventilated in such a manner that air is drawn from the floor of the workroom and there is a change of air in the workroom once every 10 minutes.

Tas H120.6 Automatic sprinkler system

If *required* by the Chief Inspector of Explosives, the building must have an *automatic sprinkler system* installed in accordance with Specification E1.5.

After Tas Part H120 insert Tas Part H121, as follows:

TAS PART H121 ý HAIRDRESSERS' PREMISES

Tas H121.1 Application of Part

This Part applies to any premises registered under the *Hairdressers' Registration Act 1975*.

Tas H121.2 Size of operating section

The operating section of a hairdressers' premises must have-

- (a) ý any floor plan dimension not less than 2.5 m; and

SUPERCEDED

(b) ý a *floor area* sufficient to enable the operations to proceed without inconvenience to the operators or the customers.

Tas H121.3 Premises in a residence

A hairdressers' premises located in a residence must-

- (a) ý be isolated from the living quarters; and
- (b) ý have direct access from a public place.

Tas H121.4 Sanitary facilities

Except where sanitary facilities are available for common use, every hairdressers' premises which has more than 5 operating seats must be provided with one water closet and one washbasin for use by customers.

Tas H121.5 Lighting

Lighting of every hairdressers' premises must comply with AS 1680.

INTRODUCTION ý

This Appendix contains variations and additions to the Building Code of Australia provisions which are considered necessary for the effective application of the Code in Victoria and shall be treated as amendments to the Code.

Amendment No 1

Amendment No 1 generally reduces the number of variations published in July 1990 in order to move further towards national uniformity.

CONTENTS ý

A - GENERAL PROVISIONS

- Vic A1.1 Definitions
- Vic A3.3 Multiple classifications
- Vic Specification A1.3 Standards adopted by reference

B - STRUCTURE

- Vic B1.2 Loads
- Vic B1.3 Construction deemed-to-satisfy

C - FIRE RESISTANCE

- Vic C1.10 Early fire hazard indices
- Vic C2.1 Application
- Vic C2.12 Separation of equipment
- Vic C2.13 Electricity substations
- Vic C3.1 Application
- Vic C3.5 Doorways in fire walls
- Vic C3.6 Sliding fire doors
- Vic Specification C1.1 Fire resisting construction
- Vic Specification C1.9 Fire resistance of Class 1 and 10 buildings

D - ACCESS AND EGRESS

- Vic D1.2 Number of exits required
- Vic D1.12 Non-required stairways and escalators
- Vic D1.15 Method of measurement
- Vic D1.101 Exits from plant rooms and lift motor rooms
- Vic Table D2.13 Riser and going dimensions
- Vic D2.21 Operation of latch

E - SERVICES AND EQUIPMENT

- Vic E1.2 Fire mains and water supply

SUPERCEDED

- Vic E1.3 Fire hydrants
- Vic Table E1.5 Requirements for sprinklers
- Vic E1.7.1 Self contained smoke alarms
- Vic E2.4 Air-handling systems
- Vic Specification E1.2 Fire mains and water supply services
- Vic Specification E1.5 Fire sprinkler systems
- Vic Specification E2.101 Lift smoke lobbies

F - HEALTH AND AMENITY

- Vic F1.7.1 Waterproofing deemed-to-satisfy
- Vic Table F2.1 Provision of sanitary and other facilities in residential buildings
- Vic Table F2.3 Facilities in Class 3 to 9 buildings
- Vic F2.5 Construction of sanitary compartments
- Vic F2.101 First aid rooms
- Vic F3.101 Children's services centres - Size of rooms
- Vic F4.1 Provision of natural light
- Vic F4.5 Ventilation of rooms
- Vic F4.8 restriction on position of water closets
- Vic F4.10 Sub-floor ventilation

Vic Part F5 NOISE TRANSMISSION AND INSULATION

Vic Part F6 THERMAL INSULATION

- Vic Specification F1.7.1 Waterproofing deemed-to-satisfy

G - ANCILLARY PROVISIONS

- Vic G1.101 Children's services centres - outdoor play space
- Vic G3.6 Separation at roof

SECTION A GENERAL PROVISIONS

PART A1 INTERPRETATION

Vary A1.1 as follows:

Vic A1.1 Definitions

Add the definition of "children's services centre" as follows:

Children's services centre means a *children's services centre* registered or proposed to be registered under the Health Act 1958, being-

(a) $\dot{\gamma}$ Class I where-

- (i) $\dot{\gamma}$ children under the age of 6 years may be cared for, educated or minded for a period of no longer than 12 hours per day; or

SUPERCEDED

SUPERCEDED

- (ii) ý a pre-school kindergarten or pre-school play centre is carried on by a proprietor who receives a pre-school subsidy from the Department of Community Services; or
- (b) ý Class II where no child may be cared for, educated or minded for more than 3 hours per day and no more than 10 hours per week but does not include a *children's services centre* Class I.

Substitute the definition of "Early childhood centre" as follows:

Early childhood centre means a *children's services centre* Class I.

Substitute Clause (b) in the definition of "fire compartment" with:

Fire compartment

- (b) ý any part thereof (excluding a *fire-resisting* service shaft) separated from the remainder by walls and/or floors each having an FRL not less than that *required* for a *fire wall* for that type of construction and where any opening in the separating construction is protected in accordance with the relevant Part.

Substitute Clause (b) in the definition of "storey" with:

Storey

- (b) ý a *mezzanine* or *mezzanines* in a room provided they comply in aggregate with the lesser of the following requirements-
 - (i) ý do not exceed 1/3 of the *floor area* of the room; or
 - (ii) ý have a *floor area* not exceeding 200 m².

PART A3 ý CLASSIFICATION OF BUILDINGS AND STRUCTURES

Substitute A3.2 classification of "Class 1" buildings as follows:

Vic A3.2 Classifications

Class 1 a residential building or group of buildings comprising-

- (a) ý one *dwelling*;
- (b) ý 2 *dwellings* where the building has a *rise in storeys* not exceeding 2 and where each *dwelling* has direct egress to a road or open space; or
- (c) ý a boarding house, hostel, group house or the like with a total *floor area* not exceeding 200 m².

Add Vic A3.3(d) as follows:

Vic A3.3(d) ý Multiple classifications

- (d) ý a plant room must have the same classification as the part of the building or the remainder of the building in which it is situated, except that if the building has more than one classification, the plant room must have the classification applying to the major use of the building.

Vary Specification A1.3 Table 1 as follows:

Vic Specification A1.3 STANDARDS ADOPTED BY REFERENCE

No	Date	Title	BCA clause(s)
----	------	-------	---------------

SUPERCEDED

SUPERCEDED

Substitute reference to As 1288-1989 as follows:

AS 1288		Rules for installation of glass in buildings (SAA Glass Installation Code)	B1.3
Part 1	1979	Selection of glass	
Part 2	1979	Glazing techniques	
Part 3	1979	Unframed toughened glass assemblies	

Substitute the Note following AS 1530 as follows:

Note: Previous test reports under AS A30 Part III-1970, AS 1530.1-1984, AS 1530.2-1973, AS 1530.3-1982 with Amdt 1-1982 and Amdt 2-1983, AS 1530.4-1975 and AS 1530.4-1985 remain valid.

Substitute "AS 1904" as follows:

AS 1904	1976	Code of practice for installation of reflective foil laminate in buildings	F1.6, Vic F6.4
----------------	------	--	----------------

Substitute "AS 1926" as follows:

AS 1926	1986	Fences and gates for private swimming pools Amdt 1, March 1987	G1.1, Vic G1.101
----------------	------	---	------------------

Add in Table A1.3 additional standards as follows:

AS 2458	1982	Hardboard Amdt 1	Vic Spec F1.7.1
AS 3786	1990	Self contained smoke alarms	Vic E1.7.1
AS 2701		Methods of sampling and testing mortar for masonry construction	Vic B1.3(o)
Part 2	1984	Methods of testing	
Part 10	1984	Methods for analysis of mortars	

Timber Framing Manual

Timber Promotion Council 1980 y Vic B1.3

Timber Frame Construction in High Wind Areas - Victoria

Timber Promotion Council 1981 y Vic B1.3

Supplementary Tables

Timber Promotion Council 1988 y Vic B1.3

SECTION B STRUCTURE

PART B1 STRUCTURAL PROVISIONS

Add B1.2(c) as follows:

Vic B1.2 Loads

(c) y **Special loads-** Precast walls:

Loadbearing precast concrete walls which rely on lateral support from *structural members* not having an FRL of at least 90/-/- must after removal of that lateral support remain free-standing whilst resisting a horizontal pressure of 0.25 kPa in any direction.

Substitute B1.3(f) and (i) as follows:

Vic B1.3 Construction deemed to satisfy

(f) y **Timber construction-**

(i) y Design of timber structures to AS 1720.

SUPERCEDED

SUPERCEDED

- (ii) √ Timber structures not located in an area subject to seismic activity or snow loads, and where the design wind velocity calculated under AS 1170.2 does not exceed 33 m/s:
 - (A) √ AS 1684; or
 - (B) √ the Victorian Timber Framing Manual and Supplementary Tables published by the Timber Promotion Council.
 - (iii) √ Timber in a Class 10a building not located in an area subject seismic activity or snow loads with a *floor area* less than 60 m². CSIRO-DBC&E Special Report - Low Rise Domestic and Similar Frame Structures, Part 4 - Supplementary Domestic Buildings for Built Up Areas, Sections I to V.
 - (iv) √ Timber structures not located in an area subject to seismic activity or snow loads, and where the design wind velocity calculated under AS1170.2 exceeds 33 m/s but does not exceed 42 m/s: the Timber Promotion Council publication Timber Frame Construction in High Wind Areas - Victoria.
- (i) √ **Glass installations-**
- (i) √ AS 1288; and
 - (ii) √ in a *children's services centre* any glass panel below 750 mm from the floor must be of safety glazing material as defined in AS 1288.

Add B1.3 (n) and (o) as follows:

Vic B1.3 Construction deemed to satisfy

- (n) √ Concrete stumps deemed-to-satisfy - Notwithstanding (b) concrete stumps shall be deemed-to-satisfy if they comply with Vic Table B1.3(n) and notes.

TABLE B1.3(n) CONCRETE STUMPS - SIZES AND REINFORCEMENT

LENGTH OF STUMPS mm	MINIMUM SIZE mm	REINFORCEMENT diameter
1 - 1400	100 x 100 or 110 diameter	5 mm hard drawn wire
1401 - 1800	100 x 100 or 110 diameter	two 5 mm hard drawn wires
1801 - 3000	125 x 125 or 140 diameter	two 5 mm hard drawn wires

Notes

1. √ Concrete used must be minimum Grade 20 as defined in AS 3600.
2. √ Stumps which project above the ground more than 12 times the width of their smaller face shall be securely braced.

(o) √ **Concession for mortar mix**

- (i) √ **Proportions by volume** - notwithstanding (a), mortar for any building containing not more than 2 *storeys* may be used providing the mix is not weaker than the ratio of 1 part portland cement to 1 part hydrated lime or lime putty to 10 parts fine aggregate volume batched.
- (ii) √ **Testing** - mortar is deemed-to-satisfy (i) if the total percentage by mass of calcium oxide plus soluble silica dioxide is not less than 8.5 when-
 - (A) √ sampled in accordance with AS 2701.2; and
 - (B) √ tested in accordance with AS 2701.10.

SECTION C FIRE RESISTANCE

PART C1 FIRE RESISTANCE AND STABILITY

Substitute C1.10 as follows:

Vic C1.10 Early Fire Hazard Indices

The Early Fire Hazard Indices of materials and assemblies permanently fixed to the structure in Class 2 to 9 buildings must comply with Specification C1.10.

PART C2 COMPARTMENTATION AND SEPARATION

Substitute C2.1 as follows:

Vic C2.1 Application

This Part does not apply to a Class 1 or 10 building or to a *public carpark* provided with a *sprinkler system*, an *open-deck carpark* or to an open spectator stand.

Substitute C2.12 (a)(iii) as follows:

Vic C2.12 Separation of equipment

(iii) *ý required* stair pressurising equipment, unless it complies with AS 1668.1;

Substitute C2.13(b) as follows:

Vic C2.13 Electricity substations

(b) *ý any* doorways opening to any other part of the building must be protected with *self-closing* 120/120/30 fire doors or other *approved* doors; and

PART C3 PROTECTION OF OPENINGS

Add Vic C3.1(c) as follows:

Vic C3.1 Application of Part

(c) *ý Notwithstanding* (a)(ii) this Part applies to *required fire-resisting* spandrels and construction separating *fire compartments*.

Substitute C3.5(a) and (c) as follows:

Vic C3.5 Doorways in fire walls

(a) *ý 2* fire doors or fire shutters, one on each side of the doorway, each of which-

(i) *ý has* an FRL of not less than 1/2 that *required* by Specification C1.1 for the *fire wall* except that each door or shutter must have an insulation level of at least 30; and

(ii) *ý is self-closing*, or *automatic* with the closing operation initiated by the activation of-

(A) *ý a* smoke detector installed in accordance with AS 1670 located on each side of the *fire wall* not more than 1.5m horizontal distance from the opening; and

SUPERCEDED

- (B) ý any other *required* suitable fire alarm system, including a *sprinkler system* in either *fire compartment* separated by the *fire wall*; or
- (c) ý a single fire door or fire shutter, that is not a metallic fire shutter, which-
 - (i) ý has an FRL of not less than that *required* by Specification C1.1 for the *fire wall* except that each door or shutter must have an insulation level of at least 30; and
 - (ii) ý is *self-closing*, or *automatic* with the closing operation initiated by the activation of-
 - (A) ý a smoke detector installed in accordance with AS 1670 located on each side of the *fire wall* not more than 1.5m horizontal distance from the opening; and
 - (B) ý any other *required* suitable fire alarm system, including a *sprinkler system* in either *fire compartment* separated by the *fire wall*.

Substitute C3.6 (a) and (b) as follows:

Vic C3.6 Sliding fire doors

- (a) ý it must be held open with an electro-magnetic device which allows the door to be fully closed in not less than 20 seconds, and not more than 30 seconds, when activated by-
 - (i) ý thermal or smoke detectors as appropriate installed in accordance with AS 1905.1; and
 - (ii) ý by any other *required* suitable fire alarm system, including a *sprinkler system* installed within the building; and
- (b) ý in the event of a power failure to the door, the door must *automatically* return to the closed position in accordance with (a); and

Substitute the lead in to Clause 2.2 of Specification C1.1 as follows:

Vic Specification C1.1 ý FIRE-RESISTING CONSTRUCTION

2.2 Fire protection for a support of another part

A part of a building that gives direct vertical support to another part *required* to have an FRL, must-

Substitute Specification C1.9 as follows:

Vic Specification C1.9 ý FIRE-RESISTANCE OF CLASS 1 AND 10 BUILDINGS

1. Scope

This Specification sets out the requirements for the construction of Class 1 and 10 buildings to resist the spread of fire.

2. External walls of Class 1 buildings

- (a) ý Any part of an *external wall* of a Class 1 building that faces an *allotment* boundary must comply with Clause 3 if it is set back less than-
 - (i) ý 1 m from an *allotment* boundary other than the boundary adjoining a road alignment or other public space; or
 - (ii) ý 2 m from another building other than a Class 10 building on the same *allotment*.

SUPERCEDED

SUPERCEDED

- (b) ý The set back distance is the shortest distance measured from the external face of the *external wall* concerned.

3. Class 1 buildings - Construction of external walls

External walls referred to in Clause 2 must-

- (a) ý have an FRL of not less than 60/60/60; or
- (b) ý if the building has a *rise in storeys* of 1 or 2 - be of concrete, masonry or masonry-veneer construction in which the external masonry or concrete is not less than 90 mm thick; and have any openings protected by construction with an FRL of at least 60/60/- or *self-closing*, tight fitting, solid-core doors not less than 35 mm thick.

4. Class 10a buildings - Construction of external walls

If an *external wall* of a Class 10a building (other than an open garage) is set back less than 1 m from the *allotment* boundary, other than a road alignment or other public space, the wall that faces the *allotment* boundary must be constructed or lined with *non-combustible* material.

5. Allowable encroachments

- (a) ý Subject to sub-clause (b) the following elements may encroach into the set-back distance referred to in Clauses 2 and 4 -
- (i) ý eaves, fascias, gutters, downpipes, *non-combustible* lining of eaves and the like;
 - (ii) ý masonry chimney backs, flues, pipes, domestic fuel tanks, cooling or heating appliances or other services;
 - (iii) ý light fittings, electricity or gas meters, aerials or antennae;
 - (iv) ý pergolas or sun blinds; or
 - (v) ý unroofed terraces, landings, steps or ramps, not more than 1 m in height.
- (b) ý Elements listed in (a)(i) and (ii) must not be built within 500 mm of an *allotment* boundary or within 1m of the *external wall* or associated encroachments of another building on the same *allotment*.

6. Recladding a wall

Clause 2 does not apply to an existing *external wall* that is reclad if the recladding does not reduce the existing set back distance by more than 150 mm.

7. Common walls

A *common wall* must-

- (a) ý if it separates Class 1 buildings, or it separates a Class 1 building from a Class 10a building on another *allotment*-
- (i) ý have an FRL of not less than 90/90/90;
 - (ii) ý be of masonry or concrete construction; and
 - (iii) ý extend to the underside of a *non-combustible* roof cladding or not less than 450 mm above a roof with a *combustible* roof cladding; or
- (b) ý if it separates Class 10a buildings on different *allotments*, be constructed or lined on both sides with *non-combustible* material.

8. Internal walls separating dwellings

- (a) ý If a building has a *rise in storeys* of 1 any *internal wall* separating the *dwellings* must-
- (i) ý be of concrete or masonry, or be lined on both sides with a *fire-protective covering*; and

SUPERCEDED

SUPERCEDED

- (ii) \dot{y} extend to the underside of the roof covering or to the underside of a ceiling lined with a *fire-protective covering*.
- (b) \dot{y} If a building has a *rise in storeys* of 2 any *internal wall* separating the *dwellings* must have an FRL of not less than 60/60/60 and -
 - (i) \dot{y} if *loadbearing* be of concrete or masonry, or if *non-loadbearing* and of *lightweight construction*, comply with Specification C1.8;
 - (ii) \dot{y} not be crossed by timber purlins or other *combustible* material; and
 - (iii) \dot{y} extend to the underside of the floor next above if complying with Clause 9 or to the underside of the roof covering if it is *non-combustible* or 450 mm above the roof covering if it is *combustible*.
- (c) \dot{y} Any doorway in an *internal wall* separating *dwellings* must be protected by a *self-closing*, tight fitting, solid core door not less than 35 mm thick.

9. Separating floors

The underside of a floor separating *dwellings* must-

- (a) \dot{y} have an FRL of at least 30/30/30; or
- (b) \dot{y} be lined on the underside with a *fire-protective covering*.

10. Sarking-type materials

Any *sarking-type material* used in a Class 1 building must have a *Flammability Index* of not more than 5.

SECTION D ACCESS AND EGRESS

PART D1 PROVISION FOR ESCAPE

Add Vic D1.2(g) as follows:

Vic D1.2 Number of exits required

- (g) \dot{y} **Access to exits:** Without passing through another *sole-occupancy unit* every occupant of a *storey* or part of a *storey* must have access to-
 - (i) \dot{y} an *exit*; or
 - (ii) \dot{y} at least 2 *exits*, if 2 or more *exits* are *required*.

Delete D1.12 (b)(iv):

Vic D1.12 Non-required stairways, ramps or escalators

Delete (b)(iv).

Add Vic D1.15(h) as follows:

Vic D1.15 Method of measurement

- (h) \dot{y} In the case of a non *fire-isolated stairway* or ramp the distance is measured along a line connecting the nosings of the treads, or the slope of the ramp, together with the distance connecting those lines across any intermediate landings.

SUPERCEDED

Add Vic D1.101 as follows:

Vic D1.101 Exits from plant rooms and lift motor rooms

- (a) \dot{y} Except as provided in (b), any room containing plant and equipment, including those referred to in C2.12 and C2.13, must be provided with *exits* in accordance with this Part for the classification which occupies the major part of the building.
- (b) \dot{y} Every plant room and lift motor room that is located on or above the main roof level of the building, below the lowest *storey* of the building or as an intermediate floor within a *storey* must have two *exits*, one of which must be fire-isolated, except if the room or group of rooms has a *floor area* not exceeding -
 - (i) \dot{y} 100 m² - the non-*fire-isolated exit* may be a ladder; or
 - (ii) \dot{y} 50 m² - both *exits* may be non-*fire-isolated*, one of which may be a ladder; or
 - (iii) \dot{y} 25 m² - a single *exit* may be provided and that *exit* may be a ladder.

PART D2 CONSTRUCTION OF EXITS

Substitute the dimensions for public and private stairs in Table D2.13 as follows:

Vic Table D2.13 RISER AND GOING DIMENSIONS

	RISER (R) \dot{y}		GOING (G) ^(b)		QUANTITY(2R+G)	
	Max	Min	Max	Min	Max	Min
Public stairs	190	115	355	250	700	550 \dot{y}
Private stairs ^(a)	190	115	355	240	700	550 \dot{y}

Substitute the lead in to D2.21 as follows:

Vic D2.21 Operation of latch

A door in a *required exit*, forming part of a *required exit* or in the path of travel to a *required exit* must be readily openable without a key from the side that would face a person seeking egress by a single hand action on a single device which is located between 900 mm and 1.2 m above the floor (except if it is the *exit* door from a *children's services centre* Class I in which case the latch may be located between 1.5 m and 1.65 m from the floor) unless-

SECTION E SERVICES AND EQUIPMENT

PART E1 FIRE FIGHTING EQUIPMENT

Substitute E1.2(e)(ii) and add (g) as follows:

Vic E1.2 Fire mains and water supply services

- (e) \dot{y} (ii) more than 6 *hydrants* are *required*; or
- (g) \dot{y} when connected to more than 6 *hydrants* or a *sprinkler system* be provided with installation control valves and where *required* such valves must be-
 - (i) \dot{y} strapped and locked in the open position;
 - (ii) \dot{y} marked to identify the purpose of each valve; and
 - (iii) \dot{y} where provided connected to any supervisory circuit or fire indicator panel.

SUPERCEDED

Substitute E1.3 (c) as follows:

Vic E1.3 Fire hydrants

(c) *Required hydrants*, except those provided for in E1.3(a)(i) and (ii), must be located so that every point on the floor is within a 6 m spray of water from the nozzle end of a fully extended 30 m length of hose.

Substitute Table E1.5 as follows:

Table E1.5 REQUIREMENTS FOR SPRINKLERS

OCCUPANCY <i>ý</i>	WHEN SPRINKLERS ARE REQUIRED
Class 6 <i>ý</i>	In <i>fire compartments</i> with- (a) a <i>floor area</i> of more than 3500 m ² ; or (b) a volume of more than 21 000 m ³
All Classes <i>ý</i>	In buildings more than 25 m in <i>effective height</i>
Carparks , other than <i>open deck carparks</i>	(a) If accommodating more than 40 vehicles; or (b) If incorporating structural steel members with an FRL less than 60/-/-.
Note: <i>Sprinkler systems</i> are also <i>required</i> under Parts: (a) <i>ý</i> H1 - for theatres, stages and public halls; (b) <i>ý</i> G3 - for <i>atriums</i> ; and (c) <i>ý</i> C2 - in C2.3 for large isolated buildings.	

Add after E1.7 as follows:

Vic E1.7.1 Self contained smoke alarms

- (a) *ý* Self-contained smoke alarms complying with the requirements of AS 3786 must be installed in every-
- (i) *ý* Class 1, 2 or 4 *dwelling*; and
 - (ii) Class 3 building that is not *required* to comply with E1.7(b), *ý* on which *building work* is carried out. *ý*
- (b) *ý* Self-contained smoke alarms must be installed on or near the ceiling and be located-
- (i) *ý* between each area containing bedrooms and the remainder of the *dwelling* and where the bedrooms are served by a hallway, the self-contained smoke alarm must be located in that hallway; and
 - (ii) *ý* on each *storey*.
- (c) *ý* A *required* self-contained smoke alarm must be connected directly to the mains power and have a standby power supply in every new building.
- (d) *ý* The owner shall be responsible for the maintenance of self contained smoke alarms installed in *dwelling*s and residential buildings.

PART E2 SMOKE CONTROL

Add Vic E2.4(c) as follows:

Vic E2.4 Air-handling systems

- (c) *ý* In buildings having an *effective height* of more than 25 m must operate-
- (i) *ý* in accordance with AS1668.1; or
 - (ii) *ý* in accordance with AS1668.1 provided that a lift smoke lobby complying with Vic Specification E2.101 and connecting the lifts and one *fire-isolated stairway* is provided on every *storey* except-

SUPERCEDED

SUPERCEDED

- (A) ý a *storey* that is an *open-deck carpark*; and
- (B) ý on the ground floor provided that any tenancy is smoke separated from the lift lobby.

Add 2(c) and substitute 3(b) in Specification E1.2 as follows:

Vic Specification E1.2 FIRE MAINS AND WATER SUPPLY SERVICES

2. General requirements

- (c) ý not incorporate plastic pipes above ground.

3. Fixed on-site fire pumps

- (b) ý if in a building or within 6 m of any building, be located in a room or enclosure which has an FRL of not less than 120/120/60 and has direct egress to a road or open space and with *exit* doors in accordance with Specification E1.8.

Substitute Specification E1.5 Clause 3 as follows:

Vic Specification E1.5 FIRE SPRINKLER SYSTEMS

3. Provisions of AS 2118 not to apply

- (a) ý The following provisions of AS 2118 do not apply-
 - (i) ý Clause 1.2.20 - definition of "fire door".
 - (ii) ý Clause 3.6 - "Maintenance".
- (b) ý In Clause 3.3.2 of AS 2118 - substitute 3 m for 10 m.

Add Specification E2.101 as follows:

Vic Specification E2.101 LIFT SMOKE LOBBIES

1. Scope

This Specification sets out requirements for lift smoke lobbies *required* by Vic E2.4 sub-clause c(ii).

2. Access

The lift smoke lobby must be accessible to all occupants of the floor at all times.

3. Walls

The walls bounding the lift smoke lobby must-

- (a) ý be smoke-proof; and
- (b) ý extend to the underside of the structural floor above; or
- (c) ý to the underside of a *non-combustible* imperforate ceiling having *non-combustible* supports.

4. Doors

Every doorway to the lift smoke lobby must-

- (a) ý be fitted with a smoke door complying with Clause 3 of Specification C3.4; and
- (b) ý not extend on the occupied side to within 100 mm of the structural floor above or false ceiling whichever is the lesser.

5. Other openings

Any other opening into the lift smoke lobby must be smoke-proof.

SUPERCEDED

SECTION F $\dot{\gamma}$ HEALTH AND AMENITY

Objectives

Delete the objectives to Part F5.

Add the objectives to Part F6 as follows:

Vic F6 Thermal Insulation

A reasonable level of thermal insulation must be provided to conserve energy used for internal heating and cooling of residential buildings.

PART F1 DAMP AND WEATHERPROOFING

Insert Vic F1.7.1

Vic F1.7.1 Waterproofing deemed-to-satisfy

Construction satisfies F1.7 if it complies with Vic Specification F1.7.1.

PART F2 SANITARY AND OTHER FACILITIES

Substitute paragraph (c) of requirements for Class 1 buildings in Table F2.1 with:

Vic Table F2.1 $\dot{\gamma}$ PROVISION OF SANITARY AND OTHER FACILITIES IN RESIDENTIAL BUILDINGS

CLASS OF BUILDING	MINIMUM FACILITIES REQUIRED
Class 1	(c) Except in a single <i>dwelling</i> constructed under section 18 of the <i>Housing Act 1983</i> , clothes washing facilities, comprising at least one wash-tub and space in the same room for a washing machine or wash copper; and.

Add note to Table F2.3 as follows:

Vic Table F2.3 $\dot{\gamma}$ FACILITIES IN CLASS 3 TO 9 BUILDINGS

Class 9b <i>Early childhood centres</i>	Note: Closet fixtures for use by children must be- (i) junior pans; and (ii) wash basins with a rim height not exceeding 600 mm.
---	--

Add F2.5(c) as follows:

Vic F2.5 Construction of sanitary compartments

(c) $\dot{\gamma}$ **Partitions in children's services centres** - Closet fixtures situated in a group for use by children in a *children's services centre* Class I must be separated from one another by means of partitions extending from between 150 mm to 250 mm above the floor to a height of not less than 900 mm or more than 1.5 m.

Add Vic F2.101 as follows:

Vic F2.101 First aid rooms

(a) $\dot{\gamma}$ If an *assembly building* or an open spectator stand accommodates more than 5000 spectators at an arena, sportsground, showground, racecourse, cricket ground, football ground, coursing ground, motor racing arena, or the like, a suitable room or rooms must be provided in accordance with Table F2.101 for use by para-medical attendants for first aid purposes.

Table F2.101 FIRST AID ROOMS ý

Spectator Capacity	Number of Rooms
5001 - 10 000	1
10 001 - 15 000	2
15 001 - 30 000	3
30 001 - 45 000	4
45 001 - 60 000	5
60 001 - 75 000	6
75 001 - 90 000	7
90 001 - 105 000	8

(b) ý **Conditions:** First aid rooms *required* by (a) must-

- (i) ý be distributed as uniformly as possible throughout the *assembly building* or open spectator stand; and
- (ii) be convenient to a public road; and
- (iii) be readily accessible from within and outside the arena or ground; and
- (iv) have a *floor area* of not less than 24 m²; and
- (v) ý be provided with a suitable wash basin or sink.

PART F3 ROOM SIZES

Add Vic F3.101 as follows:

Vic F3.101 Children's services centres - size of rooms

A *children's services centre* Class I must have a *floor area* allowing a clear space of at least 3.3 m² for each child using that room.

PART F4 LIGHT AND VENTILATION

Substitute F4.1(d) as follows:

Vic F4.1 Provision of natural light

(d) ý **Class 9b buildings** - to all general purpose classrooms in primary or secondary schools and all playrooms or the like for the use of children in *children's services centres*.

Add F4.5 (b)(iii) as follows:

Vic F4.5 Ventilation of rooms

(b) ý (iii) in the case of a *sanitary compartment* in a Class 1, 2, 3 or 4 building a fan extracting air through each water closet and cistern at a rate of not less than 10 m³/hr/closet.

Substitute F4.8(d) as follows:

Vic F4.8 Restriction on position of water closets and urinals

(d) ý a room used for public assembly, except a room in a *children's services centre*; or

Substitute F4.10(b)(i) as follows:

Vic F4.10 Sub-floor ventilation

- (b) ý (i) the sub-floor space has a minimum depth of 150 mm in every part and the walls forming the base structure are cross-ventilated by means of evenly distributed openings having an unobstructed area of not less than-
 - (A) ý 7300 mm²/m for the *external walls*; and
 - (B) ý 22000 mm²/m for the *internal walls*.

Delete Part F5:

VIC PART F5 NOISE TRANSMISSION AND INSULATION

Delete Part F5.

Add Part F6 as follows:

VIC PART F6 THERMAL INSULATION

F6.1 Application

This Part applies to Class 1, 2 and 3 buildings.

F6.2 Provision of thermal insulation

- (a) ý **R values** - In this Part "R" or "R value" means the thermal resistance of an element of the building measured in m².K/W.
- (b) ý **Performance requirement** - Residential buildings must have a reasonable level of thermal insulation to conserve energy used for internal heating and cooling.
- (c) ý **Deemed-to-satisfy provisions** - Compliance with all elements of option A or all elements of option B of Table F6.1 is deemed-to-satisfy the performance requirement.

Table F6.1 MINIMUM OVERALL R VALUE

ELEMENT ý	OPTION A	OPTION B
Roof or ceiling	R2.2	R2.2
External walls	R1.3	R1.7
Ground Floor	R1.0	R0.4

- (d) ý **Deemed "R Values"** - An element described in column 1 of Table F6.2 is deemed to have the R value adjacent to it in column 2.

Table F6.2 R VALUES FOR COMMON ELEMENTS

DESCRIPTION OF ELEMENT col 1	R VALUE col 2
Roofs or ceilings	
Tiled pitched roof, R2.5 bulk insulation between ceiling joists, lined ceiling ý	R2.4
Tiled pitched roof, foil sarking over rafters, R2.0 bulk insulation between ceiling joists, lined ceiling	R2.2
Metal deck roof, foil sarking, 20 mm air gap, R2.0 bulk insulation installed between joists/beams, ceiling lining on underside of joists/beams	R2.2
External walls	
Brick/masonry veneer with double sided reflective foil laminate fixed to external face of studs, lined internally	R1.3
Brick/masonry veneer with R1.5 bulk insulation between the studs, lined internally	R1.7
Brick/masonry veneer with R1.0 foam board fixed over the face of the studs, lined internally	R1.7

SUPERCEDED

Weatherboard/fibre-cement, double sided reflective foil laminate dished between studs lined internally	R1.3
Weatherboard/fibre cement cladding, R1.5 bulk insulation between studs, lined internally	R1.7
Cavity brick with R1.0 foam board in cavity	R1.7
Floors	
Concrete/masonry on ground	R1.5
Timber framed floor open around perimeter	R0.4
Timber framed floor, enclosed perimeter reflective foil laminate dished between joists	R1.0

(e) **Exemptions** - The requirements of this Part do not apply to the following types of construction:

- (i) cavity brick, earthwall construction, ashlar stone or other masonry walls which have a thickness (excluding any cavity) of not less than 180mm if the floor of the building is concrete or masonry in direct contact with the ground;
- (ii) windows, vents and other similar openings in walls, roofs and ceilings; or
- (iii) a garage forming part of a Class 1, 2 or 3 building which is separated from the *habitable rooms* of the building by a wall complying with the requirements for an *external wall* in Table F6.1.

F6.3 Chimneys and flues

Chimneys and flues from open solid fuel-burning appliances must be provided with a damper or flap.

F6.4 Installation of reflective foil laminate

Installation of reflective foil laminate must comply with AS1904.

Add Vic Specification F1.7.1

Vic Specification F1.7.1 WATERPROOFING DEEMED-TO-SATISFY

1. Scope

The following Specification describes construction and materials which satisfy the requirements of F1.7.

2. General requirements - shower bases

The shower base satisfies F1.7(a) if -

- (a) it is provided with a waste outlet not less than 50 mm below the adjacent floor level or, if a kerb is provided at the entry to the shower, not less than 50mm below the top of such kerb;
- (b) it is graded at not less than 1 in 60 towards the waste outlet;
- (c) it is provided on every side, other than at the entry into the shower, with a kerb not less than 50 mm in thickness and 75 mm in height and not less than 25 mm above the floor level at the entry into the shower; and
- (d) where an impervious wall sheeting is to be used, every kerb of the base is rebated to provide an overlap of the sheeting of not less than 19 mm.

3. Shower base cast in-situ

A shower base constructed in-situ satisfies Clause F1.7(a) if the base is constructed as part of a concrete floor slab and -

- (a) is cast monolithic with the floor slab, except that any projecting kerb may be separately cast if it is poured on to a bonding agent covering the whole area of the interface;

SUPERCEDED

- (b) \acute{y} has a base slab not less than 100 mm thick;
- (c) \acute{y} is so constructed that the adjacent floor slab reinforcement is extended continuously through the concrete base slab of the shower base; and
- (d) \acute{y} has the point of entry into the shower not less than 25 mm above the highest point of the floor of the base or the entire room is graded to the shower waste.

4. Shower base not cast in-situ

A shower base not cast in-situ satisfies F1.7(a) if it is -

- (a) \acute{y} constructed of concrete not less than 100 mm thick, with integral kerbs; and
- (b) \acute{y} separate from and not bonded to the building structure.

5. Flooring

A flooring system satisfies Clause F1.7(b) if it is constructed of -

- (a) \acute{y} ceramic tiles bonded to cement sheet sealed at the joints; or
- (b) \acute{y} vinyl tiles, sheet vinyl, sheet rubber or linoleum on either cement sheet or standard hardboard, type RD complying with AS 2458 sealed at the joints.

6. Walls

A wall satisfies Clause F1.7(d) if it is finished with fully-compressed fibre-cement, waterproof cement render, ceramic tiles bonded to cement sheet or water-resistant plasterboard sealed at the joints, or other impervious finish.

SECTION G ANCILLARY PROVISIONS

PART G1 MINOR STRUCTURES AND COMPONENTS

Add Vic G1.101 as follows:

Vic G1.101 Children's services centres - outdoor play space

Any outdoor play space in a *children's services centre* must be enclosed on all sides with fences or barriers at least 1.5 m high measured from ground level, with any gates and fittings complying with AS 1926.

PART G3 ATRIUM CONSTRUCTION

Substitute G3.6 as follows:

Vic G3.6 Separation at roof

The roof of an *atrium* need not have the FRL described in Specification C1.1 if -

- (a) \acute{y} no part of the building or an adjacent building is within 3 m of the *atrium* and higher than the *atrium* roof;
- (b) \acute{y} any part of the building or an adjacent building is higher than the *atrium* and within 6 m vertically and 3 m horizontally of the *atrium* roof and-
 - (i) \acute{y} that part has an FRL of not less than 120/120/120; and
 - (ii) \acute{y} any opening in that part is protected in accordance with C3.4; or
- (c) the roof structure and membrane is protected by a *sprinkler system*.

INTRODUCTION

This Appendix contains variations and additions to the BCA provisions which are considered necessary for the effective application of the Code in Western Australia and shall be treated as amendments to the Code.

Where a variation or addition has been made to the BCA, the relevant clause number may be noted by means of "flagging" in the column adjacent to the affected BCA clause.

Reference should then be made to the appropriate clause in this Appendix to determine any particular requirements for Western Australia.

CONTENTS

A - GENERAL PROVISIONS

WA Specification A1.3 Standards Adopted by Reference.

B - STRUCTURE

WA B1.3(i) Footings

WA B1.3(o) Earth wall construction

WA B1.3(p) Seismic construction: Class 1 buildings

WA Specification B1.3.1 Earth Wall Construction.

WA Specification B1.3.2 Seismic Construction- Class 1 Buildings.

C - FIRE RESISTANCE

WA C2.12 Separation of equipment

WA C3.9 Service penetrations in fire-isolated exits

D - ACCESS AND EGRESS

WA D1.3 When fire-isolated exits are required

WA D1.4 Exit travel distances

WA D1.12 Non-required stairways, ramps or escalators

WA D2.1 Application of Part

WA D2.7 Installations in exits and paths of travel

WA D2.16 Balustrades

WA D2.19 Doorways and doors

WA D3.2 Access for people with disabilities

WA D3.3 Parts of buildings to be accessible

WA D3.4 Concessions

E - SERVICES AND EQUIPMENT ý

WA E1.3	Fire hydrants
WA E2.2	Exclusion of smoke from fire-isolated exits
WA E2.4	Air-handling systems
WA E2.5	Roof vents
WA E2.7	Pressurisation
WA E3.4	Emergency lifts
WA Specification E1.2	Fire mains and water supply services. ý
WA Specification E1.8	Fire Emergency Control Centres. ý
WA Specification E2.4	Mechanical Smoke Control in Multi-storey Buildings. ý
WA Specification E2.6	Smoke Exhaust Systems. ý

F - HEALTH AND AMENITY

WA F2.4	Facilities for people with disabilities
WA F2.5	Construction of sanitary compartments
WA F4.4	Artificial lighting
WA F4.12	Reflective glazing
WA F5.3	Sound insulation of floors between units

G - ANCILLARY PROVISIONS

WA G1.1	Swimming pools ý
WA Specification G3.8	Fire and Smoke Control Systems in Atrium Buildings. ý

SECTION A GENERAL PROVISIONS ý**PART A1 INTERPRETATION**

Insert the following heading for Specification A1.3:

WA Specification A1.3 STANDARDS ADOPTED BY REFERENCE

In Table 1 of Specification A1.3, insert the following standards:

WA TABLE 1 SCHEDULE OF REFERENCED DOCUMENTS ý			
No	Date	Title ý	BCA Clause(s)
AS 1680	1976 ý	Code of practice for interior lighting and the visual environment	WA F4.4
BS 336 ý		Fire hose couplings and ancillary equipment	WA E1.3

SECTION B STRUCTURE

PART B1 STRUCTURAL PROVISIONS

Delete B1.3(g) and (m), and insert WA B1.3(m) and (n) as follows:

WA B1.3 Construction deemed-to-satisfy

(g) *ý* (deleted).

(m) *ý* **Earthwall construction:** WA Specification B1.3(m).

(n) *ý* **Seismic construction:** Class 1 buildings: WA Specification B1.3(n).

After Part B2, insert WA Specification B1.3(m) as follows:

WA Specification B1.3(m) EARTH WALL CONSTRUCTION

1. Scope

This Specification contains the requirements for *earth-wall construction*.

2. Definitions

For the purpose of this Specification: *ý*

Adobe construction means a type of construction using blocks of sun dried mud. *ý*

Bulletin 5 means CSIRO-NBTC Bulletin 5 Earth Wall Construction 4th Edition 1987. *ý*

Earth-wall construction means *adobe construction, mechanically pressed-soil block *ý* construction or rammed-earth construction*.

Mechanically pressed-soil block construction means a type of construction using blocks produced by pressed block making machines.

Rammed-earth construction means a type of construction in which damp earth is tamped in situ between temporary movable framework.

Terrain Category followed by a designation, refers to the terrain category so designated in AS 1170.2.

3. Not permitted in certain places

A building must not be of *earth-wall construction* if-

- (a) *ý* it is situated on a *site* that is subject to flooding; or
- (b) *ý* it is situated in a seismic zone as defined by the Regulations unless it has been designed in accordance with A2.2.

4. Construction generally

(a) *ý* A building of *earth-wall construction* must be constructed in accordance with the recommendations contained in *Bulletin 5* except where varied by this Specification.

(b) *ý* A building of *earth-wall construction* must not exceed two *storeys* in height and walls must be laterally restrained at intermediate floor level.

5. Sample of test results may be required

Prior to and during construction, Council may require-

- (a) *ý* in the case of-

SUPERCEDED

- (i) *rammed-earth construction* - a sample panel at least 900 mm long by 900 mm high;
 - (ii) *adobe construction* - a sample comprising of a least 3 blocks, made of the materials and by the methods to be used in the construction, to be provided for inspection on the *site*; and
- (b) *in the case of mechanically pressed-soil block construction* - the submission to it of the results of tests, conducted in accordance with Appendix E of *Bulletin 5*, made on blocks of the kind to be used in the construction after they have been moist cured for seven days.

6. Minimum thickness of walls

In a building of *earth-wall construction*, the thickness of a wall must be-

(a) *In the case of adobe construction or rammed-earth construction-*

- (i) *for an external wall*, not less than 250 mm; and
- (ii) *for an internal wall*, not less than 200 mm;

(b) *In the case of mechanically pressed-soil block construction-*

- (i) *for an external wall*, not less than 250 mm; and
- (ii) *for an internal wall*, not less than 150 mm.

7. Protection

Every building of *earth-wall construction-*

- (a) *must be provided with a suitable means of protection to prevent water from the roof running down the face of every wall; and*
- (b) *must, except in the case illustrated in Figure 1.3 of Bulletin 5, have the ground adjacent to the walls so graded and paved as to prevent any surface water from reaching those walls.*

After WA Specification B1.3(m), insert WA Specification B1.3(n) as follows:

WA Specification B1.3(n) *SEISMIC CONSTRUCTION - CLASS 1 BUILDINGS*

1. Scope

This Specification contains the requirements for Class 1 buildings in seismic zones as defined by the Building Regulations.

2. Interpretation

In this Specification-

- (a) **Timber framing connector** means a manufactured connector system for timber joints formed from 1.2 mm galvanised steel and prepunched to take nails; and
- (b) **Zone** means a seismic zone as defined by the Building Regulations.

3. Construction in Zone A

In Zone A every building exceeding 4 storeys in height must be designed by a *professional engineer* and comply with AS 2121.

4. Construction in Zone 1

In Zone 1:

- (a) ŷ Un-reinforced masonry must-
 - (i) ŷ comply with Table 4 or be designed by a *professional engineer*, and
 - (ii) ŷ not incorporate overhanging ornamentations, parapets or free-standing masonry chimneys.
- (b) ŷ *Structural members* must-
 - (i) ŷ be designed by a structural engineer; or
 - (ii) ŷ where a building does not exceed 1 *storey* in height and has a roof covering of other than concrete tiles or terracotta tiles, the *structural members* must comply with paragraph 1 of Table 4.

**TABLE 4 ŷ SINGLE STOREY RESIDENTIAL BUILDINGS IN ZONE 1
WITHOUT CONCRETE TILE OR TERRACOTTA TILE ROOF -
ALTERNATIVE DESIGN AND CONSTRUCTION**

1. ŷ Foundations and Footings

- (a) ŷ Stumps supporting framed structures must be of steel, timber or reinforced concrete and stumps with an out of the ground length exceeding 650 mm must be braced.
- (b) ŷ Floor beams must be fixed to the top of stumps with two 10 mm diameter bolts or the equivalent thereof.
- (c) ŷ Corner stumps must be braced in two directions and where a building dimension exceeds 10 m in length or width, intermediate bracing must be used at 10 m maximum centres.
- (d) ŷ The bottom plates of framed structures must be fixed to a concrete raft or strip footing with M 10 bolts or masonry anchors at 1 800 mm maximum centres.
- (e) ŷ Concrete strip footings must be continuously reinforced with two layers of reinforcement comprising two 12 mm diameter bars (Grade 410C or 410Y) per layer and tied with R6 ligatures at centres not exceeding 2.5 times the depth of the footing.
- (f) ŷ A raft incorporating a monolithic edge beam is deemed-to-satisfy (e).

2. ŷ Framed Wall Construction

- (a) ŷ Where metal framing is used:
 - (i) ŷ The framing must conform with AS 1538 or AS 1664, and must be braced, noggged and fixed together using welding or equivalent in strength using self tapping screws or bolts.
 - (ii) ŷ Wall plates must be continuous between cross walls or spliced so that no loss of strength occurs.
 - (iii) ŷ Material used in walls, other than bracing, must not be less than 1.2 mm in thickness.
- (b) ŷ Where timber framing is used:
 - (i) ŷ The framing must be fixed together by the use of timber framing connectors nailed with a minimum of three 2.8 mm diameter x 30 mm long nails to each fixing plate of the connector or if of seasoned timber, may be alternatively fixed with two 2.8 mm diameter nails, machine nailed through the top or bottom plate into the stud.
 - (ii) ŷ Wall plates must be continuous between cross walls or spliced so that no loss of strength occurs.

3. ŷ Masonry Construction

Where masonry construction is used:

- (a) ŷ Internal or *external walls* must not exceed 4 m in length unless stiffened by means of cross walls or by columns or bracing designed by a practising structural engineer.
- (b) ŷ Cross walls must be tied to the internal leaf of cavity walls by fully bonding or by metal ties at every second course.
- (c) ŷ Mortar must be at least as strong as a 1:1:6 mortar and the masonry units to have good mortar adherence properties and bricks must be laid on a full bed of mortar with cross joints properly filled.

SUPERCEDED

- (d) Both leaves of all external masonry walls must be reinforced with two R6 bars (Grade 230), or two 3.15 mm diameter bars (Grade 450), in the course immediately under *window* sills and over door and *window* heads.
- (e) Reinforcement must extend a minimum of 300 mm beyond the supporting cross walls or columns and reinforcement to external leaf must be galvanised.
- (f) Continuous reinforced brick bond beams, comprising two R6 bars (Grade 230), or two 3.15 mm diameter bars (Grade 450), in each of the top three bed joints, must be constructed-
 - (i) in every case, on the internal leaf of all *external walls* and on all cross walls; and
 - (ii) where the roof is pitched on the external leaf of the *external walls*, on that external leaf.
- (g) Cross wall reinforcement must be turned and lapped 300 mm into the *external walls*.
- (h) Splices in reinforcement must not be less than 300 mm.
- (i) The top two courses of all *internal walls* and of the internal leaf of all *external walls* must be constructed of bricks that contain no perforations.

4. Veneer on Framed Construction

Where veneer on framed construction is used:

- (a) Only veneers comprising an external skin of masonry and internal partitions of timber or metal framing may be used.
- (b) The veneer must be fixed in accordance with AS 1640.

5. Roof Construction

- (a) The roof structure must be braced so that all horizontal loads are transferred directly to the cross walls.
- (b) The roof framing must be fixed to the wall top plate by the use of timber framing connectors nailed with a minimum of three 2.8 mm diameter x 30 mm long nails to each fixing plate of the connector.
- (c) Where the walls are of masonry construction all top plates must be connected to the walls by masonry anchors, or equivalent fixing a maximum of 1 800 mm centres, and every such fixing must be fixed into the second top course.

5. Construction in Zone 2

In Zone 2:

- (a) Buildings of reinforced masonry must-
 - (i) be designed by a professional engineer; and
 - (ii) un-reinforced masonry, overhanging ornamentations, parapets and free-standing chimneys are prohibited.
- (b) *Structural members* of every building must be designed by a *professional engineer*, but where it is-
 - (i) not of masonry construction; and
 - (ii) has a roof of other than concrete tiles or terracotta tiles; and
 - (iii) does not exceed one *storey* in height, it may be designed by a *professional engineer* or comply with Table 5.

TABLE 5 SINGLE STOREY RESIDENTIAL BUILDINGS IN ZONE 2 WITHOUT CONCRETE TILE OR TERRACOTTA TILE ROOF AND NOT OF MASONRY CONSTRUCTION - ALTERNATIVE DESIGN AND CONSTRUCTION

1. Foundations and Footings

SUPERCEDED

- (a) Stumps supporting framed structures must be of steel, timber or reinforced concrete and stumps with an out of the ground length exceeding 500 mm must be braced.
- (b) Floor beams must be fixed to the top of stumps with two M10 bolts or the equivalent thereof.
- (c) Corner stumps must be braced in two directions and where a building dimension exceeds 8 m in length or width intermediate bracing must be provided at 8 m maximum centres.
- (d) The bottom plate of framed structures must be fixed to a concrete raft or strip footing with M 10 bolts or masonry anchors at 1 200 mm maximum centres.
- (e) Concrete strip footings must be continuously reinforced with two layers of reinforcement comprising two 12 mm diameter bars (Grade 410C or 410Y) per layer and tied with R6 ligatures at centres not exceeding 2.5 times the depth of the footing.
- (f) A raft incorporating a monolithic edge beam is deemed-to-satisfy (e).

2. Framed Wall Construction

- (a) Where metal framing is used:
 - (i) The framing must conform to AS1538 or AS1664, and must be braced, nogged and fixed together using welding or the equivalent in strength using self tapping screws or bolts.
 - (ii) Wall plates must be continuous between cross walls or spliced so that no loss of strength occurs.
 - (iii) Material used in walls other than bracing must not be less than 1.2 mm in thickness.
- (b) Where timber framing is used:
 - (i) The framing must be fixed together by the use of timber framing connectors nailed with a minimum of three 2.8 mm diameter x 30 mm long nails to each fixing plate of the connector or if of seasoned timber, may be alternatively fixed with two 2.8 mm diameter nails, machine nailed through the top or bottom plate into the stud.
 - (ii) Wall plates must be continuous between cross walls or spliced so that no loss of strength occurs.

3. Veneer on Framed Construction

- (a) Where veneer on framed construction is used-
 - (i) Only veneers comprising an external skin of masonry and internal partitions of timber or metal framing may be used.
 - (ii) The veneer must be fixed in accordance with AS 1640.
 - (iii) The top plate to the external frame must be continuous between internal cross walls supporting the external frame against lateral loads.
- (b) Where timber framing is used-
 - (i) Top plates must be of F8 grade timber not less in size than 75 mm x 50 mm and must be continuous between internal cross walls.
 - (ii) Supporting internal cross walls must be spaced not more than 4 m apart, except that where top plates of F8 grade timber not less in size than 100 mm x 50 mm are used cross walls may be spaced at a maximum of 4.8m.
 - (iii) The *external walls* must be fixed to supporting internal cross walls at or near top plate level, by at least two framing anchors with not less than three 2.8mm diameter nails to each tab of the framing anchor, or by bolting the frames together using a bolt of a size not less than M10 or the equivalent thereof.
- (c) Where metal framing is used-
 - (i) Top plates must be continuous between supporting internal cross walls, and for spans not exceeding 5.5 m between supporting cross walls the top plate must not be less in size than 78 mm x 31 mm x 1.2 mm or such other size as is approved, and, where the span exceeds 3.5 m, must be reinforced by a stiffened top plate not less in size than 75 mm x 79 mm x 1.6 mm or such other size as is approved;
 - (ii) The *external walls* must be fixed to the internal supporting walls at or near top plate level, by at least two framing anchors or by bolting using a bolt of a size not less than M10 or the equivalent thereof.

SUPERCEDED

SUPERCEDED

- (d) √ A 100 mm x 100 mm galvanised steel mesh secured to the outside of the timber or steel frame must be used on all *external walls* to which masonry veneer is attached;
- (e) √ Masonry veneer must not to be constructed over any openings or in any gable.

4. √ Roof Construction

- (a) √ The roof structure must be braced so that all horizontal loads are transferred directly to the cross walls.
 - (b) √ The roof framing must be fixed to the wall top plate by the use of timber framing connectors nailed with a minimum of three 2.8 mm diameter x 30 mm long nails to each fixing plate of the connector.
-

6. Free standing masonry walls

Free standing masonry walls exceeding 1.2 m in height must not be constructed in Zone 1 or Zone 2 unless designed by a *professional engineer* to resist seismic loads.

PART C2 COMPARTMENTATION AND SEPARATION

Delete C2.12 and insert WA C2.12 as follows:

WA C2.12 Separation of equipment

- (a) √ Equipment other than that described in (b) must be isolated by walls and a floor having an FRL of not less than 120/120/120 if that equipment comprises-
 - (i) √ lift motors and lift control panels;
 - (ii) √ the main electrical switchboard in a building and it serves emergency equipment;
 - (iii) √ *required* stair pressurising equipment;
 - (iv) √ emergency generators or central smoke control plant;
 - (v) √ boilers;
 - (vi) √ batteries; or
 - (vii) √ sprinkler valve equipment.
- (b) √ Equipment need not comply with (a) if it is-
 - (i) √ located in a separate *storey* (or in the topmost *storey*) that is separated from the remainder of the building by floor construction having an FRL of 120/120/120;
 - (ii) √ smoke control exhaust fans located in the air stream and they are constructed for high temperature operation in accordance with Specification E2.6; or
 - (iii) √ equipment otherwise adequately separated from the remainder of the building.
- (c) √ Separation of on-*site* fire pumps must comply with clause 3(b) of Specification E1.2.

PART C3 PROTECTION OF OPENINGS

Delete C3.9 and insert WA C3.9 as follows:

WA C3.9 Service penetrations in fire-isolated exits

Fire-isolated *exits* must not be penetrated by any services

SUPERCEDED

other than-

- (a) ý electrical wiring associated with a lighting or pressurising system serving the *exit* or a communication system in accordance with D2.22; or
- (b) ý ducting associated with the pressurising system if it-
 - (i) ý is constructed of material having an FRL of not less than 120/120/60 where it passes through any other part of the building; and
 - (ii) ý does not open into any other part of the building; or
- (c) ý water supply pipes for fire services.

SECTION D ACCESS AND EGRESS

PART D1 PROVISION FOR ESCAPE

Insert in WA D1.3(c) as follows:

WA D1.3 When fire-isolated exits are required

- (c) ý Within buildings to which Part D3 applies, every *required fire-isolated stairway* must be provided at each floor level with a recess not less than 800 mm wide, 1200 mm deep and 2000 mm high in which persons are able to rest out of the main stream of persons using the stairway in the event of an emergency.

Delete D1.4(c)(ii) as follows:

WA D1.4 Exit travel distances

- (c) ý (ii) (deleted).

After D1.12(b)(iv), insert WA D1.12(b)(v), as follows:

WA D1.12 Non-required stairways, ramps or escalators

- (b) ý (v) in a building of Type B construction.

PART D2 CONSTRUCTION OF EXITS

Delete D2.1 and insert WA D2.1 as follows:

WA D2.1 Application of Part

Except for WA D2.16(i), this Part does not apply to-

- (a) ý a Class 1 or Class 10 building; or
- (b) ý the internal parts of a *sole-occupancy unit* in a Class 2 or Class 3 building or a Class 4 part of a building.

Delete D2.7(d) and insert WA D2.7(d), as follows:

WA D2.7 Installations in exits and paths of travel

- (d) ý Services or equipment must not be installed in any corridor, hallway, lobby or the like leading to an *exit* if it comprises-
 - (i) ý electricity meters, distribution boards or ducts;

SUPERCEDED

- (ii) ý central telecommunications distribution boards or equipment; or
- (iii) ý electrical motors or other motors serving equipment in the building, unless it is enclosed by *non-combustible* construction or a *fire-protective covering*.

After D2.16(h) insert WA D2.16(i) as follows:

WA D2.16 Balustrades

- (i) ý In a Class 1 or Class 10 building, or the internal parts of a *sole-occupancy unit* in a Class 2 or Class 3 building or a Class 4 part of a building, every accessible balcony, sun-deck or the like, having a floor more than 1500 mm above the finished level of the ground below, must have at least a single horizontal rail at a height not less than 750 mm and not more than 900 mm above the floor.

Delete D2.19(c) and insert WA D2.19(c) as follows:

WA D2.19 Doorways and doors

- (c) ý must not be fitted with a sliding door unless-
 - (i) ý it serves a building or part with a *floor area* not more than 200 m²;
 - (ii) ý the doorway is the only *required exit* from the building or part; and
 - (iii) ý the door may be opened manually under a force of 110 N;

PART D3 ACCESS FOR PEOPLE WITH DISABILITIES

Delete D3.2 and insert WA D3.2 as follows:

WA D3.2 Access to buildings

Access for people with disabilities must be provided to buildings as set out in WA Table D3.2 by means of a continuous path of travel in accordance with AS1428.1-

- (a) ý from a road boundary of the allotment;
- (b) ý from any carpark space on the allotment (whether within or outside the building)-
 - (i) ý that is set aside for people with disabilities using the building; or
 - (ii) ý if there are no carpark spaces set aside for them, from any carpark area that serves the building; and
- (c) ý from any other building on the allotment to which access for people with disabilities is *required*, except that walkways, ramps and landings must have a maximum rise of 750 mm between landings at a maximum gradient of 1:12.

WA TABLE D3.2 REQUIREMENTS FOR ACCESS FOR PEOPLE WITH DISABILITIES BUILDING ACCESS REQUIREMENTS

Class 3

- | | |
|--|--------------------------------|
| (a) ý If the building contains- | To and within- |
| more than 10 <i>sole-occupancy units</i> up to 49 units | one <i>sole-occupancy unit</i> |
| more than 49 units but not more than 99 | 2 <i>sole-occupancy units</i> |
| more than 99 units | 3 <i>sole-occupancy units</i> |
| (b) ý accommodation for more than 10 persons other than in sole- occupancy | |

SUPERCEDED

SUPERCEDED

units	
up to 49 beds	2 beds
more than 49 beds but not more than 99	4 beds
more than 99 beds	6 beds
(c) Common areas that are <i>required</i> to be accessible	the entrance floor and to all public areas on every floor.
Note: For the purposes of this Table, a double bed counts as one bed.	
Class 5, 6, 7 and 8 $\dot{\gamma}$	To and within buildings in which more than 100 persons are accommodated, determined in accordance with D1.13; and To and within any floor to which vertical access by way of a ramp, step ramp or kerb ramp, or passenger lift is provided.
Class 9a	To and within all areas normally accessible to the public, patients or staff.
Class 9b	
<i>Assembly building</i> not being a <i>school</i> or an $\dot{\gamma}$ <i>early childhood centre</i> $\dot{\gamma}$	To and within every room that accommodates more than 100 persons, and if fixed seating is provided, not less than 1 wheelchair space for each 200 seats, or part, with a minimum of 2 spaces and a maximum of 12; and within any other floor to which vertical access way of a ramp, step ramp or kerb ramp, or passenger lift is provided.
<i>School</i> $\dot{\gamma}$	To every room if no alternative similar facilities to those provided in that room are accessible elsewhere in the <i>school</i> .
<i>Early childhood centre</i> $\dot{\gamma}$	To and within every room used by children.
Note: The calculation of <i>floor area</i> and the number of persons accommodated is in accordance with D1.13.	

After D3.3(c) insert WA D3.3(d) as follows:

WA D3.3 Parts of buildings to be accessible

- (d) $\dot{\gamma}$ In buildings *required* by Table D3.2 to provide access for people with disabilities, every lift must-
- (i) $\dot{\gamma}$ be provided with a handrail not less than 600 mm long fixed to the wall of the lift at least 900 mm but not more than 1000 mm above floor level in a position adjacent to the control panel of the lift or, where there is more than one, to one of the control panels;
 - (ii) $\dot{\gamma}$ have minimum internal floor dimensions of 1800 mm x 1800 mm or 1400 mm x 1900 mm except that where the lift lobby exceeds those dimensions, the lift may be reduced in size to minimum internal dimensions of 975 mm wide x 1300 mm deep;
 - (iii) $\dot{\gamma}$ have doors that open to a minimum clear width of not less than 800 mm;
 - (iv) $\dot{\gamma}$ be fitted, in addition to any other sensory beams or devices that may be fitted, with a door opening sensory beam located at least 900 mm but not more than 1200 mm above floor level; and
 - (v) have all numbers and buttons for operating the lift located at least 900 mm but not more than 1200 mm above floor level.

SUPERCEDED

Delete D3.4(c) and insert WA D3.4(c) as follows:

WA D3.4 Concessions

(c) $\dot{\gamma}$ to more than 1 car parking space for each 100 spaces in a *public carpark* or where more than 10 parking bays are provided for the use of visitors to a building to which this part applies, to more than 1 car parking bay for each 100 spaces or part thereof; or

SECTION E SERVICES AND EQUIPMENT

PART E1 FIRE-FIGHTING EQUIPMENT

After E1.3(e) insert WA E1.3(f) as follows:

WA E1.3 Fire hydrants

(f) $\dot{\gamma}$ Every *required hydrant* must be a copper alloy wheel operated valve designed to open anti-clockwise, and fitted with 65 mm instantaneous female couplings complying with BS 336.

PART E2 SMOKE CONTROL

Delete E2.2 and insert WA E2.2 as follows:

WA E2.2 Exclusion of smoke from fire-isolated exits

Buildings must be provided with means of excluding smoke from fire-isolated *exits* as listed in WA Table E2.2-

WA TABLE E2.2 MEANS FOR EXCLUDING SMOKE FROM FIRE-ISOLATED EXITS

EXIT TYPE	REQUIREMENT
<p><i>A required fire-isolated stairway</i> serving any storey above an <i>effective height</i> of 25 m:</p> <p><i>A required fire-isolated stairway</i> serving three or more below ground <i>storeys</i>:</p> <p><i>A required fire-isolated ramp</i> or <i>fire-isolated passageway</i> having a path of travel more than 60 m along it to a road or open space:</p>	<p>Either-</p> <p>(a) $\dot{\gamma}$ a pressurisation system in accordance with E2.7; or</p> <p>(b) $\dot{\gamma}$ open access ramps or <i>fire-isolated passageway</i> having balconies in accordance with D2.5.</p>
<p><i>A required fire-isolated stairway</i> serving an <i>atrium</i>:</p> <p><i>A required fire-isolated stairway</i> within a Class 9 $\dot{\gamma}$ building: $\dot{\gamma}$</p>	<p>A pressurisation system in accordance with E2.7. $\dot{\gamma}$</p>

Note: A below ground *storey* is one which is partially or wholly below ground and is not counted in the *rise in storeys* in accordance with C1.2.

Delete E2.4 and insert WA E2.4 as follows:

WA E2.4 Air handling systems

Where an air handling system is installed in a building it must-

(a) $\dot{\gamma}$ if it supplies air to more than one *storey* or *fire compartment*, operation in accordance with-

SUPERCEDED

- (i) ∫ AS 1668.1 where the building does not exceed 25 m in *effective height*; or
- (ii) ∫ Specification E2.4 where the building exceeds 25 m in *effective height*; or
- (b) ∫ if it supplies air to a single *storey* or *fire compartment*, operate in accordance with Specification E2.4.

Delete E2.5 and insert WA E2.5 as follows:

WA E2.5 Roof vents

Required roof vents must comply with the performance requirements of AS 2427 and be installed as part of a complete smoke/heat venting system complying with AS 2665, except that-

- (a) ∫ permanently open vents may form part of the *required* fire venting system provided that the *required* aerodynamic area of the total venting system complies with AS 2665 and the vents comply with all other construction and performance requirements of AS 2427;
- (b) ∫ all roof vents within the same roof smoke compartment must open at the same time; and
- (c) ∫ roof vents must be activated by-
 - (i) ∫ in a Class 7 or 8 building - any fusible link within a roof smoke ∫ compartment; or ∫
 - (ii) ∫ a *sprinkler system* if it is installed throughout the building; or
 - (iii) ∫ a fire detection and alarm system which complies with AS 1670; and
 - (iv) ∫ smoke detectors spaced not more than 30 m apart and 15 m from any curtain and with not less than one detector for each 500 m² of *floor area*; or
 - (v) ∫ rate of rise heat detectors spaced not more than 15 m apart and 7.5 m from any curtain and with not less than one detector for each 250 m² of *floor area*.

Delete E2.7 and insert WA E2.7 as follows:

WA E2.7 Pressurisation

A system designed to exclude smoke from a fire-isolated *exit*, together with any smoke lobby provided under D1.7, must-

- (a) ∫ comply with AS 1668.1, except that-
 - (i) ∫ the criteria of 50 Pa pressure differential across each door when all doors are closed does not apply; and
 - (ii) ∫ in a smoke control system complying with Specification E2.4, the air velocity at the door does not apply to non-fire floors, and
 - (iii) ∫ openable *windows* or other openable devices (other than necessary doorways, pressure-controlled relief louvres and *windows* openable by a key) must not be in the stairway, ramp or passageway; and
- (b) ∫ not serve more than one fire-isolated *exit* system and not form part of any other air-handling system;
- (c) ∫ be activated by-
 - (i) ∫ a smoke detector located between 1.5 m and 3 m from each doorway affording access to the *fire-isolated stairway*, *fire-isolated ramp* or *fire-isolated passageway*; and

SUPERCEDED

- (ii) any other *required* fire detection system that is installed in the building.

PART E3 LIFT INSTALLATIONS

Delete E3.4(b)(i) and insert WA E3.4(b)(i) as follows:

WA E3.4 Emergency lifts

- (b) y (i) Provide for Fire Service Control in accordance with AS 1735.2 except that the protection from door edge reopening devices must be retained.

Insert WA Specification E1.2, clause 5 as follows:

WA Specification E1.2 y FIRE MAINS AND WATER SUPPLY SERVICES

5. Ancillary equipment

- (a) y A *fire main* on which a *hydrant* is installed must have a minimum diameter of-
- (i) y 100 mm where one *hydrant* is connected; or
 - (ii) y 150 mm where two *hydrants* per *storey* are connected and the building has an *effective height* of more than 25 m; or
 - (iii) y 150 mm where the *effective height* of the building is more than 60 m.
- (b) y Suitable pressure reducing devices must be installed when maximum permissible static pressure is exceeded.
- (c) y Control valves must be fitted to the main if the building has an *effective height* of more than 25 m, where-
- (i) y if a single main is provided control valves must be installed at intervals not exceeding 5 *storeys*; and
 - (ii) y if two or more mains are provided they must be interconnected and fitted with control valves to enable isolation of parts of those mains.
- (d) y Where the height of a fire service exceeds 75 m it must be segregated into zones and a relay booster pump installed on the main between zones, and no zone must exceed 75 m in height.
- (e) y A 100 mm diameter *fire main* must be fitted with two inlets, and a 150 mm main with four inlets, each consisting of a 60 mm instantaneous male coupling conforming with BS 336. Each inlet must be protected by a single twist release lugged blank cap to permit the release of any pressure build up behind the cap.

After clause 7(a)(v) in Specification E1.8, insert WA Specification E1.8 clause 7(a)(vi) as follows:

WA Specification E1.8 y FIRE EMERGENCY CONTROL CENTRES

7. Size and contents

- (a) (vi) y colour-coded, durable, tactical fire plans.

Delete Specification E2.4 and insert WA Specification E2.4 as follows:

WA Specification E2.4 ∩ **MECHANICAL SMOKE CONTROL IN MULTI-STOREY BUILDINGS**

1. Scope

This Specification describes the performance and operation of air-handling systems used to control smoke in multistorey buildings.

2. Central air-conditioning plant

The installed central air-conditioning system may be utilized for smoke control if it complies with AS 1668.1, and-

- (a) ∩ additional smoke control dampers are introduced into the smoke exhaust and supply air ductwork at each *storey* or *fire compartment*-
 - (i) ∩ to stop the supply air to the fire affected *storey* or *fire compartment* and continue to supply air to all other *storeys* and *fire compartments*; and
 - (ii) ∩ to exhaust the smoke from the fire affected *storey* or *fire compartment*; and
 - (iii) ∩ to achieve not less than 20 Pa positive pressure in all other *storeys* and *fire compartments*, above the pressure in the fire affected *storey* or *fire compartment*; and
 - (iv) ∩ to fail safe to a condition of all supply air and exhaust smoke dampers fully open; and
 - (v) ∩ in such a manner that the fire integrity of the building is not compromised; and
- (b) ∩ sufficient air from other *storeys* or *fire compartments* must be mixed with the smoke exhaust from the fire affected *storey* or *fire compartment* to reduce the temperature of the exhaust gasses at the exhaust fan to a maximum of 200°C.

3. Individual air-conditioning units on each floor

Where an air-handling system supplies air to a single *storey* or *fire compartment*-

- (a) ∩ the air-handling unit in the fire-affected *storey* or *fire compartment* must stop; and
- (b) ∩ the air-handling units in all other *storeys* or *fire compartments* must supply full fresh air to those *storeys* or *fire compartments*; and
- (c) ∩ the fire-affected *storey* or *fire compartment* must be relieved to outside or exhausted, to achieve not less than 20 Pa positive pressure in all other *storeys* and *fire compartments*, above the pressure in the fire affected *storey* or *fire compartment*.

4. Actuation of smoke control system

The smoke control system must be automatic in operation and actuated by-

- (a) ∩ smoke detectors located adjacent to each *required exit*, and return and relief air paths, in each *storey* in accordance with Specification E1.7; and
- (b) ∩ by any other *required* fire alarm or *sprinkler system* installed within the building.

Delete Specification E2.6 and insert WA Specification E2.6 as follows:

WA Specification E2.6 SMOKE EXHAUST SYSTEMS

1. Scope

This Specification describes the performance and method of operation of smoke exhaust systems in buildings which are designed to-

- (a) remove smoke from within the building using ducted or roof mounted exhaust fans; or
- (b) in a shopping centre complex or mall, remove smoke from within pedestrian malls to maintain for as long as possible a tenable escape path for the occupants.

2. Fan capacity

Fan systems must have an exhaust capacity in accordance with Figure 2.

Figure 2 SMOKE EXHAUST RATE

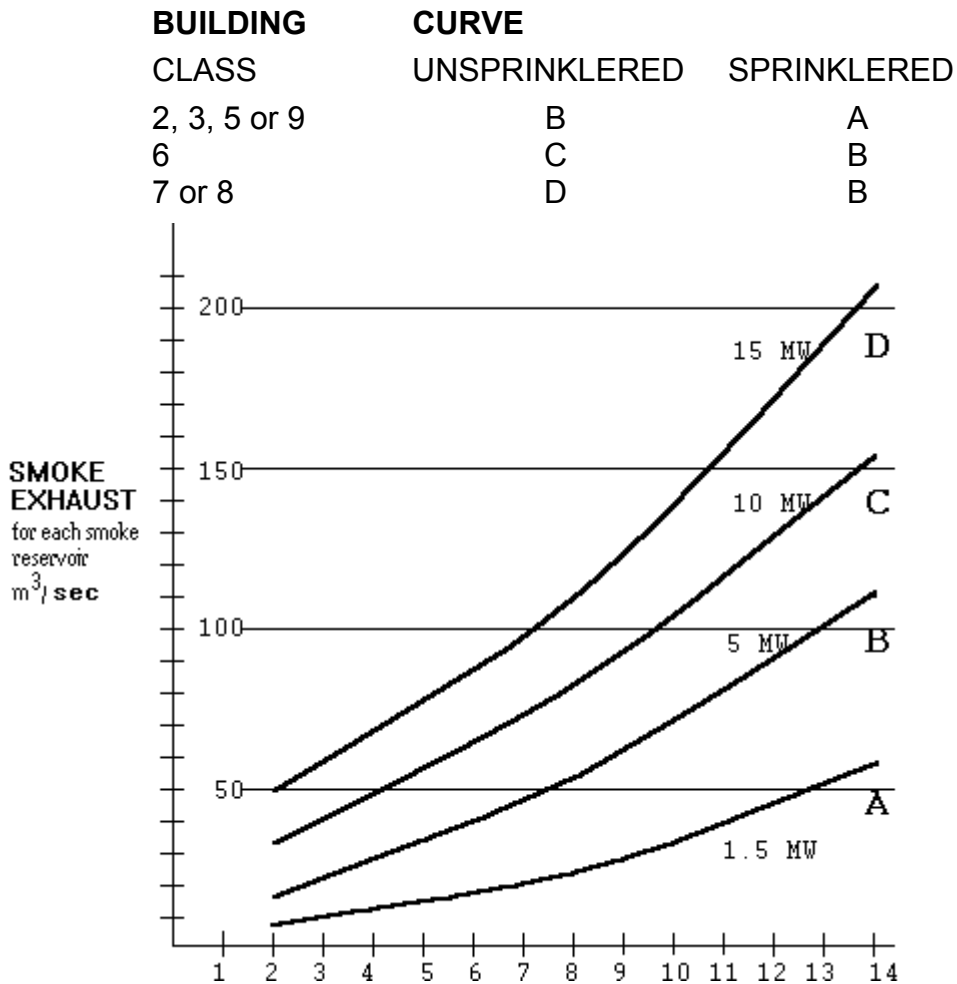

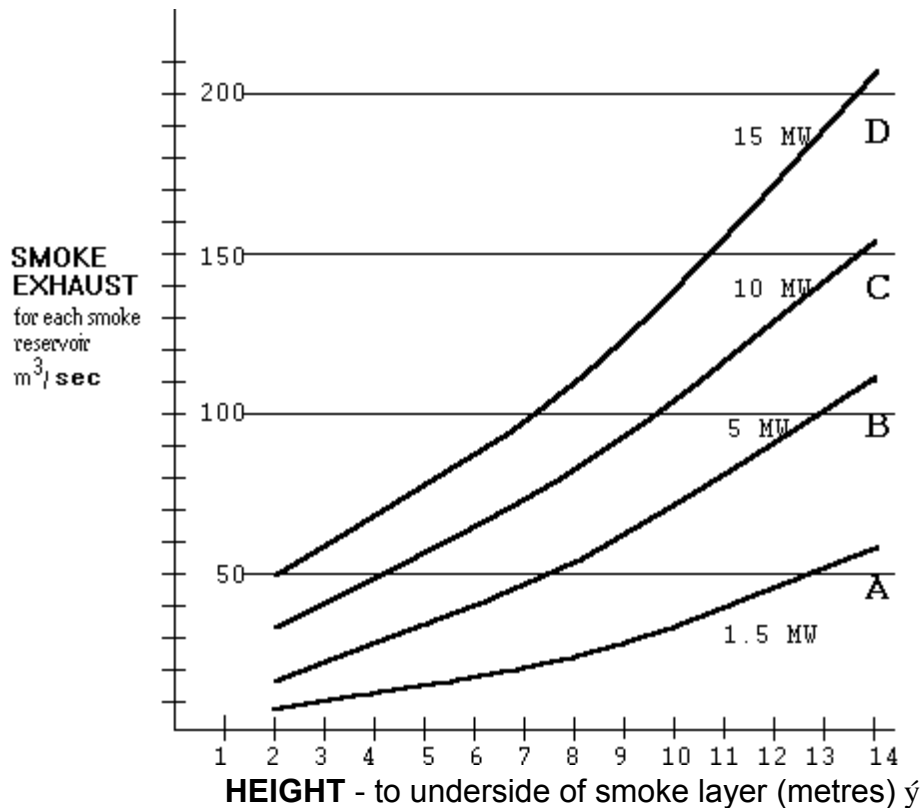

(To be not less than 2.1 m above relevant floor levels within the compartment) y

3. Smoke compartmentation of roof spaces and ceilings

Roof spaces and ceilings-

- (a) must be divided into smoke compartments not more than 1500 m² in area by draught curtains in accordance with AS 2665; or
- (b) y in a shopping centre complex or mall must have-
- (i) y draught curtains, or *non-combustible*, or toughened or wired glass bulkheads, which extend not less than 1 m beneath any imperforate ceiling; or
 - (ii) y ceiling reservoirs of not less than 500 mm deep, each containing a smoke exhaust fan, across the full width of the mall to divide it into compartments not exceeding 40 m in length.

4. Location of fans and discharge

Exhaust fans must be located so as not to cause undue turbulence, and-

- (a) y in a shopping centre complex or mall-
- (i) y not more than 20 m from the end of the complex or mall and spaced not more than 40 m apart; and
 - (ii) y not at a mall intersection unless there is an open area where the ceiling is raised not less than 2 m above the ceiling in the mall; and
 - (iii) y at natural collection points for hot smoky gasses within each smoke compartment having regard to the ceiling geometry and its effect on the migratory path of the smoke.
- (b) y in other buildings be located so that each fan must not serve more than one 1500 m² smoke compartment; and

- (c) ŷ discharge directly to the outside and in a manner that will not spread fire or smoke to adjacent *fire compartments* or buildings.

5. Make-up air

Low level fresh air inlet openings or doors must be sized to provide adequate low velocity fresh air make up to satisfy the exhaust performance of the installed smoke exhaust fans, care being exercised in the number and location of such openings and their disturbance of the smoke layer due to turbulence created by the incoming air.

6. Operation of fans

All smoke exhaust fans must start sequentially and be activated by the operation in the area served by the fan of-

- (a) ŷ a *sprinkler system*;
- (b) ŷ a fire detection and alarm system which complies with Specification E1.7; or
- (c) ŷ a detector system comprising-
- (i) ŷ smoke detectors spaced not more than 30 m apart and 15 m from any curtain, bulkhead or wall and with not less than one detector for each 500 m² of *floor area*; or
 - (ii) ŷ rate of rise heat detectors spaced not more than 15 m apart and 7.5 m from any curtain, bulkhead or wall and with not less than one detector for each 250 m² of *floor area*, and not less than 2 detectors located on opposite sides of each fan inlet.
- (d) ŷ in a shopping centre complex or mall - a control system incorporating:
- (i) ŷ Optical smoke detectors at each smoke reservoir fitted with not less than one detector for each 150 m² of *floor area*, arranged in a minimum of two groups. Full smoke exhaust must be implemented upon activation of the first alarm group in the respective reservoir. Upon activation of a second detector group and following a 30 second check period an alarm must be transmitted to Brigade.
 - (ii) ŷ At each *exit* from a shop exceeding 1000 m² in *floor area*, and at any service desk - a manual break glass fire alarm arranged to immediately activate smoke exhaust fans and transmit an immediate alarm to Brigade.
 - (iii) ŷ At any service desk and centre managers office - a discrete audio/visual alarm activated by the fire alarm system.
 - (iv) ŷ At the fire indicator board - full pilot indication of smoke control equipment operating status and manual override controls.
 - (v) ŷ Controls which direct air-handling plant in non fire alarm zones to continue operation to outside air. Air handling plant not providing a smoke exhaust function within a fire alarm zone to stop.
 - (vi) ŷ Controls which *automatically* open main entry doors to malls upon any fire alarm.

7. Protection of wiring

Power supply wiring for roof-mounted exhaust fans must be MIMS (copper) cable or otherwise suitably fire and mechanically protected wiring.

8. Resistance to high temperatures

If not adequately shielded from the airflow-

- (a) √ all parts of exhaust fans and other equipment *required* to operate in a smoke laden environment; and
- (b) √ parts of the building *required* to be smoke-resisting, must be capable of withstanding a temperature of 200°C for a period of not less than 2 hours.

PART F2 SANITARY AND OTHER FACILITIES

Delete F2.4 and insert WA F2.4 as follows:

WA F2.4 Facilities for people with disabilities

Sanitary facilities must be provided in accordance with WA Table F2.4 in every Class 3, 5, 6, 7, 8 and 9 building that is *required* by Part D3 to be accessible to people with disabilities.

WA TABLE F2.4 SANITARY FACILITIES FOR PEOPLE WITH DISABILITIES √	
CLASS OF BUILDING	MINIMUM FACILITY FOR USE BY PEOPLE WITH DISABILITIES
Class 3 -	
In every <i>sole-occupancy unit</i> to which access for people with disabilities is <i>required</i>	(a) one closet pan and washbasin; and (b) √ one shower or shower-bath.
Class 5,6,8 and 9 buildings <i>required</i> to be accessible by Part D3 and Table D.3.2 and Class 3 if accommodation is other than in <i>sole-occupancy units</i> , or other parts of the building are <i>required</i> to be accessible-	
TOTAL FACILITIES NORMALLY REQUIRED	MINIMUM NUMBER FOR USE BY PEOPLE WITH DISABILITIES
Closet pans (including those provided for use by people with disabilities) plus urinals-	
1 - 100	(a) one unisex facility; or (b) one closet pan and washbasin for each sex.
101 - 200	(a) 2 unisex facilities; or (b) √ one closet pan and washbasin for each sex and one unisex facility.
more than 200	3 unisex facilities or one closet pan and washbasin for each sex and two unisex facilities
In all cases, facilities for females must include adequate means for the disposal of sanitary towels.	
Baths or showers √	(a) one shower or shower-bath for each 10 or part thereof normally <i>required</i> but not less than one for use by both sexes; and (b) √ where <i>required</i> showers are provided one must comply with AS 1428.1- Shower Recesses and Circulation Spaces for Shower Access.

Delete F2.5(b) and insert WA F2.5(b) and (c) as follows:

WA F2.5 Construction of sanitary compartments

- (b) √ Facilities for people with disabilities - the construction and layout of sanitary compartments, showers and compartments containing washbasins for use by people with disabilities must comply with AS 1428.1.
- (c) Doors - the door of every fully enclosed closet pan compartment must-

- (i) ý open outwards; or
- (ii) ý be readily removable from the outside.

PART F4 LIGHT AND VENTILATION

After F4.4(b) insert WA F4.4(c) as follows:

WA F4.4 Artificial lighting

(c) ý Artificial lighting *required* by this Part must comply with AS 1680.

After F4.11 insert WA F4.12 as follows:

WA F4.12 Reflective glazing

- (a) ý Interpretation: Reflective glazing means glass or other glazing material that has a light or heat reflective value that exceeds 16%, because of-
 - (i) ý the properties of the glass or material;
 - (ii) ý the application to the glass or material of a reflective film or any other form of treatment; or
 - (iii) ý the method of construction used in the building component of which the glass or material forms part.
- (b) ý Restrictions on use: Reflective glazing used in a door, *window* or other component of an *external wall* or roof of any building other than a Class 1 or Class 10 building, must not-
 - (i) ý cause glare or heat radiation that will have any undue adverse effect on the surrounding environment; or
 - (ii) ý create any undue traffic hazard.

PART F5 NOISE TRANSMISSION AND INSULATION

Delete F5.3 and insert WA F5.3 as follows:

WA F5.3 Sound insulation of floors between units

A floor separating *sole-occupancy units* must have an STC not less than 45 and provide a satisfactory level of insulation against impact sound.

SECTION G ANCILLARY PROVISIONS

PART G1 MINOR STRUCTURES AND COMPONENTS

Delete G1.1 and insert WA G1.1 as follows:

WA G1.1 Swimming pools

- (a) ý **Drainage:** A *swimming pool* must have suitable means of drainage.
- (b) ý **Safety fencing:** A *swimming pool* with a depth of water more than 300 mm must have safety fencing in accordance with AS 2818 and AS 1926 to restrict access by young children to-

- (i) ŷ the allotment or the immediate pool surrounds if there is only one Class 1 building on the allotment; or
- (ii) ŷ the immediate pool surrounds, if the *swimming pool* is associated with a number of Class 1 buildings on the same allotment or a Class 2 or 3 building.

In Specification G3.8, insert WA Specification G3.8 clause (d)(iv) and (f)(iii) as follows:

WA Specification G3.8 ŷ FIRE AND SMOKE CONTROL SYSTEMS IN BUILDINGS CONTAINING ATRIUMS

3.2 Operation of atrium mechanical air handling systems

- (d) (iv) continue to supply air to *fire compartments* or *storeys* other than the fire affected compartment or *storey*.
- (f) (iii) continue to supply air to *fire compartments* or *storeys* other than the fire affected compartment or *storey*.

INDEX

A

Access and egress: Section D

Access, for people with disabilities: Part D3

Accreditation Certificate, definition: A1.1

Adoption of Standards and other references: A1.2

Air-handling systems, smoke control: E2.1, E2.4, Spec E2.4

Airlocks: F4.9

Alarm systems, atrium buildings: Spec G3.8

fire detection: Spec E1.7

Alpine area, construction: Part G4

definition: A1.1

Alteration, definition: A1.1

in a united building: A4.2

Alternative exits, discharge: D1.10

distance between: D1.5

Aluminium, construction: B1.3

Amenity and health: Section F

Ancillary provisions: Section G

Application of this Code, to a particular State or Territory: A1.5

Artificial lighting: F4.4

Assembly building, ceiling height: F3.1

definition: A1.1

Attachments, fire-resistance: Spec C1.1

Atrium, buildings, fire and smoke control systems: Spec G3.8

construction: Part G3

dimensions: G3.2

definition: A1.1

exits: G3.7

fire and smoke

control systems: G3.8

fire-isolated exits, smoke control: E2.2

smoke control: E2.1

Atrium well, definition: A1.1

Attic rooms, ceiling height: F3.2

Auditorium, discharge of exits: D1.10

theatres and public halls: Part H1

Automatic, definition: A1.1

B

Backstage, definition: A1.1

Balconies, atriums: G3.5

open access: D2.5

Balustrades: D2.16

Basements, calculation of rise in storeys: C1.2

Bathroom, ceiling height: F3.1

walls, sound insulation: F5.5

waterproofing: F1.7

Baths, Class 1, 2 and 3 buildings: F2.1

Battery rooms, separation of equipment: C2.12

Bedrooms, natural light: F4.1

Blockwork, construction: B1.3

Boilers, separation of equipment: C2.12

installation: G2.2

Booster connections, fire mains: Spec E1.2

Borrowed natural light: F4.3

Borrowed natural ventilation: F4.7

Brickwork, construction: B1.3

Building classifications: A3.2

Building elements, fire resistance: Spec A2.3

Bushfire prone areas, construction: Part G5

C

Cables and wires, protection of service penetrations: C3.15

Carparks, ventilation: F4.11

Cellulose fibre reinforced cement roofing: F1.5

Certificate of Accreditation, definition: A1.1

Chimneys, flues, fireplaces, heating appliances: Part G2

Chutes, incinerators: G2.4

shafts: Spec C1.1

Class 1 buildings, fire-resistance: Spec C1.9

sanitary facilities: F2.1

Type of fire-resisting construction: C1.9

Type of fire-resisting construction required: C1.1

Class 2 buildings, distance between alternative exits: D1.5

Early Fire Hazard Indices: Spec C1.10

exit signs: E4.7

protection of openings: C3.11

sanitary facilities: F2.1

dimensions of exits: D1.6

exit travel distance: D1.4

fire-isolated exits required: D1.3

number of exits required: D1.2

Type of construction: C1.5

Type of fire-resisting construction required: C1.1

Class 3 buildings, access for people with disabilities: D3.2

dimensions of exits: D1.6

distance between alternative exits: D1.5

Early Fire Hazard Indices: Spec C1.10

emergency warning and intercommunication systems: E4.9

exit signs: E4.7

exit travel distance: D1.4

fire-isolated exits required: D1.3

number of exits required: D1.2

protection of openings: C3.11

sanitary facilities: F2.1

sanitary facilities: F2.3

Type of construction: C1.5

Type of fire-resisting construction required: C1.1

Class 4 buildings, protection of openings: C3.11

dimensions of exits: D1.6

exit travel distance: D1.4

number of exits required: D1.2

Type of construction: C1.6

Type of fire-resisting

construction required: C1.1

Class 5 buildings, access for people with disabilities: D3.2

dimensions of exits: D1.6

distance between alternative exits: D1.5

exit travel distance: D1.4

fire-isolated exits required: D1.3

number of exits required: D1.2

sanitary facilities: F2.3

Type of fire-resisting construction required: C1.1

Class 6 buildings, access for people with disabilities: D3.2

dimensions of exits: D1.6

distance between alternative exits: D1.5

exit travel distance: D1.4

SUPERCEDED

fire-isolated exits

required: D1.3

number of exits required: D1.2

sanitary facilities: F2.3

Type of fire-resisting construction required: C1.1

Class 7 buildings, access for people with disabilities: D3.2

calculation of rise in storeys: C1.2

dimensions of exits: D1.6

distance between alternative exits: D1.5

exit travel distance: D1.4

fire-isolated exits required: D1.3

fixed platforms, walkways and ladders: D2.18

number of exits required: D1.2

sanitary facilities: F2.3

Type of fire-resisting construction required: C1.1

weatherproofing: F1.4

Class 8 buildings, access for people with disabilities: D3.2

calculation of rise in storeys: C1.2

dimensions of exits: D1.6

distance between alternative exits: D1.5

exit travel distance: D1.4

fire-isolated exits required: D1.3

fixed platforms, walkways and ladders: D2.18

number of exits required: D1.2

sanitary facilities: F2.3

type of fire-resisting construction required: C1.1

weatherproofing: F1.4

Class 9 buildings, access for people with disabilities: D3.2

Early Fire Hazard Indices: Spec C1.10

dimensions of exits: D1.6

distance between alternative exits: D1.5

exit travel distance: D1.4

fire-isolated exits required: D1.3

number of exits required: D1.2

sanitary facilities: F2.3

Class 9 buildings, Type of fire-resisting construction required: C1.1

Class 9a buildings, compartmentation: C2.5

emergency warning and intercommunication systems: E4.9

fire detection and alarm systems: Spec E1.7

stairway landings: D2.14

Class 9b buildings, emergency warning and intercommunication systems: E4.9

SUPERCEDED

Class 10 buildings, fire-resistance: Spec C1.9

Type of fire-resisting construction: C1.9

weatherproofing: F1.4

Type of fire-resisting construction required: C1.1

Classification, of buildings: A3.2

principles: A3.1

multiple, Type of construction: C1.3

multiple: A3.3

Classifications, horizontal separation: C2.8

Clinic, ceiling height: F3.1

Closet pans, sanitary facilities: Part F2

Clothes washing facilities, Class 1, 2 and 3 buildings : F2.1

Combustible, definition: A1.1

Common wall, definition: A1.1

Class 1 buildings, fire-resistance: Spec C1.9 y

Class 10 buildings, fire-resistance: Spec C1.9 y

fire-resistance: Spec C1.1 y

Compartmentation, Class 9a buildings: C2.5

floor area limitations: C2.2

large isolated buildings: C2.3

separation of openings in external walls: C3.3

vertical separation: C2.6

Components, minor structures: Part G1

Composite steel and concrete, construction: B1.3

Concrete roofing tiles, installation: B1.3, F1.5

Concrete structures, fire-resistance level: Spec A2.3

construction: B1.3

Connection of storeys, non-required stairways: D1.12

Construction, in bushfire prone areas: Part G5

of exits: Part D2 y

deemed to satisfy structural requirements: B1.3 y

sound transmission: Spec F5.2 y

structural requirements: B1.3 y

Control centres, fire emergency: Spec E1.8

Control joints, protection of openings: C3.1

Corridor, ceiling height: F3.1

Curtain wall, definition: A1.1

fire-resistance: Spec C1.1

vertical separation: C2.6

Curtains, proscenium walls, theatres and public halls: Spec H1.3

D

Damp and weatherproofing: Part F1

Damp-proof course,

mortars: F1.8

termite shields: F1.9

Damp-proofing, floors on ground: F1.10

Dampness, on building site: F1.2

Dead load, structural requirements: B1.2

Delivery room, ceiling height: F3.1

Demolition: Part B2

Design suitability: A2.2

Dimensions of exits: D1.6

Direction signs, exits: E4.6

Disabled persons, access: Part D3

sanitary facilities: F2.4

Discharge from exits: D1.10

Distance, between alternative exits: D1.5

of travel to exits: D1.4

measurement, exits: D1.14, D1.15

Distribution boards, in exits and paths of travel: D2.7

Domestic-type heating appliances: G2.2

Domestic-type water heaters, access: G1.3

Doors, Class 2, 3 and 4 buildings, protection: C3.11

lift landing, separation of shafts: C2.10

smoke control: E2.3

Doorways, construction in alpine areas: G4.3

in fire walls: C3.5

lift landing, protection: C3.10

methods of protection of openings: C3.4

protection in horizontal exits: C3.7

protection of openings: C3.1

required exits: D2.19

Drainage, domestic-type water heaters: G1.3

swimming pools: G1.1

stormwater: F1.1

E

Early childhood centre, definition: A1.1

Early Fire Hazard Indices: C1.10, Spec C1.10

determination: A2.4

- test for assemblies: Spec A2.4
- Earthquake load**, structural requirements: B1.2
- Earthwall construction**, structural provisions: B1.3
- Effective height**, definition: A1.1
- Electrical service**, switchboard, separation: C2.12
 - meters in exits and paths of travel: D2.7
 - switches and outlets, protection of service: C3.15
- Emergency generators**, separation of equipment: C2.12
- Emergency lifts**: E3.4
- Emergency lighting**, buildings in alpine areas: G4.4
 - design: E4.4 y
 - exit signs and warning systems: Part E4 y
 - requirements: E4.2 y
- Emergency warning and intercommunication systems**: E4.9
- Enclosure**, of space under stairs and ramps: D2.8
- Equipment**, fire-fighting: Part E1
 - separation: C2.12
- Escalators**, non-required: D1.12 Spec D1.12
- Escape provisions**: Part D1
- Evacuation warning systems**, atrium buildings: G3.8
- Evidence of fire resistance**, building elements: A2.3
- Evidence of suitability of materials**, form of construction or design: A2.2
- Exhaust systems**, smoke control: E2.1, Spec E2.6
 - theatres and public halls: Spec H1.2
- Exhaust ventilation**: F4.9
- Exit**, atriums: G3.7
 - construction: Part D2 y
 - definition: A1.1 y
 - dimensions: D1.6 y
 - discharge: D1.10 y
 - discharge in alpine areas: G4.6 y
 - distance between alternatives: D1.5 y
 - doors, fire emergency control centres: Spec E1.8 y
 - doorways and doors: D2.19 y
 - fire-isolated, protection of openings: C3.8 y
 - fire-isolated, re-entry: D2.22 y
 - fire-isolated, travel: D1.7 y
 - horizontal: D1.11 y
 - installations and services: D2.7 y
 - number required: D1.2 y

power-operated doors: D2.19
revolving doors: D2.19
roller shutters: D2.19
signs, Class 2 buildings: E4.7
signs, Class 3 buildings: E4.7
signs, design and operation: E4.8
signs, direction: E4.6
signs, emergency lighting, warning systems: Part E4
signs, requirements: E4.5
sliding doors: D2.19
swinging doors: D2.20
theatres and public halls: H1.5
tilt-up doors: D2.19
travel distances: D1.4

Exposure, to fire-source feature: Spec C1.1

External stairways: D1.8

External wall, definition: A1.1

Class 1 buildings, fire-resistance: Spec C1.9

Class 10 buildings, fire-resistance: Spec C1.9

fire-resistance: Spec C1.1

External wall, protection of openings: C3.2

Extinguishers, fire, portable: E1.6

F

Facilities, sanitary and other: Part F2

Factory, ceiling height: F3.1

classification: A3.2

Fast response sprinklers: Spec E1.5

Fencing, swimming pools: G1.1

Fibre reinforced cement, roof sheeting, installation: B1.3

Fire and smoke, alarms: E1.7

control systems in atrium buildings: G3.8, Spec G3.8

Fire compartment, definition: A1.1

floor area limitations: C2.2

Fire control centres: E1.8

Fire detection, alarm systems, atrium buildings: Spec G3.8

alarm systems, fire services: Spec E1.7

Fire door, definition: Spec E1.5

sliding, protection of openings: C3.6

specification: Spec C3.4

- Fire emergency control centres:** Spec E1.8
- Fire extinguishers,** portable: E1.6
- Fire-fighting, equipment:** Part E1
 - services, alpine areas: G4.7
- Fire hose reels:** E1.4
- Fire hydrants:** E1.3
- Fire-isolated exits,** Early Fire Hazard Indices: Spec C1.10
 - protection of openings: C3.8 y
 - protection of service penetrations: C3.9 y
 - re-entry: D2.22 y
 - requirements: D1.3 y
 - smoke control: E2.2 y
 - travel: D1.7 y
- Fire-isolated lift shafts,** protection of openings: C3.10 Fire-isolated passageway, definition: A1.1
 - construction: D2.11
- Fire-isolated ramp,** definition: A1.1
 - construction: D2.2
- Fire-isolated stairway,** definition: A1.1
 - construction: D2.2
- Fire main,** definition: A1.1
 - water supply services: E1.2 and Spec E1.2
- Fire orders,** alpine areas: G4.9
- Fireplaces,** construction: G2.3
 - heating appliances, chimneys and flues: Part G2
- Fire precautions,** during construction: E1.9
- Fire protection,** support of another part: Spec C1.1
- Fire-protective covering,** definition: A1.1
- Fire provisions,** special hazards: E1.10
- Fire pumps,** fire mains and water supply services: Spec E1.2
- Fire-resistance and stability:** Part C1
- Fire-resistance,** attachments: Spec C1.1
 - building elements: A2.3, Spec A2.3, Spec C1.1 y
 - Class 1 and 10 buildings: Spec C1.9 y
 - common walls: Spec C1.1 y
 - external walls: Spec C1.1 y
 - fire walls: Spec C1.1 y
 - floors: Spec C1.1 y
 - indoor sports stadiums: Spec C1.1 y
 - internal walls: Spec C1.1 y

lintels: Spec C1.1 ý
masonry-veneer walls: Spec C1.1 ý
mezzanine floors: Spec C1.1 ý
open spectator stands: Spec C1.1 ý
open-deck car parks: Spec C1.1 ý
roofs: Spec C1.1 ý
Type of construction: Spec C1.1 ý

Fire-Resistance Level, definition: A1.1
determination: Spec A2.3

Fire-resisting, definition: A1.1

Fire-resisting construction, definition: A1.1
lightweight: C1.8 ý
requirements: C1.1 ý
specification: Spec C1.1 ý

Fire-retardant coatings, Early Fire Hazard Indices: Spec C1.10

Fire-separated section: definition: A1.1

Fire shutters, specification: Spec C3.4

Fire sprinkler systems: Spec E1.5

Fire-source feature, definition: A1.1
exposure: Spec C1.1

Fire sprinklers, atrium buildings: Spec G3.8

Fire-stopping, service penetrations: C3.15

Fire-wall, definition: A1.1

Fire walls, Class 9a buildings: C2.5
fire-resistance: Spec C1.1 ý
protection of doorways: C3.5 ý
separation of buildings: C2.7 ý

Fire windows, specification: Spec C3.4

Fixed platforms, walkways and ladders: D2.18

Flammability Index, definition: A1.1
sarking type materials: Spec C1.10
sarking-type materials, Class 1 buildings: Spec C1.9

Floor area, Class 9a buildings: C2.5
definition: A1.1
limitations: C2.2

Floor protection, atrium buildings: Spec G3.8

Floors, between units, sound insulation: F5.3
fire-resistance: Spec C1.1
on ground, damp-proofing: F1.10
openings for services: C3.12

timber, sub-floor ventilation: F4.10

Flues, chimneys, fireplaces, heating appliances: Part G2

Footings, construction: B1.3

Foundation, definition: A1.1

Fuel services, exits and paths of travel: D2.7

G

Garage, weatherproofing: F1.4

Gas and other fuel services, exits and paths of travel: D2.7

Glass, installation: B1.3

GRP sheeting, roof construction: B1.3

Gypsum plaster, fire-resistance level: Spec A2.3

H

Habitable room, ceiling height: F3.1

definition: A1.1

natural light: F4.1

walls, sound insulation: F5.5

Handrails, construction: D2.17

width of stairways: D2.9

Health and amenity: Section F

Health-care building, definition: A1.1

Hearth, construction of fireplaces: G2.3

Heaters, appliances, installation: G2.2

Heating appliances, fireplaces, chimneys and flues: Part G2

Height of rooms: F3.1

Horizontal exit, definition: A1.1

protection of doorways: C3.7

requirements: D1.11

Hose reels: E1.4

Hydrant, definition: A1.1

fire: E1.3

I

Impact sound, test of equivalence: F5.5, Spec F5.5

Incinerator, chutes, exits and paths of travel: D2.7

rooms: G2.4

Indoor sports stadiums, fire-resistance: Spec C1.1

Type of construction: C1.7

Inferior wall, definition: Spec E1.5

Installations, in exits, paths of travel: D2.7

safety, maintenance: Part E5

Insulation, fire-resistance level, definition: A1.1

Insulation, noise: Part F5

Integrity, fire-resistance level, definition: A1.1

Intercommunication systems, emergency warning: E4.9

Internal wall, definition: A1.1

fire-resistance: Spec C1.1

J

K

Kitchen, ceiling height: F3.1

sinks, sanitary and other facilities: F2.1

walls, sound insulation: F5.5

L

Ladders, fixed platforms and walkways: D2.18

Land, drainage: F1.3

Landings, dimensions and construction: D2.14

Large isolated buildings, compartmentation: C2.3

Latches, door, operation: D2.21

Laundry, ceiling height: F3.1

walls, sound insulation: F5.5 y

waterproofing: F1.7 y

Lift, emergency: E3.4

indicator panels, protection: C3.10

installations: Part E3

landing doors, separation of shafts: C2.10

motor room, separation: C2.12

motor rooms, fixed platforms, walkways and ladders: D2.18

shafts, lightweight construction: Spec C1.8

shafts, protection of openings: C3.10

shafts, separation: C2.10

shafts, stairways: C2.11

stretcher facility: E3.2

use in fire: E3.3

Light, artificial: F4.4

natural: F4.1, F4.3

Lighting, fire emergency control centres: Spec E1.8

Lightweight construction, definition: A1.1

structural tests: Spec C1.8

requirements: C1.8

Lintels, fire-resistance: Spec C1.1

Live load, structural requirements: B1.2

Loadbearing, definition: A1.1

Loads, structural requirements: B1.2

Lobby, smoke, construction: D2.6

smoke, required: D1.7

Locks, operation of door latch: D2.21

Lofts and platforms, theatres and public halls: H1.6

M

Maintenance of safety installations: Part E5

Masonry, fire-resistance level: Spec A2.3

Masonry-veneer walls, fire-resistance: Spec C1.1

Materials, Early Fire Hazard Indices: Spec C1.10

structural requirements: B1.1

suitability: A2.1

Measurement of distance, emergency lighting: E4.3

exits: D1.14, D1.15

Mechanical ventilation, theatres and public halls: Spec H1.3

Metal pipes, protection of service penetrations: C3.15

Metal roofing, installation: B1.3

weatherproofing: F1.5

Mezzanine floor, definition: A1.1

fire-resistance: Spec C1.1

Minor structures and components: Part G1

Mixed types of construction, fire-resistance: C1.4

Moisture barriers, floor on ground: F1.10

Mortars, damp-proof: F1.8

Multiple classification, interpretation: A3.3

Type of construction: C1.3

N

Natural light: F4.1, F4.3

Natural smoke venting: E2.3

Natural ventilation: F4.6

Noise transmission, insulation: Part F5

Non-combustible, definition: A1.1

Non-fire-isolated stairways and ramps, construction: D2.3
travel: D1.9

Non-required stairways, ramps and escalators: D1.12

Number, persons accommodated: D1.13

O

Occupant density, number of persons: D1.13

Office, ceiling height: F3.1

classification: A3.2

Oil-fired appliances, domestic: G2.2

Open access ramps, balconies: D2.5

Open-deck carpark, compartmentation: C2.1

definition: A1.1

fire-resistance: Spec C1.1

Open-deck carpark, vertical separation: C2.6

weatherproofing: F1.4

Open fireplaces, construction: G2.3

Open garage, definition: A1.1

Open space, definition: A1.1

large isolated buildings: C2.3, C2.4

roof: D2.12

Open spectator stand, compartmentation: C2.4

definition: A1.1

dimensions of exits: D1.6

discharge of exits: D1.10

fire-resistance: Spec C1.1

number of exits required: D1.2

openings in external walls: C3.2

Type of construction: C1.7

vertical separation: C2.6

weatherproofing: F1.4

Openings, for service installations: C3.14, C3.15

in fire emergency control centres: Spec E1.8

in fire-isolated lift shafts: C3.10

in floors for services: C3.12

in proscenium walls, theatres and public halls: Spec H1.3

in shafts, protection: C3.13

protection: Part C3

protection in fire-isolated exits: C3.8

separation of fire compartments: C3.3

Operating theatre, ceiling height: F3.1

Operation of door latch: D2.21

P

Panel wall, definition: A1.1

fire-resistance: Spec C1.1

Particleboard structural flooring, installation: B1.3

Passageway, ceiling height: F3.1

fire-isolated, construction: D2.11

Paths of travel, installations and services: D2.7

Patient care area, ceiling height: F3.1

compartmentation: C2.5

definition: A1.1

dimensions of exits: D1.6

Pedestrian ramps, construction: D2.10

Penetrations: C3.15

for services, protection: C3.14, C3.15, Spec C3.15

Persons accommodated, number: D1.13

Piling, construction: B1.3

Pipes, soil and waste, sound insulation: F5.6

Plant rooms, fixed platforms, walkways and ladders: D2.18

fire separation: C2.12

Plaster, fire-resistance level: Spec A2.3

Platforms and lofts, theatres and public halls: H1.6

Pliable roof sarking: F1.6

Pools, swimming: G1.1

Portable fire extinguishers: E1.6

Power supply, fire emergency control centres: Spec E1.8

Power-operated doors, required exits: D2.19

Precautions against fire, during construction: E1.9

Pressurisation systems, requirements: Table E2.2

smoke control: E2.7

theatres and public halls: H1.2, Spec H1.2

Principles of classification: A3.1

Private garage, definition: A1.1

Professional engineer, definition: A1.1

Proscenium walls, construction: Spec H1.3

theatres and public halls: H1.3

Protection of openings: Part C3

in shafts: C3.13

methods: C3.4

service penetrations: C3.14, C3.15

Provision for escape: Part D1

Provision for special hazards, fire fighting: E1.10

Public carpark, definition: A1.1

ventilation: F4.11

Public corridor, definition: A1.1

Public hall, ceiling height: F3.1

emergency warning and intercommunication systems: E4.9

stages, theatres: Part H1

Pumps, sound insulation: F5.7

PVC sheeting, roof construction: B1.3

Q

R

Ramps, enclosure of space under: D2.8

external, alpine areas: G4.5

fire-isolated, construction: D2.2

non-fire-isolated, travel: D1.9

non-fire-isolated, construction: D2.3

non-required: D1.12 Spec D1.12

pedestrian, construction: D2.10

Re-entry from fire-isolated exits: D2.22

Referenced Standards: A1.3

Refrigerated chambers, strong rooms and vaults: G1.2

Registered Testing Authority, definition: A1.1

fire-resistance level: Spec A2.3

Required, definition: A1.1

Resistance to the incipient spread of fire, definition: A1.1

Revolving doors, required exits: D2.19

Rigging lofts, theatres and public halls: H1.6

Rise in storeys, calculation: C1.2

definition: A1.1

Risers and treads, dimensions: D2.13

Roller shutters, required exits: D2.19

Roof, as open space: D2.12

construction: B1.3

coverings: F1.5

fire-resistance: Spec C1.1

protection, atrium buildings: Spec G3.8
sarking: F1.6
separation, atriums: G3.6
structures, fire-resistance concession: Spec C1.1
vents, smoke control: E2.1
vents, smoke control: E2.5
weatherproofing: F1.4

Room height: F3.1

Room sizes: Part F3

fire emergency control centres: Spec E1.8

S

Safety fencing, swimming pools: G1.1

Safety installations, maintenance: E5.2

Sanitary compartment, construction: F2.5

definition: A1.1

dimensions of doors: D1.6

operation of door latch: D2.21

waterproofing: F1.7

weatherproofing: F1.4

Sanitary and other facilities: Part F2

Sarking, roof: F1.6

Sarking-type material, definition: A1.1

Early Fire Hazard Indices: Spec C1.10

Class 1 buildings: Spec C1.9

School, definition: A1.1

dimensions of exits: D1.6

School classroom, ceiling height: F3.1

natural light: F4.1

Seating area, theatres and public halls: H1.4

Seismic load, structural requirements: B1.2

Self-closing, definition: A1.1

Separation by fire walls: C2.7

Separation, of classifications, horizontal: C2.8

of classifications, vertical: C2.9

of equipment: C2.12

of lift shafts: C2.10

of rising and descending stair flights: D2.4

of plantrooms: C2.12

Service penetrations, in fire-isolated exits: C3.9

protection of openings: C3.14, C3.15

specification: Spec C3.15

Service station, definition: A1.1

Service units, equipment, calculation of rise in storeys: C1.2

Serviceability, structural: B1.1

Services, protection of openings in floors: C3.12

Shaft, definition: A1.1

lightweight construction: Spec C1.8 y

protection of openings: C3.13 y

separation of lifts: C2.10 y

Shop, ceiling height: F3.1

Shopping centres, compartmentation: C2.3

smoke control: E2.1

Shower enclosures, waterproofing: F1.7

Showers, Class 1, 2 and 3 buildings: F2.1

Signs, fire emergency control centres: Spec E1.8

Site, dampness: F1.2

definition: A1.1

Size of rooms: Part F3

Sliding doors, required exits: D2.19

Sliding fire doors, protection of openings: C3.6

Sloping ceilings, height: F3.2

Smoke and fire alarms: E1.7

Smoke and heat vent, definition: A1.1

large isolated buildings: C2.3 y

requirements: E2.5 y

Smoke control: Part E2

air-handling systems: E2.4 Spec E2.4

atriums: G3.8, Spec G3.8

fire-isolated exits: E2.2

Smoke detectors, location: Spec E1.7

Smoke Developed Indices: Spec C1.10

Smoke Developed Index, definition: A1.1

requirements: C1.10, Spec C1.10

Smoke doors, specification: Spec C3.4

Smoke exhaust systems: E2.6

large isolated buildings: C2.3

separation of equipment: C2.12

Smoke lobby, construction: D2.6

required: D1.7

- Smoke-proof walls**, Class 9a buildings: C2.5
- Smoke venting**, natural: E2.3
- Snow**, areas, construction: Part G4
 - load, structural requirements: B1.2
- Soil and waste pipes**, sound insulation: F5.6
- Soil treatment**, against termites: B1.3
- Sole-occupancy unit**, definition: A1.1
- Solid-fuel burning appliances**, domestic-type: G2.2
- Sound insulation**, floors between units: F5.3
 - impact, test of equivalence: Spec F5.5 y
 - pumps: F5.7 y
 - walls between units: F5.4 y
 - waste and soil pipes: F5.6 y
- Sound level**, fire emergency control centres: Spec E1.8
- Sound transmission and insulation**: Part F5
- Sound Transmission Class**, interpretation: F5.2
- Space under stairs and ramps**, enclosure: D2.8
- Spandrels**, vertical separation: C2.6
- Special hazards**, fire provisions: E1.10
- Special use buildings**: Section H
- Spread of Flame Indices**, definition: A1.1
 - requirements: C1.10, Spec C1.10
- Sprinkler system**, definition: A1.1
 - fire suppression: E1.5, Spec E1.5
 - large isolated buildings: C2.3
 - valve equipment, separation: C2.12
- Stage**, class 9b buildings, definition: A1.1
 - theatres, public halls: Part H1
- Stair**, dimensions, treads and risers: D2.13
 - enclosure of space under: D2.8
 - flights, rising and descending, separation: D2.4
 - pressurisation systems, atrium buildings: G3.8
 - pressurisation, separation of equipment: C2.12
 - shafts, lightweight construction: Spec C1.8
- Stairway**, external: D1.8
 - fire-isolated, construction: D2.2
 - landings, construction: D2.14
 - lift shafts: C2.11
 - non-fire-isolated, construction: D2.3
 - non-fire-isolated, travel: D1.9

non-required: D1.12 Spec D1.12

width: D2.9

Standard Fire Test, definition: A1.1

Fire-Resistance Level: Spec A2.3

Standards, adoption: A1.2, A1.3, Spec A1.3

STC, ratings for building elements: Spec F5.2

Steel, construction: B1.3

fire-resisting construction: Spec C1.1

Storey, calculation of rise: C1.2

definition: A1.1

Stormwater drainage: F1.1

Stretcher facility, in lifts: E3.2

Strongroom, operation of door latch: D2.21

refrigerated chambers and vaults: G1.2

Structural adequacy, Fire-Resistance Level, definition: A1.1

Structural member, definition: A1.1

Fire-Resistance Level: Spec A2.3

Structural performance: B1.1

Structural Provisions: Part B1

Structural steel members, Fire-Resistance Level: Spec C1.1, Spec A2.3

Structural tests, for lightweight construction: Spec C1.8

Structures, trafficable, alpine areas: G4.7

Sub-floor ventilation: F4.10

Subsoil drainage: F1.2

Suitability, of materials, construction or design: A2.1

Supporting parts, of buildings, fire protection: Spec C1.1

Swimming pool, definition: A1.1

requirements: G1.1

Swinging doors, required exits: D2.20

T

Telecommunication equipment, in exits, paths of travel: D2.7

Termite shields, damp-proof course: F1.9

Termites, protection: B1.3

Terracotta, roof tiles, installation: B1.3

weatherproofing: F1.5

Theatre, ceiling height: F3.1

discharge of exits: D1.10

emergency warning and intercommunication systems: E4.9

stages and public halls: Part H1

Thresholds, requirements: D2.15

Tilt-up doors, required exits: D2.19

Timber, construction: B1.3

floors, sub-floor ventilation: F4.10

Travel, distance, to exits: D1.4

via fire-isolated exits: D1.7

via non-fire-isolated stairways and ramps: D1.9

Treads and risers, dimensions: D2.13

Treatment room, ceiling height: F3.1

Type of construction, required: C1.1

fire-resistance: Spec C1.1 y

Class 1 buildings: C1.9 y

Class 4 buildings: C1.6 y

Class 10 buildings: C1.9 y

indoor sports stadiums: C1.7 y

mixed, fire-resistance: C1.4 y

open spectator stands: C1.7 y

U

United buildings: A4.1

alterations: A4.2

Urinals,

dimensions: F2.6

location: F4.8

sanitary facilities: Part F2

V

Valves, fire mains: Spec E1.2

Vapour barriers, floor on ground: F1.10

Vaults, operation of door latch: D2.21

strongrooms and refrigerated chambers: G1.2

Vehicular access, large isolated buildings: C2.3, C2.4

Ventilation and light: Part F4

Ventilation, of rooms: F4.5

exhaust: F4.9

fire emergency control centres: Spec E1.8

natural: F4.6

public car parks: F4.11

smoke: Part E2

sub-floor: F4.10

theatres and public halls: Spec H1.3

Ventilators, protection of openings: C3.1

Vents, roof, smoke control: E2.5

Vertical separation, of classifications: C2.9

compartmentation: C2.6

Volume, fire compartments: C2.2

W

Waiting room, ceiling height: F3.1

Walkways, fixed platforms and ladders: D2.18

Walls, between units, sound insulation: F5.4

non-loadbearing, lightweight construction: Spec C1.8

weatherproofing: F1.4

Warehouse, ceiling height: F3.1

Warm water installations, design and construction: F2.7

maintenance: E5.3

Warning sign, use of lifts in fire: E3.3

sliding fire door: C3.6

Warning systems, emergency lighting, exit signs: Part E4

Washbasins, dimensions: F2.6

Waste and soil pipes, sound insulation: F5.6

Water closets, location: F4.8

waterproofing: F1.7

Water heaters, household type, access: G1.3

Water supply, fire mains: E1.2, Spec E1.2

fire sprinklers: Spec E1.5

Waterproofing, of wet areas in buildings: F1.7

Weatherproofing, dampness: Part F1

of roofs and walls: F1.4

Weep holes, protection of openings: C3.1

Wet areas, in buildings, waterproofing: F1.7

Width, of stairways: D2.9

Wind load, structural requirements: B1.2

Window, definition: A1.1

fire-resistance of, Class 1 and 10 buildings: Spec C1.9

methods of protection of openings: C3.4

natural light: F4.2, F4.3

protection of openings: C3.1

smoke control: E2.1, E2.3

Wires and cables, protection of service penetrations: C3.15

X**Y****Z****ABBREVIATIONS AND SYMBOLS**

Abbreviations and Symbols used in the BCA include:

AISC	Australian Institute of Steel Construction
AS	Australian Standard
ASTM	American Society for Testing and Materials
AUBRCC	Australian Uniform Building Regulations Co-ordinating Council
BCA	Building Code of Australia
CSIRO	Commonwealth Scientific and Industrial Research Organisation
DBC&E	CSIRO Division of Building, Construction and Engineering
FRL	Fire Resistance Level
GRP	glass fibre reinforced polyester
ISO	International Organisation for Standardisation
MIMS	mineral insulated metal sheathed [cable]
NATA	National Association of Testing Authorities
NBTC	CSIRO National Building Technology Centre
PVC	polyvinyl chloride
SAA	Standards Australia [Standards Association of Australia]
STC	Sound Transmission Class
UPVC	unplasticised polyvinyl chloride

SYMBOLS(SI UNITS)

°C	degree(s) Celsius
K	kelvin(s)
kg	kilogram(s)
kg/m	kilogram(s) per metre
kg/m ²	kilogram(s) per square metre
kg/m ³	kilogram(s) per cubic metre
kPa	kilopascal(s)
kW/m ²	kilowatt(s) per square metre
L	litre(s)
L/s	litre(s) per second
L/s.m ²	litre(s) per second square metre
lx	lux
m	metre(s)

SUPERCEDED

m^2	square metre(s)
m^3	cubic metre(s)
m/s	metre(s) per second
m^3/s	cubic metre(s) per second
mm	millimetre(s)
mm^2	square millimetre(s)
μm	micrometer
MW	megawatt(s)
N	newton(s)
Pa	pascal(s)

***** ý