

**Incorporating
all 2009
amendments**



BCA 2009

Building Code of Australia

Class 2 and Class 9 Buildings

VOLUME ONE

CONTENTS AND FEATURES INTRODUCTION

General Table of Contents

Introduction

SUPERSEDED
CONTENTS AND FEATURES INTRODUCTION

© 2009 Australian Government and States and Territories of Australia

The *BCA 2009 (Volume One & Volume Two)* and the *Guide to the BCA* is the copyright of the Australian Government and States and Territories of Australia and, apart from any use as permitted under the Copyright Act 1998, no part may be reproduced without prior permission. Requests and enquiries concerning reproduction and rights should be directed in the first instance to the General Manager, Australian Building Codes Board, GPO Box 9839 Canberra ACT 2601.

Australian Building Codes Board

GPO Box 9839 Canberra ACT 2601

Telephone: Canberra 1300 134 631 *Facsimile:* + 61 2 6213 7287

Web Site: <http://www.abcb.gov.au>

Email: bca@abcb.gov.au

The Australian Building Codes Board (ABCB) is established by agreement between the Commonwealth Government and each State and Territory Government. It is a co-operative arrangement between the signatories, local government and the building industry.

ABCB Important Disclaimer

The ABCB gives no warranty or guarantee that Volume One of the BCA is correct or complete. The ABCB shall not be liable for any loss howsoever caused whether due to negligence or otherwise arising from the use of or reliance on Volume One of the BCA.

The ABCB recommends that anyone seeking to rely on Volume One of the BCA obtain their own independent expert advice in relation to building or related activities. Its interpretation in no way overrides the approvals processes in any jurisdiction.

BCA Customer Support

Telephone: 1300 134 631

Facsimile: +61 2 6290 8831

Email: bca@abcb.gov.au

ISBN 978-1-921453-46-5

GENERAL TABLE OF CONTENTS

CONTENTS AND FEATURES INTRODUCTION

Introduction	7
--------------------	---

SECTION A GENERAL PROVISIONS

Part A0 Application	13
Part A1 Interpretation	16
Part A2 Acceptance of Design and Construction	32
Part A3 Classification of Buildings and Structures	34
Part A4 United Buildings	37

SECTION B STRUCTURE

Part B1 Structural Provisions	64
-------------------------------------	----

SECTION C FIRE RESISTANCE

Part C1 Fire Resistance and Stability	80
Part C2 Compartmentation and Separation	85
Part C3 Protection of Openings	94

SECTION D ACCESS AND EGRESS

Part D1 Provision for Escape	152
Part D2 Construction of Exits	166
Part D3 Access for People with Disabilities	182

SECTION E SERVICES AND EQUIPMENT

Part E1 Fire Fighting Equipment	197
Part E2 Smoke Hazard Management	212
Part E3 Lift Installations	233
Part E4 Emergency Lighting, Exit Signs and Warning Systems	238

SUPERSEDED
CONTENTS AND FEATURES INTRODUCTION

SECTION F HEALTH AND AMENITY

Part F1	Damp and Weatherproofing	247
Part F2	Sanitary and Other Facilities	256
Part F3	Room Sizes	273
Part F4	Light and Ventilation	276
Part F5	Sound Transmission and Insulation	283

SECTION G ANCILLARY PROVISIONS

Part G1	Minor Structures and Components	303
Part G2	Heating Appliances, Fireplaces, Chimneys and Flues	308
Part G3	Atrium Construction	312
Part G4	Construction in Alpine Areas	322
Part G5	Construction in Bushfire Prone Areas	327

SECTION H SPECIAL USE BUILDINGS

Part H1	Theatres, Stages and Public Halls	332
----------------	--	-----

SECTION I MAINTENANCE

Part I1	Equipment and Safety Installations	338
Part I2	Energy Efficiency Installations	345

SECTION J ENERGY EFFICIENCY

Part J1	Building Fabric	364
Part J2	Glazing	375
Part J3	Building Sealing	402
Part J4	Air Movement	405
Part J5	Air-Conditioning and Ventilation Systems	408
Part J6	Artificial Lighting and Power	415
Part J7	Hot Water Supply	423
Part J8	Access for Maintenance	424

SUPERSEDED
CONTENTS AND FEATURES INTRODUCTION

STATE & TERRITORY APPENDICES

Appendix Commonwealth of Australia.....	448
Appendix Australian Capital Territory.....	453
Appendix New South Wales.....	461
Appendix Northern Territory.....	514
Appendix Queensland.....	538
Appendix South Australia.....	542
Appendix Tasmania.....	568
Appendix Victoria.....	636
Appendix Western Australia.....	670

INDEX ABBREVIATIONS AND SYMBOLS

Index.....	677
Abbreviations and Symbols.....	716

HISTORY OF BCA ADOPTION

History of BCA Adoption.....	720
------------------------------	-----

LIST OF AMENDMENTS

List of Amendments.....	735
-------------------------	-----

INTRODUCTION

THE BUILDING CODE OF AUSTRALIA

The Building Code of Australia (BCA) is produced and maintained by the Australian Building Codes Board (ABCB) on behalf of the Australian Government and each State and Territory Government.

The BCA is a uniform set of technical provisions for the design and construction of buildings and other structures throughout Australia whilst allowing for variations in climate and geological or geographic conditions.

THE AUSTRALIAN BUILDING CODES BOARD

The ABCB is established by agreement between the Australian Government and each State and Territory Government. It is a co-operative arrangement between the signatories, Local Government and the building industry.

The ABCB's mission is to address issues relating to health, safety, amenity and sustainability by providing for efficiency in the design, construction and performance of buildings through the BCA and the development of effective regulatory systems.

The Board comprises—

- (a) the Australian, State and Territory Governments' principal officer responsible for building regulatory matters; and
- (b) a representative of the Australian Local Government Association (ALGA); and
- (c) representatives of the building and construction industry.

The Building Codes Committee (BCC) is the peak technical advisory body to the ABCB, with responsibility for technical matters associated with the BCA.

The BCC comprises—

- (a) the General Manager of the ABCB; and
- (b) one nominee each of the Australian, State, Territory and ALGA members of the ABCB; and
- (c) representatives of the building and construction industry.

THE BCA — CONTENT

GOALS

The goal of the BCA is to enable the achievement of nationally consistent, minimum necessary standards of relevant health, safety (including structural safety and safety from fire), amenity and sustainability objectives efficiently.

This goal is applied so that—

- (a) there is a rigorously tested rationale for the regulation; and
- (b) the regulation generates benefits to society greater than the costs (that is, net benefits); and
- (c) the competitive effects of the regulation have been considered and the regulation is no more restrictive than necessary in the public interest; and
- (d) there is no regulatory or non-regulatory alternative that would generate higher net benefits.

SUPERSEDED CONTENTS AND FEATURES INTRODUCTION

FORMAT

The BCA is published in two volumes:

Volume One

pertains primarily to Class 2 to 9 buildings

Volume Two

pertains primarily to Class 1 and 10 buildings (houses, sheds, carports, etc)

Both volumes are drafted in a performance format to provide greater flexibility for the use of new and innovative building products, systems and designs.

A user may choose to comply with the *Deemed-to-Satisfy Provisions* or may use an *Alternative Solution* that satisfies the *Performance Requirements*.

The provisions in this edition are the same as those contained in the preceding edition of the BCA, plus changes as detailed in the list located at the back of the document.

STATE AND TERRITORY VARIATIONS AND ADDITIONS

Each State's and Territory's legislation adopts the BCA subject to the variation or deletion of some of its provisions, or the addition of extra provisions. These variations, deletions and additions are contained in Appendices to the BCA.

Flags identifying variations are located within relevant Clauses and at the beginning of relevant Tables. Additional clauses to a Part of the BCA are identified at the end of that Part.

DEFINITIONS

Words with special meanings are printed in italics and are defined in [A1.1](#).

LEGISLATIVE ARRANGEMENTS

GENERAL

The BCA is given legal effect by building regulatory legislation in each State and Territory. This legislation consists of an Act of Parliament and subordinate legislation which empowers the regulation of certain aspects of buildings and structures, and contains the administrative provisions necessary to give effect to the legislation.

Any provision of the BCA may be overridden by, or subject to, State or Territory legislation. The BCA must therefore be read in conjunction with that legislation. Any queries on such matters should be referred to the State or Territory authority responsible for building regulatory matters.

BCA ADOPTION

The adoption of the BCA is addressed in [Part A0](#) of Volume One.

DOCUMENTATION OF DECISIONS

Decisions made under the BCA should be fully documented and copies of all relevant documentation should be retained.

Examples of the kind of documentation which should be prepared and retained include:

- (a) Details of the *Building Solution* including all relevant plans and other supporting documentation.
- (b) In cases where an *Alternative Solution* has been proposed—
 - (i) details of the relevant *Performance Requirements*; and

SUPERSEDED

CONTENTS AND FEATURES INTRODUCTION

- (ii) the *Assessment Method* or methods used to establish compliance with the relevant *Performance Requirements*; and
- (iii) details of any *Expert Judgement* relied upon including the extent to which the judgement was relied upon and the qualifications and experience of the expert; and
- (iv) details of any tests or calculations used to determine compliance with the relevant *Performance Requirements*; and
- (v) details of any Standards or other information which were relied upon.

STRUCTURE

The BCA has been structured as set out in [A0.3](#) and shown in [Figure A0.3](#). It is the ABCB's intent that the *Objectives* and *Functional Statements* be used as an aid to the interpretation of the BCA and not for determining compliance with the BCA.

FURTHER DEVELOPMENT OF THE BCA

Regular changes are planned to the BCA to improve clarity of provisions, upgrade referenced documents and to reflect the results of research and improved technology.

COMMENTS

Comments in writing on any matter concerning the text, presentation or further development of the BCA are invited from building and other authorities, industry organisations, professional operatives and the public generally. These comments should be addressed to:

General Manager

Australian Building Codes Board

GPO Box 9839

CANBERRA ACT 2601

GENERAL PROVISIONS

- A0 Application**
- A1 Interpretation**
- A2 Acceptance of Design and Construction**
- A3 Classification of Buildings and Structures**
- A4 United Buildings**

SECTION A CONTENTS

SECTION A GENERAL PROVISIONS

Part A0 Application

- A0.1 Adoption
- A0.2 BCA Volumes
- A0.3 BCA Structure
- A0.4 Compliance with the BCA
- A0.5 Meeting the Performance Requirements
- A0.6 Objectives and Functional Statements
- A0.7 Deemed-to-Satisfy Provisions
- A0.8 Alternative Solutions
- A0.9 Assessment Methods
- A0.10 Relevant Performance Requirements

Part A1 Interpretation

- A1.1 Definitions
- A1.2 Adoption of Standards and other references
- A1.3 Referenced Standards, etc
- A1.4 Differences between referenced documents and the BCA
- A1.5 Compliance with all Sections of BCA
- A1.6 Application of the BCA to a particular State or Territory
- A1.7 Language

Part A2 Acceptance of Design and Construction

- A2.1 Suitability of materials
- A2.2 Evidence of suitability
- A2.3 Fire-resistance of building elements
- A2.4 Fire hazard properties
- A2.5 Resistance to the incipient spread of fire

Part A3 Classification of Buildings and Structures

- A3.1 Principles of classification
- A3.2 Classifications
- A3.3 Multiple classification
- A3.4 Parts with more than one classification

Part A4 United Buildings

- A4.1 When buildings are united
- A4.2 Alterations in a united building

Specifications

- Specification A1.3 Documents Adopted By Reference

Specification A2.3 Fire-Resistance of Building Elements
Specification A2.4 Fire Hazard Properties

ACT Appendix (Additional provisions and variations — refer to ACT Contents for full details)

NSW Appendix (Additional provisions and variations — refer to NSW Contents for full details)

NT Appendix (Additional provisions and variations — refer to NT Contents for full details)

Qld Appendix (Additional provisions and variations — refer to Qld Contents for full details)

SA Appendix (Additional provisions and variations — refer to SA Contents for full details)

Tas Appendix (Additional provisions and variations — refer to Tas Contents for full details)

Vic Appendix (Additional provisions and variations — refer to Vic Contents for full details)

PART A0 APPLICATION

A0.1 Adoption

The dates of adoption of the Building Code of Australia (Volume One) are shown in the “History of BCA Adoption” division at the end of this Volume.

A0.2 BCA Volumes

- (a) The Building Code of Australia consists of two volumes, Volume One and Volume Two.
- (b) This is Volume One of the Building Code of Australia which contains the requirements for—
 - (i) all Class 2 to 9 buildings; and
 - (ii) access requirements for people with disabilities in Class 10a buildings; and
 - (iii) certain Class 10b structures.
- (c) Volume Two contains the requirements for—
 - (i) Class 1 and 10a buildings (other than access requirements for people with disabilities in Class 10a buildings); and
 - (ii) certain Class 10b structures.

A0.3 BCA Structure

The structure of the BCA comprises the following as shown in **Figure A0.3**:

- (a) The *Objectives*.
- (b) The *Functional Statements*.
- (c) The *Performance Requirements* with which all *Building Solutions* must comply.
- (d) The *Building Solutions*.

Figure A0.3 — BCA Structure

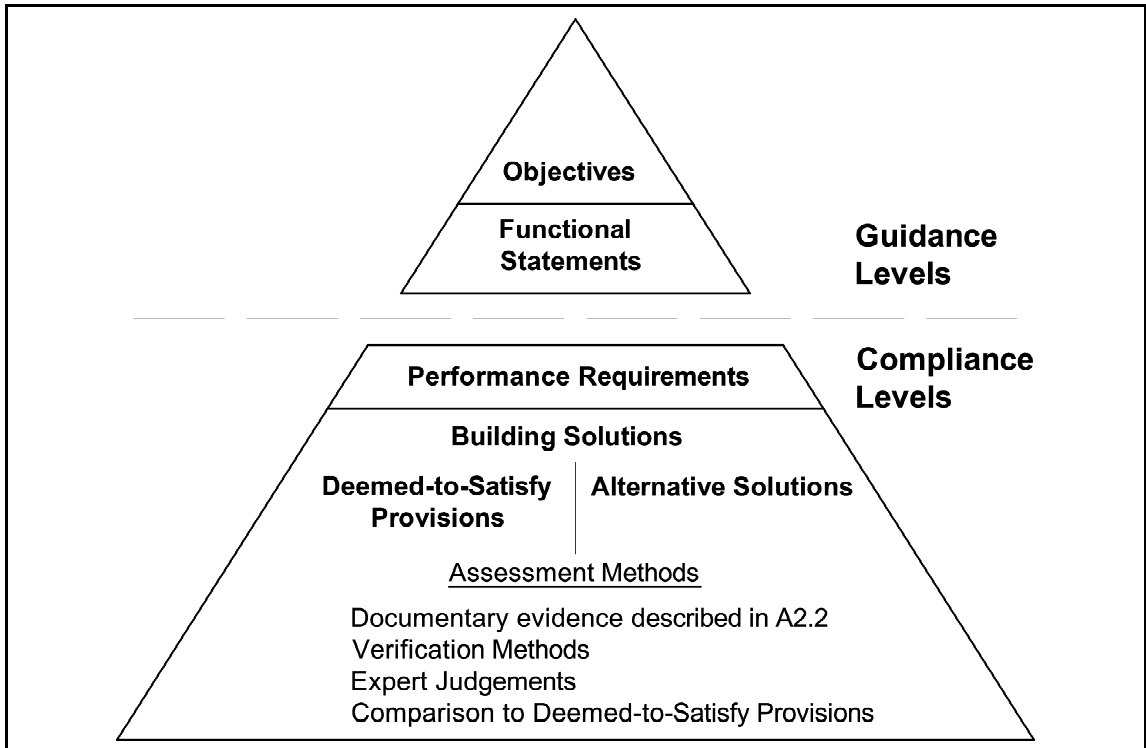

A0.4 Compliance with the BCA

A *Building Solution* will comply with the BCA if it satisfies the *Performance Requirements*.

A0.5 Meeting the Performance Requirements

Compliance with the *Performance Requirements* can only be achieved by—

- (a) complying with the *Deemed-to-Satisfy Provisions*; or
- (b) formulating an *Alternative Solution* which—
 - (i) complies with the *Performance Requirements*; or
 - (ii) is shown to be at least *equivalent* to the *Deemed-to-Satisfy Provisions*; or
- (c) a combination of (a) and (b).

A0.6 Objectives and Functional Statements

The *Objectives* and *Functional Statements* may be used as an aid to interpretation.

A0.7 Deemed-to-Satisfy Provisions

A *Building Solution* which complies with the *Deemed-to-Satisfy Provisions* is deemed to comply with the *Performance Requirements*.

A0.8 Alternative Solutions

- (a) An *Alternative Solution* must be assessed according to one or more of the *Assessment Methods*.
- (b) An *Alternative Solution* will only comply with the BCA if the *Assessment Methods* used to determine compliance with the *Performance Requirements* have been satisfied.
- (c) The *Performance Requirements* relevant to an *Alternative Solution* must be determined in accordance with **A0.10**.

A0.9 Assessment Methods

The following *Assessment Methods*, or any combination of them, can be used to determine that a *Building Solution* complies with the *Performance Requirements*:

- (a) Evidence to support that the use of a material, form of construction or design meets a *Performance Requirement* or a *Deemed-to-Satisfy Provision* as described in **A2.2**.
- (b) *Verification Methods* such as—
 - (i) the *Verification Methods* in the BCA; or
 - (ii) such other *Verification Methods* as the appropriate authority accepts for determining compliance with the *Performance Requirements*.
- (c) Comparison with the *Deemed-to-Satisfy Provisions*.
- (d) *Expert Judgement*.

A0.10 Relevant Performance Requirements

In order to comply with the provisions of **A1.5** (to comply with Sections A to J inclusive) the following method must be used to determine the *Performance Requirement* or *Performance Requirements* relevant to the *Alternative Solution*:

- (a) Identify the relevant *Deemed-to-Satisfy Provision* of each Section or Part that is to be the subject of the *Alternative Solution*.
- (b) Identify the *Performance Requirements* from the same Sections or Parts that are relevant to the identified *Deemed-to-Satisfy Provisions*.
- (c) Identify *Performance Requirements* from other Sections and Parts that are relevant to any aspects of the *Alternative Solution* proposed or that are affected by the application of the *Deemed-to-Satisfy Provisions*, that are the subject of the *Alternative Solution*.

PART A1 INTERPRETATION

A1.1 Definitions

For additional definitions see NSW Appendix, Qld Appendix, Tas Appendix, Vic Appendix

In Volume One of the BCA unless the contrary intention appears—

Accessible means having features to permit use by people with disabilities.

Accessway means a continuous *accessible* path of travel to or within a building suitable for people with disabilities as defined in AS 1428.1.

Aged care building means a Class 9c building for residential accommodation of aged persons who, due to varying degrees of incapacity associated with the ageing process, are provided with *personal care services* and 24 hour staff assistance to evacuate the building during an emergency.

Air-conditioning, for the purposes of **Section J**, means a *service* that actively cools or heats the air within a space, but does not include a *service* that directly cools or heats cold rooms or hot rooms.

Alpine area means land—

- (a) likely to be subject to significant snowfalls;
- (b) in New South Wales, A.C.T. or Victoria more than 1200 m above the Australian Height Datum; and
- (c) in Tasmania more than 900 m above the Australian Height Datum.

Alteration, in relation to a building, includes an addition or extension to a building.

Alternative Solution means a *Building Solution* which complies with the *Performance Requirements* other than by reason of satisfying the *Deemed-to-Satisfy Provisions*.

Annual energy consumption means the theoretical amount of energy used annually by the building's *services*, excluding kitchen exhaust and the like.

Assembly building means a building where people may assemble for—

- (a) civic, theatrical, social, political or religious purposes including a library, theatre, public hall or place of worship; or
- (b) educational purposes in a *school*, *early childhood centre*, preschool, or the like; or
- (c) entertainment, recreational or sporting purposes including—
 - (i) a discotheque, nightclub or a bar area of a hotel or motel providing live entertainment or containing a dance floor; or
 - (ii) a cinema; or
 - (iii) a sports stadium, sporting or other club; or
- (d) transit purposes including a bus station, railway station, airport or ferry terminal.

Assessment Method means a method used for determining that a *Building Solution* complies with the *Performance Requirements*.

Atrium means a space within a building that connects 2 or more *storeys*, and—

- (a) is wholly or substantially enclosed at the top by a floor or roof (including a glazed roof structure); and
- (b) includes any adjacent part of the building not separated by an appropriate barrier to fire; but
- (c) does not include a stairwell, rampwell or the space within a *shaft*.

Atrium well means a space in an *atrium* bounded by the perimeter of the openings in the floors or by the perimeter of the floors and the *external walls*.

Automatic means designed to operate when activated by a heat, smoke or fire sensing device.

Average recurrence interval, applied to rainfall, means the expected or average interval between exceedances of a given intensity.

Average specific extinction area means the average specific extinction area for smoke as determined by AS/NZS 3837.

Backstage means a space associated with, and adjacent to, a *stage* in a Class 9b building for scenery, props, equipment, dressing rooms, or the like.

Building Solution means a solution which complies with the *Performance Requirements* and is—

- (a) an *Alternative Solution*; or
- (b) a solution which complies with the *Deemed-to-Satisfy Provisions*; or
- (c) a combination of (a) and (b).

Carpark means a building that is used for the parking of motor vehicles but is neither a *private garage* nor used for the servicing of vehicles, other than washing, cleaning or polishing.

Certificate of Accreditation means a certificate issued by a State or Territory accreditation authority stating that the properties and performance of a building material or method of construction or design fulfill specific requirements of the BCA.

Certificate of Conformity means a certificate issued under the ABCB scheme for products and systems certification stating that the properties and performance of a building material or method of construction or design fulfill specific requirements of the BCA.

Climate Zone means an area defined in **Figure A1.1** and in **Table A1.1** for specific locations, having energy efficiency provisions based on a range of similar climatic characteristics.

Figure A1.1 — CLIMATE ZONES FOR THERMAL DESIGN

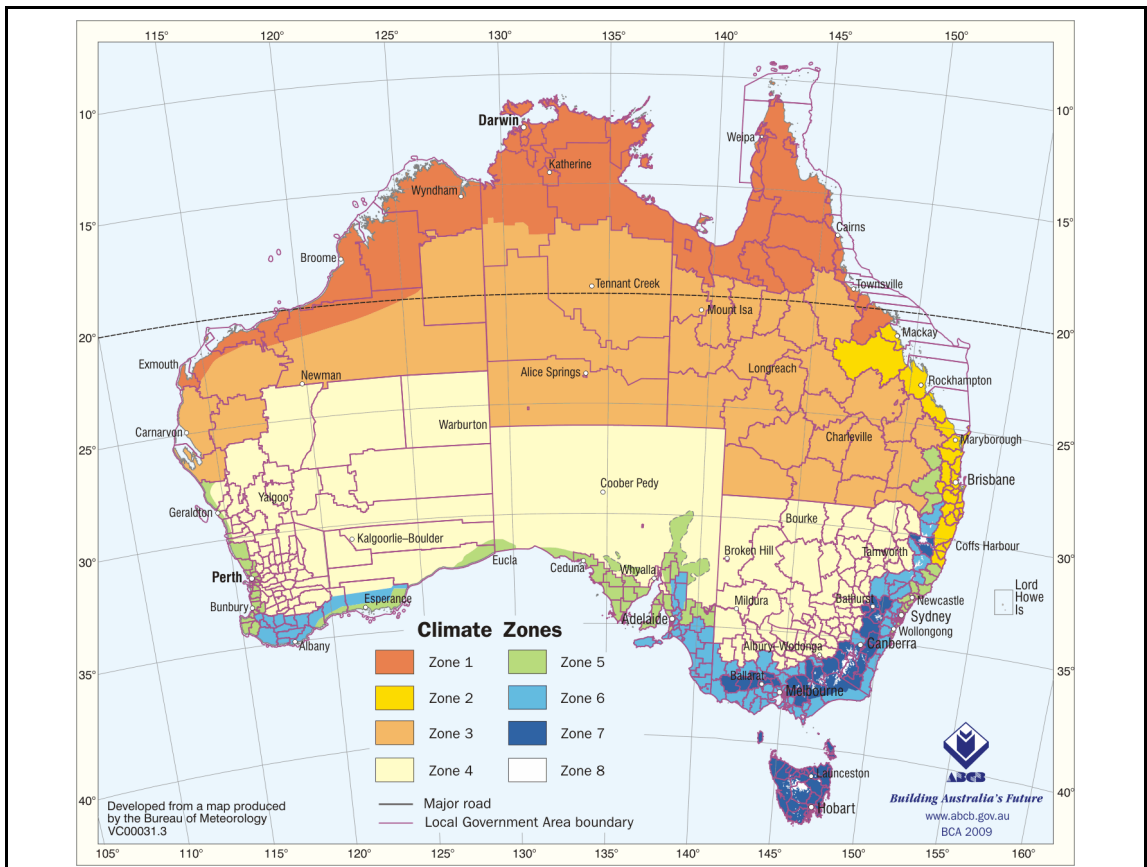

Notes:

1. This map can be viewed in enlargeable form on the Energy Efficiency page of the ABCB web site at www.abcb.gov.au.
2. A Zone 4 area in South Australia, other than a council area, at an altitude greater than 300 m above the Australian Height Datum is to be considered as Zone 5.

Table A1.1 CLIMATE ZONES FOR THERMAL DESIGN - VARIOUS LOCATIONS

Location	Climate zone	Location	Climate zone	Location	Climate zone	Location	Climate zone
Australian Capital Territory				Canberra	7		
New South Wales							
Albury	4	Byron Bay	2	Lord Howe Island	2	Sydney West	6
Armidale	7	Cobar	4	Moree	4	Tamworth	4
Batemans Bay	6	Coffs Harbour	2	Newcastle	5	Thredbo	8
Bathurst	7	Dubbo	4	Nowra	6	Wagga Wagga	4
Bega	6	Goulburn	7	Orange	7	Williamtown	5
Bellingen Shire - Dorrigo Plateau	7	Grafton	2	Perisher Smiggins	8	Wollongong	5
Bellingen Shire - Valley & seaboard	2	Griffith	4	Port Macquarie	5	Yass	6
Bourke	4	Ivanhoe	4	Sydney East	5		
Broken Hill	4	Lismore	2				
Northern Territory							
Alice Springs	3	Elliot	3	Renner Springs	3		
Darwin	1	Katherine	1	Tennant Creek	3		
Queensland							
Birdsville	3	Cunnamulla	3	Maryborough	2	Toowoomba	5
Brisbane	2	Longreach	3	Mount Isa	3	Torrens Creek	3
Bundaberg	2	Gladstone	2	Normanton	1	Townsville	1
Cairns	1	Labrador	2	Rockhampton	2	Warwick	5
Cooktown	1	Mackay	2	Roma	3	Weipa	1
South Australia							
Adelaide	5	Kingscote	6	Marree	4	Port Lincoln	5
Bordertown	6	Leigh Creek	5	Mount Gambier	6	Renmark	5
Ceduna	5	Lobethal	6	Murray Bridge	6	Tarcoola	4
Cook	4	Loxton	5	Oodnadatta	4	Victor Harbour	6
Elliston	5	Naracoorte	6	Port Augusta	4	Whyalla	4
Tasmania							
Burnie	7	Flinders Island	7	Launceston	7	Rossarden	7
Bicheno	7	Hobart	7	New Norfolk	7	Smithton	7
Deloraine	7	Huonville	7	Oatlands	7	St Marys	7
Devonport	7	King Island	7	Orford	7	Zeehan	7

Table A1.1 CLIMATE ZONES FOR THERMAL DESIGN - VARIOUS LOCATIONS— continued

Location	Climate zone	Location	Climate zone	Location	Climate zone	Location	Climate zone
Victoria							
Anglesea	6	Bright	7	Horsham	6	Swan Hill	4
Ararat	7	Colac	6	Melbourne	6	Traralgon	6
Bairnsdale	6	Dandenong	6	Mildura	4	Wangaratta	7
Ballarat	7	Echuca	4	Portland	6	Warrnambool	6
Benalla	6	Geelong	6	Sale	6	Wodonga	6
Bendigo	6	Hamilton	7	Shepparton	4		
Western Australia							
Albany	6	Cocos Island	1	Kalgoorlie-Boulder	4	Port Hedland	1
Balladonia	4	Derby	1	Karratha	1	Wagin	4
Broome	1	Esperance	5	Meekatharra	4	Wyndham	1
Bunbury	5	Exmouth	1	Northam	4		
Carnarvon	3	Geraldton	5	Pemberton	6		
Christmas Island	1	Halls Creek	3	Perth	5		

Combustible means—

- (a) Applied to a material — *combustible* as determined by AS 1530.1.
- (b) Applied to construction or part of a building — constructed wholly or in part of *combustible* materials.

Common wall means a wall that is common to adjoining buildings.

Conditioned space means a space within a building where the environment is likely, by the intended use of the space, to be controlled by *air-conditioning*, but does not include—

- (a) a non-*habitable room* of a Class 2 building or Class 4 part of a building in which a heater with a capacity of not more than 1.2 kW provides the *air-conditioning*; or
- (b) a space in a Class 6, 7, 8 or 9b building where the input power to an *air-conditioning* system is not more than 15 W/m².

Construction activity actions means actions due to stacking of building materials or the use of equipment, including cranes and trucks, during construction or actions which may be induced by floor to floor propping.

Cooling load means the calculated amount of energy removed from the cooled spaces of the building annually, by artificial means, to maintain the desired temperatures in those spaces.

Critical radiant flux means the critical heat flux at extinguishment as determined by AS ISO 9239.1.

Curtain wall means a non-*loadbearing external wall* that is not a *panel wall*.

Deemed-to-Satisfy Provisions means provisions which are deemed to satisfy the *Performance Requirements*.

(NSW, Designated bushfire prone area)

Designated bushfire prone area means land which has been designated under a power of legislation as being subject, or likely to be subject, to bushfires.

Detention centre means a building in which persons are securely detained by means of the built structure including a prison, remand centre, juvenile *detention centre*, holding cells or psychiatric *detention centre*.

(NSW, Early childhood centre)

(Tas, Early childhood centre)

(Vic, Early childhood centre)

Early childhood centre means a preschool, kindergarten or child-minding centre.

Effective height means the height to the floor of the topmost *storey* (excluding the topmost *storey* if it contains only heating, ventilating, lift or other equipment, water tanks or similar service units) from the floor of the lowest *storey* providing direct egress to a road or *open space*.

Envelope, for the purposes of **Section J**, means the parts of a building's *fabric* that separate a *conditioned space* or *habitable room* from—

- (a) the exterior of the building; or
- (b) a non-*conditioned space* including—
 - (i) the floor of a rooftop plant room, lift-machine room or the like; and
 - (ii) the floor above a *carpark* or warehouse; and
 - (iii) the *common wall* with a *carpark*, warehouse or the like,

other than a non-*conditioned space* through which conditioned air is being exhausted or relieved such as an internal corridor, cleaner's room, chemical storage room or exhaust riser.

Equivalent means equivalent to the level of health, safety and amenity provided by the *Deemed-to-Satisfy Provisions*.

Evacuation route means the continuous path of travel (including *exits*, *public corridors* and the like) from any part of a building, including within a *sole-occupancy unit* in a Class 2 or 3 building or Class 4 part, to a *safe place*.

Evacuation time means the time calculated from when the emergency starts for the occupants of the building to evacuate to a *safe place*.

Exit means—

- (a) Any, or any combination of the following if they provide egress to a road or *open space*—
 - (i) An internal or external stairway.
 - (ii) A ramp.
 - (iii) A *fire-isolated passageway*.
 - (iv) A doorway opening to a road or *open space*.
- (b) A *horizontal exit* or a *fire-isolated passageway* leading to a *horizontal exit*.

Expert Judgement means the judgement of an expert who has the qualifications and experience to determine whether a *Building Solution* complies with the *Performance Requirements*.

External wall means an outer wall of a building which is not a *common wall*.

Fabric means the basic building structural elements and components of a building including the roof, ceilings, walls and floors.

Fire brigade means a statutory authority constituted under an Act of Parliament having as one of its functions, the protection of life and property from fire and other emergencies.

Fire compartment means—

- (a) the total space of a building; or
- (b) when referred to in—
 - (i) the *Objective, Functional Statement* or *Performance Requirements* — any part of a building separated from the remainder by barriers to fire such as walls and/or floors having an appropriate resistance to the spread of fire with any openings adequately protected; or
 - (ii) the *Deemed-to-Satisfy Provisions* — any part of a building separated from the remainder by walls and/or floors each having an FRL not less than that *required* for a *fire wall* for that type of construction and where all openings in the separating construction are protected in accordance with the *Deemed-to-Satisfy Provisions* of the relevant Part.

Fire hazard means the danger in terms of potential harm and degree of exposure arising from the start and spread of fire and the smoke and gases that are thereby generated.

Fire hazard properties means the following properties of a material or assembly that indicate how they behave under specific fire test conditions:

- (a) *Average specific extinction area, critical radiant flux* and *Flammability Index*, determined as defined in **A1.1**.
- (b) *Smoke-Developed Index, smoke growth rate index, smoke development rate* and *Spread-of-Flame Index*, determined in accordance with **Specification A2.4**.

Fire intensity means the rate release of calorific energy in watts, determined either theoretically or empirically, as applicable.

Fire-isolated passageway means a corridor, hallway or the like, of *fire-resisting construction*, which provides egress to or from a *fire-isolated stairway* or *fire-isolated ramp* or to a road or *open space*.

Fire-isolated ramp means a ramp within a *fire-resisting* enclosure which provides egress from a *storey*.

Fire-isolated stairway means a stairway within a *fire-resisting shaft* and includes the floor and roof or top enclosing structure.

Fire load means the sum of the net calorific values of the *combustible* contents which can reasonably be expected to burn within a *fire compartment*, including furnishings, built-in and removable materials, and building elements. The calorific values must be determined at the ambient moisture content or humidity. (The unit of measurement is MJ.)

Fire-protective covering means—

- (a) 13 mm fire-protective grade plasterboard; or
- (b) 12 mm cellulose cement flat sheeting complying with AS/NZS 2908.2 or ISO 8336; or
- (c) 12 mm fibrous plaster reinforced with 13 mm x 13 mm x 0.7 mm galvanised steel wire mesh located not more than 6 mm from the exposed face; or
- (d) other material not less fire-protective than 13 mm fire-protective grade plasterboard, fixed in accordance with the normal trade practice for a *fire-protective covering*.

Fire-resistance level (FRL) means the grading periods in minutes determined in accordance with **Specification A2.3**, for the following criteria—

- (a) *structural adequacy*; and
- (b) *integrity*; and
- (c) *insulation*,

and expressed in that order.

Note:

A dash means that there is no requirement for that criterion. For example, 90/-- means there is no requirement for an FRL for integrity and insulation, and --/-- means there is no requirement for an FRL.

Fire-resisting, applied to a building element, means having an FRL appropriate for that element.

Fire-resisting construction means one of the Types of construction referred to in **Part C1**.

Fire safety system means one or any combination of the methods used in a building to—

- (a) warn people of an emergency; or
- (b) provide for safe evacuation; or
- (c) restrict the spread of fire; or
- (d) extinguish a fire,

and includes both active and passive systems.

Fire-source feature means—

- (a) the far boundary of a road, river, lake or the like adjoining the allotment; or
- (b) a side or rear boundary of the allotment; or
- (c) an *external wall* of another building on the allotment which is not a Class 10 building.

Fire wall means a wall with an appropriate resistance to the spread of fire that divides a *storey* or building into *fire compartments*.

Flashover, in relation to *fire hazard properties*, means a heat release rate of 1 MW.

Flammability Index means the index number as determined by AS 1530.2.

Flight means that part of a stairway that has a continuous series of risers, including risers of winders, not interrupted by a landing or floor.

Floor area means—

- (a) in relation to a building — the total area of all *storeys*; and
- (b) in relation to a *storey* — the area of all floors of that *storey* measured over the enclosing walls, and includes—
 - (i) the area of a *mezzanine* within the *storey*, measured within the finished surfaces of any *external walls*; and
 - (ii) the area occupied by any *internal walls* or partitions, any cupboard, or other built-in furniture, fixture or fitting; and
 - (iii) if there is no enclosing wall, an area which has a use that—
 - (A) contributes to the *fire load*; or
 - (B) impacts on the safety, health or amenity of the occupants in relation to the provisions of the BCA; and
- (c) in relation to a room — the area of the room measured within the finished surfaces of the walls, and includes the area occupied by any cupboard or other built-in furniture, fixture or fitting; and
- (d) in relation to a *fire compartment* — the total area of all floors within the *fire compartment* measured within the finished surfaces of the bounding construction, and if there is no bounding construction, includes an area which has a use which contributes to the *fire load*; and
- (e) in relation to an *atrium* — the total area of all floors within the *atrium* measured within the finished surfaces of the bounding construction and if no bounding construction, within the *external walls*.

Functional Statement means a statement which describes how a building achieves the *Objective*.

Glazing, for the purposes of **Section J**, means a transparent or translucent element and its supporting frame located in the *envelope*, and includes a *window* other than a *roof light*.

Group number means the number of one of 4 groups of materials used in the regulation of *fire hazard properties* and applied to materials used as a finish, surface, lining, or attachment to a wall or ceiling.

Habitable room means a room used for normal domestic activities, and—

- (a) includes a bedroom, living room, lounge room, music room, television room, kitchen, dining room, sewing room, study, playroom, family room, home theatre and sunroom; but
- (b) excludes a bathroom, laundry, water closet, pantry, walk-in wardrobe, corridor, hallway, lobby, photographic darkroom, clothes-drying room, and other spaces of a specialised nature occupied neither frequently nor for extended periods.

Health-care building means a building whose occupants or patients undergoing medical treatment generally need physical assistance to evacuate the building during an emergency and includes—

- (a) a public or private hospital; or
- (b) a nursing home or similar facility for sick or disabled persons needing full-time care; or
- (c) a clinic, day surgery or procedure unit where the effects of the predominant treatment administered involve patients becoming non-ambulatory and requiring supervised medical care on the premises for some time after the treatment.

Heating load means the calculated amount of energy delivered to the heated spaces of the building annually, by artificial means, to maintain the desired temperatures in those spaces.

Horizontal exit means a *required* doorway between 2 parts of a building separated from each other by a *fire wall*.

Illuminance means the luminous flux falling onto a unit area of surface.

Illumination power density means the total of the power that will be consumed by the lights in a space, including any lamps, ballasts, current regulators and control devices other than those that are plugged into socket outlets for intermittent use such as floor standing lamps, desk lamps or work station lamps, divided by the *floor area* of the space.

Insulation, in relation to an FRL, means the ability to maintain a temperature on the surface not exposed to the furnace below the limits specified in AS 1530.4.

Integrity, in relation to an FRL, means the ability to resist the passage of flames and hot gases specified in AS 1530.4.

Internal wall excludes a *common wall* or a party wall.

Lamp power density means the total of the maximum power rating of the lamps in a space, other than those that are plugged into socket outlets for intermittent use such as floor standing lamps, desk lamps or work station lamps, divided by the *floor area* of the space.

Latent heat gain means the heat gained by the vapourising of liquid without change of temperature.

Light source efficacy means the luminous flux of a lamp or the total radiant flux in the visible spectrum weighted by the spectral response of the eye, divided by the electric power that will be consumed by the lamp but excluding ballast and control gear power losses.

Lightweight construction means construction which incorporates or comprises—

- (a) sheet or board material, plaster, render, sprayed application, or other material similarly susceptible to damage by impact, pressure or abrasion; or
- (b) concrete and concrete products containing pumice, perlite, vermiculite, or other soft material similarly susceptible to damage by impact, pressure or abrasion; or
- (c) masonry having a thickness less than 70 mm.

Loadbearing means intended to resist vertical forces additional to those due to its own weight.

Mezzanine means an intermediate floor within a room.

Motor input power means the amount of power that is delivered to a motor from the power supply.

Motor shaft power means the amount of power that a motor is capable of delivering at its output shaft, which equates to the *motor input power* adjusted by the losses in the motor.

Non-combustible means—

- (a) Applied to a material — not deemed *combustible* as determined by AS 1530.1 — Combustibility Tests for Materials.
- (b) Applied to construction or part of a building — constructed wholly of materials that are not deemed *combustible*.

Objective means a statement contained in the BCA which is considered to reflect community expectations.

Open-deck carpark means a carpark in which all parts of the parking *storeys* are cross-ventilated by permanent unobstructed openings in not fewer than 2 opposite or approximately opposite sides, and—

- (a) each side that provides ventilation is not less than 1/6 of the area of any other side; and
- (b) the openings are not less than ½ of the wall area of the side concerned.

Open space means a space on the allotment, or a roof or similar part of a building adequately protected from fire, open to the sky and connected directly with a public road.

Open spectator stand means a tiered stand substantially open at the front.

Other property means all or any of the following—

- (a) any building on the same or an adjoining allotment; and
- (b) any adjoining allotment; and
- (c) a road.

Outdoor air means air outside the building.

Outdoor air economy cycle is a mode of operation of an *air-conditioning* system that, when the outside air thermodynamic properties are favourable, increases the quantity of outside air used to condition the space.

Outfall means that part of the disposal system receiving *surface water* from the drainage system and may include a natural water course, kerb and channel, or soakage system.

Panel wall means a non-*loadbearing external wall*, in frame or similar construction, that is wholly supported at each *storey*.

Patient care area means a part of a *health-care building* normally used for the treatment, care, accommodation, recreation, dining and holding of patients including a *ward area* and *treatment area*.

Performance Requirement means a requirement which states the level of performance which a *Building Solution* must meet.

Personal care services means any of the following:

- (a) The provision of nursing care.
- (b) Assistance or supervision in—
 - (i) bathing, showering or personal hygiene; or
 - (ii) toileting or continence management; or
 - (iii) dressing or undressing; or
 - (iv) consuming food.
- (c) The provision of direct physical assistance to a person with mobility problems.
- (d) The management of medication.
- (e) The provision of substantial rehabilitative or development assistance.

Piping, for the purposes of **Section J**, means an assembly of pipes, with or without valves or other fittings, connected together for the conveyance of liquids.

Primary building element means a member of a building designed specifically to take part of the loads specified in **B1.2** or **B1.3** and includes roof, ceiling, floor, stairway or ramp and wall framing members including bracing members designed for the specific purpose of acting as a brace to those members.

Private garage means—

- (a) any garage associated with a Class 1 building; or
- (b) any single *storey* of a building of another Class capable of accommodating not more than 3 vehicles, if there is only one such *storey* in the building; or
- (c) any separate single *storey* garage associated with another building where such garage is capable of accommodating not more than 3 vehicles.

Professional engineer means a person who is—

- (a) if legislation is applicable — a registered *professional engineer* in the relevant discipline who has appropriate experience and competence in the relevant field; or
- (b) if legislation is not applicable—
 - (i) a Corporate Member of the Institution of Engineers, Australia; or
 - (ii) eligible to become a Corporate Member of the Institution of Engineers, Australia, and has appropriate experience and competence in the relevant field.

Public corridor means an enclosed corridor, hallway or the like which—

- (a) serves as a means of egress from 2 or more *sole-occupancy units* to a *required exit* from the *storey* concerned; or
- (b) is *required* to be provided as a means of egress from any part of a *storey* to a *required exit*.

R-Value means the thermal resistance (m².K/W) of a component calculated by dividing its thickness by its thermal conductivity.

Reference building means a hypothetical building that is used to calculate the maximum allowable annual energy load, or maximum allowable *annual energy consumption* for the proposed building.

Reflective insulation means a building membrane with a reflective surface such as a reflective foil laminate, reflective barrier, foil batt or the like capable of reducing radiant heat flow.

Registered Testing Authority means—

- (a) an organisation registered by the National Association of Testing Authorities (NATA) to test in the relevant field; or
- (b) an organisation outside Australia registered by an authority recognised by NATA through a mutual recognition agreement; or
- (c) an organisation recognised as being a *Registered Testing Authority* under legislation at the time the test was undertaken.

Required means *required* to satisfy a *Performance Requirement* or a *Deemed-to-Satisfy Provision* of the BCA as appropriate.

Residential aged care building means a building whose residents, due to their incapacity associated with the ageing process, are provided with physical assistance in conducting their daily activities and to evacuate the building during an emergency.

Resident use area means part of a Class 9c *aged care building* normally used by residents, and—

- (a) includes *sole-occupancy units*, lounges, dining areas, activity rooms and the like; but
- (b) excludes offices, storage areas, commercial kitchens, commercial laundries and other spaces not for the use of residents.

Resistance to the incipient spread of fire, in relation to a ceiling membrane, means the ability of the membrane to insulate the space between the ceiling and roof, or ceiling and floor above, so as to limit the temperature rise of materials in this space to a level which will not permit the rapid and general spread of fire throughout the space.

Rise in storeys means the greatest number of *storeys* calculated in accordance with **C1.2**.

Roof light, for the purposes of **Section J**, means a skylight, *window* or the like installed in a roof—

- (a) to permit natural light to enter the room below; and
- (b) at an angle between 0 and 70 degrees measured from the horizontal plane.

Safe place means—

- (a) a place of safety within a building—
 - (i) which is not under threat from a fire; and
 - (ii) from which people must be able to safely disperse after escaping the effects of an emergency to a road or *open space*; or
- (b) a road or *open space*.

Safety measure means any measure (including an item of equipment, form of construction or safety strategy) *required* to ensure the safety of persons using the building.

Sanitary compartment means a room or space containing a closet pan or urinal.

Sarking-type material means a material such as a *reflective insulation* or other flexible membrane of a type normally used for a purpose such as water proofing, vapour proofing or thermal reflectance.

School includes a primary or secondary *school*, college, university or similar educational establishment.

Self-closing, applied to a door, means equipped with a device which returns the door to the fully closed position immediately after each opening.

Sensible heat gain means the heat gained which causes a change in temperature.

Service, for the purposes of **Part I2** and **Section J**, means a mechanical or electrical system that uses energy to provide *air-conditioning*, mechanical ventilation, hot water supply, artificial lighting, vertical transport and the like within a building, but which does not include—

- (a) systems used solely for emergency purposes; and
- (b) cooking facilities; and
- (c) portable appliances.

Service station means a garage which is not a *private garage* and is for the servicing of vehicles, other than only washing, cleaning or polishing.

Shaft means the walls and other parts of a building bounding—

- (a) a well, other than an *atrium well*; or
- (b) a vertical chute, duct or similar passage, but not a chimney or flue.

Site means the part of the allotment of land on which a building stands or is to be erected.

Sitework means work on or around a *site*, including earthworks, preparatory to or associated with the construction, *alteration*, demolition or removal of a building.

Smoke-and-heat vent means a vent, located in or near the roof for smoke and hot gases to escape if there is a fire in the building.

Smoke-Developed Index means the index number for smoke as determined by AS/NZS 1530.3.

Smoke development rate means the development rate for smoke as determined by testing flooring materials in accordance with AS ISO 9239.1.

Smoke growth rate index (SMOGR_{RC}) means the index number for smoke used in the regulation of *fire hazard properties* and applied to materials used as a finish, surface, lining or attachment to a wall or ceiling.

Solar Heat Gain Coefficient (SHGC) means the fraction of incident irradiance on *glazing* or a *roof light* that adds heat to a building's space.

Sole-occupancy unit means a room or other part of a building for occupation by one or joint owner, lessee, tenant, or other occupier to the exclusion of any other owner, lessee, tenant, or other occupier and includes—

- (a) a dwelling; or
- (b) a room or suite of rooms in a Class 3 building which includes sleeping facilities; or
- (c) a room or suite of associated rooms in a Class 5, 6, 7, 8 or 9 building; or
- (d) a room or suite of associated rooms in a Class 9c *aged care building*, which includes sleeping facilities and any area for the exclusive use of a resident.

Spread-of-Flame Index means the index number for spread of flame as determined by AS/NZS 1530.3.

NSW (Stage)

Stage means a floor or platform in a Class 9b building on which performances are presented before an audience.

Standard Fire Test means the Fire-resistance Tests of Elements of Building Construction as described in AS 1530.4.

Storey means a space within a building which is situated between one floor level and the floor level next above, or if there is no floor above, the ceiling or roof above, but not—

- (a) a space that contains only—
 - (i) a lift *shaft*, stairway or meter room; or
 - (ii) a bathroom, shower room, laundry, water closet, or other *sanitary compartment*; or
 - (iii) accommodation intended for not more than 3 vehicles; or
 - (iv) a combination of the above; or
- (b) a *mezzanine*.

Structural adequacy, in relation to an FRL, means the ability to maintain stability and adequate *loadbearing* capacity as determined by AS 1530.4.

* * * * *

Surface water means all naturally occurring water, other than sub-*surface water*, which results from rainfall on or around the *site* or water flowing onto the *site*, including that flowing from a drain, stream, river, lake or sea.

Swimming pool means any excavation or structure containing water and used primarily for swimming, wading, paddling, or the like, including a bathing or wading pool, or spa.

Thermal calculation method means a calculation method that identifies—

- (a) a *heating load*; or
- (b) a *cooling load*; or
- (c) a *heating load* and a *cooling load* (annual energy load),
based on the sum of hourly loads or an equivalent approach.

Total R-Value means the sum of the *R-Values* of the individual component layers in a composite element including any building material, insulating material, airspace and associated surface resistances.

Total U-Value means the thermal transmittance ($W/m^2.K$) of the composite element allowing for the effect of any airspaces and associated surface resistances.

Treatment area means an area within a *patient care area* such as an operating theatre and rooms used for recovery, minor procedures, resuscitation, intensive care and coronary care from which a patient may not be readily moved.

Ventilation opening, for the purposes of **Section J**, means an opening in the *external wall*, floor or roof of a building designed to allow air movement into or out of the building by natural means including a permanent opening, an openable part of a *window*, a door or other device which can be held open.

Verification Method means a test, inspection, calculation or other method that determines whether a *Building Solution* complies with the relevant *Performance Requirements*.

Ward area means that part of a *patient care area* for resident patients and may contain areas for accommodation, sleeping, associated living and nursing facilities.

Window includes a roof light, glass panel, glass block or brick, glass louvre, glazed sash, glazed door, or other device which transmits natural light directly from outside a building to the room concerned when in the closed position.

A1.2 Adoption of Standards and other references

Where a *Deemed-to-Satisfy Provision* references a document, rule, specification or provision, that adoption does not include a provision—

- (a) specifying or defining the respective rights, responsibilities or obligations as between themselves of any manufacturer, supplier or purchaser; or
- (b) specifying the responsibilities of any trades person or other building operative, architect, engineer, authority, or other person or body; or
- (c) requiring the submission for approval of any material, building component, form or method of construction, to any person, authority or body other than a person or body empowered under State or Territory legislation to give that approval; or
- (d) specifying that a material, building component, form or method of construction must be submitted to any person, authority or body for expression of opinion; or
- (e) permitting a departure from the code, rule, specification or provision at the sole discretion of the manufacturer or purchaser, or by arrangement or agreement between the manufacturer and purchaser.

A1.3 Referenced Standards, etc

- (a) A reference in a *Deemed-to-Satisfy Provision* to a document under **A1.2** refers to the edition or issue, together with any amendment, listed in **Specification A1.3** and only so much as is relevant in the context in which the document is quoted.

- (b) Any—
- (i) reference in a document listed in **Specification A1.3** (primary document) to another document (secondary document); and
 - (ii) subsequent references to other documents in secondary documents and those other documents,
- is a reference to the secondary and other documents as they existed at the time of publication of the primary document listed in **Specification A1.3**
- (c) The provisions of (b) do not apply if the secondary referenced document is also a primary referenced document.
- (d) Where the BCA references a document under **A1.2** which is subject to publication of a new edition or amendment not listed under **Specification A1.3**, the new edition or amendment need not be complied with in order to comply with the *Deemed-to-Satisfy Provisions*.

A1.4 Differences between referenced documents and the BCA

The BCA overrules in any difference arising between it and any Standard, rule, specification or provision in a document listed in **Specification A1.3**.

A1.5 Compliance with all Sections of BCA

Subject to **A1.6**, Class 2–9 buildings must be so designed and constructed that they comply with the relevant provisions of Sections **A** to **J** (inclusive) of the BCA.

A1.6 Application of the BCA to a particular State or Territory

For application within a particular State or Territory, the BCA comprises—

- (a) Sections **A** to **J** (inclusive); and
- (b) the variations, deletions and additions to Sections **A** to **J** applicable to that State or Territory specified in the relevant Appendix.

A1.7 Language

- (a) A reference to a building in the BCA is a reference to an entire building or part of a building, as the case requires.
- (b) A reference in a *Performance Requirement* of the BCA to “the degree necessary” means that consideration of all the criteria referred to in the *Performance Requirement* will determine the outcome appropriate to the circumstances. These words have been inserted to indicate that in certain situations it may not be necessary to incorporate any specific measures to meet the *Performance Requirement*.
- (c) A reference to “BCA” in this volume, other than in the **Introduction**, means “Volume One of the Building Code of Australia”.

PART A2

ACCEPTANCE OF DESIGN AND CONSTRUCTION

A2.1 Suitability of materials

Every part of a building must be constructed in an appropriate manner to achieve the requirements of the BCA, using materials that are fit for the purpose for which they are intended.

A2.2 Evidence of suitability

- (a) Subject to [A2.3](#) and [A2.4](#), evidence to support that the use of a material, form of construction or design meets a *Performance Requirement* or a *Deemed-to-Satisfy Provision* may be in the form of one or a combination of the following:
- (i) A report issued by a *Registered Testing Authority*, showing that the material or form of construction has been submitted to the tests listed in the report, and setting out the results of those tests and any other relevant information that demonstrates its suitability for use in the building.
 - (ii) A current *Certificate of Conformity* or a current *Certificate of Accreditation*.
 - (iii) A certificate from a *professional engineer* or other appropriately qualified person which—
 - (A) certifies that a material, design, or form of construction complies with the requirements of the BCA; and
 - (B) sets out the basis on which it is given and the extent to which relevant specifications, rules, codes of practice or other publications have been relied upon.
 - (iv) A current certificate issued by a product certification body that has been accredited by the Joint Accreditation System of Australia and New Zealand (JAS-ANZ).
 - (v) * * * * *
 - (vi) Any other form of documentary evidence that correctly describes the properties and performance of the material,
- (b) Evidence to support that a calculation method complies with an ABCB protocol may be in the form of one or a combination of the following:
- (i) A certificate from a *professional engineer* or other appropriately qualified person which—
 - (A) certifies that the calculation method complies with a relevant ABCB protocol; and
 - (B) sets out the basis on which it is given and the extent to which relevant specifications, rules, codes of practice and other publications have been relied upon.
 - (ii) Any other form of documentary evidence that correctly describes how the calculation method complies with a relevant ABCB protocol.
- (c) Any copy of documentary evidence submitted, must be a complete copy of the original report or document.

A2.3 Fire-resistance of building elements

Where a *Deemed-to-Satisfy Provision* requires a building element to have an FRL, it must be determined in accordance with **Specification A2.3**.

A2.4 Fire hazard properties

Where a *Deemed-to-Satisfy Provision* requires a building component or assembly to have a *fire hazard property* it must be determined as follows:

- (a) For *average specific extinction area*, *critical radiant flux* or *Flammability Index* — as defined in **A1.1**.
- (b) For *Smoke-Developed Index*, *Spread-of-Flame Index*, a material's *group number* or *smoke growth rate index* (SMOGR_{RC}) — in accordance with **Specification A2.4**.

A2.5 Resistance to the incipient spread of fire

A ceiling is deemed to have the *resistance to the incipient spread of fire* to the space above itself if—

- (a) it is identical with a prototype that has been submitted to the *Standard Fire Test* and the *resistance to the incipient spread of fire* achieved by the prototype is confirmed in a report from a *Registered Testing Authority* which—
 - (i) describes the method and conditions of the test and form of construction of the tested prototype in full; and
 - (ii) certifies that the application of restraint to the prototype complies with the *Standard Fire Test*; or
- (b) it differs in only a minor degree from a prototype tested under (a) and the *resistance to the incipient spread of fire* attributed to the ceiling is confirmed in a report from a *Registered Testing Authority* which—
 - (i) certifies that the ceiling is capable of achieving the *resistance to the incipient spread of fire* despite the minor departures from the tested prototype; and
 - (ii) describes the materials, construction and conditions of restraint which are necessary to achieve the *resistance to the incipient spread of fire*.

ACT A02 to A2.102

PART A3

CLASSIFICATION OF BUILDINGS AND STRUCTURES

A3.1 Principles of classification

The classification of a building or part of a building is determined by the purpose for which it is designed, constructed or adapted to be used.

A3.2 Classifications

Buildings are classified as follows:

Class 1: one or more buildings which in association constitute—

- (a) **Class 1a** — a single dwelling being—
 - (i) a detached house; or
 - (ii) one of a group of two or more attached dwellings, each being a building, separated by a *fire-resisting* wall, including a row house, terrace house, town house or villa unit; or
- (b) **Class 1b** — a boarding house, guest house, hostel or the like—
 - (i) with a total area of all floors not exceeding 300 m² measured over the enclosing walls of the Class 1b; and
 - (ii) in which not more than 12 persons would ordinarily be resident,

which is not located above or below another dwelling or another Class of building other than a *private garage*.

Class 2: a building containing 2 or more *sole-occupancy units* each being a separate dwelling.

Class 3: a residential building, other than a building of Class 1 or 2, which is a common place of long term or transient living for a number of unrelated persons, including—

- (a) a boarding-house, guest house, hostel, lodging-house or backpackers accommodation; or
- (b) a residential part of a hotel or motel; or
- (c) a residential part of a *school*; or
- (d) accommodation for the aged, children or people with disabilities; or
- (e) a residential part of a *health-care building* which accommodates members of staff; or
- (f) a residential part of a *detention centre*.

Class 4: a dwelling in a building that is Class 5, 6, 7, 8 or 9 if it is the only dwelling in the building.

Class 5: an office building used for professional or commercial purposes, excluding buildings of Class 6, 7, 8 or 9.

Class 6: a shop or other building for the sale of goods by retail or the supply of services direct to the public, including—

- (a) an eating room, cafe, restaurant, milk or soft-drink bar; or

- (b) a dining room, bar area that is not an *assembly building*, shop or kiosk part of a hotel or motel; or
- (c) a hairdresser's or barber's shop, public laundry, or undertaker's establishment; or
- (d) market or sale room, showroom, or *service station*.

Class 7: a building which is—

- (a) **Class 7a** — a *carpark*; or
- (b) **Class 7b** — for storage, or display of goods or produce for sale by wholesale.

Class 8: a laboratory, or a building in which a handicraft or process for the production, assembling, altering, repairing, packing, finishing, or cleaning of goods or produce is carried on for trade, sale, or gain.

Class 9: a building of a public nature—

- (a) **Class 9a** — a *health-care building*, including those parts of the building set aside as a laboratory; or
- (b) **Class 9b** — an *assembly building*, including a trade workshop, laboratory or the like in a primary or secondary *school*, but excluding any other parts of the building that are of another Class; or
- (c) **Class 9c** — an *aged care building*.

Class 10: a non-habitable building or structure—

- (a) **Class 10a** — a non-habitable building being a *private garage*, carport, shed, or the like; or
- (b) **Class 10b** — a structure being a fence, mast, antenna, retaining or free-standing wall, *swimming pool*, or the like.

A3.3 Multiple classification

Each part of a building must be classified separately, and—

- (a)
 - (i) where parts have different purposes — if not more than 10% of the *floor area* of a *storey*, being the minor use, is used for a purpose which is a different classification, the classification applying to the major use may apply to the whole storey; and
 - (ii) the provisions of (i) do not apply when the minor use is a laboratory or Class 2, 3 or 4 part; and
- (b) Classes 1a, 1b, 7a, 7b, 9a, 9b, 9c, 10a and 10b are separate classifications; and
- (c) a reference to—
 - (i) Class 1 — is to Class 1a and 1b; and
 - (ii) Class 7 — is to Class 7a and 7b; and
 - (iii) Class 9 — is to Class 9a, 9b and 9c; and
 - (iv) Class 10 — is to Class 10a and 10b; and
- (d) A plant room, machinery room, lift motor room, boiler room or the like must have the same classification as the part of the building in which it is situated.

A3.4 Parts with more than one classification

- (a) Notwithstanding **A3.3**, a building or part of a building may have more than one classification applying to the whole building or to the whole of that part of the building.
- (b) If a building or part of a building has more than one classification applying to the whole building or part in accordance with **(a)**, that building or part must comply with all the relevant provisions of the BCA for each classification.

PART A4

UNITED BUILDINGS

A4.1 When buildings are united

Two or more buildings adjoining each other form one united building if they—

- (a) are connected through openings in the walls dividing them; and
- (b) together comply with all the requirements of the BCA as though they are a single building.

A4.2 Alterations in a united building

If, after *alterations* or any other building work, two or more of the buildings in **A4.1** cease to be connected through openings in the dividing walls, each of those buildings not now connected must comply with all the requirements for a single building.

SPECIFICATION **A1.3** DOCUMENTS ADOPTED BY REFERENCE

1. Schedule of referenced documents

ACT, NSW, NT, QLD, SA, Tas, Vic Spec A1.3 Table 1

The Standards and other documents listed in **Table 1** are referred to in Volume One of the BCA.

Table 1: SCHEDULE OF REFERENCED DOCUMENTS

No.	Date	Title	BCA Clause(s)
AS/ISO 717 Part 2	2004	Acoustics — Rating of sound insulation in buildings and building elements Impact sound insulation	F5.3
AS 1038 Part 15	1995	Coal and coke — Analysis and testing Higher rank coal ash and coke ash — Ash fusibility	Spec C3.15
AS/NZS 1170 Part 0	2002	Structural design actions General principles Amdt 1	B1.1, B1.2, Spec B1.2
Part 1	2002	Permanent, imposed and other actions Amdt 1 Amdt 2	B1.2
Part 2	2002	Wind actions Amdt 1	B1.2, Spec B1.2, J4.2
Part 3	2003	Snow and ice actions Amdt 1	B1.2
AS 1170 Part 4	1993	Minimum design loads on structures Earthquake loads Amdt 1	B1.3
AS 1170 Part 4	2007	Structural design actions Earthquake actions in Australia	B1.2, B1.4
AS 1191	2002	Acoustics — Method for laboratory measurement of airborne sound insulation of building elements	Spec F5.5
AS/NZS 1200	2000	Pressure equipment	G2.2

Table 1: SCHEDULE OF REFERENCED DOCUMENTS— continued

No.	Date	Title	BCA Clause(s)
AS/NZS 1276 Part 1	1999	Acoustics — Rating of sound insulation in buildings and of building elements Airborne sound insulation [Note: Test reports based on AS1276 – 1979 and issued prior to AS/NZS 1276.1 – 1999 being referenced in the BCA, remain valid. The STC values in reports based on AS 1276 – 1979 shall be considered to be equivalent to R _w values. Test reports prepared after the BCA reference date for AS/NZS 1276.1 – 1999 must be based on that version]	F5.2
AS 1288	2006	Glass in buildings — Selection and Installation Amdt 1	B1.4, Spec C2.5, Spec C3.4
AS 1428 Part 1	2001	Design for Access and Mobility General requirements for access — New building work	A1.1, D2.10, D3.2, D3.3, D3.6, D3.7, D3.8, F2.4, G4.5, Spec D3.6
Part 4	1992	Tactile ground surface indicators for orientation of people with vision impairment Amdt 1	D3.8
AS 1530 Part 1	1994	Methods for fire tests on building materials, components and structures Combustibility test for materials	A1.1
Part 2	1993	Test for flammability of materials Amdt 1	A1.1
Part 4	2005	Fire-resistance tests on elements of construction [Note: Subject to the note to AS 4072.1, reports relating to tests carried out under earlier editions of AS 1530 Parts 1 to 4 remain valid. Reports relating to tests carried out after the date of an amendment to a Standard must relate to the amended Standard]	A1.1, C3.15, C3.16, Spec A2.4, Spec C3.15
AS/NZS 1530		Methods for fire tests on building materials, components and structures	

Table 1: SCHEDULE OF REFERENCED DOCUMENTS— continued

No.	Date	Title	BCA Clause(s)
Part 3	1999	Simultaneous determination of ignitability, flame propagation, heat release and smoke release	Spec A2.4
AS 1562 Part 1	1992	Design and installation of sheet roof and wall cladding Metal Amdt 1 Amdt 2	B1.4, F1.5
AS/NZS 1562 Part 2 Part 3	1999 1996	Design and installation of sheet roof and wall cladding Corrugated fibre-reinforced cement Plastics	F1.5 B1.4, F1.5
AS 1657	1992	Fixed platforms, walkways, stairways and ladders — Design, construction and installation (SAA Code for Fixed Platforms, Walkways, Stairways and Ladders)	D1.16, D2.18, H1.6
AS/NZS 1664 Part 1 Part 2	1997 1997	Aluminium structures Limit state design Amdt 1 Allowable stress design Amdt 1	B1.4 B1.4
AS/NZS 1668 Part 1	1998	The use of ventilation and airconditioning in buildings Fire and smoke control in multi-compartment buildings Amdt 1	C2.12, C3.15, Spec C2.5, D1.7, Spec E1.8, E2.2, Spec E2.2a, F4.12, Spec G3.8
AS 1668 Part 2	1991	The use of mechanical ventilation and air-conditioning in buildings Mechanical ventilation for acceptable indoor-air quality	F4.5, F4.11, F4.12
AS 1670		Fire detection, warning, control and intercom systems — Systems design, installation and commissioning	

Table 1: SCHEDULE OF REFERENCED DOCUMENTS— continued

No.	Date	Title	BCA Clause(s)
Part 1	2004	Fire Amdt 1	C2.3, C3.5, C3.6, C3.7, C3.8, C3.11, D2.21, G4.8, Spec C3.4, Spec E2.2a, Spec G3.8
Part 3	2004	Fire alarm monitoring	E4.9, Spec G3.8
Part 4	2004	Sound systems and intercom systems for emergency purposes	E4.9, Spec G3.8
AS/NZS 1680 Part 0	1998	Interior lighting Safe Movement	F4.4
AS 1684 Part 2	2006	Residential timber-framed construction Non-cyclonic areas Amdt 1	B1.4, F1.12
Part 3	2006	Cyclonic areas Amdt 1	B1.4, F1.12
Part 4	2006	Simplified — non-cyclonic areas Amdt 1	B1.4, F1.12
AS 1720 Part 1	1997	Timber structures Design methods Amdt 1 Amdt 2 Amdt 3 Amdt 4	B1.4
Part 4	1990	Fire resistance of structural timber	Spec A2.3
AS 1735 Part 1	2003	Lifts, escalators and moving walks General Requirements	Spec C1.8, E3.4, E3.7
Part 2	2001	Passenger and goods lifts — Electric	Spec C1.8, Spec C1.10, D1.16, E3.4, E3.5, E3.7,
Part 11	1986	Fire-rated landing doors	C3.10
Part 12	1999	Facilities for persons with disabilities Amdt 1	E3.6
AS 1860 Part 2	2006	Particleboard flooring Installation	B1.4

Table 1: SCHEDULE OF REFERENCED DOCUMENTS— continued

No.	Date	Title	BCA Clause(s)
AS 1905		Components for the protection of openings in fire-resistant walls	
Part 1	2005	Fire-resistant doorsets	C3.6, Spec C3.4
Part 2	2005	Fire-resistant roller shutters	Spec C3.4
AS 1926		Swimming pool safety	G1.1
Part 1	1993	Fencing for swimming pools Amdt 1	
Part 2	1995	Location of fencing for private swimming pools	
Part 3	2003	Water recirculation and filtration systems	G1.1
AS 2047	1999	Windows in buildings — Selection and installation Amdt 1 Amdt 2	B1.4, F1.13, J3.4
AS 2049	2002	Roof tiles Amdt 1	B1.4, F1.5
AS 2050	2002	Installation of roof tiles Amdt 1	B1.4, F1.5
AS 2118		Automatic fire sprinkler systems	
Part 1	1999	General requirements Amdt 1	Spec E1.5
Part 4	1995	Residential	Spec E1.5
Part 6	1995	Combined sprinkler and hydrant	Spec E1.5
AS 2159	1995	Piling — Design and installation Amdt 1	B1.4
AS 2293		Emergency escape lighting and exit signs for buildings	
Part 1	2005	System design, installation and operation	E4.4, E4.8
AS 2327		Composite structures	
Part 1	2003	Simply supported beams	Spec A2.3, B1.4
AS 2419		Fire hydrant installations	
Part 1	2005	System design, installation and commissioning Amdt 1	C2.12, E1.3
AS 2441	2005	Installation of fire hose reels	E1.4

Table 1: SCHEDULE OF REFERENCED DOCUMENTS— continued

No.	Date	Title	BCA Clause(s)
AS 2444	2001	Portable fire extinguishers and fire blankets — Selection and location	E1.6
AS 2665	2001	Smoke/heat venting systems — Design, installation and commissioning	Spec E2.2c, Spec G3.8
AS 2870	1996	Residential slabs and footings — Construction Amdt 1 Amdt 2 Amdt 3 Amdt 4	F1.10
AS 2890 Part 1	1993	Parking facilities Off-street car parking	D3.5
AS/NZS 2904	1995	Damp-proof courses and flashings Amdt 1	F1.9
AS/NZS 2908 Part 1	2000	Cellulose cement products Corrugated sheets	B1.4, F1.5
Part 2	2000	Flat sheets	A1.1
AS/NZS 2918	2001	Domestic solid-fuel burning appliances — Installation	G2.2
AS/NZS 3013	2005	Electrical installations — Classification of the fire and mechanical performance of wiring system elements	C2.13
AS/NZS 3500 Part 3	2003	National plumbing and drainage Stormwater drainage Amdt 1	F1.1
Part 4	2003	Heated water services Amdt 1	J7.2
AS 3600	2001	Concrete structures Amdt 1 Amdt 2	Spec A2.3, B1.4
AS 3660 Part 1	2000	Termite management New building work	B1.4, F1.9
AS/NZS 3666 Part 1	2002	Air-handling and water systems of buildings — Microbial control Design, installation and commissioning	F2.7, F4.5
Part 2	2002	Operation and maintenance	I1.2

Table 1: SCHEDULE OF REFERENCED DOCUMENTS— continued

No.	Date	Title	BCA Clause(s)
AS 3700	2001	Masonry structures Amdt 1 Amdt 2 Amdt 3	Spec A2.3, B1.4,
AS 3740	2004	Waterproofing of wet areas within residential buildings	F1.7
AS 3786	1993	Smoke alarms Amdt 1 Amdt 2 Amdt 3 Amdt 4	Spec E2.2a
AS 3823 Part 1.2	2001	Performance of electrical appliances - Airconditioners and heat pumps Test Methods — Ducted airconditioners and air-to-air heat pumps — Testing and rating for performance Amdt 1 Amdt 2	J5.4
AS/NZS 3837	1998	Method of test for heat and smoke release rates for materials and products using an oxygen consumption calorimeter	A1.1, Spec A2.4, Spec C1.10a
AS 3959	1999	Construction of buildings in bushfire-prone areas Amdt 1 Amdt 2	G5.2
AS 4072 Part 1	2005	Components for the protection of openings in fire-resistant separating elements Service penetrations and control joints Amdt 1 [Note: Systems tested to AS 1530.4 prior to 1 January 1995 need not be retested to comply with the provisions in AS 4072.1]	C3.15
AS 4100	1998	Steel Structures	Spec A2.3, B1.4
AS/NZS 4200 Part 1	1994	Pliable building membranes and underlays Materials	F1.6

Table 1: SCHEDULE OF REFERENCED DOCUMENTS— continued

No.	Date	Title	BCA Clause(s)
Part 2	1994	Amdt 1 Installation requirements	
AS 4254	1995	Ductwork for air-handling systems in buildings Amdt 1 Amdt 2	Spec C1.10
AS/NZS 4256		Plastic roof and wall cladding materials	B1.4, F1.5
Part 1	1994	General requirements	
Part 2	1994	Unplasticized polyvinyl chloride (uPVC) building sheets	
Part 3	1994	Glass fibre reinforced polyester (GRP)	
Part 5	1996	Polycarbonate	
AS/NZS 4600	2005	Cold-formed steel structures	B1.4
AS/NZS 4859		Materials for the thermal insulation of buildings	
Part 1	2002	General criteria and technical provisions Amdt 1	J1.2, Spec J5.2
AS ISO 9239		Reaction to fire tests for flooring	
Part 1	2003	Determination of the burning behaviour using a radiant heat source	A1.1
AS ISO 9705	2003	Fire tests — Full-scale room test for surface products	Spec A2.4, Spec C1.10a
AISC	1987	Guidelines for assessment of fire resistance of structural steel members	Spec A2.3
ASTM D3018-90	1994	Class A asphalt shingles surfaced with mineral granules	B1.4, F1.5
ASTM E72-80	1981	Standard method of conducting strength tests of panels for building construction	Spec C1.8
ASTM E695-79	1985	Standard method of measuring relative resistance of wall, floor and roof construction to impact loading	Spec C1.8
ARI 460	2000	Remote mechanical-draft air-cooled refrigerant condensers	J5.4
ARI 550/590	1998	Water chilling packages using the vapour compression cycle	J5.4
BS 7190	1989	Assessing thermal performance of low temperature hot water boilers using a test rig	J5.4

Table 1: SCHEDULE OF REFERENCED DOCUMENTS— continued

No.	Date	Title	BCA Clause(s)
ABCB	2006	Protocol for House Energy Rating Software Version 2006.1	JV1
ABCB	2006	Protocol for Building Energy Analysis Software Version 2006.1	Spec JV
ISO 140 Part 6	1998E	Acoustics — Measurement of sound insulation in buildings and of building elements Laboratory measurements of impact sound insulation of floors	Spec F5.5
ISO 717 Part 1	1996	Acoustics — Rating of sound insulation in buildings and of building elements Airborne sound insulation	F5.2
ISO 8336	1993E	Fibre cement flat sheets	A1.1
NASH Standard Part 1	2005	Residential and low-rise steel framing Design criteria Amdt A	B1.4

SPECIFICATION **A2.3** FIRE-RESISTANCE OF BUILDING ELEMENTS

1. Scope

This Specification sets out the procedures for determining the FRL of building elements.

2. Rating

A building element meets the requirements of this Specification if—

- (a) it is listed in, and complies with **Table 1** of this Specification; or
- (b) it is identical with a prototype that has been submitted to the *Standard Fire Test*, or an equivalent or more severe test, and the FRL achieved by the prototype is confirmed in a report from a *Registered Testing Authority* which—
 - (i) describes the method and conditions of the test and the form of construction of the tested prototype in full; and
 - (ii) certifies that the application of restraint to the prototype complied with the *Standard Fire Test*; or
- (c) it differs in only a minor degree from a prototype tested under **(b)** and the FRL attributed to the building element is confirmed in a report from a *Registered Testing Authority* which—
 - (i) certifies that the building element is capable of achieving the FRL despite the minor departures from the tested prototype; and
 - (ii) describes the materials, construction and conditions of restraint which are necessary to achieve the FRL; or
- (d) it is designed to achieve the FRL in accordance with—
 - (i) AS 2327.1, AS 4100 and AISC Guidelines for Assessment of Fire Resistance of Structural Steel Members if it is a steel or composite structure; or
 - (ii) AS 3600 if it is a concrete structure; or
 - (iii) AS 1720.4 if it is a solid or glued-laminated timber structure; or
 - (iv) AS 3700 if it is a masonry structure; or
- (e) the FRL is determined by calculation based on the performance of a prototype in the *Standard Fire Test* and confirmed in a report in accordance with **Clause 3**.

3. FRLs determined by calculation

If the FRL of a building element is determined by calculation based on a tested prototype—

- (a) the building element may vary from the prototype in relation to—
 - (i) length and height if it is a wall; and
 - (ii) height if it is a column; and
 - (iii) span if it is a floor, roof or beam; and
 - (iv) conditions of support; and

- (v) to a minor degree, cross-section and components.
- (b) the report must demonstrate by calculation that the building element would achieve the FRL if it is subjected to the regime of the *Standard Fire Test* in relation to—
 - (i) *structural adequacy* (including deflection); and
 - (ii) *integrity*; and
 - (iii) *insulation*; and
- (c) the calculations must take into account—
 - (i) the temperature reached by the components of the prototype and their effects on strength and modulus of elasticity; and
 - (ii) appropriate features of the building element such as support, restraint, cross-sectional shape, length, height, span, slenderness ratio, reinforcement, ratio of surface area to mass per unit length, and fire protection; and
 - (iii) features of the prototype that influenced its performance in the *Standard Fire Test* although these features may not have been taken into account in the design for dead and live load; and
 - (iv) features of the conditions of test, the manner of support and the position of the prototype during the test, that might not be reproduced in the building element if it is exposed to fire; and
 - (v) the design load of the building element in comparison with the tested prototype.

4. Interchangeable materials

- (a) Concrete and plaster — An FRL achieved with any material of Group A, B, C, D or E as an ingredient in concrete or plaster, applies equally when any other material of the same group is used in the same proportions:

Group A: Any portland cement.

Group B: Any lime.

Group C: Any dense sand.

Group D: Any dense calcareous aggregate, including any limestone or any calcareous gravel.

Group E: Any dense siliceous aggregate, including any basalt, diorite, dolerite, granite, granodiorite or trachyte.

- (b) Perlite and vermiculite — An FRL achieved with either gypsum-perlite plaster or gypsum-vermiculite plaster applies equally for each plaster.

5. Columns covered with lightweight construction

If the *fire-resisting* covering of a steel column is *lightweight construction*, the construction must comply with **C1.8** and **C3.17**.

6. Non-loadbearing elements

If a non-*loadbearing* element is able to be used for a purpose where the *Deemed-to-Satisfy Provisions* prescribe an FRL for *structural adequacy*, *integrity* and *insulation*, that non-*loadbearing* element need not comply with the *structural adequacy* criteria.

Table 1 FRLs DEEMED TO BE ACHIEVED BY CERTAIN BUILDING ELEMENT

Building element	Minimum thickness (mm) of principal material for FRL's					Annexure reference
WALL						
	60/60/60	90/90/90	120/120/120	180/180/180	240/240/240	Clause No
Masonry						
Ashlar	–	–	–	–	300	1, 2, 5, 6
Calcium silicate		see 2(d)(iv) of this Specification				
Concrete		see 2(d)(iv) of this Specification				
Fired clay (inc terracotta)		see 2(d)(iv) of this Specification				
Concrete						
No-fines	–	–	–	150	170	1, 5, 6
Prestressed		see 2(d)(ii) of this Specification				
Reinforced		see 2(d)(ii) of this Specification				
Plain	–	–	–	150	170	1, 5, 6
Solid gypsum blocks	75	90	100	110	125	1, 5, 6
Gypsum — perlite or Gypsum vermiculite-plaster on metal lath and channel (non-loadbearing walls only)	50	50	65	–	–	1, 5, 7
CONCRETE COLUMN						
	60/60/60	90/90/90	120/120/120	180/180/180	240/240/240	Clause
Prestressed		see 2(d)(ii) of this Specification				
Reinforced		see 2(d)(ii) of this Specification				
HOT-ROLLED STEEL COLUMN						
	60/60/60	90/90/90	120/120/120	180/180/180	240/240/240	Clause
(inc a fabricated column) exposed on no more than 3 sides:						8
Fire protection of Concrete — Cast in-situ—						
<i>loadbearing</i>	25	30	40	55	75	9, 11, 12
non- <i>loadbearing</i> -						
unplastered	25	30	40	50	65	9, 11, 12
plastered 13 mm—	25	25	30	40	50	1, 6, 9, 11, 12
Gypsum —Cast in-situ	–	–	–	–	50	9, 11, 12
Gypsum — perlite or Gypsum-vermiculite plaster						
sprayed to contour	20	25	35	50	55	1, 11
sprayed on metal lath	20	20	25	35	45	1, 7

Table 1 FRLs DEEMED TO BE ACHIEVED BY CERTAIN BUILDING ELEMENT— continued

Building element	Minimum thickness (mm) of principal material for FRL's					Annexure reference
HOT-ROLLED STEEL COLUMN						
	60/60/60	90/90/90	120/120/120	180/180/180	240/240/240	Clause
(inc. a fabricated column) exposed on no more than 3 sides and with column spaces filled:						8, 9
Fire protection of—						
Solid calcium-silicate masonry	50	50	50	50	65	1, 3, 11, 12
Solid clay masonry	50	50	50	65	90	1, 3, 11, 12
Solid concrete masonry	50	50	50	65	90	1, 3, 11, 12
Solid gypsum blocks	50	50	50	50	65	1, 3, 11, 12
Hollow terracotta blocks						
plastered 13 mm	50	50	50	65	90	1, 3, 6, 10, 11, 12
HOT-ROLLED STEEL COLUMN						
	60/60/60	90/90/90	120/120/120	180/180/180	240/240/240	Clause
(inc a fabricated column) exposed on no more than 3 sides and with column spaces unfilled:						8
Fire protection of—						
Solid calcium- silicate masonry	50	50	50	–	–	1, 3, 11, 12
Solid clay masonry	50	50	65	–	–	1, 3, 11, 12
Solid concrete masonry	50	50	65	–	–	1, 3, 11, 12
Solid gypsum blocks	50	50	50	–	–	1, 3, 11, 12
Hollow terracotta blocks—						
plastered 13 mm	50	50	65	–	–	1, 3, 6, 10, 11, 12
HOT-ROLLED STEEL COLUMN						
	60/-/-	90/-/-	120/-/-	180/-/-	240/-/-	Clause
(inc. a fabricated column) exposed on 4 sides:						8
Fire protection of—						
Concrete — Cast in-situ—						
<i>loadbearing</i>	25	40	45	65	90	9, 11, 12
non- <i>loadbearing-</i>						
unplastered	25	30	40	50	65	9, 11, 12
plastered 13 mm	25	25	30	40	50	1, 6, 9, 11, 12
Gypsum — Cast in-situ	–	–	–	–	50	9, 11, 12
Gypsum-perlite or Gypsum-vermiculite plaster						
sprayed to contour	25	30	40	55	65	1, 11

Table 1 FRLs DEEMED TO BE ACHIEVED BY CERTAIN BUILDING ELEMENT— continued

Building element	Minimum thickness (mm) of principal material for FRL's					Annexure reference	
	20	30	40	50	60		
sprayed on metal lath	20	30	40	50	60	1, 7	
HOT-ROLLED STEEL COLUMN							
	60/-/	90/-/	120/-/	180/-/	240/-/	Clause	
(inc. a fabricated column) exposed on 4 sides and with column spaces filled						8, 9	
Fire protection of—							
Solid calcium- silicate masonry	50	50	50	65	75	1, 3, 11, 12,	
Solid clay masonry	50	50	50	75	100	1, 3, 11, 12	
Solid concrete masonry	50	50	50	75	100	1, 3, 11, 12	
Solid gypsum blocks	50	50	50	65	75	1, 3, 11, 12	
Hollow terracotta blocks—							
plastered 13 mm	50	50	50	75	100	1, 3, 6, 10, 11, 12	
HOT-ROLLED STEEL COLUMN							
	60/-/	90/-/	120/-/	180/-/	240/-/	Clause	
(inc. a fabricated column) exposed on 4 sides and with column spaces unfilled						8	
Fire protection of—							
Solid calcium-silicate masonry	50	50	50	–	–	1, 3, 11, 12	
Solid clay masonry	50	50	65	–	–	1, 3, 11, 12	
Solid concrete masonry	50	50	65	–	–	1, 3, 11, 12	
Solid gypsum blocks	50	50	50	–	–	1, 3, 11, 12	
Hollow terracotta blocks—							
plastered 13 mm	50	50	65	–	–	1, 3, 6, 10, 11, 12	
BEAM							
	60/-/	90/-/	120/-/	180/-/	240/-/	Clause	
Concrete							
Prestressed		see 2(d)(ii) of this Specification					
Reinforced		see 2(d)(ii) of this Specification					
Hot-rolled Steel (inc. an open-web joist girder truss etc) exposed on no more than 3 sides:						8	
Fire protection of—							
Concrete — Cast in-situ	25	30	40	50	65	11, 12	
Gypsum-perlite or Gypsum-vermiculite plaster							
sprayed to contour	20	25	35	50	55	1, 11	
sprayed on metal lath	20	20	25	35	45	1, 7	

Table 1 FRLs DEEMED TO BE ACHIEVED BY CERTAIN BUILDING ELEMENT— continued

Building element	Minimum thickness (mm) of principal material for FRL's					Annexure reference
Hot-rolled Steel (inc. an open-web joist girder truss etc) exposed on 4 sides:						8
Fire protection of—						
Concrete — Cast in-situ	25	40	45	65	90	11, 12
Gypsum-perlite or Gypsum-vermiculite plaster —						
sprayed to contour	25	30	40	55	65	1, 11
sprayed on metal lath	20	20	30	40	50	1, 7
FLOOR, ROOF OR CEILING						
	60/60/60	90/90/90	120/120/120	180/180/180	240/240/240	Clause
Concrete —						
Prestressed		see 2(d)(ii) of this Specification				
Reinforced		see 2(d)(ii) of this Specification				

ANNEXURE TO TABLE 1

1. MORTAR, PLASTER AND PLASTER REINFORCEMENT

1.1 Mortar for masonry

Masonry units of ashlar, calcium silicate, concrete or fired clay (including terracotta blocks) must be laid in cement mortar or composition mortar complying with the relevant provisions of AS 3700.

1.2 Gypsum blocks

Gypsum blocks must be laid in gypsum-sand mortar or lime mortar.

1.3 Gypsum-sand mortar and plaster

Gypsum-sand mortar and gypsum-sand plaster must consist of either—

- (a) not more than 3 parts by volume of sand to 1 part by volume of gypsum; or
- (b) if lime putty is added, not more than 2.5 parts by volume of sand to 1 part by volume of gypsum and not more than 5% of lime putty by volume of the mixed ingredients.

1.4 Gypsum-perlite and gypsum-vermiculite plaster

Gypsum-perlite or gypsum-vermiculite plaster must be applied—

- (a) in either one or 2 coats each in the proportions of 1 m³ of perlite or vermiculite to 640 kg of gypsum if the *required* thickness of the plaster is not more than 25 mm; and
- (b) in 2 coats if the *required* thickness is more than 25 mm, the first in the proportions of 1 m³ of perlite or vermiculite to 800 kg of gypsum and the second in the proportions of 1 m³ of perlite or vermiculite to 530 kg of gypsum.

1.5 Plaster of cement and sand or cement, lime and sand

Plaster prescribed in [Table 1](#) must consist of—

- (a) cement and sand or cement, lime and sand; and
- (b) may be finished with gypsum, gypsum-sand, gypsum-perlite or gypsum-vermiculite plaster or with lime putty.

1.6 Plaster reinforcement

If plaster used as fire protection on walls is more than 19 mm thick—

- (a) it must be reinforced with expanded metal lath that—
 - (i) has a mass per unit area of not less than 1.84 kg/m²; and
 - (ii) has not fewer than 98 meshes per metre; and
 - (iii) is protected against corrosion by galvanising or other suitable method; or
- (b) it must be reinforced with 13 mm x 13 mm x 0.7 mm galvanised steel wire mesh, and with the reinforcement must be securely fixed at a distance from the face of the wall of not less than 1/3 of the total thickness of the plaster.

2. ASHLAR STONE MASONRY

Ashlar masonry must not be used in a part of the building containing more than 2 *storeys*, and must not be of—

- (a) aplite, granite, granodiorite, quartz dacite, quartz diorite, quartz porphyrite or quartz porphyry; or
- (b) conglomerate, quartzite or sandstone; or
- (c) chert or flint; or
- (d) limestone or marble.

3. DIMENSIONS OF MASONRY

The thicknesses of masonry of calcium-silicate, concrete and fired clay are calculated as follows:

3.1 Solid units

For masonry in which the amount of perforation or coring of the units does not exceed 25% by volume (based on the overall rectangular shape of the unit) the thickness of the wall must be calculated from the manufacturing dimensions of the units and the specified thickness of the joints between them as appropriate.

3.2 Hollow units

For masonry in which the amount of perforation or coring of the units exceeds 25% by volume (based on the overall rectangular shape of the unit) the thickness of the wall must be calculated from the equivalent thicknesses of the units and the specified thickness of the joints between them as appropriate.

3.3 Equivalent thickness

The equivalent thickness of a masonry unit is calculated by dividing the net volume by the area of one vertical face.

4. * * * * *

This Clause has deliberately been left blank.

5. HEIGHT-TO-THICKNESS RATIO OF CERTAIN WALLS

The ratio of height between lateral supports to overall thickness of a wall of ashlar, no-fines concrete, unreinforced concrete, solid gypsum blocks, gypsum-perlite or gypsum-vermiculite plaster on metal lath and channel, must not exceed—

- (a) 20 for a *loadbearing* wall; or
- (b) 27 for a non-*loadbearing* wall.

6. INCREASE IN THICKNESS BY PLASTERING

6.1 Walls

If a wall of ashlar, solid gypsum blocks or concrete is plastered on both sides to an equal thickness, the thickness of the wall for the purposes of [Table 1](#) (but not for the purposes of [Annexure Clause 5](#)) may be increased by the thickness of the plaster on one side.

6.2 Columns

Where [Table 1](#) indicates that column-protection is to be plastered, the tabulated thicknesses are those of the principal material. They do not include the thickness of plaster which must be additional to the listed thickness of the material to which it is applied.

7. GYPSUM-PERLITE OR GYPSUM-VERMICULITE PLASTER ON METAL LATH

7.1 Walls

In walls fabricated of gypsum-perlite or gypsum-vermiculite plaster on metal lath and channel—

- (a) the lath must be securely wired to each side of 19 mm x 0.44 kg/m steel channels (used as studs) spaced at not more than 400 mm centres; and
- (b) the gypsum-perlite or gypsum-vermiculite plaster must be applied symmetrically to each exposed side of the lath.

7.2 Columns

For the fire protection of steel columns with gypsum-perlite or gypsum-vermiculite on metal lath—

- (a) the lath must be fixed at not more than 600 mm centres vertically to steel furring channels, and—
 - (i) if the plaster is to be 35 mm thick or more — at least 12 mm clear of the column; or
 - (ii) if the plaster is to be less than 35 mm thick — at least 6 mm clear of the column; or
- (b) the plaster may be applied to self-furring lath with furring dimples to hold it not less than 10 mm clear of the column, and

the thickness of the plaster must be measured from the back of the lath.

7.3 Beams

For the fire protection of steel beams with gypsum-perlite or gypsum-vermiculite on metal lath—

- (a) the lath must be fixed at not more than 600 mm centres to steel furring channels and at least 20 mm clear of the steel; and
- (b) the thickness of the plaster must be measured from the back of the lath.

8. EXPOSURE OF COLUMNS AND BEAMS

8.1 Columns

A column incorporated in or in contact on one or more sides with a wall of solid masonry or concrete at least 100 mm thick may be considered to be exposed to fire on no more than 3 sides.

8.2 Beams

A beam, open-web joist, girder or truss in direct and continuous contact with a concrete slab or a hollow block floor or roof may be considered to be exposed to fire on no more than 3 sides.

9. FILLING OF COLUMN SPACES

- (a) The spaces between the fire-protective material and the steel (and any re-entrant parts of the column itself) must be filled solid with a fire-protective material like concrete, gypsum or grout.
- (b) The insides of hollow sections, including pipes, need not be filled.

10. HOLLOW TERRACOTTA BLOCKS

The proportion of cored holes or perforations in a hollow terracotta block (based on the overall rectangular volume of the unit) must not exceed the following:

- | | |
|---|-----|
| (a) For blocks up to 75 mm thick | 35% |
| (b) For blocks more than 75 mm but not more than 100 mm thick | 40% |
| (c) For blocks more than 100 mm | 50% |

11. REINFORCEMENT FOR COLUMN AND BEAM PROTECTION

11.1 Masonry

Masonry of calcium-silicate, fired clay and concrete for the protection of steel columns must have steel-wire or mesh reinforcement in every second course and lapped at the corners.

11.2 Gypsum blocks and hollow terracotta blocks

Gypsum blocks and hollow terracotta blocks for the protection of steel columns must have steel-wire or mesh reinforcement in every course and lapped at corners.

11.3 Structural concrete and poured gypsum

If a steel column or a steel beam is to be protected with structural concrete or poured gypsum—

- (a) the concrete or gypsum must be reinforced with steel-wire mesh or steel-wire binding placed about 20 mm from its outer surface, and—
 - (i) for concrete or gypsum less than 50 mm thick, the steel wire must be—

- (A) at least 3.15 mm in diameter; and
- (B) spaced at not more than 100 mm vertically; or
- (ii) for concrete or gypsum not less than 50 mm thick, the steel wire must be either—
 - (A) of a diameter and spacing in accordance with (i); or
 - (B) at least 5 mm in diameter and spaced at not more than 150 mm vertically.

11.4 Gypsum-perlite or gypsum-vermiculite plaster sprayed to contour

- (a) If a steel column or steel beam is protected with either gypsum-perlite or gypsum-vermiculite plaster sprayed to contour and the construction falls within the limits of **Table 11.4**, the plaster must be reinforced with—
 - (i) expanded metal lath complying with **Clause 1.6 of this Annexure**; or
 - (ii) galvanised steel wire mesh complying with **Clause 1.6 of this Annexure**.
- (b) The reinforcement must be placed at a distance from the face of the plaster of at least 1/3 of the thickness of the plaster and must be securely fixed to the column or beam at intervals of not more than the relevant listing in **Table 11.4**.
- (c) For the purposes of **Table 11.4**—
 - (i) “vertical” includes a surface at not more than 10° to the vertical; and
 - (ii) “horizontal” includes a surface at not more than 10° to the horizontal; and
 - (iii) “underside” means the underside of any horizontal or non-vertical surface.

Table 11.4 REINFORCEMENT OF GYPSUM-PERLITE OR GYPSUM-VERMICULITE PLASTER SPRAYED TO CONTOUR

Surface to be protected	Reinforcement required if smaller dimension of surface exceeds (mm)	Max spacing of fixings of the mesh to surface (mm)
Members with H or I cross-section:		
Vertical—	450	450
Non-vertical—	300	300
Underside—	300	300
Upper side of a horizontal surface—	Not required	
Members with other shapes:		
Vertical—	Any size	450
Non-vertical—	Any size	300
Underside—	Any size	300
Upper side of a horizontal surface—	Not required	

12. THICKNESS OF COLUMN AND BEAM PROTECTION

12.1 Measurement of thickness

The thickness of the fire protection to steel columns and steel beams (other than fire protection of gypsum-perlite or gypsum-vermiculite plaster sprayed on metal lath or sprayed to contour) is to be measured from the face or edge of the steel, from the face of a splice plate or from the outer part of a rivet or bolt, whichever is the closest to the outside of the fire-protective construction, except that—

- (a) if the thickness of the fire protection is 40 mm or more, rivet heads may be disregarded; and
- (b) if the thickness of the fire protection is 50 mm or more—
 - (i) any part of a bolt (other than a high-tensile bolt) may be disregarded; and
 - (ii) a column splice plate within 900 mm of the floor may encroach upon the fire protection by up to a 1/4 of the thickness of the fire protection; and
- (c) the flange of a column or beam may encroach by up to 12 mm upon the thickness of the fire protection at right angles to the web if—
 - (i) the column or beam is intended to have an FRL of 240/240/240 or 240/--; and
 - (ii) the flange projects 65 mm or more from the web; and
 - (iii) the thickness of the edge of the flange (inclusive of any splice plate) is not more than 40 mm.

SPECIFICATION **A2.4** FIRE HAZARD PROPERTIES

1. Scope

This Specification sets out the procedures for—

- (a) determining the *fire hazard properties* of assemblies tested to AS/NZS 1530.3; and
- (b) predicting a material's *group number* and *smoke growth rate index* (SMOGR_{RC}) for the purposes of **Specification C1.10a**.

2. Assemblies

2.1 General requirement

The *fire hazard properties* of assemblies and their ability to screen their core materials as *required* under **Specification C1.10** must be determined by testing in accordance with this clause.

2.2 Form of test

Tests must be carried out in accordance with—

- (a) for the determination of the *Spread-of-Flame Index* and *Smoke-Developed Index* — AS/NZS 1530.3; and
- (b) for the determination of the ability to prevent ignition and to screen its core material from free air — AS 1530.4.

2.3 Test specimens

Test specimens must incorporate—

- (a) all types of joints; and
- (b) all types of perforations, recesses or the like for pipes, light switches or other fittings, which are proposed to be used for the member or assembly of members in the building.

2.4 Concession

Clause 2.3 does not apply to joints, perforations, recesses or the like that are larger than those in the proposed application and have already been tested in the particular form of construction concerned and found to comply with the conditions of the test.

2.5 Smaller specimen permitted

A testing laboratory may carry out the test specified in **Clause 2.2(b)** at pilot scale if a specimen (which must be not less than 900 mm x 900 mm) will adequately represent the proposed construction in the building, but the results of that test do not apply to construction larger than limits defined by the laboratory conducting the pilot examination.

3. Predicting a material's group number

For a material tested to AS/NZS 3837, the material's *group number* must be determined in accordance with the following:

- (a) Data must be in the form of time and rate of heat release pairs for the duration of the test. The time interval between pairs should not be more than 5 seconds. The end of the test (t_f) is determined as defined in AS/NZS 3837.
- (b) At least three replicate specimens must be tested. The following procedure must be applied separately to each specimen:
 - (i) Determine time to ignition (t_{ig}). Time to ignition is defined as the time (in seconds) when the rate of heat release reaches or first exceeds a value of 50 kW/m².
 - (ii) Calculate the Ignitability Index (I_{ig}) expressed in reciprocal minutes.

$$I_{ig} = \frac{60}{t_{ig}}$$

- (iii) Calculate the following two rates of heat release indices.

$$I_{Q1} = \int_{t_{ig}}^{t_f} \left[\frac{q''(t)}{(t - t_{ig})^{0.34}} \right] \quad I_{Q2} = \int_{t_{ig}}^{t_f} \left[\frac{q''(t)}{(t - t_{ig})^{0.93}} \right]$$

t = time (seconds),

$q''(t)$ = rate of heat release (kW/m²) at time t

These definite integral expressions represent the area under a curve from the ignition time until the end of the test, where the parameter $q''(t)/(t - t_{ig})^m$ is plotted on the vertical axis and time (t) is plotted on the horizontal axis.

- (iv) Calculate the following three integral limits:

$$I_{Q,10min} = 6800 - 540I_{ig}$$

$$I_{Q,2min} = 2475 - 165I_{ig}$$

$$I_{Q,12min} = 1650 - 165I_{ig}$$

- (v) Classify the material in accordance with **Table 3**:

Table 3 CLASSIFICATION OF MATERIALS

If $I_{Q1} > I_{Q,10 min}$ and $I_{Q2} > I_{Q,2 min}$	the material is a Group 4 material
If $I_{Q1} > I_{Q,10 min}$ and $I_{Q2} \leq I_{Q,2 min}$	the material is a Group 3 material
If $I_{Q1} > I_{Q,10 min}$ and $I_{Q2} > I_{Q,12 min}$	the material is a Group 2 material
If $I_{Q1} > I_{Q,10 min}$ and $I_{Q2} \leq I_{Q,12 min}$	the material is a Group 1 material

- (vi) Repeat steps 1 to 5 above for each replicate specimen tested. Where a different classification group is obtained for different specimens tested, then the highest (worst) classification for any specimen must be taken as the final classification for that material.

4. Predicting a material's smoke growth rate index (SMOGR_{RC})

- (a) Measure the instantaneous rate of light-obscuring smoke R_{inst} expressed in square metres per second (m^2/s) in the exhaust duct at not more than 6 second intervals in the AS ISO 9705 room test.
- (b) Determine the 60 second running average (R_{60}) at time t . The result is the average rate of light-obscuring smoke over the period $t-30$ to $t+30$ seconds (in m^2/s). This may also be expressed mathematically as:

$$R_{60} = \frac{1}{60} \int_{t-30}^{t+30} R_{inst} dt$$

- (c) Find the time (in seconds) at which the maximum value of the 60 second running average occurs (t_{60}).
- (d) Calculate the SMOGR_{RC} index (in $m^2/s^2 \times 1000$)

$$SMOGR_{RC} = \frac{1000R_{60}}{t_{60}}$$

The SMOGR_{RC} index is based on the results of a single test.

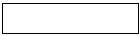

SECTION **B**

STRUCTURE

B1 Structural Provisions

SECTION B CONTENTS

SECTION B STRUCTURE

B1 STRUCTURAL PROVISIONS

Objective BO1

Functional Statement BF1.1 - BF1.2

Performance Requirement BP1.1 - BP1.3

B1.0 Deemed-to-Satisfy Provisions

B1.1 Resistance to actions

B1.2 Determination of individual actions

B1.3 Loads

B1.4 Determination of structural resistance of materials and forms of construction

Specifications

Specification B1.2 Design of Buildings in Cyclonic Areas

NT Appendix (Additional provisions and variations — refer to NT Contents for full details)

Qld Appendix (Additional provisions and variations — refer to Qld Contents for full details)

PART B1 STRUCTURAL PROVISIONS

OBJECTIVE

BO1

The *Objective* of this Part is to—

- (a) safeguard people from injury caused by structural failure; and
- (b) safeguard people from loss of amenity caused by structural behaviour; and
- (c) protect *other property* from physical damage caused by structural failure; and
- (d) safeguard people from injury that may be caused by failure of, or impact with, glazing.

FUNCTIONAL STATEMENT

BF1.1

A building or structure is to withstand the combination of loads and other actions to which it may be reasonably subjected.

BF1.2

Glazing is to be installed in a building to avoid undue risk of injury to people.

PERFORMANCE REQUIREMENT

BP1.1

- (a) A building or structure, to the degree necessary, must—
 - (i) remain stable and not collapse; and
 - (ii) prevent progressive collapse; and
 - (iii) minimise local damage and loss of amenity through excessive deformation, vibration or degradation; and
 - (iv) avoid causing damage to *other properties*,by resisting the actions to which it may reasonably be subjected.
- (b) The actions to be considered to satisfy (a) include but are not limited to—
 - (i) permanent actions (dead loads); and

- (ii) imposed actions (live loads arising from occupancy and use); and
- (iii) wind action; and
- (iv) earthquake action; and
- (v) snow action; and
- (vi) liquid pressure action; and
- (vii) ground water action; and
- (viii) rainwater action (including ponding action); and
- (ix) earth pressure action; and
- (x) differential movement; and
- (xi) time dependent effects (including creep and shrinkage); and
- (xii) thermal effects; and
- (xiii) ground movement caused by—
 - (A) swelling, shrinkage or freezing of the subsoil; and
 - (B) landslip or subsidence; and
 - (C) siteworks associated with the building or structure; and
- (xiv) *construction activity actions*; and
- (xv) termite actions.

BP1.2

The structural resistance of materials and forms of construction must be determined using five percentile characteristic material properties with appropriate allowance for—

- (a) known construction activities; and
- (b) type of material; and
- (c) characteristics of the site; and
- (d) the degree of accuracy inherent in the methods used to assess the structural behaviour; and
- (e) action effects arising from the differential settlement of foundations, and from restrained dimensional changes due to temperature, moisture, shrinkage, creep and similar effects.

BP1.3

Glass installations that are at risk of being subjected to human impact must have glazing that—

- (a) if broken on impact, will break in a way that is not likely to cause injury to people; and
- (b) resists a reasonably foreseeable human impact without breaking; and
- (c) is protected or marked in a way that will reduce the likelihood of human impact.

PART B1 STRUCTURAL PROVISIONS

Deemed-to-Satisfy Provisions

B1.0 Deemed-to-Satisfy Provisions

- (a) Where a *Building Solution* is proposed to comply with the *Deemed-to-Satisfy Provisions*, *Performance Requirement BP1.1* to *BP1.3* are satisfied—
- (i) by complying with **B1.1**, **B1.2** and **B1.4**; or
 - (ii) for the earthquake resistance component of the *Performance Requirements*, by complying with **B1.3** and **B1.4**.
- (b) Where a *Building Solution* is proposed as an *Alternative Solution* to the *Deemed-to-Satisfy Provisions* of—
- (i) **B1.1**, **B1.2** and **B1.4**; or
 - (ii) **B1.3** and **B1.4**,
- the relevant *Performance Requirements* must be determined in accordance with **A0.10**.

B1.1 Resistance to actions

The resistance of a building or structure must be greater than the most critical action effect resulting from different combinations of actions, where—

- (a) the most critical action effect on a building or structure is determined in accordance with **B1.2** and the general design procedures contained in AS/NZS 1170.0; and
- (b) the resistance of a building or structure is determined in accordance with **B1.4**.

B1.2 Determination of individual actions

The magnitude of individual actions must be determined in accordance with the following:

- (a) Permanent actions:
 - (i) the design or known dimensions of the building or structure; and
 - (ii) the unit weight of the construction; and
 - (iii) AS/NZS 1170.1.
- (b) Imposed actions:
 - (i) the known loads that will be imposed during the occupation or use of the building or structure; and
 - (ii) *construction activity actions*; and
 - (iii) AS/NZS 1170.1.
- (c) Wind, snow and ice and earthquake actions:
 - (i) the applicable annual probability of design event for safety, determined by—
 - (A) assigning the building or structure an Importance Level in accordance with **Table B1.2a**; and

Deemed-to-Satisfy Provisions

- (B) determining the corresponding annual probability of exceedance in accordance with **Table B1.2b**; and
 - (ii) AS/NZS 1170.2, AS/NZS 1170.3 and AS 1170.4 (2007) as appropriate; and
 - (iii) in cyclonic areas, metal roof cladding, its connections and immediate supporting members must comply with **Specification B1.2**; and
 - (iv) for the purposes of (iii), cyclonic areas are those determined as being located in wind regions C and D in accordance with AS/NZS 1170.2.
- (d) Actions not covered in (a), (b) and (c) above:
- (i) the nature of the action; and
 - (ii) the nature of the building or structure; and
 - (iii) the Importance Level of the building or structure determined in accordance with **Table B1.2a**; and
 - (iv) AS/NZS 1170.1.
- (e) For the purposes of (d) the actions include but are not limited to—
- (i) liquid pressure action; and
 - (ii) ground water action; and
 - (iii) rainwater action (including ponding action); and
 - (iv) earth pressure action; and
 - (v) differential movement; and
 - (vi) time dependent effects (including creep and shrinkage); and
 - (vii) thermal effects; and
 - (viii) ground movement caused by—
 - (A) swelling, shrinkage or freezing of the subsoil; and
 - (B) landslide or subsidence; and
 - (C) *siteworks* associated with the building or structure; and
 - (ix) *construction activity actions*.

Table B1.2a Importance Levels of Buildings and Structures

Importance Level	Building Types
1	Buildings or structures presenting a low degree of hazard to life and <i>other property</i> in the case of failure.
2	Buildings or structures not included in Importance Levels 1, 3 and 4.
3	Buildings or structures that are designed to contain a large number of people.
4	Buildings or structures that are essential to post-disaster recovery or associated with hazardous facilities.

Deemed-to-Satisfy Provisions

Table B1.2b Design Events for Safety

Importance Level	Annual probability of exceedance			
	Wind		Snow	Earthquake
	Non-cyclonic	Cyclonic		
1	1:100	1:200	1:100	1:250
2	1:500	1:500	1:150	1:500
3	1:1000	1:1000	1:200	1:1000
4	1:2000	1:2000	1:250	1:1500

B1.3 Loads

A building or structure must resist earthquake loads determined in accordance with AS 1170.4 (1993).

B1.4 Determination of structural resistance of materials and forms of construction

The structural resistance of materials and forms of construction must be determined in accordance with the following:

- (a) Masonry (including masonry-veneer, unreinforced masonry and reinforced masonry): AS 3700 except that AS 1170.4 (2007) must be used to determine earthquake actions.
- (b) Concrete construction (including reinforced and prestressed concrete): AS 3600.
- (c) Steel construction—
 - (i) Steel structures: AS 4100.
 - (ii) Cold-formed steel structures: AS/NZS 4600.
 - (iii) Residential and low-rise steel framing: NASH Standard.
- (d) Composite steel and concrete: AS 2327.1.
- (e) Aluminium construction: AS/NZS 1664.1 or AS/NZS 1664.2.
- (f) Timber construction:
 - (i) Design of timber structures: AS 1720.1.
 - (ii) * * * * *
 - (iii) Timber structures: AS 1684 Part 2, Part 3 or Part 4.

Qld B1.4(f)(iv)

- (g) Piling: AS 2159.
- (h) Glazed assemblies:
 - (i) The following glazed assemblies in an *external wall* must comply with AS 2047:
 - (A) Windows excluding those listed in (ii).
 - (B) Sliding doors with a frame.
 - (C) Adjustable louvres.

Deemed-to-Satisfy Provisions

- (D) Shopfronts.
- (E) Window walls with one piece framing.
- (ii) All glazed assemblies not covered by (i) and the following glazed assemblies must comply with AS 1288:
 - (A) All glazed assemblies not in an *external wall*.
 - (B) Hinged doors, including French doors and bi-fold doors.
 - (C) Revolving doors.
 - (D) Fixed louvres.
 - (E) Skylights, roof lights and windows in other than the vertical plane.
 - (F) Sliding doors without a frame.
 - (G) Shopfront doors.
 - (H) Windows constructed on site and architectural one-off windows, which are not design tested in accordance with AS 2047.
 - (I) Second-hand windows, re-used windows, recycled windows and replacement windows.
 - (J) Heritage windows.
 - (K) Glazing used in balustrades and sloping overhead glazing.

NT B1.4(i)

- (i) Termite Risk Management: Where a *primary building element* is subject to attack by subterranean termites: AS 3660.1, and—
 - (i) for the purposes of this provision, a *primary building element* consisting entirely of, or a combination of, any of the following materials is considered not subject to termite attack:
 - (A) Steel, aluminium or other metals.
 - (B) Concrete.
 - (C) Masonry.
 - (D) Fibre-reinforced cement.
 - (E) Timber — naturally termite resistant in accordance with Appendix C of AS 3660.1.
 - (F) Timber — preservative treated in accordance with Appendix D of AS 3660.1; and
 - (ii) a durable notice must be permanently fixed to the building in a prominent location, such as a meter box or the like, indicating—
 - (A) the method of termite risk management; and
 - (B) the date of installation of the system; and
 - (C) where a chemical barrier is used, its life expectancy as listed on the National Registration Authority label; and
 - (D) the installer's or manufacturer's recommendations for the scope and frequency of future inspections for termite activity.

Deemed-to-Satisfy Provisions

- (j) Roof construction (except in cyclone areas):
 - (i) Plastic sheeting: AS/NZS 1562.3, AS/NZS 4256 Parts 1, 2, 3 and 5.
 - (ii) Roofing tiles: AS 2049, AS 2050.
 - (iii) Cellulose cement corrugated sheets: AS/NZS 2908.1 with safety mesh installed in accordance with AS/NZS 1562.3 Clause 2.4.3.2 except for sub clause (g) for plastic sheeting.
 - (iv) Metal roofing: AS 1562.1.
 - (v) Asphalt shingles: ASTM D3018-90, Class A.
- (k) Particleboard structural flooring: AS 1860.2.
- (l) * * * * *
- (m) Lift *shafts* which are not *required* to have an FRL: AS 1735.2 Clause 11.1.2.

SPECIFICATION **B1.2** DESIGN OF BUILDINGS IN CYCLONIC AREAS

Deemed-to-Satisfy Provisions

NT Specification B1.2 Clause (3) (4).

1. Scope

This specification contains requirements for the design of buildings in cyclonic areas in addition to the requirements of AS/NZS 1170.2.

For the purposes of **Specification B1.2**, cyclonic areas are those determined as being located in wind regions C and D in accordance with AS/NZS 1170.2.

2. Roof Cladding

Test for strength - Metal roof cladding, its connections and immediate supporting members must be capable of remaining in position notwithstanding any permanent distortion, fracture or damage that might occur in the sheet or fastenings under the pressure sequences A to G defined in **Table 1**.

TABLE 1 LOW-HIGH-LOW PRESSURE SEQUENCE

Sequence	Number of cycles	Load
A	4500	0 to 0.45 Pt
B	600	0 to 0.6 Pt
C	80	0 to 0.8 Pt
D	1	0 to 1.0 Pt
E	80	0 to 0.8 Pt
F	600	0 to 0.6 Pt
G	4500	0 to 0.45 Pt

Note:

1. Pt is the ultimate limit state wind pressure on internal and external surfaces as determined in accordance with AS/NZS 1170.2, modified by an appropriate factor for variability, as determined in accordance with Table B1 of AS/NZS 1170.0.
2. The rate of load cycling must be less than 3Hz.
3. The single load cycle (sequence D) must be held for a minimum of 10 seconds.

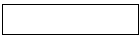

SECTION **C**

FIRE RESISTANCE

- C1 Fire Resistance and Stability**
- C2 Compartmentation and Separation**
- C3 Protection of Openings**

SECTION C CONTENTS

SECTION C FIRE RESISTANCE

C Fire Resistance

Objective CO1
Functional Statements CF1 - CF2
Performance Requirements CP1 - CP9
Verification Methods CV1 - CV2

Part C1 Fire Resistance and Stability

C1.0 Deemed-to-Satisfy Provisions
C1.1 Type of construction required
C1.2 Calculation of rise in storeys
C1.3 Buildings of multiple classification
C1.4 Mixed types of construction
C1.5 Two storey Class 2, 3 or 9c buildings
C1.6 Class 4 parts of buildings
C1.7 Open spectator stands and indoor sports stadiums
C1.8 Lightweight construction
C1.9 * * * * *
C1.10 Fire hazard properties
C1.11 Performance of external walls in fire
C1.12 Non-combustible materials

Part C2 Compartmentation and Separation

C2.0 Deemed-to-Satisfy Provisions
C2.1 Application of Part
C2.2 General floor area and volume limitations
C2.3 Large isolated Buildings
C2.4 Requirements for open spaces and vehicular access
C2.5 Class 9a and 9c buildings
C2.6 Vertical separation of openings in external walls
C2.7 Separation by fire walls
C2.8 Separation of classifications in the same storey
C2.9 Separation of classifications in different storeys
C2.10 Separation of lift shafts
C2.11 Stairways and lifts in one shaft
C2.12 Separation of equipment
C2.13 Electricity supply system
C2.14 Public corridors in Class 2 and 3 buildings

Part C3 Protection of Openings

C3.0 Deemed-to-Satisfy Provisions
C3.1 Application of Part
C3.2 Protection of openings in external walls

- C3.3 Separation of external walls and associated openings in different fire compartments
- C3.4 Acceptable methods of protection
- C3.5 Doorways in fire walls
- C3.6 Sliding fire doors
- C3.7 Protection of doorways in horizontal exits
- C3.8 Openings in fire-isolated exits
- C3.9 Service penetrations in fire-isolated exits
- C3.10 Openings in fire-isolated lift shafts
- C3.11 Bounding construction: Class 2, 3 and 4 buildings
- C3.12 Openings in floors and ceilings for services
- C3.13 Openings in shafts
- C3.14 * * * * *
- C3.15 Openings for service installations
- C3.16 Construction joints
- C3.17 Columns protected with lightweight construction to achieve an FRL

Specifications

- Specification C1.1 Fire-Resisting Construction
- Specification C1.8 Structural Tests for Lightweight Construction
- Specification C1.10 Fire Hazard Properties - General
- Specification C1.10a Fire Hazard Properties - Floors, Walls and Ceilings
- Specification C1.11 Performance of External Walls in Fire
- Specification C2.5 Smoke-Proof Walls in Health-Care and Aged Care Buildings
- Specification C3.4 Fire Doors, Smoke Doors, Fire Windows and Shutters
- Specification C3.15 Penetration of Walls, Floors and Ceilings by Services

NSW Appendix (Additional provisions and variations — refer to NSW Contents for full details)

SECTION C FIRE RESISTANCE

OBJECTIVE

CO1

The *Objective* of this Section is to—

- (a) safeguard people from illness or injury due to a fire in a building; and
- (b) safeguard occupants from illness or injury while evacuating a building during a fire; and
- (c) facilitate the activities of emergency services personnel; and
- (d) avoid the spread of fire between buildings; and
- (e) protect *other property* from physical damage caused by structural failure of a building as a result of fire.

FUNCTIONAL STATEMENTS

CF1

A building is to be constructed to maintain structural stability during fire to—

- (a) allow occupants time to evacuate safely; and
- (b) allow for *fire brigade* intervention; and
- (c) avoid damage to *other property*.

CF2

A building is to be provided with safeguards to prevent fire spread—

- (a) so that occupants have time to evacuate safely without being overcome by the effects of fire; and
- (b) to allow for *fire brigade* intervention; and
- (c) to *sole-occupancy* units providing sleeping accommodation; and

Application:

CF2(c) only applies to a Class 2 or 3 building or Class 4 part.

- (d) to adjoining *fire compartments*; and
- (e) between buildings.

PERFORMANCE REQUIREMENTS

CP1

A building must have elements which will, to the degree necessary, maintain structural stability during a fire appropriate to—

- (a) the function or use of the building; and
- (b) the *fire load*; and
- (c) the potential *fire intensity*; and
- (d) the *fire hazard*; and
- (e) the height of the building; and
- (f) its proximity to *other property*; and
- (g) any active *fire safety systems* installed in the building; and
- (h) the size of any *fire compartment*; and
- (i) *fire brigade* intervention; and
- (j) other elements they support; and
- (k) the *evacuation time*.

CP2

(a) A building must have elements which will, to the degree necessary, avoid the spread of fire—

- (i) to *exits*; and
- (ii) to *sole-occupancy units* and *public corridors*; and

Application:

CP2(a)(ii) only applies to a Class 2 or 3 building or Class 4 part.

- (iii) between buildings; and
 - (iv) in a building.
- (b) Avoidance of the spread of fire referred to in (a) must be appropriate to—
- (i) the function or use of the building; and
 - (ii) the *fire load*; and
 - (iii) the potential *fire intensity*; and
 - (iv) the *fire hazard*; and
 - (v) the number of *storeys* in the building; and
 - (vi) its proximity to *other property*; and
 - (vii) any active *fire safety systems* installed in the building; and
 - (viii) the size of any *fire compartment*; and
 - (ix) *fire brigade* intervention; and

- (x) other elements they support; and
- (xi) the *evacuation time*.

CP3

A building must be protected from the spread of fire and smoke to allow sufficient time for the orderly evacuation of the building in an emergency.

Application:

CP3 only applies to—

- (a) a *patient care area* of a Class 9a *health-care building*; and
- (b) a Class 9c *aged care building*.

CP4

A material and an assembly must, to the degree necessary, resist the spread of fire to limit the generation of smoke and heat, and any toxic gases likely to be produced, appropriate to—

- (a) the *evacuation time*; and
- (b) the number, mobility and other characteristics of occupants; and
- (c) the function or use of the building; and
- (d) any active *fire safety systems* installed in the building.

CP5

A concrete *external wall* that could collapse as a complete panel (eg. tilt-up and pre-cast concrete) must be designed so that in the event of fire within the building the likelihood of outward collapse is avoided.

Limitation:

CP5 does not apply to a building having more than two *storeys* above ground level.

CP6

A building must have elements, which will, to the degree necessary, avoid the spread of fire from service equipment having—

- (a) a high *fire hazard*; or
- (b) a potential for explosion resulting from a high *fire hazard*.

CP7

A building must have elements, which will, to the degree necessary, avoid the spread of fire so that emergency equipment provided in a building will continue to operate for a period of time necessary to ensure that the intended function of the equipment is maintained during a fire.

CP8

Any building element provided to resist the spread of fire must be protected, to the degree necessary, so that an adequate level of performance is maintained—

- (a) where openings, construction joints and the like occur; and
- (b) where penetrations occur for building services.

CP9

Access must be provided to and around a building, to the degree necessary, for *fire brigade* vehicles and personnel to facilitate *fire brigade* intervention appropriate to—

- (a) the function or use of the building; and
- (b) the *fire load*; and
- (c) the potential *fire intensity*; and
- (d) the *fire hazard*; and
- (e) any active *fire safety systems* installed in the building; and
- (f) the size of any *fire compartment*.

VERIFICATION METHODS

CV1

Compliance with **CP2(a)(iii)** to avoid the spread of fire between buildings on adjoining allotments is verified when it is calculated that—

- (a) a building will not cause heat flux in excess of those set out in column 2 of **Table CV1** at locations within the boundaries of an adjoining property set out in column 1 of **Table CV1** where another building may be constructed; and
- (b) when located at the distances from the allotment boundary set out in column 1 of **Table CV1**, a building is capable of withstanding the heat flux set out in column 2 of **Table CV1** without ignition.

Table CV1

Column 1	Column 2
Location	Heat Flux (kW/m ²)
On boundary	80
1 m from boundary	40
3 m from boundary	20
6 m from boundary	10

CV2

Compliance with **CP2(a)(iii)** to avoid the spread of fire between buildings on the same allotment is verified when it is calculated that a building—

- (a) is capable of withstanding the heat flux set out in column 2 of **Table CV2** without ignition; and
- (b) will not cause heat flux in excess of those set out in column 2 of **Table CV2**,

when the distance between the buildings is as set out in column 1 of [Table CV2](#).

Table CV2

Column 1	Column 2
Distance between buildings	Heat Flux (kW/m²)
0 m	80
2 m	40
6 m	20
12 m	10

PART C1 FIRE RESISTANCE AND STABILITY

Deemed-to-Satisfy Provisions

C1.0 Deemed-to-Satisfy Provisions

- (a) Where a *Building Solution* is proposed to comply with the *Deemed-to-Satisfy Provisions*, *Performance Requirements CP1* to *CP9* are satisfied by complying with—
- (i) **C1.1** to **C1.12**, **C2.1** to **C2.14** and **C3.1** to **C3.17**; and
 - (ii) in a building containing an *atrium*, **Part G3**; and
 - (iii) for theatres, *stages* and public halls, **Part H1**.
- (b) Where a *Building Solution* is proposed as an *Alternative Solution* to the *Deemed-to-Satisfy Provisions* of—
- (i) **C1.1** to **C1.12**, **C2.1** to **C2.14** and **C3.1** to **C3.17**; and
 - (ii) in a building containing an *atrium*, **Part G3**; and
 - (iii) for theatres, *stages* and public halls, **Part H1**,
- the relevant *Performance Requirements* must be determined in accordance with **A0.10**.

C1.1 Type of construction required

- (a) The minimum Type of *fire-resisting construction* of a building must be that specified in **Table C1.1** and **Specification C1.1**, except as allowed for—
- (i) certain Class 2, 3 or 9c buildings in **C1.5**; and
 - (ii) a Class 4 part of a building located on the top *storey* in **C1.3(b)**; and
 - (iii) *open spectator stands* and indoor sports stadiums in **C1.7**.
 - (iv) * * * * *
- (b) Type A construction is the most fire-resistant and Type C the least fire-resistant of the Types of construction.

Table C1.1 TYPE OF CONSTRUCTION REQUIRED

Rise in storeys	Class of building	
	2, 3, 9	5, 6, 7, 8
4 OR MORE	A	A
3	A	B
2	B	C
1	C	C

C1.2 Calculation of rise in storeys

- (a) The *rise in storeys* is the sum of the greatest number of *storeys* at any part of the *external walls* of the building and any *storeys* within the roof space—

Deemed-to-Satisfy Provisions

- (i) above the finished ground next to that part; or
 - (ii) if part of the *external wall* is on the boundary of the allotment, above the natural ground level at the relevant part of the boundary.
- (b) A *storey* is not counted if—
- (i) it is situated at the top of the building and contains only heating, ventilating or lift equipment, water tanks, or similar service units or equipment; or
 - (ii) it is situated partly below the finished ground and the underside of the ceiling is not more than 1 m above the average finished level of the ground at the *external wall*, or if the *external wall* is more than 12 m long, the average for the 12 m part where the ground is lowest.
- (c) In a Class 7 or 8 building, a *storey* that has an average internal height of more than 6 m is counted as—
- (i) one *storey* if it is the only *storey* above the ground; or
 - (ii) 2 *storeys* in any other case.
- (d) For the purposes of calculating the *rise in storeys* of a building—
- (i) a *mezzanine* is regarded as a *storey* in that part of the building in which it is situated if its *floor area* is more than 200 m² or more than 1/3 of the *floor area* of the room, whichever is the lesser; and
 - (ii) two or more *mezzanines* are regarded as a *storey* in that part of the building in which they are situated if they are at or near the same level and have an aggregate *floor area* more than 200 m² or more than 1/3 of the *floor area* of the room, whichever is the lesser.

C1.3 Buildings of multiple classification

- (a) In a building of multiple classifications, the Type of construction *required* for the building is the most *fire-resisting* Type resulting from the application of **Table C1.1** on the basis that the classification applying to the top *storey* applies to all *storeys*.
- (b) In a building containing a Class 4 part on the top *storey*, for the purpose of (a), the classification applying to the top *storey* must be—
- (i) when the Class 4 part occupies the whole of the top *storey*, the classification applicable to the next highest *storey*; or
 - (ii) when the Class 4 part occupies part of the top *storey*, the classification applicable to the adjacent part.

C1.4 Mixed types of construction

A building may be of mixed Types of construction where it is separated in accordance with **C2.7** and the Type of construction is determined in accordance with **C1.1** or **C1.3**.

C1.5 Two storey Class 2, 3 or 9c buildings

A building having a *rise in storeys* of 2 may be of Type C construction if—

- (a) it is a Class 2 or 3 building or a mixture of these classes and each *sole-occupancy unit* has—

Deemed-to-Satisfy Provisions

- (i) access to at least 2 *exits*; or
 - (ii) its own direct access to a road or *open space*.
- (b) it is a Class 9c *aged care building* protected throughout with a sprinkler system complying with **Specification E1.5** and complies with the maximum compartment size specified in **Table C2.2** for Type C construction.

C1.6 Class 4 parts of buildings

For the Type of construction *required* by **C1.3**, a Class 4 part of a building requires the same FRL for building elements and the same construction separating the Class 4 part from the remainder of the building as a Class 2 part in the same Type of construction.

C1.7 Open spectator stands and indoor sports stadiums

- (a) An *open spectator stand* or indoor sports stadium may be of Type C construction and need not comply with the other provisions of this Part if it contains not more than 1 tier of seating, is of *non-combustible* construction, and has only changing rooms, sanitary facilities or the like below the tiered seating.
- (b) In (a), one tier of seating means numerous rows of tiered seating incorporating cross-overs but within one viewing level.

C1.8 Lightweight construction

- (a) *Lightweight construction* must comply with **Specification C1.8** if it is used in a wall system—
- (i) that is *required* to have an FRL; or
 - (ii) for a lift *shaft*, stair *shaft* or service *shaft* or an *external wall* bounding a *public corridor* including a non *fire-isolated passageway* or non *fire-isolated ramp*, in a spectator stand, sports stadium, cinema or theatre, railway station, bus station or airport terminal.
- (b) If *lightweight construction* is used for the *fire-resisting* covering of a steel column or the like, and if—
- (i) the covering is not in continuous contact with the column, then the void must be filled solid, to a height of not less than 1.2 m above the floor to prevent indenting; and
 - (ii) the column is liable to be damaged from the movement of vehicles, materials or equipment, then the covering must be protected by steel or other suitable material.

C1.9 * * * * *

This clause has deliberately been left blank.

C1.10 Fire Hazard Properties

- (a) The *fire hazard properties* of any material or assembly in a Class 2 to 9 building must comply with—

Deemed-to-Satisfy Provisions

- (i) for floor materials, floor coverings, wall and ceiling lining materials, **Specification C1.10a**; and
- (ii) for other materials, **Specification C1.10**.

NSW C1.10(b)

- (b) Paint or fire-retardant coatings must not be used to make a substrate comply with the *required fire hazard properties*.
- (c) The requirements of (a) do not apply to a material or assembly if it is—
 - (i) plaster, cement render, concrete, terrazzo, ceramic tile or the like; or
 - (ii) a *fire-protective covering*; or
 - (iii) a timber-framed *window*; or
 - (iv) a solid timber handrail or skirting; or
 - (v) a timber-faced solid-core door or timber-faced fire door; or
 - (vi) an electrical switch, socket-outlet, cover plate or the like; or
 - (vii) a material used for—
 - (A) a roof covering or roof membrane, or a roof insulating material, applied in continuous contact with a substrate; or
 - (B) an adhesive; or
 - (C) a damp-proof course, flashing, caulking, sealing, ground moisture barrier, or the like; or
 - (viii) a paint, varnish, lacquer or similar finish, other than nitro-cellulose lacquer; or
 - (ix) a clear or translucent roof light of glass fibre reinforced polyester if—
 - (A) the roof in which it is installed forms part of a single *storey* building *required* to be Type C construction; and
 - (B) the material is used as part of the roof covering; and
 - (C) it is not closer than 1.5 m from another roof light of the same type; and
 - (D) each roof light is not more than 14 m² in area; and
 - (E) the area of the roof lights per 70 m² of roof surface is not more than 14 m²; or
 - (x) a face plate or neck adaptor of supply and return air outlets of an air handling system; or
 - (xi) a face plate or diffuser plate of light fitting and emergency *exit* signs and associated electrical wiring and electrical components; or
 - (xii) a joinery unit, cupboard, shelving or the like; or
 - (xiii) any other material that does not significantly increase the hazards of fire.

C1.11 Performance of external walls in fire

Concrete *external walls* that could collapse as complete panels (eg tilt-up and pre-cast concrete), in a building having a *rise in storeys* of not more than 2, must comply with **Specification C1.11**.

Deemed-to-Satisfy Provisions

C1.12 Non-combustible materials

The following materials, though *combustible* or containing *combustible* fibres, may be used wherever a *non-combustible* material is *required*:

- (a) Plasterboard.
- (b) Perforated gypsum lath with a normal paper finish.
- (c) Fibrous-plaster sheet.
- (d) Fibre-reinforced cement sheeting.
- (e) Pre-finished metal sheeting having a *combustible* surface finish not exceeding 1 mm thickness and where the *Spread-of-Flame Index* of the product is not greater than 0.
- (f) Bonded laminated materials where—
 - (i) each laminate is *non-combustible*; and
 - (ii) each adhesive layer does not exceed 1 mm in thickness; and
 - (iii) the total thickness of the adhesive layers does not exceed 2 mm; and
 - (iv) the *Spread-of-Flame Index* and the *Smoke-Developed Index* of the laminated material as a whole does not exceed 0 and 3 respectively.

PART C2 COMPARTMENTATION AND SEPARATION

Deemed-to-Satisfy Provisions

C2.0 Deemed-to-Satisfy Provisions

- (a) Where a *Building Solution* is proposed to comply with the *Deemed-to-Satisfy Provisions*, *Performance Requirements CP1* to *CP9* are satisfied by complying with—
- (i) **C1.1** to **C1.12**, **C2.1** to **C2.14** and **C3.1** to **C3.17**; and
 - (ii) in a building containing an *atrium*, **Part G3**; and
 - (iii) for theatres, *stages* and public halls, **Part H1**.
- (b) Where a *Building Solution* is proposed as an *Alternative Solution* to the *Deemed-to-Satisfy Provisions* of—
- (i) **C1.1** to **C1.12**, **C2.1** to **C2.14** and **C3.1** to **C3.17**; and
 - (ii) in a building containing an *atrium*, **Part G3**; and
 - (iii) for theatres, *stages* and public halls, **Part H1**,
- the relevant *Performance Requirements* must be determined in accordance with **A0.10**.

C2.1 Application of Part

C2.2, **C2.3** and **C2.4** do not apply to a *carpark* provided with a sprinkler system complying with **Specification E1.5**, an *open-deck carpark* or an *open spectator stand*.

C2.2 General floor area and volume limitations

- (a) The size of any *fire compartment* or *atrium* in a Class 5, 6, 7, 8 or 9 building must not exceed the relevant maximum *floor area* nor the relevant maximum volume set out in **Table C2.2** and **Clause C2.5** except as permitted in **Clause C2.3**.
- (b) A part of a building which contains only heating, ventilating, or lift equipment, water tanks, or similar service units is not counted in the *floor area* or volume of a *fire compartment* or *atrium* if it is situated at the top of the building.
- (c) In a building containing an *atrium*, the part of the *atrium well* bounded by the perimeter of the openings in the floors and extending from the level of the first floor above the *atrium* floor to the roof covering is not counted in the volume of the *atrium* for the purposes of this clause.

Table C2.2 MAXIMUM SIZE OF FIRE COMPARTMENTS OR ATRIA

Classification		Type of construction of building		
		Type A	Type B	Type C
5, 9b or 9c <i>aged care building</i>	max <i>floor area</i> —	8 000 m ²	5 500 m ²	3 000 m ²
	max volume—	48 000 m ³	33 000 m ³	18 000 m ³

Deemed-to-Satisfy Provisions

Table C2.2 MAXIMUM SIZE OF FIRE COMPARTMENTS OR ATRIA — continued

Classification	Type of construction of building			
	Type A	Type B	Type C	
6, 7, 8 or 9a (except for <i>patient care areas</i>)	max <i>floor area</i> —	5 000 m ²	3 500 m ²	2 000 m ²
	max volume—	30 000 m ³	21 000 m ³	12 000 m ³
Note: See C2.5 for maximum size of compartments in <i>patient care areas</i> in Class 9a <i>health care buildings</i> .				

C2.3 Large isolated buildings

The size of a *fire compartment* in a building may exceed that specified in **Table C2.2** where—
NSW C2.3(a)

- (a) the building does not exceed 18 000 m² in *floor area* nor exceed 108 000 m³ in volume, if—
 - (i) the building is Class 7 or 8, it contains not more than 2 *storeys* and is provided with open space complying with **C2.4(a)** not less than 18 m wide around the building and—
 - (A) an *automatic* fire detection and alarm system complying with AS 1670.1 and monitored in accordance with **Clause 7 of Specification E2.2a**; or
 - (B) an *automatic* smoke exhaust system in accordance with **Specification E2.2b**; or
 - (C) *automatic smoke-and-heat vents* in accordance with **Specification E2.2c**; or
 - (D) natural smoke venting, with ventilation openings distributed as evenly as practicable and comprising permanent openings at roof level with a free area not less than 1.5% of *floor area* and low level openings which may be permanent or readily openable with a free area not less than 1.5% of *floor area*; or
 - (ii) the building is Class 5 to 9 and is protected throughout with a sprinkler system complying with **Specification E1.5** and perimeter vehicular access complying with **C2.4(b)** is provided; or
- (b) the building exceeds 18 000 m² in *floor area* or 108 000 m³ in volume, is protected throughout with a sprinkler system complying with **Specification E1.5**, is provided with a perimeter vehicular access complying with **C2.4(b)** and if—
 - (i) the ceiling height of the *fire compartment* is not more than 12 m, it has a smoke exhaust system in accordance with **Specification E2.2b** or *smoke-and-heat vents* in accordance with **Specification E2.2c**; or
 - (ii) the ceiling height is more than 12 m, it has a smoke exhaust system in accordance with **Specification E2.2b**; or
- (c) there is more than one building on the allotment and—
 - (i) each building complies with **(a)** or **(b)**; or
 - (ii) if the buildings are closer than 6 m to each other they are regarded as one building and collectively comply with **(a)** or **(b)**.

Deemed-to-Satisfy Provisions

C2.4 Requirements for open spaces and vehicular access

- (a) An open space *required* by **C2.3** must—
- (i) be wholly within the allotment except that any road, river, or public place adjoining the allotment, but not the farthest 6 m of it may be included; and
 - (ii) include vehicular access in accordance with **(b)**; and
 - (iii) not be used for the storage or processing of materials; and
 - (iv) not be built upon, except for guard houses and service structures (such as electricity substations and pump houses) which may encroach upon the width of the space if they do not unduly impede fire-fighting at any part of the perimeter of the allotment or unduly add to the risk of spread of fire to any building on an adjoining allotment.
- (b) Vehicular access *required* by this Part—
- (i) must be capable of providing continuous access for emergency vehicles to enable travel in a forward direction from a public road around the entire building; and
 - (ii) must have a minimum unobstructed width of 6 m with no part of its furthest boundary more than 18 m from the building and in no part of the 6 m width be built upon or used for any purpose other than vehicular or pedestrian movement; and
 - (iii) must provide reasonable pedestrian access from the vehicular access to the building; and
 - (iv) must have a load bearing capacity and unobstructed height to permit the operation and passage of *fire brigade* vehicles; and
 - (v) must be wholly within the allotment except that a public road complying with **(i)**, **(ii)**, **(iii)** and **(iv)** may serve as the vehicular access or part thereof.

C2.5 Class 9a and 9c buildings

- (a) A Class 9a *health care building* must comply with the following:
- (i) *Patient care areas* must be divided into *fire compartments* not exceeding 2000 m².
 - (ii) *Ward areas*—
 - (A) where the *floor area* exceeds 1000 m², must be divided into *floor areas* not more than 1000 m² by walls with an FRL of not less than 60/60/60; and
 - (B) where the *floor area* exceeds 500 m², must be divided into areas not more than 500 m² by smoke proof walls complying with **Specification C2.5**; and
 - (C) where division of *ward areas* by *fire-resisting* walls under **(i)** or **(ii)(A)** is not *required*, any smoke-proof wall *required* under **(ii)(B)** must have an FRL of not less than 60/60/60.
 - (iii) *Treatment areas* must be divided into *floor areas* not more than 1000 m² by smoke-proof walls complying with **Specification C2.5**.
 - (iv) A *fire compartment* must be separated from the remainder of the building by *fire walls* and—

Deemed-to-Satisfy Provisions

- (A) in Type A construction—floors and roof or ceiling as *required* in **Specification C1.1**; and
 - (B) in Type B construction—floors with an FRL of not less than 120/120/120 and with the openings in *external walls* bounding *patient care areas* being vertically separated in accordance with the requirements of **C2.6** as if the building were of Type A construction.
- (v) The following ancillary use areas located within a *patient care area* must be separated from the remainder of the *patient care area* by walls with an FRL of not less than 60/60/60:
- (A) A kitchen and related food preparation areas having a combined *floor area* of more than 30 m².
 - (B) A room containing a hyperbaric facility (pressure chamber).
 - (C) A room used predominantly for the storage of medical records having a *floor area* of more than 10 m².
 - (D) A laundry, where items of equipment are of the type that are potential fire sources (eg. gas fire dryers).
- (vi) A wall *required* by (v) to separate ancillary use areas from the remainder of the building must extend to the underside of—
- (A) the floor above; or
 - (B) a *non-combustible* roof covering; or
 - (C) a ceiling having a *resistance to the incipient spread of fire* to the space above itself of not less than 60 minutes.
- (vii) Openings in walls *required* by (ii) and (v) to have an FRL must be protected as follows:
- (A) Doorways—*self-closing* or *automatic* closing –/60/30 fire doors.
 - (B) Windows—*automatic* or permanently fixed closed –/60/– fire windows or –/60/– *automatic* fire shutters.
 - (C) Other openings—construction having an FRL not less than –/60/–.

NSW C2.5(b)

- (b) A Class 9c *aged care building* must comply with the following:
- (i) A building must be divided into areas not more than 500 m² by smoke-proof walls complying with **Specification C2.5**.
 - (ii) A *fire compartment* must be separated from the remainder of the building by *fire walls* and, notwithstanding **C2.7** and **Specification C1.1**, floors with an FRL of not less than 60/60/60.
 - (iii) Internal walls (other than those bounding lift and stair shafts) supported by floors provided in accordance with **C2.5(b)(ii)** need not comply with **Specification C1.1** if they have an FRL not less than 60/–/–.
 - (iv) The following ancillary use areas must be separated from the *sole-occupancy units* by smoke proof walls complying with **Specification C2.5**:
 - (A) A kitchen and related food preparation areas having a combined *floor area* of more than 30 m².

Deemed-to-Satisfy Provisions

- (B) A laundry, where items of equipment are of the type that are potential fire sources (eg gas fire dryers).
- (C) Storage rooms greater than 10 m² principally for the storage of administrative records.
- (v) Openings in *fire walls* must be protected as follows:
 - (A) Doorways — *self-closing* or *automatic* closing –/60/30 fire doors.
 - (B) Windows — *automatic* or permanently fixed closed –/60/– fire windows or –/60/– *automatic* fire shutters.
 - (C) Other openings — construction having an FRL not less than –/60/–.

C2.6 Vertical separation of openings in external walls

- (a) If in a building of Type A construction, any part of a *window* or other opening in an *external wall* is above another opening in the *storey* next below and its vertical projection falls no further than 450 mm outside the lower opening (measured horizontally), the openings must be separated by—
 - (i) a spandrel which—
 - (A) is not less than 900 mm in height; and
 - (B) extends not less than 600 mm above the upper surface of the intervening floor; and
 - (C) is of *non-combustible* material having an FRL of not less than 60/60/60; or
 - (ii) part of a *curtain wall* or *panel wall* that complies with (i); or
 - (iii) construction that complies with (i) behind a *curtain wall* or *panel wall* and has any gaps packed with a *non-combustible* material that will withstand thermal expansion and structural movement of the walling without the loss of seal against fire and smoke; or
 - (iv) a slab or other horizontal construction that—
 - (A) projects outwards from the external face of the wall not less than 1100 mm; and
 - (B) extends along the wall not less than 450 mm beyond the openings concerned; and
 - (C) is *non-combustible* and has an FRL of not less than 60/60/60.
- (b) The requirements of (a) do not apply to—
 - (i) an *open-deck carpark*; or
 - (ii) an *open spectator stand*; or
 - (iii) a building which has a sprinkler system complying with **Specification E1.5** installed throughout; or
 - (iv) openings within the same stairway; or
 - (v) openings in *external walls* where the floor separating the *storeys* does not require an FRL with respect to *integrity* and *insulation*.

Deemed-to-Satisfy Provisions

- (c) For the purposes of **C2.6**, *window* or other opening means that part of the *external wall* of a building that does not have an FRL of 60/60/60 or greater.

C2.7 Separation by fire walls

- (a) **Construction** — A *fire wall* must be constructed in accordance with the following:
- (i) The *fire wall* has the relevant FRL prescribed by **Specification C1.1** for each of the adjoining parts, and if these are different, the greater FRL, except where **Tables 3.9, 4.2 and 5.2 of Specification C1.1** permit a lower FRL on the *carpark* side.
 - (ii) Any openings in a *fire wall* must comply with the *Deemed-to-Satisfy Provisions of Part C3*.
 - (iii) Building elements, other than roof battens with dimensions of 75 mm x 50 mm or less or *sarking-type material*, must not pass through or cross the *fire wall* unless the *required fire resisting* performance of the *fire wall* is maintained.
- (b) **Separation of buildings** — A part of a building separated from the remainder of the building by a *fire wall* may be treated as a separate building for the purposes of the *Deemed-to-Satisfy Provisions* of **Sections C, D and E** if it is constructed in accordance with (a) and the following:
- (i) The *fire wall* extends through all *storeys* and spaces in the nature of *storeys* that are common to that part and any adjoining part of the building.
 - (ii) The *fire wall* is carried through to the underside of the roof covering.
 - (iii) Where the roof of one of the adjoining parts is lower than the roof of the other part, the *fire wall* extends to the underside of—
 - (A) the covering of the higher roof, or not less than 6 m above the covering of the lower roof; or
 - (B) the lower roof if it has an FRL not less than that of the *fire wall* and no openings closer than 3 m to any wall above the lower roof; or
 - (C) the lower roof if its covering is *non-combustible* and the lower part has a sprinkler system complying with **Specification E1.5**.
- (c) **Separation of fire compartments** — A part of a building separated from the remainder of the building by a *fire wall* may be treated as a separate *fire compartment* if it is constructed in accordance with (a) and the *fire wall* extends to the underside of—
- (i) a floor having an FRL *required* for a *fire wall*; or
 - (ii) the roof covering.

C2.8 Separation of classifications in the same storey

If a building has parts of different classifications located alongside one another in the same *storey*—

- (a) each building element in that *storey* must have the higher FRL prescribed in **Specification C1.1** for that element for the classifications concerned; or
- (b) the parts must be separated in that *storey* by a *fire wall* having—
 - (i) the higher FRL prescribed in **Table 3** or **4**; or
 - (ii) the FRL prescribed in **Table 5**,

Deemed-to-Satisfy Provisions

of **Specification C1.1** as applicable, for that element for the Type of construction and the classifications concerned; or

- (c) where one part is a carpark complying with **Table 3.9, 4.2 or 5.2 of Specification C1.1**, the parts may be separated by a *fire wall* complying with the appropriate Table.

C2.9 Separation of classifications in different storeys

If parts of different classification are situated one above the other in adjoining *storeys* they must be separated as follows:

- (a) Type A construction — The floor between the adjoining parts must have an FRL of not less than that prescribed in **Specification C1.1** for the classification of the lower *storey*.
- (b) Type B or C construction — If one of the adjoining parts is of Class 2, 3 or 4, the floor separating the part from the *storey* below must—
 - (i) be a floor/ceiling system incorporating a ceiling which has a *resistance to the incipient spread of fire* to the space above itself of not less than 60 minutes; or
 - (ii) have an FRL of at least 30/30/30; or
 - (iii) have a *fire-protective covering* on the underside of the floor, including beams incorporated in it, if the floor is *combustible* or of metal.

C2.10 Separation of lift shafts

- (a) Any lift connecting more than 2 *storeys*, or more than 3 *storeys* if the building is sprinklered, (other than lifts which are wholly within an *atrium*) must be separated from the remainder of the building by enclosure in a *shaft* in which—
 - (i) in a building *required* to be of Type A construction—the walls have the relevant FRL prescribed by **Specification C1.1**; and
 - (ii) in a building *required* to be of Type B construction — the walls—
 - (A) if *loadbearing*, have the relevant FRL prescribed by **Table 4 of Specification C1.1**; or
 - (B) if *non-loadbearing*, be of *non-combustible* construction.
- (b) Any lift in a *patient care area* in a Class 9a *health-care building* or a *resident use area* in Class 9c *aged care building* must be separated from the remainder of the building by a *shaft* having an FRL of not less than—
 - (i) in a building of Type A or B construction — 120/120/120; or
 - (ii) in a building of Type C construction — 60/60/60.
- (c) An emergency lift must be contained within a *fire-resisting shaft* having an FRL of not less than 120/120/120.
- (d) Openings for lift landing doors and services must be protected in accordance with the *Deemed-to-Satisfy Provisions* of **Part C3**.

C2.11 Stairways and lifts in one shaft

A stairway and lift must not be in the same *shaft* if either the stairway or the lift is *required* to be in a *fire-resisting shaft*.

Deemed-to-Satisfy Provisions

C2.12 Separation of equipment

- (a) Equipment other than that described in (b) and (c) must be separated from the remainder of the building with construction complying with (d), if that equipment comprises—
 - (i) lift motors and lift control panels; or
 - (ii) emergency generators used to sustain emergency equipment operating in the emergency mode; or
 - (iii) central smoke control plant; or
 - (iv) boilers; or
 - (v) a battery or batteries installed in the building that have a voltage exceeding 24 volts and a capacity exceeding 10 ampere hours.
- (b) Equipment need not be separated in accordance with (a) if the equipment comprises—
 - (i) smoke control exhaust fans located in the air stream which are constructed for high temperature operation in accordance with **Specification E2.2b**; or
 - (ii) stair pressurising equipment installed in compliance with the relevant provisions of AS/NZS 1668.1; or
 - (iii) a lift installation without a machine-room; or
 - (iv) equipment otherwise adequately separated from the remainder of the building.
- (c) Separation of on-site fire pumps must comply with the requirements of AS 2419.1.
- (d) Separating construction must have—
 - (i) except as provided by (ii)—
 - (A) an FRL as *required* by **Specification C1.1**, but not less than 120/120/120; and
 - (B) any doorway protected with a *self-closing* fire door having an FRL of not less than -/120/30; or
 - (ii) when separating a lift *shaft* and lift motor room, an FRL not less than 120/-/-.

C2.13 Electricity supply system

- (a) An electricity substation located within a building must—
 - (i) be separated from any other part of the building by construction having an FRL of not less than 120/120/120; and
 - (ii) have any doorway in that construction protected with a *self-closing* fire door having an FRL of not less than -/120/30.
- (b) A main switchboard located within the building which sustains emergency equipment operating in the emergency mode must—
 - (i) be separated from any other part of the building by construction having an FRL of not less than 120/120/120; and
 - (ii) have any doorway in that construction protected with a *self-closing* fire door having an FRL of not less than -/120/30.

Deemed-to-Satisfy Provisions

- (c) Electrical conductors located within a building that supply—
- (i) a substation located within the building which supplies a main switchboard covered by **(b)**; or
 - (ii) a main switchboard covered by **(b)**,
- must—
- (iii) have a classification in accordance with AS/NZS 3013 of not less than—
 - (A) if located in a position that could be subject to damage by motor vehicles — WS53W; or
 - (B) otherwise — WS52W; or
 - (iv) be enclosed or otherwise protected by construction having an FRL of not less than 120/120/120.
- (d) Where emergency equipment is *required* in a building, all switchboards in the electrical installation, which sustain the electricity supply to the emergency equipment, must be constructed so that emergency equipment switchgear is separated from non-emergency equipment switchgear by metal partitions designed to minimise the spread of a fault from the non-emergency equipment switchgear.
- (e) For the purposes of **(d)**, emergency equipment includes but is not limited to the following:
- (i) Fire hydrant booster pumps.
 - (ii) Pumps for *automatic* sprinkler systems, water spray, chemical fluid suppression systems or the like.
 - (iii) Pumps for fire hose reels where such pumps and fire hose reels form the sole means of fire protection in the building.
 - (iv) Air handling systems designed to exhaust and control the spread of fire and smoke.
 - (v) Emergency lifts.
 - (vi) Control and indicating equipment.
 - (vii) Sound systems and intercom systems for emergency purposes.

C2.14 Public corridors in Class 2 and 3 buildings

In a Class 2 or 3 building, a *public corridor*, if more than 40 m in length, must be divided at intervals of not more than 40 m with smoke-proof walls complying with **Clause 2 of Specification C2.5**.

PART C3 PROTECTION OF OPENINGS

Deemed-to-Satisfy Provisions

C3.0 Deemed-to-Satisfy Provisions

- (a) Where a *Building Solution* is proposed to comply with the *Deemed-to-Satisfy Provisions, Performance Requirements CP1 to CP9* are satisfied by complying with—
- (i) **C1.1 to C1.12, C2.1 to C2.14** and **C3.1 to C3.17**; and
 - (ii) in a building containing an *atrium*, **Part G3**; and
 - (iii) for theatres, *stages* and public halls, **Part H1**.
- (b) Where a *Building Solution* is proposed as an *Alternative Solution* to the *Deemed-to-Satisfy Provisions* of—
- (i) **C1.1 to C1.12, C2.1 to C2.14** and **C3.1 to C3.17**; and
 - (ii) in a building containing an *atrium*, **Part G3**; and
 - (iii) for theatres, *stages* and public halls, **Part H1**,
- the relevant *Performance Requirements* must be determined in accordance with **A0.10**.

C3.1 Application of Part

- (a) The *Deemed-to-Satisfy Provisions* of this Part do not apply to—
- (i) control joints, weep holes and the like in *external walls* of masonry construction and joints between panels in *external walls* of pre-cast concrete panel construction if, in all cases they are not larger than necessary for the purpose; and
 - (ii) *non-combustible* ventilators for sub-floor or cavity ventilation, if each does not exceed 45 000 mm² in face area and is spaced not less than 2 m from any other ventilator in the same wall; and
 - (iii) openings in the vertical plane formed between building elements at the construction edge or perimeter of a balcony or verandah, colonnade, terrace, or the like; and
 - (iv) in a *carpark*—
 - (A) service penetrations through; and
 - (B) openings formed by a vehicle ramp in, a floor other than a floor that separates a part not used as a *carpark*.
- (b) For the purposes of the *Deemed-to-Satisfy Provisions* of this Part—
- (i) openings in building elements *required* to be *fire-resisting* include doorways, *windows* (including any associated fanlight), infill panels and fixed or openable glazed areas that do not have the *required* FRL; and
 - (ii) openings, other than those covered under **(a)(iii)**, between building elements such as columns, beams and the like, in the plane formed at the construction edge or perimeter of the building, are deemed to be openings in an *external wall*.

Deemed-to-Satisfy Provisions

C3.2 Protection of openings in external walls

Openings in an *external wall* that is *required* to have an FRL must—

- (a) if the distance between the opening and the *fire-source feature* to which it is exposed is less than—
 - (i) 3 m from a side or rear boundary of the allotment; or
 - (ii) 6 m from the far boundary of a road, river, lake or the like adjoining the allotment, if not located in a *storey* at or near ground level; or
 - (iii) 6 m from another building on the allotment that is not Class 10,
 be protected in accordance with **C3.4** and if wall-wetting sprinklers are used, they are located externally; and
- (b) if *required* to be protected under (a), not occupy more than 1/3 of the area of the *external wall* of the *storey* in which it is located unless they are in a Class 9b building used as an *open spectator stand*.

C3.3 Separation of external walls and associated openings in different fire compartments

The distance between parts of *external walls* and any openings within them in different *fire compartments* separated by a *fire wall* must not be less than that set out in **Table C3.3**, unless—

- (a) those parts of each wall have an FRL not less than 60/60/60; and
- (b) any openings protected in accordance with **C3.4**.

Table C3.3 DISTANCE BETWEEN EXTERNAL WALLS AND ASSOCIATED OPENINGS IN DIFFERENT FIRE COMPARTMENTS

Angle between walls	Min. Distance
0° (walls opposite)	6 m
more than 0° to 45°	5 m
more than 45° to 90°	4 m
more than 90° to 135°	3 m
more than 135° to less than 180°	2 m
180° or more	Nil

C3.4 Acceptable methods of protection

- (a) Where protection is *required*, doorways, *windows* and other openings must be protected as follows:
 - (i) Doorways —
 - (A) internal or external wall-wetting sprinklers as appropriate used with doors that are *self-closing* or *automatic* closing; or
 - (B) –/60/30 fire doors that are *self-closing* or *automatic* closing.

Deemed-to-Satisfy Provisions

- (ii) *Windows* —
 - (A) internal or external wall-wetting sprinklers as appropriate used with *windows* that are *automatic* closing or permanently fixed in the closed position; or
 - (B) –/60/– fire *windows* that are *automatic* closing or permanently fixed in the closed position; or
 - (C) –/60/– *automatic* closing fire shutters.
 - (iii) Other openings —
 - (A) excluding voids - internal or external wall-wetting sprinklers, as appropriate; or
 - (B) construction having an FRL not less than –/60/–.
- (b) Fire doors, fire *windows* and fire shutters must comply with **Specification C3.4**.

C3.5 Doorways in fire walls

- (a) The aggregate width of openings for doorways in a *fire wall*, which are not part of a *horizontal exit*, must not exceed ½ of the length of the *fire wall*, and each doorway must be protected by—
- (i) 2 fire doors or fire shutters, one on each side of the doorway, each of which has an FRL of not less than ½ that *required* by **Specification C1.1** for the *fire wall* except that each door or shutter must have an *insulation* level of at least 30; or
 - (ii) a fire door on one side and a fire shutter on the other side of the doorway, each of which complies with **(i)**; or
 - (iii) a single fire door or fire shutter which has an FRL of not less than that *required* by **Specification C1.1** for the *fire wall* except that each door or shutter must have an *insulation* level of at least 30.
- (b)
- (i) A fire door or fire shutter *required* by **(a)(i)**, **(a)(ii)** or **(a)(iii)** must be *self-closing*, or *automatic* closing in accordance with **(ii)** and **(iii)**.
 - (ii) The *automatic* closing operation must be initiated by the activation of a smoke detector, or any other detector deemed suitable in accordance with AS 1670.1 if smoke detectors are unsuitable in the atmosphere, installed in accordance with the relevant provisions of AS 1670.1 and located on each side of the *fire wall* not more than 1.5 m horizontal distance from the opening.
 - (iii) Where any other *required* suitable fire alarm system, including a sprinkler system complying with **Specification E1.5**, is installed in the building, activation of the system in either *fire compartment* separated by the *fire wall* must also initiate the *automatic* closing operation.

C3.6 Sliding fire doors

- (a) If a doorway in a *fire wall* is fitted with a sliding fire door which is open when the building is in use—
- (i) it must be held open with an electromagnetic device, which when de-activated in accordance with **(b)**, allows the door to be fully closed in not less than 20 seconds and not more than 30 seconds after release; and

Deemed-to-Satisfy Provisions

- (ii) in the event of power failure to the door—the door must fail safe in the closed position in accordance with (i); and
- (iii) an audible warning device must be located near the doorway and a red flashing warning light of adequate intensity on each side of the doorway must be activated in accordance with (b); and
- (iv) signs must be installed on each side of the *doorway* located directly over the opening stating—

WARNING — SLIDING FIRE DOOR

in capital letters not less than 50 mm high in a colour contrasting with the background.

- (b)
 - (i) The electromagnetic device must be de-activated and the warning system activated by heat or smoke detectors, as appropriate, installed in accordance with AS/NZS 1905.1 and the relevant provisions of AS 1670.1.
 - (ii) Where any other *required* suitable fire alarm system, including a sprinkler system complying with **Specification E1.5**, is installed in the building, activation in either *fire compartment* separated by the *fire wall* must also de-activate the electromagnetic device and activate the warning system.

C3.7 Protection of doorways in horizontal exits

- (a) A doorway that is part of a *horizontal exit* must be protected by either—
 - (i) a single fire door that has an FRL of not less than that *required* by **Specification C1.1** for the *fire wall* except that the door must have an *insulation* level of at least 30; or
 - (ii) in a Class 7 or 8 building — 2 fire doors, one on each side of the doorway, each with an FRL of not less than ½ that *required* by **Specification C1.1** for the *fire wall* except that each door must have an *insulation* level of at least 30.
- (b)
 - (i) Each door *required* by (a) must be *self-closing*, or *automatic-closing* in accordance with (ii) and (iii).
 - (ii) The *automatic-closing* operation must be initiated by the activation of a smoke detector, or any other detector deemed suitable in accordance with AS 1670.1 if smoke detectors are unsuitable in the atmosphere, installed in accordance with the relevant provisions of AS 1670.1 and located on each side of the *fire wall* not more than 1.5 m horizontal distance from the opening.
 - (iii) Where any other *required* suitable fire alarm system, including a sprinkler system complying with **Specification E1.5**, is installed in the building, activation of the system in either *fire compartment* separated by the *fire wall* must also initiate the *automatic-closing* operation.

Deemed-to-Satisfy Provisions

C3.8 Openings in fire-isolated exits

- (a)
- (i) Doorways that open to *fire-isolated stairways*, *fire-isolated passageways* or *fire-isolated ramps*, and are not doorways opening to a road or *open space*, must be protected by –/60/30 fire doors that are *self-closing*, or *automatic-closing* in accordance with (ii) and (iii).
 - (ii) The *automatic-closing* operation must be initiated by the activation of a smoke detector, or any other detector deemed suitable in accordance with AS 1670 if smoke detectors are unsuitable in the atmosphere, installed in accordance with the relevant provisions of AS 1670.1 and located not more than 1.5 m horizontal distance from the approach side of the doorway.
 - (iii) Where any other *required* suitable fire alarm system, including a sprinkler system complying with **Specification E1.5**, is installed in the building, activation of the system must also initiate the *automatic-closing* operation.
- (b) A *window* in an *external wall* of a *fire-isolated stairway*, *fire-isolated passageway* or *fire-isolated ramp* must be protected in accordance with **C3.4** if it is within 6 m of, and exposed to, a *window* or other opening in a wall of the same building, other than in the same fire-isolated enclosure.

C3.9 Service penetrations in fire-isolated exits

Fire-isolated *exits* must not be penetrated by any services other than—

- (a) electrical wiring permitted by **D2.7(e)** to be installed within the *exit*; or
- (b) ducting associated with a pressurisation system if it—
 - (i) is constructed of material having an FRL of not less than –/120/60 where it passes through any other part of the building; and
 - (ii) does not open into any other part of the building; or
- (c) water supply pipes for fire services.

C3.10 Openings in fire-isolated lift shafts

- (a) **Doorways** — If a lift *shaft* is *required* to be fire-isolated, an entrance doorway to that *shaft* must be protected by –/60/– fire doors that—
- (i) comply with AS 1735.11; and
 - (ii) are set to remain closed except when discharging or receiving passengers, goods or vehicles.
- (b) **Lift indicator panels** — A lift call panel, indicator panel or other panel in the wall of a fire-isolated lift *shaft* must be backed by construction having an FRL of not less than –/60/60 if it exceeds 35 000 mm² in area.

C3.11 Bounding construction: Class 2, 3 and 4 buildings

- (a) A doorway in a Class 2 or 3 building must be protected if it provides access from a *sole-occupancy unit* to—

Deemed-to-Satisfy Provisions

- (i) a *public corridor*, public lobby, or the like; or
 - (ii) a room not within a *sole-occupancy unit*; or
 - (iii) the landing of an internal non *fire-isolated stairway* that serves as a *required exit*; or
 - (iv) another *sole-occupancy unit*.
- (b) A doorway in a Class 2 or 3 building must be protected if it provides access from a room not within a *sole-occupancy unit* to—
- (i) a *public corridor*, public lobby, or the like; or
 - (ii) the landing of an internal non *fire-isolated stairway* that serves as a *required exit*.
- (c) A doorway in a Class 4 part must be protected if it provides access to any other internal part of the building.

NSW C3.11(d)

- (d) Protection for a doorway must be at least—
- (i) in a building of Type A construction — a *self-closing* –/60/30 fire door; and
 - (ii) in a building of Type B or C construction — a *self-closing*, tight fitting, solid core door, not less than 35 mm thick,
- except—
- (iii) in a Class 3 building used as a *residential aged care building* protected with a sprinkler system complying with **Specification E1.5**—
 - (A) a tight fitting, solid core door not less than 35 mm thick if the building is divided into *floor areas* not exceeding 500 m² with smoke proof walls complying with **Clause 2 of Specification C2.5**; or
 - (B) a tight fitting, solid core door not less than 35 mm thick fitted with a *self-closing* device, a delayed closing device or an *automatic* closing device.
- (e) Other openings in *internal walls* which are *required* to have an FRL with respect to *integrity* and *insulation* must not reduce the *fire-resisting* performance of the wall.
- (f)
- (i) A door *required* by (d) may be *automatic*-closing in accordance with (ii) and (iii).
 - (ii) The *automatic*-closing operation must be initiated by the activation of a smoke detector, or any other detector deemed suitable in accordance with AS 1670.1 if smoke detectors are unsuitable in the atmosphere, installed in accordance with the relevant provisions of AS 1670.1 and located not more than 1.5 m horizontal distance from the approach side of the doorway.
 - (iii) Where any other *required* suitable fire alarm system, including a sprinkler system complying with **Specification E1.5**, is installed in the building, activation of the system must also initiate the *automatic*-closing operation.
- (g) In a Class 2 or 3 building where a path of travel to an *exit* does not provide a person seeking egress with a choice of travel in different directions to alternative *exits* and is along an open balcony, landing or the like and passes an *external wall* of—
- (i) another *sole-occupancy unit*; or
 - (ii) a room not within a *sole-occupancy unit*,

Deemed-to-Satisfy Provisions

then that *external wall* must—

- (iii) be constructed of concrete or masonry, or be lined internally with a *fire-protective covering*; and
- (iv) have any doorway fitted with a *self-closing*, tight-fitting solid core door not less than 35 mm thick; and
- (v) have any *windows* or other openings—
 - (A) protected internally in accordance with **C3.4**; or
 - (B) located at least 1.5 m above the floor of the balcony, landing or the like.

NSW C3.11(h)

C3.12 Openings in floors and ceilings for services

- (a) Where a service passes through—
 - (i) a floor that is *required* to have an FRL with respect to *integrity* and *insulation*; or
 - (ii) a ceiling *required* to have a *resistance to the incipient spread of fire*,
 the service must be installed in accordance with **(b)**.
- (b) A service must be protected—
 - (i) in a building of Type A construction, by a *shaft* complying with **Specification C1.1**; or
 - (ii) in a building of Type B or C construction, by a *shaft* that will not reduce the fire performance of the building elements it penetrates; or
 - (iii) in accordance with **C3.15**.
- (c) Where a service passes through a floor which is *required* to be protected by a *fire-protective covering*, the penetration must not reduce the fire performance of the covering.

C3.13 Openings in shafts

In a building of Type A construction, an opening in a wall providing access to a ventilating, pipe, garbage or other service *shaft* must be protected by—

- (a) if it is in a *sanitary compartment* — a door or panel which, together with its frame, is *non-combustible* or has an FRL of not less than –/30/30; or
- (b) a *self-closing* –/60/30 fire door or hopper; or
- (c) an access panel having an FRL of not less than –/60/30; or
- (d) if the *shaft* is a garbage *shaft* — a door or hopper of *non-combustible* construction.

C3.14 * * * * *

This clause has deliberately been left blank.

Deemed-to-Satisfy Provisions

C3.15 Openings for service installations

Where an electrical, electronic, plumbing, mechanical ventilation, air-conditioning or other service penetrates a building element (other than an *external wall* or roof) that is *required* to have an FRL with respect to *integrity* or *insulation* or a *resistance to the incipient spread of fire*, that installation must comply with any one of the following:

- (a) **Tested systems.**
 - (i) The service, building element and any protection method at the penetration are identical with a prototype assembly of the service, building element and protection method which has been tested in accordance with AS 4072.1 and AS 1530.4 and has achieved the *required* FRL or *resistance to the incipient spread of fire*.
 - (ii) It complies with (i) except for the *insulation* criteria relating to the service if—
 - (A) the service is a pipe system comprised entirely of metal (excluding pipe seals or the like); and
 - (B) any *combustible* building element is not located within 100 mm of the service for a distance of 2 m from the penetration; and
 - (C) *combustible* material is not able to be located within 100 mm of the service for a distance of 2 m from the penetration; and
 - (D) it is not located in a *required exit*.
- (b) **Ventilation and air-conditioning** — In the case of ventilating or air-conditioning ducts or equipment, the installation is in accordance with AS/NZS 1668.1.
- (c) **Compliance with Specification C3.15**
 - (i) The service is a pipe system comprised entirely of metal (excluding pipe seals or the like) and is installed in accordance with **Specification C3.15** and it—
 - (A) penetrates a wall, floor or ceiling, but not a ceiling *required* to have a *resistance to the incipient spread of fire*; and
 - (B) connects not more than 2 *fire compartments* in addition to any *fire-resisting* service *shafts*; and
 - (C) does not contain a flammable or *combustible* liquid or gas.
 - (ii) The service is sanitary plumbing installed in accordance with **Specification C3.15** and it—
 - (A) is of metal or UPVC pipe; and
 - (B) penetrates the floors of a Class 5, 6, 7, 8 or 9b building; and
 - (C) is in a *sanitary compartment* separated from other parts of the building by walls with the FRL *required* by **Specification C1.1** for a stair *shaft* in the building and a *self-closing* -/60/30 fire door.
 - (iii) The service is a wire or cable, or a cluster of wires or cables installed in accordance with **Specification C3.15** and it—
 - (A) penetrates a wall, floor or ceiling, but not a ceiling *required* to have a *resistance to the incipient spread of fire*; and

Deemed-to-Satisfy Provisions

- (B) connects not more than 2 *fire compartments* in addition to any *fire-resisting* service *shafts*.
- (iv) The service is an electrical switch, outlet, or the like, and it is installed in accordance with **Specification C3.15**.

C3.16 Construction joints

Construction joints, spaces and the like in and between building elements *required* to be *fire-resisting* with respect to *integrity* and *insulation* must be protected in a manner identical with a prototype tested in accordance with AS 1530.4 to achieve the *required* FRL.

C3.17 Columns protected with lightweight construction to achieve an FRL

A column protected by *lightweight construction* to achieve an FRL which passes through a building element that is *required* to have an FRL or a *resistance to the incipient spread of fire*, must be installed using a method and materials identical with a prototype assembly of the construction which has achieved the *required* FRL or *resistance to the incipient spread of fire*.

SPECIFICATION C1.1 FIRE-RESISTING CONSTRUCTION

1. SCOPE

This Specification contains requirements for the *fire-resisting construction* of building elements.

2. GENERAL REQUIREMENTS

2.1 Exposure to fire-source features

- (a) A part of a building element is exposed to a *fire-source feature* if any of the horizontal straight lines between that part and the *fire-source feature*, or vertical projection of the feature, is not obstructed by another part of the building that—
 - (i) has an FRL of not less than 30/—/—; and
 - (ii) is neither transparent nor translucent.
- (b) A part of a building element is not exposed to a *fire-source feature* if the *fire-source feature* is—
 - (i) an *external wall* of another building that stands on the allotment and the part concerned is more than 15 m above the highest part of that *external wall*; or
 - (ii) a side or rear boundary of the allotment and the part concerned is below the level of the finished ground at every relevant part of the boundary concerned.
- (c) If various distances apply for different parts of a building element—
 - (i) the entire element must have the FRL applicable to that part having the least distance between itself and the relevant *fire-source feature*; or
 - (ii) each part of the element must have the FRL applicable according to its individual distance from the relevant *fire-source feature*,but this provision does not override or permit any exemption from **Clause 2.2**.

2.2 Fire protection for a support of another part

- (a) Where a part of a building *required* to have an FRL depends upon direct vertical or lateral support from another part to maintain its FRL, that supporting part, subject to **(b)**, must—
 - (i) have an FRL not less than that *required* by other provisions of this Specification; and
 - (ii) if located within the same *fire compartment* as the part it supports have an FRL in respect of *structural adequacy* the greater of that *required*—
 - (A) for the supporting part itself; and
 - (B) for the part it supports; and
 - (iii) be *non-combustible*—
 - (A) if *required* by other provisions of this Specification; or
 - (B) if the part it supports is *required* to be *non-combustible*.
- (b) The following building elements need not comply with **(a)(ii)** and **(a)(iii)(B)**:

- (i) An element providing lateral support to an *external wall* complying with **Clause 5.1(b)** or **C1.11**.
- (ii) An element providing support within a *carpark* and complying with **Clause 3.9, 4.2** or **5.2**.
- (iii) A roof providing lateral support in a building—
 - (A) of Type A construction if it complies with **Clause 3.5(a), (b)** or **(d)**; and
 - (B) of Type B and C construction.
- (iv) A column providing lateral support to a wall where the column complies with **Clause 2.5(a)** and **(b)**.
- (v) An element providing lateral support to a *fire wall* or *fire-resisting wall*, provided the wall is supported on both sides and failure of the element on one side does not affect the fire performance of the wall.

2.3 Lintels

A lintel must have the FRL *required* for the part of the building in which it is situated, unless it does not contribute to the support of a fire door, fire *window* or fire shutter, and—

- (a) it spans an opening in—
 - (i) a wall of a building containing only one *storey*; or
 - (ii) a non-*loadbearing* wall of a Class 2 or 3 building; or
- (b) it spans an opening in masonry which is not more than 150 mm thick and—
 - (i) not more than 3 m wide if the masonry is non-*loadbearing*; or
 - (ii) not more than 1.8 m wide if the masonry is *loadbearing* and part of a solid wall or one of the leaves of a cavity wall.

2.4 Attachments not to impair fire-resistance

- (a) A *combustible* material may be used as a finish or lining to a wall or roof, or in a sign, sunscreen or blind, awning, or other attachment to a building element which has the *required* FRL if—
 - (i) the material is exempted under **C1.10** or complies with the *fire hazard properties* prescribed in—
 - (A) **Clause 2 of Specification C1.10**; or
 - (B) **Clause 2** and **3 of Specification C1.10a**; and
 - (ii) it is not located near or directly above a *required exit* so as to make the *exit* unusable in a fire; and
 - (iii) it does not otherwise constitute an undue risk of fire spread via the facade of the building.
- (b) The attachment of a facing or finish, or the installation of ducting or any other service, to a part of a building *required* to have an FRL must not impair the *required* FRL of that part.

2.5 General concessions

- (a) **Steel columns** — A steel column, other than one in a *fire wall* or *common wall*, need not have an FRL in a building that contains—

- (i) only 1 *storey*; or
- (ii) 2 *storeys* in some of its parts and 1 *storey* only in its remaining parts if the sum of the *floor areas* of the upper *storeys* of its 2 *storey* parts does not exceed the lesser of—
 - (A) 1/8 of the sum of the *floor areas* of the 1 *storey* parts; or
 - (B) in the case of a building to which one of the maximum *floor areas* specified in **Table C2.2** is applicable — 1/10 of that area; or
 - (C) in the case of a building to which two or more of the maximum *floor areas* specified in **Table C2.2** is applicable — 1/10 of the lesser of those areas.
- (b) **Timber columns** — A timber column may be used in a single *storey* building if—
 - (i) in a *fire wall* or *common wall* the column has an FRL not less than that listed in the appropriate **Table 3, 4 or 5**; and
 - (ii) in any other case where the column is *required* to have an FRL in accordance with **Table 3, 4 or 5**, it has an FRL of not less than 30/–/–.
- (c) **Structures on roofs** — A *non-combustible* structure situated on a roof need not comply with the other provisions of this Specification if it only contains—
 - (i) lift motor equipment; or
 - (ii) one or more of the following:
 - (A) Hot water or other water tanks.
 - (B) Ventilating ductwork, ventilating fans and their motors.
 - (C) Air-conditioning chillers.
 - (D) *Window* cleaning equipment.
 - (E) Other service units that are *non-combustible* and do not contain *combustible* liquids or gases.
- (d) **Curtain walls and panel walls** — A requirement for an *external wall* to have an FRL does not apply to a *curtain wall* or *panel wall* which is of *non-combustible* construction and fully protected by *automatic* external wall-wetting sprinklers.
- (e) * * * * *

This clause has deliberately been left blank.

- (f) **Balconies and verandahs** — A balcony, verandah or the like and any incorporated supporting part, which is attached to or forms part of a building, need not comply with **Tables 3, 4 and 5** if—
 - (i) it does not form part of the only path of travel to a *required exit* from the building; and
 - (ii) in Type A construction—
 - (A) it is situated not more than 2 *storeys* above the lowest *storey* providing direct egress to a road or *open space*; and
 - (B) any supporting columns are of *non-combustible* construction.

2.6 Mezzanine floors: Concession

- (a) This Clause does not apply to a Class 9b building that is a spectator stand or audience viewing area accommodating more than 100 persons as calculated according to **D1.13**.
- (b) A *mezzanine* and its supports need not have an FRL or be *non-combustible* provided—
 - (i) the total *floor area* of all the *mezzanines* in the same room does not exceed 1/3 of the *floor area* of the room or 200 m², whichever is the lesser; and
 - (ii) the FRL of each wall and column that supports any other part of the building within 6 m of the *mezzanine* is increased by the amount listed in **Table 2.6**.

Table 2.6 INCREASED FRLs — CONSTRUCTION SURROUNDING MEZZANINES

Level otherwise required for any FRL criterion (mins)	Increase in level to (not less than):
30	60
60	90
90	120
120	180
180	240

The increase in level applies to each FRL criterion (*structural adequacy*, *integrity* or *insulation*) relevant to the building element concerned.

2.7 Enclosure of shafts

Shafts required to have an FRL must be enclosed at the top and bottom by construction having an FRL not less than that *required* for the walls of a non-*loadbearing shaft* in the same building, except that these provisions need not apply to—

- (a) the top of a *shaft* extending beyond the roof covering, other than one enclosing a *fire-isolated stairway* or *ramp*; or
- (b) the bottom of a *shaft* if it is *non-combustible* and laid directly on the ground.

2.8 Carparks in Class 2 and 3 buildings

- (a) If a Class 2 building contains not more than 4 *storeys* of which—
 - (i) one *storey* is Class 7 used solely for the purpose of parking motor vehicles or for some other purpose that is ancillary to a Class 2; and
 - (ii) the remaining *storeys* are of Class 2,
 the *carpark storey* is regarded as Class 2 only for the purpose of determining the relevant *fire-resisting* requirements of this Specification.
- (b) If a Class 3 building or a building of Class 2 and 3 contains not more than 3 *storeys* of which—
 - (i) one *storey* is Class 7 used solely for the purpose of parking motor vehicles or for some other purpose that is ancillary to the other *storeys*; and
 - (ii) the remaining *storeys* are of Class 2 or 3,

the *carpark storey* is regarded as Class 2 or 3 only for the purpose of determining the relevant *fire-resisting* requirements of this Specification.

2.9 Residential aged care building: Concession

In a Class 3 building protected with a sprinkler system complying with **Specification E1.5** and used as a *residential aged care building*, any FRL criterion prescribed in **Tables 3, 4** or **5**—

- (a) for any floor and any *loadbearing* wall, may be reduced to 60, except any FRL criterion of 90 for an *external wall* must be maintained when tested from the outside; and
- (b) for any non-*loadbearing internal wall*, need not apply if—
 - (i) it is lined on each side with standard grade plasterboard not less than 13 mm thick or similar *non-combustible* material; and
 - (ii) it extends—
 - (A) to the underside of the floor next above; or
 - (B) to the underside of a ceiling lined with standard grade plasterboard not less than 13 mm thick or a material with at least an equivalent level of fire protection; or
 - (C) to the underside of a *non-combustible* roof covering; and
 - (iii) any insulation installed in the cavity of the wall is *non-combustible*; and
 - (iv) any construction joint, space or the like between the top of the wall and the floor, ceiling or roof is smoke sealed with intumescent putty or other suitable material.

3. TYPE A FIRE-RESISTING CONSTRUCTION

3.1 Fire-resistance of building elements

In a building *required* to be of Type A construction—

- (a) each building element listed in **Table 3** and any beam or column incorporated in it, must have an FRL not less than that listed in the Table for the particular Class of building concerned; and
- (b) *external walls*, *common walls* and the flooring and floor framing of lift pits must be *non-combustible*; and
- (c) any *internal wall required* to have an FRL with respect to *integrity* and *insulation* must extend to—
 - (i) the underside of the floor next above; or
 - (ii) the underside of a roof complying with **Table 3**; or
 - (iii) if under **Clause 3.5** the roof is not *required* to comply with **Table 3**, the underside of the *non-combustible* roof covering and, except for roof battens with dimensions of 75 mm x 50 mm or less or *sarking-type material*, must not be crossed by timber or other *combustible* building elements; or
 - (iv) a ceiling that is immediately below the roof and has a *resistance to the incipient spread of fire* to the roof space between the ceiling and the roof of not less than 60 minutes; and

- (d) a *loadbearing internal wall* and a *loadbearing fire wall* (including those that are part of a *loadbearing shaft*) must be of concrete or masonry; and
- (e) a non-*loadbearing*—
 - (i) *internal wall required* to be *fire-resisting*; and
 - (ii) lift, ventilating, pipe, garbage, or similar *shaft* that is not for the discharge of hot products of combustion, must be of *non-combustible* construction; and
- (f) the FRLs specified in **Table 3** for an external column apply also to those parts of an internal column that face and are within 1.5 m of a *window* and are exposed through that *window* to a *fire-source feature*.

Table 3 TYPE A CONSTRUCTION: FRL OF BUILDING ELEMENTS

Building element	Class of building — FRL: (in minutes)			
	<i>Structural adequacy/Integrity/Insulation</i>			
	2, 3 or 4 part	5, 7a or 9	6	7b or 8
EXTERNAL WALL (including any column and other building element incorporated therein) or other external building element, where the distance from any <i>fire-source feature</i> to which it is exposed is—				
For <i>loadbearing</i> parts—				
less than 1.5 m	90/ 90/ 90	120/120/120	180/180/180	240/240/240
1.5 to less than 3 m	90/ 60/ 60	120/ 90/ 90	180/180/120	240/240/180
3 m or more	90/ 60/ 30	120/ 60/ 30	180/120/ 90	240/180/ 90
For non- <i>loadbearing</i> parts—				
less than 1.5 m	- / 90/ 90	- /120/120	- /180/180	- /240/240
1.5 to less than 3 m	- / 60/ 60	- / 90/ 90	- /180/120	- /240/180
3 m or more	- / - / -	- / - / -	- / - / -	- / - / -
EXTERNAL COLUMN not incorporated in an <i>external wall</i> , where the distance from any <i>fire-source feature</i> to which it is exposed is—				
less than 3 m	90/ - / -	120/ - / -	180/ - / -	240/ - / -
3 m or more	- / - / -	- / - / -	- / - / -	- / - / -
COMMON WALLS and FIRE WALLS—	90/ 90/ 90	120/120/120	180/180/180	240/240/240

Table 3 TYPE A CONSTRUCTION: FRL OF BUILDING ELEMENTS— continued

Building element	Class of building — FRL: (in minutes)			
	<i>Structural adequacy/Integrity/Insulation</i>			
	2, 3 or 4 part	5, 7a or 9	6	7b or 8
INTERNAL WALLS—				
<i>Fire-resisting</i> lift and stair <i>shafts</i> —				
<i>Loadbearing</i>	90/ 90/ 90	120/120/120	180/120/120	240/120/120
Non- <i>loadbearing</i>	- / 90/ 90	- /120/120	- /120/120	- /120/120
Bounding <i>public corridors</i> , public lobbies and the like—				
<i>Loadbearing</i>	90/ 90/ 90	120/ - / -	180/ - / -	240/ - / -
Non- <i>loadbearing</i>	- / 60/ 60	- / - / -	- / - / -	- / - / -
Between or bounding <i>sole-occupancy units</i> —				
<i>Loadbearing</i>	90/ 90/ 90	120/ - / -	180/ - / -	240/ - / -
Non- <i>loadbearing</i>	- / 60/ 60	- / - / -	- / - / -	- / - / -
Ventilating, pipe, garbage, and like <i>shafts</i> not used for the discharge of hot products of combustion—				
<i>Loadbearing</i>	90/ 90/ 90	120/ 90/ 90	180/120/120	240/120/120
Non- <i>loadbearing</i>	- / 90/ 90	- / 90/ 90	- /120/120	- /120/120
OTHER LOADBEARING INTERNAL WALLS, INTERNAL BEAMS, TRUSSES and COLUMNS—				
	90/ - / -	120/ - / -	180/ - / -	240/ - / -
FLOORS	90/ 90/ 90	120/120/120	180/180/180	240/240/240
ROOFS	90/ 60/ 30	120/ 60/ 30	180/ 60/ 30	240/ 90/ 60

3.2 Concessions for floors

A floor need not comply with **Table 3** if—

- (a) it is laid directly on the ground; or
- (b) in a Class 2, 3, 5 or 9 building, the space below is not a *storey*, does not accommodate motor vehicles, is not a storage or work area, and is not used for any other ancillary purpose; or
- (c) it is a timber *stage* floor in a Class 9b building laid over a floor having the *required* FRL and the space below the *stage* is not used as a dressing room, store room, or the like; or
- (d) it is within a *sole-occupancy unit* in a Class 2 or 3 building or Class 4 part; or
- (e) it is an open-access floor (for the accommodation of electrical and electronic services and the like) above a floor with the *required* FRL.

3.3 Floor loading of Class 5 and 9b buildings: Concession

If a floor in a Class 5 or 9b building is designed for a live load not exceeding 3 kPa—

- (a) the floor next above (including floor beams) may have an FRL of 90/90/90; or
- (b) the roof, if that is next above (including roof beams) may have an FRL of 90/60/30.

3.4 Roof superimposed on concrete slab: Concession

A roof superimposed on a concrete slab roof need not comply with **Clause 3.1** as to *fire-resisting construction* if—

- (a) the superimposed roof and any construction between it and the concrete slab roof are *non-combustible* throughout; and
- (b) the concrete slab roof complies with **Table 3**.

3.5 Roof: Concession

A roof need not comply with **Table 3** if its covering is *non-combustible* and the building—

- (a) has a sprinkler system complying with **Specification E1.5** installed throughout; or
- (b) has a *rise in storeys* of 3 or less; or
- (c) is of Class 2 or 3; or
- (d) has an *effective height* of not more than 25 m and the ceiling immediately below the roof has a *resistance to the incipient spread of fire* to the roof space of not less than 60 minutes.

3.6 Rooflights

If a roof is *required* to have an FRL or its covering is *required* to be *non-combustible*, rooflights or the like installed in that roof must—

- (a) have an aggregate area of not more than 20% of the roof surface; and
- (b) be not less than 3 m from—
 - (i) any boundary of the allotment other than the boundary with a road or public place; and
 - (ii) any part of the building which projects above the roof unless that part has the FRL *required* of a *fire wall* and any openings in that part of the wall for 6 m vertically above the rooflight or the like are protected in accordance with **C3.4**; and
 - (iii) any rooflight or the like in an adjoining *sole-occupancy unit* if the walls bounding the unit are *required* to have an FRL; and
 - (iv) any rooflight or the like in an adjoining fire-separated section of the building; and
- (c) if a ceiling with a *resistance to the incipient spread of fire* is *required*, be installed in a way that will maintain the level of protection provided by the ceiling to the roof space.

3.7 Internal columns and walls: Concession

For a building with an *effective height* of not more than 25 m and having a roof without an FRL in accordance with **Clause 3.5**, in the *storey* immediately below that roof, internal columns other than those referred to in **Clause 3.1(f)** and *internal walls* other than *fire walls* and *shaft walls* may have—

- (a) in a Class 2 or 3 building: FRL 60/60/60; or
- (b) in a Class 5, 6, 7, 8 or 9 building—
 - (i) with *rise in storeys* exceeding 3: FRL 60/60/60
 - (ii) with *rise in storeys* not exceeding 3: no FRL.

3.8 Open spectator stands and indoor sports stadiums: Concession

In an *open spectator stand* or indoor sports stadium, the following building elements need not have the FRL specified in **Table 3**:

- (a) The roof if it is *non-combustible*.
- (b) Columns and *loadbearing* walls supporting only the roof if they are *non-combustible*.
- (c) Any non-*loadbearing* part of an *external wall* less than 3 m—
 - (i) from any *fire-source feature* to which it is exposed if it has an FRL of not less than –/60/60 and is *non-combustible*; or
 - (ii) from an *external wall* of another *open spectator stand* if it is *non-combustible*.

3.9 Carparks

- (a) Notwithstanding **Clause 3.1**, a *carpark* may comply with **Table 3.9** if it is an *open-deck carpark* or is protected with a sprinkler system complying with **Specification E1.5** and is—
 - (i) a separate building; or
 - (ii) a part of a building—
 - (A) which only occupies part of a *storey*, and is separated from the remaining part by a *fire wall*; or
 - (B) which is located above or below another classification, and the floor separating the classifications complies with **C2.9**; or
 - (C) which is located above another Class 7 part of the building not used for carparking, and the floor separating the parts complies with **Table 3** for a Class 7 part other than a *carpark*; or
 - (D) which is located below another Class 7 part of the building not used for carparking, and the floor separating the parts complies with **Table 3.9**.
- (b) For the purposes of this clause, a *carpark*—
 - (i) includes—
 - (A) an administration area associated with the functioning of the *carpark*; and
 - (B) where the *carpark* is sprinklered, is associated with a Class 2 or 3 building and provides carparking for separate *sole-occupancy units*, each carparking area with an area not greater than 10% of its *floor area* for purposes ancillary to the *sole-occupancy units*; but
 - (ii) excludes—
 - (A) except for **(b)(i)**, any area of another classification, or other part of a Class 7 building not used for carparking; and
 - (B) a building or part of a building specifically intended for the parking of trucks, buses, vans and the like.

Table 3.9 REQUIREMENTS FOR CARPARKS

Building element	FRL (not less than) <i>Structural adequacy/Integrity/Insulation</i> ESA/M (not greater than)
Wall	
(a) <i>external wall</i>	
(i) less than 3 m from a <i>fire-source feature</i> to which it is exposed:	
<i>Loadbearing</i>	60/60/60
Non- <i>loadbearing</i>	- /60/60
(ii) 3 m or more from a <i>fire-source feature</i> to which it is exposed	- / - / -
(b) <i>internal wall</i>	
(i) <i>loadbearing</i> , other than one supporting only the roof (not used for carparking)	60/ - / -
(ii) supporting only the roof (not used for carparking)	- / - / -
(iii) non- <i>loadbearing</i>	- / - / -
(c) <i>fire wall</i>	
(i) from the direction used as a <i>carpark</i>	60/60/60
(ii) from the direction not used as a <i>carpark</i>	as <i>required</i> by Table 3
Column	
(a) supporting only the roof (not used for carparking) and 3 m or more from a <i>fire-source feature</i> to which it is exposed	- / - / -
(b) steel column, other than one covered by (a) and one that does not support a part of a building that is not used as a <i>carpark</i>	60/ - / - or 26 m ² /tonne
(c) any other column not covered by (a) or (b)	60/ - / -
Beam	
(a) steel floor beam in continuous contact with a concrete floor slab	60/ - / - or 30 m ² /tonne
(b) any other beam	60/ - / -
Fire-resisting lift and stair shaft (within the <i>carpark</i> only)	60/60/60
Floor slab and vehicle ramp	60/60/60
Roof (not used for carparking)	- / - / -
Notes: 1. ESA/M means the ratio of exposed surface area to mass per unit length.	

Table 3.9 REQUIREMENTS FOR CARPARKS— continued

Building element	FRL (not less than) <i>Structural adequacy/Integrity/Insulation</i> ESA/M (not greater than)
2.	Refer to Specification E1.5 for special requirements for a sprinkler system in a <i>carpark</i> complying with Table 3.9 and located within a multi-classified building.

3.10 Class 2 buildings: Concession

- (a) A Class 2 building having a *rise in storeys* of not more than 3 need not comply with **Clauses 3.1(b), (d) and (e) of Specification C1.1** and the requirement of **C2.6** for *non-combustible* material, if it is constructed using—
 - (i) timber framing throughout; or
 - (ii) *non-combustible* material throughout; or
 - (iii) a combination of (i) and (ii),
 provided—
 - (iv) * * * * *
 - (v) any insulation installed in the cavity of a wall *required* to have an FRL is *non-combustible*; and
 - (vi) the building is fitted with an *automatic* smoke alarm system complying with **Specification E2.2a**.
- (b) A Class 2 building having a *rise in storeys* of not more than 4 may have the top three *storeys* constructed in accordance with (a) provided—
 - (i) the lowest *storey* is used solely for the purpose of parking motor vehicles or for some other ancillary purpose; and
 - (ii) the lowest *storey* is constructed of concrete or masonry including the floor between it and the Class 2 part of the building above; and
 - (iii) the lowest *storey* and the *storey* above are separated by construction having an FRL of not less than 90/90/90 with no openings or penetrations that would reduce the *fire-resisting* performance of that construction except that a doorway in that construction may be protected by a –/60/30 *self-closing* fire door.
- (c) In a Class 2 building complying with (a) or (b) and fitted with a sprinkler system complying with **Specification E1.5**, any FRL criterion prescribed in **Table 3**—
 - (i) for any floor and any *loadbearing* wall, may be reduced to 60, except any FRL criterion of 90 for an *external wall* must be maintained when tested from the outside; and
 - (ii) for any non-*loadbearing internal wall*, need not apply if—
 - (A) it is lined on each side with 13 mm standard grade plasterboard or similar *non-combustible* material; and
 - (B) it extends—
 - (aa) to the underside of the floor next above; or

- (bb) to the underside of a ceiling with a *resistance to the incipient spread of fire* of 60 minutes; or
- (cc) to the underside of a *non-combustible* roof covering; and
- (C) any insulation installed in the cavity of the wall is *non-combustible*; and
- (D) any construction joint, space or the like between the top of the wall and the floor, ceiling or roof is smoke sealed with intumescent putty or other suitable material; and
- (E) any doorway in the wall is protected by a *self-closing*, tight fitting, solid core door not less than 35 mm thick.

4. TYPE B FIRE-RESISTING CONSTRUCTION

4.1 Fire-resistance of building elements

In a building *required* to be of Type B construction—

- (a) each building element listed in **Table 4**, and any beam or column incorporated in it, must have an FRL not less than that listed in the Table for the particular Class of building concerned; and
- (b) the *external walls*, *common walls*, and the flooring and floor framing in any lift pit, must be *non-combustible*; and
- (c) if a stair *shaft* supports any floor or a structural part of it—
 - (i) the floor or part must have an FRL of 60/–/– or more; or
 - (ii) the junction of the stair *shaft* must be constructed so that the floor or part will be free to sag or fall in a fire without causing structural damage to the *shaft*; and
- (d) any *internal wall* which is *required* to have an FRL with respect to *integrity* and *insulation*, except a wall that bounds a *sole-occupancy unit* in the topmost (or only) *storey* and there is only one unit in that *storey*, must extend to—
 - (i) the underside of the floor next above if that floor has an FRL of at least 30/30/30; or
 - (ii) the underside of a ceiling having a *resistance to the incipient spread of fire* to the space above itself of not less than 60 minutes; or
 - (iii) the underside of the roof covering if it is *non-combustible* and, except for roof battens with dimensions of 75 mm x 50 mm or less or *sarking-type material*, must not be crossed by timber or other *combustible* building elements; or
 - (iv) 450 mm above the roof covering if it is *combustible*; and
- (e) a *loadbearing internal wall* and a *loadbearing fire wall* (including those that are part of a *loadbearing shaft*) must be of concrete or masonry; and
- (f) a non-*loadbearing internal wall required* to be *fire-resisting* must be of *non-combustible* construction; and
- (g) in a Class 5, 6, 7, 8 or 9 building, in the *storey* immediately below the roof, internal columns and *internal walls* other than *fire walls* and *shaft* walls, need not comply with **Table 4**; and

- (h) lift, subject to **C2.10**, ventilating, pipe, garbage, and similar *shafts* which are not for the discharge of hot products of combustion and not *loadbearing*, must be of *non-combustible* construction in—
- (i) a Class 2, 3 or 9 building; and
 - (ii) a Class 5, 6, 7 or 8 building if the *shaft* connects more than 2 *storeys*; and
- (i) in a Class 2 or 3 building, except where within the one *sole-occupancy unit*, or a Class 9a *health-care building* or a Class 9b building, a floor separating *storeys* or above a space for the accommodation of motor vehicles or used for storage or any other ancillary purpose, must—
- (i) be constructed so that it is at least of the standard achieved by a floor/ceiling system incorporating a ceiling which has a *resistance to the incipient spread of fire* to the space above itself of not less than 60 minutes; or
 - (ii) have an FRL of at least 30/30/30; or
 - (iii) have a *fire-protective covering* on the underside of the floor, including beams incorporated in it, if the floor is *combustible* or of metal; and
- (j) in a Class 9c *aged care building* a floor above a space for the accommodation of motor vehicles or used for storage or any other ancillary purpose, and any column supporting the floor must—
- (i) be constructed so that it is at least of the standard achieved by a floor/ceiling system incorporating a ceiling which has a *resistance to the incipient spread of fire* to the space above itself of not less than 60 minutes; or
 - (ii) have an FRL of at least 30/30/30; or
 - (iii) have a *fire-protective covering* on the underside of the floor, including beams incorporated in it, if the floor is *combustible* or of metal.

Table 4 TYPE B CONSTRUCTION: FRL OF BUILDING ELEMENTS

Building element	Class of building—FRL: (in minutes)			
	<i>Structural adequacy/Integrity/Insulation</i>			
	2, 3 or 4 part	5, 7a or 9	6	7b or 8
EXTERNAL WALL (including any column and other building element incorporated therein) or other external building element, where the distance from any <i>fire-source feature</i> to which it is exposed is—				
For <i>loadbearing</i> parts—				
less than 1.5 m	90/ 90/ 90	120/120/120	180/180/180	240/240/240
1.5 to less than 3 m	90/ 60/ 30	120/ 90/ 60	180/120/ 90	240/180/120
3 to less than 9 m	90/ 30/ 30	120/ 30/ 30	180/ 90/ 60	240/ 90/ 60
9 to less than 18 m	90/ 30/ -	120/ 30/ -	180/ 60/ -	240/ 60/ -
18 m or more	- / - / -	- / - / -	- / - / -	- / - / -
For non- <i>loadbearing</i> parts—				
less than 1.5 m	- / 90/ 90	- /120/120	- /180/180	- /240/240
1.5 to less than 3 m	- / 60/ 30	- / 90/ 60	- /120/ 90	- /180/120
3 m or more	- / - / -	- / - / -	- / - / -	- / - / -
EXTERNAL COLUMN not incorporated in an <i>external wall</i> , where the distance from any <i>fire-source feature</i> to which it is exposed is—				
less than 3 m	90/ - / -	120/ - / -	180/ - / -	240/ - / -
3 m or more	- / - / -	- / - / -	- / - / -	- / - / -
COMMON WALLS and FIRE WALLS—	90/ 90 / 90	120/120/120	180/180/180	240/240/240
INTERNAL WALLS—				
<i>Fire-resisting</i> lift and stair <i>shafts</i> —				
<i>Loadbearing</i>	90/ 90/ 90	120/120/120	180/120/120	240/120/120
<i>Fire-resisting</i> stair <i>shafts</i>				
Non- <i>loadbearing</i>	- / 90/ 90	- /120/120	- /120/120	- /120/120
Bounding <i>public corridors</i> , public lobbies and the like—				
<i>Loadbearing</i>	60/ 60/ 60	120/ - / -	180/ - / -	240/ - / -
Non- <i>loadbearing</i>	- / 60/ 60	- / - / -	- / - / -	- / - / -
Between or bounding <i>sole-occupancy units</i> —				
<i>Loadbearing</i>	60/ 60/ 60	120/ - / -	180/ - / -	240/ - / -
Non- <i>loadbearing</i>	- / 60/ 60	- / - / -	- / - / -	- / - / -
OTHER LOADBEARING INTERNAL WALLS and COLUMNS—				
	60/ - / -	120/ - / -	180/ - / -	240/ - / -
ROOFS	- / - / -	- / - / -	- / - / -	- / - / -

4.2 Carparks

- (a) Notwithstanding **Clause 4.1**, a *carpark* may comply with **Table 4.2** if it is an *open-deck carpark* or is protected with a sprinkler system complying with **Specification E1.5** and is—
- (i) a separate building; or
 - (ii) a part of a building, and if occupying only part of a *storey*, is separated from the remaining part by a *fire wall*.
- (b) For the purposes of this clause, a *carpark*—
- (i) includes—
 - (A) an administration area associated with the functioning of the *carpark*; and
 - (B) where the *carpark* is sprinklered, is associated with a Class 2 or 3 building and provides carparking for separate *sole-occupancy units*, each carparking area with an area not greater than 10% of its *floor area* for purposes ancillary to the *sole-occupancy units*; but
 - (ii) excludes—
 - (A) except for **(b)(i)**, any area of another classification, or other part of a Class 7 building not used for carparking; and
 - (B) a building or part of a building specifically intended for the parking of trucks, buses, vans and the like.

Table 4.2 REQUIREMENTS FOR CARPARKS

Building element	FRL (not less than) <i>Structural adequacy/Integrity/Insulation</i> ESA/M (not greater than)
Wall	
(a) <i>external wall</i>	
(i) less than 3 m from a <i>fire-source feature</i> to which it is exposed:	
<i>Loadbearing</i>	60/60/60
Non- <i>loadbearing</i>	- /60/60
(ii) 3 m or more from a <i>fire-source feature</i> to which it is exposed	- / - / -
(b) <i>internal wall</i>	
(i) <i>loadbearing</i> , other than one supporting only the roof (not used for carparking)	60/ - / -
(ii) supporting only the roof (not used for carparking)	- / - / -
(iii) non- <i>loadbearing</i>	- / - / -

Table 4.2 REQUIREMENTS FOR CARPARKS— continued

Building element	FRL (not less than) <i>Structural adequacy/Integrity/Insulation</i> ESA/M (not greater than)
(c) <i>fire wall</i>	
(i) from the direction used as a <i>carpark</i>	60/60/60
(ii) from the direction not used as a <i>carpark</i>	as <i>required</i> by Table 4
Column	
(a) supporting only the roof (not used for carparking) and 3 m or more from a <i>fire-source feature</i> to which it is exposed	- / - / -
(b) steel column, other than one covered by (a)	60/ - / - or 26 m ² /tonne
(c) any other column not covered by (a) or (b)	60/ - / -
Beam	
(a) less than 3 m from a <i>fire-source feature</i> :	
(i) steel floor beam in continuous contact with a concrete floor slab	60/ - / - or 30 m ² /tonne
(ii) any other beam	60/ - / -
(b) 3 m or more from a <i>fire-source feature</i>	- / - / -
Lift shaft	- / - / -
Fire-resisting stair shaft (within the <i>carpark</i> only)	60/60/60
Roof, floor slab and vehicle ramp	- / - / -
Note: ESA/M means the ratio of exposed surface area to mass per unit length.	

4.3 Class 2 buildings: Concession

- (a) A Class 2 building having a *rise in storeys* of not more than 2 need not comply with **Clause 4.1(b), (e), (f) and (h)** of Specification C1.1 if it is constructed using—
- (i) timber framing throughout; or
 - (ii) *non-combustible* material throughout; or
 - (iii) a combination of **(i)** and **(ii)**,
- provided—
- (iv) * * * * *
 - (v) any insulation installed in the cavity of a wall *required* to have an FRL is *non-combustible*; and
 - (vi) the building is fitted with an *automatic* smoke alarm system complying with **Specification E2.2a**.
- (b) A Class 2 building having a *rise in storeys* of not more than 2 may have the top *storey* constructed in accordance with **(a)** provided—

- (i) the lowest *storey* is used solely for the purpose of parking motor vehicles or for some other ancillary purpose; and
 - (ii) the lowest *storey* is constructed of concrete or masonry including the floor between it and the Class 2 part of the building above; and
 - (iii) the lowest *storey* and the *storey* above are separated by construction having an FRL of not less than 90/90/90 with no openings or penetrations that would reduce the *fire-resisting* performance of that construction except that a doorway in that construction may be protected by a –/60/30 *self-closing* fire door.
- (c) In a Class 2 building complying with (a) or (b) and fitted with a sprinkler system complying with **Specification E1.5**, any FRL criterion prescribed in **Table 4**—
- (i) for any *loadbearing* wall, may be reduced to 60, except any FRL criterion of 90 for an *external wall* must be maintained when tested from the outside; and
 - (ii) for any non-*loadbearing internal wall*, need not apply, if—
 - (A) it is lined on both sides with 13 mm standard grade plasterboard or similar *non-combustible* material; and
 - (B) it extends—
 - (aa) to the underside of the floor next above if that floor has an FRL of at least 30/30/30 or is lined on the underside with a *fire-protective covering*; or
 - (bb) to the underside of a ceiling with a *resistance to the incipient spread of fire* of 60 minutes; or
 - (cc) to the underside of a *non-combustible* roof covering; and
 - (C) any insulation installed in the cavity of the wall is *non-combustible*; and
 - (D) any construction joints, spaces and the like between the top of the wall and the floor, ceiling or roof is smoke sealed with intumescent putty or other suitable material.

5. TYPE C FIRE-RESISTING CONSTRUCTION

5.1 Fire-resistance of building elements

In a building *required* to be of Type C construction—

- (a) a building element listed in **Table 5** and any beam or column incorporated in it, must have an FRL not less than that listed in the Table for the particular Class of building concerned; and
- (b) an *external wall* that is *required* by **Table 5** to have an FRL need only be tested from the outside to satisfy the requirement; and
- (c) a *fire wall* or an *internal wall* bounding a *sole-occupancy unit* or separating adjoining units must comply with **Specification C1.8** if it is of *lightweight construction* and is *required* to have an FRL; and
- (d) in a Class 2 or 3 building, an *internal wall* which is *required* by **Table 5** to have an FRL must extend—
 - (i) to the underside of the floor next above if that floor has an FRL of at least 30/30/30 or a *fire-protective covering* on the underside of the floor; or

- (ii) to the underside of a ceiling having a *resistance to the incipient spread of fire* to the space above itself of not less than 60 minutes; or
- (iii) to the underside of the roof covering if it is *non-combustible*, and except for roof battens with dimensions of 75 mm x 50 mm or less or *sarking-type material*, must not be crossed by timber or other *combustible* building elements; or
- (iv) 450 mm above the roof covering if it is *combustible*; and
- (e) in a Class 2 or 3 building, except where within the one *sole-occupancy unit*, or a Class 9a *health-care building*, or a Class 9b building, a floor separating *storeys*, or above a space for the accommodation of motor vehicles or used for storage or any other ancillary purpose, and any column supporting the floor, must—
 - (i) have an FRL of at least 30/30/30; or
 - (ii) have a *fire-protective covering* on the underside of the floor including beams incorporated in it and around the column, if the floor or column is *combustible* or of metal; and
- (f) in a Class 9c *aged care building* a floor above a space for the accommodation of motor vehicles or used for storage or any other ancillary purpose, and any column supporting the floor, must—
 - (i) have an FRL of at least 30/30/30; or
 - (ii) have a *fire-protective covering* on the underside of the floor including beams incorporated in it and around the column, if the floor or column is *combustible* or of metal.

Table 5 TYPE C CONSTRUCTION: FRL OF BUILDING ELEMENTS

Building element	Class of building—FRL: (in minutes)			
	<i>Structural adequacy/Integrity/Insulation</i>			
	2, 3 or 4 part	5, 7a or 9	6	7b or 8
EXTERNAL WALL (including any column and other building element incorporated therein) or other external building element, where the distance from any <i>fire-source feature</i> to which it is exposed is—				
Less than 1.5 m	90/ 90/ 90	90/ 90/ 90	90/ 90/ 90	90/ 90/ 90
1.5 to less than 3 m	- / - / -	60/ 60/ 60	60/ 60/ 60	60/ 60/ 60
3 m or more	- / - / -	- / - / -	- / - / -	- / - / -
EXTERNAL COLUMN not incorporated in an <i>external wall</i> , where the distance from any <i>fire-source feature</i> to which it is exposed is—				
Less than 1.5 m	90/ - / -	90/ - / -	90/ - / -	90/ - / -
1.5 to less than 3 m	- / - / -	60/ - / -	60/ - / -	60/ - / -
3 m or more	- / - / -	- / - / -	- / - / -	- / - / -
COMMON WALLS and FIRE WALLS—	90/ 90/ 90	90/ 90/ 90	90/ 90/ 90	90/ 90/ 90

Table 5 TYPE C CONSTRUCTION: FRL OF BUILDING ELEMENTS— continued

Building element	Class of building—FRL: (in minutes)			
	<i>Structural adequacy/Integrity/Insulation</i>			
	2, 3 or 4 part	5, 7a or 9	6	7b or 8
INTERNAL WALLS-				
Bounding <i>public corridors</i> , public lobbies and the like—	60 / 60/ 60	- / - / -	- / - / -	- / - / -
Between or bounding <i>sole-occupancy units</i> —	60/ 60/ 60	- / - / -	- / - / -	- / - / -
Bounding a stair if <i>required</i> to be rated—	60/ 60/ 60	60/ 60/ 60	60/ 60/ 60	60/ 60/ 60
ROOFS	- / - / -	- / - / -	- / - / -	- / - / -

5.2 Carparks

- (a) Notwithstanding **Clause 5.1**, a *carpark* may comply with **Table 5.2** if it is an *open-deck carpark* or is protected with a sprinkler system complying with **Specification E1.5** and is—
- (i) a separate building; or
 - (ii) a part of a building, and if occupying only part of a *storey*, is separated from the remaining part by a *fire wall*.
- (b) For the purposes of this clause, a *carpark*—
- (i) includes—
 - (A) an administration area associated with the functioning of the *carpark*; and
 - (B) where the *carpark* is sprinklered, is associated with a Class 2 or 3 building and provides carparking for separate *sole-occupancy units*, each carparking area with an area not greater than 10% of its *floor area* for purposes ancillary to the *sole-occupancy units*; but
 - (ii) excludes—
 - (A) except for **(b)(i)**, any area of another classification, or other part of a Class 7 building not used for carparking; and
 - (B) a building or part of a building specifically intended for the parking of trucks, buses, vans and the like.

Table 5.2 REQUIREMENTS FOR CARPARKS

Building element	FRL (not less than) <i>Structural adequacy/Integrity/Insulation</i> ESA/M (not greater than)
Wall	
(a) <i>external wall</i>	
(i) less than 1.5 m from a <i>fire-source feature</i> to which it is exposed:	
<i>Loadbearing</i>	60/60/60
<i>Non-loadbearing</i>	- /60/60
(ii) 1.5 m or more from a <i>fire-source feature</i> to which it is exposed	- / - / -
(b) <i>internal wall</i>	- / - / -
(c) <i>fire wall</i>	
(i) from the direction used as a <i>carpark</i>	60/60/60
(ii) from the direction not used as a <i>carpark</i>	90/90/90
Column	
(a) steel column less than 1.5 m from a <i>fire-source feature</i>	60/ - / - or 26 m ² /tonne
(b) any other column less than 1.5 m from a <i>fire-source feature</i>	60/ - / -
(c) any other column not covered by (a) or (b)	- / - / -
Beam	
(a) less than 1.5 m from a <i>fire-source feature</i>	
(i) steel floor beam in continuous contact with a concrete floor slab	60/ - / - or 30 m ² /tonne
(ii) any other beam	60/ - / -
(b) 1.5 m or more from a <i>fire-source feature</i>	- / - / -
Roof, floor slab and vehicle ramp	
	- / - / -
Note: ESA/M means the ratio of exposed surface area to mass per unit length.	

SPECIFICATION **C1.8** STRUCTURAL TESTS FOR LIGHTWEIGHT CONSTRUCTION

Deemed-to-Satisfy Provisions

1. Scope

This Specification describes tests to be applied to and criteria to be satisfied by a wall system of *lightweight construction*.

2. Application

A wall system need not be tested in accordance with this Specification for static pressure or impact if it is designed and constructed in accordance with the *Deemed-to-Satisfy Provisions* of **Section B** to resist the appropriate pressures and impacts defined in this Specification.

3. Tests

3.1 Walls of certain Class 9b buildings

Lightweight construction forming—

- (a) a wall of a lift *shaft* and stair *shaft*; and
- (b) an *external* and *internal wall* bounding a *public corridor*, public lobby or the like, including a *fire-isolated* and non *fire-isolated passageway* or *ramp*,
in a spectator stand, sports stadium, cinema or theatre, railway or bus station or airport terminal, must be subjected to the following tests and must fulfil the following criteria:
 - (i) The materials tests of **Clause 5(a)** and the criteria of **Clause 6(a)**.
 - (ii) A static test by the imposition of a uniformly distributed load of 1.0 kPa (or its equivalent) in accordance with **Clause 5(b)** and the damage and deflection criteria of **Clauses 6(b)** and **(c)** respectively.
 - (iii) A dynamic test by the fall of the impact bag through a height of 350 mm in accordance with **Clause 5(c)** and the damage and deflection criteria of **Clauses 6(b)** and **(d)** respectively.
 - (iv) The surface indentation test of **Clause 5(d)** and the surface indentation criterion of **Clause 6(e)**.

3.2 Walls of shafts and fire-isolated exits generally

A wall of *lightweight construction* that is *required* to be *fire-resisting* and which bounds a lift *shaft*, stair *shaft*, or service *shaft*, *fire-isolated passageway* or *fire-isolated ramp* must be subjected to the following tests and must fulfil the following criteria:

- (a) The materials tests of **Clause 5(a)** and the criteria of **Clause 6(a)**.
- (b) A static test by the imposition of a uniformly distributed load of 0.35 kPa (or its equivalent) in accordance with **Clause 5(b)** and the damage and deflection criteria of **Clauses 6(b)** and **(c)** respectively.

Deemed-to-Satisfy Provisions

- (c) A dynamic test by the fall of the impact bag through a height of 150 mm in accordance with **Clause 5(c)** and the damage and deflection criteria of **Clauses 6(b)** and **(d)** respectively.
- (d) The surface indentation test of **Clause 5(d)** and the surface indentation criterion of **Clause 6(e)**.

3.3 Additional requirements for lift shafts

- (a) In addition to the requirements of **Clauses 3.1** and **3.2**, a wall system for use in a lift *shaft* that is *required* to be *fire-resisting* must be subjected to dynamic test by the imposition of—
 - (i) where the lift car speed is 7 m/s or less — 10⁶ cycles of a uniformly distributed load between 0 and 0.2 kPa (or its equivalent); or
 - (ii) where the lift car speed is greater than 7 m/s — 10⁶ cycles of a uniformly distributed load between 0 and 0.35 kPa (or its equivalent) in accordance with **Clause 5(e)** and must fulfil the damage criteria of **Clause 6(b)**.
- (b) The wall system must be subjected to the static test in accordance with **Clause 3.2(b)** after the successful conclusion of the dynamic test specified in **(a)**.

3.4 Walls generally

An *external* and *internal wall* of *lightweight construction* that is *required* to be *fire-resisting*, other than one covered by **Clauses 3.1**, **3.2** or **3.3**, must be subjected to the following tests and must fulfil the following criteria:

- (a) The materials tests of **Clause 5(a)** and the criteria of **Clause 6(a)**.
- (b) A static test by the imposition of a uniformly distributed load of 0.25 kPa (or its equivalent) in accordance with **Clause 5(b)** and the damage and deflection criteria of **Clauses 6(b)** and **(c)** respectively.
- (c) A dynamic test by fall of the impact bag through a height of 100 mm in accordance with **Clause 5(c)** and the damage and deflection criteria of **Clauses 6(b)** and **(d)** respectively.
- (d) The surface indentation test of **Clause 5(d)** and the surface indentation criterion of **Clause 6(e)**.

4. Test specimens

4.1 General

Testing must be carried out on either—

- (a) construction in-situ; or
- (b) a laboratory specimen of the construction.

4.2 Testing in-situ

If testing is carried out in-situ, it must be done on that part of the construction least likely, because of the particular combination of the height of the walls, the support conditions and other aspects of the construction, to resist the loads.

Deemed-to-Satisfy Provisions

4.3 Testing of specimens

If a laboratory specimen is tested, the specimen must span only in the direction corresponding to the height of the wall and testing must be done in accordance with either (a) or (b) below:

- (a)
 - (i) The height of the test specimen (or length, if the specimen is tested horizontally) must be identical with the height between supports in the actual construction; and
 - (ii) the specimen must be supported at the top and bottom (or at each end if tested horizontally) by components identical with, and in a manner identical with, the actual construction.
- (b) If the distance between supports of the actual construction is more than 3 m, then a smaller specimen may be tested but—
 - (i) the distance between supports must be not less than 3 m; and
 - (ii) forces, reactions and support conditions must be modelled so as to reproduce the behaviour of the actual construction if it were tested in-situ.

5. Test methods

Tests must be carried out in accordance with the following:

- (a) **Material tests** — The methods specified for the constituent materials of the construction of the standards adopted by reference in the BCA.
- (b) **For resistance to static pressure** — The provisions for testing walls under transverse load in ASTM E72-80, except that—
 - (i) support conditions must be as specified in **Clause 4.3**; and
 - (ii) equivalent load shall mean the quarter-point load that produces the same deflection or central moment as appropriate.
- (c) **For resistance to impact** — The provisions for testing wall systems in ASTM E695-79, except that—
 - (i) the point of impact must be set 1.5 m above finished floor level or 1.5 m above the part of the specimen that corresponds to finished floor level; and
 - (ii) the impact bag must be not less than 225 mm in diameter and not more than 260 mm in diameter and have a mass of not less than 27.2 or more than 27.3 kg; and
 - (iii) the mass must be achieved by putting loose, dry sand into the bag and must be adjusted before each series of impact tests; and
 - (iv) where the impact bag and suspension cannot be vertical at the instant of impact on a curved surface or an inclined surface, the height of drop is the net height at the point of impact.
- (d) **For resistance to surface indentation** — The test for resistance to surface indentation must be carried out at three points on the surface of an undamaged sample sheet as follows:

Deemed-to-Satisfy Provisions

- (i) A steel ball of 10 mm diameter with a load of 150 N must be placed gently on the surface of the sheet and allowed to remain in position for 5 minutes.
- (ii) The ball and load must then be removed and the diameter of each impression of the ball on the surface measured.
- (e) **For resistance of lift shaft construction to repetitive load** — As for 5(b) except that—
 - (i) it is sufficient to test one specimen with the pressure applied from the side of the construction on which the lift will operate; and
 - (ii) the load must be applied dynamically at a frequency not less than 1 Hz and not more than 3 Hz; and
 - (iii) equivalent load shall mean the quarter-point load that produces the same central moment as the distributed load.

6. Criteria for compliance

The wall system or the specimen of it must fulfil the following criteria:

- (a) **Materials** — Materials must comply with the applicable standard adopted by reference in the BCA.
- (b) **Damage** — There must be no crack, penetration or permanent surface-deformation to a depth of more than 0.5 mm or any other non-elastic deformation or fastener failure.
- (c) **Deflection — Static pressure** — Under static pressure the deflection must not be more than—
 - (i) 1/240th of the height between supports; or
 - (ii) for construction other than a lift *shaft* — 30 mm; or
 - (iii) for a lift *shaft* — 20 mm unless the requirements of Clause 15.2(a) of AS 1735.2 or Clauses 5.2.1.1 and 5.2.1.2 of Appendix A of AS 1735.1 are fulfilled.
- (d) **Deflection — Impact** — Under impact the instantaneous deflection must not be more than—
 - (i) 1/120th of the height of the wall between supports; or
 - (ii) for construction other than a lift *shaft* — 30 mm; or
 - (iii) for a lift *shaft* — 20 mm unless the requirements of Clause 15.2(a) of AS 1735.2 are fulfilled.
- (e) **Surface indentation** — No impression must be more than 5 mm in diameter.

SPECIFICATION **C1.10** FIRE HAZARD PROPERTIES - GENERAL

Deemed-to-Satisfy Provisions

1. Scope

This Specification sets out requirements in relation to the *fire hazard properties* of materials and assemblies in Class 2 to 9 buildings other than—

- (a) floor materials and floor coverings; and
- (b) wall and ceiling linings.

2. Class 2 to 9 buildings: General requirements

Except where superseded by **Clause 3** or **4**, any material or assembly as specified in **Clause 1**, used in a Class 2 to 9 building must—

- (a) in the case of a *sarking-type material*, have a *Flammability Index* not more than 5; or
- (b) in the case of other materials, have—
 - (i) a *Spread-of-Flame Index* not more than 9; and
 - (ii) a *Smoke-Developed Index* not more than 8 if the *Spread-of-Flame Index* is more than 5; or
- (c) be completely covered on all faces by concrete or masonry not less than 50 mm thick; or
- (d) in the case of a composite member or assembly, be constructed so that when assembled as proposed in a building—
 - (i) any material which does not comply with **(a)** or **(b)** is protected on all sides and edges from exposure to the air; and
 - (ii) the member or assembly, when tested in accordance with **Specification A2.4**, has a *Smoke-Developed Index* and a *Spread-of-Flame Index* not exceeding those prescribed in **(b)**; and
 - (iii) the member or assembly retains the protection in position so that it prevents ignition of the material and continues to screen it from access to free air for a period of not less than 10 minutes.

3. Fire-isolated exits

In a *fire-isolated stairway*, *fire-isolated passageway* or *fire-isolated ramp* in a Class 2 to 9 building—

- (a) a material as specified in **Clause 1**, other than a *sarking-type material* used in a ceiling or used as an attachment or part of an attachment to a building element must have—
 - (i) *Spread-of-Flame Index* of 0; and
 - (ii) *Smoke-Developed Index* of not more than 2; and
 - (iii) if *combustible*, be attached directly to a *non-combustible* substrate and not exceed 1 mm finished thickness; and

Deemed-to-Satisfy Provisions

- (b) a *sarking-type material* used in the form of an exposed wall or ceiling must have a *Flammability Index* of 0.

4. Class 2, 3 and 9 buildings

A material as specified in **Clause 1**, other than a *sarking-type material* used as an attachment or part of an attachment to a building element must if—

- (a) in a Class 2, 3, 9a or 9b building, it is used as a finish, surface, lining or attachment to any wall or ceiling in a *public corridor* which is a means of egress to—
- (i) a *required fire-isolated stairway* or an external stairway used instead; or
 - (ii) a *required fire-isolated passageway*, or *required fire-isolated ramp*,
- have a *Spread-of-Flame Index* of 0 and a *Smoke-Developed Index* of not more than 5; or
- (b) in a Class 9a building in a *patient-care area*, it is used as a finish, surface, lining or attachment to a—
- (i) ceiling — have a *Spread-of-Flame Index* of 0 and a *Smoke-Developed Index* of not more than 3; and
 - (ii) wall — have a *Spread-of-Flame Index* of not more than 2 and a *Smoke-Developed Index* of not more than 5, except that skirtings of up to 150 mm above the floor may be considered as, and have the Early Fire Hazard Indices of, the floor covering; and
 - (iii) floor — have a—
 - (A) *Spread-of-Flame Index* of not more than 3 and a *Smoke-Developed Index* of not more than 5; or
 - (B) *Spread-of-Flame Index* of 0 and a *Smoke-Developed Index* of not more than 6; or
- (c) in a Class 9b building not protected by a sprinkler system used as a theatre or public hall, in the auditorium or audience seating area, it is used as a finish, surface, lining or attachment to a—
- (i) ceiling — have a *Spread-of-Flame Index* of not more than 6 and a *Smoke-Developed Index* of not more than 3; and
 - (ii) wall — have a *Spread-of-Flame Index* of not more than 6 and a *Smoke-Developed Index* of not more than 5; and
 - (iii) floor — have a *Spread-of-Flame Index* of not more than 7 and a *Smoke-Developed Index* of not more than 5, except where the auditorium is used mainly for—
 - (A) indoor swimming or ice skating — have a *Spread-of-Flame Index* of not more than 9 and a *Smoke-Developed Index* of not more than 8; or
 - (B) other indoor sports or multi-purpose functions — have a *Spread-of-Flame Index* of not more than 8 and a *Smoke-Developed Index* of not more than 7; or

NSW Spec C1.10 4(d) and (e)

- (d) in a Class 9b building used as a theatre or public hall, it is used in any part of fixed seating in the audience area or auditorium have a *Spread-of-Flame Index* of 0 and a *Smoke-Developed Index* of not more than 5.

Deemed-to-Satisfy Provisions

5. * * * * *

This clause has deliberately been left blank.

6. * * * * *

This clause has deliberately been left blank.

7. * * * * *

This clause has deliberately been left blank.

8. Air-handling ductwork

Rigid and flexible ductwork in a Class 2 to 9 building must comply with the fire hazard properties set out in AS 4254.

9. Lift cars

The materials as specified in **Clause 1** used in the construction of a lift car in a Class 2 to 9 building must comply with the fire hazard properties *required* by AS 1735.2.

SPECIFICATION C1.10a FIRE HAZARD PROPERTIES - FLOORS, WALLS AND CEILINGS

Deemed-to-Satisfy Provisions

1. Scope

This Specification sets out requirements in relation to the *fire hazard properties* of—

- (a) floor materials and floor coverings; and
- (b) wall and ceiling linings.

2. Floor materials and floor coverings

A floor material or floor covering must have—

- (a) a *critical radiant flux* not less than that listed in **Table 1**; and
- (b) in a building not protected by a sprinkler system complying with **Specification E1.5**, a maximum *smoke development rate* of 750 percent-minutes.

Table 1 CRITICAL RADIANT FLUX (CRF in kW/M²) OF FLOOR MATERIALS AND FLOOR COVERINGS

Class of building	General		Fire-Isolated Exits
	Building not fitted with a sprinkler system complying with Specification E1.5	Building fitted with a sprinkler system complying with Specification E1.5	
Class 2, 3, 5, 6, 7, 8 or 9b Excluding accommodation for the aged	2.2	1.2	2.2
Class 3 Accommodation for the aged	4.5	2.2	4.5
Class 9a <i>Patient care areas</i>	4.5	2.2	4.5
Areas other than <i>patient care areas</i>	2.2	1.2	4.5
Class 9c <i>Resident use areas</i>	-	2.2	4.5
Areas other than <i>resident use areas</i>	-	1.2	4.5

Deemed-to-Satisfy Provisions

3. Walls and ceilings

- (a) For the purposes of this Clause, the *group number* of a material is determined by either—
- (i) physical testing in accordance with AS ISO 9705; or
 - (ii) prediction in accordance with **Clause 3 of Specification A2.4** using data obtained by testing the material at 50 kW/m² irradiance in the horizontal orientation with edge frame in accordance with AS/NZS 3837.
- (b) The *group number* of a material is as follows when tested or predicted in accordance with sub-clause (a):
- (i) A Group 1 material is one that does not reach flashover when exposed to 100 kW for 600 seconds followed by exposure to 300 kW for 600 seconds.
 - (ii) A Group 2 material is one that reaches flashover following exposure to 300 kW within 600 seconds after not reaching flashover when exposed to 100 kW for 600 seconds.
 - (iii) A Group 3 material is one that reaches flashover in more than 120 seconds but within 600 seconds when exposed to 100 kW.
 - (iv) A Group 4 material is one that reaches flashover within 120 seconds when exposed to 100 kW.
- (c) A material used as a finish, surface, lining or attachment to a wall or ceiling must be a Group 1, Group 2 or Group 3 material used in accordance with **Table 2** and for buildings not fitted with a sprinkler system complying with **Specification E1.5**, have—
- (i) a *smoke growth rate index* not more than 100; or
 - (ii) an *average specific extinction area* less than 250m²/kg.

Table 2 WALL AND CEILING LINING MATERIALS (Material Groups Permitted)

Class of building	Fire-isolated exits	Public corridors		Specific areas		Other areas
	Wall/ceiling	Wall	Ceiling	Wall	Ceiling	Wall/ceiling
Class 2 or 3						
Excluding accommodation for the aged, people with disabilities, and children						
Unsprinklered	1	1, 2	1, 2	1, 2, 3	1, 2, 3	1, 2, 3
Sprinklered	1	1, 2, 3	1, 2, 3	1, 2, 3	1, 2, 3	1, 2, 3
Class 3 or 9a						
Accommodation for the aged, people with disabilities, children and <i>health-care buildings</i>						
Unsprinklered	1	1	1	1, 2	1, 2	1, 2, 3
Sprinklered	1	1, 2	1, 2	1, 2, 3	1, 2, 3	1, 2, 3
Class 5, 6, 7, 8 or 9b schools						
Unsprinklered	1	1, 2	1, 2	1, 2, 3	1, 2	1, 2, 3
Sprinklered	1	1, 2, 3	1, 2, 3	1, 2, 3	1, 2, 3	1, 2, 3

Deemed-to-Satisfy Provisions

Table 2 WALL AND CEILING LINING MATERIALS (Material Groups Permitted)— continued

Class of building	Fire-isolated exits	Public corridors		Specific areas		Other areas
	Wall/ceiling	Wall	Ceiling	Wall	Ceiling	Wall/ceiling
Class 9b other than schools						
Unsprinklered	1	1	1	1, 2	1, 2	1, 2, 3
Sprinklered	1	1, 2	1, 2	1, 2, 3	1, 2, 3	1, 2, 3
Class 9c						
Sprinklered	1	1, 2	1, 2	1, 2, 3	1, 2, 3	1, 2, 3

For the purpose of this Table:

1. "Sprinklered" means a building fitted with a sprinkler system complying with [Specification E1.5](#).
2. "Specific areas" means within:
 - (a) for Class 2 and 3 buildings, a [sole-occupancy unit](#).
 - (b) for Class 5 buildings, open plan offices with a minimum floor dimension/floor to ceiling height ratio > 5.
 - (c) for Class 6 buildings, shops or other building with a minimum floor dimension/floor to ceiling height ratio > 5.
 - (d) for Class 9a [health-care buildings](#), [patient care areas](#).
 - (e) for Class 9b theatres and halls, etc, an auditorium.
 - (f) for Class 9b schools, a classroom.
 - (g) for Class 9c [aged care buildings](#), [resident use areas](#).

4. Lift cars

In a lift car, the [fire hazard properties](#) of materials used as—

- (a) floor materials and floor coverings must have critical radiant flux not less than 2.2; and
- (b) wall and ceiling linings must be a Group 1 material or a Group 2 material in accordance with [Clause 3\(b\)](#).

SPECIFICATION C1.11 PERFORMANCE OF EXTERNAL WALLS IN FIRE

Deemed-to-Satisfy Provisions

1. Scope

This Specification contains measures to minimise, in the event of fire, the likelihood of *external walls* covered by **Clause 2** collapsing outwards as complete panels and the likelihood of panels separating from supporting members.

2. Application

This Specification applies to buildings having a *rise in storeys* of not more than 2 with concrete *external walls* that could collapse as complete panels (eg. tilt-up and precast concrete) which—

- (a) consist of either single or multiple panels attached by steel connections to lateral supporting members; and
- (b) depend on those connections to resist outward movement of the panels relative to the supporting members; and
- (c) have height to thickness ratio not greater than 50.

3. General requirements for external wall panels

- (a) Cast-in inserts and fixings must be anchored into the panel with welded bars or be fixed to the panel reinforcement.
- (b) Cast-in inserts for top connections and fixings acting together must be able to resist an ultimate load of two times the larger of the forces *required* to develop—
 - (i) the ultimate bending moment capacity of the panel at its base; or
 - (ii) the overturning moment at the base of the panel arising from an outwards lateral displacement at the top of the panel equal to one tenth of the panel height.
- (c) Top connections of the panel exposed to fire, such as clips and drilled-in inserts, acting together must be able to resist an ultimate load of six times the larger of the forces *required* to develop the moment specified in **(b)(i)** or **(ii)**.

Note.

The increased forces specified by use of the multiplier of two or six in **(b)** and **(c)** above are to take account of the lower strength of the connections and members at the higher than ambient temperatures expected in a fire.

- (d) Lateral supporting members and their connections must be designed to resist the connection forces specified in **(b)** and **(c)** and in the case of an eaves tie member the force in the member must be determined assuming that it deforms in a manner compatible with the lateral displacement of the wall panels, and that it acts in tension only.
- (e) *External wall* panels that span vertically must have at least two upper connections per panel to the supporting member, except that where a number of panels are designed to

Deemed-to-Satisfy Provisions

act as one unit, (eg. tongue and groove hollow-core panels), only two upper connections are *required* for each unit.

- (f) *External wall* panels that span horizontally between columns must have at least two connections at each column.

4. Additional requirements for vertically spanning external wall panels adjacent to columns

- (a) Where vertically spanning *external wall* panels are located adjacent to columns, connections to the panels must be located and/or detailed to minimise forces that may develop between the panels and columns arising from the restraint of differential displacement.
- (b) The requirements of (a) are satisfied by—
- (i) detailing the connections and/or the supporting member to sustain a relative outward displacement of (d) between the panels and columns at the connection height where d(m) is calculated as—
 - (A) the square of the connection height (m) divided by one hundred and twenty-five, when the connection height is less than 5 m; or
 - (B) the connection height (m) divided by twenty-five, when the connection height (m) is greater than or equal to 5 m; or
 - (ii) in situations where an eaves tie member is used to provide lateral support to *external wall* panels, the tie member is connected to the panels no closer than a distance (s) from the column where s(m) is taken as one quarter of the panel height (m).

SPECIFICATION **C2.5** SMOKE-PROOF WALLS IN
HEALTH-CARE AND AGED CARE
BUILDINGS

Deemed-to-Satisfy Provisions

1. SCOPE

This Specification sets out requirements for the construction of smoke-proof walls in Class 9a *health-care buildings* and Class 9c *aged care buildings*. Smoke proof walls required to have an FRL are to be in accordance with **Clause A2.3**.

2. Class 9a health-care buildings

Smoke-proof walls *required* by **C2.5** in Class 9a *health-care buildings* must comply with the following:

- (a) Be *non-combustible* and extend to the underside of—
 - (i) the floor above; or
 - (ii) a *non-combustible* roof covering; or
 - (iii) a ceiling having a *resistance to the incipient spread of fire* to the space above itself of not less than 60 minutes.
- (b) Not incorporate any glazed areas unless the glass is safety glass as defined in AS 1288.
- (c) Only have doorways which are fitted with smoke doors complying with **Specification C3.4**.
- (d) Have all openings around penetrations and the junctions of the smoke-proof wall and the remainder of the building stopped with *non-combustible* material to prevent the free passage of smoke.
- (e) Incorporate smoke dampers where air-handling ducts penetrate the wall unless the duct forms part of a smoke hazard management system *required* to continue air movement through the duct during a fire.

3. Class 9c aged care buildings

Smoke-proof walls *required* by **C2.5** in Class 9c *aged care buildings* must comply with the following:

- (a) The wall may be lined on one side only.
- (b) Linings on the wall must be *non-combustible* and extend to the underside of—
 - (i) the floor above; or
 - (ii) a *non-combustible* roof covering; or
 - (iii) a flush plasterboard ceiling lined with 13 mm standard grade plasterboard or a *fire protective covering* with all penetrations sealed against the free passage of smoke.
- (c) If plasterboard is used in the lining on a wall, it must be a minimum of 13 mm standard grade plasterboard.

Deemed-to-Satisfy Provisions

- (d) Not incorporate any glazed areas unless the glass is safety glass as defined in AS 1288.
- (e) Only have doorways which are fitted with smoke doors complying with **Specification C3.4**.
- (f) Have all openings around penetrations and the junctions of the smoke-proof wall and the remainder of the building stopped with *non-combustible* material to prevent the free passage of smoke.
- (g) Incorporate smoke dampers where air-handling ducts penetrate the wall unless the duct forms part of a smoke hazard management system *required* to continue air movement through the duct during a fire.

4. Doorways in smoke-proof walls

A door *required* by **C2.5** or this Specification to be smoke-proof or have an FRL, other than one that serves a *fire compartment* provided with a zone smoke control system in accordance with AS/NZS 1668.1, must provide a smoke reservoir by not extending within 400 mm of the underside of—

- (a) a roof covering; or
- (b) the floor above; or
- (c) an imperforate false ceiling that will prevent the free passage of smoke.

SPECIFICATION **C3.4** FIRE DOORS, SMOKE DOORS, FIRE WINDOWS AND SHUTTERS

Deemed-to-Satisfy Provisions

1. SCOPE

This Specification sets out requirements for the construction of fire doors, smoke doors, fire *windows* and fire shutters.

2. FIRE DOORS

A *required* fire door must—

- (a) comply with AS 1905.1; and
- (b) not fail by radiation through any glazed part during the period specified for *integrity* in the *required* FRL.

3. SMOKE DOORS

3.1 General requirements

Smoke doors must be constructed so that smoke will not pass from one side of the doorway to the other and, if they are glazed, there is minimal danger of a person being injured by accidentally walking into them.

3.2 Construction deemed-to-satisfy

A smoke door of one or two leaves satisfies **Clause 3.1** if it is constructed as follows:

- (a) The leaves are side-hung to swing—
 - (i) in the direction of egress; or
 - (ii) in both directions.
- (b)
 - (i) The leaves are capable of resisting smoke at 200°C for 30 minutes.
 - (ii) Solid-core leaves at least 35 mm thick satisfy **(i)**.
- (c) The leaves are fitted with smoke seals.
- (d)
 - (i) The leaves are normally in the closed position; or
 - (ii)
 - (A) The leaves are closed *automatically* with the *automatic* closing operation initiated by smoke detectors, installed in accordance with the relevant provisions of AS 1670.1, located on each side of the doorway not more than 1.5 m horizontal distance from the doorway; and

Deemed-to-Satisfy Provisions

- (B) in the event of power failure to the door, the leaves fail-safe in the closed position.
- (e) The leaves return to the fully closed position after each manual opening.
- (f) Any glazing incorporated in the door complies with AS 1288.
- (g)
 - (i) If a glazed panel is capable of being mistaken for an unobstructed *exit*, the presence of the glass must be identified by opaque construction.
 - (ii) An opaque mid-height band, mid-rail or crash bar satisfies (i).

4. FIRE SHUTTERS

A *required* fire shutter must—

- (a) be a shutter that—
 - (i) is identical with a tested prototype that has achieved the *required* FRL; and
 - (ii) is installed in the same manner and in an opening that is not larger than the tested prototype; and
 - (iii) did not have a rise in average temperature on the side remote from the furnace of more than 140 K during the first 30 minutes of the test; or
- (b) be a steel shutter complying with AS 1905.2 if a metallic fire shutter is not prohibited by **C3.5**.

5. FIRE WINDOWS

A *required* fire *window* must be—

- (a) identical in construction with a prototype that has achieved the *required* FRL; and
- (b) installed in the same manner and in an opening that is not larger than the tested prototype.

SPECIFICATION **C3.15** PENETRATION OF WALLS, FLOORS AND CEILINGS BY SERVICES

Deemed-to-Satisfy Provisions

1. Scope

This Specification prescribes materials and methods of installation for services that penetrate walls, floors and ceilings *required* to have an FRL.

2. Application

- (a) This Specification applies to installations permitted under the *Deemed-to-Satisfy Provisions* of the BCA as alternatives to systems that have been demonstrated by test to fulfil the requirements of **C3.15(a)**.
- (b) This Specification does not apply to installations in ceilings *required* to have a *resistance to the incipient spread of fire* nor to the installation of piping that contains or is intended to contain a flammable liquid or gas.

3. Metal pipe systems

- (a) A pipe system comprised entirely of metal (excluding pipe seals or the like) that is not normally filled with liquid must not be located within 100 mm, for a distance of 2 m from the penetration, of any *combustible* building element or a position where *combustible* material may be located, and must be constructed of—
 - (i) copper alloy or stainless steel with a wall thickness of at least 1 mm; or
 - (ii) cast iron or steel (other than stainless steel) with a wall thickness of at least 2 mm.
- (b) An opening for a pipe system comprised entirely of metal (excluding pipe seals or the like) must—
 - (i) be neatly formed, cut or drilled; and
 - (ii) be no closer than 200 mm to any other service penetration; and
 - (iii) accommodate only one pipe.
- (c) A pipe system comprised entirely of metal (excluding pipe seals or the like) must be wrapped but must not be lagged or enclosed in thermal insulation over the length of its penetration of a wall, floor or ceiling unless the lagging or thermal insulation fulfils the requirements of **Clause 7**.
- (d) The gap between a metal pipe and the wall, floor or ceiling it penetrates must be fire-stopped in accordance with **Clause 7**.

4. Pipes penetrating sanitary compartments

If a pipe of metal or UPVC penetrates the floor of a *sanitary compartment* in accordance with **C3.15(c)(i)**—

- (a) the opening must be neatly formed and no larger than is necessary to accommodate the pipe or fitting; and

Deemed-to-Satisfy Provisions

- (b) the gap between pipe and floor must be fire-stopped in accordance with **Clause 7**.

5. Wires and cables

If a wire or cable or cluster of wires or cables penetrates a floor, wall or ceiling—

- (a) the opening must be neatly formed, cut or drilled and no closer than 50 mm to any other service; and
- (b) the opening must be no larger in cross-sectional area than—
- (i) 2000 mm² if only a single cable is accommodated and the gap between cable and wall, floor or ceiling is no wider than 15 mm; or
 - (ii) 500 mm² in any other case; and
- (c) the gap between the service and the wall, floor or ceiling must be fire-stopped in accordance with **Clause 7**.

6. Electrical switches and outlets

If an electrical switch, outlet, socket or the like is accommodated in an opening or recess in a wall, floor or ceiling—

- (a) the opening or recess must not—
- (i) be located opposite any point within 300 mm horizontally or 600 mm vertically of any opening or recess on the opposite side of the wall; or
 - (ii) extend beyond half the thickness of the wall; and
- (b) the gap between the service and the wall, floor or ceiling must be fire-stopped in accordance with **Clause 7**.

7. Fire-stopping

- (a) **Material:** The material used for the fire-stopping of service penetrations must be concrete, high-temperature mineral fibre, high-temperature ceramic fibre or other material that does not flow at a temperature below 1120°C when tested in accordance with AS 1038.15, and must have—
- (i) demonstrated in a system tested in accordance with **C3.15(a)** that it does not impair the *fire-resisting* performance of the building element in which it is installed; or
 - (ii) demonstrated in a test in accordance with **(e)** that it does not impair the *fire-resisting* performance of the test slab.
- (b) **Installation:** Fire-stopping material must be packed into the gap between the service and wall, floor or ceiling in a manner, and compressed to the same degree, as adopted for testing under **Clause 7(a)(i)** or **(ii)**.
- (c) **Hollow construction:** If a pipe penetrates a hollow wall (such as a stud wall, a cavity wall or a wall of hollow blockwork) or a hollow floor/ceiling system, the cavity must be so framed and packed with fire-stopping material that is—
- (i) installed in accordance with **Clause 7(b)** to a thickness of 25 mm all round the service for the full length of the penetration; and

Deemed-to-Satisfy Provisions

- (ii) restrained, independently of the service, from moving or parting from the surfaces of the service and of the wall, floor or ceiling.
- (d) **Recesses:** If an electrical switch, socket, outlet or the like is accommodated in a recess in a hollow wall or hollow floor/ ceiling system—
 - (i) the cavity immediately behind the service must be framed and packed with fire-stopping material in accordance with **Clause 7(c)**; or
 - (ii) the back and sides of the service must be protected with refractory lining board identical with and to the same thickness as that in which the service is installed.
- (e) **Test:** The test to demonstrate compliance of a fire-stopping material with this Specification must be conducted as follows:
 - (i) The test specimen must comprise a concrete slab not less than 1 m square and not more than 100 mm thick, and appropriately reinforced if necessary for *structural adequacy* during manufacture, transport and testing.
 - (ii) The slab must have a hole 50 mm in diameter through the centre and the hole must be packed with the fire-stopping material.
 - (iii) The slab must be conditioned in accordance with AS 1530.4.
 - (iv) Two thermocouples complying with AS 1530.4 must be attached to the upper surface of the packing each about 5 mm from its centre.
 - (v) The slab must be tested on flat generally in accordance with Section 10 of AS 1530.4 and must achieve an FRL of 60/60/60 or as otherwise *required*.

SECTION **D**

ACCESS AND EGRESS

- D1 Provision for Escape**
- D2 Construction of Exits**
- D3 Access for People with Disabilities**

SECTION D CONTENTS

SECTION D ACCESS AND EGRESS

Section D Access and Egress

Objective DO1
Functional Statements DF1 - DF2
Performance Requirements DP1 - DP9
Verification Method DV1

Part D1 Provision for Escape

D1.0 Deemed-to-Satisfy Provisions
D1.1 Application of Part
D1.2 Number of exits required
D1.3 When fire-isolated stairways and ramps are required
D1.4 Exit travel distances
D1.5 Distance between alternative exits
D1.6 Dimensions of exits and paths of travel to exits
D1.7 Travel via fire-isolated exits
D1.8 External stairways or ramps in lieu of fire-isolated exits
D1.9 Travel by non-fire-isolated stairways or ramps
D1.10 Discharge from exits
D1.11 Horizontal exits
D1.12 Non-required stairways, ramps or escalators
D1.13 Number of persons accommodated
D1.14 Measurement of distances
D1.15 Method of measurement
D1.16 Plant rooms and lift machine rooms: Concession
D1.17 Access to lift pits

Part D2 Construction of Exits

D2.0 Deemed-to-Satisfy Provisions
D2.1 Application of Part
D2.2 Fire-isolated stairways and ramps
D2.3 Non-fire-isolated stairways and ramps
D2.4 Separation of rising and descending stair flights
D2.5 Open access ramps and balconies
D2.6 Smoke lobbies
D2.7 Installations in exits and paths of travel
D2.8 Enclosure of space under stairs and ramps
D2.9 Width of stairways
D2.10 Pedestrian ramps
D2.11 Fire-isolated passageways
D2.12 Roof as open space
D2.13 Goings and risers
D2.14 Landings
D2.15 Thresholds

- D2.16 Balustrades or other barriers
- D2.17 Handrails
- D2.18 Fixed platforms, walkways, stairways and ladders
- D2.19 Doorways and doors
- D2.20 Swinging doors
- D2.21 Operation of latch
- D2.22 Re-entry from fire-isolated exits
- D2.23 Signs on doors

Part D3 Access for People with Disabilities

- D3.0 Deemed-to-Satisfy Provisions
- D3.1 Application of Part
- D3.2 General building access requirements
- D3.3 Parts of buildings to be accessible
- D3.4 Concessions
- D3.5 Carparking
- D3.6 Identification of accessible facilities, services and features
- D3.7 Hearing augmentation
- D3.8 Tactile indicators

Specifications

- Specification D1.12 Non-Required Stairways, Ramps and Escalators
- Specification D3.6 Braille and Tactile Signs

ACT Appendix (Additional provisions and variations — refer to ACT Contents for full details)

NSW Appendix (Additional provisions and variations — refer to NSW Contents for full details)

SA Appendix (Additional provisions and variations — refer to SA Contents for full details)

Vic Appendix (Additional provisions and variations — refer to Vic Contents for full details)

SECTION D ACCESS AND EGRESS

OBJECTIVE

DO1

The *Objective* of this Section is to—

- (a) provide, as far as is reasonable, people with safe, equitable and dignified access to—
 - (i) a building; and
 - (ii) the services and facilities within a building; and
- (b) safeguard occupants from illness or injury while evacuating in an emergency.

FUNCTIONAL STATEMENTS

DF1

A building is to provide, as far as is reasonable—

- (a) safe; and
- (b) equitable and dignified,

access for people to the services and facilities within.

Application:

DF1(b), with respect to people with disabilities, only requires special provisions in—

- (a) a Class 3, 5, 6, 8 or 9 building; or
- (b) a Class 7 building other than a Class 7 *carpark* associated with a Class 2 building; or
- (c) a Class 10a building other than a Class 10a building associated with a Class 1 or 2 building or Class 4 part of a building.

DF2

A building is to be provided with means of evacuation which allow occupants time to evacuate safely without being overcome by the effects of an emergency.

Limitation:

DF2 does not apply to the internal parts of a *sole-occupancy unit* in a Class 2 or 3 building or Class 4 part of a building.

PERFORMANCE REQUIREMENTS

DP1

Access must be provided, to the degree necessary, to enable—

- (a) safe; and
- (b) equitable and dignified, movement of people to and within a building.

SA Application to DP1

Application:

DP1(b), with respect to people with disabilities, only requires special provisions in—

- (a) a Class 3, 5, 6, 8 or 9 building; or
- (b) a Class 7 building other than a Class 7 *carpark* associated with a Class 2 building; or
- (c) a Class 10a building other than a Class 10a building associated with a Class 1 or 2 building or Class 4 part of a building.

DP2

So that people can move safely to and within a building, it must have—

- (a) walking surfaces with safe gradients; and
- (b) any doors installed to avoid the risk of occupants—
 - (i) having their egress impeded; or
 - (ii) being trapped in the building; and
- (c) any stairways and ramps with—
 - (i) slip-resistant walking surfaces on—
 - (A) ramps; and
 - (B) stairway treads or near the edge of the nosing; and
 - (ii) suitable handrails where necessary to assist and provide stability to people using the stairway or ramp; and
 - (iii) suitable landings to avoid undue fatigue; and
 - (iv) landings where a door opens from or onto the stairway or ramp so that the door does not create an obstruction; and
 - (v) in the case of a stairway, suitable safe passage in relation to the nature, volume and frequency of likely usage.

DP3

Where people could fall—

- (a) 1 m or more—
 - (i) from a floor or roof or through an opening (other than through an openable *window*) in the *external wall* of a building; or

- (ii) due to a sudden change of level within or associated with a building; or
- (b) 4 m or more from a floor through an openable *window*,
a barrier must be provided which must be—
 - (c) continuous and extend for the full extent of the hazard; and
 - (d) of a height to protect people from accidentally falling from the floor or roof or through the opening; and
 - (e) constructed to prevent people from falling through the barrier; and
 - (f) capable of restricting the passage of children; and
 - (g) of strength and rigidity to withstand—
 - (i) the foreseeable impact of people; and
 - (ii) where appropriate, the static pressure of people pressing against it.

Limitations:

DP3 does not apply where such a barrier would be incompatible with the intended use of an area such as a stage, loading dock or the like.

DP3(f) does not apply to—

- (a) *fire-isolated stairways*, *fire-isolated ramps*, and other areas used primarily for emergency purposes, excluding external stairways and external ramps; and
- (b) Class 7 (other than *carparks*) and Class 8 buildings and parts of buildings containing those classes.

DP4

Exits must be provided from a building to allow occupants to evacuate safely, with their number, location and dimensions being appropriate to—

- (a) the travel distance; and
- (b) the number, mobility and other characteristics of occupants; and
- (c) the function or use of the building; and
- (d) the height of the building; and
- (e) whether the *exit* is from above or below ground level.

DP5

To protect evacuating occupants from a fire in the building *exits* must be fire-isolated, to the degree necessary, appropriate to—

- (a) the number of *storeys* connected by the *exits*; and
- (b) the *fire safety system* installed in the building; and
- (c) the function or use of the building; and
- (d) the number of *storeys* passed through by the *exits*; and
- (e) *fire brigade* intervention.

DP6

So that occupants can safely evacuate the building, paths of travel to exits must have dimensions appropriate to—

- (a) the number, mobility and other characteristics of occupants; and
- (b) the function or use of the building.

Limitation:

DP6 does not apply to the internal parts of a *sole-occupancy unit* in a Class 2 or 3 building or Class 4 part of a building.

With respect to people with disabilities, DP6 does not apply to—

- (a) a Class 2 building; or
- (b) a Class 7 *carpark* associated with a Class 2 building.

DP7

Accessways must be provided, as far as is reasonable, to and within a building which—

- (a) have features to enable people with disabilities to safely, equitably and with dignity—
 - (i) approach the building from the road boundary and from any carparking spaces associated with the building; and
 - (ii) access work and public spaces, accommodation and facilities for personal hygiene; and
- (b) are identified at appropriate locations and are easy to find; and
- (c) enable a person in a wheelchair to manoeuvre.

SA Application to DP7

Application:

DP7 only applies to—

- (a) a Class 3, 5, 6, 8 or 9 building; or
- (b) a Class 7 building other than a Class 7 *carpark* associated with a Class 2 building; or
- (c) a Class 10 building other than a Class 10 building associated with a Class 2 building or Class 4 part of a building.

DP8

Carparking spaces for use by people with disabilities must be—

- (a) provided, to the degree necessary, to give equitable access for carparking; and
- (b) designated and easy to find.

Limitation:

DP8 does not apply to a building where—

- (a) a parking service is provided; and

- (b) direct access to any carparking spaces by the general public or occupants is not available.

DP9

An inbuilt communication system for entry, information, entertainment, or for the provision of a service, must be suitable for occupants who are hearing impaired.

Limitation:

DP9 does not apply to—

- (a) a Class 2 building; or
- (b) a Class 4 part of a building; or
- (c) a Class 7 *carpark* associated with a Class 2 building; or
- (d) an inbuilt communication system used only for emergency warning purposes.

VERIFICATION METHOD

DV1

Compliance with **DP3(e)** and **(f)** for wire balustrades is verified when the wire balustrade passes the test described below:

(a) Application

The test must be carried out on either—

- (i) a prototype of a wire balustrade that is identical to that proposed to be installed on site; or
- (ii) a wire balustrade installed on site.

(b) Test equipment

The test equipment must consist of the following:

- (i) A horizontally suspended 125 mm diameter, 405 mm long cylinder of 1 mm thick steel having a highly polished 105 mm long cone at one end with a 20 mm diameter flat leading edge to which an eye bolt is fixed.
- (ii) A sufficiently flexible horizontal cable with mechanisms capable of applying and measuring a tension of 150 N (or a 15.3 kg weight suspended over a low friction pulley) is to be attached to the eye bolt (see **Figure DV1**).
- (iii) A mechanism capable of measuring the tension force applied to each balustrade wire.

Figure DV1

APPARATUS FOR TESTING WIRE BALUSTRADES

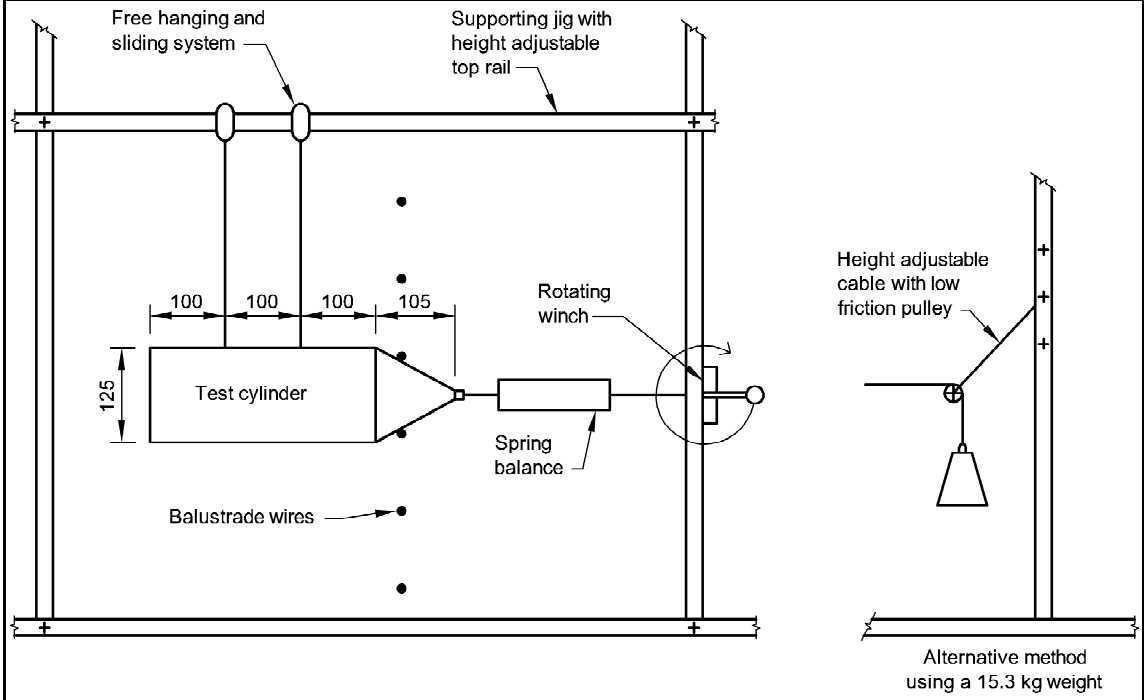

(c) Test procedure

The test procedure must be as follows:

- (i) Tension the wires, within their safe load, to the same tension in all wires and measure the tensions with a strain indicator.
- (ii) For—
 - (A) horizontal or near horizontal wires, position the cone against a pair of wires at the mid-span between supports, then apply the 150 N tension force to the cone; and
 - (B) vertical wires, position the cone against a pair of wires at the mid-span between supporting rails, then apply the 150 N tension force to the cone; and
 - (C) near-vertical wires, position the cone against a pair of wires at the widest opening between the wires, then apply the 150 N tension force to the cone.
- (iii) Attempt to pull the cone through the gap between the wires under the 150 N load, and—
 - (A) increase the tension in the wires and repeat (ii) until such time as the cone will not pull through; or
 - (B) if it does not pull through, reduce the tension in the wires and repeat step (ii); and
- (iv) When the cone is just prevented from pulling through the gap, the wires are at the correct tension in which case the cone is withdrawn and the tension recorded.

- (v) Reduce the tension in the wires and repeat steps (ii) to (iv) twice more, recording the tension in each case after the cone has been removed and then calculate the average of the three tensions as the *required* tension for each wire.
- (vi) For prototype tests of horizontal or near horizontal wires, record the deflection of each wire at the average tension calculated in accordance with (v) when a 2 kg mass is hung at mid-span between supports.

(d) **Test report**

The test report must include the following information:

- (i) The name and address of the person supervising the test.
- (ii) The test report number.
- (iii) The date of the test.
- (iv) The wire manufacturer's name and address, and specifications of the wires used in the test including the safe load limit of the wires.
- (v) The construction details of the test specimen, including a description and drawings and details of the components including supports, post or railing spacings and wire spacings.
- (vi) For a prototype test, the *required* tension calculated in accordance with (c)(v).
- (vii) For prototype tests of horizontal or near horizontal wires, the deflection measured in accordance with (c)(vi).

PART D1 PROVISION FOR ESCAPE

Deemed-to-Satisfy Provisions

D1.0 Deemed-to-Satisfy Provisions

- (a) Where a *Building Solution* is proposed to comply with the *Deemed-to-Satisfy Provisions*, *Performance Requirements DP1* to *DP9* are satisfied by complying with—
- (i) **D1.1** to **D1.16**, **D2.1** to **D2.23** and **D3.1** to **D3.8**; and
 - (ii) in a building containing an *atrium*, **Part G3**; and
 - (iii) for theatres, *stages* and public halls, **Part H1**.
- (b) Where a *Building Solution* is proposed as an *Alternative Solution* to the *Deemed-to-Satisfy Provisions* of—
- (i) **D1.1** to **D1.16**, **D2.1** to **D2.23** and **D3.1** to **D3.8**; and
 - (ii) in a building containing an *atrium*, **Part G3**; and
 - (iii) for theatres, *stages* and public halls, **Part H1**,
- the relevant *Performance Requirements* must be determined in accordance with **A0.10**.

D1.1 Application of Part

The *Deemed-to-Satisfy Provisions* of this Part do not apply to the internal parts of a *sole-occupancy unit* in a Class 2 or 3 building or a Class 4 part of a building.

D1.2 Number of exits required

- (a) **All buildings** — Every building must have at least one *exit* from each *storey*.
- (b) **Class 2 to 8 buildings** — In addition to any *horizontal exit*, not less than 2 *exits* must be provided from the following:
- (i) Each *storey* if the building has an *effective height* of more than 25 m.
 - (ii) A Class 2 or 3 building subject to **C1.5**.
- (c) **Basements** — In addition to any *horizontal exit*, not less than 2 *exits* must be provided from any *storey* if egress from that *storey* involves a vertical rise within the building of more than 1.5 m, unless—
- (i) the *floor area* of the *storey* is not more than 50 m²; and
 - (ii) the distance of travel from any point on the floor to a single *exit* is not more than 20 m.
- (d) **Class 9 buildings** — In addition to any *horizontal exit*, not less than 2 *exits* must be provided from the following:
- (i) Each *storey* if the building has a *rise in storeys* of more than 6 or an *effective height* of more than 25 m.
 - (ii) Any *storey* which includes a *patient care area* in a Class 9a *health-care building*.
 - (iii) Any *storey* that contains sleeping areas in a Class 9c *aged care building*.

Deemed-to-Satisfy Provisions

- (iv) Each *storey* in a Class 9b building used as an *early childhood centre*.
- (v) Each *storey* in a primary or secondary *school* with a *rise in storeys* of 2 or more.
- (vi) Any *storey* or *mezzanine* that accommodates more than 50 persons, calculated under **D1.13**.

NSW D1.2(d)(vii)

- (e) **Exits from Class 9c aged care buildings and patient care areas in Class 9a health-care buildings** — In a Class 9a *health-care building* and a Class 9c *aged care building*, at least one *exit* must be provided from every part of a *storey* which has been divided into *fire compartments* in accordance with **C2.2** or **C2.5**.
- (f) **Exits in open spectator stands** — In an *open spectator stand* containing more than one tier of seating, every tier must have not less than 2 stairways or ramps, each forming part of the path of travel to not less than 2 *exits*.
- (g) **Access to exits** — Without passing through another *sole-occupancy unit* every occupant of a *storey* or part of a *storey* must have access to—
 - (i) an *exit*; or
 - (ii) at least 2 *exits*, if 2 or more *exits* are *required*.

D1.3 When fire-isolated stairways and ramps are required

- (a) **Class 2 and 3 buildings** — Every stairway or ramp serving as a *required exit* must be fire-isolated unless it connects, passes through or passes by not more than—
 - (i) 3 consecutive *storeys* in a Class 2 building; or
 - (ii) 2 consecutive *storeys* in a Class 3 building,
 and one extra *storey* of any classification may be included if—
 - (iii) it is only for the accommodation of motor vehicles or for other ancillary purposes; or
 - (iv) the building has a sprinkler system complying with **Specification E1.5** installed throughout; or
 - (v) the *required exit* does not provide access to or egress for, and is separated from, the extra *storey* by construction having—
 - (A) an FRL of –/60/60, if non-*loadbearing*; and
 - (B) an FRL of 90/90/90, if *loadbearing*; and
 - (C) no opening that could permit the passage of fire or smoke.
- (b) **Class 5 to 9 buildings** — Every stairway or ramp serving as a *required exit* must be fire-isolated unless—
 - (i) in a Class 9a *health-care building* — it connects, or passes through or passes by not more than 2 consecutive *storeys* in areas other than *patient care areas*; or
 - (ii) it is part of an *open spectator stand*; or
 - (iii) in any other case except in a Class 9c *aged care building*, it connects, passes through or passes by not more than 2 consecutive *storeys* and one extra *storey* of any classification may be included if—
 - (A) the building has a sprinkler system complying with **Specification E1.5** installed throughout; or

Deemed-to-Satisfy Provisions

- (B) the *required exit* does not provide access to or egress for, and is separated from, the extra *storey* by construction having—
 - (aa) an FRL of –/60/60, if non-*loadbearing*; and
 - (bb) an FRL of 90/90/90 for Type A construction or 60/60/60 for Type B construction, if *loadbearing*; and
 - (cc) no opening that could permit the passage of fire or smoke.

D1.4 Exit travel distances

- (a) **Class 2 and 3 buildings—**
 - (i) The entrance doorway of any *sole-occupancy unit* must be not more than—
 - (A) 6 m from an *exit* or from a point from which travel in different directions to 2 *exits* is available; or
 - (B) 20 m from a single *exit* serving the *storey* at the level of egress to a road or *open space*; and
 - (ii) no point on the floor of a room which is not in a *sole-occupancy unit* must be more than 20 m from an *exit* or from a point at which travel in different directions to 2 *exits* is available.
- (b) **Class 4 parts —** The entrance doorway to any Class 4 part must be not more than 6 m from an *exit* or a point from which travel in different directions to 2 *exits* is available.
- (c) **Class 5 to 9 buildings —** Subject to **(d)**, **(e)** and **(f)**—
 - (i) no point on a floor must be more than 20 m from an *exit*, or a point from which travel in different directions to 2 *exits* is available, in which case the maximum distance to one of those *exits* must not exceed 40 m; and
 - (ii) in a Class 5 or 6 building, the distance to a single *exit* serving a *storey* at the level of access to a road or *open space* may be increased to 30 m.

Vic D1.4(d)

- (d) **Class 9a buildings —** In a *patient care area* in a Class 9a building—
 - (i) no point on the floor must be more than 12 m from a point from which travel in different directions to 2 of the *required exits* is available; and
 - (ii) the maximum distance to one of those *exits* must not be more than 30 m from the starting point.
- (e) **Open spectator stands —** The distance of travel to an *exit* in a Class 9b building used as an *open spectator stand* must be not more than 60 m.
- (f) **Assembly buildings —** In a Class 9b building other than a *school* or *early childhood centre*, the distance to one of the *exits* may be 60 m if—
 - (i) the path of travel from the room concerned to that *exit* is through another area which is a corridor, hallway, lobby, ramp or other circulation space; and
 - (ii) the room is smoke-separated from the circulation space by construction having an FRL of not less than 60/60/60 with every doorway in that construction protected by a tight fitting, *self-closing*, solid-core door not less than 35 mm thick; and
 - (iii) the maximum distance of travel does not exceed 40 m within the room and 20 m from the doorway to the room through the circulation space to the *exit*.

Deemed-to-Satisfy Provisions

D1.5 Distance between alternative exits

Exits that are *required* as alternative means of egress must be—

- (a) distributed as uniformly as practicable within or around the *storey* served and in positions where unobstructed access to at least 2 *exits* is readily available from all points on the floor including lift lobby areas; and
- (b) not less than 9 m apart; and
- (c) not more than—
 - (i) in a Class 2 or 3 building — 45 m apart; or
 - (ii) in a Class 9a *health-care building*, if such *required exit* serves a *patient care area* — 45 m apart; or
 - (iii) in all other cases — 60 m apart; and
- (d) located so that alternative paths of travel do not converge such that they become less than 6 m apart.

D1.6 Dimensions of exits and paths of travel to exits

In a *required exit* or path of travel to an *exit*—

- (a) the unobstructed height throughout must be not less than 2 m, except the unobstructed height of any doorway may be reduced to not less than 1980 mm; and
- (b) the unobstructed width of each *exit* or path of travel to an *exit*, except for doorways, must be not less than—
 - (i) 1 m; or
 - (ii) 1.8 m in a passageway, corridor or ramp normally used for the transportation of patients in beds within a *treatment area* or *ward area*; and
 - (iii) in a *public corridor* in a Class 9c *aged care building*, notwithstanding (c) and (d)—
 - (A) 1.5 m; and
 - (B) 1.8 m for the full width of the doorway, providing access into a *sole-occupancy unit* or communal bathroom; and
- (c) if the *storey* or *mezzanine* accommodates more than 100 persons but not more than 200 persons, the aggregate unobstructed width, except for doorways, must be not less than—
 - (i) 1 m plus 250 mm for each 25 persons (or part) in excess of 100; or
 - (ii) 1.8 m in a passageway, corridor or ramp normally used for the transportation of patients in beds within a *treatment area* or *ward area*; and
- (d) if the *storey* or *mezzanine* accommodates more than 200 persons, the aggregate unobstructed width, except for doorways, must be increased to—
 - (i) 2 m plus 500 mm for every 60 persons (or part) in excess of 200 persons if egress involves a change in floor level by a stairway or ramp with a gradient steeper than 1 in 12; or
 - (ii) in any other case, 2 m plus 500 mm for every 75 persons (or part) in excess of 200; and

Deemed-to-Satisfy Provisions

- (e) in an *open spectator stand* which accommodates more than 2000 persons, the aggregate unobstructed width, except for doorways, must be increased to 17 m plus a width (in metres) equal to the number in excess of 2000 divided by 600; and
- (f) the unobstructed width of a doorway must be not less than—
 - (i) in *patient care areas* through which patients would normally be transported in beds, if the doorway provides access to, or from, a corridor of width—
 - (A) less than 2.2 m — 1200 mm; or
 - (B) 2.2 m or greater — 1070 mm; and
 where the doorway is fitted with two leaves and one leaf is secured in the closed position in accordance with **D2.21(a)(v)**, the other leaf must permit an unobstructed opening not less than 800 mm wide; or
 - (ii) in *patient care areas* in a *horizontal exit* — 1250 mm; or
 - (iii) the unobstructed width of each *exit* provided to comply with **(b)**, **(c)**, **(d)** or **(e)**, minus 250 mm; or
 - (iv) in a Class 9c *aged care building*—

Vic D1.6(f)(iv)

- (A) 1070 mm where it opens from a *public corridor* to a *sole-occupancy unit*; or
- (B) 870 mm in other *resident use areas*; or
- (C) 800 mm in non-*resident use areas*,

and where the doorway is fitted with two leaves and one leaf is secured in the closed position in accordance with **D2.21(a)(v)**, the other leaf must permit an unobstructed opening not less than 870 mm wide in *resident use areas* and 800 mm wide in non-*resident use areas*; or

- (v) in any other case except where it opens to a *sanitary compartment* or bathroom — 750 mm wide; and
- (g) the unobstructed width of a *required exit* must not diminish in the direction of travel to a road or *open space*, except where the width is increased in accordance with **(b)(ii)** or **(f)(i)**.

NSW D1.6(f)(vi)

NSW D1.6(h)

D1.7 Travel via fire-isolated exits

- (a) A doorway from a room must not open directly into a stairway, passageway or ramp that is *required* to be fire-isolated unless it is from—
 - (i) a *public corridor*, public lobby or the like; or
 - (ii) a *sole-occupancy unit* occupying all of a *storey*; or
 - (iii) a *sanitary compartment*, airlock or the like.
- (b) Each *fire-isolated stairway* or *fire-isolated ramp* must provide independent egress from each *storey* served and discharge directly, or by way of its own *fire-isolated passageway*—
 - (i) to a road or *open space*; or

Deemed-to-Satisfy Provisions

- (ii) to a point—
 - (A) in a *storey* or space, within the confines of the building, that is used only for pedestrian movement, car parking or the like and is open for at least 2/3 of its perimeter; and
 - (B) from which an unimpeded path of travel, not further than 20 m, is available to a road or *open space*; or
- (iii) into a covered area that—
 - (A) adjoins a road or *open space*; and
 - (B) is open for at least 1/3 of its perimeter; and
 - (C) has an unobstructed clear height throughout, including the perimeter openings, of not less than 3 m; and
 - (D) provides an unimpeded path of travel from the point of discharge to the road or *open space* of not more than 6 m.
- (c) Where a path of travel from the point of discharge of a fire-isolated *exit* necessitates passing within 6 m of any part of an *external wall* of the same building, measured horizontally at right angles to the path of travel, that part of the wall must have—
 - (i) an FRL of not less than 60/60/60; and
 - (ii) any openings protected internally in accordance with **C3.4**,
for a distance of 3 m above or below, as appropriate, the level of the path of travel, or for the height of the wall, whichever is the lesser.
- (d) If more than 2 access doorways, not from a *sanitary compartment* or the like, open to a *required* fire-isolated *exit* in the same *storey*—
 - (i) a smoke lobby in accordance with **D2.6** must be provided; or
 - (ii) the *exit* must be pressurised in accordance with AS/NZS 1668.1.
- (e) A ramp must be provided at any change in level less than 600 mm in a *fire-isolated passageway* in a Class 9 building.

D1.8 External stairways or ramps in lieu of fire-isolated exits

- (a) An external stairway or ramp may serve as a *required exit* in lieu of a fire-isolated *exit* serving a *storey* below an *effective height* of 25 m, if the stairway or ramp is—
 - (i) *non-combustible* throughout; and
 - (ii) protected in accordance with **(c)** if it is within 6 m of, and exposed to any part of the *external wall* of the building it serves.
- (b) For the purposes of this clause—
 - (i) exposure under **(a)(ii)**, is measured in accordance with **Clause 2.1 of Specification C1.1**, as if the *exit* was a building element and the *external wall* of the building was a *fire-source feature* to the *exit*, except that the FRL *required* in **Clause 2.1(a)(i)** must not be less than 60/60/60; and
 - (ii) the plane formed at the construction edge or perimeter of an unenclosed building or part such as an *open-deck carpark*, *open spectator stand* or the like, is deemed to be an *external wall*; and

Deemed-to-Satisfy Provisions

- (iii) openings in an *external wall* and openings under (c) and (d), are determined in accordance with C3.1.
- (c) The protection referred to in (a)(ii), must adequately protect occupants using the *exit* from exposure to a fire within the building, in accordance with one of the following methods:
 - (i) The part of the *external wall* of the building to which the *exit* is exposed must have—
 - (A) an FRL of not less than 60/60/60; and
 - (B) no openings less than 3 m from the *exit* (except a doorway serving the *exit* protected by a -/60/30 fire door in accordance with C3.8(a)); and
 - (C) any opening 3 m or more but less than 6 m from the *exit*, protected in accordance with C3.4 and if wall wetting sprinklers are used, they are located internally.
 - (ii) The *exit* must be protected from—
 - (A) any part of the *external wall* of the building having an FRL of less than 60/60/60; and
 - (B) any openings in the *external wall*,
 by the construction of a wall, roof, floor or other shielding element as appropriate in accordance with (d).
- (d) The wall, roof, floor or other shielding element *required* by (c)(ii) must—
 - (i) have an FRL of not less than 60/60/60; and
 - (ii) have no openings less than 3 m from the *external wall* of the building (except a doorway serving the *exit* protected by a -/60/30 fire door in accordance with C3.8(a)); and
 - (iii) have any opening 3 m or more but less than 6 m from any part of the *external wall* of the building protected in accordance with C3.4 and if wall wetting sprinklers are used, they are located on the side exposed to the *external wall*.

D1.9 Travel by non-fire-isolated stairways or ramps

- (a) A non-*fire-isolated stairway* or non-*fire-isolated ramp* serving as a *required exit* must provide a continuous means of travel by its own *flights* and landings from every *storey* served to the level at which egress to a road or *open space* is provided.
- (b) In a Class 2, 3 or 4 building, the distance between the doorway of a room or *sole-occupancy unit* and the point of egress to a road or *open space* by way of a stairway or ramp that is not fire-isolated and is *required* to serve that room or *sole-occupancy unit* must not exceed—
 - (i) 30 m in a building of Type C construction; or
 - (ii) 60 m in all other cases.
- (c) In a Class 5 to 9 building, the distance from any point on a floor to a point of egress to a road or *open space* by way of a *required* non-*fire-isolated stairway* or non-*fire-isolated ramp* must not exceed 80 m.
- (d) In a Class 2, 3 or 9a building, a *required* non-*fire-isolated stairway* or non-*fire-isolated ramp* must discharge at a point not more than—

Deemed-to-Satisfy Provisions

- (i) 15 m from a doorway providing egress to a road or *open space* or from a *fire-isolated passageway* leading to a road or *open space*; or
 - (ii) 30 m from one of 2 such doorways or passageways if travel to each of them from the non-*fire-isolated stairway* or non-*fire-isolated ramp* is in opposite or approximately opposite directions.
- (e) In a Class 5 to 8 or 9b building, a *required* non-*fire-isolated stairway* or non-*fire-isolated ramp* must discharge at a point not more than—
- (i) 20 m from a doorway providing egress to a road or *open space* or from a *fire-isolated passageway* leading to a road or *open space*; or
 - (ii) 40 m from one of 2 such doorways or passageways if travel to each of them from the non-*fire-isolated stairway* or non-*fire-isolated ramp* is in opposite or approximately opposite directions.
- (f) In a Class 2 or 3 building, if 2 or more *exits* are *required* and are provided by means of internal non-*fire-isolated stairways* or non-*fire-isolated ramps*, each *exit* must—
- (i) provide separate egress to a road or *open space*; and
 - (ii) be suitably smoke-separated from each other at the level of discharge.

D1.10 Discharge from exits

- (a) An *exit* must not be blocked at the point of discharge and where necessary, suitable barriers must be provided to prevent vehicles from blocking the *exit*, or access to it.
- (b) If a *required exit* leads to an *open space*, the path of travel to the road must have an unobstructed width throughout of not less than—
- (i) the minimum width of the *required exit*; or
 - (ii) 1 m,
- whichever is the greater.
- (c) If an *exit* discharges to *open space* that is at a different level than the public road to which it is connected, the path of travel to the road must be by—
- (i) a ramp or other incline having a gradient not steeper than 1:8 at any part, or not steeper than 1:14 if *required* by the *Deemed-to-Satisfy Provisions* of **Part D3**; or
 - (ii) except if the *exit* is from a Class 9a building, a stairway complying with the *Deemed-to-Satisfy Provisions* of the BCA.
- (d) The discharge point of alternative *exits* must be located as far apart as practical.
- (e) In a Class 9b building which is an *open spectator stand* that accommodates more than 500 persons, a *required* stairway or *required* ramp must not discharge to the ground in front of the stand.

NSW D1.10(f)

- (f) In a Class 9b building containing an auditorium which accommodates more than 500 persons, not more than 2/3 of the *required* width of *exits* must be located in the main entrance foyer.

D1.11 Horizontal exits

- (a) *Horizontal exits* must not be counted as *required exits*—

Deemed-to-Satisfy Provisions

- (i) between *sole-occupancy units*; or
 - (ii) in a Class 9b building used as an *early childhood centre*, primary or secondary *school*.
- (b) In a Class 9a *health-care building* or Class 9c *aged care building*, *horizontal exits* may be counted as *required exits* if the path of travel from a *fire compartment* leads by one or more *horizontal exits* directly into another *fire compartment* which has at least one *required exit* which is not a *horizontal exit*.
- (c) In cases other than in (b), *horizontal exits* must not comprise more than half of the *required exits* from any part of a *storey* divided by a *fire wall*.
- (d) *Horizontal exits* must have a clear area on the side of the *fire wall* to which occupants are evacuating, to accommodate the total number of persons (calculated under D1.13) served by the *horizontal exit* of not less than—
- (i) 2.5 m² per patient/resident in a Class 9a *health-care building* or Class 9c *aged care building*; and
 - (ii) 0.5 m² per person in any other case.
- (e) Where a *fire compartment* is provided with only two *exits*, and one of those *exits* is a *horizontal exit*, the clear area *required* by (d) is to be of a size that accommodates all the occupants from the *fire compartment* being evacuated.
- (f) The clear area *required* by (d) must be connected to the *horizontal exit* by an unobstructed path that has at least the dimensions *required* for the *horizontal exit* and may include the area of the unobstructed path.

D1.12 Non-required stairways, ramps or escalators

An escalator, moving walkway or non-*required* non *fire-isolated stairway* or pedestrian ramp—

- (a) must not be used between *storeys* in—
 - (i) a *patient care area* in a Class 9a *health-care building*; or
 - (ii) a *resident use area* in a Class 9c *aged care building*; and
- (b) may connect any number of *storeys* if it is—
 - (i) in an *open spectator stand* or indoor sports stadium; or
 - (ii) in a *carpark* or an *atrium*; or
 - (iii) outside a building; or
 - (iv) in a Class 5 or 6 building that is sprinklered throughout, where the escalator, walkway, stairway or ramp complies with **Specification D1.12**; and
- (c) except where permitted in (b) must not connect more than—
 - (i) 3 *storeys* if each of those *storeys* is provided with a sprinkler system complying with **Specification E1.5** throughout; or
 - (ii) 2 *storeys*,

provided that in each case, those *storeys* must be consecutive, and one of those *storeys* is situated at a level at which there is direct egress to a road or *open space*; and

Deemed-to-Satisfy Provisions

- (d) except where permitted in (b) or (c), must not connect, directly or indirectly, more than 2 storeys at any level in a Class 5, 6, 7, 8 or 9 building and those storeys must be consecutive.

D1.13 Number of persons accommodated

The number of persons accommodated in a storey, room or mezzanine must be determined with consideration to the purpose for which it is used and the layout of the floor area by—

- (a) calculating the sum of the numbers obtained by dividing the floor area of each part of the storey by the number of square metres per person listed in Table D1.13 according to the use of that part, excluding spaces set aside for—
- (i) lifts, stairways, ramps and escalators, corridors, hallways, lobbies and the like; and
 - (ii) service ducts and the like, sanitary compartments or other ancillary uses; or
- (b) reference to the seating capacity in an assembly building or room; or
- (c) any other suitable means of assessing its capacity.

NSW Table D1.13

Table D1.13 AREA PER PERSON ACCORDING TO USE

Type of use	m ² per person
Art gallery, exhibition area, museum	4
Bar	0.5
—bar standing	0.5
—other	1
Board room	2
Boarding house	15
Cafe, church, dining room	1
<i>Carpark</i>	30
Computer room	25
Court room	10
—judicial area	10
—public seating	1
Dance floor	0.5
Dormitory	5
<i>Early childhood centre</i>	4
Factory—	
(a) machine shop, fitting shop or like place for cutting, for cutting, grading, finishing or fitting of metals or glass, except in the fabrication of structural steelwork or manufacture of vehicles or bulky products	5
(b) areas used for fabrication and processing other than those in (a)	50

Deemed-to-Satisfy Provisions

Table D1.13 AREA PER PERSON ACCORDING TO USE—continued

Type of use	m ² per person
(c) a space in which the layout and natural use of fixed plant or equipment determines the number of persons who will occupy the space during working hours	Area per person determined by the use of the plant or equipment
Gymnasium	3
Hostel, hotel, motel, guest house	15
Indoor sports stadium—arena	10
Kiosk	1
Kitchen, laboratory, laundry	10
Library	—reading space —storage space
	2 30
Office, including one for typewriting or document copying	10
<i>Patient care areas</i>	10
Plant room	—ventilation, electrical or other service units —boilers or power plant
	30 50
Reading room	2
Restaurant	1
<i>School</i>	—general classroom —multi-purpose hall —staff room —trade and practical area —primary —secondary
	2 1 10 4 As for workshop
Shop	—space for sale of goods— (a) at a level entered direct from the open air or any lower level (b) all other levels
	3 5
Showroom	—display area, covered mall or arcade
	5
Skating rink, based on rink area	1.5
Spectator stand, audience viewing area:	—standing viewing area —removable seating —fixed seating (number of seats) —bench seating (450 mm/person)
	0.3 1

Deemed-to-Satisfy Provisions

Table D1.13 AREA PER PERSON ACCORDING TO USE— continued

Type of use	m ² per person
Storage space	30
<i>Swimming pool</i> , based on pool area	1.5
Switch room, transformer room	30
Telephone exchange	30
—private	
Theatre and public hall	1
Theatre dressing room	4
Transport terminal	2
Workshop	
—for maintenance staff	30
—for manufacturing processes	As for Factory
Notes to table:	
Bar standing is the area used by standing patrons and extends not less than 1.5m wide from the outside edge of the bar top for the length of the serving area of the bar.	

D1.14 Measurement of distances

The nearest part of an *exit* means in the case of—

- (a) a *fire-isolated stairway*, *fire-isolated passageway*, or *fire-isolated ramp*, the nearest part of the doorway providing access to them; and
- (b) a non-*fire-isolated stairway*, the nearest part of the nearest riser; and
- (c) a non-*fire-isolated ramp*, the nearest part of the junction of the floor of the ramp and the floor of the *storey*; and
- (d) a doorway opening to a road or *open space*, the nearest part of the doorway; and
- (e) a *horizontal exit*, the nearest part of the doorway.

D1.15 Method of measurement

The following rules apply:

- (a) In the case of a room that is not a *sole-occupancy unit* in a Class 2 or 3 building or Class 4 part, the distance includes the straight-line measurement from any point on the floor of the room to the nearest part of a doorway leading from it, together with the distance from that part of the doorway to the single *required exit* or point from which travel in different directions to 2 *required exits* is available.
- (b) Subject to (d), the distance from the doorway of a *sole-occupancy unit* in a Class 2 or 3 building or a Class 4 part is measured in a straight line to the nearest part of the *required single exit* or point from which travel in different directions to 2 *required exits* is available.
- (c) Subject to (d), the distance between *exits* is measured in a straight line between the nearest parts of those *exits*.

Deemed-to-Satisfy Provisions

- (d) Only the shortest distance is taken along a corridor, hallway, external balcony or other path of travel that curves or changes direction.
- (e) If more than one corridor, hallway, or other internal path of travel connects *required exits*, the measurement is along the path of travel through the point at which travel in different directions to those *exits* is available.
- (f) If a wall (including a demountable *internal wall*) that does not bound—
 - (i) a room; or
 - (ii) a corridor, hallway or the like,
 causes a change of direction in proceeding to a *required exit*, the distance is measured along the path of travel past that wall.
- (g) If permanent fixed seating is provided, the distance is measured along the path of travel between the rows of seats.
- (h) In the case of a non-*fire-isolated stairway* or non-*fire-isolated ramp*, the distance is measured along a line connecting the nosings of the treads, or along the slope of the ramp, together with the distance connecting those lines across any intermediate landings.

D1.16 Plant rooms and lift machine rooms: Concession

- (a) A ladder may be used in lieu of a stairway to provide egress from—
 - (i) a plant room with a *floor area* of not more than 100 m²; or
 - (ii) all but one point of egress from a plant room or a lift machine room with a *floor area* of not more than 200 m².
- (b) A ladder permitted under (a)—
 - (i) may form part of an *exit* provided that in the case of a *fire-isolated stairway* it is contained within the *shaft*; or
 - (ii) may discharge within a *storey* in which case it must be considered as forming part of the path of travel; and
 - (iii) must comply with—
 - (A) AS 1657 for a plant room; and
 - (B) AS 1735.2 for a lift machine room.

D1.17 Access to lift pits

Access to lift pits must—

- (a) where the pit depth is not more than 3 m, be through the lowest landing doors; or
- (b) where the pit depth is more than 3 m, be provided through an access doorway complying with the following:
 - (i) In lieu of **D1.6**, the doorway must be level with the pit floor and not be less than 600 mm wide by 1980 mm high clear opening, which may be reduced to 1500 mm where it is necessary to comply with (ii).
 - (ii) No part of the lift car or platform must encroach on the pit doorway entrance when the car is on a fully compressed buffer.

Deemed-to-Satisfy Provisions

- (iii) Access to the doorway must be by a stairway complying with AS 1657.
- (iv) In lieu of **D2.21**, doors fitted to the doorway must be—
 - (A) of the horizontal sliding or outwards opening hinged type; and
 - (B) self-closing and self-locking from the outside; and
 - (C) marked on the landing side with the letters not less than 35 mm high:
**“DANGER LIFTWELL – ENTRY OF UNAUTHORIZED PERSONS
PROHIBITED – KEEP CLEAR AT ALL TIMES”**

ACT D1.101

PART D2

CONSTRUCTION OF EXITS

Deemed-to-Satisfy Provisions

D2.0 Deemed-to-Satisfy Provisions

- (a) Where a *Building Solution* is proposed to comply with the *Deemed-to-Satisfy Provisions*, *Performance Requirements DP1* to *DP9* are satisfied by complying with—
- (i) **D1.1** to **D1.16**, **D2.1** to **D2.23** and **D3.1** to **D3.8**; and
 - (ii) in a building containing an *atrium*, **Part G3**; and
 - (iii) for theatres, *stages* and public halls, **Part H1**.
- (b) Where a *Building Solution* is proposed as an *Alternative Solution* to the *Deemed-to-Satisfy Provisions* of—
- (i) **D1.1** to **D1.16**, **D2.1** to **D2.23** and **D3.1** to **D3.8**; and
 - (ii) in a building containing an *atrium*, **Part G3**; and
 - (iii) for theatres, *stages* and public halls, **Part H1**,
- the relevant *Performance Requirements* must be determined in accordance with **A0.10**.

D2.1 Application of Part

NSW D2.1

Except for—

- (a) **D2.13**, **D2.14(a)** and **D2.16**, the *Deemed-to-Satisfy Provisions* of this Part do not apply to the internal parts of a *sole-occupancy unit* in a Class 3 building; and
- (b) **D2.13**, **D2.14(a)**, **D2.16** and **D2.18**, the *Deemed-to-Satisfy Provisions* of this Part do not apply to the internal parts of a *sole-occupancy unit* in a Class 2 building or Class 4 part.

D2.2 Fire-isolated stairways and ramps

A stairway or ramp (including any landings) that is *required* to be within a *fire-resisting shaft* must be constructed—

- (a) of *non-combustible* materials; and
- (b) so that if there is local failure it will not cause structural damage to, or impair the fire-resistance of, the *shaft*.

D2.3 Non-fire-isolated stairways and ramps

In a building having a *rise in storeys* of more than 2, *required* stairs and ramps (including landings and any supporting building elements) which are not *required* to be within a *fire-resisting shaft*, must be constructed according to **D2.2**, or only of—

- (a) reinforced or prestressed concrete; or
- (b) steel in no part less than 6 mm thick; or
- (c) timber that—

Deemed-to-Satisfy Provisions

- (i) has a finished thickness of not less than 44 mm; and
- (ii) has an average density of not less than 800 kg/m³ at a moisture content of 12%; and
- (iii) has not been joined by means of glue unless it has been laminated and glued with resorcinol formaldehyde or resorcinol phenol formaldehyde glue.

D2.4 Separation of rising and descending stair flights

If a stairway serving as an *exit* is *required* to be fire-isolated—

- (a) there must be no direct connection between—
 - (i) a *flight* rising from a *storey* below the lowest level of access to a road or *open space*; and
 - (ii) a *flight* descending from a *storey* above that level; and
- (b) any construction that separates or is common to the rising and descending *flights* must be—
 - (i) *non-combustible*; and
 - (ii) smoke proof in accordance with **Clause 2 of Specification C2.5**.

D2.5 Open access ramps and balconies

Where an open access ramp or balcony is provided to meet the smoke hazard management requirements of **Table E2.2a**, it must—

- (a) have ventilation openings to the outside air which—
 - (i) have a total unobstructed area not less than the *floor area* of the ramp or balcony; and
 - (ii) are evenly distributed along the open sides of the ramp or balcony; and
- (b) not be enclosed on its open sides above a height of 1 m except by an open grille or the like having a free air space of not less than 75% of its area.

D2.6 Smoke lobbies

A smoke lobby *required* by **D1.7** must—

- (a) have a *floor area* not less than 6 m²; and
- (b) be separated from the occupied areas in the *storey* by walls which are impervious to smoke, and—
 - (i) have an FRL of not less than 60/60/– (which may be fire-protective grade plasterboard, gypsum block with set plaster, face brickwork, glass blocks or glazing); and
 - (ii) extend from slab to slab, or to the underside of a ceiling with a *resistance to the incipient spread of fire* of 60 minutes which covers the lobby; and
 - (iii) any construction joints between the top of the walls and the floor slab, roof or ceiling must be smoke sealed with intumescent putty or other suitable material; and

Deemed-to-Satisfy Provisions

- (c) at any opening from the occupied areas, have smoke doors complying with **Clause 3 of Specification C3.4** except that the smoke sensing device need only be located on the approach side of the opening; and
- (d) be pressurised as part of the *exit* if the *exit* is *required* to be pressurised under **E2.2**.

D2.7 Installations in exits and paths of travel

- (a) Access to service *shafts* and services other than to fire-fighting or detection equipment as permitted in the *Deemed-to-Satisfy Provisions* of **Section E**, must not be provided from a *fire-isolated stairway*, *fire-isolated passageway* or *fire-isolated ramp*.
- (b) An opening to any chute or duct intended to convey hot products of combustion from a boiler, incinerator, fireplace or the like, must not be located in any part of a *required exit* or any corridor, hallway, lobby or the like leading to a *required exit*.
- (c) Gas or other fuel services must not be installed in a *required exit*.
- (d) Services or equipment comprising—
 - (i) electricity meters, distribution boards or ducts; or
 - (ii) central telecommunications distribution boards or equipment; or
 - (iii) electrical motors or other motors serving equipment in the building,
 may be installed in—
 - (iv) a *required exit*, except for fire-isolated *exits* specified in (a); or
 - (v) in any corridor, hallway, lobby or the like leading to a *required exit*,
 if the services or equipment are enclosed by *non-combustible* construction or a *fire-protective covering* with doorways or openings suitably sealed against smoke spreading from the enclosure.
- (e) Electrical wiring may be installed in a fire-isolated *exit* if the wiring is associated with—
 - (i) a lighting, detection, or pressurisation system serving the *exit*; or
 - (ii) a security, surveillance or management system serving the *exit*; or
 - (iii) an intercommunication system or an audible or visual alarm system in accordance with **D2.22**; or
 - (iv) the monitoring of hydrant or sprinkler isolating valves.

D2.8 Enclosure of space under stairs and ramps

- (a) **Fire-isolated stairways and ramps** — If the space below a *required fire-isolated stairway* or *fire-isolated ramp* is within the fire-isolated *shaft*, it must not be enclosed to form a cupboard or similar enclosed space.
- (b) **Non fire-isolated stairways and ramps** — The space below a *required non fire-isolated stairway* (including an external stairway) or non *fire-isolated ramp* must not be enclosed to form a cupboard or other enclosed space unless—
 - (i) the enclosing walls and ceilings have an FRL of not less than 60/60/60; and
 - (ii) any access doorway to the enclosed space is fitted with a *self-closing* –/60/30 fire door.

Deemed-to-Satisfy Provisions

D2.9 Width of stairways

- (a) The *required* width of a stairway must—
 - (i) be measured clear of all obstructions such as handrails, projecting parts of balustrades or other barriers and the like; and
 - (ii) extend without interruption, except for ceiling cornices, to a height not less than 2 m vertically above a line along the nosings of the treads or the floor of the landing.
- (b) A *required* stairway that exceeds 2 m in width is counted as having a width of only 2 m unless it is divided by a handrail, balustrade or other barrier continuous between landings and each division is less than 2 m wide.

D2.10 Pedestrian ramps

- (a) A *fire-isolated ramp* may be substituted for a *fire-isolated stairway* if the construction enclosing the *ramp* and the width and ceiling height comply with the requirements for a *fire-isolated stairway*.
- (b) A ramp serving as a *required exit* must—
 - (i) where the ramp is also serving as an *accessible* ramp under **Part D3**, be in accordance with AS 1428.1; or
 - (ii) in any other case, have a gradient not steeper than 1:8.
- (c) The floor surface of a ramp must have a non-slip finish.

D2.11 Fire-isolated passageways

- (a) The enclosing construction of a *fire-isolated passageway* must have an FRL when tested for a fire outside the passageway in another part of the building of—
 - (i) if the passageway discharges from a *fire-isolated stairway* or *ramp* — not less than that *required* for the stairway or ramp *shaft*; or
 - (ii) in any other case — not less than 60/60/60.
- (b) Notwithstanding **(a)(ii)**, the top construction of a *fire-isolated passageway* need not have an FRL if the walls of the *fire-isolated passageway* extend to the underside of—
 - (i) a *non-combustible* roof covering; or
 - (ii) a ceiling having a *resistance to the incipient spread of fire* of not less than 60 minutes separating the roof space or ceiling space in all areas surrounding the passageway within the *fire compartment*.

D2.12 Roof as open space

If an *exit* discharges to a roof of a building, the roof must—

- (a) have an FRL of not less than 120/120/120; and
- (b) not have any rooflights or other openings within 3 m of the path of travel of persons using the *exit* to reach a road or *open space*.

Deemed-to-Satisfy Provisions

D2.13 Goings and risers

- (a) A stairway must have—
- (i) not more than 18 nor less than 2 risers in each *flight*; and
 - (ii) except as permitted by (b) and (c), going (G), riser (R) and quantity (2R + G) in accordance with **Table D2.13**; and
 - (iii) except as permitted by (b) and (c), goings and risers that are constant throughout in one *flight*; and
 - (iv) risers which do not have any openings that would allow a 125 mm sphere to pass through between the treads; and
 - (v) treads which have a non-slip finish or an adequate non-skid strip near the edge of the nosings; and
 - (vi) treads of solid construction (not mesh or other perforated material) if the stairway is more than 10 m high or connects more than 3 *storeys*; and
 - (vii) in a Class 9b building, not more than 36 risers in consecutive *flights* without a change in direction of at least 30°; and
 - (viii) in the case of a *required* stairway, no winders in lieu of a landing.

NSW D2.13(a)(ix),(x),(xi)

- (b) In the case of a non-*required* stairway—
- (i) the stairway must have—
 - (A) not more than 3 winders in lieu of a quarter landing; and
 - (B) not more than 6 winders in lieu of a half landing; and
 - (ii) the going of all straight treads must be constant throughout the same *flight*; and
 - (iii) the going of all winders in lieu of a quarter or half landing may vary from the going of the straight treads within the same *flight* provided that the going of all such winders is constant.
- (c) Where a stairway discharges to a sloping public walkway or public road—
- (i) the riser (R) may be reduced to account for the slope of the walkway or road; and
 - (ii) the quantity (2R+G) may vary at that location.

Deemed-to-Satisfy Provisions

Table D2.13 RISER AND GOING DIMENSIONS (mm)

	Riser (R)		Going (G) ^(b)		Quantity (2R+G)	
	Max	Min	Max	Min	Max	Min
Public stairways	190	115	355	250	700	550
Private stairways ^(a)	190	115	355	240	700	550

125 mm sphere must not pass through treads

Note:

(a) Private stairways are—

- (i) stairways in a *sole-occupancy unit* in a Class 2 building or Class 4 part; and
- (ii) in any building, stairways which are not part of a *required exit* and to which the public do not normally have access.

(b) The going in tapered treads (except winders in lieu of a quarter or half landing) in a curved or spiral stairway is measured—

- (i) 270 mm in from the outer side of the unobstructed width of the stairway if the stairway is less than 1 m wide (applicable to a non-*required* stairway only); and
- (ii) 270 mm from each side of the unobstructed width of the stairway if the stairway is 1 m wide or more.

D2.14 Landings

In a stairway—

- (a) landings having a maximum gradient of 1:50 may be used in any building to limit the number of risers in each *flight* and each landing must—
- (i) be not less than 750 mm long, and where this involves a change in direction, the length is measured 500 mm from the inside edge of the landing; and
 - (ii) have a non-slip finish throughout or an adequate non-skid strip near the edge of the landing where it leads to a *flight* below; and
- (b) in a Class 9a building—
- (i) the area of any landing must be sufficient to move a stretcher, 2 m long and 600 mm wide, at a gradient not more than the gradient of the stairs, with at least one end of the stretcher on the landing while changing direction between *flights*; or

Deemed-to-Satisfy Provisions

- (ii) the stair must have a change of direction of 180°, and the landing a clear width of not less than 1.6 m and a clear length of not less than 2.7 m.

D2.15 Thresholds

The threshold of a doorway must not incorporate a step or ramp at any point closer to the doorway than the width of the door leaf unless—

- (a) in *patient care areas* in a Class 9a *health-care building*, the door sill is not more than 25 mm above the finished floor level to which the doorway opens; or
- (b) in a Class 9c *aged care building*, a ramp is provided with a maximum gradient of 1:8 for a maximum height of 25 mm over the threshold; or

NSW D2.15(c),(d)

- (c) in other cases—
 - (i) the doorway opens to a road or *open space*, external stair landing or external balcony; and
 - (ii) the door sill is not more than 190 mm above the finished surface of the ground, balcony, or the like, to which the doorway opens.

D2.16 Balustrades or other barriers

- (a) A continuous balustrade or other barrier must be provided along the side of any roof to which public access is provided, any stairway or ramp, any floor, corridor, hallway, balcony, deck, verandah, *mezzanine*, access bridge or the like and along the side of any delineated path of access to a building, if—
 - (i) it is not bounded by a wall; and
 - (ii) its level above the surface beneath, is more than—
 - (A) 4 m where it is possible for a person to fall through an openable *window*; or
 - (B) 1 m in any other case.
- (b) The requirements of (a) do not apply to—
 - (i) the perimeter of a *stage*, rigging loft, loading dock or the like; or
 - (ii) areas referred to in **D2.18**; or
 - (iii) a retaining wall unless the retaining wall forms part of, or is directly associated with a delineated path of access to a building from the road, or a delineated path of access between buildings.
- (c) A balustrade or other barrier in—
 - (i) *fire-isolated stairways*, *fire-isolated ramps* and other areas used primarily for emergency purposes, excluding external stairways and external ramps; and
 - (ii) Class 7 (other than *carparks*) and Class 8 buildings and parts of buildings containing those classes,
 must comply with (g) and (h)(i).
- (d) A balustrade or other barrier in stairways and ramps, other than those covered in (c), must comply with (g) and (h)(ii).

Deemed-to-Satisfy Provisions

- (e) A balustrade or other barrier along the side of a horizontal or near horizontal surface such as a—
 - (i) roof to which public access is provided and any path of access to a building; and
 - (ii) floor, corridor, hallway, balcony, verandah, *mezzanine*, access bridge or the like, must comply with (g) and (h)(ii).
- (f) A balustrade or other barrier in front of fixed seating on a *mezzanine* or balcony within an auditorium in a Class 9b building must comply with (g)(iv) and (h)(ii).
- (g) The height of a balustrade or other barrier must be constructed in accordance with the following:
 - (i) The height is not less than 865 mm above the nosings of the stair treads or the floor of a ramp or other path of travel with a gradient not less than 1:20.
 - (ii) The height is not less than—
 - (A) 1 m above the floor of any access path, balcony, landing or the like where the path of travel has a gradient less than 1:20; or
 - (B) 865 mm above the floor of a landing to a stair or ramp where the balustrade or other barrier is provided along the inside edge of the landing and does not exceed a length of 500 mm; or
 - (C) 865 mm above the floor beneath an openable *window*.
 - (iii) A transition zone may be incorporated where the balustrade or other barrier height changes from 865 mm on the stair *flight* or ramp to 1 m at the landing.

NSW D2.16(f)(iv) and (v)

- (iv) For a balustrade or other barrier provided under (f), the height above the floor must be not less than—
 - (A) 1 m; or
 - (B) 700 mm and a horizontal projection extends not less than 1 m outwards from the top of the balustrade.
- (h) Openings in a balustrade or other barrier must be constructed in accordance with the following:
 - (i) For a balustrade or other barrier provided under (c)—
 - (A) the space between balusters or the width of any opening (including any openable *window* or panel) must not be more than 300 mm; or
 - (B) where rails are used, a rail must be provided at a height of not more than 150 mm above the nosings of the stair treads or the floor of the landing, balcony or the like and the space between rails must not be more than 460 mm.
 - (ii) For a balustrade or other barrier other than those provided under (c)—
 - (A) any opening does not permit a 125 mm sphere to pass through it and for stairs, the space is measured above the nosings; and
 - (B) for floors more than 4 m above the surface beneath, any horizontal or near horizontal elements between 150 mm and 760 mm above the floor must not facilitate climbing.

Deemed-to-Satisfy Provisions

- (i) A wire balustrade must be constructed in accordance with the following and is deemed to meet the requirements of **(h)(ii)(A)**:
 - (i) For horizontal wire systems-
 - (A) when measured with a strain indicator, it must be in accordance with the tension values in **Table D2.16a**; or
 - (B) must not exceed the maximum deflections in **Table D2.16c**.
 - (ii) For non-continuous vertical wire systems, when measured with a strain indicator, must be in accordance with the tension values in **Table D2.16a** (see Note 4).
 - (iii) For continuous vertical or continuous near vertical sloped wire systems—
 - (A) must have wires of no more than 2.5 mm diameter with a lay of 7x7 or 7x19 construction; and
 - (B) changes in direction at support rails must pass around a pulley block without causing permanent deformation to the wire; and
 - (C) must have supporting rails, constructed with a spacing of not more than 900 mm, of a material that does not allow deflection that would decrease the tension of the wire under load; and
 - (D) when the wire tension is measured with a strain indicator, it must be in accordance with the tension values in **Table D2.16b** and measured in the furthest span from the tensioning device.

TABLE D2.16a WIRE BALUSTRADE CONSTRUCTION – REQUIRED TENSION FOR STAINLESS STEEL HORIZONTAL WIRES

			Clear distance between posts (mm)								
			600	800	900	1000	1200	1500	1800	2000	2500
Wire dia. (mm)	Lay	Wire spacing (mm)	Minimum <i>required</i> tension in Newtons (N)								
2.5	7x7	60	55	190	263	415	478	823	1080	1139	X
		80	382	630	730	824	1025	1288	X	X	X
		100	869	1218	1368	X	X	X	X	X	X
2.5	1x19	60	35	218	310	402	585	810	1125	1325	X
		80	420	630	735	840	1050	1400	1750	X	X
		100	1140	1565	X	X	X	X	X	X	X
3.0	7x7	60	15	178	270	314	506	660	965	1168	1491
		80	250	413	500	741	818	1083	1370	1565	X
		100	865	1278	1390	1639	X	X	X	X	X
3.0	1x19	60	25	183	261	340	520	790	1025	1180	X
		80	325	555	670	785	1015	1330	1725	1980	X
		100	1090	1500	1705	1910	X	X	X	X	X

Deemed-to-Satisfy Provisions

TABLE D2.16a WIRE BALUSTRADE CONSTRUCTION – REQUIRED TENSION FOR STAINLESS STEEL HORIZONTAL WIRES – continued

4.0	7x7	60	5	73	97	122	235	440	664	813	1178
		80	196	422	480	524	760	1100	1358	1530	2130
		100	835	1182	1360	1528	1837	2381	2811	3098	X
4.0	1x19	60	5	5	10	15	20	147	593	890	1280
		80	30	192	300	415	593	1105	1303	1435	1844
		100	853	1308	1487	1610	2048	2608	3094	3418	3849
4.0	7x19	60	155	290	358	425	599	860	1080	1285	1540
		80	394	654	785	915	1143	1485	1860	2105	2615
		100	1038	1412	1598	1785	2165	2735	X	X	X

Notes:

- 1 Lay = number of strands by the number of individual wires in each strand. For example a lay of 7x19 consists of 7 strands with 19 individual wires in each strand.
- 2 Where a change of direction is made in a run of wire, the tensioning device is to be placed at the end of the longest span.
- 3 If a 3.2 mm wire is used the tension figures for 3.0 mm wire are applied.
- 4 This table may also be used for a set of non-continuous (single) vertical wires forming a balustrade using the appropriate clear distance between posts as the vertical clear distance between the rails.
- 5 X = Not allowed because the required tension would exceed the safe load of the wire.
- 6 Tension measured with a strain indicator.

TABLE D2.16b CONTINUOUS WIRE BALUSTRADE CONSTRUCTION – REQUIRED TENSION FOR VERTICAL OR NEAR VERTICAL STAINLESS STEEL WIRES

Wire dia. (mm)	Lay	Widest spacing between wires (mm)	Maximum clear spacing between rails (mm)
			900
			<i>Required</i> tension in Newtons (N)
2.5	7x19	80	145
		100	310
		110	610
2.5	7x7	80	130
		100	280
		110	500

Notes:

- 1 Lay = number of strands by the number of individual wires in each strand. For example a lay of 7x19 consists of 7 strands with 19 individual wires in each strand.

Deemed-to-Satisfy Provisions

TABLE D2.16b CONTINUOUS WIRE BALUSTRADE CONSTRUCTION – REQUIRED TENSION FOR VERTICAL OR NEAR VERTICAL STAINLESS STEEL WIRES— continued

2	Vertical wires require two pulley blocks to each 180 ^o change of direction in the wire.
3	Near vertical wires may only require one pulley block for each change of direction.
4	Tension measured with a strain indicator.
5	The table only includes 7x7 and 7x19 wires due to other wires not having sufficient flexibility to make the necessary turns.

TABLE D2.16c WIRE BALUSTRADE CONSTRUCTION – MAXIMUM PERMISSIBLE DEFLECTION FOR STAINLESS STEEL WIRES

		Clear distance between posts (mm)					
		600	900	1200	1500	1800	2000
Wire dia. (mm)	Wire spacing (mm)	Maximum permissible deflection of each wire in mm when a 2 kg mass is suspended at mid span					
2.5	60	17	11	9	8	8	8
	80	7	5	5	5	X	X
3.0	60	19	13	8	7	7	7
	80	8	6	6	5	5	5
4.0	60	18	12	8	8	7	7
	80	8	6	4	4	4	4

Notes:

- 1 Where a change of direction is made in a run of wire the 2 kg mass must be placed at the middle of the longest span.
- 2 If a 3.2 mm wire is used the deflection figures for 3.0 mm wire are applied.
- 3 This table may also be used for a set of non-continuous (single) vertical wires forming a balustrade using the appropriate clear distance between posts as the vertical clear distance between the rails. The deflection (offset) is measured by hooking a standard spring scale to the mid span of each wire and pulling it horizontally until a force of 19.6 N is applied.
- 4 X = Not allowed because the required tension would exceed the safe load of the wire.
- 5 This table has been limited to 60 mm and 80 mm spaces for 2.5 mm, 3 mm and 4 mm diameter wires because the required wire tensions at greater spacings would require the tension to be beyond the wire safe load limit, or the allowed deflection would be impractical to measure.

D2.17 Handrails

(a) Except for handrails referred to in [D2.18](#), handrails must be—

Deemed-to-Satisfy Provisions

- (i) located along at least one side of the ramp or *flight*; and
 - (ii) located along each side if the total width of the stairway or ramp is 2 m or more; and
 - (iii) not more than 2 m apart in the case of intermediate handrails; and
 - (iv) in a Class 9b building used as a primary *school*—
 - (A) have one handrail fixed at a height of not less than 865 mm; and
 - (B) have a second handrail fixed at a height between 665 mm and 750 mm, measured above the nosings of stair treads and the floor surface of the ramp, landing or the like; and
 - (v) in any other case, fixed at a height of not less than 865 mm measured above the nosings of stair treads and the floor surface of the ramp, landing, or the like; and
 - (vi) continuous between stair *flight* landings and have no obstruction on or above them that will tend to break a hand-hold.
- (b) Handrails—
- (i) in a Class 9a *health-care building* must be provided along at least one side of every passageway or corridor used by patients, and must be—
 - (A) fixed not less than 50 mm clear of the wall; and
 - (B) where practicable, continuous for their full length.
 - (ii) in a Class 9c *aged care building* must be provided along both sides of every passageway or corridor used by residents, and must be—
 - (A) fixed not less than 50 mm clear of the wall; and
 - (B) where practicable, continuous for their full length.
- (c) Handrails *required* to assist people with disabilities must be provided in accordance with **D3.3(a)(ii)**.

D2.18 Fixed platforms, walkways, stairways and ladders

A fixed platform, walkway, stairway, ladder and any going and riser, landing, handrail, balustrade or other barrier attached thereto may comply with AS 1657 in lieu of **D2.13**, **D2.14**, **D2.16** and **D2.17** if it only serves:

- (a) machinery rooms, boiler houses, lift-machine rooms, plant-rooms, and the like; or
- (b) non-*habitable rooms*, such as attics, storerooms and the like that are not used on a frequent or daily basis in the internal parts of a *sole-occupancy unit* in a Class 2 building or Class 4 part.

D2.19 Doorways and doors

- (a) A doorway in a *resident use area* of a Class 9c *aged care building* must not be fitted with—
 - (i) a sliding fire door; or
 - (ii) a sliding smoke door; or
 - (iii) a revolving door; or

Deemed-to-Satisfy Provisions

- (iv) a roller shutter door; or
 - (v) a tilt-up door.
- (b) A doorway serving as a *required exit* or forming part of a *required exit*, or a doorway in a *patient care area* of a Class 9a *health-care building*—
- (i) must not be fitted with a revolving door; and
 - (ii) must not be fitted with a roller shutter or tilt-up door unless—
 - (A) it serves a Class 6, 7 or 8 building or part with a *floor area* not more than 200 m²; and
 - (B) the doorway is the only *required exit* from the building or part; and
 - (C) it is held in the open position while the building or part is lawfully occupied; and
 - (iii) must not be fitted with a sliding door unless—
 - (A) it leads directly to a road or *open space*; and
 - (B) the door is able to be opened manually under a force of not more than 110 N; and
 - (iv) if fitted with a door which is power-operated—
 - (A) it must be able to be opened manually under a force of not more than 110 N if there is a malfunction or failure of the power source; and
 - (B) if it leads directly to a road or *open space* it must open automatically if there is a power failure to the door or on the activation of a fire or smoke alarm anywhere in the *fire compartment* served by the door.

NSW D2.19(b)(v)

D2.20 Swinging doors

A swinging door in a *required exit* or forming part of a *required exit*—

- (a) must not encroach—
 - (i) at any part of its swing by more than 500 mm on the *required* width (including any landings) of a *required*—
 - (A) stairway; or
 - (B) ramp; or
 - (C) passageway,
 if it is likely to impede the path of travel of the people already using the *exit*; and
 - (ii) when fully open, by more than 100 mm on the *required* width of the *required exit*, and

the measurement of encroachment in each case is to include door handles or other furniture or attachments to the door; and
- (b) must swing in the direction of egress unless—
 - (i) it serves a building or part with a *floor area* not more than 200 m², it is the only *required exit* from the building or part and it is fitted with a device for holding it in the open position; or

Deemed-to-Satisfy Provisions

- (ii) it serves a *sanitary compartment* or airlock (in which case it may swing in either direction); and
- (c) must not otherwise impede the path or direction of egress.

D2.21 Operation of latch

- (a) Except as *required* by (b), a door in a *required exit*, forming part of a *required exit* or in the path of travel to a *required exit* must be readily openable without a key from the side that faces a person seeking egress, by a single hand downward action or pushing action on a single device which is located between 900 mm and 1.1 m from the floor, except if it—
 - (i) serves a vault, strong-room, *sanitary compartment*, or the like; or
 - (ii) serves only, or is within—
 - (A) a *sole-occupancy unit* in a Class 2 or 3 building or a Class 4 part; or
 - (B) a *sole-occupancy unit* with a *floor area* not more than 200 m² in a Class 5, 6, 7 or 8 building; or
 - (C) a space which is otherwise inaccessible to persons at all times when the door is locked; or
 - (iii) serves the secure parts of a bank, *detention centre*, mental health facility, *early childhood centre* or the like and it can be immediately unlocked—
 - (A) by operating a fail-safe control switch, not contained within a protective enclosure, to actuate a device to unlock the door; or
 - (B) by hand by a person or persons, specifically nominated by the owner, properly instructed as to the duties and responsibilities involved and available at all times when the building is lawfully occupied so that persons in the building or part may immediately escape if there is a fire; or
 - (iv) is fitted with a fail-safe device which *automatically* unlocks the door upon the activation of any sprinkler system complying with **Specification E1.5** or smoke, or any other detector system deemed suitable in accordance with AS 1670.1 installed throughout the building; or
 - (v) is in a Class 9a or 9c building and—
 - (A) is one leaf of a two-leaf door complying with **D1.6(f)(i)** or **D1.6(f)(iv)** provided that it is not held closed by a locking mechanism and is readily openable; and
 - (B) the door is not *required* to be a fire door or smoke door.
- (b) The requirements of (a) do not apply in a Class 9b building (other than a *school*, an *early childhood centre* or a building used for religious purposes) to a door in a *required exit*, forming part of a *required exit* or in the path of travel to a *required exit* serving a *storey* or room accommodating more than 100 persons, determined in accordance with **D1.13**, in which case it must be readily openable—
 - (i) without a key from the side that faces a person seeking egress; and
 - (ii) by a single hand pushing action on a single device such as a panic bar located between 900 mm and 1.1 m from the floor; and

Deemed-to-Satisfy Provisions

- (iii) where a two-leaf door is fitted, the provisions of (i) and (ii) need only apply to one door leaf if the appropriate requirements of D1.6 are satisfied by the opening of that one leaf.

NSW D2.21(b)(iv) and (c)

Vic D2.21(a)(vi)

D2.22 Re-entry from fire-isolated exits

- (a) Doors of a fire-isolated *exit* must not be locked from the inside as follows:
 - (i) In a Class 9a *health-care building*.
 - (ii) In a Class 9c *aged care building*.
 - (iii) In a fire-isolated *exit* serving any storey above an *effective height* of 25 m, throughout the *exit*.
- (b) The requirements of (a) do not apply to a door fitted with a fail-safe device that *automatically* unlocks the door upon the activation of a fire alarm and—
 - (i) on at least every fourth *storey*, the doors are not able to be locked and a sign is fixed on such doors stating that re-entry is available; or
 - (ii) an intercommunication system, or an audible or visual alarm system, operated from within the enclosure is provided near the doors and a sign is fixed adjacent to such doors explaining its purpose and method of operation.

D2.23 Signs on doors

- (a) A sign, to alert persons that the operation of certain doors must not be impaired, must be installed where it can readily be seen on, or adjacent to, a—
 - (i)
 - (A) *required* fire door providing direct access to a fire-isolated *exit*, except a door providing direct egress from a *sole-occupancy unit* in a Class 2 or 3 building or Class 4 part; and
 - (B) *required* smoke door,
on the side of the door that faces a person seeking egress and, if the door is fitted with a device for holding it in the open position, on either the wall adjacent to the doorway or both sides of the door; and
 - (ii)
 - (A) fire door forming part of a *horizontal exit*; and
 - (B) smoke door that swings in both directions; and
 - (C) door leading from a fire isolated *exit* to a road or *open space*,
on each side of the door.
- (b) A sign referred to in (a) must be in capital letters not less than 20 mm high in a colour contrasting with the background and state—
 - (i) for an *automatic* door held open by an *automatic* hold-open device—
“FIRE SAFETY DOOR—DO NOT OBSTRUCT”; or

Deemed-to-Satisfy Provisions

- (ii) for a *self-closing* door—
**“FIRE SAFETY DOOR
DO NOT OBSTRUCT
DO NOT KEEP OPEN”**; or
- (iii) for a door discharging from a fire-isolated *exit*—
“FIRE SAFETY DOOR—DO NOT OBSTRUCT”.

NSW D2.101

PART D3

ACCESS FOR PEOPLE WITH DISABILITIES

Deemed-to-Satisfy Provisions

D3.0 Deemed-to-Satisfy Provisions

- (a) Where a *Building Solution* is proposed to comply with the *Deemed-to-Satisfy Provisions*, *Performance Requirements DP1* to *DP9* are satisfied by complying with—
- (i) **D1.1** to **D1.16**, **D2.1** to **D2.23** and **D3.1** to **D3.8**; and
 - (ii) in a building containing an *atrium*, **Part G3**; and
 - (iii) for theatres, *stages* and public halls, **Part H1**.
- (b) Where a *Building Solution* is proposed as an *Alternative Solution* to the *Deemed-to-Satisfy Provisions* of—
- (i) **D1.1** to **D1.16**, **D2.1** to **D2.23** and **D3.1** to **D3.8**; and
 - (ii) in a building containing an *atrium*, **Part G3**; and
 - (iii) for theatres, *stages* and public halls, **Part H1**,
- the relevant *Performance Requirements* must be determined in accordance with **A0.10**.

D3.1 Application of Part

SA D3.1

The *Deemed-to-Satisfy Provisions* of this Part apply to Class 3, 5, 6, 7, 8, 9 or 10a buildings other than—

- (a) a Class 10a building associated with a Class 2 building or Class 4 part of a building; or
- (b) a Class 7a building associated with a Class 2 building.

D3.2 General building access requirements

- (a) Buildings must be *accessible* as *required* by **Table D3.2**.
- (b) Parts of buildings *required* to be *accessible* must comply with this Part and AS 1428.1.
- (c) External access to a building *required* to be *accessible* must be in accordance with this Part and AS 1428.1, and must be provided—
 - (i) from the allotment boundary at the main points of entry; and
 - (ii) from any *accessible* carparking space on the allotment in accordance with **D3.5**; and
 - (iii) from any adjacent and associated *accessible* building on the allotment; and
 - (iv) through the principal public entrance.

SA Table D3.2 Class 2

Deemed-to-Satisfy Provisions

Table D3.2 REQUIREMENTS FOR ACCESS FOR PEOPLE WITH DISABILITIES

Class of building	Access requirements
Class 3 building or group of buildings	
(a) Common areas and unique features and services	To and within— <ul style="list-style-type: none"> (i) the common areas on the <i>storey</i> incorporating the principal public entrance; and (ii) any facility <i>required</i> to be <i>accessible</i>; and (iii) not less than 1 of each room or area in which a unique service is provided or which has a unique feature.
(b) If the building or group of buildings contains <i>sole-occupancy units</i> —	
for 1 to 20 units	To and within 1 <i>sole-occupancy unit</i>
for more than 20 but not more than 45 units	To and within 2 <i>sole-occupancy unit</i> .
for each additional 30 units or part thereof	To and within 1 additional <i>sole-occupancy unit</i> .
	Where 2 or more <i>accessible sole-occupancy units</i> are <i>required</i> , they must be distributed as equitably as practical so as to be representative of the range of amenity available.
(c) If accommodation is provided for more than 10 persons, other than in <i>sole-occupancy units</i> —	
up to 49 beds	To 2 beds.
more than 49 but not more than 99 beds	To 4 beds.
more than 99 beds	To 6 beds.
Class 5, 6, 7 and 8	To and within— <ul style="list-style-type: none"> (i) the entrance floor; and (ii) any other floor to which vertical access by way of a ramp, step ramp or kerb ramp complying with AS 1428.1 or a passenger lift is provided.
Class 9a health-care	To and within all areas normally used by the public, patients or staff.

Deemed-to-Satisfy Provisions

Table D3.2 REQUIREMENTS FOR ACCESS FOR PEOPLE WITH DISABILITIES— continued

Class of building	Access requirements
<p>Class 9b</p> <p>An <i>assembly building</i> not being a <i>school</i> or an <i>early childhood centre</i></p>	<p>To and within—</p> <ul style="list-style-type: none"> (i) every auditorium but not to every tier or platform; and (ii) the main entrance to the auditorium; and (iii) if fixed seating is provided, not less than 1 wheelchair space for each 100 persons or part thereof, with a minimum of 2 spaces, up to 200 persons, and an additional space for each additional 200 persons or part thereof by which the number of persons exceeds 200; and (iv) all other areas normally used by the occupants.
<p>A <i>school</i></p>	<p>To and within—</p> <ul style="list-style-type: none"> (i) all areas normally used by the occupants, including staff, students and visitors, if no alternative similar facilities to those provided in that area are <i>accessible</i> elsewhere in the <i>school</i>; and (ii) any other floor to which vertical access by way of a ramp, step ramp or kerb ramp complying with AS 1428.1, or a passenger lift is provided.
<p>An <i>early childhood centre</i></p>	<p>To and within all areas normally used by the occupants including staff, children and visitors.</p>

Deemed-to-Satisfy Provisions

Table D3.2 REQUIREMENTS FOR ACCESS FOR PEOPLE WITH DISABILITIES— continued

Class of building	Access requirements
Aged care buildings or group of buildings being a Class 9c building	
(a) Common areas and unique features and services	To and within— <ul style="list-style-type: none"> (i) the common areas on the <i>storey</i> incorporating the principal public entrance, excluding resident use sanitary facilities, utility rooms, store rooms and the like; and (ii) any facility <i>required</i> to be <i>accessible</i>; and (iii) not less than 1 of each room or area in which a unique service is provided or which has a unique feature.
(b) If the building or group of buildings contains <i>sole-occupancy units</i> —	
for 1 to 20 units	To and within 1 <i>sole-occupancy unit</i> .
for more than 20 but not more than 45 units	To and within 2 <i>sole-occupancy unit</i> .
for each additional 30 units or part thereof	To and within 1 additional <i>sole-occupancy unit</i> .
	Where 2 or more <i>accessible sole-occupancy units</i> are <i>required</i> , they must be distributed as equitably as practical so as to be representative of the range of amenity available.
(c) If accommodation is provided for more than 10 persons, other than in <i>sole-occupancy units</i> —	
up to 49 beds	To 2 beds.
more than 49 but not more than 99 beds	To 4 beds.
more than 99 beds	To 6 beds.
Class 10a	To and within building containing any of the following: <ul style="list-style-type: none"> (i) Sanitary facilities, showers, handbasins, changeroom facilities or the like. (ii) A unique service or feature, such as a public shelter or the like, which is located in an <i>accessible</i> area.

Deemed-to-Satisfy Provisions

Table D3.2 REQUIREMENTS FOR ACCESS FOR PEOPLE WITH DISABILITIES— continued

Class of building	Access requirements
Notes: For the purpose of this Table:	
1. A unique service or feature, unless otherwise indicated, includes a TV room, dining room, lounge room, common laundry, recreation area, individual shop, eating area, public viewing area, ticket purchasing, lunchroom, and the like.	
2. A double bed counts as 1 bed.	
3. A common area does not include an internal space such as a corridor or lobby that is not an <i>accessway</i> .	

D3.3 Parts of buildings to be accessible

- (a) In a building or part of a building *required* by **Table D3.2** to be *accessible*—
 - (i) access must be provided—
 - (A) to any *sanitary compartment required* for the use of people with disabilities; and
 - (B) to areas normally used by the occupants, excluding any plantroom, commercial kitchen, cleaners’ store room, maintenance accessway, rigging loft, or the like; and
 - (ii) where access is *required* to the entrance floor but not to other levels and a passenger lift is not installed, at least one *required* ramp must have handrails complying with Clause 5.3(e) of AS 1428.1 or at least one *required* stairway must comply with Clause 9 of AS 1428.1; and
 - (A) * * * * *
 - (B) * * * * *
 - (iii) every passenger lift must comply with **E3.6**.
- (b) A path of travel *required* to be *accessible* must not include a stairway, turnstile, revolving door, escalator or other impediment which would prevent a person in a wheelchair using it.
- (c) Access, finishes and fittings, including passageways, ramps, step ramps or kerb ramps, signs, doorways and other parts of the building *required* by this Part must comply with the provisions of AS 1428.1.

D3.4 Concessions

It is not necessary to provide access for people with disabilities to—

- (a) more than 30% of the public space in a restaurant, cafe, bar, function room, or the like, in a Class 6 or Class 9b building; or
- (b) a *mezzanine*; or
- (c) a space not regarded as a *storey* by definition; or
- (d) any area if access would be inappropriate because of the particular purpose for which the area is used.

SA D3.4(e)

Deemed-to-Satisfy Provisions

D3.5 Carparking

Carparking spaces for people with disabilities—

- (a) subject to **(b)**, must be provided in accordance with **Table D3.5** in—
 - (i) a *carpark required* to be *accessible*; and
 - (ii) a carparking area on the same allotment as a building *required* to be *accessible*; and
- (b) need not be provided in a *carpark* or carparking area where a parking service is provided and direct access to any of the carparking spaces is not available to the general public or occupants; and
- (c) subject to **(d)**, must comply with AS 2890.1; and
- (d) are not *required* to be signed where there is a total of not more than 5 carparking spaces, so as to restrict the use of the carparking space only for people with disabilities.

Table D3.5 CARPARKING SPACES FOR PEOPLE WITH DISABILITIES

Class of building to which the <i>carpark</i> or carparking area is associated	Number of carparking spaces <i>required</i> for people with disabilities
Class 3	
(a) Boarding house, guest house, hostel, lodging house, backpackers accommodation, or the residential part of a hotel or motel.	To be calculated by multiplying the total number of carparking spaces by the— <ul style="list-style-type: none"> (i) percentage of <i>accessible sole-occupancy units</i> to the total number of <i>sole-occupancy units</i>; or (ii) percentage of beds to which access for people with disabilities is provided to the total number of beds provided. The calculated number to be taken to the next whole figure.
(b) Residential part of a <i>school</i> , accommodation for the aged, disabled or children, residential part of a <i>health-care building</i> which accommodates members of staff or the residential part of a <i>detention centre</i> .	1 space for every 100 carparking spaces or part thereof.
Class 5, 7, 8 and 9c	1 space for every 100 carparking spaces or part thereof.
Class 6	
(a) Up to 1000 carparking spaces; and	1 space for every 50 carparking spaces or part thereof.

Deemed-to-Satisfy Provisions

Table D3.5 CARPARKING SPACES FOR PEOPLE WITH DISABILITIES— continued

Class of building to which the <i>carpark</i> or carparking area is associated	Number of carparking spaces <i>required</i> for people with disabilities
(b) for each additional 100 carparking spaces or part thereof in excess of 1000 carparking spaces.	1 space.
Class 9a	
(a) Hospital (non-outpatient area)	1 space for every 100 carparking spaces or part thereof.
(b) Hospital (outpatient area)—	
(i) up to 1000 carparking spaces; and	1 space for every 50 carparking spaces or part thereof.
(ii) for each additional 100 carparking spaces or part thereof in excess of 1000 carparking spaces.	1 space.
(c) Nursing home	1 space for every 100 carparking spaces or part thereof.
(d) Clinic or day surgery not forming part of a hospital.	1 space for every 100 carparking spaces or part thereof.
Class 9b	
(a) <i>School</i>	1 space for every 100 carparking spaces or part thereof.
(b) Other <i>assembly building</i> —	
(i) up to 1000 carparking spaces; and	1 space for every 50 carparking spaces or part thereof.
(ii) for each additional 100 carparking spaces or part thereof in excess of 1000 carparking spaces.	1 space.

D3.6 Identification of accessible facilities, services and features

In every building *required* to be *accessible*, clear and legible Braille and tactile signage complying with **Specification D3.6** and incorporating the international symbol of access or deafness or other symbol as appropriate, in accordance with AS 1428.1 must identify—

- (a) each—
 - (i) sanitary facility; and
 - (ii) *accessible* space with a hearing augmentation system; and
- (b) where an entrance or lift is not *accessible*, identify each *accessible*—
 - (i) entrance; and
 - (ii) lift or bank of lifts; and

Deemed-to-Satisfy Provisions

the path of travel from the principal public entrance to these features and facilities where their location is not apparent to the building occupant.

D3.7 Hearing augmentation

- (a) Where an inbuilt amplification system, other than one used for emergency warning purposes only, is installed, a hearing augmentation system complying with AS 1428.1 must be provided in the following locations:
 - (i) In any conference room, meeting room or the like with a *floor area* of more than 100 m².
 - (ii) In any room used for judicatory purposes.
 - (iii) In any auditorium in a Class 9b building, equitably distributed and to not less than 15% of the *floor area*.
 - (iv) At any ticket office, tellers booth, reception area or the like where the public is screened from the service provider.
- (b) In a Class 9b building, any screen or scoreboard capable of displaying public announcements, must be capable of supplementing any public address system, other than a public address system used for emergency warning purposes only.

D3.8 Tactile indicators

- (a) For a building *required* to be *accessible*, tactile ground surface indicators must be provided to warn people with a vision impairment that they are approaching—
 - (i) if used by the public—
 - (A) a stairway; and
 - (B) an escalator; and
 - (C) a travelator; and
 - (D) a ramp other than a step ramp and kerb ramp; and
 - (ii) in the absence of a suitable barrier—
 - (A) an overhead obstruction less than 2 m above floor level, other than a doorway; and
 - (B) a path of travel meeting a vehicular way adjacent to a principal public entrance to a building, if there is no kerb or kerb ramp at that point.
- (b) Tactile ground surface indicators *required* by (a) must be Type B indicators in accordance with AS 1428.4.
- (c) A hostel for the aged, nursing home for the aged, a *residential aged care building* or a Class 9c *aged care building*, need not comply with (a)(i) if handrails incorporating a raised dome button in accordance with AS 1428.1 are provided to warn people with impaired vision that they are approaching a stairway or ramp.

SPECIFICATION **D1.12** NON-REQUIRED STAIRWAYS, RAMPS AND ESCALATORS

Deemed-to-Satisfy Provisions

1. Scope

This Specification contains the requirements to allow non-*required* stairways, ramps or escalators to connect any number of *storeys* in a Class 5 or 6 building. The requirements do not apply in an *atrium* or outside a building.

2. Requirements

An escalator, moving walkway or non-*required* non-*fire-isolated stairway* or pedestrian ramp must comply with the following:

- (a) The escalator, walkway, stairway or ramp must be bounded by a *shaft* of:
 - (i) construction with an FRL of not less than 120/120/120 if *loadbearing* or - /120/120 if non-*loadbearing* and if of *lightweight construction* must comply with **Specification C1.8**; or
 - (ii) glazed construction with an FRL of not less than - /60/30 protected by a wall wetting system in accordance with **Clause 2.4 of Specification G3.8**.
- (b) The void of each non-*required* stairway, ramp or escalator must not connect more than 2 *storeys*.
- (c) Rising and descending escalators, walkways, stairways and ramps within one *shaft* must be separated by construction with an FRL of not less than - /60/30.
- (d) Openings into the *shaft* must be protected by fire doors with an FRL not less than - /60/30.
- (e) When the fire door is in the closed position, the floor or any covering over the floor beneath the fire door must not be *combustible*.
- (f) Fire doors must be fitted with smoke seals and the assembly must be tested in accordance with AS 1530.4.
- (g) Fire doors must be—
 - (i) closed and locked for security reasons; or
 - (ii) held open and be *automatic* closing.
- (h) Smoke detectors must be installed on both sides of the opening, not more than 1.5 m horizontal distance from the opening.
- (i) In the closed position, fire doors must be openable on a single hand downward action or horizontal pushing action on a single device within the *shaft* and by key only from outside the *shaft*.
- (j) A warning sign must be displayed where it can readily be seen outside the *shaft* near all fire doors opening to the *shaft*. The sign must comply with the details and dimensions of **Figure 2**.

Deemed-to-Satisfy Provisions

Figure 2 WARNING SIGN FOR NON-REQUIRED STAIRWAY, RAMP OR ESCALATOR

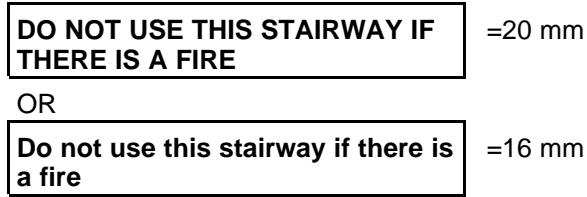

- (k) All doors opening into the *shaft* must be within 20 m of a *required exit*.
- (l) Signs showing the direction of the nearest *required exit* must be installed where they can be readily seen.
- (m) Materials attached to any wall, ceiling or floor within the *shaft* must have a *Spread-of-Flame Index* of 0 and a *Smoke-Developed Index* of not more than 5.
- (n) Emergency lighting must be installed in the *shaft* in accordance with **E4.4**.
- (o) No step or ramp may be closer to the threshold of the doorway than the width of the door leaf.

SPECIFICATION **D3.6** BRAILLE AND TACTILE SIGNS

1. Scope

This Specification sets out the requirements for the design and installation of Braille and tactile signage.

2. Braille and Tactile signage

2.1 Location of Braille and tactile signs

Signs including symbols, numbering and lettering must be designed and installed as follows:

- (a) Signs must be located not less than 1200 mm and not higher than 1600 mm above the floor or ground surface.
- (b) Signs with single lines of characters must have the line of tactile characters not less than 1250 mm and not higher than 1350 mm above the floor or ground surface.
- (c) Signs identifying rooms containing features or facilities listed in **D3.6** must be located—
 - (i) on the wall on the latch side of the door with the leading edge of the sign located between 50 mm and 300 mm from the architrave; and
 - (ii) in the event of insufficient latch side dimension, a sign may be placed on the non-latch side of the door; and
 - (iii) where (i) or (ii) is not possible, the sign may be placed on the door itself.
- (d) Signs identifying paths of travel must be placed so they are located directly ahead in the direction of travel. Where one wall continues in the direction of travel and the other forms a corner, the sign must be placed on the continuing wall.

2.2 Braille and tactile sign specification

The following applies to Braille and tactile sign orientation:

- (a) Tactile characters must be raised or embossed to a height of not less than 1 mm and not more than 1.5 mm.
- (b) Characters must have a height of not less than 17.5 mm for each metre of viewing distance.
- (c) Upper case tactile characters must have a height of not less than 15 mm and not more than 55 mm.
- (d) Lower case tactile characters must have a height of 50% of the related upper case characters.
- (e) Tactile characters, symbols, and the like, must have rounded edges.
- (f) The entire sign, including any frame, must have all edges rounded.
- (g) The surface of the sign must be continuous for hygiene purposes.
- (h) Signs must be constructed so as to resist the removal of letters and Braille dots by picking or adhesive failure.
- (i) The background, negative space or fill of signs must be of matt or low sheen finish.

- (j) The characters, symbols, logos and other features of signs must be matt or low sheen finish.
- (k) The minimum letter spacing of tactile characters on signs must be 2 mm.
- (l) The minimum word spacing of tactile characters on signs must be 10 mm.
- (m) Fonts with letters of constant stroke thickness must be used.
- (n) The thickness of letter strokes must be not less than 2 mm and not more than 7 mm.
- (o) Tactile text must be left justified, except that single words may be centre justified.

2.3 Luminance-contrast

The following applies to luminance-contrast as defined in AS 1428.1:

- (a) The background, negative space or fill of a sign or border must have a minimum luminance-contrast with the surface on which it is mounted of 30%.
- (b) A border must be provided for luminance-contrast with the sign's background and shall have a minimum width of 5 mm.
- (c) Tactile characters, icons and symbols must have a minimum 30% luminance-contrast with their background or fill within the sign.
- (d) Luminance-contrasts must be met under the lighting conditions in which the sign is to be located.

2.4 Lighting

Braille and tactile signs must be illuminated to ensure luminance-contrast requirements are met at all times during which the sign is *required* to be read.

2.5 Braille

The following applies to Braille:

- (a) Braille must be grade 1 Braille (uncontracted) in accordance with the criteria set out by the Australian Braille Authority.
- (b) Braille must be raised and domed.
- (c) Braille must be located 8 mm below the bottom line of text (not including descenders).
- (d) Braille must be left justified.
- (e) Where an arrow is used in the tactile sign, a small arrow must be provided for Braille readers.
- (f) On signs with multiple lines of text and characters, a semi-circular Braille locator at the left margin must be horizontally aligned with the first line of Braille text.

SERVICES AND EQUIPMENT

- E1 Fire Fighting Equipment**
- E2 Smoke Hazard Management**
- E3 Lift Installations**
- E4 Emergency Lighting, Exit Signs and Warning Systems**

SECTION E CONTENTS

SECTION E SERVICES AND EQUIPMENT

Part E1 Fire Fighting Equipment

Objective EO1
Functional Statement EF1.1
Performance Requirements EP1.1 - EP1.6
E1.0 Deemed-to-Satisfy Provisions
E1.1 * * * * *
E1.2 * * * * *
E1.3 Fire hydrants
E1.4 Fire hose reels
E1.5 Sprinklers
E1.6 Portable fire extinguishers
E1.7 * * * * *
E1.8 Fire control centres
E1.9 Fire precautions during construction
E1.10 Provision for special hazards
Specification E1.5 Fire Sprinkler Systems
Specification E1.8 Fire Control Centres

Part E2 Smoke Hazard Management

Objective EO2
Functional Statement EF2.1
Performance Requirements EP2.1 - EP2.2
E2.0 Deemed-to-Satisfy Provisions
E2.1 Application of Part
E2.2 General requirements
E2.3 Provision for special hazards
Specification E2.2a Smoke Detection and Alarm Systems
Specification E2.2b Smoke Exhaust Systems
Specification E2.2c Smoke-and-Heat Vents

Part E3 Lift Installations

Objective EO3
Functional Statements EF3.1 - EF3.3
Performance Requirements EP3.1 - EP3.4
E3.0 Deemed-to-Satisfy Provisions
E3.1 * * * * *
E3.2 Stretcher facility in lifts
E3.3 Warning against use of lifts in fire
E3.4 Emergency lifts
E3.5 Landings
E3.6 Facilities for people with disabilities
E3.7 Fire service controls
E3.8 Aged care buildings

Part E4 Emergency Lighting, Exit Signs and Warning Systems

Objective EO4

Functional Statement EF4.1

Performance Requirements EP4.1 - EP4.3

E4.0 Deemed-to-Satisfy Provisions

E4.1 * * * * *

E4.2 Emergency lighting requirements

E4.3 Measurement of distance

E4.4 Design and operation of emergency lighting

E4.5 Exit signs

E4.6 Direction signs

E4.7 Class 2 and 3 buildings and Class 4 parts: Exemptions

E4.8 Design and operation of exit signs

E4.9 Sound systems and intercommunication systems for emergency purposes

NSW Appendix (Additional provisions and variations — refer to NSW Contents for full details)

NT Appendix (Additional provisions and variations — refer to NT Contents for full details)

Tas Appendix (Additional provisions and variations — refer to Tas Contents for full details)

Vic Appendix (Additional provisions and variations — refer to Vic Contents for full details)

PART E1 FIRE FIGHTING EQUIPMENT

Deemed-to-Satisfy Provisions

OBJECTIVE

EO1

The *Objective* of this Part is to—

- (a) safeguard occupants from illness or injury while evacuating during a fire; and
- (b) provide facilities for occupants and the *fire brigade* to undertake fire-fighting operations; and
- (c) prevent the spread of fire between buildings.

TAS EO1(d)

FUNCTIONAL STATEMENT

EF1.1

A building is to be provided with fire-fighting equipment to safeguard against fire spread—

- (a) to allow occupants time to evacuate safely without being overcome by the effects of fire; and
- (b) so that occupants may undertake initial attack on a fire; and
- (c) so that the *fire brigade* have the necessary equipment to undertake search, rescue, and fire-fighting operations; and
- (d) to other parts of the building; and
- (e) between buildings.

TAS EF1.2

PERFORMANCE REQUIREMENTS

EP1.1

A fire hose reel system must be installed to the degree necessary to allow occupants to safely undertake initial attack on a fire appropriate to—

- (a) the size of the *fire compartment*; and
- (b) the function or use of the building; and

Deemed-to-Satisfy Provisions

- (c) any other *fire safety systems* installed in the building; and
- (d) the *fire hazard*.

EP1.2

Fire extinguishers must be installed to the degree necessary to allow occupants to undertake initial attack on a fire appropriate to—

- (a) the function or use of the building; and
- (b) any other *fire safety systems* installed in the building; and
- (c) the *fire hazard*.

EP1.3

A fire hydrant system must be provided to the degree necessary to facilitate the needs of the *fire brigade* appropriate to—

- (a) fire-fighting operations; and
- (b) the *floor area* of the building; and
- (c) the *fire hazard*.

Application:

EP1.3 only applies to a building where a *fire brigade* is available to attend.

EP1.4

An *automatic* fire suppression system must be installed to the degree necessary to control the development and spread of fire appropriate to—

- (a) the size of the *fire compartment*; and
- (b) the function or use of the building; and
- (c) the *fire hazard*; and
- (d) the height of the building.

EP1.5

Suitable means of fire-fighting must be installed to the degree necessary in a building under construction to allow initial fire attack by construction workers and for the *fire brigade* to undertake attack on the fire appropriate to—

- (a) the *fire hazard*; and
- (b) the height the building has reached during its construction.

EP1.6

Suitable facilities must be provided to the degree necessary in a building to co-ordinate *fire brigade* intervention during an emergency appropriate to—

- (a) the function or use of the building; and

Deemed-to-Satisfy Provisions

- (b) the *floor area* of the building; and
- (c) the height of the building.

TAS EP1.7

PART E1 FIRE FIGHTING EQUIPMENT

Deemed-to-Satisfy Provisions

E1.0 Deemed-to-Satisfy Provisions

Tas E1.0

- (a) Where a *Building Solution* is proposed to comply with the *Deemed-to-Satisfy Provisions, Performance Requirements EP1.1 to EP1.6* are satisfied by complying with **E1.1 to E1.10**.
- (b) Where a *Building Solution* is proposed as an *Alternative Solution* to the *Deemed-to-Satisfy Provisions* of **E1.1 to E1.10**, the relevant *Performance Requirements* must be determined in accordance with **A0.10**.

E1.1 * * * * *

This clause has deliberately been left blank.

E1.2 * * * * *

This clause has deliberately been left blank.

E1.3 Fire hydrants

- (a) A fire hydrant system must be provided to serve a building—
 - (i) having a total *floor area* greater than 500 m²; and
 - (ii) where a *fire brigade* is available to attend a building fire.
- (b) The fire hydrant system—
 - (i) must be installed in accordance with AS 2419.1; and
 - (ii) where internal fire hydrants are provided, they must serve only the *storey* on which they are located except that a *sole-occupancy unit*—
 - (A) in a Class 2 or 3 building or Class 4 part may be served by a single fire hydrant located at the level of egress from that *sole-occupancy unit*, or
 - (B) of not more than 2 *storeys* in a Class 5, 6, 7, 8 or 9 building may be served by a single fire hydrant located at the level of egress from that *sole-occupancy unit* provided the fire hydrant can provide coverage to the whole of the *sole-occupancy unit*; and
 - (iii) * * * * *
 - (iv) * * * * *
 - (v) * * * * *
 - (vi) where the water supply system is taken from a static source, suitable connections and vehicular access must be provided to permit *fire brigade* personnel to draw

Deemed-to-Satisfy Provisions

water from that source and a fire-service booster connection must be provided adjacent to allow boosting of the system.

(vii) * * * * *

E1.4 Fire hose reels

- (a) E1.4 does not apply to—
- (i) a Class 9c *aged care building*; or
 - (ii) classrooms and associated corridors in a primary or secondary *school*.
- (b) A fire hose reel system must be provided—
- (i) to serve the whole building where one or more internal fire hydrants are installed; or
 - (ii) where internal fire hydrants are not installed, to serve any *fire compartment* with a *floor area* greater than 500 m², and for the purposes of this clause, a *sole-occupancy unit* in a Class 2 or 3 building or Class 4 part is considered to be a *fire compartment*.
- (c) The fire hose reel system must—
- (i) have fire hose reels installed in accordance with AS 2441; and
 - (ii) provide fire hose reels to serve only the *storey* at which they are located, except a *sole-occupancy unit*—
 - (A) in a Class 2 or 3 building or Class 4 part may be served by a single fire hose reel located at the level of egress from that *sole-occupancy unit*; and
 - (B) of not more than 2 *storeys* in a Class 5, 6, 7, 8 or 9 building may be served by a single fire hose reel located at the level of egress from that *sole-occupancy unit* provided the fire hose reel can provide coverage to the whole of the *sole-occupancy unit*.
- (d) Fire hose reels must be located internally, externally or in combination, to achieve the system coverage specified in AS 2441.
- (e) In achieving system coverage, one or a combination of the following location criteria for individual fire hose reels must be met in determining the layout of any fire hose reel system:
- (i) Fire hose reels must be located adjacent to an internal fire hydrant (other than one within a fire-isolated *exit*), except that a fire hose reel need not be located adjacent to every fire hydrant, provided system coverage can be achieved.
 - (ii) Fire hose reels must be located within 4 m of an *exit*, except that a fire hose reel need not be located adjacent to every *exit*, provided system coverage can be achieved.
 - (iii) Where system coverage is not achieved by compliance with (i) and (ii), additional fire hose reels may be located in paths of travel to an *exit* to achieve the *required* coverage.
- (f) Fire hose reels must be located so that the fire hose will not need to pass through doorways fitted with fire or smoke doors, except—

Deemed-to-Satisfy Provisions

- (i) doorways in walls referred to in **C2.12** or **C2.13** separating equipment or electrical supply systems; and
- (ii) doorways in bounding construction in a Class 2 or 3 building or Class 4 part referred to in **C3.11**; and
- (iii) doorway openings to *shafts* referred to in **C3.13**.

E1.5 Sprinklers

A sprinkler system must—

- (a) be installed in a building or part of a building when *required* by **Table E1.5**; and
- (b) comply with **Specification E1.5**.

NT Table E1.5

Vic Table E1.5

Table E1.5 REQUIREMENTS FOR SPRINKLERS

Occupancy	When sprinklers are required
All classes— (a) including an <i>open-deck carpark</i> within a multiclassified building; but (b) excluding an <i>open-deck carpark</i> being a separate building	Throughout the whole building if any part of the building has an <i>effective height</i> of more than 25 m.
Class 6	In <i>fire compartments</i> where either of the following apply: (a) A <i>floor area</i> of more than 3 500 m ² . (b) A volume more than 21 000 m ³ .
Class 7a, other than <i>open-deck carparks</i>	In <i>fire compartments</i> where more than 40 vehicles are accommodated.
Class 9c aged care building	Throughout the building and any <i>fire compartment</i> containing a Class 9c part.
Class 9b theatres, stages & public halls	see Part H1
Atrium construction	see Part G3
Large isolated buildings	see Clause C2.3
Occupancies of excessive hazard (see Note 3)	In <i>fire compartments</i> where either of the following apply: (a) A <i>floor area</i> of more than 2 000 m ² . (b) A volume of more than 12 000 m ³ .
Notes:	
1.	See Specification C1.1 for use of sprinklers in Class 2 buildings and <i>carparks</i> generally.
2.	See Part E2 for use of sprinklers to satisfy Smoke Hazard Management provisions.

Deemed-to-Satisfy Provisions

Table E1.5 REQUIREMENTS FOR SPRINKLERS — *continued*

Occupancy	When sprinklers are required
3.	<p>For the purposes of this Table, occupancies of excessive <i>fire hazard</i> comprise buildings which contain—</p> <ul style="list-style-type: none"> (a) hazardous processes or storage including the following: <ul style="list-style-type: none"> (i) Aircraft hangars. (ii) Cane furnishing manufacture, processing and storage. (iii) Fire-lighter and fireworks manufacture and warehousing. (iv) Foam plastic and foam plastic goods manufacture, processing and warehousing, eg, furniture factory. (v) Hydrocarbon based sheet product, manufacture, processing and warehousing, eg, vinyl floor coverings. (vi) Woodwool and other flammable loose fibrous material manufacture. (b) <i>Combustible</i> Goods with an aggregate volume exceeding 1000 m³ and stored to a height greater than 4 m including the following: <ul style="list-style-type: none"> (i) Aerosol packs with flammable contents. (ii) Carpets and clothing. (iii) Electrical appliances. (iv) <i>Combustible</i> compressed fibreboards (low and high density) and plywoods. (v) <i>Combustible</i> cartons, irrespective of content (vi) Esparto and other fibrous <i>combustible</i> material. (vii) Furniture including timber, cane and composite, where foamed rubber or plastics are incorporated. (viii) Paper storage (all forms of new or waste) eg, bales, sheet, horizontal or vertical rolls, waxed coated or processed. (ix) Textiles raw and finished, eg, rolled cloth, clothing and manchester. (x) Timber storage including sheets, planks, boards, joists and cut sizes. (xi) Vinyl, plastic, foamed plastic, rubber and other <i>combustible</i> sheets, offcuts and random pieces and rolled material storage, eg, carpet, tar paper, linoleum, wood veneer and foam mattresses. (xii) All materials having wrappings or preformed containers of foamed plastics.

E1.6 Portable fire extinguishers

Portable fire extinguishers must be provided as listed in [Table E1.6](#) and must be selected, located and distributed in accordance with Sections 1, 2, 3 and 4 of AS 2444.

Deemed-to-Satisfy Provisions

E1.7 * * * * *

This clause has deliberately been left blank.

E1.8 Fire control centres

A fire control centre facility in accordance with **Specification E1.8** must be provided for—

- (a) a building with an *effective height* of more than 25 m; and
- (b) a Class 6, 7, 8 or 9 building with a total *floor area* of more than 18 000 m².

E1.9 Fire precautions during construction

In a building under construction—

- (a) not less than one fire extinguisher to suit Class A, B and C fires and electrical fires must be provided at all times on each *storey* adjacent to each *required exit* or temporary stairway or *exit*; and
- (b) after the building has reached an *effective height* of 12 m—
 - (i) the *required* fire hydrants and fire hose reels must be operational in at least every *storey* that is covered by the roof or the floor structure above, except the 2 uppermost *storeys*; and
 - (ii) any *required* booster connections must be installed.

Table E1.6 REQUIREMENTS FOR EXTINGUISHERS (Note 3)

Occupancy class	Risk class (as defined in AS 2444)
<p>General provisions—Class 2 to 9 (except within <i>sole-occupancy units</i> of a Class 2 or 3 building or Class 4 part or <i>sole-occupancy units</i> in a Class 9c <i>aged care building</i>)</p>	<ul style="list-style-type: none"> (a) To cover Class AE or E fire risks associated with emergency services switchboards. (Note 1) (b) To cover Class F fire risks involving cooking oils and fats in kitchens. (c) To cover Class B fire risks in locations where flammable liquids in excess of 50 litres are stored or used (not including that held in fuel tanks of vehicles). (d) To cover Class A fire risks in normally occupied <i>fire compartments</i> less than 500 m² not provided with fire hose reels (excluding <i>open deck carparks</i>). (e) To cover Class A fire risks in classrooms and associated corridors in primary and secondary schools not provided with fire hose reels.

Deemed-to-Satisfy Provisions

Table E1.6 REQUIREMENTS FOR EXTINGUISHERS (Note 3) — continued

Occupancy class	Risk class (as defined in AS 2444)
<p>Specific provisions (in addition to general provisions)—</p> <p>(a) Class 9a <i>health care building</i></p> <p>(b) Class 3 parts of detention and correctional occupancies</p> <p>(c) Class 3 accommodation for children, aged persons and people with disabilities</p> <p>(d) Class 9c <i>aged care buildings</i></p>	<p>To cover Class A and E fire risks. (Note 2)</p>
<p>Notes</p> <p>1. For the purposes of this Table, an emergency services switchboard is one which sustains emergency equipment operating in the emergency mode.</p> <p>2. A Class E fire extinguisher need only be located at each nurses, supervisors station or the like.</p> <p>3. Additional extinguishers may be required to cover fire risks in relation to special hazards provided for in E1.10.</p>	

E1.10 Provision for special hazards

Suitable additional provision must be made if special problems of fighting fire could arise because of—

- (a) the nature or quantity of materials stored, displayed or used in a building or on the allotment; or
- (b) the location of the building in relation to a water supply for fire-fighting purposes.

Tas E1.101

SPECIFICATION **E1.5** FIRE SPRINKLER SYSTEMS

Deemed-to-Satisfy Provisions

1. Scope

This Specification sets out requirements for the design and installation of fire sprinkler systems.

2. Adoption of AS 2118

Subject to this Specification, a sprinkler system must comply with—

- (a) AS 2118.1; or
Vic Spec E1.5 2(b)
- (b) for a Class 2 or 3 building: AS 2118.4 as applicable; or
- (c) for a combined sprinkler and fire hydrant system: AS 2118.6; or
- (d) for a Class 9c *aged care building*: AS 2118.4, as applicable.

3. Separation of sprinklered and non-sprinklered areas

Where a part of a building is not protected with sprinklers, the sprinklered and non-sprinklered parts must be fire-separated with a wall or floor which must—

- (a) comply with any specific requirement of the *Deemed-to-Satisfy Provisions* of the BCA; or
- (b) where there is no specific requirement, comply with the relevant part of AS 2118.

4. Protection of openings

Any openings, including those for service penetrations, in construction separating sprinklered and non-sprinklered parts of a building, including the construction separating the areas nominated as permitted exceptions in AS 2118.1, must be protected in accordance with the *Deemed-to-Satisfy Provisions* of **Part C3**.

5. Fast response sprinklers

Fast response sprinklers may be installed only if they are suitable for the type of application proposed and it is demonstrated that the sprinkler system is designed to accommodate their use.

6. Sprinkler valve enclosures

- (a) Sprinkler alarm valves must be located in a secure room or enclosure which has direct egress to a road or *open space*.
- (b) All sprinkler valve rooms and enclosures must be secured with a system suitable for use by the *fire brigade*.

7. Water supply

The Grade of water supply to a *required* sprinkler system must not be less than—

Deemed-to-Satisfy Provisions

- (a) for a building greater than 25 m in *effective height*, Grade 1, except that a secondary water supply storage capacity of 25,000 litres may be used if—
 - (i) the storage tank is located at the topmost *storey* of the building; and
 - (ii) the building occupancy is classified as no more hazardous than Ordinary Hazard 2 (OH2) under AS 2118.1; and
 - (iii) an operational *fire brigade* service is available to attend a building fire; and
- (b) for a building not greater than 25 m in *effective height*, at least Grade 3.

8. Building occupant warning system

A *required* sprinkler system must be connected to and activate a building occupant warning system complying with **Clause 6 of Specification E2.2a**.

9. Connection to other systems

Where a smoke hazard management system is installed and is actuated by smoke detectors, the sprinkler system must, wherever practicable, be arranged to also activate the smoke hazard management system.

10. Anti-tamper devices

Where a sprinkler system is installed in a theatre, public hall or the like, any valves provided to control sprinklers over any *stage* area must be fitted with anti-tamper devices connected to a monitoring panel at the location normally used by the *stage* manager.

11. Sprinkler systems in carparks

The sprinkler system protecting a *carpark* complying with **Table 3.9 of Specification C1.1** in a multiclassified building must—

- (a) be independent of the sprinkler system protecting any part of the building not used as a *carpark*; or
- (b) if forming part of a sprinkler system protecting a part of the building not used as a *carpark*, be designed such that the section protecting the non-*carpark* part can be isolated without interrupting the water supply or otherwise affecting the effective operation of the section protecting the *carpark*.

12. Class 9c aged care buildings

In addition to the provisions of AS 2118.4, a sprinkler system in a Class 9c *aged care building* must—

- (a) be provided with a monitored main stop valve in accordance with AS 2118.1; and
- (b) be permanently connected with a direct data link or other approved monitoring system to a fire station or fire station dispatch centre.

SPECIFICATION **E1.8** FIRE CONTROL CENTRES

Deemed-to-Satisfy Provisions

1. Scope

This Specification describes the construction and content of *required* fire control centres and rooms. A fire control room is a fire control centre in a dedicated room with additional specific requirements. Clauses 2 to 5 apply to fire control centres (including fire control rooms). Clauses 6 to 12 apply additional requirements to fire control rooms.

2. Purpose and content

A fire control centre must—

- (a) provide an area from which fire-fighting operations or other emergency procedures can be directed or controlled; and
- (b) contain controls, panels, telephones, furniture, equipment and the like associated with the *required* fire services in the building; and
- (c) not be used for any purpose other than the control of—
 - (i) fire-fighting activities; and
 - (ii) other measures concerning the occupant safety or security.

3. Location of fire control centre

A fire control centre must be so located in a building that egress from any part of its floor, to a public road or *open space*, does not involve changes in level which in aggregate exceed 300 mm.

4. Equipment not permitted within a fire control centre

An internal combustion engine, pumps, sprinkler control valves, pipes and pipe fittings must not be located in a fire control centre, but may be located in rooms accessed through the fire control centre.

5. Ambient sound level for a fire control centre

- (a) The ambient sound level within the fire control centre measured when all fire safety equipment is operating in the manner in which it operates in an emergency must not exceed 65 dB(A).
- (b) The measurement must be taken for a sufficient time to characterize the effects of all sound sources. Where there is not a great variation in noise level, a measurement time of 60 seconds may be used.

6. Construction of a fire control room

A fire control centre in a building more than 50 m in *effective height* must be in a separate room where—

Deemed-to-Satisfy Provisions

- (a) the enclosing construction is of concrete, masonry or the like, sufficiently impact resistant to withstand the impact of any likely falling debris, and with an FRL of not less than 120/120/120; and
- (b) any material used as a finish, surface, lining or the like within the room complies with the requirements of **Specification C1.10** or **Specification C1.10a** for fire-isolated *exits*; and
- (c) services, pipes, ducts and the like that are not directly *required* for the proper functioning of the fire control room do not pass through it; and
- (d) openings in the walls, floors or ceiling which separate the room from the interior of the building are confined to doorways, ventilation and other openings for services necessary for the proper functioning of the facility.

7. Protection of openings in a fire control room

Openings permitted by **Clause 6** must be protected as follows:

- (a) Openings for *windows*, doorways, ventilation, service pipes, conduits and the like, in an *external wall* of the building that faces a public road or *open space*, must be protected in accordance with the *Deemed-to-Satisfy Provisions* of **Part C3**.
- (b) Openings in the floors, ceilings and *internal walls* enclosing a fire control room must, except for doorways, be protected in accordance with the *Deemed-to-Satisfy Provisions* of **Part C3**.
- (c) A door opening in the *internal walls* enclosing a fire-control room, must be fitted with a *self closing* –/120/30 smoke sealed fire door.
- (d) Openings associated with natural or mechanical ventilation must—
 - (i) not be made in any ceiling or floor immediately above or below the fire control room; and
 - (ii) be protected by a –/120/– fire damper if the opening is for a duct through a wall *required* to have an FRL, other than an *external wall*.

8. Doors to a fire control room

- (a) *Required* doors to a fire control room must open into the room, be lockable and located so that persons using escape routes from the building will not obstruct or hinder access to the room.
- (b) The fire control room must be accessible via two paths of travel—
 - (i) one from the front entrance of the building; and
 - (ii) one direct from a public place or *fire-isolated passageway* which leads to a public place and has a door with an FRL of not less than –/120/30.

9. Size and contents of a fire control room

- (a) A fire control room must contain—
 - (i) a Fire Indicator Panel and necessary control switches and visual status indication for all *required* fire pumps, smoke control fans and other *required* fire safety equipment installed in the building; and
 - (ii) a telephone directly connected to an external telephone exchange; and

Deemed-to-Satisfy Provisions

- (iii) a blackboard or whiteboard not less than 1200 mm wide x 1000 mm high; and
 - (iv) a pin-up board not less than 1200 mm wide x 1000 mm high; and
 - (v) a raked plan layout table of a size suitable for laying out the plans provided under **(vi)**; and
 - (vi) colour-coded, durable, tactical fire plans.
- (b) In addition, a fire control room may contain—
- (i) master emergency control panels, lift annunciator panels, remote switching controls for gas or electrical supplies and emergency generator backup; and
 - (ii) building security, surveillance and management systems if they are completely segregated from all other systems.
- (c) A fire control room must—
- (i) have a *floor area* of not less than 10 m² and the length of any internal side must be not less than 2.5 m; and
 - (ii) if only the minimum prescribed equipment is installed — have a net *floor area* of not less than 8 m² with a clear space of not less than 1.5 m² in front of the Fire Indicator Panel; and
 - (iii) if additional equipment is installed — have an additional area of not less than 2 m² net *floor area* for each additional facility and a clear space of not less than 1.5 m² in front of each additional control or indicator panel,

and the area *required* for any path of travel through the room to other areas must be provided in addition to the requirements **(ii)** and **(iii)**.

10. Ventilation and power supply for a fire control room

A fire control room must be ventilated by—

- (a) natural ventilation from a *window* or doorway in an *external wall* of the building which opens directly into the fire control room from a roadway or *open space*; or
- (b) a pressurisation system that only serves the fire control room, and—
 - (i) is installed in accordance with AS/NZS 1668.1 as though the room is a *fire-isolated stairway*; and
 - (ii) is activated *automatically* by operation of the fire alarm, or sprinkler system complying with **Specification E1.5**, installed in the building and manually by an over-riding control in the room; and
 - (iii) provides a flow of fresh air through the room of not less than 30 air changes per hour when the system is operating and any door to the room is open; and
 - (iv) has fans, motors and ductwork that form part of the system but not contained within the fire control room protected by enclosing construction with an FRL of not less than 120/120/120; and
 - (v) has any electrical supply to the fire control room or equipment necessary for its operation connected to the supply side of the main disconnection switch for the building,

Deemed-to-Satisfy Provisions

and no openable devices other than necessary doorways, pressure controlled relief louvres and *windows* that are openable by a key, must be constructed in the fire control room.

11. Sign for a fire control room

The external face of the door to the fire control room must have a sign with the words—

FIRE CONTROL ROOM

in letters of not less than 50 mm high and of a colour which contrasts with that of the background.

12. Lighting for a fire control room

Emergency lighting in accordance with the *Deemed-to-Satisfy Provisions* of **Part E4** must be provided in a fire control room, except that an illumination level of not less than 400 lux must be maintained at the surface of the plan table.

PART E2

SMOKE HAZARD MANAGEMENT

OBJECTIVE

EO2

The *Objective* of this Part is to—

- (a) safeguard occupants from illness or injury by warning them of a fire so that they may safely evacuate; and
- (b) safeguard occupants from illness or injury while evacuating during a fire.

FUNCTIONAL STATEMENT

EF2.1

A building is to be provided with safeguards so that—

- (a) occupants are warned of a fire in the building so that they may safely evacuate; and
- (b) occupants have time to safely evacuate before the environment in any *evacuation route* becomes untenable from the effects of fire.

PERFORMANCE REQUIREMENTS

EP2.1

In a building providing sleeping accommodation, occupants must be provided with *automatic* warning on the detection of smoke so they may evacuate in the event of a fire to a *safe place*.

Application:

EP2.1 only applies to a Class 2, 3, 9a or 9c building or Class 4 part.

EP2.2

- (a) In the event of a fire in a building the conditions in any *evacuation route* must be maintained for the period of time occupants take to evacuate the part of the building so that—
 - (i) the temperature will not endanger human life; and
 - (ii) the level of visibility will enable the *evacuation route* to be determined; and
 - (iii) the level of toxicity will not endanger human life.

- (b) The period of time occupants take to evacuate referred to in (a) must be appropriate to—
- (i) the number, mobility and other characteristics of the occupants; and
 - (ii) the function or use of the building; and
 - (iii) the travel distance and other characteristics of the building; and
 - (iv) the *fire load*; and
 - (v) the potential *fire intensity*; and
 - (vi) the *fire hazard*; and
 - (vii) any active *fire safety systems* installed in the building; and
 - (viii) *fire brigade* intervention.

Limitation:

EP2.2 does not apply to an *open-deck carpark* or *open spectator stand*.

PART E2

SMOKE HAZARD MANAGEMENT

Deemed-to-Satisfy Provisions

E2.0 Deemed-to-Satisfy Provisions

- (a) Where a *Building Solution* is proposed to comply with the *Deemed-to-Satisfy Provisions, Performance Requirements EP2.1 to EP2.2* are satisfied by complying with—
- (i) **E2.1 to E2.3**; and
 - (ii) in a building containing an *atrium*, **Part G3**.
- (b) Where a *Building Solution* is proposed as an *Alternative Solution* to the *Deemed-to-Satisfy Provisions* of—
- (i) **E2.1 to E2.3**; and
 - (ii) in a building containing an *atrium*, **Part G3**,
- the relevant *Performance Requirements* must be determined in accordance with **A0.10**.

E2.1 Application of Part

- (a) The *Deemed-to-Satisfy Provisions* of this Part do not apply to any *open deck carpark* or *open spectator stand*.
- (b) The smoke exhaust and *smoke-and-heat vent* provisions of this Part do not apply to any area not used by occupants for an extended period of time such as a storeroom with a floor area less than 30 m², *sanitary compartment*, plant room or the like.

E2.2 General requirements

- (a) A building must comply with **(b), (c), (d)** and—
- (i) **Table E2.2a** as applicable to Class 2 to 9 buildings such that each separate part complies with the relevant provisions for the classification; and
 - (ii) **Table E2.2b** as applicable to Class 6 and 9b buildings such that each separate part complies with the relevant provisions for the classification.
- (b) An air-handling system which does not form part of a smoke hazard management system in accordance with **Table E2.2a** or **Table E2.2b** and which recycles air from one *fire compartment* to another *fire compartment* or operates in a manner that may unduly contribute to the spread of smoke from one *fire compartment* to another *fire compartment* must—
- (i) be designed and installed to operate as a smoke control system in accordance with AS/NZS 1668.1; or
 - (ii)
 - (A) incorporate smoke dampers where the air-handling ducts penetrate any elements separating the *fire compartments* served; and
 - (B) be arranged such that the air-handling system is shut down and the smoke dampers are activated to close *automatically* by smoke detectors complying with Clause 4.10 of AS/NZS 1668.1; and

Deemed-to-Satisfy Provisions

for the purposes of this provision, each *sole-occupancy unit* in a Class 2 or 3 building is treated as a separate *fire compartment*.

- (c) Miscellaneous air-handling systems covered by Sections 5 and 11 of AS/NZS 1668.1 serving more than one *fire compartment* (other than a *carpark* ventilation system) and not forming part of a smoke hazard management system must comply with that Section of the Standard.
- (d) A smoke detection system must be installed in accordance with **Clause 5 of Specification E2.2a** to operate AS/NZS 1668.1 systems that are provided for zone smoke control and *automatic* air pressurisation for fire-isolated *exits*.

E2.3 Provision for special hazards

Additional smoke hazard management measures may be necessary due to the—

- (a) special characteristics of the building; or
- (b) special function or use of the building; or
- (c) special type or quantity of materials stored, displayed or used in a building; or
- (d) special mix of classifications within a building or *fire compartment*,

which are not addressed in **Tables E2.2a** and **E2.2b**.

Table E2.2a GENERAL PROVISIONS

FIRE-ISOLATED EXITS	
A <i>required</i> —	
(a)	<i>fire-isolated stairway</i> , including any associated <i>fire-isolated passageway</i> or <i>fire-isolated ramp</i> serving—
(i)	any <i>storey</i> above an <i>effective height</i> of 25 m; or
(ii)	more than 2 below ground <i>storeys</i> , not counted in the <i>rise in storeys</i> in accordance with C1.2 ; or
(iii)	an <i>atrium</i> ; or
(iv)	a Class 9a building with a <i>rise in storeys</i> of more than 2; or
(v)	a Class 9c <i>aged care building</i> with a <i>rise in storeys</i> of more than 2; and
(b)	<i>fire-isolated passageway</i> or <i>fire-isolated ramp</i> with a length of travel more than 60 m to a road or <i>open space</i> ,
must be provided with—	
(c)	an <i>automatic</i> air pressurisation system for fire-isolated <i>exits</i> in accordance with AS/NZS 1668.1; or
(d)	open access ramps or balconies in accordance with D2.5 .
Notes:	
1.	An <i>automatic</i> air pressurisation system for fire-isolated <i>exits</i> applies to the entire <i>exit</i> .
2.	Refer D1.7(d) for pressurisation of a fire-isolated <i>exit</i> having more than 2 access doorways from within the same <i>storey</i> .

Deemed-to-Satisfy Provisions

Table E2.2a GENERAL PROVISIONS — continued

BUILDINGS MORE THAN 25 M IN EFFECTIVE HEIGHT	
CLASS 2 AND 3 BUILDINGS AND CLASS 4 PART OF A BUILDING	
A Class 2 and 3 building or part of a building and Class 4 part of a building must be provided with an <i>automatic</i> smoke detection and alarm system complying with Specification E2.2a .	
Note:	Refer C2.14 for division of <i>public corridors</i> greater than 40 m in length.
CLASS 5, 6, 7b, 8 and 9b BUILDINGS	
A Class 5, 6, 7b, 8 and 9b building or part of a building must be provided with a zone smoke control system in accordance with AS/NZS 1668.1	
Note:	Refer Table E2.2b for Specific Provisions applicable to a Class 6 (in a <i>fire compartment</i> having a <i>floor area</i> of more than 2000 m ²) and 9b building or part of a building.
CLASS 9a BUILDINGS	
A Class 9a building must be provided with—	
(a)	an <i>automatic</i> smoke detection and alarm system complying with Specification E2.2a ; and
(b)	a zone smoke control system in accordance with AS/NZS 1668.1.
Note:	A building more than 25 m in <i>effective height</i> requires a sprinkler system under E1.5 .
BUILDINGS NOT MORE THAN 25 M IN EFFECTIVE HEIGHT	
CLASS 2 AND 3 BUILDINGS AND CLASS 4 PART	
A Class 2 and 3 building or part of a building and Class 4 part of a building—	
(a)	must be provided with an <i>automatic</i> smoke detection and alarm system complying with Specification E2.2a ; and
(b)	where a <i>required fire-isolated stairway</i> serving the Class 2 or 3 parts also serves one or more <i>storeys</i> of Class 5, 6, 7 (other than an <i>open deck carpark</i>), 8 or 9b parts—
(i)	the <i>fire-isolated stairway</i> , including any associated <i>fire-isolated passageway</i> or <i>fire-isolated ramp</i> , must be provided with an <i>automatic</i> air pressurisation system for fire-isolated <i>exits</i> in accordance with AS/NZS 1668.1; or
(ii)	the Class 5, 6, 7 (other than an <i>open deck carpark</i>), 8 and 9b parts must be provided with—
(A)	an <i>automatic</i> smoke detection and alarm system complying with Specification E2.2a ; or
(B)	a sprinkler system complying with Specification E1.5 ; and

Deemed-to-Satisfy Provisions

Table E2.2a GENERAL PROVISIONS — *continued*

(c)	<p>where a <i>required fire-isolated stairway</i> serving the Class 4 part also serves one or more <i>storeys</i> of Class 5, 6, 7 (other than an <i>open deck carpark</i>), 8 or 9b parts—</p> <p>(i) a system complying with (b)(i) or (b)(ii) must be installed; or</p> <p>(ii) a smoke alarm or detector system complying with Specification E2.2a must be provided except that alarms or detectors need only be installed adjacent to each doorway into each <i>fire-isolated stairway</i> (set back horizontally from the doorway by a distance of not more than 1.5 m) to initiate a building occupant warning system for the Class 4 part.</p>
Notes:	
1.	Refer C2.14 for division of <i>public corridors</i> greater than 40 m in length.
2.	Refer Table E2.2b for Specific Provisions applicable to a Class 6 (in a <i>fire compartment</i> having a <i>floor area</i> of more than 2000 m ²) and 9b building or part of a building.
CLASS 5, 6, 7b, 8 and 9b BUILDINGS	
In a—	
(a)	Class 5 or 9b <i>school</i> building or part of a building having a <i>rise in storeys</i> of more than 3; or
(b)	Class 6, 7b, 8 or 9b building (other than a <i>school</i>) or part of a building having a <i>rise in storeys</i> of more than 2; or
(c)	building having a <i>rise in storeys</i> of more than 2 and containing—
(i)	a Class 5 or 9b <i>school</i> part; and
(ii)	a Class 6, 7b, 8 or 9b (other than a <i>school</i>) part,
the building must be provided with—	
(d)	in each <i>required fire-isolated stairway</i> , including any associated <i>fire-isolated passageway</i> or <i>fire-isolated ramp</i> , an <i>automatic</i> air pressurisation system for fire-isolated <i>exits</i> in accordance with AS/NZS 1668.1; or
(e)	a zone smoke control system in accordance with AS/NZS 1668.1, if the building has more than one <i>fire compartment</i> ; or
(f)	an <i>automatic</i> smoke detection and alarm system complying with Specification E2.2a ; or
(g)	a sprinkler system complying with Specification E1.5 .
Notes:	
1.	Refer Table E2.2b for Specific Provisions applicable to a Class 6 (in a <i>fire compartment</i> having a <i>floor area</i> of more than 2000 m ²) and 9b building or part of a building.
2.	Refer provisions under Class 2 and 3 buildings and Class 4 part in this Table where a Class 5, 6, 7b, 8 and 9b building contains a Class 2, 3 or 4 part.
3.	Reference to "the building" being provided with specified measures, means to the nominated classes within the building. For parts of the building of other classes, see other parts of this Table.

Deemed-to-Satisfy Provisions

Table E2.2a GENERAL PROVISIONS — continued

CLASS 9a and 9c BUILDINGS	
<p>A Class 9a <i>health-care building</i> or a Class 9c <i>aged care building</i>, or a building containing a part thereof, must be provided throughout with—</p>	
<p>(a)</p>	<p>an <i>automatic</i> smoke detection and alarm system complying with Specification E2.2a; and</p>
<p>(b)</p>	<p><i>automatic</i> shutdown of any air-handling system which does not form part of a zone smoke control system (other than individual room units with a capacity not more than 1000 L/s, systems serving critical treatment areas and miscellaneous exhaust air systems installed in accordance with Sections 5 and 11 of AS/NZS 1668.1) on the activation of—</p> <p>(i) smoke detectors installed in accordance with (a); and</p> <p>(ii) any other installed fire detection and alarm system including a sprinkler system complying with Specification E1.5; and</p>
<p>(c)</p>	<p>in a building having a <i>rise in storeys</i> of more than 2 and not more than 25 m <i>effective height</i> (not being a Class 9c <i>aged care building</i>)—</p> <p>(i) a zone smoke control system in accordance with AS/NZS 1668.1; or</p> <p>(ii) a sprinkler system complying with Specification E1.5 throughout with residential sprinkler heads in <i>patient care areas</i>.</p>
<p>Note:</p>	<p>Refer to Clause 2 of Specification C2.5 for the provisions for smoke dampers.</p>
CLASS 7a BUILDINGS	
<p>A Class 7a building, including a basement, provided with a mechanical ventilation system in accordance with AS 1668.2 must comply with Clause 5.5 of AS/NZS 1668.1 except that—</p>	
<p>(a)</p>	<p>fans with metal blades suitable for operation at normal temperature may be used; and</p>
<p>(b)</p>	<p>the electrical power and control cabling need not be fire rated.</p>
BASEMENTS (other than Class 7a buildings)	
<p>A basement, not counted in the <i>rise in storeys</i> in accordance with C1.2, must—</p>	
<p>(a)</p>	<p>comply with measures in accordance with this Table applicable to the building generally; and</p>
<p>(b)</p>	<p>where the basement has a total <i>floor area</i> of more than 2000 m², be provided with—</p> <p>(i) if not more than 2 below ground <i>storeys</i>—</p> <p style="margin-left: 20px;">(A) a zone smoke control system in accordance with AS/NZS 1668.1, if the basement has more than one <i>fire compartment</i>; or</p> <p style="margin-left: 20px;">(B) an <i>automatic</i> smoke detection and alarm system complying with Specification E2.2a; or</p> <p style="margin-left: 20px;">(C) a sprinkler system complying with Specification E1.5; or</p> <p>(ii) if more than 2 below ground <i>storeys</i>, a sprinkler system complying with Specification E1.5.</p>

Deemed-to-Satisfy Provisions

Table E2.2a GENERAL PROVISIONS — *continued*

Notes:	
1.	Refer Table E2.2b for Specific Provisions applicable to a Class 6 (in a <i>fire compartment</i> having a <i>floor area</i> of more than 2000 m ²) and 9b building or part of a building.
2.	Basements with more than 3 below ground <i>storeys</i> or containing Class 6 or 9b occupancies with a large number of occupants may require special consideration in accordance with E2.3 .
ATRIUMS	
Refer Part G3 .	

NSW Table E2.2b

Table E2.2b SPECIFIC PROVISIONS

CLASS 6 BUILDINGS IN FIRE COMPARTMENTS MORE THAN 2000 m²
CLASS 6 BUILDINGS (not containing an enclosed common walkway or mall serving more than one Class 6 <i>sole-occupancy unit</i>)
<p>(a) Where the <i>floor area</i> of a Class 6 part of a <i>fire compartment</i> is more than 2000 m², the <i>fire compartment</i>, must be provided with—</p> <ul style="list-style-type: none"> (i) an <i>automatic</i> smoke exhaust system complying with Specification E2.2b; or (ii) <i>automatic smoke-and-heat vents</i> complying with Specification E2.2c, if the building is single <i>storey</i>; or (iii) if the <i>floor area</i> of the <i>fire compartment</i> is not more than 3500 m² and the building— <ul style="list-style-type: none"> (A) is single <i>storey</i>, an <i>automatic</i> smoke detection and alarm system complying with Specification E2.2a; or (B) has a <i>rise in storeys</i> of not more than 2, a sprinkler system complying with Specification E1.5. <p>(b) The provisions of (a) do not apply to—</p> <ul style="list-style-type: none"> (i) a Class 6 <i>sole-occupancy unit</i> that— <ul style="list-style-type: none"> (A) has a <i>floor area</i> of not more than 2000 m²; and (B) is single <i>storey</i> with a main public entrance opening to a road or <i>open space</i>; and (C) is separated from other parts of the <i>fire compartment</i> by construction, including openings, penetrations and junctions with other building elements, that prevents the free passage of smoke; and (ii) parts of any other classification that are smoke separated from a Class 6 part by construction complying with (i)(C).

Deemed-to-Satisfy Provisions

Table E2.2b SPECIFIC PROVISIONS — *continued*

CLASS 6 BUILDINGS (containing an enclosed common walkway or mall serving more than one Class 6 sole-occupancy unit)
<p>(a) Where the <i>floor area</i> of a Class 6 part of a <i>fire compartment</i> is more than 2000 m², the <i>fire compartment</i>, including the enclosed common walkway or mall, must be provided with—</p> <ul style="list-style-type: none"> (i) an <i>automatic</i> smoke exhaust system complying with Specification E2.2b; or (ii) <i>automatic smoke-and-heat vents</i> complying with Specification E2.2c, if the building is single <i>storey</i>; or (iii) if the <i>floor area</i> of the <i>fire compartment</i> is not more than 3500 m² and the building has a <i>rise in storeys</i> of not more than 2, a sprinkler system complying with Specification E1.5. <p>(b) The provisions of (a) do not apply to—</p> <ul style="list-style-type: none"> (i) a Class 6 <i>sole-occupancy unit</i> that— <ul style="list-style-type: none"> (A) opens onto the enclosed common walkway or mall if the Class 6 <i>sole-occupancy unit</i> has a <i>floor area</i> of not more than 1000 m²; or (B) does not open onto the enclosed common walkway or mall if the Class 6 <i>sole-occupancy unit</i>— <ul style="list-style-type: none"> (aa) has a <i>floor area</i> of not more than 2000 m²; and (bb) is single <i>storey</i> with a main entrance opening to a road or <i>open space</i>; and (cc) is separated from other parts of the <i>fire compartment</i> by construction, including openings, penetrations and junctions with other building elements, that prevents the free passage of smoke; and (ii) parts of any other classification that are smoke separated from a Class 6 part by construction complying with (i)(B)(cc).
<p>Note: A <i>fire compartment</i> having a <i>floor area</i> of more than 3500 m² in a Class 6 building requires a sprinkler system under E1.5.</p>
CLASS 9b ASSEMBLY BUILDINGS
NIGHTCLUBS and DISCOTHEQUES AND THE LIKE
<p>A building or part of a building used as a nightclub, discotheque or the like must be provided with—</p> <p>(a) <i>automatic</i> shutdown of any air-handling system (other than miscellaneous exhaust air systems installed in accordance with Sections 5 and 11 of AS/NZS 1668.1) which does not form part of the smoke hazard management system, on the activation of—</p> <ul style="list-style-type: none"> (i) smoke detectors installed complying with Clause 5 of Specification E2.2a; and (ii) any other installed fire detection and alarm system, including a sprinkler system complying with Specification E1.5; and

Deemed-to-Satisfy Provisions

Table E2.2b SPECIFIC PROVISIONS — *continued*

<p>(b) (i) an <i>automatic</i> smoke exhaust system complying with Specification E2.2b; or</p> <p>(ii) <i>automatic smoke-and-heat vents</i> complying with Specification E2.2c, if the building is single <i>storey</i>; or</p> <p>(iii) a sprinkler system complying with Specification E1.5 with fast response sprinkler heads.</p>
EXHIBITION HALLS
<p>A building or part of a building used as an exhibition hall must be provided with—</p> <p>(a) <i>automatic</i> shutdown of any air-handling system (other than miscellaneous exhaust air systems installed in accordance with Sections 5 and 11 of AS/NZS 1668.1) which does not form part of the smoke hazard management system, on the activation of—</p> <p>(i) smoke detectors installed complying with Specification E2.2a; and</p> <p>(ii) any other installed fire detection and alarm system, including a sprinkler system complying with Specification E1.5; and</p> <p>(b) where the <i>floor area</i> is more than 2000 m² and not more than 3500 m²—</p> <p>(i) an <i>automatic</i> smoke exhaust system complying with Specification E2.2b; or</p> <p>(ii) <i>automatic smoke-and-heat vents</i> complying with Specification E2.2c, if the building is single <i>storey</i>; or</p> <p>(iii) a sprinkler system complying with Specification E1.5; and</p> <p>(c) where the <i>floor area</i> is more than 3500 m², a sprinkler system complying with Specification E1.5 and—</p> <p>(i) an <i>automatic</i> smoke exhaust system complying with Specification E2.2b; or</p> <p>(ii) <i>automatic smoke-and-heat vents</i> complying with Specification E2.2c, if the building is single <i>storey</i>.</p>
THEATRES and PUBLIC HALLS
<p>A building or part of a building used as a theatre or public hall which—</p> <p>(a) is a <i>school</i> assembly, church or community hall, and has a <i>stage</i> and any <i>backstage</i> area with a total <i>floor area</i> of more than 300 m²; or</p> <p>(b) is not a <i>school</i> assembly, church or community hall, and has a <i>stage</i> and any <i>backstage</i> area with a total <i>floor area</i> of more than 200 m²; or</p> <p>(c) has a <i>stage</i> with an associated rigging loft—</p> <p>must be provided with—</p> <p>(i) an <i>automatic</i> smoke exhaust system complying with Specification E2.2b; or</p> <p>(ii) <i>automatic smoke-and-heat vents</i> complying with Specification E2.2c, if the building is single <i>storey</i>.</p>

Deemed-to-Satisfy Provisions

Table E2.2b SPECIFIC PROVISIONS — *continued*

THEATRES and PUBLIC HALLS (not listed above) INCLUDING LECTURE THEATRES AND CINEMA/AUDITORIUM COMPLEXES
<p>A building or part of a building used as a theatre or public hall (not listed above) including a lecture theatre and cinema/auditorium complex—</p> <p>(a) must be provided with <i>automatic</i> shutdown of any air-handling system (other than miscellaneous exhaust air systems installed in accordance with Sections 5 and 11 of AS/NZS 1668.1) which does not form part of the smoke hazard management system, on the activation of—</p> <ul style="list-style-type: none"> (i) smoke detectors installed complying with Specification E2.2a; and (ii) any other installed fire detection and alarm system, including a sprinkler system complying with Specification E1.5; and <p>(b) other than in the case of a <i>school</i> lecture theatre, where the <i>floor area</i> of the <i>fire compartment</i> is more than 2000 m²—</p> <ul style="list-style-type: none"> (i) an <i>automatic</i> smoke exhaust system complying with Specification E2.2b; or (ii) <i>automatic smoke-and-heat vents</i> complying with Specification E2.2c, if the building is single <i>storey</i>; or (iii) if the floor area of the <i>fire compartment</i> is not more than 5000 m² and the building has a <i>rise in storeys</i> of not more than 2— <ul style="list-style-type: none"> (A) an <i>automatic</i> smoke detection and alarm system complying with Specification E2.2a; or (B) a sprinkler system complying with Specification E1.5.
OTHER ASSEMBLY BUILDINGS (not listed above) and EXCLUDING SCHOOLS
<p>(a) Each <i>fire compartment</i>, other than one in a building described in (b), having a <i>floor area</i> of more than 2000 m² must be provided with—</p> <ul style="list-style-type: none"> (i) an <i>automatic</i> smoke exhaust system complying with Specification E2.2b; or (ii) <i>automatic smoke-and-heat vents</i> complying with Specification E2.2c, if the building is single <i>storey</i>; or (iii) if the <i>floor area</i> of the <i>fire compartment</i> is not more than 5000 m² and the building has a <i>rise in storeys</i> of not more than 2— <ul style="list-style-type: none"> (A) an <i>automatic</i> smoke detection and alarm system complying with Specification E2.2a; or (B) a sprinkler system complying with Specification E1.5. <p>(b) The following buildings are exempt from the provisions of (a):</p> <ul style="list-style-type: none"> (i) Sporting complexes (including sports halls, gymnasiums, <i>swimming pools</i>, ice and roller rinks, and the like) other than an indoor sports stadium with a total spectator seating for more than 1000. (ii) Churches and other places used solely for religious worship.

SPECIFICATION **E2.2a** SMOKE DETECTION AND ALARM SYSTEMS

Deemed-to-Satisfy Provisions

1. Scope

This Specification describes the installation and operation of *automatic* smoke detection and alarm systems.

2. Type of system

A *required automatic* smoke detection and alarm system must comply with the following:

- (a) **Class 2 and 3 buildings and Class 4 parts of a building:**
 - (i) Subject to (ii), a Class 2 and 3 building and Class 4 part of a building must be provided with—
 - (A) a smoke alarm system complying with **Clause 3**; or
 - (B) a smoke detection system complying with **Clause 4**; or
 - (C) a combination of a smoke alarm system complying with **Clause 3** within *sole-occupancy units* and a smoke detection system complying with **Clause 4** in areas not within the *sole-occupancy units*.
 - (ii) A Class 3 building must be provided with a smoke detection system complying with **Clause 4** if it—
 - (A) has a Class 3 part located more than 2 *storeys* above ground level; or
 - (B) accommodates more than 20 residents and is used as a residential part of a *school* or accommodation for the aged, children or people with disabilities.
- (b) **Class 5, 6, 7, 8 and 9b buildings:** A smoke detection system complying with **Clause 4**.
- (c) **Class 9a health-care building:**
 - (i) Where 6 or less bed patients are accommodated—
 - (A) a smoke alarm system complying with **Clause 3**; or
 - (B) a smoke detection system complying with **Clause 4**.
 - (ii) Where more than 6 bed patients are accommodated, a smoke detection system complying with **Clause 4**.
- (d) **Class 9c aged care building:** A smoke detection system complying with **Clause 4**.

3. Smoke alarm system

- (a) A smoke alarm system must—
 - (i) consist of smoke alarms complying with AS 3786; and
 - (ii) be powered from the consumers mains source.
- (b) In kitchens and other areas where the use of the area is likely to result in smoke alarms causing spurious signals—

Deemed-to-Satisfy Provisions

- (i) any other detector deemed suitable in accordance with AS 1670.1 may be installed provided that smoke detectors are installed elsewhere in the *sole-occupancy unit* in accordance with **Clause 3(c)(i)**; or
- (ii) an alarm acknowledgement facility may be installed,
except where the kitchen or other area is sprinklered, the detectors need not be installed in the kitchen or other areas likely to result in spurious signals.
- (c) In a Class 2 or 3 building or Class 4 part of a building, smoke alarms must be installed—
 - (i) within each *sole-occupancy unit*, located on or near the ceiling in any *storey*—
 - (A) containing bedrooms—
 - (aa) between each part of the *sole-occupancy unit* containing bedrooms and the remainder of the *sole-occupancy unit*; and
 - (bb) where bedrooms are served by a hallway, in that hallway; and
 - (B) not containing any bedrooms, in egress paths; and
 - (ii) in a building not protected with a sprinkler system, in *public corridors* and other internal public spaces, located in accordance with the requirements for smoke detectors in AS 1670.1 and connected to activate a building occupant warning system in accordance with **Clause 6**; and
- (d) In a Class 9a building, smoke alarms must be installed in every room, *public corridor* and other internal public spaces and—
 - (i) be located in accordance with the requirements for smoke detectors in AS 1670.1 and interconnected to provide a common alarm; and
 - (ii) have manual call points installed in *evacuation routes* so that no point on a floor is more than 30 m from a manual call point.

4. Smoke detection system

- (a) A smoke detection system must—
 - (i) subject to **(c)** and **(d)**, comply with AS 1670.1 except for the provisions of—
 - (A) Clause 3.26(f); and
 - (B) * * * * *
 - (C) * * * * *
 - (ii) activate a building occupant warning system in accordance with **Clause 6**.
- (b) In kitchens and other areas where the use of the area is likely to result in smoke detectors causing spurious signals—
 - (i) any other detector deemed suitable in accordance with AS 1670.1 may be installed provided that smoke detectors are installed elsewhere in the *sole-occupancy unit* in accordance with **Clause 3(c)(i)**; or
 - (ii) an alarm acknowledgement facility may be installed,
except where the kitchen or other area is sprinklered, the detectors need not be installed in the kitchen or other areas likely to result in spurious signals.

Deemed-to-Satisfy Provisions

- (c) In a Class 2 or 3 building or Class 4 part of a building smoke detectors must be installed—
 - (i) within each *sole-occupancy unit*, located in accordance with the requirements for smoke alarms in **Clause 3(c)(i)**; and
 - (ii) in a building not protected with a sprinkler system, in *public corridors* and other internal public spaces.
- (d) In a Class 9a *health-care building*—
 - (i)
 - (A) photoelectric type smoke detectors must be installed in *patient care areas* and alternate photoelectric and ionisation detectors must be installed in paths of travel to *exits* from *patient care areas*; and
 - (B) in areas other than *patient care areas* and paths of travel to *exits* from *patient care areas*, where the use of the area is likely to result in smoke detectors causing spurious signals, any other detector deemed suitable in accordance with AS 1670.1 may be installed in lieu of smoke detectors, except that the detectors need not be installed if the area is sprinklered; and
 - (ii) manual call points must be installed in *evacuation routes* so that no point on a floor is more than 30 m from a manual call point.

Vic Spec E2.2a 4(e)

- (e) In a Class 9c *aged care building*—
 - (i) remote automatic indication of each zone must be given in each smoke compartment by means of—
 - (A) mimic panels with an illuminated display; or
 - (B) annunciator panels with alpha numeric display; and
 - (ii) if the building accommodates more than 20 residents, manual call points must be installed in paths of travel so that no point on a floor is more than 30 m from a manual call point.

5. Smoke detection for smoke control systems

- (a) Smoke detectors *required* to activate air pressurisation systems for fire-isolated *exits* and zone smoke control systems must—
 - (i) be installed in accordance with AS/NZS 1668.1; and
 - (ii) have additional smoke detectors installed adjacent to each bank of lift landing doors set back horizontally from the door openings by a distance of not more than 3 m.
- (b) Smoke detectors *required* to activate—
 - (i) *automatic* shutdown of air-handling systems in accordance with **Table E2.2b**; or
 - (ii) a smoke exhaust system in accordance with **Specification E2.2b**,
must—
 - (iii) be spaced—

Deemed-to-Satisfy Provisions

- (A) not more than 20 m apart and not more than 10 m from any wall, bulkhead or smoke curtain; and
- (B) in enclosed malls and walkways in a Class 6 building not more than 15 m apart and not more than 7.5 m from any wall, bulkhead or curtain; and
- (iv) have a sensitivity—
 - (A) in accordance with AS/NZS 1668.1 in areas other than a multi-storey walkway and mall in a Class 6 building; and
 - (B) not exceeding 0.5% smoke obscuration per metre with compensation for external airborne contamination as necessary, in a multi-storey walkway and mall in a Class 6 building.
- (c) Smoke detectors provided to activate a smoke control system must—
 - (i)
 - (A) form part of a building fire or smoke detection system complying with AS 1670.1; or
 - (B) be a separate dedicated system incorporating control and indicating equipment complying with AS 1670.1; and
 - (ii) activate a building occupant warning system complying with **Clause 6**, except that smoke detectors provided solely to initiate *automatic* shutdown of air-handling systems in accordance with **(b)(i)** need not activate a building occupant warning system.

6. Building occupant warning system

A building occupant warning system must comply with Clause 3.22 of AS 1670.1 to sound through all occupied areas except—

- (a) in a Class 2 and 3 building or Class 4 part of a building provided with a smoke alarm system in accordance with **Clause 3(c)(ii)**—
 - (i) the sound pressure level need not be measured within a *sole-occupancy unit* if a level of not less than 85 dB(A) is provided at the door providing access to the *sole-occupancy unit*; and
 - (ii) the inbuilt sounders of the smoke alarms may be used to wholly or partially meet the requirements; and
- (b) in a Class 2 and 3 building or Class 4 part of a building provided with a smoke detection system in accordance with **Clause 4(c)**, the sound pressure level from a warning system need not be measured within a *sole-occupancy unit* if a level of not less than 100 dB(A) is provided at the door providing access to the *sole-occupancy unit*; and
- (c) in a Class 3 building used as a *residential aged care building*, the system—
 - (i) must be arranged to provide a warning for occupants; and
 - (ii) in areas used by residents, may have its alarm adjusted in volume and content to minimise trauma consistent with the type and condition of residents; and
- (d) in a Class 9a *health-care building*, in a *patient care area*, the system—
 - (i) must be arranged to provide a warning for occupants; and

Deemed-to-Satisfy Provisions

- (ii) in a *ward area*, may have its alarm adjusted in volume and content to minimise trauma consistent with the type and condition of the patients.
- (e) in a Class 9c *aged care building*, the system—
 - (i) must be arranged to provide a warning for occupants; and
 - (ii) must notify staff caring for the residents of the building; and
 - (iii) in areas used by residents, may have its alarm adjusted in volume and content to minimise trauma consistent with the type and condition of resident.

7. System monitoring

The following installations must be connected to a fire alarm monitoring system connected to a fire station or fire station dispatch centre in accordance with AS 1670.3:

- (a) A smoke detection system in a Class 3 building provided in accordance with **Clause 2(a)(ii)**.
- (b) A smoke detection system in a Class 9a *health-care building*, if the building accommodates more than 20 patients.

Vic Spec E2.2a 7(b)

- (c) A smoke detection system in a Class 9c *aged care building*.

Vic Spec E2.2a 7(c)

- (d) Smoke detection in accordance with **Clause 5** provided to activate—
 - (i) a smoke exhaust system in accordance with **Specification E2.2b**; or
 - (ii) *smoke-and-heat vents* in accordance with **Specification E2.2c**.

NSW Spec E2.2a 7(e)

- (e) A fire detection system installed in accordance with **C2.3(a)(i)(A)**.

SPECIFICATION **E2.2b** SMOKE EXHAUST SYSTEMS

Deemed-to-Satisfy Provisions

1. Scope

This Specification describes the requirements for mechanical smoke exhaust systems.

2. Smoke exhaust capacity

- (a) Smoke exhaust fans must have a sufficient capacity to contain the smoke layer—
 - (i) within a smoke reservoir formed in accordance with **Clause 4** and not less than 2 m above the highest floor level; and
 - (ii) above the top of any openings interconnecting different smoke reservoirs.
- (b) Exhaust rates must be determined in accordance with **Figure 2.1**, with the height measurement taken from the lowest floor level to the underside of the smoke layer.

3. Smoke exhaust fans

Each smoke exhaust fan, complete with its drive, flexible connections, control gear and wiring must—

- (a) be constructed and installed so that it is capable of continuous operation (exhausting the *required* volumetric flow rate at the installed system resistance) at a temperature of 200° C for a period of not less than 1 hour; and
- (b) in a building not fitted with a sprinkler system, be capable of continuous operation at a temperature of 300° C for a period of not less than 30 minutes; and
- (c) be rated to handle the *required* volumetric flow rate at ambient temperature to be capable of exhausting cool smoke during the early stages of a fire and to allow routine testing; and
- (d) have any high temperature overload devices installed, *automatically* overridden during the smoke exhaust operation.

Deemed-to-Satisfy Provisions

Figure 2.1

SMOKE EXHAUST RATE

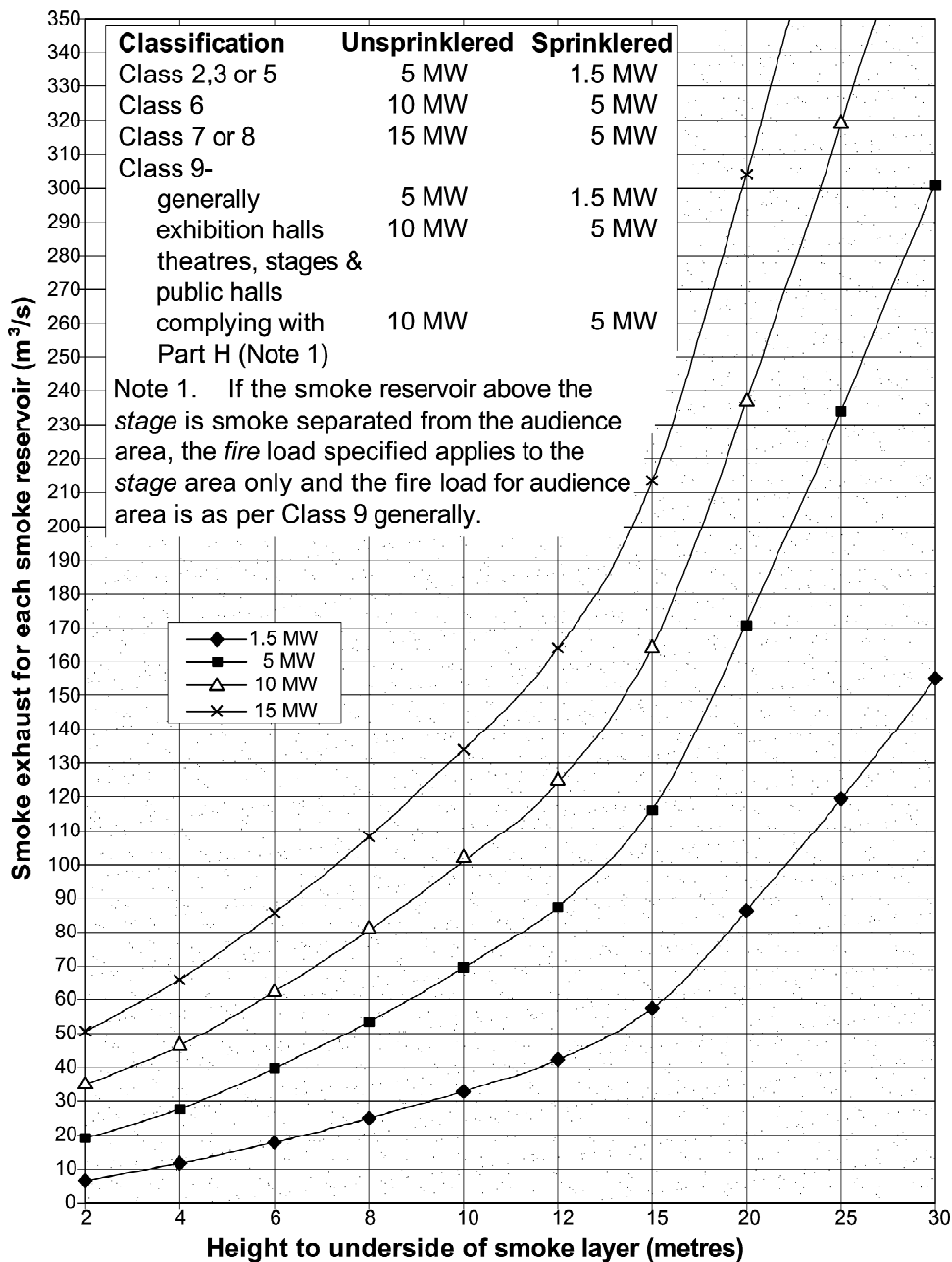

4. Smoke reservoirs

- (a) A *fire compartment* must be divided at ceiling level into smoke reservoirs formed by smoke baffles/curtains of *non-combustible* and non-shatterable construction.

Deemed-to-Satisfy Provisions

- (b) The horizontal area of a smoke reservoir must not exceed 2000 m² and in enclosed walkways and malls of a Class 6 building must not exceed 60 m in length.
- (c) Smoke reservoirs must be of sufficient depth to contain the smoke layer and must not be less than 500 mm below an imperforate ceiling or roof.
- (d)
 - (i) Within a multi-storey fire compartment, a non-combustible bulkhead or smoke baffle/curtain must be provided around the underside of each opening into a building void to minimise the spread of smoke to other storeys.
 - (ii) The depth of the bulkhead or smoke baffle must be not less than the depth of the smoke reservoir provided under (c) plus an additional 400 mm.

5. Smoke exhaust fan and vent location

Smoke exhaust fans and vents must be located—

- (a) such that each smoke reservoir is served by one or more fans with the maximum exhaust rate at any one point limited to avoid extracting air from below the smoke layer; and
- (b) to prevent the formation of stagnant regions resulting in excessive cooling and downward mixing of smoke; and
- (c) at natural collection points for the hot smoky gases within each smoke reservoir having due regard to the ceiling geometry and its effect on the migratory path of the smoke; and
- (d) away from the intersection of walkways or malls; and
- (e) to ensure that any voids containing escalators and/or stairs commonly used by the public are not used as a smoke exhaust path; and
- (f) to discharge directly to outdoor with a velocity of not less than 5 m/s, at a suitable point not less than 6 m from any air intake point or exit.

6. Make-up air

- (a) Low level make-up air must be provided either automatically or via permanent ventilation openings to replace the air exhausted so as to minimise—
 - (i) any disturbance of the smoke layer due to turbulence created by the incoming air; and
 - (ii) the risk of smoke migration to areas remote from the fire due to the effect of make-up air on the air balance of the total system.
- (b) The velocity of make-up air through doorways must not exceed 2.5 m/s.
- (c) Within a multi-storey fire compartment, make-up air must be provided across each vertical opening from a building void to the fire-affected storey at an average velocity of 1 m/s so as to minimise the spread of smoke from the fire-affected storey to other storeys.

7. Smoke exhaust system control

- (a) Each smoke exhaust fan must be activated sequentially by smoke detectors complying with Specification E2.2a and arranged in zones to match the smoke reservoir served by the fan(s).

Deemed-to-Satisfy Provisions

- (b) Subject to (c) and (d), an air handling system (other than individual room units less than 1000 l/s and miscellaneous exhaust air systems installed in accordance with Sections 5 and 11 of AS/NZS 1668.1) which does not form part of the smoke hazard management system must be *automatically* shut down on the activation of the smoke exhaust system.
- (c) In a single *storey fire compartment*, air handling systems in all non fire-affected zones may operate on 100% *outdoor air* to provide make-up air to the fire-affected zone.
- (d) Within a multi-*storey fire compartment*, air handling systems in all non fire-affected zones and *storeys* must operate at 100% *outdoor air* to provide make-up air to the fire-affected *storey* via building voids connecting *storeys*.
- (e) Manual override control and indication together with operating instructions for use by emergency personnel must be provided adjacent to the fire indicator panel in accordance with the requirements of Clauses 4.13 and 4.15 of AS/NZS 1668.1.
- (f) Manual control for the smoke exhaust system must also be provided at a location normally used by the *stage* manager in a theatre.
- (g) Power supply wiring to exhaust fans together with detection, control, and indication circuits (and where necessary to *automatic* make-up air supply arrangements) must comply with AS/NZS 1668.1.

8. Smoke detection

A smoke detection system must be installed in accordance with **Specification E2.2a** to activate the smoke exhaust system.

SPECIFICATION **E2.2c** SMOKE-AND-HEAT VENTS

Deemed-to-Satisfy Provisions

1. Adoption of AS 2665

Automatic smoke-and-heat vents must be installed as a system complying with AS 2665 except that—

- (a) * * * * *
- (b) * * * * *
- (c) permanently open vents may form part of the smoke/heat venting system provided they comply with the relevant criteria for *automatic smoke-and-heat vents* in AS 2665.

2. Controls

Where a *smoke-and-heat vent* system is installed to comply with **Table E2.2b**, the following must apply:

- (a) In addition to thermally released link operation, *smoke-and-heat vents* must also be initiated by smoke detection complying with **Clauses 5** and **7 of Specification E2.2a** and arranged in zones to match the smoke reservoirs.
- (b) * * * * *
- (c) * * * * *

3. * * * * *

PART E3

LIFT INSTALLATIONS

OBJECTIVE

EO3

The *Objective* of this Part is to—

- (a) facilitate the safe movement of occupants; and
- (b) facilitate access for emergency services personnel to carry out emergency procedures and assist in the evacuation of occupants.

FUNCTIONAL STATEMENTS

EF3.1

Where a passenger lift is provided, it is to facilitate safe and easy—

- (a) movement for occupants with disabilities; and
- (b) evacuation of occupants, who due to illness or injury need stretcher assistance.

Application:

EF3.1(b) only applies to a building with an *effective height* of more than 12 m.

EF3.2

A building is to be provided with one or more passenger lifts to facilitate—

- (a) the safe access for emergency services personnel; and
- (b) safe and easy evacuation of occupants who due to illness, injury or disability cannot use stairways in the event of an emergency.

Application:

EF3.2 only applies to—

- (a) a building with an *effective height* of more than 25 m; and
- (b) a Class 9a building in which *patient care areas* are located above a level with direct access to a road or *open space*.

EF3.3

A building having a passenger lift is to be provided with measures to alert occupants when use of the lift is inappropriate.

PERFORMANCE REQUIREMENTS

EP3.1

Stretcher facilities must be provided—

- (a) in at least one emergency lift *required* by **EP3.2**; or
- (b) where an emergency lift is not *required* and a passenger lift is provided, in at least one lift, to serve each floor in the building served by the passenger lift.

Application:

EP3.1(b) only applies to a building with an *effective height* of more than 12 m.

EP3.2

One or more passenger lifts fitted as emergency lifts to serve each floor served by the lifts in a building must be installed to facilitate the activities of the *fire brigade* and other emergency services personnel.

Application:

EP3.2 only applies to—

- (a) a building with an *effective height* of more than 25 m; and
- (b) a Class 9a building in which *patient care areas* are located at a level that does not have direct access to a road or *open space*.

EP3.3

Signs or other means must be provided to warn occupants against the use of a lift during a fire.

EP3.4

When a passenger lift is provided in a building *required* to be *accessible*, it must be suitable for use by occupants with disabilities.

PART E3 LIFT INSTALLATIONS

Deemed-to-Satisfy Provisions

E3.0 Deemed-to-Satisfy Provisions

- (a) Where a *Building Solution* is proposed to comply with the *Deemed-to-Satisfy Provisions, Performance Requirements EP3.1 to EP3.4* are satisfied by complying with **E3.1 to E3.8**.
- (b) Where a *Building Solution* is proposed as an *Alternative Solution* to the *Deemed-to-Satisfy Provisions* of **E3.1 to E3.8**, the relevant *Performance Requirements* must be determined in accordance with **A0.10**.

E3.1 * * * * *

This clause has deliberately been left blank.

E3.2 Stretcher facility in lifts

- (a) A stretcher facility in accordance with **(b)** must be provided—
 - (i) in at least one emergency lift *required* by **E3.4**; or
 - (ii) where an emergency lift is not *required*, if passenger lifts are installed to serve any storey above an *effective height* of 12 m, in at least one of those lifts to serve each floor served by the lifts.
- (b) A stretcher facility must accommodate a raised stretcher with a patient lying on it horizontally by providing a clear space not less than 600 mm wide x 2000 mm long x 1400 mm high above the floor level.

E3.3 Warning against use of lifts in fire

A warning sign must—

- (a) be displayed where it can be readily seen—
 - (i) near every call button for a passenger lift or group of lifts throughout a building; except
 - (ii) a small lift such as a dumb-waiter or the like that is for the transport of goods only; and
- (b) comply with the details and dimensions of **Figure E3.3** and consist of—
 - (i) incised, inlaid or embossed letters on a metal, wood, plastic or similar plate securely and permanently attached to the wall; or
 - (ii) letters incised or inlaid directly into the surface of the material forming the wall.

Deemed-to-Satisfy Provisions

Figure E3.3

WARNING SIGN FOR PASSENGER LIFTS

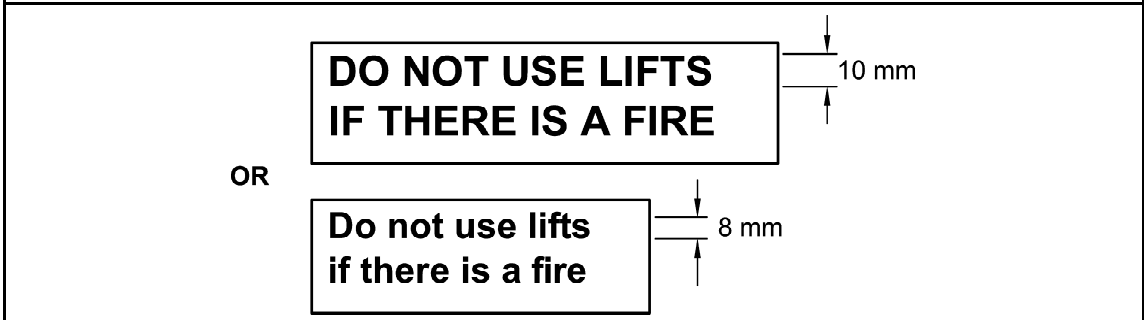

E3.4 Emergency lifts

- (a) At least one emergency lift complying with (e) must be installed in—
 - (i) a building which has an *effective height* of more than 25 m; and
 - (ii) a Class 9a building in which *patient care areas* are located at a level that does not have direct egress to a road or *open space*.
- (b) An emergency lift may be combined with a passenger lift and must serve those *storeys* served by the passenger lift so that all *storeys* of the building served by passenger lifts are served by at least one emergency lift.
- (c) Where two or more passenger lifts are installed and serve the same *storeys*, excluding a lift that is within an *atrium* and not contained wholly within a *shaft*—
 - (i) at least two emergency lifts must be provided to serve those *storeys*; and
 - (ii) if located within different *shafts*, at least one emergency lift must be provided in each *shaft*.
- (d) An emergency lift must be contained within a *fire-resisting shaft* in accordance with the requirements of **C2.10**.
- (e) An emergency lift must—
 - (i) comply with AS 1735.2 or Appendix A of AS 1735.1; and
 - (ii) in a Class 9a building serving a *patient care area*—
 - (A) have minimum dimensions, measured clear of all obstructions, including handrails, etc complying with **Table E3.4**; and
 - (B) be connected to a standby power supply system where installed; and
 - (iii) have a rating of at least 600 kg if the building has an *effective height* of more than 75 m.

Deemed-to-Satisfy Provisions

Table E3.4 MINIMUM EMERGENCY LIFT DIMENSIONS IN CLASS 9a BUILDINGS

Minimum depth of car	2280 mm
Minimum width of car	1600 mm
Minimum floor to ceiling height	2300 mm
Minimum door height	2100 mm
Minimum door width	1300 mm

E3.5 Landings

- (a) The provisions of Clause 12.2— “Access” of AS 1735.2 do not apply.
- (b) Access and egress to and from liftwell landings must comply with the *Deemed-to-Satisfy Provisions* of **Section D**.

E3.6 Facilities for people with disabilities

Where *required* by **D3.3(a)**, every passenger lift must—

- (a) be provided with a handrail complying with the provisions for a mandatory handrail in AS 1735.12; and
- (b) have minimum internal floor dimensions complying with AS 1735.12; and
- (c) have doors with a minimum clear opening complying with AS 1735.12; and
- (d) be fitted with a series of door opening sensory devices which will detect a 75 mm diameter rod across the door opening between 50 mm and 1550 mm above floor level; and
- (e) have car control buttons complying with Section 7 of AS 1735.12.

E3.7 Fire service controls

In passenger lifts designed in accordance with AS 1735 Parts 1 or 2, all lift cars serving any storey above an *effective height* of 12 m must be provided with fire service controls.

E3.8 Aged care buildings

Where residents in a Class 9c *aged care building* are on levels which do not have direct access to a road or *open space*, the building must be provided with either,

- (a) at least one lift to accommodate a stretcher in accordance with **E3.2(b)**; or
- (b) a ramp in accordance with AS 1428.1, and

the lift or ramp must discharge at a level providing direct access to a road or *open space*.

PART E4 EMERGENCY LIGHTING, EXIT SIGNS AND WARNING SYSTEMS

OBJECTIVE

EO4

The *Objective* of this Part is, in an emergency, to safeguard occupants from injury by—

- (a) having adequate lighting; and
- (b) having adequate identification of *exits* and paths of travel to *exits*; and
- (c) being made aware of the emergency.

FUNCTIONAL STATEMENT

EF4.1

A building is to be provided with—

- (a) adequate lighting upon failure of normal artificial lighting during an emergency; and
- (b) adequate means—
 - (i) of warning occupants to evacuate; and
 - (ii) to manage the evacuation process; and
 - (iii) to identify *exits* and paths of travel to an *exit*.

PERFORMANCE REQUIREMENTS

EP4.1

A level of illumination for safe evacuation in an emergency must be provided, to the degree necessary, appropriate to—

- (a) the function or use of the building; and
- (b) the *floor area* of the building; and
- (c) the distance of travel to an *exit*.

Limitation:

EP4.1 does not apply to the internal parts of a *sole-occupancy unit* in a Class 2, 3 or 9c building or Class 4 part of a building.

EP4.2

To facilitate evacuation, suitable signs or other means of identification must, to the degree necessary—

- (a) be provided to identify the location of *exits*; and
- (b) guide occupants to *exits*; and
- (c) be clearly visible to occupants; and
- (d) operate in the event of a power failure of the main lighting system for sufficient time for occupants to safely evacuate.

Limitation:

EP4.2 does not apply to the internal parts of a *sole-occupancy unit* in a Class 2 or 3 building or Class 4 part of a building.

EP4.3

To warn occupants of an emergency and assist evacuation of a building, a sound system and intercom system for emergency purposes must be provided, to the degree necessary, appropriate to—

- (a) the *floor area* of the building; and
- (b) the function or use of the building; and
- (c) the height of the building.

PART E4 EMERGENCY LIGHTING, EXIT SIGNS AND WARNING SYSTEMS

Deemed-to-Satisfy Provisions

E4.0 Deemed-to-Satisfy Provisions

- (a) Where a *Building Solution* is proposed to comply with the *Deemed-to-Satisfy Provisions, Performance Requirements EP4.1 to EP4.3* are satisfied by complying with **E4.1 to E4.9**.
- (b) Where a *Building Solution* is proposed as an *Alternative Solution* to the *Deemed-to-Satisfy Provisions* of **E4.1 to E4.9**, the relevant *Performance Requirements* must be determined in accordance with **A0.10**.

E4.1 * * * * *

This clause has deliberately been left blank.

E4.2 Emergency lighting requirements

An emergency lighting system must be installed—

- (a) in every *fire-isolated stairway, fire-isolated ramp* or *fire-isolated passageway*; and
- (b) in every *storey* of a Class 5, 6, 7, 8 or 9 building where the *storey* has a *floor area* more than 300 m²—
 - (i) in every passageway, corridor, hallway, or the like, that is part of the path of travel to an *exit*; and
 - (ii) in any room having a *floor area* more than 100 m² that does not open to a corridor or space that has emergency lighting or to a road or *open space*; and
 - (iii) in any room having a *floor area* more than 300 m²; and
- (c) in every passageway, corridor, hallway, or the like, having a length of more than 6 m from the entrance doorway of any *sole-occupancy unit* in a Class 2 or 3 building or Class 4 part of a building to the nearest doorway opening directly to—
 - (i) a *fire-isolated stairway, fire-isolated ramp* or *fire-isolated passageway*; or
 - (ii) an external stairway serving instead of a *fire-isolated stairway* under **D1.8**; or
 - (iii) an external balcony leading to a *fire-isolated stairway, fire-isolated ramp* or *fire-isolated passageway*; or
 - (iv) a road or *open space*; and
- (d) in every *required* non *fire-isolated stairway*; and
- (e) in a *sole-occupancy unit* in a Class 5, 6 or 9 building if—
 - (i) the *floor area* of the unit is more than 300 m²; and
 - (ii) an *exit* from the unit does not open to a road or *open space* or to an external stairway, passageway, balcony or ramp, leading directly to a road or *open space*; and

Deemed-to-Satisfy Provisions

- (f) in every room or space to which there is public access in every *storey* in a Class 6 or 9b building if—
 - (i) the *floor area* in that *storey* is more than 300 m²; or
 - (ii) any point on the floor of that *storey* is more than 20 m from the nearest doorway leading directly to a stairway, ramp, passageway, road or *open space*; or
 - (iii) egress from that *storey* involves a vertical rise within the building of more than 1.5 m, or any vertical rise if the *storey* concerned does not admit sufficient light; or
 - (iv) the *storey* provides a path of travel from any other *storey required* by (i), (ii) or (iii) to have emergency lighting; and
- (g) in a Class 9a *health-care building*—
 - (i) in every passageway, corridor, hallway, or the like, serving a *treatment area* or a *ward area*; and
 - (ii) in every room having a *floor area* of more than 120 m² in a *patient care area*; and
- (h) in every Class 9c *aged care building* excluding within *sole-occupancy units*; and
- (i) in every *required* fire control centre.

E4.3 Measurement of distance

Distances, other than vertical rise, must be measured along the shortest path of travel whether by straight lines, curves or a combination of both.

E4.4 Design and operation of emergency lighting

Every *required* emergency lighting system must comply with AS 2293.1.

E4.5 Exit signs

An *exit* sign must be clearly visible to persons approaching the *exit*, and must be installed on, above or adjacent to each—

- (a) door providing direct egress from a *storey* to—
 - (i) an enclosed stairway, passageway or ramp serving as a *required exit*; and
 - (ii) an external stairway, passageway or ramp serving as a *required exit*; and
 - (iii) an external access balcony leading to a *required exit*; and
- (b) door from an enclosed stairway, passageway or ramp at every level of discharge to a road or *open space*; and
- (c) *horizontal exit*; and
- (d) door serving as, or forming part of, a *required exit* in a *storey required* to be provided with emergency lighting in accordance with **E4.2**.

Deemed-to-Satisfy Provisions

E4.6 Direction signs

NSW E4.6

If an *exit* is not readily apparent to persons occupying or visiting the building then *exit* signs must be installed in appropriate positions in corridors, hallways, lobbies, and the like, indicating the direction to a *required exit*.

E4.7 Class 2 and 3 buildings and Class 4 parts: Exemptions

E4.5 does not apply to—

- (a) a Class 2 building in which every door referred to is clearly and legibly labelled on the side remote from the *exit* or balcony—
 - (i) with the word “EXIT” in capital letters 25 mm high in a colour contrasting with that of the background; or
 - (ii) by some other suitable method; and
- (b) an entrance door of a *sole-occupancy unit* in a Class 2 or 3 building or Class 4 part.

E4.8 Design and operation of exit signs

Every *required exit* sign must—

- (a) comply with AS 2293.1; and
- (b) be clearly visible at all times when the building is occupied by any person having the right of legal entry to the building.

E4.9 Sound systems and intercom systems for emergency purposes

A sound system and intercom system for emergency purposes complying where applicable with **AS 1670.4** must be installed—

- (a) in a building with an *effective height* of more than 25 m; and
- (b) in a Class 3 building having a *rise in storeys* of more than 2 and used as—
 - (i) the residential part of a *school*; or
 - (ii) accommodation for the aged, children or people with disabilities; and
- (c) in a Class 3 building used as a *residential aged care building*, except that the system—
 - (i) must be arranged to provide a warning for occupants; and
 - (ii) in areas used by the residents, may have its alarm adjusted in volume and content to minimise trauma consistent with the type and condition of residents; and
- (d) in a Class 9a building having a *floor area* of more than 1000 m² or a *rise in storeys* of more than 2, and the system—
 - (i) must be arranged to provide a warning for occupants; and
 - (ii) in a *ward area*, may have its alarm adjusted in volume and content to minimise trauma consistent with the type and condition of patients; and
- (e) in a Class 9b building—

Deemed-to-Satisfy Provisions

- (i) used as a *school* and having a *rise in storeys* of more than 3; or
- (ii) used as a theatre, public hall, or the like, having a *floor area* more than 1000 m² or a *rise in storeys* of more than 2.

SECTION **F**

HEALTH AND AMENITY

- F1 Damp and Weatherproofing**
- F2 Sanitary and Other Facilities**
- F3 Room Sizes**
- F4 Light and Ventilation**
- F5 Sound Transmission and Insulation**

SECTION F CONTENTS

SECTION F HEALTH AND AMENITY

Part F1 Damp and Weatherproofing

- Objective FO1
- Functional Statements FF1.1 - FF1.3
- Performance Requirements FP1.1 - FP1.7
- F1.0 Deemed-to-Satisfy Provisions
- F1.1 Stormwater drainage
- F1.2 * * * * *
- F1.3 * * * * *
- F1.4 * * * * *
- F1.5 Roof coverings
- F1.6 Sarking
- F1.7 Water proofing of wet areas in buildings
- F1.8 * * * * *
- F1.9 Damp-proofing
- F1.10 Damp-proofing of floors on the ground
- F1.11 Provision of floor wastes
- F1.12 Sub-floor ventilation
- F1.13 Glazed assemblies

Part F2 Sanitary and Other Facilities

- Objective FO2
- Functional Statements FF2.1 - FF2.4
- Performance Requirements FP2.1 - FP2.6
- F2.0 Deemed-to-Satisfy Provisions
- F2.1 Facilities in residential buildings
- F2.2 Calculation of number of occupants and facilities
- F2.3 Facilities in Class 3 to 9 buildings
- F2.4 Facilities for people with disabilities
- F2.5 Construction of sanitary compartments
- F2.6 Interpretation: Urinals and washbasins
- F2.7 Microbial (legionella) control
- F2.8 Waste management

Part F3 Room Sizes

- Objective FO3
- Functional Statement FF3.1
- Performance Requirement FP3.1
- F3.0 Deemed-to-Satisfy Provisions
- F3.1 Height of rooms and other spaces

Part F4 Light and Ventilation

- Objective FO4

Functional Statements FF4.1 - FF4.3
Performance Requirements FP4.1 - FP4.5
F4.0 Deemed-to-Satisfy Provisions
F4.1 Provision of natural light
F4.2 Methods and extent of natural lighting
F4.3 Natural light borrowed from adjoining room
F4.4 Artificial lighting
F4.5 Ventilation of rooms
F4.6 Natural ventilation
F4.7 Ventilation borrowed from adjoining room
F4.8 Restriction on position of water closets and urinals
F4.9 Airlocks
F4.10 * * * * *
F4.11 Carparks
F4.12 Kitchen local exhaust ventilation

Part F5 Sound Transmission and Insulation

Objective FO5
Functional Statement FF5.1
Performance Requirements FP5.1 - FP5.6
Verification Methods FV5.1 and FV5.2
F5.0 Deemed-to-Satisfy Provisions
F5.1 Application of Part
F5.2 Determination of airborne sound insulation ratings
F5.3 Determination of impact sound insulation ratings
F5.4 Sound insulation rating of floors
F5.5 Sound insulation rating of walls
F5.6 Sound insulation rating of services
F5.7 Sound isolation of pumps
Specification F5.2 Sound Insulation for Building Elements
Specification F5.5 Impact Sound - Test of Equivalence

NSW Appendix (Additional provisions and variations — refer to NSW Contents for full details)

NT Appendix (Additional provisions and variations — refer to NT Contents for full details)

SA Appendix (Additional provisions and variations — refer to SA Contents for full details)

Tas Appendix (Additional provisions and variations — refer to Tas Contents for full details)

Vic Appendix (Additional provisions and variations — refer to Vic Contents for full details)

PART F1 **DAMP AND WEATHERPROOFING**

OBJECTIVE

FO1

The *Objective* of this Part is to—

- (a) safeguard occupants from illness or injury and protect the building from damage caused by—
 - (i) *surface water*; and
 - (ii) external moisture entering a building; and
 - (iii) the accumulation of internal moisture in a building; and
- (b) protect *other property* from damage caused by redirected *surface water*.

FUNCTIONAL STATEMENTS

FF1.1

A building including any associated *sitework* is to be constructed in a way that protects people and *other property* from the adverse effects of redirected *surface water*.

FF1.2

A building is to be constructed to provide resistance to moisture penetrating from the outside including rising from the ground.

FF1.3

A building is to be constructed to avoid the likelihood of—

- (a) the creation of unhealthy or dangerous conditions; and
 - (b) damage to building elements,
- caused by dampness or water overflow from bathrooms, laundries and the like.

PERFORMANCE REQUIREMENTS

FP1.1

Surface water, resulting from a storm having an *average recurrence interval* of 20 years and which is collected or concentrated by a building or *sitework*, must be disposed of in a way that avoids the likelihood of damage or nuisance to any *other property*.

FP1.2

Surface water, resulting from a storm having an *average recurrence interval* of 100 years must not enter the building.

Limitation:

FP1.2 does not apply to—

- (a) a Class 7 or 8 building where in the particular case there is no necessity for compliance; or
- (b) a garage, tool shed, *sanitary compartment*, or the like, forming part of a building used for other purposes; or
- (c) an *open spectator stand* or *open-deck carpark*.

FP1.3

A drainage system for the disposal of *surface water* must—

- (a) convey *surface water* to an appropriate *outfall*; and
- (b) avoid the entry of water into a building; and
- (c) avoid water damaging the building.

FP1.4

A roof and *external wall* (including openings around *windows* and doors) must prevent the penetration of water that could cause—

- (a) unhealthy or dangerous conditions, or loss of amenity for occupants; and
- (b) undue dampness or deterioration of building elements.

Limitation:

FP1.4 does not apply to—

- (a) a Class 7 or 8 building where in the particular case there is no necessity for compliance; or
- (b) a garage, tool shed, *sanitary compartment*, or the like, forming part of a building used for other purposes; or
- (c) an *open spectator stand* or *open-deck carpark*.

FP1.5

SA FP1.5

Moisture from the ground must be prevented from causing—

- (a) undue dampness or deterioration of building elements; and
- (b) unhealthy or dangerous conditions, or loss of amenity for occupants.

Limitation:

FP1.5 does not apply to—

- (a) a Class 7 or 8 building where in the particular case there is no necessity for compliance; or
- (b) a garage, tool shed, *sanitary compartment*, or the like, forming part of a building used for other purposes; or
- (c) an *open spectator stand* or *open-deck carpark*.

FP1.6

SA FP1.6

Overflow from a bathroom, laundry facility or the like must be prevented from penetrating to—

- (a) another *sole-occupancy unit* used for sleeping accommodation; and
- (b) a public space,

in a *storey* below in the same building.

FP1.7

To protect the structure of the building and to maintain the amenity of the occupants, water must be prevented from penetrating—

- (a) behind fittings and linings; and
- (b) into concealed spaces,

of *sanitary compartments*, bathrooms, laundries and the like.

SA FP1.8

PART F1

DAMP AND WEATHERPROOFING

Deemed-to-Satisfy Provisions

F1.0 Deemed-to-Satisfy Provisions

- (a) *Performance Requirement FP1.4*, for the prevention of the penetration of water through *external walls*, must be complied with.

There are no *Deemed-to-Satisfy Provisions* for this *Performance Requirement* in respect of *external walls*.

SA F1.0(b)

- (b) Where a *Building Solution* is proposed to comply with the *Deemed-to-Satisfy Provisions*, *Performance Requirements FP1.1* to *FP1.3* and *FP1.5* to *FP1.7* are satisfied by complying with *F1.1* to *F1.13*.
- (c) Where a *Building Solution* is proposed as an *Alternative Solution* to the *Deemed-to-Satisfy Provisions* of *F1.1* to *F1.13*, the relevant *Performance Requirements* must be determined in accordance with *A0.10*.

F1.1 Stormwater drainage

Stormwater drainage must comply with AS/NZS 3500.3.

F1.2 * * * * *

This clause has deliberately been left blank.

F1.3 * * * * *

This clause has deliberately been left blank.

F1.4 * * * * *

This clause has deliberately been left blank.

F1.5 Roof coverings

A roof must be covered with—

- (a) concrete roofing tiles complying with AS 2049 and fixed, except in cyclonic areas, in accordance with AS 2050, as appropriate; or
- (b) terracotta roofing tiles complying with AS 2049 and fixed, except in cyclonic areas, in accordance with AS 2050; or
- (c) cellulose cement corrugated sheeting complying with AS/NZS 2908.1 and installed in accordance with AS/NZS 1562.2; or
- (d) metal sheet roofing complying with AS 1562.1; or

Deemed-to-Satisfy Provisions

- (e) plastic sheet roofing designed and installed in accordance with AS/NZS 4256 Parts 1, 2, 3 and 5 and AS/NZS 1562.3; or
- (f) asphalt shingles complying with ASTM D3018-90, Class A.

F1.6 Sarking

Sarking-type materials used for weatherproofing of roofs and walls must comply with AS/NZS 4200 Parts 1 and 2.

F1.7 Water proofing of wet areas in buildings

SA F1.7

- (a) Building elements in wet areas in Class 2 and 3 buildings and Class 4 parts of buildings must be water-resistant or waterproof in accordance with AS 3740.
- (b) In a Class 5, 6, 7, 8 or 9 building, the bathroom or shower room, slop hopper or sink compartment, laundry or sanitary compartment must be water-resistant or waterproof in accordance with AS 3740 as if they were in a residential building.
- (c) Where a slab or stall type urinal is installed—
 - (i) the floor surface of the room containing the urinal must—
 - (A) be an impervious material; and
 - (B) where no step is installed—
 - (aa) be graded to the urinal channel for a distance of 1.5 m from the urinal channel; and
 - (bb) the remainder of the floor be graded to a floor waste; and
 - (C) where a step is installed—
 - (aa) the step must have an impervious surface and be graded to the urinal channel; and
 - (bb) the floor behind the step must be graded to a floor waste; and
 - (ii) the junction between the floor surface and the urinal channel must be impervious.
- (d) Where a wall hung urinal is installed—
 - (i) the wall must be surfaced with impervious material extending from the floor to not less than 50 mm above the top of the urinal and not less than 225 mm on each side of the urinal.
 - (ii) the floor must be surfaced with impervious material and graded to a floor waste.
- (e) In a room with timber or steel framed walls and containing a urinal—
 - (i) the wall must be surfaced with an impervious material extending from the floor to not less than 100 mm above the floor surface; and
 - (ii) the junction of the floor surface and the wall surface must be impervious.

F1.8 * * * * *

This clause has deliberately been left blank.

Deemed-to-Satisfy Provisions

F1.9 Damp-proofing

- (a) Except for a building covered by (c), moisture from the ground must be prevented from reaching—
- (i) the lowest floor timbers and the walls above the lowest floor joists; and
 - (ii) the walls above the damp-proof course; and
 - (iii) the underside of a suspended floor constructed of a material other than timber, and the supporting beams or girders.

SA F1.9(b)

- (b) Where a damp-proof course is provided, it must consist of—
- (i) a material that complies with AS/NZS 2904; or
 - (ii) impervious termite shields in accordance with AS 3660.1.
- (c) The following buildings need not comply with (a):
- (i) A Class 7 or 8 building where in the particular case there is no necessity for compliance.
 - (ii) A garage, tool shed, *sanitary compartment*, or the like, forming part of a building used for other purposes.
 - (iii) an *open spectator stand* or *open-deck carpark*.

F1.10 Damp-proofing of floors on the ground

SA F1.10

If a floor of a room is laid on the ground or on fill, moisture from the ground must be prevented from reaching the upper surface of the floor and adjacent walls by the insertion of a vapour barrier in accordance with AS 2870, except damp-proofing need not be provided if—

- (a) weatherproofing is not *required*; or
- (b) the floor is the base of a stair, lift or similar *shaft* which is adequately drained by gravitation or mechanical means.

F1.11 Provision of floor wastes

SA F1.11

In a Class 2 or 3 building or Class 4 part of a building, the floor of each bathroom and laundry located at any level above a *sole-occupancy unit* or public space must be graded to permit drainage to a floor waste.

F1.12 Sub-floor ventilation

The sub-floor space between a suspended floor of a building and the ground must be in accordance with the following:

- (a) The sub-floor space must—
 - (i) be cleared of all building debris and vegetation; and
 - (ii) be cross-ventilated by means of openings; and

Deemed-to-Satisfy Provisions

- (iii) contain no dead air spaces; and
 - (iv) be graded to prevent surface water ponding under the building; and
 - (v) have evenly spaced ventilation openings.
- (b) In double leaf masonry walls, the cross ventilation openings specified in **(a)** must be provided in both leaves of the masonry, with inner-leaf openings being aligned with outer-leaf openings to allow an unobstructed flow of air.
- (c) Internal walls constructed in sub-floor spaces must be provided with openings—
- (i) having an unobstructed area equivalent to that *required* for the adjacent external openings; and
 - (ii) which are evenly distributed throughout such internal walls.
- (d) The clearance between the ground surface and the underside of the floor, including any horizontal framing member, must be in accordance with **Table F1.12**.
- (e) The sub-floor ventilation openings in internal and *external walls* must be in accordance with **Table F1.12** for the climatic zones given in **Figure F1.12**.
- (f) Where ventilation is obstructed by patios, paving or the like, additional ventilation must be provided to ensure that the overall level of ventilation is maintained.
- (g) Where the ground or sub-floor space is excessively damp or subject to frequent flooding, in addition to the requirements of **(a)** to **(f)**—
- (i) the area of sub-floor ventilation *required* in **(e)** must be increased by 50%; or
 - (ii) a sealed impervious membrane must be provided over the ground; or
 - (iii) Durability Class 1 or 2 timbers or H3 preservative treated timbers in accordance with AS 1684.2, AS 1684.3 or AS 1684.4 must be used.

Deemed-to-Satisfy Provisions

**Figure F1.12
CLIMATIC ZONES BASED ON RELATIVE HUMIDITY**

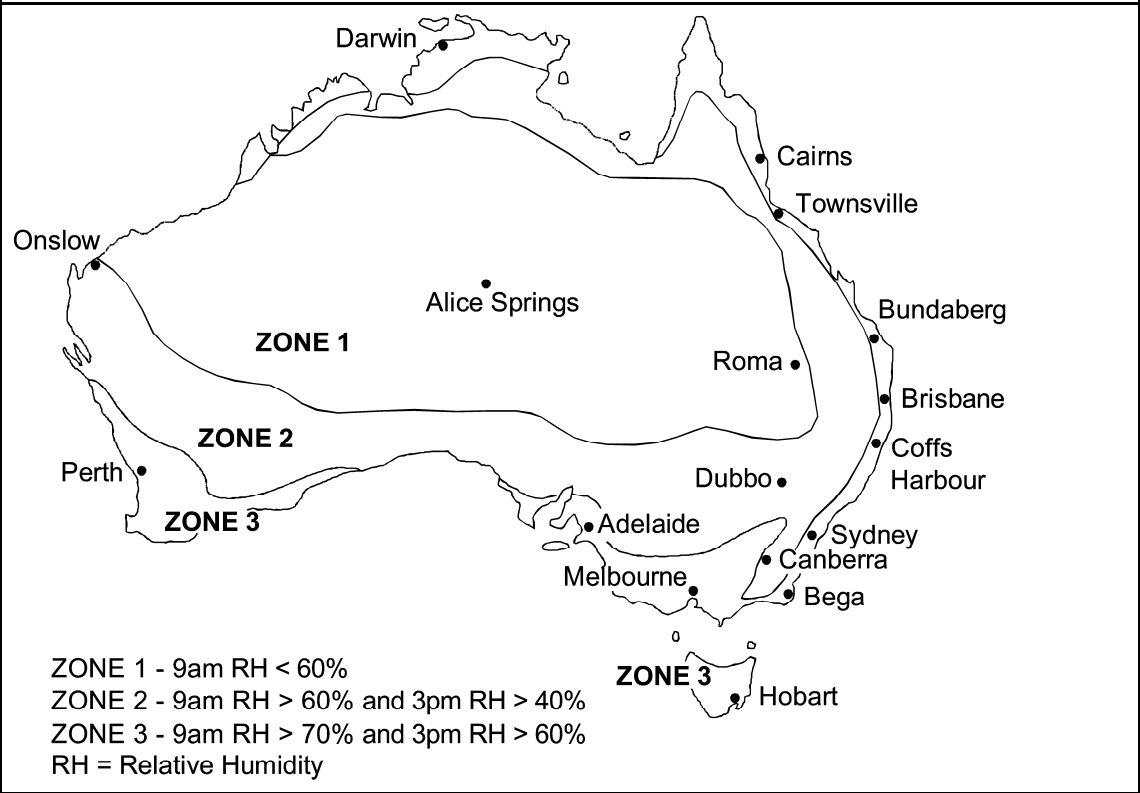

Note: The season with the highest relative humidity is used. Generally this will be July for southern Australia and January for northern Australia.

Table F1.12 SUB-FLOOR VENTILATION AND CLEARANCE

Climate zone (see Figure F1.12)	Minimum sub-floor ventilation (mm ² /m of wall)		Minimum height from ground surface (mm)	
	No membrane	Ground sealed with impervious membrane	Termite inspection not required	Termite inspection required (see note)
1	2000	1000	150	400
2	4000	2000	150	400
3	6000	3000	150	400

Note: On sloping sites, 400 mm clearance may be reduced to 150 mm within 2 m of *external walls*.

Deemed-to-Satisfy Provisions

F1.13 Glazed assemblies

- (a) Subject to **(b)** and **(c)**, the following glazed assemblies in an *external wall*, must comply with AS 2047 requirements for resistance to water penetration:
- (i) Windows.
 - (ii) Sliding doors with a frame.
 - (iii) Adjustable louvres.
 - (iv) Shopfronts.
 - (v) Window walls with one piece framing.
- (b) The following buildings need not comply with **(a)**:
- (i) A Class 7 or 8 building where in the particular case there is no necessity for compliance.
 - (ii) A garage, tool shed, *sanitary compartment*, or the like, forming part of a building used for other purposes, except where the construction of the garage, tool shed, *sanitary compartment* or the like contributes to the weatherproofing of the other part of the building.
 - (iii) An *open spectator stand* or *open-deck carpark*.
- (c) The following glazed assemblies need not comply with **(a)**:
- (i) All glazed assemblies not in an *external wall*.
 - (ii) Hinged doors, including French doors and bi-fold doors.
 - (iii) Revolving doors.
 - (iv) Fixed louvres.
 - (v) Skylights, roof lights and windows in other than the vertical plane.
 - (vi) Sliding doors without a frame.
 - (vii) Shopfront doors.
 - (viii) Windows constructed on site and architectural one-off windows, which are not design tested in accordance with AS 2047.
 - (ix) Second-hand windows, re-used windows, recycled windows and replacement windows.
 - (x) Heritage windows.

PART F2 SANITARY AND OTHER FACILITIES

OBJECTIVE

FO2

The *Objective* of this Part is to—

- (a) safeguard occupants from illness caused by infection; and
- (b) safeguard occupants from loss of amenity arising from the absence of adequate personal hygiene facilities; and
- (c) enable occupants to carry out laundering; and
- (d) provide for facilities to enable food preparation; and
- (e) enable unconscious occupants of *sanitary compartments* to be removed from the compartment.

FUNCTIONAL STATEMENTS

FF2.1

A building is to be provided with—

- (a) suitable sanitary facilities and space and facilities for personal hygiene; and
NSW FF2.1(b)
- (b) adequate means for the prevention of contaminants to hot water, warm water and cooling water systems.

FF2.2

A building is to be provided with space and facilities for laundering.

Vic FF2.2 Application

Application:

FF2.1 only applies to—

- (a) a Class 2 building or Class 4 part of a building; and
- (b) a Class 9a *health-care building*; and
- (c) a Class 9c *aged care building*; and
- (d) an *early childhood centre*.

FF2.3

A building is to be provided with space and facilities for the preparation and cooking of food.

Application:

FF2.3 only applies to—

- (a) a Class 2 building or Class 4 part of a building; and
- (b) a Class 9a *health-care building*; and
- (c) a Class 9c *aged care building*; and
- (d) an *early childhood centre*.

FF2.4

A *sanitary compartment* is to have sufficient space or other means to permit an unconscious occupant to be removed from the compartment.

PERFORMANCE REQUIREMENTS

FP2.1

Suitable sanitary facilities for personal hygiene must be provided in a convenient location within or associated with a building, to the degree necessary, appropriate to—

- (a) the function or use of the building; and
- (b) the number and gender of the occupants; and
- (c) the disability or other particular needs of the occupants.

FP2.2

Laundrying facilities or space for laundrying facilities must be provided in a convenient location within or associated with a building appropriate to the function or use of the building.

Vic FP2.2 Application

Application:

FP2.2 only applies to—

- (a) a Class 2 building or Class 4 part; and
- (b) a Class 9a *health-care building*; and
- (c) a Class 9c *aged care building*; and
- (d) an *early childhood centre*.

FP2.3

A facility must be provided which includes—

- (a) a means for food rinsing, utensil washing and waste water disposal; and

- (b) a means for cooking food; and
- (c) a space for food preparation.

Vic FP2.3(d)

Application:

FP2.3 only applies to—

- (a) a Class 2 building or Class 4 part; and
- (b) a Class 9a *health-care building*; and
- (c) a Class 9c *aged care building*; and
- (d) an *early childhood centre*.

FP2.4

Suitable means must be provided in a building containing wards or bedrooms to facilitate the emptying of sewage or dirty water from containers.

Application:

FP2.4 only applies to a Class 9a or 9c building.

FP2.5

A *sanitary compartment* must be constructed with sufficient space or other means to permit an unconscious occupant to be removed from the compartment.

FP2.6

NSW FP2.6

Hot water, warm water and cooling water systems installed in a building must control the accumulation of harmful levels of micro-organisms.

Limitation:

FP2.6 does not apply to a system serving only a single *sole-occupancy unit* in a Class 2 or 3 building or Class 4 part of a building.

PART F2 SANITARY AND OTHER FACILITIES

Deemed-to-Satisfy Provisions

F2.0 Deemed-to-Satisfy Provisions

Vic F2.0

- (a) Where a *Building Solution* is proposed to comply with the *Deemed-to-Satisfy Provisions, Performance Requirements FP2.1 to FP2.6* are satisfied by complying with **F2.1 to F2.8**.
- (b) Where a *Building Solution* is proposed as an *Alternative Solution* to the *Deemed-to-Satisfy Provisions* of **F2.1 to F2.8**, the relevant *Performance Requirements* must be determined in accordance with **A0.10**.

F2.1 Facilities in residential buildings

Sanitary and other facilities for Class 2 and 3 buildings and Class 9c *aged care buildings* and for Class 4 parts of buildings must be provided in accordance with **Table F2.1**.

Vic Table F2.1

Table F2.1 PROVISION OF SANITARY AND OTHER FACILITIES IN RESIDENTIAL BUILDINGS

Class 2
Within each <i>sole-occupancy unit</i> , provide—
(a) a kitchen sink and facilities for the preparation and cooking of food; and
(b) a bath or shower; and
(c) a closet pan and washbasin.
Laundry facilities, provide either—
(a) in each <i>sole-occupancy unit</i> —
(i) clothes washing facilities, comprising at least one washtub and space for a washing machine; and
(ii) clothes drying facilities comprising—
(A) clothes line or hoist with not less than 7.5 m of line; or
(B) space for one heat-operated drying cabinet or appliance in the same room as the clothes washing facilities; or
Note: A kitchen sink or washbasin must not be counted as a laundry washtub.
(b) a separate laundry for each 4 <i>sole-occupancy units</i> , or part thereof—
(i) clothes washing facilities comprising at least one washtub and one washing machine; and
(ii) clothes drying facilities comprising—
(A) clothes line or hoist with not less than 7.5 m of line per <i>sole-occupancy unit</i> , or

Deemed-to-Satisfy Provisions

Table F2.1 PROVISION OF SANITARY AND OTHER FACILITIES IN RESIDENTIAL BUILDINGS— continued

<p>(B) one heat-operated drying cabinet or appliance for each 4 <i>sole-occupancy units</i>.</p> <p>Facilities for employees—</p> <p>If the building contains more than 10 <i>sole-occupancy units</i>, or a group of Class 2 buildings on the one allotment contains, in total, more than 10 <i>sole-occupancy units</i> — provide a closet pan and washbasin in a compartment or room at or near ground level and accessible to employees without entering a <i>sole-occupancy unit</i>.</p>
Class 3 (other than Class 3 <i>residential aged care buildings</i>)
<p>Facilities for residents—</p> <p>For each building or group of buildings, provide—</p> <p>(a) a bath or shower; and</p> <p>(b) a closet pan and washbasin,</p> <p>for each 10 residents for whom private facilities are not provided, except that—</p> <p>(c) if one urinal is provided for each 25 males up to 50 and one additional urinal for each additional 50 males or part thereof,</p> <p>one closet pan for each 12 males may be provided.</p> <p>Facilities for employees — see Clause F2.3.</p> <p>Note: These facilities need not be situated within the building.</p>
Class 3 (<i>residential aged care buildings</i>)
<p>Facilities for residents—</p> <p>For each building or group of buildings, provide—</p> <p>(a) a shower, closet pan and wash basin for each 8 residents or part thereof for whom private facilities are not provided; and</p> <p>(b) a suitable bath for each 30 residents or part thereof.</p> <p>Note: Urinals must not be taken into consideration in calculating the number of facilities.</p>
Class 4
<p>For each <i>sole-occupancy unit</i>, provide—</p> <p>(a) a kitchen sink and facilities for the preparation and cooking of food; and</p> <p>(b) a bath or shower; and</p> <p>(c) a closet pan and washbasin; and</p> <p>(d) clothes washing facilities, comprising a washtub and space in the same room for a washing machine or wash copper; and</p> <p>(e) a clothes line or hoist, or space for a heat-operated drying cabinet or similar appliance for the exclusive use of the occupants.</p> <p>Note: A kitchen sink or washbasin must not be counted as a laundry washtub.</p>
Class 9c (<i>aged care buildings</i>)

Deemed-to-Satisfy Provisions

Table F2.1 PROVISION OF SANITARY AND OTHER FACILITIES IN RESIDENTIAL BUILDINGS— continued

Facilities for residents—

For each building or group of buildings, provide—

- (a) a closet pan and wash basin for each 6 residents or part thereof for whom private facilities are not provided; and
- (b) a shower for each 7 residents or part thereof for whom private facilities are not provided; and
- (c) a suitable bath, fixed or mobile.

Other facilities, provide—

- (a) one kitchen or other adequate facility for the preparation and cooking or reheating of food including a kitchen sink and washbasin; and
- (b) laundry facilities for the cleansing and drying of linen and clothing or adequate facilities for holding and dispatch or treatment of soiled linen and clothing and the like and the receipt and storage of clean linen; and
- (c) one clinical hand washing basin for each 16 residents or part thereof.

Note: Urinals must not be taken into consideration in calculating the number of facilities.

F2.2 Calculation of number of occupants and facilities

- (a) The number of persons accommodated must be calculated according to **D1.13** if it cannot be more accurately determined by other means.
- (b) Unless the premises are used predominantly by one sex, sanitary facilities must be provided on the basis of equal numbers of males and females.
- (c) In calculating the number of sanitary facilities to be provided under **F2.1** and **F2.3**, a unisex facility *required* for people with disabilities may be counted once for each sex.
- (d) For the purposes of this Part, a unisex facility comprises one closet pan, one washbasin and means for the disposal of sanitary towels.

F2.3 Facilities in Class 3 to 9 buildings

SA F2.3(a)

- (a) Sanitary facilities must be provided for Class 3, 5, 6, 7, 8 and 9 buildings in accordance with **Table F2.3**.
- (b) If not more than 10 people are employed, a unisex facility may be provided instead of separate facilities for each sex.
- (c) If the majority of employees are of one sex, not more than 2 employees of the other sex may share toilet facilities if the facilities are separated by means of walls, partitions and doors to afford privacy.

Deemed-to-Satisfy Provisions

- (d) Employees and the public may share the same facilities in a Class 6 and 9b building (other than a *school* or *early childhood centre*) provided the number of facilities provided is not less than the total number of facilities *required* for employees plus those *required* for the public.
- (e) Adequate means of disposal of sanitary towels must be provided in sanitary facilities for use by females.
- (f) A Class 9a *health-care building* must be provided with—
 - (i) one kitchen or other adequate facility for the preparation and cooking or reheating of food including a kitchen sink and washbasin; and
 - (ii) laundry facilities for the cleansing and drying of linen and clothing or adequate facilities for holding and dispatch or treatment of soiled linen and clothing, sanitary towels and the like and the receipt and storage of clean linen; and
 - (iii) one shower for each 8 patients or part thereof; and
 - (iv) one island-type plunge bath in each *storey* containing a *ward area*.

Vic F2.3(g)

- (g) A Class 9b *early childhood centre* must be provided with—
 - (i) one kitchen with facilities for preparation and cooking of food for infants including a kitchen sink and space for a refrigerator; and
 - (ii) one bath or shower-bath; and
 - (iii) if the centre accommodates children younger than 3 years old—
 - (A) a laundry facility comprising a washtub and space in the same room for a washing machine; and
 - (B) a bench type baby bath.
- (h) Class 9b theatres and sporting venues must be provided with one shower for each 10 participants or part thereof.

SA Table F2.3

Tas Table F2.3

Vic Table F2.3

Table F2.3 SANITARY FACILITIES IN CLASS 3, 5, 6, 7, 8 AND 9 BUILDINGS

User Group	Closet Pans		Urinals		Washbasins	
	Design Occupancy	Number	Design Occupancy	Number	Design Occupancy	Number
Class 3, 5, 6 and 9 other than schools						
Male employees	1 — 20	1	1 — 10	0	1 — 30	1
	> 20	Add 1 per 20	11 — 25	1	> 30	Add 1 per 30
			26 — 50	2		
			>50	Add 1 per 50		
Female employees	1 — 15	1			1 — 30	1
	> 15	Add 1 per 15			> 30	Add 1 per 30
Class 7 and 8						
Male employees	1 — 20	1	1 — 10	0	1 — 20	1
	> 20	Add 1 per 20	11 — 25	1	> 20	Add 1 per 20
			26 — 50	2		
			>50	Add 1 per 50		
Female employees	1 — 15	1			1 — 20	1
	> 15	Add 1 per 15			> 20	Add 1 per 20
Class 6 — department stores, shopping centres						
Male patrons	1 — 1200	1	1 — 600	1	1 — 600	1
	> 1200	Add 1 per 1200	>600	Add 1 per 1200	>600	Add 1 per 1200
Female patrons	1 — 300	1			1 — 600	1
	301 — 600	2			601 — 1200	2
	>600	Add 1 per 1200			>1200	Add 1 per 1200

Deemed-to-Satisfy Provisions **SUPERSEDED**

Table F2.3 SANITARY FACILITIES IN CLASS 3, 5, 6, 7, 8 AND 9 BUILDINGS — continued

User Group	Closet Pans		Urinals		Washbasins	
	Design Occupancy	Number	Design Occupancy	Number	Design Occupancy	Number
Note: Sanitary facilities need not be provided for patrons if the building accommodates not more than 600 people.						
Class 6 — restaurants, cafes, bars						
Male patrons	1 — 100	1	1 — 50	1	1 — 50	1
	101 — 300	2	51 — 100	2	51 — 200	2
	>300	Add 1 per 200	101 — 150	3	>200	Add 1 per 200
			151 — 200	4		
			201 — 250	5		
			>250	Add 1 per 100		
Female patrons	1 — 25	1			1 — 50	1
	26 — 50	2			51 — 150	2
	51 — 100	3			>150	Add 1 per 200
	101 — 150	4				
	151 — 200	5				
	201 — 250	6				
	>250	Add 1 per 100				
Note: Sanitary facilities need not be provided for patrons if the building accommodates not more than 20 people.						
Class 9a — health-care buildings						
Male patients	1 — 16	2			1 — 8	1
	>16	Add 1 per 8			> 8	Add 1 per 8
Female patients	1 — 16	2			1 — 8	1
	>16	Add 1 per 8			> 8	Add 1 per 8

Deemed-to-Satisfy Provisions **SUPERSEDED**

Table F2.3 SANITARY FACILITIES IN CLASS 3, 5, 6, 7, 8 AND 9 BUILDINGS — continued

User Group	Closet Pans		Urinals		Washbasins	
	Design Occupancy	Number	Design Occupancy	Number	Design Occupancy	Number
Class 9b — schools						
Male employees	1 — 20	1	1 — 10	0	1 — 30	1
	> 20	Add 1 per 20	11 — 20	1	> 30	Add 1 per 30
			21 — 45	2		
			>45	Add 1 per 30		
Female employees	1 — 5	1			1 — 30	1
	>5	Add 1 per 15			> 30	Add 1 per 30
Male students	1 — 30	1	1 — 30	1	1 — 20	1
	31 — 70	2	31 — 70	2	21 — 40	2
	>70	Add 1 per 70	>70	Add 1 per 35	>40	Add 1 per 40
Female students	1 — 10	1			1 — 20	1
	11 — 20	2			21 — 40	2
	>20	Add 1 per 20			>40	Add 1 per 40
Class 9b — early childhood centres						
Children	1 — 15	1			1 — 15	1
	> 15	Add 1 per 15			> 15	Add 1 per 15
Note: Facilities for use by children must be— (a) junior pans; and (b) washbasins with a rim height not exceeding 600mm.						
Class 9b — theatres and cinemas with multiple auditoria, sports venues, art galleries or the like						

Deemed-to-Satisfy Provisions **SUPERSEDED**

Table F2.3 SANITARY FACILITIES IN CLASS 3, 5, 6, 7, 8 AND 9 BUILDINGS — continued

User Group	Closet Pans		Urinals		Washbasins	
	Design Occupancy	Number	Design Occupancy	Number	Design Occupancy	Number
Male participants	1 — 20 > 20	1 Add 1 per 20	1 — 10 > 10	1 Add 1 per 10	1 — 10 > 10	1 Add 1 per 10
Female participants	1 — 10 > 10	1 Add 1 per 10			1 — 10 > 10	1 Add 1 per 10
Male spectators or patrons	1 — 50 51 — 250 251 — 500 >500	0 1 2 Add 1 per 500	1 — 50 51 — 100 >100	0 1 Add 1 per 100	1 — 50 51 — 150 >150	0 1 Add 1 per 150
Female spectators or patrons	1 — 50 51 — 75 >75	0 1 Add 1 per 75			1 — 50 51 — 150 >150	0 1 Add 1 per 150
Class 9b — Single auditorium theatres and cinemas						
Male patrons	1 — 50 51 — 250 251 — 500 >500	0 1 2 Add 1 per 500	1 — 50 51 — 100 >100	0 1 Add 1 per 100	1 — 50 51 — 150 >150	0 1 Add 1 per 150

Deemed-to-Satisfy Provisions **SUPERSEDED**

Table F2.3 SANITARY FACILITIES IN CLASS 3, 5, 6, 7, 8 AND 9 BUILDINGS — continued

User Group	Closet Pans		Urinals		Washbasins	
	Design Occupancy	Number	Design Occupancy	Number	Design Occupancy	Number
Female patrons	1 — 50	0			1 — 50	0
	51 — 110	3			51 — 150	1
	111 — 170	4			>150	Add 1 per 150
	171 — 230	5				
	231 — 250	6				
	>250	Add 1 per 80				
Class 9b — churches, chapels or the like						
Male patrons	1 — 300	1	1 — 200	1	1 — 250	1
	>300	Add 1 per 500	> 200	Add 1 per 200	> 250	Add 1 per 250
Female patrons	1 — 150	1			1 — 250	1
	> 150	Add 1 per 150			> 250	Add 1 per 250`
Class 9b — public halls, function rooms or the like						
Male patrons	1 — 100	1	1 — 50	1	1 — 50	1
	>100	Add 1 per 200	51 — 100	2	51 — 200	2
			101 — 150	3	>200	Add 1 per 200
			151 — 200	4		
			201 — 250	5		
			>250	Add 1 per 100		

Deemed-to-Satisfy Provisions **SUPERSEDED**

Table F2.3 SANITARY FACILITIES IN CLASS 3, 5, 6, 7, 8 AND 9 BUILDINGS — continued

User Group	Closet Pans		Urinals		Washbasins	
	Design Occupancy	Number	Design Occupancy	Number	Design Occupancy	Number
Female patrons	1 — 25	1			1 — 50	1
	26 — 50	2			51 — 150	2
	51 — 100	3			>150	Add 1 per 200
	101 — 150	4				
	151 — 200	5				
	201 — 250	6				
	>250	Add 1 per 100				

Note: Sanitary facilities need not be provided for patrons if the building accommodates not more than 20 people.

Notes:

1. Number — means the number of facilities *required*.
2. > — means greater than
3. Employees — a reference to employees includes owners and managers using the building.
4. A reference to "add 1 per 100 or 150, 250, 500" etc. includes any part of that number.

Deemed-to-Satisfy Provisions

F2.4 Facilities for people with disabilities

(a) Sanitary facilities must be provided for people with disabilities in accordance with **Table F2.4** for—

SA F2.4(a)(i)

- (i) every Class 3, 5, 6, 7, 8 and 9 building that is *required* to be *accessible* in accordance with **Part D3** and must be calculated as part of the number of facilities *required* by **Table F2.3**; and
 - (ii) a Class 10a building *required* to be *accessible*.
- (b) The construction and layout of all facilities provided in accordance with **Table F2.4** must comply with AS 1428.1.
- (c) A unisex facility must be located so that it can be entered without crossing an area reserved for one sex only.
- (d) Where two or more facilities for people with disabilities are *required*, the number of mirror image configurations of each facility shall be provided as evenly as possible.

SA Table F2.4

Table F2.4 SANITARY FACILITIES FOR PEOPLE WITH DISABILITIES

Class 3 and Class 9c <i>aged care buildings</i>	
(a)	In every <i>sole-occupancy unit</i> to which access for people with disabilities is <i>required</i> , provide—
(i)	one closet pan and washbasin; and
(ii)	one shower; and
(iii)	a shelf in each sanitary compartment.
(b)	To parts of the building to which access for people with disabilities is <i>required</i> other than in <i>sole-occupancy units</i> , provide—
(i)	where F2.1 and F2.3 <i>require</i> 1–100 closet pans plus urinals, one wheelchair <i>accessible</i> unisex facility; or
(ii)	where F2.1 and F2.3 <i>require</i> 101–200 closet pans plus urinals—
(A)	two wheelchair <i>accessible</i> unisex facilities; or
(B)	one wheelchair <i>accessible</i> unisex facility and one wheelchair accessible closet pan and washbasin for each sex; or
(iii)	where F2.1 and F2.3 <i>require</i> more than 200 closet pans plus urinals—
(A)	two wheelchair <i>accessible</i> unisex facilities or one wheelchair <i>accessible</i> unisex facility and one wheelchair <i>accessible</i> closet pan and washbasin for each sex; and
(B)	one additional wheelchair <i>accessible</i> unisex facility or one wheelchair <i>accessible</i> closet pan and washbasin for each sex for each additional 100 facilities normally <i>required</i> ; and

Deemed-to-Satisfy Provisions

Table F2.4 SANITARY FACILITIES FOR PEOPLE WITH DISABILITIES — *continued*

- (iv) where **F2.1** and **F2.3** *require* 1 or more showers, one *accessible* shower for each 10 showers or part thereof, but not less than one for use by both sexes; and
- (v) adequate facilities for the disposal of sanitary towels must be provided; and
- (vi) a unisex sanitary facility must have a shelf.

Class 5, 6, 7, 8, 9a & 9b buildings

In buildings to which access for people with disabilities is *required*—

- (a) where **F2.1** and **F2.3** *require* 1–100 closet pans plus urinals, provide one wheelchair *accessible* unisex facility; or
- (b) where **F2.1** and **F2.3** *require* 101–200 closet pans plus urinals, provide—
 - (i) two wheelchair *accessible* unisex facilities; or
 - (ii) one wheelchair *accessible* unisex facility and one wheelchair *accessible* closet pan and washbasin for each sex; or
- (c) where **F2.1** and **F2.3** *require* more than 200 closet pans plus urinals, provide—
 - (i) two wheelchair *accessible* unisex facilities or one wheelchair *accessible* unisex facility and one wheelchair *accessible* closet pan and washbasin for each sex; and
 - (ii) one additional wheelchair *accessible* unisex facility or one wheelchair *accessible* closet pan and washbasin for each sex for each additional 100 facilities normally *required*; and
- (d) where **F2.1** and **F2.3** *require* 1 or more showers, provide one *accessible* shower for each 10 showers or part thereof, but not less than one for use by both sexes; and
- (e) adequate facilities for the disposal of sanitary towels must be provided; and
- (f) a unisex sanitary facility must have a shelf.

Class 10a buildings

In buildings *required* to be *accessible*, provide—

- (a) where sanitary facilities are provided, not less than 1 wheelchair *accessible* unisex sanitary facility; and
- (b) where sanitary facilities containing more than one *sanitary compartment* are provided for the general public in addition to the wheelchair *accessible* unisex facility, not less than 1 *sanitary compartment* for each sex, suitable for an ambulant person with a disability; and
- (c) where shower facilities are provided, not less than 1 *accessible* shower for each 10 showers or part thereof, with not less than 1 *accessible* shower suitably located for use by both sexes; and
- (d) adequate facilities for the disposal of sanitary towels; and
- (e) a shelf in each unisex sanitary facility.

Notes:

1. A *sanitary compartment* suitable for an ambulant person with a disability need not be wheelchair *accessible*.

Deemed-to-Satisfy Provisions

Table F2.4 SANITARY FACILITIES FOR PEOPLE WITH DISABILITIES — *continued*

2. Where sanitary facilities *required* by **Tables F2.1** and **Table F2.3** are located in an appurtenant Class 10a building, the number of *accessible* sanitary facilities must be determined as if the Class 10a building was of the same classification as that to which it is appurtenant.

F2.5 Construction of sanitary compartments

- (a) Other than in an *early childhood centre*, *sanitary compartments* must have doors and partitions that separate adjacent compartments and extend—
- (i) from floor level to the ceiling in the case of a unisex facility; or
 - (ii) to a height of not less than 1.5 m above the floor if primary *school* children are the principal users; or
 - (iii) 1.8 m above the floor in all other cases.
- (b) The door to a fully enclosed *sanitary compartment* must—
- (i) open outwards; or
 - (ii) slide; or
 - (iii) be readily removable from the outside of the *sanitary compartment*,
- unless there is a clear space of at least 1.2 m, measured in accordance with **Figure F2.5**, between the closet pan within the *sanitary compartment* and the doorway.

Vic F2.5(c)

Figure F2.5

CONSTRUCTION OF SANITARY COMPARTMENTS

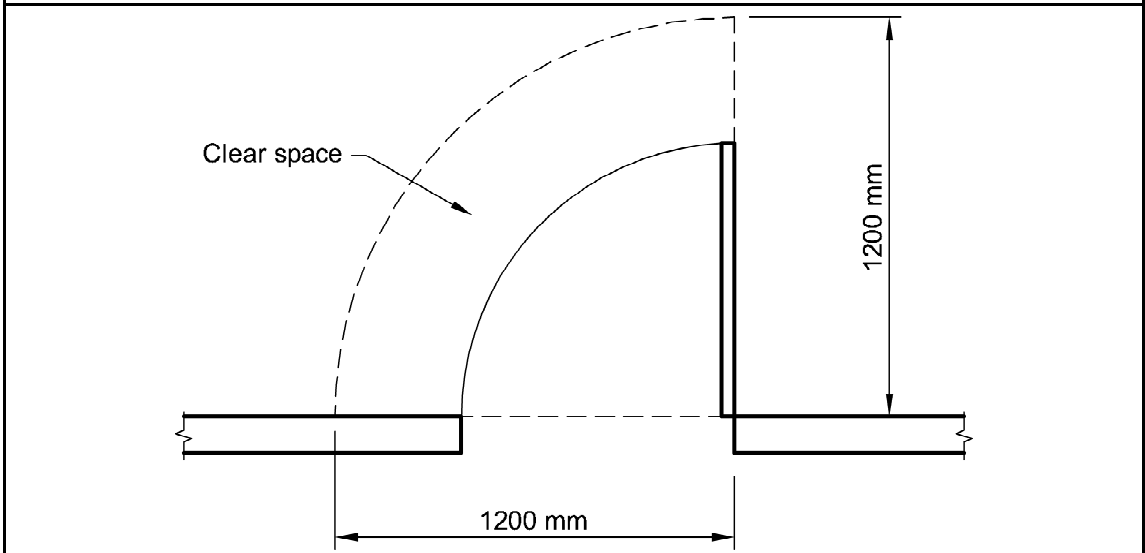

F2.6 Interpretation: Urinals and washbasins

- (a) A urinal may be—

Deemed-to-Satisfy Provisions

- (i) an individual stall or wall-hung urinal; or
 - (ii) each 600 mm length of a continuous urinal trough; or
 - (iii) a closet pan used in place of a urinal.
- (b) A washbasin may be—
- (i) an individual basin; or
 - (ii) a part of a hand washing trough served by a single water tap.

F2.7 Microbial (legionella) control

NSW F2.7

Hot water, warm water and cooling water systems in a building other than a system serving only a single *sole-occupancy unit* in a Class 2 or 3 building or Class 4 part of a building must be installed in accordance with AS/NZS 3666.1.

F2.8 Waste management

- (a) In a Class 9a *health-care building*, at least one slop-hopper or other device, other than a water closet pan or urinal, must be provided—
- (i) on any *storey* containing *ward areas* or bedrooms to facilitate emptying of containers of sewage or dirty water; and
 - (ii) with a flushing apparatus, tap and grating.
- (b) In a Class 9c *aged care building*, the following facilities must be provided for every 60 beds or part thereof on each storey containing *resident use areas*—
- (i) one slop-hopper or other device other than a water closet pan or urinal for the safe handling and disposal of liquid and solid wastes with a flushing apparatus, tap and grating ; and
 - (ii) an appliance for the disinfection of pans or an adequate means to dispose of receptacles.

Tas F2.101, F2.102

Vic F2.101

PART **F3** ROOM SIZES

OBJECTIVE

FO3

Vic FO3

The *Objective* of this Part is to safeguard occupants from injury or loss of amenity caused by inadequate height of a room or space.

FUNCTIONAL STATEMENT

FF3.1

Vic FF3.1

A building is to be constructed to provide height in a room or space suitable for the intended use.

PERFORMANCE REQUIREMENT

FP3.1

Vic FP3.1

A *habitable room* or space must have sufficient height that does not unduly interfere with its intended function.

PART F3 ROOM SIZES

Deemed-to-Satisfy Provisions

F3.0 Deemed-to-Satisfy Provisions

Vic F3.0

- (a) Where a *Building Solution* is proposed to comply with the *Deemed-to-Satisfy Provisions, Performance Requirements FP3.1* is satisfied by complying with **F3.1**.
- (b) Where a *Building Solution* is proposed as an *Alternative Solution* to the *Deemed-to-Satisfy Provisions* of **F3.1**, the relevant *Performance Requirements* must be determined in accordance with **A0.10**.

F3.1 Height of rooms and other spaces

The ceiling height must be not less than—

- (a) in a Class 2 or 3 building or Class 4 part—
 - (i) a kitchen, laundry, or the like — 2.1 m; and
 - (ii) a corridor, passageway or the like — 2.1 m; and
 - (iii) a *habitable room* excluding a kitchen — 2.4 m; and
 - (iv) in a room or space with a sloping ceiling or projections below the ceiling line within—
 - (A) a *habitable room*—
 - (aa) in an attic — a height of not less than 2.2 m for not less than two-thirds of the *floor area* of the room or space; and
 - (bb) in other rooms — a height of not less than 2.4 m for not less than two-thirds of the *floor area* of the room or space; and
 - (B) a non-*habitable room* — a height of not less than 2.1 m for not less than two-thirds of the *floor area* of the room or space; andwhen calculating the *floor area* of a room or space, any part that has a ceiling height of less than 1.5 m is not included; and
- (b) in a Class 5, 6, 7 or 8 building—
 - (i) except as allowed in **(ii)** and **(f)** — 2.4 m; and
 - (ii) a corridor, passageway, or the like — 2.1 m; and
- (c) in a Class 9a *health-care building*—
 - (i) a *patient care area* — 2.4 m; and
 - (ii) an operating theatre or delivery room — 3 m; and
 - (iii) a treatment room, clinic, waiting room, passageway, corridor, or the like — 2.4 m; and
- (d) in a Class 9b building—

Deemed-to-Satisfy Provisions

- (i) a *school* classroom or other *assembly building* or part that accommodates not more than 100 persons — 2.4 m; and
- (ii) a theatre, public hall or other *assembly building* or part that accommodates more than 100 persons — 2.7 m; and
- (e) in a Class 9c *aged care building* —
 - (i) a kitchen, laundry, or the like — 2.1 m; and
 - (ii) a corridor, passageway or the like — 2.4 m; and
 - (iii) a *habitable room* excluding a kitchen — 2.4 m; and
- (f) in any building—
 - (i) a bathroom, shower room, *sanitary compartment*, airlock, tea preparation room, pantry, store room, garage, car parking area, or the like — 2.1 m; and
 - (ii) a commercial kitchen — 2.4 m; and
 - (iii) above a stairway, ramp, landing or the like — 2 m measured vertically above the nosing line of stairway treads or the floor surface of the ramp, landing or the like.

Vic F3.101—F3.103

PART F4 LIGHT AND VENTILATION

OBJECTIVE

FO4

The *Objective* of this Part is to—

- (a) safeguard occupants from injury, illness or loss of amenity due to—
 - (i) isolation from natural light; and
 - (ii) lack of adequate artificial lighting; and
- (b) safeguard occupants from illness or loss of amenity due to lack of air freshness.

FUNCTIONAL STATEMENTS

FF4.1

A space within a building used by occupants is to be provided with openings to admit natural light consistent with its function or use.

FF4.2

A space within a building used by occupants is to be provided with artificial lighting consistent with its function or use which, when activated in the absence of suitable natural light, will enable safe movement.

FF4.3

A space used by occupants within a building is to be provided with adequate ventilation consistent with its function or use.

PERFORMANCE REQUIREMENTS

FP4.1

Sufficient openings must be provided and distributed in a building so that natural light, when available, provides a level of *illuminance* appropriate to the function or use of that part of the building.

FP4.2

Artificial lighting must be installed to provide a level of *illuminance* appropriate to the function or use of the building to enable safe movement by occupants.

FP4.3

A space in a building used by occupants must be provided with means of ventilation with *outdoor air* which will maintain adequate air quality.

FP4.4

A mechanical air-handling system installed in a building must control—

- (a) the circulation of objectionable odours; and
- (b) the accumulation of harmful contamination by micro-organisms, pathogens and toxins.

FP4.5

Contaminated air must be disposed of in a manner which does not unduly create a nuisance or hazard to people in the building or *other property*.

PART F4 LIGHT AND VENTILATION

Deemed-to-Satisfy Provisions

F4.0 Deemed-to-Satisfy Provisions

- (a) Where a *Building Solution* is proposed to comply with the *Deemed-to-Satisfy Provisions, Performance Requirements FP4.1 to FP4.5* are satisfied by complying with **F4.1 to F4.12**.
- (b) Where a *Building Solution* is proposed as an *Alternative Solution* to the *Deemed-to-Satisfy Provisions* of **F4.1 to F4.12**., the relevant *Performance Requirements* must be determined in accordance with **A0.10**.

F4.1 Provision of natural light

Natural lighting must be provided in:

- (a) **Class 2 buildings and Class 4 parts of buildings** — to all *habitable rooms*.
- (b) **Class 3 buildings** — to all bedrooms and dormitories.
- (c) **Class 9a and 9c buildings** — to all rooms used for sleeping purposes.

Vic F4.1(d)

- (d) **Class 9b buildings** — to all general purpose classrooms in primary or secondary *schools* and all playrooms or the like for the use of children in an *early childhood centre*.

F4.2 Methods and extent of natural lighting

- (a) Subject to **Clause 3.6 of Specification C1.1**, *required* natural lighting must be provided by *windows* that—
 - (i) have an aggregate light transmitting area measured exclusive of framing members, glazing bars or other obstructions of not less than 10% of the *floor area* of the room; and
 - (ii) are open to the sky or face a court or other space open to the sky or an open verandah, carport or the like.

Vic F4.2(b)

- (b) Except in a Class 9c *aged care building*, in a Class 2, 3 or 9 building or Class 4 part of a building a *required window* that faces a boundary of an adjoining allotment or a wall of the same building or another building on the allotment must not be less than a horizontal distance from that boundary or wall that is the greater of—
 - (i) generally—1 m; and
 - (ii) in a *patient care area* or other room used for sleeping purposes in a Class 9a building—3 m; and
 - (iii) 50% of the square root of the exterior height of the wall in which the *window* is located, measured in metres from its sill.

Vic F4.2(c)

- (c) In a Class 9c *aged care building*, a *required window* must be transparent and located—

Deemed-to-Satisfy Provisions

- (i) in an *external wall* with the *window* sill not more than 1 m above the floor level; and
- (ii) where the *window* faces an adjoining allotment, another building or another wall of the same building, it must not be less than a horizontal distance of 3 m from the adjoining allotment, other building or wall.

F4.3 Natural light borrowed from adjoining room

Natural lighting to a room in a Class 2 building or Class 4 part of a building or in a *sole-occupancy unit* of a Class 3 building, may come through a glazed panel or opening from an adjoining room (including an enclosed verandah) if—

- (a) both rooms are within the same *sole-occupancy unit* or the enclosed verandah is on common property; and
- (b) the glazed panel or opening has an area of not less than 10% of the *floor area* of the room to which it provides light; and
- (c) the adjoining room has *windows* with an aggregate light transmitting area of not less than 10% of the combined *floor areas* of both rooms,

and the areas specified in (b) and (c) may be reduced as appropriate if direct natural light is provided from another source.

F4.4 Artificial lighting

- (a) Artificial lighting must be provided—
 - (i) in *required* stairways, passageways, and ramps; and
 - (ii) if natural lighting of a standard equivalent to that *required* by F4.2 is not available, and the periods of occupation or use of the room or space will create undue hazard to occupants seeking egress in an emergency, in—
 - (A) Class 4 parts of a building — to *sanitary compartments*, bathrooms, shower rooms, airlocks and laundries; and
 - (B) Class 2 buildings — to *sanitary compartments*, bathrooms, shower rooms, airlocks, laundries, common stairways and other spaces used in common by the occupants of the building; and
 - (C) Class 3, 5, 6, 7, 8 and 9 buildings — to all rooms that are frequently occupied, all spaces *required* to be *accessible*, all corridors, lobbies, internal stairways, other circulation spaces and paths of egress.
- (b) The artificial lighting system must comply with AS/NZS 1680.0.
- (c) The system may provide a lesser level of illumination to the following spaces during times when the level of lighting would be inappropriate for the use:
 - (i) A theatre, cinema or the like, when performances are in progress, with the exception of aisle lighting *required* by Part H1.
 - (ii) A museum, gallery or the like, where sensitive displays require low lighting levels.
 - (iii) A discotheque, nightclub or the like, where to create an ambience and character for the space, low lighting levels are used.

Deemed-to-Satisfy Provisions

F4.5 Ventilation of rooms

A *habitable room*, office, shop, factory, workroom, *sanitary compartment*, bathroom, shower room, laundry and any other room occupied by a person for any purpose must have—

- (a) natural ventilation complying with **F4.6**; or
NSW F4.5(b)
- (b) a mechanical ventilation or air-conditioning system complying with AS 1668.2 and AS/NZS 3666.1.

F4.6 Natural ventilation

Natural ventilation provided in accordance with **F4.5(a)** must consist of permanent openings, *windows*, doors or other devices which can be opened—

- (a) with an aggregate opening or openable size not less than 5% of the *floor area* of the room *required* to be ventilated; and
- (b) open to—
 - (i) suitably sized court, or space open to the sky; or
 - (ii) an open verandah, carport, or the like; or
 - (iii) an adjoining room in accordance with **F4.7**.

F4.7 Ventilation borrowed from adjoining room

Natural ventilation to a room may come through a *window*, opening, ventilating door or other device from an adjoining room (including an enclosed verandah) if both rooms are within the same *sole-occupancy unit* or the enclosed verandah is common property, and—

- (a) in a Class 2 building, a *sole-occupancy unit* of a Class 3 building or Class 4 part of a building—
 - (i) the room to be ventilated is not a *sanitary compartment*; and
 - (ii) the *window*, opening, door or other device has a ventilating area of not less than 5% of the *floor area* of the room to be ventilated; and
 - (iii) the adjoining room has a *window*, opening, door or other device with a ventilating area of not less than 5% of the combined *floor areas* of both rooms; and
- (b) in a Class 5, 6, 7, 8 or 9 building—
 - (i) the *window*, opening, door or other device has a ventilating area of not less than 10% of the *floor area* of the room to be ventilated, measured not more than 3.6 m above the floor; and
 - (ii) the adjoining room has a *window*, opening, door or other device with a ventilating area of not less than 10% of the combined *floor areas* of both rooms; and
- (c) the ventilating areas specified in (a) and (b) may be reduced as appropriate if direct natural ventilation is provided from another source.

F4.8 Restriction on position of water closets and urinals

A room containing a closet pan or urinal must not open directly into—

Deemed-to-Satisfy Provisions

- (a) a kitchen or pantry; or
- (b) a public dining room or restaurant; or
- (c) a dormitory in a Class 3 building; or
- (d) a room used for public assembly (which is not an *early childhood centre*, primary *school* or *open spectator stand*); or
- (e) a workplace normally occupied by more than one person.

F4.9 Airlocks

If a room containing a closet pan or urinal is prohibited under F4.8 from opening directly to another room—

- (a) in a *sole-occupancy unit* in a Class 2 or 3 building or Class 4 part of a building—
 - (i) access must be by an airlock, hallway or other room; or
 - (ii) the room containing the closet pan or urinal must be provided with mechanical exhaust ventilation; and
- (b) in a Class 5, 6, 7, 8 or 9 building (which is not an *early childhood centre*, primary *school* or *open spectator stand*)—
 - (i) access must be by an airlock, hallway or other room with a *floor area* of not less than 1.1 m² and fitted with *self-closing* doors at all access doorways; or
 - (ii) the room containing the closet pan or urinal must be provided with mechanical exhaust ventilation and the doorway to the room adequately screened from view.

F4.10 * * * * *

This clause has deliberately been left blank. Its content covering sub-floor ventilation has been relocated to F1.12.

F4.11 Carparks

Every *storey* of a *carpark*, except an *open-deck carpark*, must have—

- (a) a system of ventilation complying with AS 1668.2; or
- (b) an adequate system of permanent natural ventilation.

F4.12 Kitchen local exhaust ventilation

A commercial kitchen must be provided with a kitchen exhaust hood complying with AS/NZS 1668.1 and AS 1668.2 where—

- (a) any cooking apparatus has—
 - (i) a total maximum electrical power input exceeding 8 kW; or
 - (ii) a total gas power input exceeding 29 MJ/h; or
- (b) the total maximum power input to more than one apparatus exceeds—
 - (i) 0.5 kW electrical power; or
 - (ii) 1.8 MJ gas,

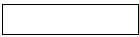

Deemed-to-Satisfy Provisions

per m² of *floor area* of the room or enclosure.

Tas F4.101

PART F5 SOUND TRANSMISSION AND INSULATION

NT Part F5

OBJECTIVE

F05

The *Objective* of this Part is to safeguard occupants from illness or loss of amenity as a result of undue sound being transmitted—

- (a) between adjoining *sole-occupancy units*; and
- (b) from common spaces to *sole-occupancy units*; and
- (c) from parts of different classifications to *sole-occupancy units*.

Application:

F05 only applies to a Class 2 or 3 building or a Class 9c *aged care building*.

FUNCTIONAL STATEMENT

FF5.1

A part of a building that separates *sole-occupancy units*, or separates a *sole-occupancy unit* from a common space or part of another classification within the building is to be constructed to prevent undue sound transmission.

Application:

FF5.1 only applies to a Class 2 or 3 building or a Class 9c *aged care building*.

PERFORMANCE REQUIREMENTS

FP5.1

Floors separating—

- (a) *sole-occupancy units*: or
- (b) a *sole-occupancy units* from a plant room, lift *shaft*, stairway, *public corridor*, public lobby, or the like, or a part of a different classification,

must provide insulation against the transmission of airborne and impact generated sound sufficient to prevent illness or loss of amenity to the occupants.

Application:

FP5.1 only applies to a Class 2 or 3 building .

FP5.2

Walls separating sole-occupancy units or a *sole-occupancy unit* from a plant room, lift *shaft*, stairway, *public corridor*, public lobby, or the like, or parts of a different classification, must provide insulation against the transmission of—

- (a) airborne sound; and
- (b) impact generated sound, if the wall is separating a bathroom, *sanitary compartment*, laundry or kitchen in one *sole-occupancy unit* from a *habitable room* (other than a kitchen) in an adjoining unit,

sufficient to prevent illness or loss of amenity to the occupants.

Application:

FP5.2 only applies to a Class 2 or 3 building.

FP5.3

The *required* sound insulation of a floor or a wall must not be compromised by—

- (a) the incorporation or penetration of a pipe or other service element; or
- (b) a door assembly.

Application

FP5.3 only applies to a Class 2 or 3 building.

FP5.4

Floors separating *sole-occupancy units* must provide insulation against the transmission of airborne and impact generated sound sufficient to prevent illness or loss of amenity to the occupants.

Application

FP5.4 only applies to a Class 9c *aged care building*.

FP5.5

Walls separating *sole-occupancy units*, or a *sole-occupancy unit* from a kitchen, bathroom, *sanitary compartment* (not being an associated ensuite), laundry, plant room or utilities room, must provide insulation against the transmission of—

- (a) airborne sound; and
- (b) impact generated sound, if the wall separates a *sole-occupancy unit* from a kitchen or laundry,

sufficient to prevent illness or loss of amenity to the occupants.

Application

FP5.5 only applies to a Class 9c *aged care building*.

FP5.6

The required sound insulation of a floor or a wall must not be compromised by the incorporation or penetration of a pipe or other service element.

Application

FP5.6 only applies to a Class 9c *aged care building*.

VERIFICATION METHODS

FV5.1

Compliance with **FP5.1** and **FP5.3** to avoid the transmission of airborne and impact generated sound through floors is verified when it is measured in-situ that the separating floor has—

- (a) airborne: a weighted standardised level difference with spectrum adaptation term ($D_{nT,w} + C_{tr}$) not less than 45 when determined under AS/NZS 1276.1 or ISO 717.1; and
- (b) impact: a weighted standardised impact sound pressure level with spectrum adaptation term ($L_{nT,w} + C_I$) not more than 62 when determined under AS/ISO 717.2.

FV5.2

Compliance with **FP5.2(a)** and **FP5.3** to avoid the transmission of airborne sound through walls is verified when it is measured in-situ that—

- (a) a wall separating *sole-occupancy units* has a weighted standardised level difference with spectrum adaptation term ($D_{nT,w} + C_{tr}$) not less than 45 when determined under AS/NZS 1276.1 or ISO 717.1; or
- (b) a wall separating a *sole-occupancy unit* from a plant room, lift *shaft*, stairway, *public corridor*, public lobby, or the like, or parts of a different classification, has a weighted standardised level difference ($D_{nT,w}$) not less than 45 when determined under AS/NZS 1276.1 or ISO 717.1; or
- (c) any door assembly located in a wall that separates a sole-occupancy unit from a stairway, public corridor, public lobby, or the like, has a weighted standardised level difference ($D_{nT,w}$) not less than 25 when determined under AS/NZS 1276.1 or ISO 717.1.

PART F5

SOUND TRANSMISSION AND INSULATION

Deemed-to-Satisfy Provisions

NT Part F5

F5.0 Deemed-to-Satisfy Provisions

- (a) Where a *Building Solution* is proposed to comply with the *Deemed-to-Satisfy Provisions, Performance Requirements FP5.1 to FP5.6* are satisfied by complying with **F5.1 to F5.7**.
- (b) Where a *Building Solution* is proposed as an *Alternative Solution* to the *Deemed-to-Satisfy Provisions* of **F5.1 to F5.7**, the relevant *Performance Requirements* must be determined in accordance with **A0.10**.

F5.1 Application of Part

The *Deemed-to-Satisfy Provisions* of this Part apply to Class 2 and 3 buildings and Class 9c *aged care buildings*.

F5.2 Determination of airborne sound insulation ratings

A form of construction *required* to have an airborne sound insulation rating must—

- (a) have the *required* value for weighted sound reduction index (R_w) or weighted sound reduction index with spectrum adaptation term ($R_w + C_{tr}$) determined in accordance with AS/NZS 1276.1 or ISO 717.1 using results from laboratory measurements; or
- (b) comply with **Specification F5.2**.

F5.3 Determination of impact sound insulation ratings

- (a) A floor in a building *required* to have an impact sound insulation rating must—
 - (i) have the *required* value for weighted normalised impact sound pressure level with spectrum adaptation term ($L_{n,w} + C_i$) determined in accordance with AS/ISO 717.2 using results from laboratory measurements; or
 - (ii) comply with **Specification F5.2**.
- (b) A wall in a building required to have an impact sound insulation rating must—
 - (i) for a Class 2 or 3 building be of discontinuous construction; and
 - (ii) for a Class 9c *aged care building*, must—
 - (A) for other than masonry, be two or more separate leaves without rigid mechanical connection except at the periphery; or
 - (B) be identical with a prototype that is no less resistant to the transmission of impact sound when tested in accordance with **Specification F5.5** than a wall listed in Table 2 of **Specification F5.2**.
- (c) For the purposes of this Part, discontinuous construction means a wall having a minimum 20 mm cavity between 2 separate leaves, and
 - (i) for masonry, where wall ties are required to connect leaves, the ties are of the resilient type; and

Deemed-to-Satisfy Provisions

- (ii) for other than masonry, there is no mechanical linkage between leaves except at the periphery.

F5.4 Sound insulation rating of floors

- (a) A floor in a Class 2 or 3 building must have an $R_w + C_{tr}$ (airborne) not less than 50 and an $L_{n,w} + C_I$ (impact) not more than 62 if it separates—
 - (i) *sole-occupancy units*; or
 - (ii) a *sole-occupancy unit* from a plant room, lift *shaft*, stairway, *public corridor*, public lobby or the like, or parts of a different classification.
- (b) A floor in a Class 9c *aged care building* separating *sole-occupancy units* must have an R_w not less than 45.

F5.5 Sound insulation rating of walls

- (a) A wall in a Class 2 or 3 building must —
 - (i) have an $R_w + C_{tr}$ (airborne) not less than 50, if it separates *sole-occupancy units*; and
 - (ii) have an R_w (airborne) not less than 50, if it separates a *sole-occupancy unit* from a plant room, lift *shaft*, stairway, *public corridor*, public lobby or the like, or parts of a different classification; and
 - (iii) comply with **F5.3(b)** if it separates:
 - (A) a bathroom, *sanitary compartment*, laundry or kitchen in one *sole-occupancy unit* from a *habitable room* (other than a kitchen) in an adjoining unit; or
 - (B) a *sole-occupancy unit* from a plant room or lift *shaft*.
- (b) A door may be incorporated in a wall in a Class 2 or 3 building that separates a *sole-occupancy unit* from a stairway, *public corridor*, public lobby or the like, provided the door assembly has an R_w not less than 30.
- (c) A wall in a Class 9c *aged care building* must have an R_w not less than 45 if it separates—
 - (i) *sole-occupancy units*; or
 - (ii) a *sole-occupancy unit* from a kitchen, bathroom, *sanitary compartment* (not being an associated ensuite), laundry, plant room or utilities room.
- (d) In addition to (c), a wall separating a *sole-occupancy unit* in a Class 9c *aged care building* from a kitchen or laundry must comply with **F5.3(b)**.
- (e) Where a wall *required* to have sound insulation has a floor above, the wall must continue to—
 - (i) the underside of the floor above; or
 - (ii) a ceiling that provides the sound insulation *required* for the wall.
- (f) Where a wall *required* to have sound insulation has a roof above, the wall must continue to—
 - (i) the underside of the roof above; or
 - (ii) a ceiling that provides the sound insulation *required* for the wall.

Deemed-to-Satisfy Provisions

F5.6 Sound insulation rating of services

- (a) If a duct, soil, waste or water supply pipe, including a duct or pipe that is located in a wall or floor cavity, serves or passes through more than one *sole-occupancy unit*, the duct or pipe must be separated from the rooms of any *sole-occupancy unit* by construction with an $R_w + C_{tr}$ (airborne) not less than—
- (i) 40 if the adjacent room is a *habitable room* (other than a kitchen); or
 - (ii) 25 if the adjacent room is a kitchen or non-*habitable room*.
- (b) If a storm water pipe passes through a *sole-occupancy unit* it must be separated in accordance with (a)(i) and (ii).

F5.7 Sound isolation of pumps

A flexible coupling must be used at the point of connection between the service pipes in a building and any circulating or other pump.

SPECIFICATION **F5.2** SOUND INSULATION FOR BUILDING ELEMENTS

Deemed-to-Satisfy Provisions

1. Scope

- (a) This Specification lists the weighted sound reduction index R_w for some common forms of construction.
- (b) Wall systems listed in Table 2 having a minimum 20 mm cavity between 2 separate leaves, with
 - (i) for masonry, where wall ties are required to connect leaves, the ties are of the resilient type; and
 - (ii) for other than masonry, there is no mechanical linkage between leaves except at the periphery,are deemed to be discontinuous construction.

2. Construction deemed-to-satisfy

The forms of construction listed in **Table 2** for wall construction and **Table 3** for floor construction, are considered to have the R_w , $R_w + C_{tr}$ and $L_{n,w} + C_l$ stated in that Table. The forms of construction must be installed as follows:

- (a) **Masonry** — Units must be laid with all joints filled solid, including those between the masonry and any adjoining construction.
- (b) **Concrete slabs** — Joints between concrete slabs or panels and any adjoining construction must be filled solid.
- (c) **Sheeting materials**—
 - (i) if one layer is *required* on both sides of a wall, it must be fastened to the studs with joints staggered on opposite sides; and
 - (ii) if two layers are *required*, the second layer must be fastened over the first layer so that the joints do not coincide with those of the first layer; and
 - (iii) joints between sheets or between sheets and any adjoining construction must be taped and filled solid.
- (d) **Timber or steel-framed construction** — perimeter framing members must be securely fixed to the adjoining structure and—
 - (i) bedded in resilient compound; or
 - (ii) the joints must be caulked so that there are no voids between the framing members and the adjoining structure.
- (e) **Services**—
 - (i) Services must not be chased into concrete or masonry elements.
 - (ii) A door or panel *required* to have a certain $R_w + C_{tr}$ that provides access to a duct, pipe or other service must—

Deemed-to-Satisfy Provisions

- (A) not open into any *habitable room* (other than a kitchen); and
- (B) be firmly fixed so as to overlap the frame or rebate of the frame by not less than 10 mm, be fitted with a sealing gasket along all edges and be constructed of—
 - (aa) wood, particleboard or blockboard not less than 33 mm thick; or
 - (bb) compressed fibre reinforced cement sheeting not less than 9 mm thick; or
 - (cc) other suitable material with a mass per unit area not less than 24.4 kg/m²
- (iii) A water supply pipe must—
 - (A) only be installed in the cavity of discontinuous construction; and
 - (B) in the case of a pipe that serves only one *sole-occupancy unit*, not be fixed to the wall leaf on the side adjoining any other *sole-occupancy unit* and have a clearance not less than 10 mm to the other wall leaf.
- (iv) Electrical outlets must be offset from each other—
 - (A) in masonry walling, not less than 100 mm; and
 - (B) in timber or steel framed walling, not less than 300 mm.

Table 2 ACCEPTABLE FORMS OF CONSTRUCTION FOR WALLS

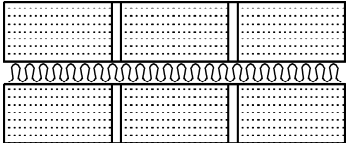
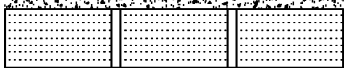
Description	$R_w + C_{tr}$ (not less than)	R_w (not less than)	Construction
Wall construction type: Masonry			
Two leaves of 110 mm clay brick masonry with:			
(a) cavity not less than 50 mm between leaves; and	50	50	
(b) 50 mm thick glass wool insulation with a density of 11 kg/m ³ or 50 mm thick polyester insulation with a density of 20 kg/m ³ in the cavity.			
Two leaves of 110 mm clay brick masonry with:			
(a) cavity not less than 50 mm between leaves; and	50	50	
(b) 13 mm cement render on each outside face.			







Deemed-to-Satisfy Provisions

Table 2 ACCEPTABLE FORMS OF CONSTRUCTION FOR WALLS— continued

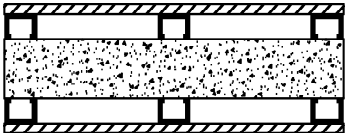
Description	$R_w + C_{tr}$ (not less than)	R_w (not less than)	Construction
<p>Single leaf of 110 mm clay brick masonry with:</p> <p>(a) a row of 70 mm x 35 mm timber studs or 64 mm steel studs at 600 mm centres, spaced 20 mm from the masonry wall; and</p> <p>(b) 50 mm thick mineral insulation or glass wool insulation with a density of 11 kg/m³ positioned between studs; and</p> <p>(c) one layer of 13 mm plasterboard fixed to outside face of studs and outside face of masonry.</p>	50	50	
<p>Single leaf of 90 mm clay brick masonry with:</p> <p>(a) a row of 70 mm x 35 mm timber studs or 64 mm steel studs at 600 mm centres, spaced 20 mm from each face of the masonry wall; and</p> <p>(b) 50 mm thick mineral insulation or glass wool insulation with a density of 11 kg/m³ positioned between studs in each row; and</p> <p>(c) one layer of 13 mm plasterboard fixed to studs on each outside face.</p>	50	50	
Single leaf of 150 mm brick masonry with 13 mm cement render on each face.	-	50	
Single leaf of 220 mm brick masonry with 13 mm cement render on each face.	50	50	
110 mm thick brick masonry with 13 mm cement render on each face.	-	45	
110 mm thick concrete brickwork.	-	45	
Wall construction type: Concrete			
150 mm thick plain off form concrete.	50	50	

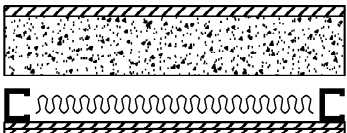
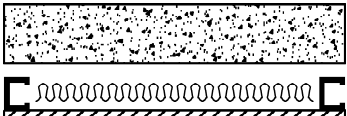

Deemed-to-Satisfy Provisions

Table 2 ACCEPTABLE FORMS OF CONSTRUCTION FOR WALLS— continued

Description	$R_w + C_{tr}$ (not less than)	R_w (not less than)	Construction
150 mm thick concrete panel with one layer of 10 mm plasterboard fixed to 28 mm metal furring channels on each face.	-	50	
200 mm thick concrete panel with one layer of 13 mm plasterboard or 13 mm cement render on each face.	50	50	
100 mm thick concrete panel with: (a) a row of 64 mm steel studs at 600 mm centres, spaced 25 mm from the concrete panel; and (b) 80 mm thick polyester insulation or 50 mm thick glass wool insulation with a density of 11 kg/m ³ , positioned between studs; and (c) two layers of 13 mm plasterboard fixed to outside face of studs and one layer of 13 mm plasterboard fixed to outside face of concrete panel.	50	50	
125 mm thick concrete panel with: (a) a row of 64 mm steel studs at 600 mm centres, spaced 20 mm from the concrete panel; and (b) 70 mm polyester insulation with a density of 9 kg/m ³ , positioned between studs; and (c) one layer of 13 mm plasterboard fixed to the outside face of the studs.	50	50	
125 mm thick concrete panel.	-	50	
100 mm concrete panel with 13 mm cement render or one layer of 13 mm plasterboard on each face.	-	50	
190 mm thick concrete blockwork.	-	45	
140 mm thick concrete blockwork, the face shell thickness of the blocks being not less than 44 mm and with:			

Deemed-to-Satisfy Provisions

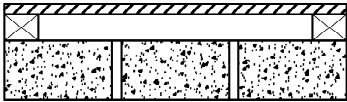
Table 2 ACCEPTABLE FORMS OF CONSTRUCTION FOR WALLS— continued

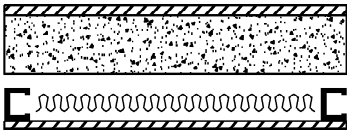
Description	$R_w + C_{tr}$ (not less than)	R_w (not less than)	Construction
(a) 50 mm x 50 mm timber battens spaced at not more than 610 mm centres screw-fixed on one face of the blocks into resilient plugs with rubber inserts between battens and the wall; and (b) the face of the battens clad with 13 mm plasterboard.	-	45	
In-situ concrete- 100 mm thick.	-	45	
Precast concrete- 100 mm thick and without joints.	-	45	
Wall construction type: Autoclaved aerated concrete			
75 mm thick autoclaved aerated concrete wall panel with:			
(a) a row of 64 mm steel studs at 600 mm centres, spaced 20 mm from the autoclaved aerated concrete wall panel; and (b) 75 mm thick glass wool insulation with a density of 11 kg/m ³ positioned between studs; and (c) one layer of 10 mm moisture resistant plasterboard or 13 mm fire protective grade plasterboard fixed to outside face of studs and outside face of autoclaved aerated concrete wall panel.	50	50	

Deemed-to-Satisfy Provisions

Table 2 ACCEPTABLE FORMS OF CONSTRUCTION FOR WALLS— continued

Description	$R_w + C_{tr}$ (not less than)	R_w (not less than)	Construction
<p>75 mm thick autoclaved aerated concrete wall panel with:</p> <p>(a) a row of 64 mm steel studs at 600 mm centres, spaced 35 mm from the autoclaved aerated concrete panel wall; and</p> <p>(b) 28 mm metal furring channels fixed to the outside face of the autoclaved aerated concrete wall panel, with 50 mm thick polyester insulation with a density of 9 kg/m³ positioned between furring channels and one layer of 13 mm fire protective grade plasterboard fixed to furring channels; and</p> <p>(c) 105 mm thick glass wool insulation with a density of 7 kg/m³ positioned between studs; and</p> <p>(d) one layer of 13 mm fire protective grade plasterboard fixed to the outside face of the studs.</p>	50	50	
<p>Two leaves of 75 mm autoclaved aerated concrete wall panel with:</p> <p>(a) a cavity not less than 30 mm between panels containing 50 mm glass wool insulation with a density of 11 kg/m³; and</p> <p>(b) one layer of 10 mm plasterboard fixed to outside face of each panel.</p>	50	50	
<p>75 mm thick autoclaved aerated concrete wall panel with:</p> <p>(a) one layer of 10 mm moisture resistant plasterboard on one face; and</p> <p>(b) 28 mm metal furring channels and resilient mounts, 75 mm polyester insulation with a density of 9 kg/m³ and 13 mm fire protective grade plasterboard fixed to the other face.</p>	-	50	
Wall construction type: Timber and steel framing			
Two rows of 90 x 35 mm timber studs or two rows of 64 mm steel studs at 600 mm centres with:			

Deemed-to-Satisfy Provisions

Table 2 ACCEPTABLE FORMS OF CONSTRUCTION FOR WALLS— continued

Description	$R_w + C_{tr}$ (not less than)	R_w (not less than)	Construction
<p>(a) an air gap not less than 20 mm between the rows of studs; and</p> <p>(b) 50 mm thick glass wool insulation or 60 mm thick polyester insulation with a density of 11 kg/m³; positioned between one row of studs, and</p> <p>(c) two layers of 13 mm fire protective grade plasterboard or one layer of 6 mm fibre cement sheet and one layer of 13 mm fire protective grade plasterboard, fixed to outside face of studs.</p>	50	50	
<p>Two rows of 64 mm steel studs at 600 mm centres with:</p> <p>(a) an air gap not less than 80 mm between the rows of studs; and</p> <p>(b) 200 mm thick polyester insulation with a density of 14 kg/m³; positioned between studs; and</p> <p>(c) one layer of 13 mm fire-protective grade plasterboard and one layer 13 mm plasterboard on one outside face and one layer of 13 mm fire-protective grade plasterboard on the other outside face</p>	50	50	
<p>One row of 92 mm steel studs at 600 mm centres with:</p> <p>(a) 50 mm thick glass wool insulation with a density of 11 kg/m³ or 60 mm thick polyester insulation with a density of 8 kg/m³, positioned between studs; and</p> <p>(b) two layers of 13 mm fire protective grade plasterboard or one layer of 6 mm fibre cement sheet and one layer of 13 mm fire protective grade plasterboard, fixed to each face.</p>	-	50	
<p>One row of 64 mm steel studs with 2 layers of 16 mm fire-protective grade plasterboard fixed to each face.</p>	-	45	
<p>One row of 64 mm steel studs with:</p>			

Deemed-to-Satisfy Provisions

Table 2 ACCEPTABLE FORMS OF CONSTRUCTION FOR WALLS— continued



Description	$R_w + C_{tr}$ (not less than)	R_w (not less than)	Construction
(a) 1 layer of 16 mm fire-protective grade plasterboard fixed to one face; and (b) 50 mm thick mineral insulation or glass wool insulation with a density of 11 kg/m ³ positioned between the studs; and (c) 2 layers of fire-protective grade plasterboard fixed to the other face, the inner layer being 16 mm thick and the outer layer being 13 mm.	-	45	
One row of 64 mm steel studs with 2 layers of 13 mm plasterboard on each face.	-	45	

Table 3 ACCEPTABLE FORMS OF CONSTRUCTION FOR FLOORS

Description	$R_w + C_{tr}$ (not less than)	$L_{n,w} + C_l$ (not more than)	R_w (not less than)	Construction
Floor construction type: Concrete				
150 mm thick concrete slab with:				
(a) 28 mm metal furring channels and isolation mounts fixed to underside of slab, at 600 mm centres; and (b) 65 mm thick polyester insulation with a density of 8 kg/m ³ , positioned between furring channels; and (c) one layer of 13 mm plasterboard fixed to furring channels.	50	62	50	
200 mm thick concrete slab with carpet on underlay.	50	62	50	
100 mm thick concrete slab.	45	-	45	

Deemed-to-Satisfy Provisions

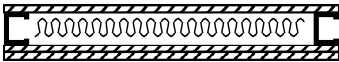
Table 3 ACCEPTABLE FORMS OF CONSTRUCTION FOR FLOORS— continued

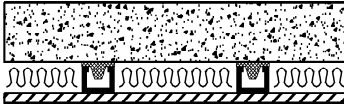
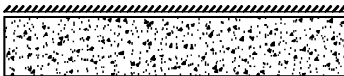
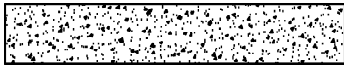
Description	$R_w + C_{tr}$ (not less than)	$L_{n,w} + C_1$ (not more than)	R_w (not less than)	Construction
Floor construction type: Autoclaved aerated concrete				
75 mm thick autoclaved aerated concrete floor panel with:				
<ul style="list-style-type: none"> (a) 8 mm ceramic tiles with flexible adhesive and waterproof membrane, located above the slab; and (b) timber joists at 600 mm centres; and (c) R1.5 glass wool insulation positioned between timber joists; and (d) 28 mm metal furring channels and resilient mounts fixed to underside of joists; and (e) two layers of 13 mm plasterboard fixed to furring channels. 	50	62	50	
Floor construction type: Timber				
19 mm thick chipboard floor sheeting with:				
<ul style="list-style-type: none"> (a) 190 x 45 mm timber joists at 450 mm centres; and (b) R2.5 glass wool insulation positioned between timber joists; and (c) 28 mm metal furring channels and isolation mounts fixed to underside of joists, isolation mounts to be of natural rubber with a dynamic factor of not more than 1.1 and static deflection of not less than 3 mm at actual operating load; and (d) two layers of 16 mm fire-protective grade plasterboard fixed to furring channels. 	50	62	50	

Deemed-to-Satisfy Provisions

Table 3 ACCEPTABLE FORMS OF CONSTRUCTION FOR FLOORS— continued

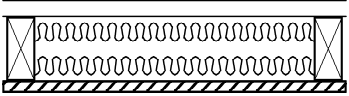
Description	$R_w + C_{tr}$ (not less than)	$L_{n,w} + C_1$ (not more than)	R_w (not less than)	Construction
<p>19 mm thick tongued and grooved boards with:</p> <p>(a) timber joists not less than 175 mm x 50 mm; and</p> <p>(b) 75 mm thick mineral insulation or glass wool insulation with a density of 11 kg/m³ positioned between joists and laid on 10 mm thick plasterboard fixed to underside of joists; and</p> <p>(c) 25 mm thick mineral insulation or glass wool insulation with a density of 11 kg/ m³ laid over entire floor, including tops of joists before flooring is laid; and</p> <p>(d) secured to 75 mm x 50 mm battens; and</p> <p>(e) the assembled flooring laid over the joists, but not fixed to them, with the battens lying between the joists.</p>	-	-	45	

SPECIFICATION **F5.5** **IMPACT SOUND — TEST OF EQUIVALENCE**

Deemed-to-Satisfy Provisions

1. Scope

This Specification describes a method of test to determine the comparative resistance of walls to the transmission of impact sound.

2. Construction to be tested

- (a) The test is conducted on a specimen of prototype wall construction and on a specimen of one or other of the constructions specified in **Table 2 of Specification F5.2**.
- (b) The testing of a construction specified in **Table 2 of Specification F5.2** need not be repeated for subsequent comparisons provided complete records of the results, the test equipment and the technique of testing are kept so that identical equipment can be employed and an identical technique can be adopted in the testing of specimens of prototype wall construction.

3. Method

- (a) The wall constructions to be compared must be tested in accordance with AS 1191.
- (b) A horizontal steel platform 510 mm x 460 mm x 10 mm thick must be placed with one long edge in continuous and direct contact with the wall to be tested on the side of the wall on which the impact sound is to be generated.
- (c) A tapping machine complying with ISO 140/6 — 1998 (E) must be mounted centrally on the steel platform.
- (d) The sound transmission through the wall must be determined in accordance with AS 1191 except that the tapping machine as mounted on the steel platform must be used as the source of sound.
- (e) The impact sound pressure levels measured in the receiving room must be converted into normalised levels using a reference equivalent absorption area of 10 m².

ANCILLARY PROVISIONS

- G1 Minor Structures and Components**

- G2 Heating Appliances, Fireplaces, Chimneys and Flues**

- G3 Atrium Construction**

- G4 Construction in Alpine Areas**

- G5 Construction in Bushfire Prone Areas**

SECTION G CONTENTS

SECTION G ANCILLARY PROVISIONS

Part G1 Minor Structures and Components

Objective GO1

Functional Statements GF1.1 - GF1.3

Performance Requirements GP1.1 - GP1.4

G1.0 Deemed-to-Satisfy Provisions

G1.1 Swimming pools

G1.2 Refrigerated chambers, strong-rooms and vaults

Part G2 Heating Appliances, Fireplaces, Chimneys and Flues

Objective GO2

Functional Statements GF2.1 - GF2.2

Performance Requirements GP2.1 - GP2.2

G2.0 Deemed-to-Satisfy Provisions

G2.1 * * * * *

G2.2 Installation of appliances

G2.3 Open fireplaces

G2.4 Incinerator rooms

Part G3 Atrium Construction

G3.1 Atriums affected by this Part

G3.2 Dimensions of atrium well

G3.3 Separation of atrium by bounding walls

G3.4 Construction of bounding walls

G3.5 Construction at balconies

G3.6 Separation at roof

G3.7 Means of egress

G3.8 Fire and smoke control systems

Specification G3.8 Fire and Smoke Control Systems in Buildings Containing
Atriums

Part G4 Construction in Alpine Areas

Objective GO4

Functional Statement GF4.1

Performance Requirements GP4.1 - GP4.4

G4.0 Deemed-to-Satisfy Provisions

G4.1 Application of Part

G4.2 * * * * *

G4.3 External doorways

G4.4 Emergency lighting

G4.5 External ramps

G4.6 Discharge of exits

G4.7 External trafficable structures

G4.8 Fire-fighting services and equipment
G4.9 Fire orders

Part G5 Construction in Bushfire Prone Areas

Objective GO5
Functional Statement GF5.1
Performance Requirement GP5.1
G5.0 Deemed-to-Satisfy Provisions
G5.1 Application of Part
G5.2 Protection

ACT Appendix (Additional provisions and variations — refer to ACT Contents for full details)

NSW Appendix (Additional provisions and variations — refer to NSW Contents for full details)

Qld Appendix (Additional provisions and variations — refer to Qld Contents for full details)

SA Appendix (Additional provisions and variations — refer to SA Contents for full details)

Tas Appendix (Additional provisions and variations — refer to Tas Contents for full details)

Vic Appendix (Additional provisions and variations — refer to Vic Contents for full details)

PART G1 **MINOR STRUCTURES AND COMPONENTS**

OBJECTIVE

GO1

The *Objective* of this Part is to—

- (a) safeguard people from illness caused by the discharge of *swimming pool* waste water; and
- (b) protect *other property* from damage caused by the discharge of *swimming pool* waste water; and
- (c) safeguard young children from drowning or injury in a *swimming pool*; and

Application

GO1(a) and **(b)** do not apply in NT.

GO1(c) does not apply in NSW, NT, Qld and WA.

GO1(c), in ACT, SA and Tas, only applies to a *swimming pool* associated with a Class 2 or 3 building or Class 4 part of a building, with a depth of water more than 300 mm.

GO1(c), in Vic, only applies to a *swimming pool* with a depth of water more than 300 mm, associated with—

- (a) a Class 2 or 3 building or Class 4 part of a building; or
- (b) a *children's service*.

- (d) safeguard people from drowning or injury due to suction by a *swimming pool* water recirculation system.

Application

GO1(d) only applies to a *swimming pool* with a depth of water more than 300 mm.

- (e) safeguard occupants from illness or injury resulting from being accidentally locked inside spaces which are designed to be entered for short periods of time only and in which occupation for longer periods may be hazardous.

Tas GO1(f), (g), (h)

FUNCTIONAL STATEMENTS

GF1.1

Adequate means for the disposal of *swimming pool* water and drainage is to be provided to a *swimming pool*.

Application

GF1.1 does not apply in NT.

GF1.2

A *swimming pool* is to be provided with—

- (a) means of restricting access by young children to it; and

Application

GF1.2(a) does not apply in NSW, NT, Qld and WA.

GF1.2(a), in ACT, SA and Tas, only applies to a *swimming pool* associated with a Class 2 or 3 building or Class 4 part of a building, with a depth of water more than 300 mm.

GF1.2(a), in Vic, only applies to a *swimming pool* with a depth of water more than 300 mm, associated with—

- (a) a Class 2 or 3 building or Class 4 part of a building; or
- (b) a *children's service*.

- (b) means to reduce the possibility of a person being entrapped or injured due to suction by a water recirculation system.

Application

GF1.2(b) only applies to a *swimming pool* with a depth of water more than 300 mm.

GF1.3

Any refrigerated or cooling chamber, strong-room and vault or the like that is capable of accommodating a person is to have safety measures to facilitate escape and for alerting people outside such a space in the event of an emergency.

TAS GF1.4 — 1.6

PERFORMANCE REQUIREMENTS

GP1.1

A *swimming pool* must have adequate means of draining the pool in a manner which will not—

- (a) cause illness to people; or
- (b) affect *other property*.

Application

GP1.1 does not apply in NT.

GP1.2

- (a) A barrier must be provided to a *swimming pool* and must—
- (i) be continuous for the full extent of the hazard; and
 - (ii) be of a strength and rigidity to withstand the foreseeable impact of people; and
 - (iii) restrict the access of young children to the pool and the immediate pool surrounds; and
 - (iv) have any gates and doors fitted with latching devices not readily operated by young children, and constructed to automatically close and latch.

Application

GP1.2(a) does not apply in NSW, NT, Qld and WA.

GP1.2(a), in ACT, SA and Tas, only applies to a *swimming pool* associated with a Class 2 or 3 building or Class 4 part of a building, with a depth of water more than 300 mm.

GP1.2(a), in Vic, only applies to a *swimming pool* with a depth of water more than 300 mm, associated with—

- (a) a Class 2 or 3 building or Class 4 part of a building; or
- (b) a *children's service*.

- (b) A *swimming pool* water recirculation system must incorporate safety measures to avoid entrapment of, or injury to, a person.

Application

GP1.2(b) only applies to a *swimming pool* with a depth of water more than 300 mm.

GP1.3

Any refrigerated or cooling chamber, or the like which is of sufficient size for a person to enter must—

- (a) have adequate means of communicating with or alerting other occupants in the building in the case of an emergency; and
- (b) have a door which is—
 - (i) of adequate dimensions to allow occupants to readily escape; and
 - (ii) openable from inside without a key at all times.

GP1.4

Any strong-room, vault or the like which is of sufficient size for a person to enter must—

- (a) have adequate means of communicating with or alerting other occupants in the building in the case of an emergency; and
- (b) have internal lighting controllable only from within the room; and
- (c) have an external indicator that the room is occupied.

Tas GP1.5–1.9

PART G1 MINOR STRUCTURES AND COMPONENTS

Deemed-to-Satisfy Provisions

G1.0 Deemed-to-Satisfy Provisions

- (a) *Performance Requirement GP1.1* must be complied with.

There is no *Deemed-to-Satisfy Provision* for this *Performance Requirement*.

Tas G1.0(b)

- (b) Where a *Building Solution* is proposed to comply with the *Deemed-to-Satisfy Provisions*, *Performance Requirements GP1.2* to *GP1.4* are satisfied by complying with **G1.1** and **G1.2**.
- (c) Where a *Building Solution* is proposed as an *Alternative Solution* to the *Deemed-to-Satisfy Provisions* of **G1.1** and **G1.2**, the relevant *Performance Requirements* must be determined in accordance with **A0.10**.

G1.1 Swimming pools

- (a) **Application:** The provisions of (b) do not apply in NSW, the Northern Territory, Queensland and Western Australia as follows:
- (i) **NSW**—safety fencing: restriction of access to swimming pools is regulated under the Swimming Pools Act 1992.
 - (ii) **Northern Territory**—all provisions: swimming pools are controlled under the *Northern Territory of Australia Swimming Pool Safety Act 2004*.
 - (iii) **Queensland**—safety fencing: restriction of access to swimming pools is regulated under the Queensland Building Act 1975 and the Standard Building Regulation.
 - (iv) **Western Australia**—safety fencing: restriction of access to private swimming pools is regulated under the Local Government (Miscellaneous Provisions) Act 1960 and the Building Regulations 1989 as amended.

Vic G1.1(b)

- (b) **Safety fencing:** A *swimming pool* associated with a Class 2 or 3 building or Class 4 part of a building, with a depth of water more than 300 mm must have suitable barriers to restrict access by young children to the immediate pool surrounds in accordance with AS 1926 Parts 1 and 2.
- (c) A water recirculation system in a *swimming pool* with a depth of water more than 300 mm must—
- (i) for a spa pool, comply with AS 1926.3 except the specified distance between two outlets connected to a common line may be not less than 600 mm; and
 - (ii) for all other *swimming pools*, comply with AS 1926.3.

ACT G1.1(c)–(d)

SA G1.1(d) and (e)

Tas G1.1(c)–(g)

Deemed-to-Satisfy Provisions

G1.2 Refrigerated chambers, strong-rooms and vaults

- (a) A refrigerated or cooling chamber, strongroom or vault which is of sufficient size for a person to enter must have—
- (i) a door which is capable of being opened by hand from inside without a key; and
 - (ii) internal lighting controlled only by a switch which is located adjacent to the entrance doorway inside the chamber, strongroom or vault; and
 - (iii) an indicator lamp positioned outside the chamber, strongroom or vault which is illuminated when the interior lights *required* by **(a)(ii)** are switched on; and
 - (iv) an alarm that is—
 - (A) located outside but controllable only from within the chamber, strongroom or vault; and
 - (B) able to achieve a sound pressure level outside the chamber, strongroom or vault of 90 dB(A) when measured 3 m from the sounding device.
- (b) A door *required* by **(a)(i)** in a refrigerated or cooling chamber must have a doorway with a clear width of not less than 600 mm and a clear height not less than 1.5 m.

NSW G1.101

Qld G101

Tas G101.1, G101.2

PART G2

**HEATING APPLIANCES, FIREPLACES,
CHIMNEYS AND FLUES**

OBJECTIVE

GO2

The *Objective* of this Part is to—

- (a) safeguard occupants from illness or injury caused by—
 - (i) fire from combustion appliances installed within a building; and
 - (ii) malfunction of a pressure vessel installed within a building; and
- (b) protect a building from damage caused by the malfunction of a pressure vessel installed within.

Tas GO2(a)

FUNCTIONAL STATEMENTS

GF2.1

Combustion appliances using controlled combustion located in a building are to be installed in a way which reduces the likelihood of fire spreading beyond the appliance.

Tas GP2.1

GF2.2

Pressure vessels located in a building are to be installed in a manner which will provide adequate safety for occupants.

PERFORMANCE REQUIREMENTS

GP2.1

Where provided in a building, a combustion appliance and its associated components, including an open fire-place, chimney, flue, chute, hopper or the like, must be installed—

- (a) to withstand the temperatures likely to be generated by the appliance; and
- (b) so that it does not raise the temperature of any building element to a level that would adversely affect the element's physical or mechanical properties or function; and

- (c) so that hot products of combustion will not—
- (i) escape through the walls of the associated components; and
 - (ii) discharge in a position that will cause fire to spread to nearby *combustible* materials or allow smoke to penetrate through nearby *windows*, ventilation inlets, or the like.

Tas GP2.1(c)

GP2.2

When located in a building, a pressure vessel must be installed to avoid, during reasonably foreseeable conditions, the likelihood of—

- (a) leakage from the vessel which could cause damage to the building; and
- (b) rupture or other mechanical damage of the vessel which could cause damage to the building or injury to occupants.

PART G2

**HEATING APPLIANCES, FIREPLACES,
CHIMNEYS AND FLUES**

Deemed-to-Satisfy Provisions

G2.0 Deemed-to-Satisfy Provisions

- (a) Where a *Building Solution* is proposed to comply with the *Deemed-to-Satisfy Provisions*, *Performance Requirements GP2.1* and *GP2.2* are satisfied by complying with *G2.1* to *G2.4*.
- (b) Where a *Building Solution* is proposed as an *Alternative Solution* to the *Deemed-to-Satisfy Provisions* of *G2.1* to *G2.4*, the relevant *Performance Requirements* must be determined in accordance with *A0.10*.

G2.1 * * * * *

This clause has deliberately been left blank.

G2.2 Installation of appliances

The installation of a stove, heater or similar appliance in a building must comply with:

- (a) * * * * *
- (b) Domestic solid-fuel burning appliances — Installation: AS/NZS 2918.

Tas G2.2(b)

- (c) Pressure equipment: AS/NZS 1200.

ACT G2.2(d), (e)

G2.3 Open fireplaces

An open fireplace, or solid-fuel burning appliance in which the fuel-burning compartment is not enclosed must have—

- (a) a hearth constructed of stone, concrete, masonry or similar *non-combustible* material so that—
 - (i) it extends not less than 300 mm beyond the front of the fireplace opening and not less than 150 mm beyond each side of that opening; and
 - (ii) it extends beyond the limits of the fireplace or appliance not less than 300 mm if the fireplace or appliance is free-standing from any wall of the room; and
 - (iii) its upper surface does not slope away from the grate or appliance; and
 - (iv) *combustible* material situated below the hearth but not below that part *required* to extend beyond the fireplace opening or the limits of the fireplace is not less than 150 mm from the upper surface of the hearth; and
- (b) walls forming the sides and back of the fireplace up to not less than 300 mm above the underside of the arch or lintel which—

Deemed-to-Satisfy Provisions

- (i) are constructed in 2 separate leaves of solid masonry not less than 180 mm thick, excluding any cavity; and
- (ii) do not consist of concrete block masonry in the construction of the inner leaf; and
- (c) walls of the chimney above the level referred to in (b)—
 - (i) constructed of masonry units with a net volume, excluding cored and similar holes, not less than 75% of their gross volume, measured on the overall rectangular shape of the units, and with an actual thickness of not less than 100 mm; and
 - (ii) lined internally to a thickness of not less than 12 mm with rendering consisting of 1 part cement, 3 parts lime, and 10 parts sand by volume, or other suitable material; and
- (d) suitable damp-proof courses or flashings to maintain weatherproofing.

G2.4 Incinerator rooms

- (a) If an incinerator is installed in a building any hopper giving access to a charging chute must be—
 - (i) *non-combustible*; and
 - (ii) gas-tight when closed; and
 - (iii) designed to return to the closed position after use; and
 - (iv) not attached to a chute that connects directly to a flue unless the hopper is located in the open air; and
 - (v) not located in a *required exit*.
- (b) A room containing an incinerator must be separated from other parts of the building by construction with an FRL of not less than 60/60/60.

PART G3 ATRIUM CONSTRUCTION

Deemed-to-Satisfy Provisions

Note:

Part G3 contains *Deemed-to-Satisfy Provisions* additional to those contained in **Sections C, D and E** for *Atrium* Construction.

G3.1 Atriums affected by this Part

This Part does not apply to an *atrium* which—

- (a) connects only 2 *storeys*; or
- (b) connects only 3 *storeys* if—
 - (i) each *storey* is provided with a sprinkler system complying with **Specification E1.5** throughout; and
 - (ii) one of those *storeys* is situated at a level at which there is direct egress to a road or *open space*.

G3.2 Dimensions of atrium well

An *atrium well* must have a width throughout the well that is able to contain a cylinder having a horizontal diameter of not less than 6 m.

G3.3 Separation of atrium by bounding walls

An *atrium* must be separated from the remainder of the building at each *storey* by bounding walls set back not more than 3.5 m from the perimeter of the *atrium well* except in the case of the walls at no more than 3 consecutive *storeys* if—

- (a) one of those *storeys* is at a level at which direct egress to a road or *open space* is provided; and
- (b) the sum of the *floor areas* of those *storeys* that are contained within the *atrium* is not more than the maximum area that is permitted in **Table C2.2**.

G3.4 Construction of bounding walls

Bounding walls must—

- (a) have an FRL of not less than 60/60/60, and—
 - (i) extend from the floor of the *storey* to the underside of the floor next above or to the underside of the roof; and
 - (ii) have any door openings protected with *self-closing* or *automatic* –/60/30 fire doors; or
- (b) be constructed of fixed toughened safety glass, or wired safety glass in *non-combustible* frames, with—
 - (i) any door openings fitted with a *self-closing* smoke door complying with **Specification C3.4**; and

Deemed-to-Satisfy Provisions

- (ii) the walls and doors protected with wall-wetting systems in accordance with **Specification G3.8**; and
- (iii) a fire barrier with an FRL of not less than –/60/30 installed in any ceiling spaces above the wall.

G3.5 Construction at balconies

If a bounding wall separating an *atrium* from the remainder of the building is set back from the perimeter of the *atrium well*, a balustrade or other barrier that is imperforate and *non-combustible*, and not less than 1 m high must be provided.

G3.6 Separation at roof

In an *atrium*—

- (a) the roof must have the FRL prescribed in **Table 3 of Specification C1.1**; or
- (b) the roof structure and membrane must be protected by a sprinkler system complying with **Specification E1.5**.

G3.7 Means of egress

All areas within an *atrium* must have access to at least 2 *exits*.

G3.8 Fire and smoke control systems

Sprinkler systems, smoke control, fire detection and alarm systems, and sound systems and intercom system for emergency purposes must be installed in compliance with **Specification G3.8**.

SPECIFICATION **G3.8** FIRE AND SMOKE CONTROL SYSTEMS IN BUILDINGS CONTAINING ATRIUMS

Deemed-to-Satisfy Provisions

1. SCOPE

This Specification sets out the requirements for the design and operation of systems of fire and smoke control in buildings containing an *atrium*.

2. AUTOMATIC FIRE SPRINKLER SYSTEM

2.1 General requirement

A sprinkler system complying with **Specification E1.5** must be installed in every building containing an *atrium*, except where varied or superseded by this Specification.

2.2 Roof protection

A roof of an *atrium* which does not have the FRL prescribed in **Specification C1.1** or the *Deemed-to-Satisfy Provisions* of **Part C2** must be protected by *automatic* sprinklers arranged to wet both the covering membrane and supporting structure if the roof is—

- (a) less than 12 m above the floor of the *atrium* or the floor of the highest *storey* where the bounding construction is set back more than 3.5 m from the *atrium well* if a Class 2, 3, 5 or 9 part of a building is open to the *atrium*; or
- (b) less than 20 m above the floor of the *atrium* or the floor of the highest *storey* where the bounding construction is set back more than 3.5 m from the *atrium well* if a Class 6, 7 or 8 part of a building is open to the *atrium*,

and the temperature rating of sprinkler heads providing roof protection must be within the range 79°C–100°C.

2.3 Atrium floor protection

The floor of the *atrium* must be protected by sprinklers with—

- (a) the use of sidewall pattern sprinkler heads together with overhead sprinklers where dictated by the dimensions of the *atrium*; and
- (b) sprinkler heads of the fast response type, installed with suitable *non-combustible* heat collector plates of 200 mm minimum diameter to ensure activation by a rising fire plume.

2.4 Sprinkler systems to glazed walls

2.4.1 Location of protection

Where an *atrium* is separated from the remainder of the building by walls or doors incorporating glazing, a wall wetting system with suitable *non-combustible* heat collector plates of 200 mm diameter must be provided to protect the glazing as follows:

Deemed-to-Satisfy Provisions

- (a) On the *atrium* side of the glazing — to all glazed walls which are set back more than 3.5 m from the *atrium well*.
- (b) On the *atrium* side of the glazing — to all glazed walls which are not set back, or are set back 3.5 m or less, from the *atrium well*, for all levels which are less than—
 - (i) 12 m above the floor of an *atrium* or the floor of the highest *storey* where the bounding wall is set back more than 3.5 m from the *atrium well* if a Class 2, 3, 5 or 9 part of the building is open to the *atrium*; or
 - (ii) 20 m above the floor of an *atrium* or the floor of the highest *storey* where the bounding wall is set back more than 3.5 m from the *atrium well* if a Class 6, 7 or 8 part of the building is open to the *atrium*.
- (c) On the side of the glazing away from the *atrium well*—to all glazing forming part of the bounding wall at each *storey*.

2.4.2 Sprinkler head location

Sprinklers must be located in positions allowing full wetting of the glazing surfaces without wetting adjacent sprinkler heads.

2.4.3 Head rating and response time

Sprinkler heads must be of the fast response type and have a maximum temperature rating of 74°C.

2.4.4 Water discharge rate

The rate of water discharge to protect glazing must be not less than—

- (a) on the *atrium* side of the glazing—
 - (i) 0.25 L/s.m² where glazing is not set back from the *atrium well*; or
 - (ii) 0.167 L/s.m² where glazing is set back from the *atrium well*; and
- (b) on the side away from the *atrium well*—0.167 L/s.m².

2.4.5 Water supply

In addition to that of the basic sprinkler protection for the building, the water supply to *required* wall wetting systems must be of adequate capacity to accommodate the following on the *atrium* side of the glazing:

- (a) Where the bounding walls are set back less than 3.5 m from the *atrium well*—wall wetting of a part not less than 6 m long for a height of not less than—
 - (i) 12 m above the floor of an *atrium* or the floor of the highest *storey* where the bounding wall is set back more than 3.5 m from the *atrium well* if a Class 2, 3, 5 or 9 part of the building is open to the *atrium*; or
 - (ii) 20 m above the floor of an *atrium* or the floor of the highest *storey* where the bounding wall is set back more than 3.5 m from the *atrium well* if a Class 6, 7 or 8 part of the building is open to the *atrium*; and
- (b) Where the walls are set back 3.5 m or more from the *atrium well*—wetting of a part not less than 12 m long on one *storey*.

Deemed-to-Satisfy Provisions

2.5 Stop valves

- (a) Basic sprinkler and wall wetting systems protecting a building containing an *atrium* must be provided with easily accessible and identified stop valves.
- (b) Sprinkler and wall wetting systems must be provided with independent stop valves.
- (c) Sprinkler heads protecting the roof of the *atrium* must be provided with a stop valve.
- (d) Stop valve to wall wetting and roof sprinklers may be of the gate type.
- (e) All sprinkler and wall wetting stop valves must be monitored to detect unauthorised closure.

3. SMOKE CONTROL SYSTEM

3.1 General requirements

Except where varied or superseded by this Specification, mechanical air-handling systems in a building containing an *atrium* must comply with AS/NZS 1668.1.

3.2 Operation of atrium mechanical air-handling systems

Mechanical air-handling systems serving an *atrium* must be designed to operate so that during a fire—

- (a) a tenable atmosphere is maintained in all paths of travel along balconies to *required exits* during the period of evacuation; and
- (b) smoke exhaust fans serving the *atrium* are only activated when smoke enters the *atrium*; and
- (c) central plant systems do not use the *atrium* as a return air path; and
- (d) central plant systems which use return air paths remote from the *atrium*—
 - (i) cycle to the full outside air mode; and
 - (ii) stop supply air to the fire affected *storey* or *fire compartment*; and
 - (iii) continue to fully exhaust the fire affected *storey* or *fire compartment* and reduce the exhaust from other *storeys* or *fire compartments* by at least 75%; and
 - (iv) continue to supply air to *fire compartments* or *storeys* other than the fire affected *storey* or *fire compartment*; and
- (e) fans performing relief or exhaust duty from the *atrium* stop normal operation; and
- (f) floor by floor, or unitary, air-handling plant serving a single *fire compartment* or *storey*—
 - (i) ceases normal operation in the fire affected *storey* or *fire compartment*; and
 - (ii) commences full relief or exhaust from that fire affected *storey* or *fire compartment*; and
 - (iii) continue to supply air to *fire compartments* or *storeys* other than the fire affected *storey* or *fire compartment*.

Deemed-to-Satisfy Provisions

3.3 Activation of smoke control system

- (a) The smoke control system must be activated by—
 - (i) operation of an *automatic* fire alarm; or
 - (ii) operation of the sprinkler system; or
 - (iii) a manual start switch.
- (b) All controls for the smoke control system must be located—
 - (i) in the fire control room; or
 - (ii) in the emergency control centre, (if any); or
 - (iii) adjacent to the sprinkler control valves; or
 - (iv) incorporated in the Fire Indicator Panel.

3.4 Smoke exhaust system

A smoke exhaust system serving an *atrium* must be designed on the basis of—

- (a) the sprinkler system limiting the size of a fire to—
 - (i) a heat output of 1.5 MW and perimeter of 7.5 m if a Class 2, 3, 5 or 9 part of the building is open to the *atrium*; or
 - (ii) a heat output of 5 MW and perimeter of 12 m if a Class 6, 7 or 8 part of the building is open to the *atrium*;
- (b) a smoke plume reaching a level 3 m above the highest *storey* having a path of travel to a *required exit* along a balcony bounding the *atrium well*, and not less than—
 - (i) 12 m above the floor of an *atrium* or the floor of the highest *storey* where the bounding wall is set back more than 3.5 m from the *atrium well* if a Class 2, 3, 5 or 9 part of the building is open to the *atrium*; or
 - (ii) 20 m above the floor of an *atrium* or the floor of the highest *storey* where the bounding construction is set back more than 3.5 m from the *atrium well* if a Class 6, 7 or 8 part of the building is open to the *atrium*; and
- (c) the smoke exhaust system discharging smoke at a rate of not less than that shown in **Figure 3.4** for the appropriate height of smoke plume and fire size—
 - (i) from the top of the *atrium*; or
 - (ii) horizontally where calculations of wind velocity induced pressure profiles for the building verify that the exhaust system will operate effectively for all wind directions.

Deemed-to-Satisfy Provisions

Figure 3.4

SMOKE EXHAUST RATE

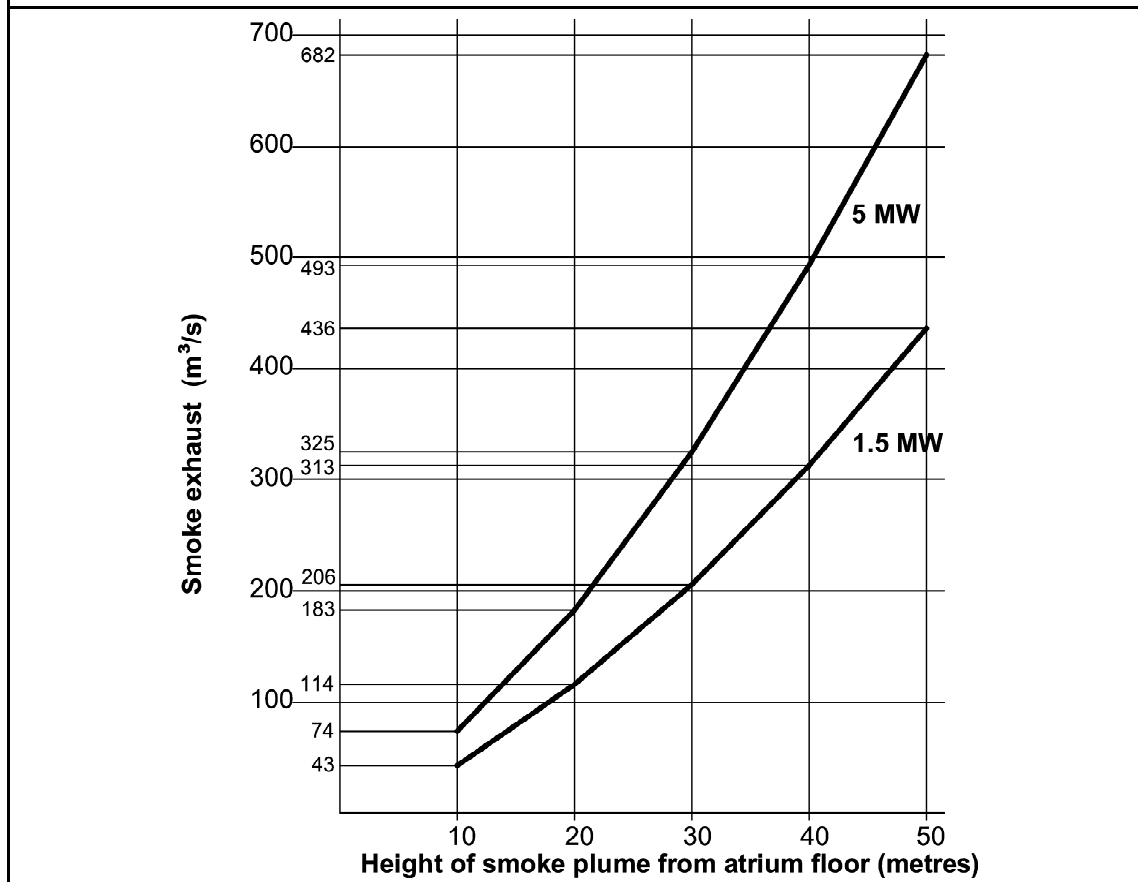

3.5 Upward air velocity

Notwithstanding 3.4(c), the average upward air velocity in the atrium, due to the required smoke exhaust quantity must—

- (a) be not less than 0.2 m/s at any level over an 18 m height above the floor of the atrium; and
- (b) not exceed the following maximum velocities in atriums of constant cross sectional plan area—
 - (i) for occupancy classification qualifying for 1.5 MW fire size — 3.5 m/s.
 - (ii) for occupancy classifications qualifying for 5 MW fire size — 5 m/s.

3.6 Exhaust fans

- (a) Smoke exhaust must be provided by fans capable of continuous and required operation for a period of not less than 1 hour when handling exhaust gases at 200°C.

Deemed-to-Satisfy Provisions

- (b) Where a Class 2, 3 or 9 part of a building adjoins an *atrium*, the *atrium* must be provided with a minimum of 3 fans each capable of 50% of the total *required* smoke exhaust capacity.
- (c) *Atriums* other than those referred to in (b) must be provided with a minimum of 2 fans each capable of 50% of the total *required* smoke exhaust capacity.

3.7 Smoke and heat vents

Notwithstanding **Clause 3.6**, *automatic* vents complying with AS 2665 may be used, except where a Class 6 part of a building adjoins the *atrium*, in lieu of exhaust fans provided that—

- (a) the height from the *atrium* floor to the bottom of the highest vent is not more than 12 m; and
- (b) the vents are fitted with a remote manual operation switch located adjacent to the sprinkler control valves or incorporated in the Fire Indicator Panel.

3.8 Make-up air supply

- (a) Uniformly distributed make-up air must be provided to the *atrium* exhaust system from—
 - (i) outside the *atrium* at or near the lowest *storey* level; and
 - (ii) relief air from non-fire *storeys*.
- (b) A discharge volume sufficient to maintain a velocity of not less than 0.1 m/s towards the *atrium well* must be provided on all *storeys* where the bounding wall is set back from the *atrium well*.
- (c) The requirements of (a)(i) are satisfied if make-up air is provided to the *atrium* exhaust system in such a manner as to prevent, as far as possible, disturbance of the smoke layer due to turbulence created by the incoming air, through—
 - (i) openings directly from the outside air to the *atrium* and located as close as practicable to the lowest level of the *atrium*; or
 - (ii) ducts from the outside air to the *atrium* which deliver air as close as practicable to the lowest level of the *atrium* and, where passing through any other *fire compartment* having an FRL of at least 60/60/60; or
 - (iii) a combination of (i) or (ii).

4. FIRE DETECTION AND ALARM SYSTEM

4.1 General requirements

Except where superseded by this Specification, *automatic* fire detection and alarm systems in a building containing an *atrium* must comply with AS 1670.1.

4.2 Smoke detection system

Smoke detection within an *atrium*—

- (a) must be provided within all outside air intakes and at individual floor return air intakes of all air-handling systems to initiate *automatic* fire mode operation, and where applicable, comply with the restart facilities in AS/NZS 1668.1; and

Deemed-to-Satisfy Provisions

- (b) must operate at an obscuration level not greater than 0.5% per metre with compensation for external airborne contamination as necessary; and
- (c) must sample air within the *atrium* and in *storeys* where the bounding wall is set back more than 3.5 m from the *atrium well*; and
- (d) must be calibrated to compensate for smoke dilution where sampling occurs within return air path common to more than one room; and
- (e) may incorporate beam type detectors to sense smoke in an *atrium* in a Class 5, 6, 7 or 8 building with an *effective height* of not more than 25 m if—
 - (i) the beam detectors are located at intervals of not more than 3 *storeys*; and
 - (ii) arranged to scan at 90 degrees orientation to adjacent beam units.

4.3 Smoke detection in spaces separated from the atrium by bounding walls

Smoke detection systems must be located at all return and relief air openings associated with the building air-handling systems and be—

- (a) of the sampling type system as *required* in 4.2; or
- (b) of the point type photoelectric smoke detector.

4.4 Alarm systems

- (a) A break-glass fire alarm point must be provided at each door to a *fire-isolated stairway*, *fire-isolated ramp*, or *fire-isolated passageway*.
- (b) A staged alarm must be provided where an air sampling type smoke detection system is provided for the *atrium*, and must operate as follows:
 - (i) Alert building management when abnormal smoke levels of 0.03% obscuration per metre are detected.
 - (ii) Initiate a second alarm to management and start all smoke control systems including pressurisation of escape routes when smoke levels of 0.07% obscuration per metre are detected.
 - (iii) Automatically call the *fire brigade*, activate the sound system and intercom system for emergency purposes, and de-activate all plant not necessary for fire safety within the building when smoke levels of 0.09% obscuration per metre are detected.
- (c) Beam and point type smoke detectors *required* must simultaneously operate all functions referred to above and activate at the level set out in AS/NZS 1668.1.

5. SOUND SYSTEMS AND INTERCOM SYSTEMS FOR EMERGENCY PURPOSES

All buildings containing an *atrium* must be provided with a sound system and intercom system for emergency purposes which—

- (a) complies with AS 1670.4; and
- (b) incorporates visual warning devices that—
 - (i) operate upon the evacuation signal; and

Deemed-to-Satisfy Provisions

- (ii) display the words “EVACUATE” in red with letters conforming with the requirements of the *Deemed-to-Satisfy Provisions* of **Part E4** for *exit* signs.

6. STANDBY POWER SYSTEM

- (a) If a *required* path of travel to an *exit* is within an *atrium*, a suitable alternative power supply must be provided to operate *required* safety systems, including sprinkler systems and fire hydrant pumps, air handling systems, alarms, warning and communication systems and emergency lighting circuits.
- (b) The alternative power supply must—
 - (i) be connected *automatically* if the normal power supply fails; and
 - (ii) if located within the building, be separated from the remainder of the building by an enclosure with an FRL of at least 120/120/120; and
 - (iii) be connected to the safety systems by means of cabling complying with **C2.13(c)(iii)** and **(iv)**.
- (c) The requirements of **(a)** are satisfied by—
 - (i) a single medium voltage supply taken from an electricity substation situated within, or adjacent to, the building concerned where the power supply to the substation consists of two or more high voltage cables each taking electricity from separate transformers; or
 - (ii) two or more medium voltage supplies each taking electricity from separate electricity substations situated—
 - (A) outside the building concerned; and
 - (B) at a suitable distance from each other; or
 - (iii) a single medium voltage supply taken from an electricity substation together with an electricity generating plant capable of—
 - (A) generating a medium voltage supply; and
 - (B) starting and taking the *required* electrical load within a period of not more than 30 seconds from the time of normal supply failure.

7. SYSTEM FOR EXCLUDING SMOKE FROM FIRE-ISOLATED EXITS

Required fire-isolated *exits* in a building containing an *atrium* must be protected from the entry of smoke in accordance with **E2.2**.

PART G4 CONSTRUCTION IN ALPINE AREAS

OBJECTIVE

GO4

The *Objective* of this Part is to safeguard occupants in *alpine areas* from illness or injury from an emergency while evacuating a building.

Application

GO4 applies to a building constructed in an *alpine area* and overrules other provisions of the BCA.

FUNCTIONAL STATEMENT

GF4.1

A building in an *alpine area* is to be provided with additional measures in view of the increased difficulties in fire-fighting and maintaining access and means of egress in snow conditions.

Application

GF4.1 applies to a building constructed in an *alpine area* and overrules other provisions of the BCA.

PERFORMANCE REQUIREMENTS

GP4.1

An external doorway from a building in an *alpine area* must be installed so that opening the door is not obstructed by snow or ice.

Application

GP4.1 applies to a building constructed in an *alpine area* overrules other provisions of the BCA.

GP4.2

A building in an *alpine area* containing external trafficable structures forming part of the means of egress must be constructed so that those structures remain, as far as practicable, useable under snow conditions.

Application

GP4.2 applies to a building constructed in an *alpine area* and overrules other provisions of the BCA.

GP4.3

A building in an *alpine area* must be constructed so that snow or ice is not shed from the building onto the allotment, any adjoining allotment, road or public space in a location or manner that will—

- (a) obstruct a means of egress from any building to a road or *open space*; or
- (b) otherwise endanger people.

Application

GP4.3 applies to a building constructed in an *alpine area* and overrules other provisions of the BCA.

GP4.4

A building in an *alpine area* must have a *fire safety system* installed to—

- (a) facilitate fire-fighting operations; and
- (b) alert occupants in the event of an emergency.

Application

GP4.4 applies to a building constructed in an *alpine area* and overrules other provisions of the BCA.

PART G4 CONSTRUCTION IN ALPINE AREAS

Deemed-to-Satisfy Provisions

G4.0 Deemed-to-Satisfy Provisions

- (a) Where a *Building Solution* is proposed to comply with the *Deemed-to-Satisfy Provisions, Performance Requirements GP4.1 to GP4.4* are satisfied by complying with **G4.1 to G4.9**.
- (b) Where a *Building Solution* is proposed as an *Alternative Solution* to the *Deemed-to-Satisfy Provisions* of **G4.1 to G4.9**, the relevant *Performance Requirements* must be determined in accordance with **A0.10**.

G4.1 Application of Part

- (a) The *Deemed-to-Satisfy Provisions* of this Part apply to any building constructed in an *alpine area* in addition to other *Deemed-to-Satisfy Provisions* of the BCA.
- (b) Where any *Deemed-to-Satisfy Provisions* are in conflict, the provisions of this Part take precedence.

G4.2 * * * * *

Note:

This clause has deliberately been left blank.

G4.3 External doorways

- (a) A door fitted to an external doorway which may be subject to the build-up of snow must—
 - (i) only be capable of opening inwards; and
 - (ii) be marked “OPEN INWARDS” on the inside face of the door in letters not less than 75 mm high and in a colour contrasting with that of the background; and
 - (iii) if it serves a corridor or stairway, be positioned in an alcove or recess with—
 - (A) no horizontal dimension less than twice the width of the door; and
 - (B) the door positioned to open against a wall such that the distance from any part of its swing to the nearest point of entry of the stairway or corridor is not less than the width of the door.
- (b) Every threshold of a *required exit* doorway must be located so that snow or ice is not deposited in a manner that will obstruct means of egress from that doorway.

G4.4 Emergency lighting

In a Class 2, 3, 5, 6, 7, 8 or 9 building or Class 4 part of a building, a system of emergency lighting must be installed in accordance with the *Deemed-to-Satisfy Provisions* of **Part E4**—

- (a) in every stairway (other than those within a *sole-occupancy unit* in a Class 2 or 3 building or Class 4 part of a building); and

Deemed-to-Satisfy Provisions

- (b) in every *public corridor* or the like leading to an *exit*; and
- (c) externally above every doorway opening to a road or *open space*; and
- (d) in any *storey* of the building if illumination sufficient for safe egress will not be available under conditions of emergency.

G4.5 External ramps

An external ramp serving as an *exit* must—

- (a) where a ramp is also serving as an *accessible* ramp under **Part D3**, be in accordance with AS 1428.1; or
- (b) in any other case, have a gradient not steeper than 1:12.

G4.6 Discharge of exits

A building in an *alpine area* must be so constructed that—

- (a) if any part of an *external wall* is more than 3.6 m above the natural ground level — the distance of that part from a boundary other than a road alignment is not less than 2.5 m plus 100 mm for each 300 mm or part by which that part of the wall exceeds a height of 3.6 m; and
- (b) if an *exit* doorway discharges into a court between wings of a building — the wings are not less than 6 m apart; and
- (c) if an *exit* doorway is opposite a barrier which is more than 900 mm above the threshold of the doorway — the threshold is at a distance from that barrier of not less than twice the height of the barrier or 6 m, whichever is the lesser.

G4.7 External trafficable structures

External stairways, ramps, access bridges or other trafficable structures must have—

- (a) a floor surface that consists of steel mesh or other suitable material if it is used as a means of egress; and
- (b) any *required* balustrade or other barrier constructed so that its sides are not less than 75% open.

G4.8 Fire-fighting services and equipment

Every Class 2, 3, 5, 6, 7, 8 and 9 building must have—

- (a) a manually operated fire alarm system with call-points complying with AS 1670.1; and
- (b) fire hose reels and fire hydrants installed in accordance with the *Deemed-to-Satisfy Provisions* of **Part E1**.

G4.9 Fire orders

Every Class 2, 3 or 9 building must display a notice clearly marked “FIRE ORDERS” in suitable locations near the main entrance and on each *storey*, explaining—

- (a) the method of operation of the fire alarm system and the location of all call-points; and
- (b) the location and methods of operation of all fire-fighting equipment; and

Deemed-to-Satisfy Provisions

- (c) the location of all *exits*; and
- (d) the procedure for evacuation of the building.

PART G5

**CONSTRUCTION IN BUSHFIRE PRONE
AREAS**

OBJECTIVE

NSW G05

G05

The *Objective* of this Part is to—

- (a) safeguard occupants from injury; and
- (b) protect buildings,

from the effects of a bushfire.

Application

G05 only applies to a Class 2 or 3 building in a *designated bushfire prone area* and applies in addition to other provisions of the BCA.

FUNCTIONAL STATEMENT

NSW GF5.1

GF5.1

A building constructed in a *designated bushfire prone area* is to provide a resistance to bushfires in order to reduce the danger to life and minimise the risk of the loss of the building.

Application

GF5.1 only applies to a Class 2 or 3 building in a *designated bushfire prone area* and applies in addition to other provisions of the BCA.

PERFORMANCE REQUIREMENT

NSW GP5.1

GP5.1

A building that is constructed in a *designated bushfire prone area* must be designed and constructed to reduce the risk of ignition from a bushfire while the fire front passes.

Application

GP5.1 only applies to a Class 2 and 3 building in a *designated bushfire prone area* and applies in addition to other provisions of the BCA.

PART **G5**

**CONSTRUCTION IN BUSHFIRE PRONE
AREAS**

Deemed-to-Satisfy Provisions

G5.0 Deemed-to-Satisfy Provisions

- (a) Where a *Building Solution* is proposed to comply with the *Deemed-to-Satisfy Provisions*, *Performance Requirements GP5.1* is satisfied by complying with **G5.1** and **G5.2**.
- (b) Where a *Building Solution* is proposed as an *Alternative Solution* to the *Deemed-to-Satisfy Provisions* of **G5.1** and **G5.2**, the relevant *Performance Requirements* must be determined in accordance with **A0.10**.

G5.1 Application of Part

The *Deemed-to-Satisfy Provisions* of this Part apply to Class 2 and 3 buildings in *designated bushfire prone areas*.

G5.2 Protection

NSW G5.2

SA G5.2

A Class 2 or 3 building in a *designated bushfire prone area* must comply with AS 3959.

SA G5.3

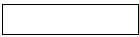

SECTION **H**

SPECIAL USE BUILDINGS

H1 Theatres, Stages and Public Halls

SECTION H CONTENTS

SECTION H SPECIAL USE BUILDINGS

Part H1 Theatres, Stages and Public Halls

H1.1 Application of Part

H1.2 Separation

H1.3 Proscenium wall construction

H1.4 Seating area

H1.5 Exits from theatre stages

H1.6 Access to platforms and lofts

H1.7 Aisle lights in theatres

Specification H1.3 Construction of Theatres with Proscenium Walls

NSW Appendix (Additional provisions and variations — refer to NSW Contents for full details)

NT Appendix (Additional provisions and variations — refer to NT Contents for full details)

SA Appendix (Additional provisions and variations — refer to SA Contents for full details)

Tas Appendix (Additional provisions and variations — refer to Tas Contents for full details)

Vic Appendix (Additional provisions and variations — refer to Vic Contents for full details)

PART H1 THEATRES, STAGES AND PUBLIC HALLS

Deemed-to-Satisfy Provisions

Note.

Part H1 contains *Deemed-to-Satisfy Provisions* additional to those contained in Sections C, D and E for buildings containing theatres, stages and public halls.

H1.1 Application of Part

NSW H1.1

- (a) The *Deemed-to-Satisfy Provisions* of this Part apply to every enclosed Class 9b building or part of a building which—
- (i) is a *school* assembly, church or community hall with a *stage* and any *backstage* area with a total *floor area* of more than 300 m²; or
 - (ii) otherwise, has a *stage* and any *backstage* area with a total *floor area* of more than 200 m²; or
 - (iii) has a *stage* with an associated rigging loft.
- (b) Notwithstanding (a)—
- (i) **H1.4** applies to every open or enclosed Class 9b building; and
 - (ii) **H1.7** applies to every enclosed Class 9b building.

H1.2 Separation

A theatre, public hall or the like must—

- (a) have a sprinkler system complying with **Specification E1.5**; or
- (b) have the *stage*, *backstage* area and accessible under-*stage* area separated from the audience by a proscenium wall in accordance with **H1.3**.

H1.3 Proscenium wall construction

A proscenium wall must comply with **Specification H1.3**.

H1.4 Seating area

In a seating area—

- (a) the gradient of the floor surface must not be steeper than 1 in 8, or the floor must be stepped so that—
 - (i) a line joining the nosings of consecutive steps does not exceed an angle of 30° to the horizontal; and
 - (ii) the height of each step in the stepped floor is not more than 600 mm; and
 - (iii) the height of any opening in such a step is not more than 125 mm; and
- (b) if an aisle divides the stepped floor and the difference in level between any 2 consecutive steps—

Deemed-to-Satisfy Provisions

- (i) exceeds 230 mm but not 400 mm — an intermediate step must be provided in the aisle; and
 - (ii) exceeds 400 mm — 2 equally spaced intermediate steps must be provided in the aisle; and
 - (iii) the going of intermediate steps must be not less than 270 mm and such as to provide as nearly as practicable equal treads throughout the length of the aisle; and
- (c) the clearance between rows of fixed seats used for viewing performing arts, sport or recreational activities must be not less than—
- (i) 300 mm if the distance to an aisle is not more than 3.5 m; or
 - (ii) 500 mm if the distance to an aisle is more than 3.5 m.

H1.5 Exits from theatre stages

- (a) The path of travel to an *exit* from a *stage* or performing area must not pass through the proscenium wall if the *stage* area is separated from the audience area with a proscenium wall.
- (b) *Required exits* from *backstage* and under-*stage* areas must be independent of those provided for the audience area.

H1.6 Access to platforms and lofts

A stairway that provides access to a service platform, rigging loft, or the like, must comply with AS 1657.

H1.7 Aisle lights in theatres

In every enclosed Class 9b building, where in any part of the auditorium, the general lighting is dimmed or extinguished during public occupation and the floor is stepped or is inclined at a slope steeper than 1 in 12, aisle lights must be provided to illuminate the full length of the aisle and tread of each step.

SPECIFICATION **H1.3** CONSTRUCTION OF THEATRES WITH PROSCENIUM WALLS

Deemed-to-Satisfy Provisions

1. Scope

This Specification contains the requirements for the construction of proscenium walls for theatres, public halls, or the like.

2. Separation of stage areas, etc

- (a) Dressing rooms, scene docks, property rooms, workshops, associated store rooms and other ancillary areas must be—
 - (i) located on the *stage* side of the proscenium wall; and
 - (ii) separated from corridors and the like by construction having an FRL of not less than 60/60/60, and if of *lightweight construction*, complying with **Specification C1.8**.
- (b) The *stage* and *backstage* must be separated from other parts of the building other than the audience seating area by construction having an FRL of not less than 60/60/60, and if of *lightweight construction*, complying with **Specification C1.8**.
- (c) Any doorway in the construction referred to in paragraphs (a) and (b) must be protected by a *self-closing* - /60/30 fire door.

3. Proscenium wall construction

A proscenium wall must—

- (a) extend to the underside of the roof covering or the underside of the structural floor next above; and
- (b) have an FRL of not less than 60/60/60, and if of *lightweight construction*, comply with **Specification C1.8**.

4. Combustible materials not to cross proscenium wall

Timber purlins or other *combustible* material must not pass through or cross any proscenium wall.

5. Protection of openings in proscenium wall

Every opening in a proscenium wall must be protected—

- (a) at the principal opening, by a curtain in accordance with **Clause 6** which is—
 - (i) capable of closing the proscenium opening within 35 seconds either by gravity slide or motor assisted mechanisms; and
 - (ii) operated by a system of *automatic* heat activated devices, manually operated devices or push button emergency devices; and

Deemed-to-Satisfy Provisions

- (iii) able to be operated from either the *stage* side or the audience side of the curtain; and
- (b) at any doorway in the wall, by a *self-closing* - /60/30 fire door.

6. Proscenium curtains

A curtain *required* by **Clause 5** must be—

- (a) a fire safety curtain—
 - (i) made of *non-combustible* material; and
 - (ii) capable of withstanding a pressure differential of 0.5 kPa over its entire surface area; and
 - (iii) so fitted that when fully lowered it inhibits the penetration of smoke around the perimeter of the opening, from the *stage*; or
- (b) a curtain—
 - (i) having a *Spread-of-Flame Index* not greater than 0 and a *Smoke-Developed Index* not greater than 3; and
 - (ii) protected by a deluge system of open sprinklers installed along the full width of the curtain.

MAINTENANCE

- I1 Equipment and Safety Installations
- I2 Energy Efficiency Installations

SECTION I CONTENTS

SECTION I MAINTENANCE

Part I1 Equipment and Safety Installations

Objective IO1

Functional Statement IF1.1

Performance Requirement IP1.1 - IP1.2

11.0 Deemed-to-Satisfy Provisions

11.1 Safety measures

11.2 Mechanical ventilation and hot water, warm water and cooling water systems

Part I2 Energy Efficiency Installations

Objective IO2

Functional Statement IF2.1

Performance Requirement IP2.1

I2.0 Deemed-to-Satisfy Provisions

I2.1 Application of Part

I2.2 Components of services

NSW Appendix (Additional provisions and variations — refer to NSW Contents for full details)

NT Appendix (Additional provisions and variations — refer to NT Contents for full details)

SA Appendix (Additional provisions and variations — refer to SA Contents for full details)

PART 11

EQUIPMENT AND SAFETY INSTALLATIONS

OBJECTIVE

IO1

The *Objective* of this Part is to ensure that people are protected from illness, injury and loss of amenity throughout the life of the building.

FUNCTIONAL STATEMENT

IF1.1

Equipment and safety installations in a building are to safeguard people from illness or injury and prevent the loss of amenity.

PERFORMANCE REQUIREMENT

IP1.1

Safety measures must be capable of performing to a standard no less than that which they were originally *required* to achieve.

IP1.2

Mechanical ventilation and hot water, warm water and cooling water systems must be adequately maintained to safeguard people from illness or injury.

PART 11

EQUIPMENT AND SAFETY INSTALLATIONS

Deemed-to-Satisfy Provisions

11.0 Deemed-to-Satisfy Provisions

- (a) Where a *Building Solution* is proposed to comply with the *Deemed-to-Satisfy Provisions*—
- (i) *Performance Requirement IP1.1* is satisfied by complying with **11.1**; and
 - (ii) *Performance Requirement IP1.2* is satisfied by complying with **11.2**.
- (b) Where a *Building Solution* is proposed as an *Alternative Solution* to the *Deemed-to-Satisfy Provisions* of **11.1** to **11.2**, the relevant *Performance Requirements* must be determined in accordance with **A0.10**.

11.1 Safety measures

NSW 11.1

NT 11.1

SA 11.1

Safety measures must—

- (a) perform to a standard not less than they were originally *required* to achieve; and
- (b) for those safety measures listed in Tables I1.1 to I1.13, perform to a standard not less than that determined using the corresponding BCA provisions.

Table I1.1 SAFETY MEASURES - BUILDING FIRE INTEGRITY

Safety measure	BCA provisions for determining standard of performance
Building elements <i>required</i> to satisfy prescribed <i>fire-resistance levels</i>	Section C D1.12
Materials and assemblies <i>required</i> to have <i>fire hazard properties</i>	C1.10
Elements <i>required</i> to be <i>non-combustible</i> , provide fire protection, compartmentation or separation	C2.5 to C2.14, C3.3, C3.11 D1.7, D1.8 E1.3 G3.4
Wall-wetting sprinklers (including doors and windows <i>required</i> in conjunction with wall-wetting sprinklers)	C3.4, C3.8, C3.11 D1.7, D1.8 G3.8

Deemed-to-Satisfy Provisions

Table 11.1 SAFETY MEASURES - BUILDING FIRE INTEGRITY— continued

Safety measure	BCA provisions for determining standard of performance
Fire doors (including sliding fire doors and their associated warning systems) and associated <i>self-closing</i> , <i>automatic</i> closing and latching mechanisms	C2.12, C2.13, C3.4 to C3.8, C3.10, C3.11 D1.7, D1.8, D1.12
Fire windows (including windows that are <i>automatic</i> or permanently fixed in the closed position)	C3.4, C3.8, C3.11 D1.7, D1.8
Fire shutters	C3.4, C3.5 D1.7, D1.8
Solid core doors and associated <i>self-closing</i> , <i>automatic</i> closing and latching mechanisms	C3.11
Fire protection at service penetrations through elements <i>required</i> to be <i>fire-resisting</i> with respect to <i>integrity</i> or <i>insulation</i> , or to have a <i>resistance to the incipient spread of fire</i>	C3.12, C3.13, C3.15
Fire protection associated with construction joints, spaces and the like in and between building elements <i>required</i> to be <i>fire-resisting</i> with respect to <i>integrity</i> and <i>insulation</i>	C3.16
Smoke doors and associated <i>self-closing</i> , <i>automatic</i> closing and latching mechanisms	Spec C2.5 D2.6
Proscenium walls (including proscenium curtains)	H1.3

Table 11.2 SAFETY MEASURES - MEANS OF EGRESS

Safety measure	BCA provisions for determining standard of performance
Paths of travel to <i>exits</i>	D1.6
Discharge from <i>exits</i> (including paths of travel from <i>open spaces</i> to the public roads to which they are connected)	D1.7, D1.9 to D1.11, D2.12 G4.3, G4.6, G4.7
Exits (including <i>fire-isolated stairways</i> and ramps, non- <i>fire-isolated stairways</i> and ramps, stair treads, balustrades and handrails associated with <i>exits</i> , and <i>fire-isolated passageways</i>)	D2.2, D2.3, D2.8 to D2.11, D2.13, D2.16, D2.17
Smoke lobbies to fire-isolated <i>exits</i>	D1.7, D2.6
Open access ramps or balconies for fire-isolated <i>exits</i>	D2.19 to D2.23
Doors (other than fire or smoke doors) in a <i>required exit</i> , forming part of a <i>required exit</i> or in a path of travel to a <i>required exit</i> , and associated <i>self-closing</i> , <i>automatic</i> closing and latching mechanisms	D1.6, D2.19 to D2.21, D2.23

Deemed-to-Satisfy Provisions

Table 11.3 SAFETY MEASURES - SIGNS

Safety measure	BCA provisions for determining standard of performance
<i>Exit</i> signs (including direction signs)	Specification D1.12 E4.5, E4.6, E4.8
Signs warning against the use of lifts in the event of fire	E3.3
Warning signs on sliding fire doors and doors to non- <i>required</i> stairways, ramps and escalators	C3.6 Specification D1.12
Signs, intercommunication systems, or alarm systems on doors of fire-isolated <i>exits</i> stating that re-entry to a <i>storey</i> is available	D2.22
Signs alerting persons that operation of doors must not be impaired	D2.23
Signs <i>required</i> on doors, in <i>alpine areas</i> , alerting people that they open inwards	G4.3
Fire order notices <i>required</i> in <i>alpine areas</i>	G4.9

Table 11.4 SAFETY MEASURES - LIGHTING

Safety measure	BCA provisions for determining standard of performance
Emergency lighting	E4.2, E4.4
Artificial lighting <i>required</i> to assist occupant movement and egress	F4.4, H1.7

Table 11.5 SAFETY MEASURES - FIRE FIGHTING SERVICES AND EQUIPMENT

Safety measure	BCA provisions for determining standard of performance
Fire hydrant system (including on-site pump set and fire-service booster connection)	E1.3
Fire hose reel system	E1.4
Sprinkler system	E1.5 G3.8 H1.2
Portable fire extinguishers	E1.6
Fire control centres (or rooms)	E1.8
Provisions for special hazards	E1.10

Deemed-to-Satisfy Provisions

Table 11.6 SAFETY MEASURES - AIR HANDLING SYSTEMS

Safety measure	BCA provisions for determining standard of performance
Smoke hazard management systems <ul style="list-style-type: none"> • <i>Automatic</i> air pressurisation systems for fire-isolated <i>exits</i> • zone smoke control system • <i>automatic</i> smoke exhaust system • <i>automatic</i> smoke and heat vents • air-handling systems that do not form part of smoke hazard management system and which may unduly contribute to the spread of smoke • miscellaneous air-handling systems covered by Sections 5 and 11 of AS/NZS 1668.1 serving more than one <i>fire compartment</i> • other air-handling systems 	E2.2
Carpark mechanical ventilation system	F4.11
<i>Atrium</i> smoke control system	Specification G3.8

Table 11.7 SAFETY MEASURES - AUTOMATIC FIRE DETECTION AND ALARM SYSTEMS

Safety measure	BCA provisions for determining standard of performance
Smoke and heat alarm system	Clause 3 of Specification E2.2a
Smoke and heat detection system	Clause 4 of Specification E2.2a
<i>Atrium</i> fire detection and alarm systems	Clause 4 of Specification G3.8

Table 11.8 SAFETY MEASURES - OCCUPANT WARNING SYSTEMS

Safety measure	BCA provisions for determining standard of performance
Sound system and intercom system for emergency purposes	E4.9 Clause 5 of Specification G3.8
Building occupant warning system	Clause 8 of Specification E1.5 Clause 6 of Specification E2.2a

Table 11.9 SAFETY MEASURES - LIFTS

Safety measure	BCA provisions for determining standard of performance
Stretcher facilities in lifts	E3.2

Deemed-to-Satisfy Provisions

Table 11.9 SAFETY MEASURES - LIFTS— continued

Safety measure	BCA provisions for determining standard of performance
Emergency lifts	E3.4
Passenger lift fire service controls	E3.7

Table 11.10 SAFETY MEASURES - STANDBY POWER SUPPLY SYSTEMS

Safety measure	BCA provisions for determining standard of performance
Standby power supply system	E3.4
	Clause 6 of Specification G3.8

Table 11.11 SAFETY MEASURES - BUILDING CLEARANCE AND FIRE APPLIANCES

Safety measure	BCA provisions for determining standard of performance
Open space around large isolated buildings	C2.3, C2.4
Vehicular access around large isolated buildings	C2.3, C2.4

Table 11.12 SAFETY MEASURES - OTHER MEASURES

Safety measure	BCA provisions for determining standard of performance
Glazed assemblies	B1.4
	F1.13
Balconies	Part B1
Balustrades	Part B1
	D2.16
Swimming pool safety fencing	G1.1
Refrigerated chambers, strong rooms and vaults	G1.2
Bushfire protection measures	G5.2

Table 11.13 SAFETY MEASURES - BUILDING USE AND APPLICATION

Safety measure	BCA provisions for determining standard of performance
Classification and use of building	A3.2 to A3.4
Occupancy hazard	E1.5, E1.6, E1.10

Deemed-to-Satisfy Provisions

11.2 Mechanical ventilation and hot water, warm water and cooling water systems

NSW 11.2

SA 11.2

Mechanical ventilation and hot water, warm water and cooling water systems in a building other than a system only serving a single *sole-occupancy unit* in a Class 2 or 3 building or Class 4 part must be maintained in accordance with AS/NZS 3666.2.

PART 12

ENERGY EFFICIENCY INSTALLATIONS

NSW Part 12

NT Part 12

OBJECTIVE

IO2

The *Objective* of this Part is to reduce greenhouse gas emissions by efficiently using energy throughout the life of the building.

Limitation:

IO2 does not apply to a *sole-occupancy unit* in a Class 2 building, or a Class 4 part of a building.

FUNCTIONAL STATEMENT

IF2.1

A building's *services* are to be continually capable of using energy efficiently.

Limitation:

IF2.1 does not apply to a *sole-occupancy unit* in a Class 2 building, or a Class 4 part of a building.

PERFORMANCE REQUIREMENT

IP2.1

A building's *services* must continue to perform to a standard of energy efficiency no less than that which they were originally *required* to achieve.

Limitation:

IP2.1 does not apply to *services* serving only one *sole-occupancy unit* in a Class 2 building, or serving only a Class 4 part of a building.

PART 12

ENERGY EFFICIENCY INSTALLATIONS

Deemed-to-Satisfy Provisions

NSW Part 12

NT Part 12

12.0 Deemed-to-Satisfy Provisions

- (a) Where a *Building Solution* is proposed to comply with the *Deemed-to-Satisfy Provisions, Performance Requirement IP2.1* is satisfied by complying with **12.1** to **12.2**.
- (b) Where a *Building Solution* is proposed as an *Alternative Solution* to the *Deemed-to-Satisfy Provisions* of **12.1** to **12.2**, the relevant *Performance Requirements* must be determined in accordance with **A0.10**.

12.1 Application of Part

The *Deemed-to-Satisfy Provisions* of this Part do not apply to *services* serving only one *sole-occupancy unit* of a Class 2 building or serving a Class 4 part of a building.

12.2 Components of services

Components of *services* must be maintained to ensure that they perform to a standard not less than they were originally *required* to achieve, including—

- (a) adjustable or motorised shading devices; and
- (b) time switches and motion detectors; and
- (c) room temperature thermostats; and
- (d) plant thermostats such as on boilers or refrigeration units; and
- (e) motorised air dampers and control valves; and
- (f) reflectors, lenses and diffusers of light fittings; and
- (g) heat transfer equipment; and
- (h) plant that receives a concession under **Clause 2(e) of Specification JV** for the use of energy generated on-site from sources that do not emit greenhouse gases.

ENERGY EFFICIENCY

- J1 Building Fabric**
- J2 Glazing**
- J3 Building Sealing**
- J4 Air Movement**
- J5 Air-conditioning and Ventilation Systems**
- J6 Artificial Lighting and Power**
- J7 Hot Water Supply**
- J8 Access for Maintenance**

SECTION J CONTENTS

SECTION J ENERGY EFFICIENCY

Section J Energy and Efficiency

- Objective JO1
- Functional Statements JF1
- Performance Requirement JP1 - JP2
- Verification Methods JV1 - JV3
- Specification JV

Part J1 Building Fabric

- J1.0 Deemed-to-Satisfy Provisions
- J1.1 Application of Part
- J1.2 Thermal construction general
- J1.3 Roof and ceiling construction
- J1.4 Roof Lights
- J1.5 Walls
- J1.6 Floors

Part J2 Glazing

- J2.0 Deemed-to-Satisfy Provisions
- J2.1 Application of Part
- J2.2 Applicable glazing provisions
- J2.3 Glazing - Method 1
- J2.4 Glazing - Method 2
- J2.5 Shading

Part J3 Building Sealing

- J3.0 Deemed-to-Satisfy Provisions
- J3.1 Application of Part
- J3.2 Chimneys and flues
- J3.3 Roof lights
- J3.4 Windows and doors
- J3.5 Exhaust fans
- J3.6 Construction of roofs, walls and floors
- J3.7 Evaporative coolers

Part J4 Air Movement

- J4.0 Deemed-to-Satisfy Provisions
- J4.1 Application of Part
- J4.2 Air movement
- J4.3 Ventilation openings
- J4.4 Ceiling fans and evaporative coolers

Part J5 Air-Conditioning and Ventilation Systems

J5.0 Deemed-to-Satisfy Provisions

J5.1 * * * * *

J5.2 Air-conditioning and ventilation systems

J5.3 Time Switch

J5.4 Heating and chilling systems

J5.5 Miscellaneous exhaust systems

Part J6 Artificial Lighting and Power

J6.0 Deemed-to-Satisfy Provisions

J6.1 Application of Part

J6.2 Interior artificial lighting

J6.3 Interior artificial lighting and power control

J6.4 Interior decorative and display lighting

J6.5 Artificial lighting around the perimeter of a building

J6.6 Boiling water and chilled water storage units

Part J7 Hot Water Supply

J7.0 Deemed-to-Satisfy Provisions

J7.1 * * * * *

J7.2 Hot water supply

Part J8 Access for Maintenance

J8.0 Deemed-to-Satisfy Provisions

J8.1 Application of Part

J8.2 Access for maintenance

Specifications

Specification J1.2 Material Properties

Specification J1.3 Roof and Ceiling Construction

Specification J1.5 Wall Construction

Specification J1.6 Floor Construction

Specification J5.2 Ductwork Insulation and Sealing

Specification J5.4 Insulating of Piping, Vessels, Heat Exchangers and Tanks

Specification J6 Lighting and Power Control Devices

NSW Appendix (Additional provisions and variations — refer to NSW Contents for full details)

NT Appendix (Additional provisions and variations — refer to NT Contents for full details)

SA Appendix (Additional provisions and variations — refer to SA Contents for full details)

Vic Appendix (Additional provisions and variations — refer to Vic Contents for full details)

SECTION J ENERGY EFFICIENCY

NSW Section J

NT Section J

OBJECTIVE

JO1

The *Objective* of this Section is to reduce greenhouse gas emissions by efficiently using energy.

FUNCTIONAL STATEMENTS

JF1

A building, including its *services*, is to be capable of efficiently using energy.

PERFORMANCE REQUIREMENT

JP1

A building, including its *services*, must have, to the degree necessary, features that facilitate the efficient use of energy appropriate to—

- (a) the function and use of the building and *services*; and
- (b) the internal environment; and
- (c) the geographic location of the building; and
- (d) the effects of nearby permanent features such as topography, structures and buildings; and
- (e) solar radiation being—
 - (i) utilised for heating; and
 - (ii) controlled to minimise energy for cooling; and
- (f) the sealing of the building *envelope* against air leakage; and
- (g) the utilisation of air movement to assist heating and cooling; and
- (h) the energy source of the *services*.

JP2

A building, including its *services*, must have, to the degree necessary, features that facilitate the maintenance of systems and components appropriate to the function and use of the building.

Limitation:

JP2 does not apply to *services* serving only one *sole-occupancy unit* in a Class 2 building or serving a Class 4 part of a building.

SA JP3

VERIFICATION METHODS

JV1 Verification using a stated value for a sole-occupancy unit of a Class 2 building or for a Class 4 part of a building

VIC JV1(a)

- (a) For a Class 2 building or Class 4 part of a building, other than its *services*, compliance with **JP1** is verified when it is determined using a *thermal calculation method* that—
 - (i) each *sole-occupancy unit* has an energy rating of not less than 3 stars; and
 - (ii) the average energy rating of all of the *sole-occupancy units* is not less than—
 - (A) in *climate zones* 1 to 3, 3.5 stars; and
 - (B) in *climate zones* 4 to 8, 4 stars.
- (b) The thermal calculation method used in (a) must comply with the ABCB Protocol for House Energy Rating Software.
- (c) Averaging of energy ratings must be carried out in MJ/m².annum or points.

JV2 * * * * *

This clause has deliberately been left blank.

JV3 Verification using a reference building

- (a) For a Class 3, 5, 6, 7, 8 and 9 building, compliance with **JP1** is verified when it is determined using a *thermal calculation method* that the *annual energy consumption* of the proposed building with its *services* is not more than the *annual energy consumption* of a *reference building* when—
 - (i) the proposed building is modelled with the proposed *services*; and
 - (ii) the proposed building is modelled with the same *services* as the *reference building*.
- (b) The *annual energy consumption* in (a) must be calculated—
 - (i) for the *reference building*, using:
 - (A) the *Deemed-to-Satisfy Provisions*; and

- (B) a solar absorptance of 0.7 for the *external walls* and roofs; and
- (C) the maximum *lamp power density* or maximum *illumination power density* without any increase for a motion detector, corridor lighting timer, manual dimming system, programmable dimming system, dynamic dimming system, fixed dimming system, daylight sensor or dynamic lighting control device; and
- (ii) for both the proposed building and the *reference building*, in accordance with **Specification JV** using the same—
 - (A) *thermal calculation method*; and
 - (B) location, being either the location where the building is to be constructed if appropriate climatic data is available, or the nearest location with similar climatic conditions in the same *climate zone*, for which climatic data is available; and
 - (C) adjacent structures and features; and
 - (D) environmental conditions such as ground reflectivity, sky and ground form factors, temperature of external bounding surfaces, air velocities across external surfaces and the like; and
 - (E) orientation; and
 - (F) roof form; and
 - (G) external doors; and
 - (H) floor plan, including the location of *glazing* ; and
 - (I) ground to lowest floor arrangement; and
 - (J) dimensions of external, internal and separating walls; and
 - (K) surface density of *envelope* walls over 220 kg/m²; and
 - (L) number of *storeys*; and
 - (M) intermediate floors; and
 - (N) floor coverings; and
 - (O) internal shading devices, their criteria such as colour and their operation; and
 - (P) number and sizes of lifts and escalators; and
 - (Q) range and type of *services* and energy sources; and
 - (R) internal artificial lighting levels; and
 - (S) internal power loads; and
 - (T) internal *air-conditioning* zones; and
 - (U) daily and annual profiles of the—
 - (aa) building occupancy; and
 - (bb) operation of *services*; and
 - (V) internal relative humidity range; and
 - (W) supply hot water temperature and rate; and
 - (X) system resistances for fans and pumps; and
 - (Y) degree of building sealing; and

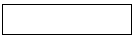

(Z) *outdoor air economy cycle* provision.

SA JV4

SPECIFICATION **JV**

**ANNUAL ENERGY CONSUMPTION
CALCULATION**

1. Scope

This Specification contains the requirements for calculating the *annual energy consumption* of *services* in a building.

2. Annual energy consumption of services

The *annual energy consumption*—

- (a) for *air-conditioning*, must be calculated on the basis of—
 - (i) the space temperature being within the range of 20°CDB to 24°CDB for 98% of the plant operation time; and
 - (ii) the daily occupancy and operation profiles in **Tables 2a** to **2g**; and
 - (iii) plant serving public areas of a Class 3 or Class 9c *aged care building* being available on thermostatic control 24 hours per day; and
 - (iv) the amount of ventilation *required* by **Part F4**; and
 - (v) the internal heat gains in a building—
 - (A) from the occupants, at an average rate of 75 W per person *sensible heat gain* and 55 W per person *latent heat gain*, with the number of people calculated in accordance with **Table D1.13**; and
 - (B) from hot meals in a dining room, restaurant or cafe, at a rate of 5 W per person *sensible heat gain* and 25 W per person *latent heat gain* with the number of people calculated in accordance with **Table D1.13**; and
 - (C) from appliances and equipment, in accordance with **Table 2h**; and
 - (D) from artificial lighting, that is calculated in **(b)**; and
 - (vi) infiltration values, for a perimeter zone of depth equal to the floor-to-ceiling height, of—
 - (A) when pressurising plant is operating, 0.5 air changes per hour; and
 - (B) when pressurising plant is not operating, 1.0 air changes per hour; and
 - (vii) in other than a Class 6 shop or shopping centre, blinds being operated when the solar radiation on the *glazing* exceeds 150 W/m²; and
 - (viii) furniture and fittings density of 20 kg/m²; and
 - (ix) the *R-Value* of air films being in accordance with **Specification J1.2**; and
 - (x) heat migration across *air-conditioning* zone boundaries; and
- (b) for artificial lighting, must be calculated on the basis of the proposed level of artificial lighting in the building with the daily profile in **Tables 2a** to **2g**; and
- (c) for a lift in a building with more than one classification, may be proportioned according to the number of *storeys* of the part for which the *annual energy consumption* is being calculated; and

- (d) for hot water supply, must be calculated on the basis of the consumption rates of [Table 2i](#); and
- (e) may be reduced by 50% of the energy generated on-site from sources that do not emit greenhouse gases such as solar and wind power; and
- (f) must be calculated using a [thermal calculation method](#) that complies with the ABCB Protocol for Building Energy Analysis Software.

Table 2a OCCUPANCY AND OPERATION PROFILES OF A CLASS 3 BUILDING OR CLASS 9c AGED CARE BUILDING

Time period (local standard time)	Occupancy		Artificial lighting	<i>Air-conditioning</i>	
	Monday to Friday	Saturday, Sunday and holidays		Monday to Friday	Saturday, Sunday and holidays
12:00am to 1:00am	85%	85%	5%	On	On
1:00am to 2:00am	85%	85%	5%	On	On
2:00am to 3:00am	85%	85%	5%	On	On
3:00am to 4:00am	85%	85%	5%	On	On
4:00am to 5:00am	85%	85%	5%	On	On
5:00am to 6:00am	85%	85%	25%	On	On
6:00am to 7:00am	85%	85%	80%	On	On
7:00am to 8:00am	80%	85%	80%	On	On
8:00am to 9:00am	50%	50%	50%	On	On
9:00am to 10:00am	10%	50%	20%	Off	On
10:00am to 11:00am	10%	20%	20%	Off	Off
11:00am to 12:00pm	10%	20%	20%	Off	Off
12:00pm to 1:00pm	10%	20%	20%	Off	Off
1:00pm to 2:00pm	10%	20%	20%	Off	Off
2:00pm to 3:00pm	10%	20%	20%	Off	Off
3:00pm to 4:00pm	10%	30%	20%	Off	Off
4:00pm to 5:00pm	50%	50%	20%	On	On
5:00pm to 6:00pm	50%	50%	50%	On	On
6:00pm to 7:00pm	70%	50%	50%	On	On
7:00pm to 8:00pm	70%	70%	50%	On	On
8:00pm to 9:00pm	80%	80%	50%	On	On
9:00pm to 10:00pm	85%	80%	50%	On	On
10:00pm to 11:00pm	85%	85%	50%	On	On
11:00pm to 12:00am	85%	85%	5%	On	On

Table 2a OCCUPANCY AND OPERATION PROFILES OF A CLASS 3 BUILDING OR CLASS 9c AGED CARE BUILDING— continued

Time period (local standard time)	Occupancy		Artificial lighting	<i>Air-conditioning</i>	
	Monday to Friday	Saturday, Sunday and holidays		Monday to Friday	Saturday, Sunday and holidays
Note: The occupancy profile is expressed as a percentage of the maximum number of people that can be accommodated in the Class 3 building or Class 9c <i>aged care building</i> . The artificial lighting profile is expressed as a percentage of the maximum <i>lamp power density</i> permitted under Part J6 .					

Table 2b OCCUPANCY AND OPERATION PROFILES OF A CLASS 5 BUILDING, A CLASS 8 LABORATORY OR A CLASS 9a CLINIC, DAY SURGERY OR PROCEDURE UNIT

Time period (local standard time)	Occupancy (Monday to Friday)	Artificial lighting (Monday to Friday)	Appliances and equipment (Monday to Friday)	<i>Air- conditioning</i> (Monday to Friday)
12:00am to 1:00am	0%	10%	10%	Off
1:00am to 2:00am	0%	10%	10%	Off
2:00am to 3:00am	0%	10%	10%	Off
3:00am to 4:00am	0%	10%	10%	Off
4:00am to 5:00am	0%	10%	10%	Off
5:00am to 6:00am	0%	10%	10%	Off
6:00am to 7:00am	0%	10%	10%	Off
7:00am to 8:00am	15%	40%	25%	On
8:00am to 9:00am	60%	80%	70%	On
9:00am to 10:00am	100%	100%	100%	On
10:00am to 11:00am	100%	100%	100%	On
11:00am to 12:00pm	100%	100%	100%	On
12:00pm to 1:00pm	100%	100%	100%	On
1:00pm to 2:00pm	100%	100%	100%	On
2:00pm to 3:00pm	100%	100%	100%	On
3:00pm to 4:00pm	100%	100%	100%	On
4:00pm to 5:00pm	100%	100%	100%	On
5:00pm to 6:00pm	50%	80%	60%	On
6:00pm to 7:00pm	15%	60%	25%	Off
7:00pm to 8:00pm	5%	40%	15%	Off

Table 2b OCCUPANCY AND OPERATION PROFILES OF A CLASS 5 BUILDING, A CLASS 8 LABORATORY OR A CLASS 9a CLINIC, DAY SURGERY OR PROCEDURE UNIT— continued

Time period (local standard time)	Occupancy (Monday to Friday)	Artificial lighting (Monday to Friday)	Appliances and equipment (Monday to Friday)	Air-conditioning (Monday to Friday)
8:00pm to 9:00pm	5%	20%	15%	Off
9:00pm to 10:00pm	0%	10%	10%	Off
10:00pm to 11:00pm	0%	10%	10%	Off
11:00pm to 12:00am	0%	10%	10%	Off

Notes:

- The occupancy profile is expressed as a percentage of the maximum number of people that can be accommodated in the building. The artificial lighting profile is expressed as a percentage of the maximum *illumination power density* permitted under **Part J6**. The appliances and equipment profile is expressed as a percentage of the maximum internal heat gain in **Table 2h**. The *air-conditioning* profile is expressed as the plant status.
- Saturday and Sunday profiles are 10% continuous artificial lighting and 10% continuous appliances and equipment. There is no occupancy and the *air-conditioning* is "off".

Table 2c OCCUPANCY AND OPERATION PROFILES OF A CLASS 6 SHOP OR SHOPPING CENTRE

Time period (local standard time)	Occupancy (Daily)	Artificial lighting (Daily)	Appliances and equipment (Daily)	Air-conditioning (Daily)
12:00am to 1:00am	0%	10%	10%	Off
1:00am to 2:00am	0%	10%	10%	Off
2:00am to 3:00am	0%	10%	10%	Off
3:00am to 4:00am	0%	10%	10%	Off
4:00am to 5:00am	0%	10%	10%	Off
5:00am to 6:00am	0%	10%	10%	Off
6:00am to 7:00am	0%	10%	10%	Off
7:00am to 8:00am	10%	100%	70%	On
8:00am to 9:00am	20%	100%	70%	On
9:00am to 10:00am	20%	100%	70%	On
10:00am to 11:00am	15%	100%	70%	On
11:00am to 12:00pm	25%	100%	70%	On
12:00pm to 1:00pm	25%	100%	70%	On
1:00pm to 2:00pm	15%	100%	70%	On

Table 2c OCCUPANCY AND OPERATION PROFILES OF A CLASS 6 SHOP OR SHOPPING CENTRE— continued

Time period (local standard time)	Occupancy (Daily)	Artificial lighting (Daily)	Appliances and equipment (Daily)	<i>Air- conditioning</i> (Daily)
2:00pm to 3:00pm	15%	100%	70%	On
3:00pm to 4:00pm	15%	100%	70%	On
4:00pm to 5:00pm	15%	100%	70%	On
5:00pm to 6:00pm	5%	100%	70%	On
6:00pm to 7:00pm	5%	100%	70%	Off
7:00pm to 8:00pm	0%	10%	10%	Off
8:00pm to 9:00pm	0%	10%	10%	Off
9:00pm to 10:00pm	0%	10%	10%	Off
10:00pm to 11:00pm	0%	10%	10%	Off
11:00pm to 12:00am	0%	10%	10%	Off

Note:
The occupancy profile is expressed as a percentage of the maximum number of people that can be accommodated in the building. The artificial lighting profile is expressed as a percentage of the maximum *illumination power density* permitted under **Part J6**. The appliances and equipment profile is expressed as a percentage of the maximum internal heat gain in **Table 2h**. The *air-conditioning* profile is expressed as the plant status.

Table 2d OCCUPANCY AND OPERATION PROFILES OF A CLASS 6 RESTAURANT OR CAFE

Time period (local standard time)	Occupancy (Monday to Saturday)	Artificial lighting (Monday to Saturday)	Appliances and equipment (Monday to Saturday)	<i>Air- conditioning</i> (Monday to Saturday)
12:00am to 1:00am	0%	5%	15%	Off
1:00am to 2:00am	0%	5%	15%	Off
2:00am to 3:00am	0%	5%	15%	Off
3:00am to 4:00am	0%	5%	15%	Off
4:00am to 5:00am	0%	5%	15%	Off
5:00am to 6:00am	0%	5%	15%	Off
6:00am to 7:00am	5%	40%	40%	Off
7:00am to 8:00am	5%	40%	40%	On
8:00am to 9:00am	5%	60%	60%	On
9:00am to 10:00am	5%	60%	60%	On

Table 2d OCCUPANCY AND OPERATION PROFILES OF A CLASS 6 RESTAURANT OR CAFE— continued

Time period (local standard time)	Occupancy		Artificial lighting	Appliances and equipment	<i>Air- conditioning</i>
	(Monday to Saturday)	(Monday to Saturday)			
10:00am to 11:00am	20%	90%	90%	90%	On
11:00am to 12:00pm	50%	90%	90%	90%	On
12:00pm to 1:00pm	80%	90%	90%	90%	On
1:00pm to 2:00pm	70%	90%	90%	90%	On
2:00pm to 3:00pm	40%	90%	90%	90%	On
3:00pm to 4:00pm	20%	90%	90%	90%	On
4:00pm to 5:00pm	25%	90%	90%	90%	On
5:00pm to 6:00pm	50%	90%	90%	90%	On
6:00pm to 7:00pm	80%	90%	90%	90%	On
7:00pm to 8:00pm	80%	90%	90%	90%	On
8:00pm to 9:00pm	80%	90%	90%	90%	On
9:00pm to 10:00pm	50%	90%	90%	90%	On
10:00pm to 11:00pm	35%	50%	50%	50%	On
11:00pm to 12:00am	20%	30%	30%	30%	On

Notes:

- The occupancy profile is expressed as a percentage of the maximum number of people that can be accommodated in the building. The artificial lighting profile is expressed as a percentage of the maximum *illumination power density* permitted under **Part J6**. The appliances and equipment profile is expressed as a percentage of the maximum internal heat gain in **Table 2h**. The *air-conditioning* profile is expressed as the plant status.
- Sunday profiles is 5% continuous artificial lighting and 5% continuous appliances and equipment. There is no occupancy and the *air-conditioning* is "off".

Table 2e OCCUPANCY AND OPERATION PROFILES OF A CLASS 9a WARD AREA

Time period (local standard time)	Occupancy		Artificial lighting	<i>Air-conditioning</i>	
	Monday to Friday	Saturday and Sunday		Monday to Friday	Saturday and Sunday
12:00am to 1:00am	85%	85%	5%	On	On
1:00am to 2:00am	85%	85%	5%	On	On
2:00am to 3:00am	85%	85%	5%	On	On
3:00am to 4:00am	85%	85%	5%	On	On
4:00am to 5:00am	85%	85%	5%	On	On

Table 2e OCCUPANCY AND OPERATION PROFILES OF A CLASS 9a WARD AREA— continued

Time period (local standard time)	Occupancy		Artificial lighting	<i>Air-conditioning</i>	
	Monday to Friday	Saturday and Sunday		Monday to Friday	Saturday and Sunday
5:00am to 6:00am	85%	85%	25%	On	On
6:00am to 7:00am	85%	85%	80%	On	On
7:00am to 8:00am	85%	85%	80%	On	On
8:00am to 9:00am	85%	85%	50%	On	On
9:00am to 10:00am	85%	85%	20%	On	On
10:00am to 11:00am	85%	85%	20%	On	On
11:00am to 12:00pm	85%	85%	20%	On	On
12:00pm to 1:00pm	85%	85%	20%	On	On
1:00pm to 2:00pm	85%	85%	20%	On	On
2:00pm to 3:00pm	85%	85%	20%	On	On
3:00pm to 4:00pm	85%	85%	20%	On	On
4:00pm to 5:00pm	85%	85%	20%	On	On
5:00pm to 6:00pm	85%	85%	50%	On	On
6:00pm to 7:00pm	85%	85%	50%	On	On
7:00pm to 8:00pm	85%	85%	50%	On	On
8:00pm to 9:00pm	85%	85%	50%	On	On
9:00pm to 10:00pm	85%	85%	50%	On	On
10:00pm to 11:00pm	85%	85%	50%	On	On
11:00pm to 12:00am	85%	85%	5%	On	On

Note:

The occupancy profile is expressed as a percentage of the maximum number of people that can be accommodated in the building. The artificial lighting profile is expressed as a percentage of the maximum *illumination power density* permitted under **Part J6**. The *air-conditioning* profile is expressed as the plant status.

Table 2f OCCUPANCY AND OPERATION PROFILES OF A CLASS 9b THEATRE OR CINEMA

Time period (local standard time)	Occupancy		Artificial lighting		<i>Air-conditioning</i>	
	Monday to Friday	Sat. & Sun.	Monday to Friday	Sat. & Sun.	Monday to Friday	Sat. & Sun.
12:00am to 1:00am	0%	0%	5%	5%	Off	Off
1:00am to 2:00am	0%	0%	5%	5%	Off	Off
2:00am to 3:00am	0%	0%	5%	5%	Off	Off

Table 2f OCCUPANCY AND OPERATION PROFILES OF A CLASS 9b THEATRE OR CINEMA— continued

Time period (local standard time)	Occupancy		Artificial lighting		Air-conditioning	
	Monday to Friday	Sat. & Sun.	Monday to Friday	Sat. & Sun.	Monday to Friday	Sat. & Sun.
3:00am to 4:00am	0%	0%	5%	5%	Off	Off
4:00am to 5:00am	0%	0%	5%	5%	Off	Off
5:00am to 6:00am	0%	0%	5%	5%	Off	Off
6:00am to 7:00am	0%	0%	5%	5%	Off	Off
7:00am to 8:00am	0%	0%	5%	5%	Off	On
8:00am to 9:00am	0%	20%	100%	100%	Off	On
9:00am to 10:00am	0%	80%	10%	10%	Off	On
10:00am to 11:00am	0%	80%	10%	10%	Off	On
11:00am to 12:00pm	0%	80%	10%	10%	On	On
12:00pm to 1:00pm	20%	20%	100%	100%	On	On
1:00pm to 2:00pm	80%	80%	5%	5%	On	On
2:00pm to 3:00pm	80%	80%	5%	5%	On	On
3:00pm to 4:00pm	80%	80%	5%	5%	On	On
4:00pm to 5:00pm	80%	80%	5%	5%	On	On
5:00pm to 6:00pm	20%	20%	100%	100%	On	On
6:00pm to 7:00pm	20%	20%	100%	100%	On	On
7:00pm to 8:00pm	80%	80%	100%	100%	On	On
8:00pm to 9:00pm	80%	80%	5%	5%	On	On
9:00pm to 10:00pm	80%	80%	5%	5%	On	On
10:00pm to 11:00pm	80%	80%	5%	5%	On	On
11:00pm to 12:00am	10%	10%	100%	100%	On	On

Note:

The occupancy profile is expressed as a percentage of the maximum number of people that can be accommodated in the building. The artificial lighting profile is expressed as a percentage of the maximum *illumination power density* permitted under **Part J6**. The *air-conditioning* profile is expressed as the plant status.

Table 2g OCCUPANCY AND OPERATION PROFILES OF A CLASS 9b SCHOOL

Time period (local standard time)	Occupancy (Monday to Friday)	Artificial lighting (Monday to Friday)	Appliances and equipment (Monday to Friday)	Air-conditioning (Monday to Friday)
12:00am to 1:00am	0%	5%	5%	Off

Table 2g OCCUPANCY AND OPERATION PROFILES OF A CLASS 9b SCHOOL— continued

Time period (local standard time)	Occupancy (Monday to Friday)	Artificial lighting (Monday to Friday)	Appliances and equipment (Monday to Friday)	Air-conditioning (Monday to Friday)
1:00am to 2:00am	0%	5%	5%	Off
2:00am to 3:00am	0%	5%	5%	Off
3:00am to 4:00am	0%	5%	5%	Off
4:00am to 5:00am	0%	5%	5%	Off
5:00am to 6:00am	0%	5%	5%	Off
6:00am to 7:00am	0%	5%	5%	Off
7:00am to 8:00am	5%	30%	30%	On
8:00am to 9:00am	75%	85%	85%	On
9:00am to 10:00am	90%	95%	95%	On
10:00am to 11:00am	90%	95%	95%	On
11:00am to 12:00pm	90%	95%	95%	On
12:00pm to 1:00pm	50%	80%	70%	On
1:00pm to 2:00pm	50%	80%	70%	On
2:00pm to 3:00pm	90%	95%	95%	On
3:00pm to 4:00pm	70%	90%	80%	On
4:00pm to 5:00pm	50%	70%	60%	On
5:00pm to 6:00pm	20%	20%	20%	Off
6:00pm to 7:00pm	20%	20%	20%	Off
7:00pm to 8:00pm	20%	20%	20%	Off
8:00pm to 9:00pm	10%	10%	10%	Off
9:00pm to 10:00pm	5%	5%	5%	Off
10:00pm to 11:00pm	5%	5%	5%	Off
11:00pm to 12:00am	5%	5%	5%	Off

Notes:

1. The occupancy profile is expressed as a percentage of the maximum number of people that can be accommodated in the building. The artificial lighting profile is expressed as a percentage of the maximum *illumination power density* permitted under **Part J6**. The appliances and equipment profile is expressed as a percentage of the maximum internal heat gain in **Table 2h**. The *air-conditioning* profile is expressed as the plant status.
2. Saturday and Sunday profiles are 5% continuous artificial lighting and 5% continuous appliances and equipment. There is no occupancy and the *air-conditioning* is "off".

Table 2h INTERNAL HEAT GAINS FOR APPLIANCES AND EQUIPMENT

Application	Internal sensible heat gain rate (W/m ²)
<i>Sole-occupancy unit</i> of a Class 3 building, a Class 9a building <i>ward area</i> or Class 9c <i>aged care building</i>	5 W/m ² averaged for 24 hours per day, 7 days per week, continuous operation
Class 5 building, Class 8 laboratory and a Class 9a clinic, day surgery and a procedure unit.	15 W/m ²
Class 6 shop and shopping centre, Class 6 cafe and restaurant and Class 9b <i>school</i>	5 W/m ²
Other applications	No load

Table 2i HOT WATER SUPPLY CONSUMPTION RATES

Application	Daily consumption rate
Residential part of a hotel or motel	75 L/ <i>sole-occupancy unit</i>
Dormitory, boarding house, guest house, hostel, lodging-house and backpackers accommodation	50 L/person
Residential part of a <i>school</i> , accommodation for the aged, children or people with disabilities and a <i>detention centre</i> or a <i>health care building</i> which accommodates members of staff	
Class 9c <i>aged care building</i>	
Office, laboratory, shop and <i>assembly building</i>	4 L/person
Dining room, restaurant and cafe	9 L/meal
<i>Health care building ward area</i>	70 L/patient
<i>School</i>	7 L/person
Other applications	4 L/person

PART J1 BUILDING FABRIC

Deemed-to-Satisfy Provisions

J1.0 Deemed-to-Satisfy Provisions

VIC J1.0

- (a) Where a *Building Solution* is proposed to comply with the *Deemed-to-Satisfy Provisions*, *Performance Requirement JP1* is satisfied by complying with—
- (i) **J1.1** to **J1.6**; and
 - (ii) **J2.1** to **J2.5**; and
 - (iii) **J3.1** to **J3.7**; and
 - (iv) **J4.1** to **J4.4**; and
 - (v) **J5.1** to **J5.5**; and
 - (vi) **J6.1** to **J6.6**; and
 - (vii) **J7.1** to **J7.2**.
- (b) Where a *Building Solution* is proposed as an *Alternative Solution* to the *Deemed-to-Satisfy Provisions* of—
- (i) **J1.1** to **J1.6**; and
 - (ii) **J2.1** to **J2.5**; and
 - (iii) **J3.1** to **J3.7**; and
 - (iv) **J4.1** to **J4.4**; and
 - (v) **J5.1** to **J5.5**; and
 - (vi) **J6.1** to **J6.6**; and
 - (vii) **J7.1** to **J7.2**,

the relevant *Performance Requirements* must be determined in accordance with **A0.10**.

J1.1 Application of Part

VIC J1.1

The *Deemed-to-Satisfy Provisions* of this Part apply to building elements forming the *envelope* of a Class 2 to 9 building other than—

- (a) a Class 7, 8 or 9b building that does not have a *conditioned space*; or
- (b) an atrium or solarium that is not a *conditioned space* and is separated from the remainder of the building by an *envelope*.

J1.2 Thermal construction general

- (a) Where *required*, insulation must comply with AS/NZS 4859.1 and be installed so that it—

Deemed-to-Satisfy Provisions

- (i) abuts or overlaps adjoining insulation other than at supporting members such as studs, noggings, joists, furring channels and the like where the insulation must butt against the member; and
 - (ii) forms a continuous barrier with ceilings, walls, bulkheads, floors or the like that inherently contribute to the thermal barrier; and
 - (iii) does not affect the safe or effective operation of a *service* or fitting.
- (b) Where *required, reflective insulation* must be installed with—
- (i) the necessary airspace to achieve the *required R-Value* between a reflective side of the *reflective insulation* and a building lining or cladding; and
 - (ii) the *reflective insulation* closely fitted against any penetration, door or *window* opening; and
 - (iii) the *reflective insulation* adequately supported by framing members; and
 - (iv) each adjoining sheet of roll membrane being—
 - (A) overlapped not less than 50 mm; or
 - (B) taped together.
- (c) Where *required*, bulk insulation must be installed so that—
- (i) it maintains its position and thickness, other than where it crosses roof battens, water pipes, electrical cabling or the like; and
 - (ii) in a ceiling, where there is no bulk insulation or *reflective insulation* in the wall beneath, it overlaps the wall by not less than 50 mm.
- (d) Roof, ceiling, wall and floor materials, and associated surfaces are deemed to have the thermal properties listed in **Specification J1.2**.

J1.3 Roof and ceiling construction

- (a) A roof or ceiling that is part of the *envelope* must achieve the *Total R-Value* specified in **Table J1.3** for the direction of heat flow.
- (b) The *Total R-Value* specified in Table J1.3 is reduced—
- (i) in *climate zones* 1, 2 and 3, for a Class 2 or 3 building, Class 4 part of a building or Class 9c *aged care building* with a roof upper surface solar absorptance value of not more than 0.55, by R0.5; and
 - (ii) in *climate zones* 1, 2 and 3, for a Class 5 to 8, 9a and 9b building with—
 - (A) a roof upper surface solar absorptance value not more than 0.55, by R0.5; or
 - (B) a roof upper surface solar absorptance value of not more than 0.35, by R1.0; and
 - (iii) in *climate zone* 5, for a Class 5 to 8, 9a and 9b building with—
 - (A) a roof upper surface solar absorptance value of not more than 0.55, by R0.25; or
 - (B) a roof upper surface solar absorptance value of not more than 0.35, by R0.5.

Deemed-to-Satisfy Provisions

- (c) In *climate zones* 7 and 8, the *Total R-Value* specified in **Table J1.3** for Class 5 to 9 buildings may be reduced by 0.2 provided the total area of any *roof lights* is not more than 1.5% of the *floor area* of the *storey* served.
- (d) A roof that—
- (i) is *required* to achieve a minimum *Total R-Value*; and
 - (ii) has metal sheet roofing fixed to metal purlins, metal rafters or metal battens; and
 - (iii) does not have a ceiling lining or has a ceiling lining fixed directly to those metal purlins, metal rafters or metal battens (see **Specification J1.3 Figure 2(c)** and **(f)**),
- must have a thermal break, consisting of a material with an *R-Value* of not less than R0.2, installed between the metal sheet roofing and its supporting member.
- (e) Roof and ceiling construction is deemed to have the thermal properties listed in **Specification J1.3**.

Table J1.3 ROOFS AND CEILINGS - MINIMUM TOTAL R-VALUE FOR EACH CLIMATE ZONE

<i>Climate zone</i>	1	2		3	4	5	6	7	8
		Below 300 m altitude	At or above 300 m altitude						
(a) Class 2 or 3 building, Class 4 part of a building or Class 9c <i>aged care building</i>									
Minimum <i>Total R-Value</i> for a roof or ceiling generally	2.2	2.2	2.5	2.2	3.0	2.7	3.2	3.8	4.3
Minimum <i>Total R-Value</i> for a ceiling below a non- <i>conditioned space</i> such as a plant room, lift machinery room, store room or the like	1.1	1.1	1.25	1.1	1.5	1.35	1.6	1.9	2.15
Direction of heat flow	Downwards		Downwards and upwards		Upwards				
(b) Class 5, 6, 7, 8, 9a or 9b building									
Minimum <i>Total R-Value</i> for a roof or ceiling generally	3.2							3.2	4.3

Deemed-to-Satisfy Provisions

Table J1.3 ROOFS AND CEILINGS - MINIMUM TOTAL R-VALUE FOR EACH CLIMATE ZONE— continued

Climate zone	1	2		3	4	5	6	7	8
		Below 300 m altitude	At or above 300 m altitude						
Minimum Total R-Value for a ceiling below a non-conditioned space such as a plant room, lift machinery room, store room or the like	1.6							1.6	2.15
Direction of heat flow	Downwards							Upwards	
Note: Altitude means the height of the highest part of the roof above the Australian Height Datum.									

J1.4 Roof lights

- (a) *Roof lights*—
- (i) serving a *habitable room*, public area or an interconnecting space such as a corridor, hallway, stairway or the like in a Class 2 or 3 building or Class 4 part of a building must satisfy (b), (c) and (d); or
 - (ii) that form part of the *envelope* of a Class 5, 6, 7, 8 or 9 building, must satisfy (b) and (c).
- (b) If the total area of the *roof lights* is more than 1.5% but not more than 10% of the *floor area* of the room or space they serve, the *roof lights* must comply with **Table J1.4**.
- (c) The total area of the *roof lights* may exceed 10% of the *floor area* of the room or space they serve, where—
- (i) compliance with the natural lighting requirements of **Part F4** can only be achieved by a *roof light*; and
 - (ii) the transparent and translucent elements of the *roof lights*, including any imperforate ceiling diffuser achieves—
 - (A) an *SHGC* of not more than 0.25; and
 - (B) a *Total U-Value* of not more than 1.3.
- (d) The aggregate area of *roof lights* serving a *storey* of a *sole-occupancy unit*, including the case where the *floor area* of a room or space constitutes the total *floor area* of the *storey* of a *sole-occupancy unit*, must not exceed 3% of the total *floor area* of the *storey* of the *sole-occupancy unit* served.

Deemed-to-Satisfy Provisions

Table J1.4 ROOF LIGHTS - THERMAL PERFORMANCE OF TRANSPARENT AND TRANSLUCENT ELEMENTS

<i>Roof light</i> shaft index (see Note 1)	Total area of <i>roof lights</i> serving the room or space as a percentage of the <i>floor area</i> of the room or space		
	More than 1.5% and up to 3%	More than 3% and up to 5%	More than 5% and up to 10%
Less than 0.5	<i>SHGC</i> of not more than 0.75 and a <i>Total U-Value</i> of not more than 5.0	<i>SHGC</i> of not more than 0.50 and a <i>Total U-Value</i> of not more than 5.0	<i>SHGC</i> of not more than 0.25 and a <i>Total U-Value</i> of not more than 2.5
0.5 to less than 1.0	<i>Total U-Value</i> of not more than 5.0	<i>SHGC</i> of not more than 0.70 and a <i>Total U-Value</i> of not more than 5.0	<i>SHGC</i> of not more than 0.35 and a <i>Total U-Value</i> of not more than 2.5
1.0 to less than 2.5	<i>Total U-Value</i> of not more than 5.0	<i>Total U-Value</i> of not more than 5.0	<i>SHGC</i> of not more than 0.45 and a <i>Total U-Value</i> of not more than 2.5
2.5 and above	<i>Total U-Value</i> of not more than 5.0	<i>Total U-Value</i> of not more than 5.0	<i>Total U-Value</i> of not more than 2.5

Notes:

- The *roof light* shaft index is determined by measuring the distance from the centre of the shaft at the roof to the centre of the shaft at the ceiling level and dividing it by the average internal dimension of the shaft opening at the ceiling level (or the diameter for a circular shaft) in the same units of measurement.
- The total area of *roof lights* is the combined area for all *roof lights* serving the room or space.
- The area of a *roof light* is the area of the roof opening that allows light to enter the building.
- The thermal performance of an imperforate ceiling diffuser may be included in the *Total U-Value* of the *roof light*.

J1.5 Walls

- (a) Each part of an *external wall* that is part of the *envelope* must satisfy one of the options in **Table J1.5a** or **Table J1.5b** except for—
- in *climate zones* 1, 2 and 3 south of latitude 20° south, an *external wall* of a Class 2 or 3 building or a Class 4 part of a building facing the south orientation sector as described in **Figure J2.3**; and
 - opaque non-glazed openings in *external walls* such as doors (including garage doors), vents, penetrations, shutters and the like; and
 - glazing*; and
 - a *storey* complying with **(b)**.

Deemed-to-Satisfy Provisions

Table J1.5a OPTIONS FOR EACH PART OF AN EXTERNAL WALL OF A CLASS 2 OR 3 BUILDING, CLASS 4 PART OF A BUILDING OR CLASS 9C AGED CARE BUILDING

Climate zone	Options
1, 2 and 3	(a) Achieve a minimum <i>Total R-Value</i> of 1.4.
	(b) Shade the <i>external wall</i> of the <i>storey</i> with a verandah, balcony, eaves, overhang, carport or the like which projects at a minimum angle of 15 degrees in accordance with Figure J1.5 .
4	(a) Achieve a minimum <i>Total R-Value</i> of 1.7.
	(b) Achieve a surface density of not less than 220 kg/m ² .
5	(a) Achieve a minimum <i>Total R-Value</i> of 1.4.
	(b) Achieve a surface density of not less than 220 kg/m ² .
6	(a) Achieve a minimum <i>Total R-Value</i> of 1.7.
	(b) (i) Achieve a surface density of not less than 220 kg/m ² ; and (ii) the <i>storey</i> be constructed on a flooring system that is in direct contact with the ground, such as a concrete slab-on-ground or the like.
	(c) (i) Achieve a surface density of not less than 220 kg/m ² ; and (ii) incorporate insulation with an <i>R-Value</i> of not less than 1.0.
7	(a) Achieve a minimum <i>Total R-Value</i> of 1.9.
	(b) (i) Achieve a surface density of not less than 220 kg/m ² ; and (ii) incorporate insulation with an <i>R-Value</i> of not less than 1.0.
8	Achieve a minimum <i>Total R-Value</i> of 2.8.

Deemed-to-Satisfy Provisions

Table J1.5b OPTIONS FOR EACH PART OF AN EXTERNAL WALL OF A CLASS 5, 6, 7, 8, 9a AND 9b BUILDING

<i>Climate zone</i>	Options
1, 3, 4 and 6	<p>(a) Achieve a minimum <i>Total R-Value</i> of 1.8.</p>
	<p>(b) (i) Achieve a surface density of not less than 220 kg/m²; and (ii) incorporate a cavity of 20 mm to 35 mm; and (iii) shade the <i>external wall</i> of the <i>storey</i> with a verandah, balcony, eaves, overhang, covered <i>carpark</i>, carport or the like which projects at a minimum angle of 15 degrees in accordance with Figure J1.5; and (iv) incorporate insulation with an <i>R-Value</i> of not less than 1.0.</p>
	<p>(c) (i) Achieve a surface density of not less than 220 kg/m² with masonry that has a thermal conductivity of less than 0.8; and (ii) incorporate a cavity of 20 mm to 35 mm; and (iii) incorporate insulation with an <i>R-Value</i> of not less than 1.0.</p>
	<p>(d) (i) Achieve a surface density of not less than 220 kg/m² with masonry that has a thermal conductivity of less than 0.8; and (ii) shade the <i>external wall</i> of the <i>storey</i> with a verandah, balcony, eaves, overhang, covered <i>carpark</i>, carport or the like which projects at a minimum angle of 30 degrees in accordance with Figure J1.5; and (iii) incorporate insulation with an <i>R-Value</i> of not less than 0.5.</p>
	<p>(e) For an <i>external wall</i> where the only space for insulation is provided by a furring channel, top hat section, batten or the like— (i) achieve a minimum <i>Total R-Value</i> of 1.4; and (ii) satisfy <i>glazing</i> energy index option B of Table J2.4a.</p>

Deemed-to-Satisfy Provisions

Table J1.5b OPTIONS FOR EACH PART OF AN EXTERNAL WALL OF A CLASS 5, 6, 7, 8, 9a AND 9b BUILDING— continued

Climate zone	Options
2 and 5	<p>(a) Achieve a minimum <i>Total R-Value</i> of 1.8.</p> <p>(b) (i) Achieve a surface density of not less than 220 kg/m² with masonry that has a thermal conductivity of less than 0.8; and (ii) shade the <i>external wall</i> of the <i>storey</i> with a verandah, balcony, eaves, overhang, covered <i>carpark</i>, carport or the like which projects at a minimum angle of 30 degrees in accordance with Figure J1.5.</p> <p>(c) (i) Achieve a surface density of not less than 220 kg/m²; and (ii) incorporate a cavity of 20 mm to 35 mm; and (iii) shade the <i>external wall</i> of the <i>storey</i> with a verandah, balcony, eaves, overhang, covered <i>carpark</i>, carport or the like which projects at a minimum angle of 15 degrees in accordance with Figure J1.5; and (iv) incorporate insulation with an <i>R-Value</i> of not less than 0.5.</p> <p>(d) (i) Achieve a surface density of not less than 220 kg/m² with masonry that has a thermal conductivity of less than 0.8; and (ii) incorporate a cavity of 20 mm to 35 mm; and (iii) incorporate insulation with an <i>R-Value</i> of not less than 0.5.</p> <p>(e) For an <i>external wall</i> where the only space for insulation is provided by a furring channel, top hat section, batten or the like— (i) achieve a minimum <i>Total R-Value</i> of 1.4; and (ii) satisfy <i>glazing</i> energy index option B of Table J2.4a.</p>
7	<p>(a) Achieve a minimum <i>Total R-Value</i> of 1.8.</p> <p>(b) (i) Achieve a surface density of not less than 220 kg/m²; and (ii) incorporate a cavity of 20 mm to 35 mm; and (iii) shade the <i>external wall</i> of the <i>storey</i> with a verandah, balcony, eaves, overhang, covered <i>carpark</i>, carport or the like which projects at a minimum angle of 15 degrees in accordance with Figure J1.5; and (iv) incorporate insulation with an <i>R-Value</i> of not less than 1.0.</p> <p>(c) (i) Achieve a surface density of not less than 220 kg/m² with masonry that has a thermal conductivity of less than 0.8; and (ii) incorporate a cavity of 20 mm to 35 mm; and (iii) incorporate insulation with an <i>R-Value</i> of not less than 1.0.</p> <p>(d) For an <i>external wall</i> where the only space for insulation is provided by a furring channel, top hat section, batten or the like— (i) achieve a minimum <i>Total R-Value</i> of 1.4; and (ii) satisfy <i>glazing</i> energy index option B of Table J2.4a.</p>

Deemed-to-Satisfy Provisions

Table J1.5b OPTIONS FOR EACH PART OF AN EXTERNAL WALL OF A CLASS 5, 6, 7, 8, 9a AND 9b BUILDING— continued

Climate zone	Options
8	Achieve a minimum <i>Total R-Value</i> of 2.8.
Note: Refer to J1.1 on the application of Part J1 for Class 7, 8 and 9b buildings that do not have a <i>conditioned space</i> .	

Figure J1.5

MEASUREMENT OF PROJECTION FOR WALL SHADING

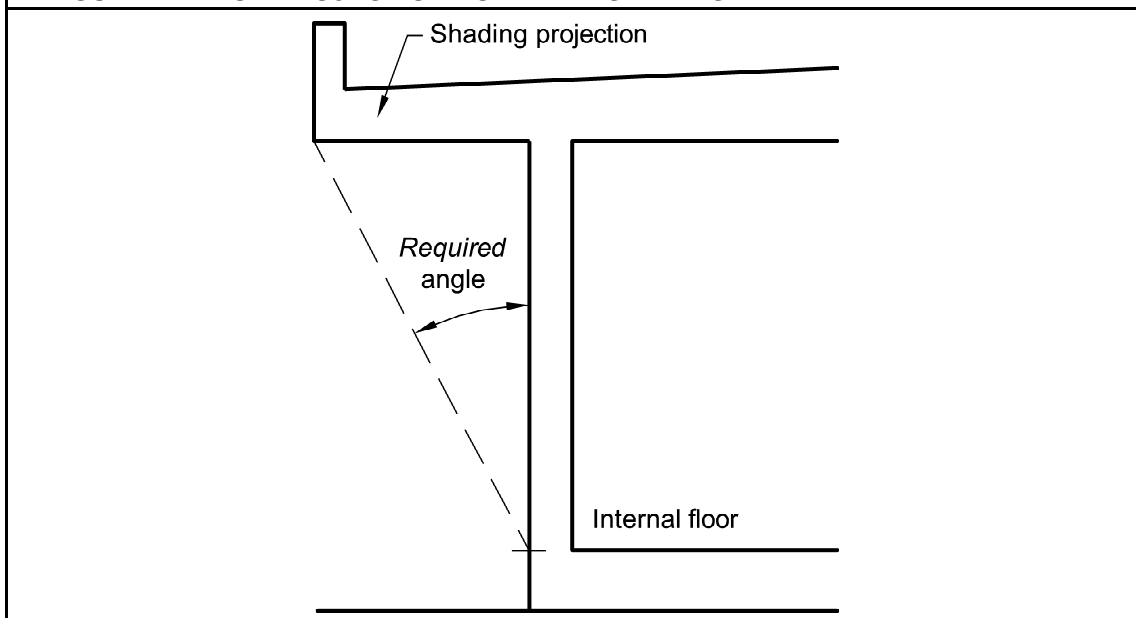

- (b) In *climate zones* 4, 6, 7 and 8, where the minimum *Total R-Value* specified in **Table J1.5(a)** or **Table J1.5(b)** cannot be achieved for a *storey*, the deficit may be compensated by the performance of the *glazing* in that *storey*, provided the sum of the conductance of the *external walls* and of the *glazing* is not more than that *required*, where—
- (i) the design conductance is calculated—
 - (A) for the *external walls*, by dividing their areas by their *Total R-Values*; and
 - (B) for the *glazing*, by multiplying its area by its *Total U-Value*; and
 - (ii) the *required* conductance is calculated—
 - (A) for the *external walls*, by dividing their areas by their *required* minimum *Total R-Values*; and
 - (B) for the *glazing*, in accordance with **J2.3(b)** or **J2.4(b)**.
- (c) In *climate zones* 4, 6, 7 and 8, any wall, other than an *external wall*, that is part of the *envelope* must, subject to **(d)**, satisfy one of the following:
- (i) Satisfy the requirements for an *external wall* that is part of the *envelope*.
 - (ii) In *climate zone* 6, achieve 50% of the *Total R-Value* specified in **Table J1.5a** or **Table J1.5b** provided the adjoining non-*conditioned space* is enclosed.

Deemed-to-Satisfy Provisions

- (iii) In *climate zones* 4, 7 and 8, achieve 50% of the *Total R-Value* specified in **Table J1.5a** or **Table J1.5b** provided the adjoining non-*conditioned space* is enclosed and each element bounding the adjoining non-*conditioned space* achieves 50% of the *Total R-Value* that would be *required* if it were part of the *envelope*.
- (d) The requirements of **(c)(ii)** and **(c)(iii)** only apply where any *roof lights* or *glazing* serving the spaces adjoining the wall satisfy the *Deemed-to-Satisfy Provisions* in **J1.4** and **Part J2**.
- (e) A wall that—
 - (i) is *required* to achieve a minimum *Total R-Value*; and
 - (ii) has lightweight external cladding such as weatherboards, fibre cement or metal sheeting fixed to a metal frame; and
 - (iii) does not have a wall lining or has a wall lining that is fixed directly to the metal frame,
 must have a thermal break, consisting of a material with an *R-Value* of not less than R0.2, installed between the external cladding and the metal frame.
- (f) Wall construction is deemed to have the thermal properties listed in **Specification J1.5**.

J1.6 Floors

- (a) A suspended floor that is part of a building's *envelope*—
 - (i) with an unenclosed perimeter, must achieve the *Total R-Value* specified in **Table J1.6**; and
 - (ii) with an in-slab heating or cooling system, must be insulated around the vertical edge of its perimeter and underneath the slab with insulation having an *R-Value* of not less than 1.0.
- (b) In *climate zones* 1 to 6, the minimum *Total R-Value required* in **(a)** may be reduced by R0.5 provided R0.75 is added to the *Total R-Value required* for the roof and ceiling construction.
- (c) A concrete slab-on-ground—
 - (i) with an in-slab heating or cooling system; or
 - (ii) located in *climate zone* 8,
 must have insulation installed around the vertical edge of its perimeter.
- (d) Insulation *required* by **(c)** must—
 - (i) have an *R-Value* of not less than 1.0; and
 - (ii) be water resistant; and
 - (iii) be continuous from the adjacent finished ground level—
 - (A) to a depth of not less than 300 mm; or
 - (B) for the full depth of the vertical edge of the concrete slab-on-ground.
- (e) Floor construction is deemed to have the thermal properties listed in **Specification J1.6**.

Deemed-to-Satisfy Provisions

Table J1.6 SUSPENDED FLOOR WITH AN UNENCLOSED PERIMETER - MINIMUM TOTAL R-VALUE

Class of building	<i>Climate zone</i>								
	1	2		3	4	5	6	7	8
		Below 300 m altitude	At or above 300 m altitude						
2, 3, 4 and 9c <i>aged care building</i>	Nil	Nil	Nil	Nil	Nil	Nil	1.0	1.0	2.5
5, 6, 7, 8, 9a and 9b	1.5	Nil	Nil	1.5	1.5	Nil	1.5		2.5
Direction of heat flow	Upwards		Downwards and upwards		Downwards				
<p>Note: Altitude means the height, above the Australian Height Datum, of the location where the building is to be constructed.</p>									

PART J2

GLAZING

Deemed-to-Satisfy Provisions

J2.0 Deemed-to-Satisfy Provisions

VIC J2.0

- (a) Where a *Building Solution* is proposed to comply with the *Deemed-to-Satisfy Provisions*, *Performance Requirement JP1* is satisfied by complying with—
- (i) **J1.1** to **J1.6**; and
 - (ii) **J2.1** to **J2.5**; and
 - (iii) **J3.1** to **J3.7**; and
 - (iv) **J4.1** to **J4.4**; and
 - (v) **J5.1** to **J5.5**; and
 - (vi) **J6.1** to **J6.6**; and
 - (vii) **J7.1** to **J7.2**.
- (b) Where a *Building Solution* is proposed as an *Alternative Solution* to the *Deemed-to-Satisfy Provisions* of—
- (i) **J1.1** to **J1.6**; and
 - (ii) **J2.1** to **J2.5**; and
 - (iii) **J3.1** to **J3.7**; and
 - (iv) **J4.1** to **J4.4**; and
 - (v) **J5.1** to **J5.5**; and
 - (vi) **J6.1** to **J6.6**; and
 - (vii) **J7.1** to **J7.2**,

the relevant *Performance Requirements* must be determined in accordance with **A0.10**.

J2.1 Application of Part

VIC J2.1

The *Deemed-to-Satisfy Provisions* of this Part apply to elements forming the *envelope* of a building other than—

- (a) a Class 7, 8 or 9b building that does not have a *conditioned space*; or
- (b) an atrium or solarium that is not a *conditioned space* and is separated from the remainder of the building by an *envelope*.

J2.2 Applicable glazing provisions

Glazing of a building must be designed and installed, as appropriate, in accordance with—

- (a) **J2.3** for a Class 2, 3 or 9c *aged care building* or Class 4 part; and
- (b) **J2.3** or **J2.4** for a Class 6 building with a total *floor area* of not more than 500 m²; and

Deemed-to-Satisfy Provisions

- (c) **J2.4** for—
- (i) a Class 6 building with a total *floor area* of more than 500 m²; and
 - (ii) a Class 5, 7, 8, 9a and 9b building.

J2.3 Glazing - Method 1

- (a) The *glazing* in each *storey*, including any *mezzanine*, of—
- (i) a *sole-occupancy unit*; and
 - (ii) a public space; and
 - (iii) any other occupied space,
- must be assessed separately in accordance with (b) and (c).
- (b) The aggregate conductance and aggregate solar heat gain of the *glazing* must not exceed the allowances obtained by multiplying the area of the floor of the *storey*, including any *mezzanine*, of the *sole-occupancy unit*, public space or other occupied space, measured within the enclosing walls, by—
- (i) for conductance, the constant C_U ; and
 - (ii) for solar heat gain, the constant C_{SHGC} ,
- obtained from **Table J2.3a**.

Table J2.3a CONSTANTS FOR CONDUCTANCE AND SOLAR HEAT GAIN

<i>Climate zone</i>	1	2	3	4	5	6	7	8
C_U	2.4	2.5	1.6	1.2	1.9	1.4	1.2	0.7
C_{SHGC}	0.09	0.15	0.10	0.13	0.14	0.19	0.22	0.32

- (c) The aggregate conductance and aggregate solar heat gain of the *glazing* in each *storey* of a *sole-occupancy unit*, public space or other occupied space, must be calculated by adding the conductance and solar heat gain of each *glazing* element in accordance with the following formulae—

- (i) For conductance:

$$(A_1 \times U_1) + (A_2 \times U_2) + (A_3 \times U_3) + \dots$$

where—

$A_{1, 2, \text{ etc}}$ = the area of each *glazing* element; and

$U_{1, 2, \text{ etc}}$ = the *Total U-Value* of each *glazing* element.

- (ii) For solar heat gain:

$$(A_1 \times SHGC_1 \times E_1) + (A_2 \times SHGC_2 \times E_2) + (A_3 \times SHGC_3 \times E_3) + \dots$$

where—

$A_{1, 2, \text{ etc}}$ = the area of each *glazing* element; and

$SHGC_{1, 2, \text{ etc}}$ = the *SHGC* of each *glazing* element; and

Deemed-to-Satisfy Provisions

$E_{1, 2, \text{etc}}$ = the solar exposure factor for each *glazing* element obtained from **Table J2.3b**.

Table J2.3b SOLAR EXPOSURE FACTOR (E)

P/H (refer Figure J2.4)	Orientation Sector (refer Figure J2.3)							
	North	North east	East	South east	South	South west	West	North west
CLIMATE ZONE 1								
0.00	0.52	0.84	1.29	1.24	0.87	1.27	1.32	0.85
0.05	0.44	0.74	1.19	1.13	0.75	1.17	1.23	0.75
0.10	0.41	0.68	1.11	1.07	0.68	1.09	1.15	0.69
0.15	0.39	0.64	1.06	1.00	0.61	1.02	1.08	0.64
0.20	0.37	0.59	1.01	0.94	0.55	0.94	1.00	0.60
0.25	0.35	0.56	0.95	0.88	0.52	0.89	0.96	0.57
0.30	0.33	0.52	0.90	0.82	0.48	0.85	0.92	0.53
0.35	0.32	0.49	0.84	0.76	0.45	0.80	0.88	0.50
0.40	0.30	0.45	0.79	0.69	0.42	0.75	0.83	0.47
0.50	0.27	0.41	0.72	0.64	0.38	0.67	0.75	0.42
0.60	0.25	0.37	0.66	0.59	0.34	0.60	0.66	0.38
0.70	0.24	0.34	0.59	0.53	0.32	0.56	0.62	0.35
0.80	0.22	0.31	0.53	0.47	0.30	0.52	0.58	0.32
0.90	0.20	0.28	0.49	0.44	0.27	0.48	0.53	0.30
1.00	0.19	0.26	0.45	0.41	0.25	0.43	0.48	0.28
1.10	0.18	0.24	0.41	0.37	0.23	0.41	0.45	0.27
1.20	0.18	0.23	0.37	0.33	0.22	0.39	0.42	0.26
1.30	0.17	0.22	0.35	0.32	0.22	0.36	0.40	0.24
1.40	0.17	0.21	0.32	0.30	0.22	0.32	0.37	0.22
1.50	0.16	0.20	0.30	0.28	0.20	0.31	0.36	0.22
1.60	0.15	0.18	0.28	0.26	0.18	0.29	0.34	0.21
1.70	0.14	0.18	0.28	0.24	0.18	0.29	0.32	0.20
1.80	0.13	0.18	0.27	0.22	0.17	0.28	0.30	0.18
1.90	0.13	0.18	0.25	0.22	0.17	0.26	0.29	0.17
2.00	0.12	0.17	0.23	0.21	0.16	0.24	0.28	0.17
CLIMATE ZONE 2								
0.00	0.72	1.05	1.22	1.04	0.72	1.12	1.34	1.11
0.05	0.60	0.92	1.10	0.92	0.60	1.01	1.23	0.99
0.10	0.55	0.85	1.04	0.86	0.57	0.94	1.14	0.90
0.15	0.51	0.79	0.98	0.81	0.53	0.89	1.07	0.84

Deemed-to-Satisfy Provisions

Table J2.3b SOLAR EXPOSURE FACTOR (E)— continued

P/H (refer Figure J2.4)	Orientation Sector (refer Figure J2.3)							
	North	North east	East	South east	South	South west	West	North west
0.20	0.47	0.74	0.92	0.76	0.50	0.84	1.00	0.78
0.25	0.45	0.69	0.87	0.72	0.47	0.80	0.96	0.73
0.30	0.43	0.65	0.83	0.68	0.45	0.76	0.92	0.69
0.35	0.41	0.60	0.78	0.65	0.43	0.72	0.87	0.64
0.40	0.39	0.56	0.73	0.61	0.40	0.67	0.83	0.60
0.50	0.36	0.50	0.67	0.55	0.37	0.61	0.75	0.53
0.60	0.33	0.44	0.60	0.49	0.33	0.55	0.67	0.45
0.70	0.31	0.40	0.55	0.45	0.31	0.51	0.62	0.42
0.80	0.29	0.37	0.50	0.41	0.29	0.46	0.58	0.39
0.90	0.27	0.34	0.46	0.38	0.27	0.43	0.52	0.35
1.00	0.26	0.30	0.43	0.35	0.24	0.40	0.47	0.32
1.10	0.24	0.29	0.39	0.33	0.23	0.37	0.44	0.30
1.20	0.23	0.27	0.35	0.30	0.22	0.34	0.41	0.28
1.30	0.22	0.26	0.34	0.29	0.22	0.32	0.39	0.26
1.40	0.21	0.24	0.32	0.28	0.21	0.30	0.36	0.24
1.50	0.20	0.24	0.30	0.26	0.20	0.29	0.33	0.23
1.60	0.19	0.23	0.28	0.25	0.19	0.27	0.31	0.22
1.70	0.18	0.22	0.26	0.23	0.18	0.26	0.29	0.21
1.80	0.17	0.20	0.24	0.22	0.17	0.26	0.28	0.20
1.90	0.17	0.19	0.23	0.21	0.17	0.24	0.27	0.19
2.00	0.17	0.19	0.22	0.21	0.16	0.22	0.27	0.19
CLIMATE ZONE 3								
0.00	0.56	1.04	1.42	1.18	0.66	1.16	1.36	1.01
0.05	0.47	0.94	1.32	1.08	0.57	1.05	1.26	0.90
0.10	0.44	0.85	1.25	1.02	0.54	0.99	1.19	0.83
0.15	0.41	0.79	1.17	0.96	0.50	0.93	1.13	0.78
0.20	0.38	0.73	1.10	0.90	0.46	0.87	1.06	0.73
0.25	0.36	0.69	1.05	0.85	0.44	0.83	1.00	0.68
0.30	0.35	0.64	0.99	0.81	0.42	0.79	0.95	0.64
0.35	0.34	0.60	0.93	0.76	0.40	0.75	0.90	0.60
0.40	0.32	0.56	0.88	0.71	0.38	0.72	0.84	0.56
0.50	0.30	0.49	0.81	0.65	0.35	0.64	0.77	0.50
0.60	0.28	0.43	0.74	0.58	0.31	0.57	0.71	0.44

Deemed-to-Satisfy Provisions

Table J2.3b SOLAR EXPOSURE FACTOR (E)— continued

P/H (refer Figure J2.4)	Orientation Sector (refer Figure J2.3)							
	North	North east	East	South east	South	South west	West	North west
0.70	0.26	0.39	0.67	0.53	0.29	0.53	0.65	0.40
0.80	0.24	0.35	0.59	0.47	0.27	0.50	0.60	0.35
0.90	0.22	0.32	0.54	0.44	0.25	0.46	0.56	0.32
1.00	0.20	0.29	0.50	0.40	0.24	0.43	0.53	0.29
1.10	0.20	0.28	0.46	0.37	0.22	0.40	0.48	0.28
1.20	0.19	0.26	0.42	0.34	0.21	0.37	0.43	0.26
1.30	0.18	0.24	0.39	0.33	0.20	0.35	0.42	0.25
1.40	0.17	0.22	0.35	0.31	0.20	0.32	0.41	0.23
1.50	0.17	0.21	0.34	0.29	0.18	0.32	0.38	0.22
1.60	0.17	0.20	0.33	0.27	0.16	0.31	0.35	0.21
1.70	0.16	0.19	0.31	0.25	0.16	0.29	0.34	0.20
1.80	0.15	0.19	0.30	0.24	0.16	0.28	0.33	0.19
1.90	0.15	0.18	0.28	0.24	0.15	0.26	0.30	0.18
2.00	0.15	0.18	0.25	0.24	0.15	0.24	0.27	0.17
CLIMATE ZONE 4								
0.00	0.72	1.19	1.40	1.05	0.57	0.99	1.31	1.12
0.05	0.61	1.10	1.31	0.97	0.49	0.91	1.22	1.02
0.10	0.56	1.00	1.24	0.91	0.46	0.85	1.17	0.94
0.15	0.49	0.94	1.18	0.86	0.44	0.81	1.11	0.87
0.20	0.43	0.87	1.12	0.82	0.41	0.76	1.05	0.81
0.25	0.40	0.82	1.07	0.78	0.39	0.73	1.00	0.76
0.30	0.37	0.76	1.02	0.74	0.38	0.69	0.95	0.71
0.35	0.33	0.71	0.97	0.71	0.36	0.66	0.90	0.66
0.40	0.30	0.66	0.92	0.67	0.34	0.62	0.85	0.62
0.50	0.29	0.58	0.83	0.61	0.31	0.58	0.79	0.53
0.60	0.27	0.50	0.74	0.56	0.29	0.53	0.72	0.45
0.70	0.26	0.44	0.68	0.52	0.27	0.49	0.66	0.40
0.80	0.24	0.38	0.63	0.49	0.25	0.45	0.59	0.36
0.90	0.22	0.35	0.59	0.46	0.23	0.42	0.55	0.33
1.00	0.20	0.31	0.55	0.42	0.22	0.39	0.51	0.30
1.10	0.20	0.29	0.50	0.39	0.21	0.37	0.48	0.27
1.20	0.19	0.26	0.46	0.37	0.20	0.35	0.45	0.25
1.30	0.17	0.24	0.43	0.35	0.18	0.34	0.41	0.23

Deemed-to-Satisfy Provisions

Table J2.3b SOLAR EXPOSURE FACTOR (E)— continued

P/H (refer Figure J2.4)	Orientation Sector (refer Figure J2.3)							
	North	North east	East	South east	South	South west	West	North west
1.40	0.16	0.23	0.39	0.34	0.17	0.33	0.38	0.21
1.50	0.16	0.21	0.38	0.32	0.17	0.31	0.35	0.21
1.60	0.16	0.20	0.38	0.30	0.16	0.29	0.33	0.20
1.70	0.15	0.19	0.35	0.29	0.15	0.27	0.32	0.18
1.80	0.14	0.18	0.32	0.27	0.14	0.25	0.32	0.17
1.90	0.14	0.17	0.30	0.25	0.14	0.24	0.29	0.16
2.00	0.13	0.17	0.28	0.23	0.14	0.24	0.26	0.16
CLIMATE ZONE 5								
0.00	0.82	1.09	1.19	0.96	0.68	1.04	1.30	1.16
0.05	0.69	0.96	1.07	0.85	0.57	0.92	1.19	1.04
0.10	0.63	0.88	1.01	0.79	0.54	0.86	1.11	0.94
0.15	0.57	0.82	0.95	0.75	0.51	0.81	1.05	0.88
0.20	0.51	0.76	0.89	0.70	0.48	0.76	0.99	0.83
0.25	0.48	0.72	0.85	0.67	0.46	0.72	0.95	0.77
0.30	0.45	0.67	0.80	0.64	0.43	0.69	0.90	0.72
0.35	0.42	0.63	0.76	0.60	0.41	0.65	0.85	0.67
0.40	0.39	0.58	0.71	0.57	0.38	0.62	0.81	0.62
0.50	0.37	0.52	0.65	0.52	0.36	0.56	0.73	0.55
0.60	0.35	0.46	0.58	0.47	0.33	0.51	0.65	0.48
0.70	0.32	0.42	0.54	0.43	0.31	0.47	0.59	0.44
0.80	0.30	0.37	0.50	0.40	0.28	0.43	0.52	0.40
0.90	0.28	0.34	0.46	0.37	0.26	0.40	0.49	0.35
1.00	0.26	0.31	0.42	0.34	0.25	0.37	0.46	0.31
1.10	0.25	0.28	0.39	0.32	0.23	0.35	0.43	0.29
1.20	0.24	0.26	0.36	0.30	0.22	0.33	0.40	0.27
1.30	0.23	0.25	0.34	0.28	0.21	0.31	0.37	0.26
1.40	0.21	0.23	0.32	0.27	0.20	0.29	0.34	0.24
1.50	0.21	0.22	0.30	0.25	0.19	0.28	0.32	0.23
1.60	0.20	0.22	0.29	0.23	0.18	0.27	0.30	0.21
1.70	0.19	0.21	0.27	0.22	0.18	0.25	0.29	0.20
1.80	0.18	0.20	0.25	0.21	0.17	0.23	0.27	0.20
1.90	0.18	0.19	0.24	0.21	0.17	0.22	0.26	0.19
2.00	0.17	0.17	0.24	0.21	0.16	0.21	0.25	0.19

Deemed-to-Satisfy Provisions

Table J2.3b SOLAR EXPOSURE FACTOR (E)— continued

P/H (refer Figure J2.4)	Orientation Sector (refer Figure J2.3)							
	North	North east	East	South east	South	South west	West	North west
CLIMATE ZONE 6								
0.00	0.84	1.08	1.15	0.87	0.61	1.05	1.40	1.24
0.05	0.71	0.97	1.05	0.78	0.52	0.96	1.30	1.13
0.10	0.65	0.90	0.99	0.74	0.49	0.91	1.25	1.04
0.15	0.58	0.83	0.93	0.69	0.47	0.86	1.18	0.97
0.20	0.52	0.77	0.88	0.65	0.44	0.82	1.12	0.91
0.25	0.48	0.72	0.84	0.62	0.42	0.78	1.06	0.85
0.30	0.44	0.68	0.80	0.59	0.40	0.75	1.01	0.80
0.35	0.40	0.63	0.75	0.57	0.38	0.71	0.95	0.75
0.40	0.36	0.58	0.71	0.54	0.36	0.67	0.90	0.69
0.50	0.33	0.51	0.66	0.49	0.33	0.63	0.83	0.60
0.60	0.30	0.43	0.61	0.45	0.31	0.58	0.76	0.51
0.70	0.28	0.39	0.56	0.42	0.29	0.54	0.71	0.45
0.80	0.26	0.35	0.50	0.38	0.26	0.50	0.66	0.40
0.90	0.24	0.32	0.46	0.35	0.25	0.46	0.61	0.38
1.00	0.22	0.29	0.42	0.32	0.23	0.42	0.56	0.36
1.10	0.21	0.26	0.40	0.30	0.23	0.41	0.52	0.32
1.20	0.20	0.24	0.37	0.29	0.23	0.39	0.48	0.29
1.30	0.19	0.23	0.34	0.27	0.21	0.36	0.45	0.27
1.40	0.18	0.22	0.32	0.26	0.19	0.34	0.42	0.26
1.50	0.17	0.21	0.30	0.25	0.19	0.32	0.40	0.24
1.60	0.16	0.19	0.28	0.24	0.18	0.31	0.38	0.21
1.70	0.16	0.19	0.27	0.23	0.18	0.29	0.36	0.20
1.80	0.15	0.18	0.26	0.22	0.17	0.28	0.34	0.20
1.90	0.15	0.18	0.25	0.21	0.17	0.27	0.32	0.19
2.00	0.14	0.17	0.24	0.21	0.17	0.26	0.31	0.17
CLIMATE ZONE 7								
0.00	0.96	1.17	1.21	0.94	0.64	0.91	1.19	1.18
0.05	0.83	1.05	1.10	0.83	0.54	0.81	1.09	1.07
0.10	0.76	0.97	1.04	0.80	0.51	0.76	1.03	0.98
0.15	0.69	0.91	0.98	0.75	0.48	0.72	0.97	0.92
0.20	0.62	0.85	0.93	0.70	0.45	0.68	0.91	0.86
0.25	0.56	0.80	0.89	0.67	0.43	0.65	0.87	0.81

Deemed-to-Satisfy Provisions

Table J2.3b SOLAR EXPOSURE FACTOR (E)— continued

P/H (refer Figure J2.4)	Orientation Sector (refer Figure J2.3)							
	North	North east	East	South east	South	South west	West	North west
0.30	0.51	0.75	0.84	0.64	0.41	0.62	0.82	0.75
0.35	0.46	0.70	0.80	0.61	0.40	0.59	0.78	0.69
0.40	0.40	0.65	0.76	0.58	0.38	0.55	0.74	0.64
0.50	0.36	0.58	0.71	0.54	0.35	0.51	0.69	0.57
0.60	0.32	0.51	0.65	0.50	0.33	0.47	0.63	0.51
0.70	0.30	0.45	0.60	0.47	0.30	0.44	0.58	0.45
0.80	0.28	0.40	0.54	0.44	0.28	0.41	0.53	0.40
0.90	0.26	0.36	0.51	0.41	0.27	0.38	0.48	0.36
1.00	0.25	0.33	0.48	0.37	0.25	0.35	0.44	0.32
1.10	0.24	0.30	0.45	0.36	0.24	0.33	0.41	0.29
1.20	0.22	0.28	0.41	0.34	0.23	0.31	0.38	0.27
1.30	0.21	0.26	0.39	0.32	0.22	0.30	0.36	0.25
1.40	0.19	0.23	0.36	0.30	0.21	0.28	0.33	0.24
1.50	0.19	0.22	0.34	0.29	0.20	0.27	0.32	0.22
1.60	0.18	0.21	0.33	0.27	0.20	0.26	0.31	0.21
1.70	0.18	0.20	0.30	0.26	0.19	0.25	0.29	0.20
1.80	0.17	0.20	0.28	0.24	0.18	0.24	0.27	0.19
1.90	0.17	0.19	0.27	0.24	0.18	0.22	0.26	0.18
2.00	0.16	0.19	0.27	0.23	0.18	0.21	0.25	0.18
CLIMATE ZONE 8								
0.00	0.85	1.12	1.20	0.96	0.68	1.01	1.27	1.16
0.05	0.71	0.99	1.09	0.85	0.57	0.90	1.16	1.04
0.10	0.65	0.90	1.02	0.79	0.54	0.84	1.09	0.95
0.15	0.59	0.85	0.96	0.75	0.51	0.78	1.04	0.89
0.20	0.52	0.79	0.90	0.70	0.48	0.73	0.98	0.83
0.25	0.49	0.74	0.86	0.67	0.45	0.70	0.93	0.78
0.30	0.45	0.70	0.82	0.64	0.43	0.67	0.88	0.73
0.35	0.42	0.65	0.77	0.61	0.41	0.64	0.84	0.68
0.40	0.39	0.60	0.73	0.57	0.39	0.61	0.79	0.63
0.50	0.36	0.53	0.67	0.53	0.36	0.56	0.73	0.56
0.60	0.34	0.46	0.60	0.48	0.33	0.50	0.66	0.49
0.70	0.32	0.41	0.55	0.45	0.31	0.47	0.60	0.44
0.80	0.30	0.37	0.50	0.41	0.29	0.43	0.53	0.40

Deemed-to-Satisfy Provisions

Table J2.3b SOLAR EXPOSURE FACTOR (E)— continued

P/H (refer Figure J2.4)	Orientation Sector (refer Figure J2.3)							
	North	North east	East	South east	South	South west	West	North west
0.90	0.28	0.33	0.46	0.38	0.27	0.40	0.50	0.36
1.00	0.25	0.30	0.42	0.35	0.25	0.37	0.47	0.33
1.10	0.24	0.29	0.40	0.33	0.24	0.35	0.43	0.29
1.20	0.23	0.28	0.37	0.31	0.23	0.33	0.39	0.26
1.30	0.22	0.26	0.35	0.30	0.22	0.31	0.37	0.25
1.40	0.21	0.23	0.32	0.29	0.20	0.29	0.34	0.24
1.50	0.20	0.22	0.31	0.27	0.19	0.27	0.32	0.23
1.60	0.20	0.21	0.30	0.25	0.18	0.25	0.31	0.22
1.70	0.19	0.21	0.28	0.23	0.18	0.24	0.29	0.21
1.80	0.19	0.20	0.25	0.22	0.17	0.23	0.28	0.20
1.90	0.17	0.19	0.24	0.22	0.16	0.23	0.26	0.19
2.00	0.16	0.18	0.23	0.21	0.16	0.22	0.24	0.19

Notes:

- The orientation sector of the glazing is based on True North.
- Exposure factors for P/H values between those shown in the Table can be interpolated.

J2.4 Glazing - Method 2

- (a) The *glazing* in each *storey*, including any *mezzanine*, of a building must be assessed separately in accordance with (b) and (c) for—
- glazing* in the external *fabric* facing each orientation; and
 - glazing* in the internal *fabric* using the south orientation sector energy constants in Table J2.4b and shading multipliers in Table J2.4c and Table J2.4d.
- (b) The aggregate *air-conditioning* energy value attributable to the *glazing* must not exceed the allowance obtained by multiplying the facade area of the orientation by the energy index in Table J2.4a.

Table J2.4a ENERGY INDEX

Energy index option	Climate zone							
	1	2	3	4	5	6	7	8
A	0.180	0.217	0.221	0.227	0.257	0.220	0.170	0.046
B	0.173	0.209	0.208	0.204	0.236	0.191	0.148	Not applicable

Note

Option A applies to all *glazing* other than where compliance with Option B is *required* by Table J1.5b

Deemed-to-Satisfy Provisions

- (c) The aggregate *air-conditioning* energy value must be calculated by adding the *air-conditioning* energy value through each *glazing* element in accordance with the following formula:

$$A_1[SHGC_1(C_A \times S_{H1} + C_B \times S_{C1}) + C_C \times U_1] + A_2[SHGC_2(C_A \times S_{H2} + C_B \times S_{C2}) + C_C \times U_2] + \dots$$

where—

- $A_{1, 2, \text{ etc}}$ = the area of each *glazing* element; and
- $C_{A, B \text{ and } C}$ = the energy constants A, B and C for the specific orientation from **Table J2.4b**; and
- $SHGC_{1, 2, \text{ etc}}$ = the *SHGC* of each *glazing* element; and
- $S_{H1, 2, \text{ etc}}$ = the heating shading multiplier for each *glazing* element obtained from **Table J2.4c**; and
- $S_{C1, 2, \text{ etc}}$ = the cooling shading multiplier for each *glazing* element obtained from **Table J2.4d**; and
- $U_{1, 2, \text{ etc}}$ = the *Total U-Value* of each *glazing* element.

- (d) For the purposes of (c), where the *air-conditioning* energy value of a *glazing* element is calculated to be negative, it must be taken to be zero.

Table J2.4b ENERGY CONSTANTS (C_A , C_B AND C_C)

Climate zone	Energy constants	Orientation Sector (refer Figure J2.3)							
		North	North east	East	South east	South	South west	West	North west
1	C_A	0.00	0.00	0.00	0.00	0.00	0.00	0.00	0.00
	C_B	0.80	0.92	0.91	0.67	0.48	0.67	0.88	0.91
	C_C	0.02	0.02	0.02	0.02	0.02	0.02	0.02	0.02
2	C_A	0.00	0.00	0.00	0.00	0.00	0.00	0.00	0.00
	C_B	1.20	1.40	1.31	0.84	0.48	0.70	1.03	1.17
	C_C	-0.01	-0.01	-0.01	0.00	0.00	0.00	-0.01	-0.01
3	C_A	0.00	0.00	0.00	0.00	0.00	0.00	0.00	0.00
	C_B	1.01	1.16	1.08	0.69	0.41	0.67	1.01	1.09
	C_C	0.01	0.01	0.01	0.02	0.01	0.01	0.01	0.01
4	C_A	-0.16	-0.18	-0.30	-0.44	-0.45	-0.46	-0.40	-0.26
	C_B	1.25	1.37	1.18	0.68	0.35	0.60	0.98	1.20
	C_C	0.00	0.00	0.03	0.07	0.09	0.08	0.04	0.02
5	C_A	-0.06	-0.09	-0.18	-0.41	-0.47	-0.43	-0.28	-0.14
	C_B	1.46	1.55	1.32	0.75	0.41	0.68	1.13	1.38
	C_C	-0.02	-0.01	0.00	0.05	0.07	0.05	0.02	-0.01

Deemed-to-Satisfy Provisions

Table J2.4b ENERGY CONSTANTS (C_A , C_B AND C_C)— continued

Climate zone	Energy constants	Orientation Sector (refer Figure J2.3)							
		North	North east	East	South east	South	South west	West	North west
6	C_A	-0.37	-0.38	-0.59	-0.82	-0.87	-0.90	-0.85	-0.61
	C_B	1.53	1.66	1.39	0.80	0.38	0.66	1.07	1.34
	C_C	-0.01	-0.01	0.03	0.11	0.15	0.13	0.08	0.03
7	C_A	-0.41	-0.43	-0.70	-0.76	-0.74	-0.85	-0.92	-0.71
	C_B	1.32	1.39	1.09	0.59	0.25	0.47	0.81	1.09
	C_C	0.00	0.01	0.06	0.13	0.16	0.15	0.11	0.05
8	C_A	-0.87	-0.81	-0.75	-0.61	-0.73	-0.75	-0.87	-0.92
	C_B	0.55	0.61	0.52	0.28	0.10	0.26	0.46	0.54
	C_C	0.13	0.12	0.14	0.17	0.20	0.19	0.22	0.15

Table J2.4c HEATING SHADING MULTIPLIER (S_H)

G (refer Figure J2.4)	P/H (refer Figure J2.4)	Orientation Sector (refer Figure J2.3)							
		North	North east	East	South east	South	South west	West	North west
CLIMATE ZONES 1, 2 AND 3									
In <i>climate zones</i> 1, 2 and 3, the heating shading multiplier is to be taken as 1.0									
CLIMATE ZONES 4 AND 5									
Not more than 100 mm	0.0	1.00	1.00	1.00	1.00	1.00	1.00	1.00	1.00
	0.2	0.96	0.95	0.92	0.90	0.94	0.92	0.92	0.95
	0.4	0.86	0.83	0.79	0.78	0.87	0.83	0.80	0.85
	0.6	0.66	0.65	0.63	0.69	0.81	0.74	0.66	0.70
	0.8	0.30	0.41	0.43	0.62	0.77	0.66	0.50	0.47
	1.0	0.00	0.08	0.22	0.56	0.74	0.60	0.35	0.15
	1.2	0.00	0.00	0.08	0.52	0.71	0.54	0.21	0.00
	1.4	0.00	0.00	0.04	0.48	0.69	0.50	0.12	0.00
	1.6	0.00	0.00	0.02	0.45	0.67	0.46	0.08	0.00
	1.8	0.00	0.00	0.01	0.42	0.66	0.43	0.04	0.00
2.0	0.00	0.00	0.00	0.39	0.64	0.39	0.00	0.00	

Deemed-to-Satisfy Provisions

Table J2.4c HEATING SHADING MULTIPLIER (S_{Ht})— continued

G (refer Figure J2.4)	P/H (refer Figure J2.4)	Orientation Sector (refer Figure J2.3)							
		North	North east	East	South east	South	South west	West	North west
More than 100 mm but not more than 500 mm	0.0	1.00	1.00	1.00	1.00	1.00	1.00	1.00	1.00
	0.2	0.99	0.99	0.98	0.97	0.98	0.97	0.98	0.99
	0.4	0.97	0.95	0.92	0.89	0.93	0.91	0.92	0.96
	0.6	0.91	0.88	0.84	0.81	0.88	0.85	0.85	0.90
	0.8	0.79	0.78	0.73	0.70	0.84	0.79	0.75	0.81
	1.0	0.59	0.63	0.62	0.67	0.80	0.73	0.65	0.69
	1.2	0.27	0.45	0.48	0.63	0.78	0.68	0.54	0.50
	1.4	0.03	0.28	0.35	0.59	0.75	0.63	0.44	0.31
	1.6	0.02	0.19	0.25	0.56	0.74	0.59	0.34	0.21
	1.8	0.01	0.09	0.14	0.52	0.72	0.55	0.25	0.10
More than 500 mm but not more than 1200 mm	0.0	1.00	1.00	1.00	1.00	1.00	1.00	1.00	1.00
	0.2	1.00	1.00	0.99	0.99	0.99	0.99	0.99	0.99
	0.4	0.99	0.98	0.97	0.97	0.97	0.96	0.97	0.99
	0.6	0.98	0.97	0.94	0.92	0.95	0.93	0.94	0.97
	0.8	0.95	0.94	0.90	0.88	0.92	0.89	0.90	0.94
	1.0	0.91	0.89	0.84	0.83	0.89	0.85	0.84	0.90
	1.2	0.82	0.82	0.78	0.78	0.86	0.82	0.78	0.84
	1.4	0.67	0.71	0.70	0.73	0.84	0.78	0.71	0.75
	1.6	0.45	0.58	0.60	0.70	0.81	0.74	0.64	0.62
	1.8	0.22	0.44	0.51	0.66	0.79	0.71	0.56	0.48
More than 1200 mm but less than 1800 mm	0.0	1.00	1.00	1.00	1.00	1.00	1.00	1.00	1.00
	0.2	1.00	1.00	1.00	1.00	1.00	1.00	1.00	1.00
	0.4	1.00	0.99	0.99	0.98	0.99	0.98	0.98	0.99
	0.6	0.99	0.98	0.97	0.96	0.97	0.96	0.97	0.98
	0.8	0.98	0.97	0.95	0.93	0.95	0.93	0.94	0.97
	1.0	0.97	0.95	0.92	0.90	0.93	0.91	0.91	0.95
	1.2	0.94	0.92	0.88	0.87	0.91	0.88	0.87	0.93
	1.4	0.88	0.87	0.83	0.83	0.89	0.85	0.83	0.88
	1.6	0.77	0.80	0.77	0.80	0.87	0.82	0.77	0.83
	1.8	0.66	0.73	0.71	0.77	0.86	0.79	0.72	0.77
2.0	0.56	0.66	0.66	0.73	0.84	0.77	0.67	0.71	

Deemed-to-Satisfy Provisions

Table J2.4c HEATING SHADING MULTIPLIER (S_{Hc})— continued

G (refer Figure J2.4)	P/H (refer Figure J2.4)	Orientation Sector (refer Figure J2.3)							
		North	North east	East	South east	South	South west	West	North west
CLIMATE ZONES 6 AND 7									
Not more than 100 mm	0.0	1.00	1.00	1.00	1.00	1.00	1.00	1.00	1.00
	0.2	0.95	0.93	0.91	0.90	0.93	0.91	0.91	0.93
	0.4	0.82	0.82	0.78	0.79	0.86	0.81	0.78	0.80
	0.6	0.61	0.66	0.64	0.70	0.80	0.71	0.64	0.62
	0.8	0.31	0.46	0.49	0.63	0.74	0.63	0.52	0.41
	1.0	0.02	0.23	0.35	0.58	0.70	0.56	0.40	0.17
	1.2	0.00	0.04	0.23	0.53	0.66	0.51	0.30	0.02
	1.4	0.00	0.00	0.14	0.49	0.63	0.47	0.22	0.00
	1.6	0.00	0.00	0.10	0.45	0.60	0.44	0.16	0.00
	1.8	0.00	0.00	0.05	0.41	0.58	0.41	0.11	0.00
	2.0	0.00	0.00	0.01	0.37	0.55	0.38	0.05	0.00
More than 100 mm but not more than 500 mm	0.0	1.00	1.00	1.00	1.00	1.00	1.00	1.00	1.00
	0.2	0.99	0.99	0.98	0.97	0.97	0.97	0.97	0.98
	0.4	0.96	0.94	0.91	0.89	0.93	0.91	0.91	0.94
	0.6	0.88	0.87	0.83	0.82	0.87	0.84	0.82	0.86
	0.8	0.75	0.78	0.73	0.70	0.83	0.76	0.71	0.75
	1.0	0.57	0.66	0.62	0.68	0.78	0.69	0.61	0.60
	1.2	0.33	0.51	0.51	0.64	0.75	0.63	0.52	0.44
	1.4	0.14	0.37	0.42	0.60	0.72	0.59	0.44	0.30
	1.6	0.10	0.25	0.33	0.57	0.69	0.55	0.36	0.20
	1.8	0.05	0.12	0.25	0.53	0.67	0.51	0.29	0.10
	2.0	0.00	0.00	0.17	0.50	0.64	0.48	0.21	0.00

Deemed-to-Satisfy Provisions

Table J2.4c HEATING SHADING MULTIPLIER (S_{Hc})— continued

G (refer Figure J2.4)	P/H (refer Figure J2.4)	Orientation Sector (refer Figure J2.3)							
		North	North east	East	South east	South	South west	West	North west
More than 500 mm but not more than 1200 mm	0.0	1.00	1.00	1.00	1.00	1.00	1.00	1.00	1.00
	0.2	1.00	0.99	0.99	0.99	0.99	0.99	0.99	0.99
	0.4	0.99	0.98	0.97	0.96	0.97	0.96	0.96	0.98
	0.6	0.97	0.96	0.93	0.92	0.94	0.92	0.92	0.96
	0.8	0.94	0.93	0.89	0.87	0.91	0.88	0.87	0.92
	1.0	0.88	0.88	0.83	0.82	0.87	0.83	0.81	0.86
	1.2	0.79	0.82	0.77	0.77	0.85	0.79	0.75	0.79
	1.4	0.66	0.73	0.69	0.73	0.82	0.75	0.68	0.69
	1.6	0.48	0.63	0.62	0.69	0.79	0.70	0.61	0.57
	1.8	0.30	0.53	0.54	0.66	0.76	0.66	0.55	0.45
2.0	0.13	0.42	0.47	0.63	0.74	0.62	0.48	0.33	
More than 1200 mm but less than 1800 mm	0.0	1.00	1.00	1.00	1.00	1.00	1.00	1.00	1.00
	0.2	1.00	1.00	1.00	1.00	1.00	0.99	0.99	1.00
	0.4	0.99	0.99	0.98	0.98	0.98	0.98	0.98	0.99
	0.6	0.99	0.98	0.97	0.96	0.96	0.95	0.96	0.98
	0.8	0.98	0.96	0.94	0.93	0.94	0.93	0.93	0.96
	1.0	0.96	0.94	0.91	0.89	0.92	0.90	0.89	0.93
	1.2	0.92	0.91	0.87	0.86	0.90	0.86	0.84	0.89
	1.4	0.85	0.87	0.82	0.82	0.87	0.83	0.80	0.84
	1.6	0.76	0.81	0.77	0.79	0.85	0.80	0.74	0.77
	1.8	0.67	0.75	0.72	0.75	0.83	0.77	0.69	0.69
2.0	0.57	0.69	0.67	0.72	0.81	0.74	0.64	0.62	

Deemed-to-Satisfy Provisions

Table J2.4c HEATING SHADING MULTIPLIER (S_{Ht})— continued

G (refer Figure J2.4)	P/H (refer Figure J2.4)	Orientation Sector (refer Figure J2.3)							
		North	North east	East	South east	South	South west	West	North west
CLIMATE ZONE 8									
Not more than 100 mm	0.0	1.00	1.00	1.00	1.00	1.00	1.00	1.00	1.00
	0.2	0.90	0.91	0.90	0.93	0.93	0.91	0.92	0.91
	0.4	0.73	0.77	0.77	0.89	0.85	0.80	0.80	0.77
	0.6	0.55	0.63	0.68	0.83	0.77	0.72	0.68	0.62
	0.8	0.37	0.50	0.61	0.75	0.71	0.67	0.57	0.48
	1.0	0.19	0.35	0.53	0.67	0.66	0.64	0.49	0.37
	1.2	0.07	0.22	0.44	0.60	0.62	0.62	0.43	0.29
	1.4	0.00	0.12	0.36	0.53	0.59	0.59	0.38	0.21
	1.6	0.00	0.08	0.29	0.48	0.56	0.56	0.34	0.15
	1.8	0.00	0.04	0.23	0.43	0.53	0.52	0.31	0.09
	2.0	0.00	0.00	0.16	0.38	0.51	0.48	0.27	0.04
More than 100 mm but not more than 500 mm	0.0	1.00	1.00	1.00	1.00	1.00	1.00	1.00	1.00
	0.2	0.96	0.96	0.95	0.95	0.96	0.95	0.96	0.96
	0.4	0.87	0.89	0.87	0.91	0.90	0.87	0.89	0.88
	0.6	0.73	0.79	0.78	0.87	0.85	0.81	0.81	0.78
	0.8	0.57	0.67	0.70	0.81	0.79	0.73	0.72	0.66
	1.0	0.42	0.56	0.64	0.79	0.75	0.69	0.63	0.54
	1.2	0.27	0.45	0.59	0.74	0.71	0.66	0.55	0.43
	1.4	0.17	0.32	0.52	0.67	0.67	0.63	0.49	0.35
	1.6	0.10	0.22	0.46	0.62	0.64	0.62	0.44	0.28
	1.8	0.03	0.13	0.39	0.57	0.62	0.61	0.40	0.22
	2.0	0.00	0.00	0.00	0.10	0.75	0.50	0.00	0.00

Deemed-to-Satisfy Provisions

Table J2.4c HEATING SHADING MULTIPLIER (S_{H})— continued

G (refer Figure J2.4)	P/H (refer Figure J2.4)	Orientation Sector (refer Figure J2.3)							
		North	North east	East	South east	South	South west	West	North west
More than 500 mm but not more than 1200 mm	0.0	1.00	1.00	1.00	1.00	1.00	1.00	1.00	1.00
	0.2	0.99	0.99	0.99	0.98	0.99	0.99	0.99	0.99
	0.4	0.97	0.97	0.96	0.95	0.96	0.95	0.96	0.97
	0.6	0.93	0.94	0.92	0.92	0.93	0.91	0.93	0.92
	0.8	0.85	0.89	0.87	0.88	0.90	0.86	0.88	0.87
	1.0	0.75	0.82	0.79	0.86	0.86	0.82	0.83	0.80
	1.2	0.65	0.73	0.74	0.86	0.82	0.78	0.77	0.72
	1.4	0.54	0.65	0.69	0.85	0.79	0.73	0.71	0.64
	1.6	0.42	0.56	0.66	0.81	0.76	0.70	0.65	0.55
	1.8	0.31	0.48	0.62	0.76	0.73	0.66	0.60	0.47
	2.0	0.20	0.39	0.58	0.72	0.70	0.63	0.54	0.39
More than 1200 mm but less than 1800 mm	0.0	1.00	1.00	1.00	1.00	1.00	1.00	1.00	1.00
	0.2	1.00	1.00	0.99	0.99	1.00	0.99	0.99	0.99
	0.4	0.98	0.98	0.98	0.98	0.98	0.98	0.98	0.98
	0.6	0.96	0.97	0.96	0.96	0.96	0.95	0.96	0.96
	0.8	0.93	0.94	0.92	0.94	0.94	0.91	0.93	0.93
	1.0	0.88	0.91	0.89	0.91	0.91	0.89	0.90	0.89
	1.2	0.80	0.86	0.84	0.88	0.89	0.86	0.86	0.84
	1.4	0.72	0.80	0.78	0.87	0.86	0.83	0.81	0.78
	1.6	0.63	0.74	0.75	0.87	0.84	0.80	0.77	0.72
	1.8	0.54	0.67	0.71	0.86	0.82	0.77	0.72	0.65
	2.0	0.45	0.60	0.67	0.86	0.79	0.74	0.68	0.58

Notes:

1. In *climate zones* 4 to 8, where G is 1800 mm or more, the heating shading multiplier is to be taken as 1.0.
2. The heating shading multiplier for P/H values between those shown in **Table J2.4c** can be interpolated.
3. For *glazing* in the internal *fabric* use the appropriate value for the south orientation sector with a P/H value of 2.0.

Deemed-to-Satisfy Provisions

Table J2.4d COOLING SHADING MULTIPLIER (S_c)

G (refer Figure J2.4)	P/H (refer Figure J2.4)	Orientation Sector (refer Figure J2.3)							
		North	North east	East	South east	South	South west	West	North west
CLIMATE ZONES 1, 2 AND 3									
Not more than 100 mm	0.0	1.00	1.00	1.00	1.00	1.00	1.00	1.00	1.00
	0.2	0.79	0.84	0.86	0.85	0.87	0.87	0.87	0.84
	0.4	0.57	0.66	0.71	0.70	0.76	0.73	0.72	0.67
	0.6	0.41	0.52	0.58	0.58	0.68	0.62	0.60	0.53
	0.8	0.32	0.40	0.47	0.48	0.62	0.54	0.50	0.43
	1.0	0.26	0.32	0.39	0.42	0.58	0.48	0.43	0.35
	1.2	0.22	0.28	0.33	0.38	0.56	0.43	0.37	0.30
	1.4	0.20	0.24	0.29	0.34	0.53	0.39	0.33	0.25
	1.6	0.19	0.22	0.26	0.32	0.52	0.36	0.29	0.22
	1.8	0.18	0.20	0.23	0.30	0.50	0.33	0.26	0.20
	2.0	0.17	0.18	0.21	0.28	0.49	0.31	0.24	0.18
More than 100 mm but not more than 500 mm	0.0	1.00	1.00	1.00	1.00	1.00	1.00	1.00	1.00
	0.2	0.92	0.94	0.95	0.94	0.93	0.94	0.95	0.94
	0.4	0.72	0.81	0.85	0.83	0.84	0.84	0.85	0.81
	0.6	0.54	0.68	0.73	0.72	0.77	0.75	0.74	0.68
	0.8	0.42	0.56	0.63	0.57	0.71	0.66	0.64	0.56
	1.0	0.34	0.46	0.54	0.54	0.66	0.59	0.56	0.47
	1.2	0.29	0.38	0.46	0.48	0.62	0.54	0.49	0.41
	1.4	0.25	0.32	0.40	0.43	0.60	0.50	0.44	0.35
	1.6	0.23	0.29	0.35	0.40	0.57	0.46	0.39	0.31
	1.8	0.21	0.26	0.32	0.37	0.56	0.42	0.36	0.28
	2.0	0.20	0.24	0.29	0.34	0.54	0.39	0.32	0.25

Deemed-to-Satisfy Provisions

Table J2.4d COOLING SHADING MULTIPLIER (S_C)— continued

G (refer Figure J2.4)	P/H (refer Figure J2.4)	Orientation Sector (refer Figure J2.3)							
		North	North east	East	South east	South	South west	West	North west
More than 500 mm but not more than 1200 mm	0.0	1.00	1.00	1.00	1.00	1.00	1.00	1.00	1.00
	0.2	0.97	0.98	0.98	0.98	0.96	0.98	0.98	0.98
	0.4	0.89	0.93	0.94	0.93	0.91	0.93	0.94	0.92
	0.6	0.74	0.85	0.88	0.86	0.86	0.86	0.87	0.84
	0.8	0.59	0.76	0.81	0.79	0.81	0.80	0.80	0.74
	1.0	0.49	0.66	0.73	0.72	0.77	0.73	0.72	0.66
	1.2	0.41	0.58	0.66	0.65	0.73	0.68	0.66	0.58
	1.4	0.35	0.51	0.59	0.59	0.69	0.63	0.60	0.51
	1.6	0.31	0.44	0.53	0.54	0.66	0.59	0.55	0.46
	1.8	0.28	0.39	0.48	0.50	0.64	0.55	0.50	0.41
2.0	0.25	0.35	0.43	0.46	0.61	0.51	0.45	0.37	
More than 1200 mm but less than 1800 mm	0.0	1.00	1.00	1.00	1.00	1.00	1.00	1.00	1.00
	0.2	0.98	0.99	0.99	0.99	0.98	0.99	0.99	0.99
	0.4	0.94	0.96	0.97	0.96	0.94	0.96	0.96	0.95
	0.6	0.86	0.92	0.93	0.92	0.90	0.91	0.92	0.90
	0.8	0.73	0.85	0.88	0.86	0.86	0.86	0.87	0.83
	1.0	0.59	0.87	0.83	0.80	0.82	0.81	0.81	0.76
	1.2	0.51	0.70	0.76	0.75	0.79	0.76	0.75	0.69
	1.4	0.44	0.63	0.71	0.70	0.76	0.71	0.70	0.62
	1.6	0.38	0.57	0.65	0.64	0.73	0.67	0.64	0.56
	1.8	0.34	0.52	0.60	0.60	0.70	0.63	0.60	0.51
2.0	0.30	0.46	0.55	0.56	0.67	0.60	0.55	0.46	

Deemed-to-Satisfy Provisions

Table J2.4d COOLING SHADING MULTIPLIER (S_C)— continued

G (refer Figure J2.4)	P/H (refer Figure J2.4)	Orientation Sector (refer Figure J2.3)							
		North	North east	East	South east	South	South west	West	North west
CLIMATE ZONES 4 AND 5									
Not more than 100 mm	0.0	1.00	1.00	1.00	1.00	1.00	1.00	1.00	1.00
	0.2	0.81	0.85	0.87	0.86	0.90	0.88	0.87	0.84
	0.4	0.61	0.68	0.72	0.72	0.81	0.75	0.72	0.67
	0.6	0.46	0.54	0.59	0.61	0.74	0.64	0.60	0.53
	0.8	0.35	0.42	0.49	0.53	0.68	0.57	0.51	0.42
	1.0	0.28	0.34	0.42	0.47	0.64	0.50	0.44	0.34
	1.2	0.24	0.29	0.37	0.43	0.62	0.46	0.38	0.29
	1.4	0.22	0.26	0.33	0.39	0.59	0.42	0.34	0.26
	1.6	0.20	0.23	0.30	0.36	0.57	0.39	0.31	0.24
	1.8	0.20	0.21	0.27	0.34	0.56	0.37	0.29	0.22
	2.0	0.19	0.20	0.25	0.32	0.54	0.34	0.26	0.21
More than 100 mm but not more than 500 mm	0.0	1.00	1.00	1.00	1.00	1.00	1.00	1.00	1.00
	0.2	0.93	0.95	0.96	0.95	0.96	0.95	0.95	0.95
	0.4	0.77	0.83	0.86	0.85	0.89	0.86	0.85	0.82
	0.6	0.62	0.70	0.74	0.74	0.82	0.77	0.74	0.68
	0.8	0.48	0.58	0.64	0.60	0.76	0.68	0.64	0.56
	1.0	0.37	0.48	0.55	0.58	0.72	0.61	0.56	0.46
	1.2	0.32	0.40	0.48	0.52	0.68	0.56	0.50	0.39
	1.4	0.28	0.35	0.43	0.48	0.66	0.52	0.44	0.34
	1.6	0.25	0.30	0.39	0.45	0.64	0.48	0.40	0.30
	1.8	0.23	0.27	0.35	0.42	0.62	0.45	0.37	0.27
	2.0	0.21	0.25	0.32	0.39	0.60	0.42	0.34	0.25

Deemed-to-Satisfy Provisions

Table J2.4d COOLING SHADING MULTIPLIER (S_C)— continued

G (refer Figure J2.4)	P/H (refer Figure J2.4)	Orientation Sector (refer Figure J2.3)							
		North	North east	East	South east	South	South west	West	North west
More than 500 mm but not more than 1200 mm	0.0	1.00	1.00	1.00	1.00	1.00	1.00	1.00	1.00
	0.2	0.97	0.98	0.98	0.98	0.98	0.98	0.98	0.98
	0.4	0.90	0.94	0.94	0.94	0.95	0.94	0.94	0.93
	0.6	0.81	0.86	0.88	0.87	0.91	0.88	0.88	0.85
	0.8	0.70	0.77	0.81	0.81	0.87	0.81	0.80	0.75
	1.0	0.58	0.68	0.74	0.74	0.82	0.76	0.73	0.66
	1.2	0.47	0.60	0.67	0.68	0.79	0.70	0.66	0.58
	1.4	0.40	0.52	0.61	0.62	0.75	0.65	0.60	0.50
	1.6	0.35	0.46	0.55	0.58	0.73	0.61	0.55	0.44
	1.8	0.31	0.41	0.50	0.54	0.70	0.57	0.50	0.39
2.0	0.27	0.36	0.45	0.50	0.68	0.54	0.46	0.35	
More than 1200 mm but less than 1800 mm	0.0	1.00	1.00	1.00	1.00	1.00	1.00	1.00	1.00
	0.2	0.98	0.99	0.99	0.99	0.99	0.99	0.99	0.99
	0.4	0.94	0.97	0.97	0.96	0.97	0.96	0.97	0.96
	0.6	0.88	0.92	0.93	0.93	0.94	0.92	0.93	0.91
	0.8	0.82	0.87	0.88	0.88	0.91	0.88	0.88	0.85
	1.0	0.72	0.80	0.83	0.82	0.88	0.83	0.82	0.77
	1.2	0.63	0.72	0.77	0.77	0.85	0.78	0.76	0.70
	1.4	0.53	0.65	0.72	0.73	0.82	0.74	0.71	0.63
	1.6	0.45	0.59	0.67	0.67	0.79	0.70	0.66	0.56
	1.8	0.40	0.53	0.62	0.63	0.77	0.66	0.61	0.50
2.0	0.36	0.48	0.57	0.59	0.74	0.62	0.56	0.45	

Deemed-to-Satisfy Provisions

Table J2.4d COOLING SHADING MULTIPLIER (S_C)— continued

G (refer Figure J2.4)	P/H (refer Figure J2.4)	Orientation Sector (refer Figure J2.3)							
		North	North east	East	South east	South	South west	West	North west
CLIMATE ZONES 6 AND 7									
Not more than 100 mm	0.0	1.00	1.00	1.00	1.00	1.00	1.00	1.00	1.00
	0.2	0.82	0.86	0.87	0.87	0.90	0.88	0.87	0.84
	0.4	0.63	0.69	0.72	0.74	0.80	0.74	0.72	0.67
	0.6	0.49	0.56	0.60	0.64	0.73	0.64	0.61	0.54
	0.8	0.40	0.46	0.51	0.56	0.68	0.57	0.52	0.44
	1.0	0.35	0.38	0.44	0.51	0.64	0.51	0.45	0.38
	1.2	0.32	0.34	0.39	0.48	0.61	0.47	0.41	0.35
	1.4	0.31	0.32	0.36	0.45	0.59	0.44	0.37	0.32
	1.6	0.30	0.30	0.33	0.42	0.57	0.42	0.34	0.31
	1.8	0.30	0.29	0.31	0.41	0.56	0.40	0.32	0.30
	2.0	0.30	0.28	0.29	0.39	0.55	0.38	0.31	0.29
More than 100 mm but not more than 500 mm	0.0	1.00	1.00	1.00	1.00	1.00	1.00	1.00	1.00
	0.2	0.93	0.95	0.95	0.95	0.95	0.95	0.95	0.95
	0.4	0.79	0.84	0.86	0.86	0.88	0.86	0.85	0.82
	0.6	0.64	0.71	0.75	0.76	0.81	0.76	0.74	0.68
	0.8	0.52	0.60	0.65	0.63	0.75	0.68	0.65	0.57
	1.0	0.43	0.51	0.57	0.61	0.71	0.61	0.57	0.48
	1.2	0.38	0.44	0.50	0.56	0.68	0.56	0.50	0.42
	1.4	0.35	0.39	0.45	0.52	0.65	0.52	0.46	0.38
	1.6	0.33	0.35	0.41	0.49	0.63	0.49	0.42	0.35
	1.8	0.32	0.33	0.38	0.47	0.62	0.46	0.39	0.33
	2.0	0.31	0.31	0.36	0.45	0.60	0.44	0.36	0.32

Deemed-to-Satisfy Provisions

Table J2.4d COOLING SHADING MULTIPLIER (S_c)— continued

G (refer Figure J2.4)	P/H (refer Figure J2.4)	Orientation Sector (refer Figure J2.3)							
		North	North east	East	South east	South	South west	West	North west
More than 500 mm but not more than 1200 mm	0.0	1.00	1.00	1.00	1.00	1.00	1.00	1.00	1.00
	0.2	0.97	0.98	0.98	0.98	0.98	0.98	0.98	0.98
	0.4	0.91	0.94	0.94	0.94	0.94	0.94	0.94	0.93
	0.6	0.82	0.87	0.88	0.88	0.90	0.88	0.87	0.85
	0.8	0.72	0.79	0.81	0.82	0.85	0.81	0.80	0.75
	1.0	0.62	0.70	0.74	0.76	0.81	0.75	0.73	0.66
	1.2	0.53	0.62	0.67	0.70	0.77	0.70	0.67	0.58
	1.4	0.47	0.55	0.62	0.65	0.74	0.65	0.61	0.51
	1.6	0.42	0.49	0.56	0.61	0.72	0.61	0.56	0.46
	1.8	0.38	0.44	0.51	0.57	0.69	0.57	0.51	0.42
More than 1200 mm but less than 1800 mm	0.0	1.00	1.00	1.00	1.00	1.00	1.00	1.00	1.00
	0.2	0.99	0.99	0.99	0.99	0.99	0.99	0.99	0.99
	0.4	0.95	0.97	0.97	0.96	0.97	0.96	0.97	0.96
	0.6	0.89	0.93	0.93	0.93	0.94	0.92	0.93	0.91
	0.8	0.82	0.87	0.88	0.88	0.90	0.88	0.87	0.85
	1.0	0.75	0.81	0.83	0.83	0.87	0.83	0.82	0.78
	1.2	0.67	0.74	0.78	0.79	0.83	0.78	0.76	0.70
	1.4	0.59	0.68	0.72	0.74	0.80	0.74	0.71	0.63
	1.6	0.52	0.61	0.67	0.70	0.77	0.70	0.66	0.57
	1.8	0.47	0.56	0.63	0.66	0.75	0.66	0.61	0.52
2.0	0.43	0.51	0.58	0.62	0.73	0.63	0.57	0.47	

Deemed-to-Satisfy Provisions

Table J2.4d COOLING SHADING MULTIPLIER (S_c)— continued

G (refer Figure J2.4)	P/H (refer Figure J2.4)	Orientation Sector (refer Figure J2.3)							
		North	North east	East	South east	South	South west	West	North west
CLIMATE ZONE 8									
Not more than 100 mm	0.0	1.00	1.00	1.00	1.00	1.00	1.00	1.00	1.00
	0.2	0.78	0.83	0.86	0.85	0.87	0.86	0.86	0.83
	0.4	0.58	0.65	0.70	0.71	0.75	0.73	0.71	0.65
	0.6	0.47	0.52	0.58	0.61	0.67	0.63	0.60	0.53
	0.8	0.43	0.44	0.49	0.54	0.62	0.56	0.52	0.45
	1.0	0.42	0.40	0.44	0.50	0.59	0.51	0.47	0.41
	1.2	0.41	0.39	0.41	0.48	0.57	0.48	0.43	0.39
	1.4	0.41	0.38	0.39	0.46	0.56	0.46	0.40	0.38
	1.6	0.40	0.37	0.37	0.45	0.55	0.45	0.39	0.37
	1.8	0.40	0.37	0.36	0.44	0.54	0.44	0.38	0.37
	2.0	0.40	0.36	0.36	0.43	0.53	0.44	0.37	0.37
More than 100 mm but not more than 500 mm	0.0	1.00	1.00	1.00	1.00	1.00	1.00	1.00	1.00
	0.2	0.91	0.94	0.95	0.94	0.94	0.95	0.95	0.94
	0.4	0.74	0.81	0.84	0.83	0.85	0.84	0.85	0.80
	0.6	0.58	0.66	0.73	0.73	0.77	0.75	0.74	0.67
	0.8	0.48	0.55	0.62	0.60	0.70	0.66	0.65	0.56
	1.0	0.44	0.47	0.54	0.58	0.65	0.60	0.57	0.48
	1.2	0.43	0.42	0.49	0.54	0.62	0.55	0.51	0.44
	1.4	0.42	0.40	0.45	0.51	0.60	0.52	0.47	0.41
	1.6	0.41	0.39	0.42	0.49	0.58	0.49	0.44	0.39
	1.8	0.41	0.38	0.40	0.47	0.57	0.48	0.42	0.38
	2.0	0.41	0.37	0.38	0.46	0.56	0.46	0.40	0.38

Deemed-to-Satisfy Provisions

Table J2.4d COOLING SHADING MULTIPLIER (S_c)— continued

G (refer Figure J2.4)	P/H (refer Figure J2.4)	Orientation Sector (refer Figure J2.3)							
		North	North east	East	South east	South	South west	West	North west
More than 500 mm but not more than 1200 mm	0.0	1.00	1.00	1.00	1.00	1.00	1.00	1.00	1.00
	0.2	0.97	0.98	0.98	0.98	0.97	0.98	0.98	0.97
	0.4	0.88	0.93	0.94	0.93	0.93	0.93	0.93	0.92
	0.6	0.78	0.84	0.87	0.86	0.87	0.86	0.87	0.83
	0.8	0.66	0.74	0.79	0.79	0.81	0.80	0.80	0.74
	1.0	0.56	0.64	0.71	0.72	0.75	0.73	0.73	0.64
	1.2	0.49	0.56	0.65	0.66	0.71	0.68	0.66	0.57
	1.4	0.46	0.50	0.59	0.61	0.68	0.64	0.61	0.51
	1.6	0.44	0.45	0.54	0.57	0.66	0.60	0.56	0.47
	1.8	0.43	0.42	0.49	0.54	0.63	0.57	0.52	0.44
2.0	0.42	0.40	0.46	0.52	0.61	0.53	0.49	0.42	
More than 1200 mm but less than 1800 mm	0.0	1.00	1.00	1.00	1.00	1.00	1.00	1.00	1.00
	0.2	0.98	0.99	0.99	0.99	0.99	0.99	0.99	0.99
	0.4	0.93	0.96	0.96	0.96	0.95	0.96	0.96	0.95
	0.6	0.86	0.91	0.93	0.91	0.91	0.91	0.92	0.90
	0.8	0.78	0.84	0.87	0.86	0.87	0.86	0.87	0.83
	1.0	0.69	0.77	0.82	0.80	0.82	0.81	0.81	0.76
	1.2	0.60	0.69	0.75	0.75	0.78	0.76	0.76	0.68
	1.4	0.54	0.62	0.69	0.70	0.74	0.72	0.70	0.62
	1.6	0.49	0.55	0.65	0.65	0.71	0.68	0.66	0.56
	1.8	0.47	0.50	0.60	0.62	0.69	0.64	0.61	0.52
2.0	0.45	0.46	0.55	0.58	0.67	0.61	0.57	0.48	

Notes:

- Where G is 1800 mm or more, the cooling shading multiplier is to be taken as 1.0.
- The cooling shading multiplier for P/H values between those shown in **Table J2.4d** can be interpolated.
- For *glazing* in the internal *fabric* use the appropriate value for the south orientation sector with a P/H value of 2.0.

Deemed-to-Satisfy Provisions

Figure J2.3

ORIENTATION SECTORS

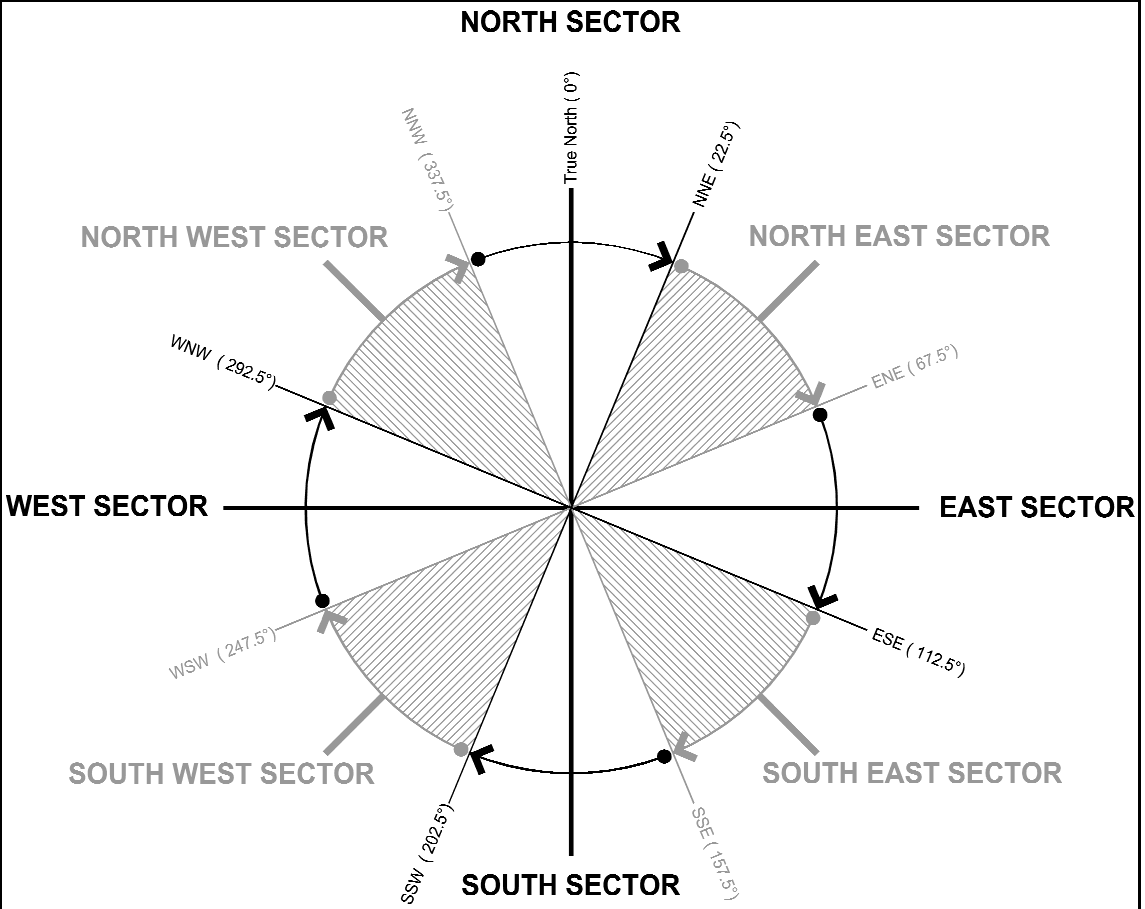

Note:

A building wall or a *glazing* element faces a particular orientation sector of Figure J2.3 if it faces any direction in that orientation sector.

Deemed-to-Satisfy Provisions

Figure J2.4

METHOD OF MEASURING P AND H

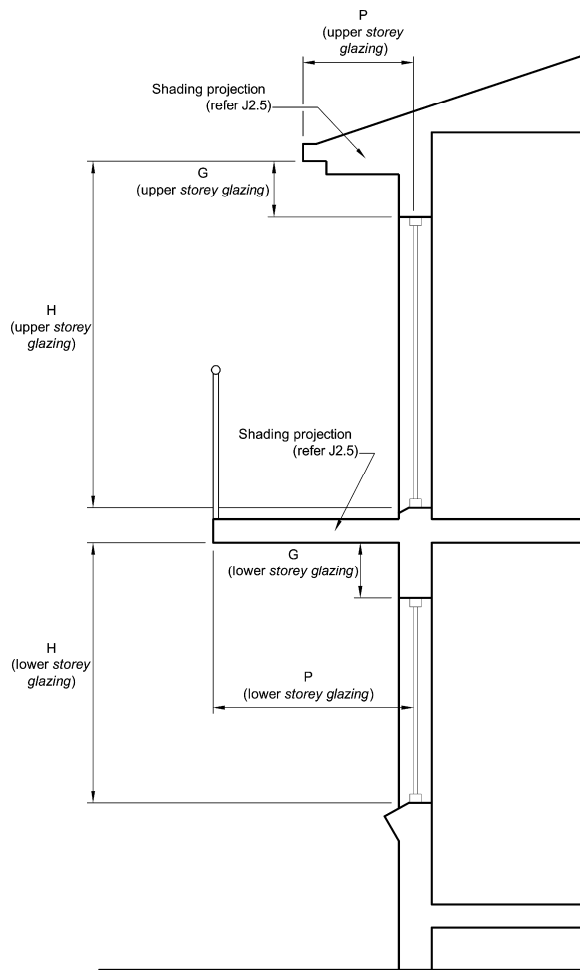

Notes:

1. An external shading device that complies with **J2.5(b)** is considered to achieve a P/H value of 2.
2. For Glazing - Method 1, where G exceeds 500mm, the value of P must be halved.

J2.5 Shading

Where shading is *required* to comply with **J2.3** or **J2.4**, it must—

- (a) be provided by an external permanent projection, such as a verandah, balcony, fixed canopy, eaves or shading hood, which—
 - (i) extends horizontally on both sides of the *glazing* for the same projection distance P in **Figure J2.4**; or
 - (ii) provides the equivalent shading to (i) with a reveal or the like; or

Deemed-to-Satisfy Provisions

- (b) be provided by an external shading device, such as a shutter, blind, vertical or horizontal building screen with blades, battens or slats, which—
 - (i) is capable of restricting at least 80% of summer solar radiation; and
 - (ii) if adjustable-
 - (A) in a Class 2 or 4 building, is readily operated either manually, mechanically or electronically by the building occupants; or
 - (B) in a Class 3, 5, 6, 7, 8 or 9 building, is operated automatically in response to the level of solar radiation.

PART J3 BUILDING SEALING

Deemed-to-Satisfy Provisions

J3.0 Deemed-to-Satisfy Provisions

VIC J3.0

- (a) Where a *Building Solution* is proposed to comply with the *Deemed-to-Satisfy Provisions*, *Performance Requirement JP1* is satisfied by complying with—
- (i) **J1.1** to **J1.6**; and
 - (ii) **J2.1** to **J2.5**; and
 - (iii) **J3.1** to **J3.7**; and
 - (iv) **J4.1** to **J4.4**; and
 - (v) **J5.1** to **J5.5**; and
 - (vi) **J6.1** to **J6.6**; and
 - (vii) **J7.1** to **J7.2**.
- (b) Where a *Building Solution* is proposed as an *Alternative Solution* to the *Deemed-to-Satisfy Provisions* of—
- (i) **J1.1** to **J1.6**; and
 - (ii) **J2.1** to **J2.5**; and
 - (iii) **J3.1** to **J3.7**; and
 - (iv) **J4.1** to **J4.4**; and
 - (v) **J5.1** to **J5.5**; and
 - (vi) **J6.1** to **J6.6**; and
 - (vii) **J7.1** to **J7.2**,

the relevant *Performance Requirements* must be determined in accordance with **A0.10**.

J3.1 Application of Part

SA J3.1

VIC J3.1

The *Deemed-to-Satisfy Provisions* of this Part apply to elements forming the *envelope* of a Class 2 to 9 building, other than—

- (a) a building in *climate zones* 1, 2, 3 and 5 where the only means of *air-conditioning* is by using an evaporative cooler; or
- (b) a permanent building *ventilation opening*, in a space where a gas appliance is located, that is necessary for the safe operation of a gas appliance; or
- (c) a Class 6, 7, 8 and 9b building that does not have a *conditioned space*; or
- (d) a building or space where the mechanical ventilation *required* by **Part F4** provides sufficient pressurisation to prevent infiltration; or

Deemed-to-Satisfy Provisions

- (e) an atrium or solarium that is not a *conditioned space* and is separated from the remainder of the building by an *envelope*.

NSW J3.1(f)

J3.2 Chimneys and flues

The chimney or flue of an open solid-fuel burning appliance must be provided with a damper or flap that can be closed to seal the chimney or flue.

J3.3 Roof lights

SA J3.3(a)

- (a) A *roof light* must be sealed, or capable of being sealed when serving—
- (i) a *conditioned space*; or
 - (ii) a *habitable room* in *climate zones* 4, 6, 7 and 8.
- (b) A *roof light required* by (a) must be constructed with—
- (i) an imperforate ceiling diffuser or the like installed at the ceiling or internal lining level; or
 - (ii) a weatherproof seal if it is a roof *window*; or
 - (iii) a shutter system readily operated either manually, mechanically or electronically by the occupant.

J3.4 Windows and doors

SA J3.4

- (a) A seal to restrict air infiltration must be fitted to each edge of a door, openable *window* or the like forming part of—
- (i) the *envelope* of a *conditioned space*; or
 - (ii) the external fabric of a *habitable room* or public area in *climate zones* 4, 6, 7 and 8.
- (b) The requirements of (a) do not apply to—
- (i) a *window* complying with AS 2047; or
 - (ii) a louvre door, louvre *window*, or other such opening; or
 - (iii) a fire door or smoke door; or
 - (iv) a roller shutter door, roller shutter grille or other security door or device installed only for out-of-hours security.
- (c) A seal *required* by (a) may be a foam or rubber compressible strip, fibrous seal or the like.
- (d) A main entrance to a building, if leading to a *conditioned space* must have an airlock, *self-closing* door, revolving door or the like, other than—
- (i) where the *conditioned space* has a *floor area* of not more than 50 m²; or
 - (ii) where a café, restaurant, open front shop or the like has—

Deemed-to-Satisfy Provisions

- (A) a 3 m deep un-conditioned zone between the main entrance, including an open front, and the *conditioned space*; and
- (B) at all other entrances to the café, restaurant, open front shop or the like, *self-closing* doors.

J3.5 Exhaust fans

SA J3.5

A miscellaneous exhaust fan, such as a bathroom or domestic kitchen exhaust fan, must be fitted with a sealing device such as a self-closing damper or the like when serving—

- (a) a *conditioned space*; or
- (b) a *habitable room* in *climate zones* 4, 6, 7 and 8.

J3.6 Construction of roofs, walls and floors

SA J3.6(a)

- (a) Roofs, ceilings, walls, floors and any opening such as a *window*, door or the like must be constructed to minimise air leakage in accordance with **(b)** when forming part of—
 - (i) the *envelope*; or
 - (ii) the external *fabric* of a *habitable room* or a public area in *climate zones* 4, 6, 7 and 8.
- (b) Construction *required* by **(a)** must be—
 - (i) enclosed by internal lining systems that are close fitting at ceiling, wall and floor junctions; or
 - (ii) sealed by caulking, skirting, architraves, cornices or the like.
- (c) The requirements of **(a)** do not apply to openings, grilles and the like *required* for smoke hazard management.

J3.7 Evaporative coolers

SA J3.7

An evaporative cooler must be fitted with a self-closing damper or the like when serving—

- (a) a heated space; or
- (b) a *habitable room* or a public area of a building in *climate zones* 4, 6, 7 and 8.

PART J4 AIR MOVEMENT

Deemed-to-Satisfy Provisions

J4.0 Deemed-to-Satisfy Provisions

VIC J4.0

- (a) Where a *Building Solution* is proposed to comply with the *Deemed-to-Satisfy Provisions*, *Performance Requirement JP1* is satisfied by complying with—
- (i) **J1.1** to **J1.6**; and
 - (ii) **J2.1** to **J2.5**; and
 - (iii) **J3.1** to **J3.7**; and
 - (iv) **J4.1** to **J4.4**; and
 - (v) **J5.1** to **J5.5**; and
 - (vi) **J6.1** to **J6.6**; and
 - (vii) **J7.1** to **J7.2**,
- (b) Where a *Building Solution* is proposed as an *Alternative Solution* to the *Deemed-to-Satisfy Provisions* of—
- (i) **J1.1** to **J1.6**; and
 - (ii) **J2.1** to **J2.5**; and
 - (iii) **J3.1** to **J3.7**; and
 - (iv) **J4.1** to **J4.4**; and
 - (v) **J5.1** to **J5.5**; and
 - (vi) **J6.1** to **J6.6**; and
 - (vii) **J7.1** to **J7.2**,

the relevant *Performance Requirements* must be determined in accordance with **A0.10**.

J4.1 Application of Part

VIC J4.1

The *Deemed-to-Satisfy Provisions* of this Part apply to a *habitable room* in a *sole-occupancy unit* of a Class 2 building or a Class 4 part of a building.

J4.2 Air movement

- (a) Air movement must be provided in accordance with **Table J4.2**.
- (b) Air movement *required* by (a) may be provided through an opening from an adjoining room (including an enclosed verandah) if both rooms are within the same *sole-occupancy unit* and—
- (i) the adjoining room is not a *sanitary compartment*; and

Deemed-to-Satisfy Provisions

- (ii) the opening between the adjoining room and the *habitable room* complies with **Table J4.2** as if it were a *ventilation opening* to the *habitable room*, or a proportion thereof, if some ventilation is provided from another source; and
 - (iii) the *ventilation opening* to the adjoining room complies with **Table J4.2** for the total area of the floor of the adjoining room and the proportion of the *habitable room* that is ventilated from the adjoining room.
- (c) The requirements of (a) do not apply to buildings in Region D severe tropical cyclone areas in AS/NZS 1170.2 provided—
- (i) the *external walls* are shaded with a verandah, balcony, eaves, carport or the like that projects at a minimum angle of 15 degrees in accordance with **Figure J1.5**; and
 - (ii) the *external walls* achieve a minimum *Total R-Value* of 2.5; and
 - (iii) the roof achieves an additional R1.5 to that *required* by **J1.3**.

Table J4.2 PROVISION FOR AIR MOVEMENT

<i>Climate zones</i>	Minimum total <i>ventilation opening</i> area per room (percentage of the area of the room's floor (see Note 1))		
	Without a ceiling fan or evaporative cooler	With a ceiling fan	With an evaporative cooler
1	15%	12.5%	15% (see Note 2)
2	10%	5%	10% (see Note 2)
3	12.5%	7.5%	7.5%
4	10%	5%	5%
5	7.5%	5%	7.5% (see Note 2)
6, 7 and 8	As <i>required</i> by Part F4		
Notes:			
1. To account for the progressive increase in wind velocity with height, the minimum total <i>ventilation opening</i> area may be reduced by a factor of 0.1 for every 10 m in height that a building exceeds a height of 10 m above ground level, until the minimum area <i>required</i> by F4.6 is reached.			
2. Because evaporative coolers are less effective than ceiling fans in more humid locations, the minimum total <i>ventilation opening</i> area <i>required</i> in <i>climate zones</i> 1, 2 and 5 with an evaporative cooler is the same as without one.			

J4.3 Ventilation openings

- (a) For a room without a ceiling fan or evaporative cooler, the total *ventilation opening* area *required* by **Table J4.2** for *climate zones* 1, 2, 3, 4 and 5 must—
- (i) be connected by a breeze path complying with (b) to another *ventilation opening* in another room or space; or
 - (ii) be provided by a minimum of two *ventilation openings* located within the same room, with each *ventilation opening* having an area of not less than 25% of the area *required* by **Table J4.2**.

Deemed-to-Satisfy Provisions

- (b) A breeze path *required* by **(a)(i)** must—
- (i) pass through not more than two openings in the internal walls with each opening having an area of not less than 1.5 m²; and
 - (ii) have a distance along the breeze path between *ventilation openings* of not more than 20 m.

J4.4 Ceiling fans and evaporative coolers

Where *required*, a ceiling fan or evaporative cooler must—

- (a) be permanently fixed; and
- (b) have a speed controller; and
- (c) for a ceiling fan, have a blade rotation diameter of not less than 900 mm.

PART J5

AIR-CONDITIONING AND VENTILATION
SYSTEMS

Deemed-to-Satisfy Provisions

J5.0 Deemed-to-Satisfy Provisions

VIC J5.0

- (a) Where a *Building Solution* is proposed to comply with the *Deemed-to-Satisfy Provisions*, *Performance Requirement JP1* is satisfied by complying with—
- (i) **J1.1** to **J1.6**; and
 - (ii) **J2.1** to **J2.5**; and
 - (iii) **J3.1** to **J3.7**; and
 - (iv) **J4.1** to **J4.4**; and
 - (v) **J5.1** to **J5.5**; and
 - (vi) **J6.1** to **J6.6**; and
 - (vii) **J7.1** to **J7.2**,
- (b) Where a *Building Solution* is proposed as an *Alternative Solution* to the *Deemed-to-Satisfy Provisions* of—
- (i) **J1.1** to **J1.6**; and
 - (ii) **J2.1** to **J2.5**; and
 - (iii) **J3.1** to **J3.7**; and
 - (iv) **J4.1** to **J4.4**; and
 - (v) **J5.1** to **J5.5**; and
 - (vi) **J6.1** to **J6.6**; and
 - (vii) **J7.1** to **J7.2**,
- the relevant *Performance Requirements* must be determined in accordance with **A0.10**.

J5.1 * * * * *

This clause has deliberately been left blank.

J5.2 Air-conditioning and ventilation systems

- (a) An *air-conditioning* unit or system must—
- (i) be capable of—
 - (A) being inactivated when the *sole-occupancy unit*, building or part of the building served is not occupied; and
 - (B) where the *air-conditioning* unit or system has motorised outside air and return dampers, close the dampers when the *air-conditioning* unit or system is inactivated.

Deemed-to-Satisfy Provisions

- (ii) have any supply and return ductwork insulated and sealed in accordance with **Specification J5.2**; and
- (iii) when serving more than one *sole-occupancy unit*, *air-conditioning* zone or area with different heating and cooling needs—
 - (A) thermostatically control the temperature of each *sole-occupancy unit*, zone or area; and
 - (B) not control the temperature by mixing actively heated air and actively cooled air; and
 - (C) limit reheating to not more than a 7.5 K rise in temperature at the supply air rate for the space served and may be increased or decreased at the same rate that the supply air rate is respectively decreased or increased; and
- (iv) in other than a Class 6 restaurant, bar or café or Class 9b building, have an *outdoor air economy cycle*—
 - (A) in *climate zone* 3, when the *air-conditioning* unit capacity is over 65 kW_r; and
 - (B) in *climate zones* 4, 5, 6, 7 and 8 when the *air-conditioning* unit capacity is over 50 kW_r; and
- (v) in a Class 3 building, be capable of controlling the temperature of a *sole-occupancy unit* at a different temperature during sleeping periods than during other periods; and
- (vi) when the air flow rate is greater than 1000 L/s, be designed so that the total *motor shaft power* of the fans in the system is in accordance with **Table J5.2a**; and

Table J5.2a FAN MAXIMUM TOTAL MOTOR SHAFT POWER

Internal load for equipment and people (W/m ² of the <i>floor area</i> of the <i>conditioned space</i>)	Fan maximum total <i>motor shaft power</i>	
	For a building of not more than 500 m ² <i>floor area</i> (W/m ² of the <i>conditioned space</i>)	For a building of more than 500 m ² <i>floor area</i> (W/m ² of the <i>conditioned space</i>)
Up to 100	9	12
101 to 150	12	15
151 to 200	14	18
201 to 300	19	25
301 to 400	23	31
Notes	For more than 400 W/m ² internal load— <ul style="list-style-type: none"> (a) in a building of not more than 500 m² <i>floor area</i>, use 0.07 W of <i>motor shaft power</i> for each Watt of internal load; and (b) in a building of more than 500 m² <i>floor area</i>, use 0.09 W of <i>motor shaft power</i> for each Watt of internal load. 	

- (vii) the requirements of **(vi)** do not apply to—
 - (A) the input power for an energy reclaiming system that preconditions outdoor air; and

Deemed-to-Satisfy Provisions

- (B) the input power for process related components such as high efficiency particulate air filters.
- (b) A mechanical ventilation system must—
- (i) in other than a *sole-occupancy unit* in a Class 2 building or a Class 4 part of a building, be capable of being inactivated when the building or part of the building served by that system is not occupied; and
 - (ii) when serving a *conditioned space*, not provide mechanical ventilation in excess of the minimum quantity *required* by **Part F4** by more than 50% other than where there is—
 - (A) additional unconditioned outside air supplied—
 - (aa) to provide free cooling; or
 - (bb) to balance *required* exhaust ventilation such as toilet exhaust; or
 - (cc) to balance process exhaust such as from a *health-care building* or laboratory; or
 - (B) additional exhaust ventilation needed to balance the *required* mechanical ventilation; or
 - (C) an energy reclaiming system that preconditions outside air; and
 - (iii) when the air flow rate is more than 1000 L/s,
 - (A) have a fan *motor shaft power* to air flow rate ratio, or fan *motor input power* to air flow rate ratio, in accordance with **Table J5.2b**; and
 - (B) in other than *climate zone 2*, when serving a *conditioned space* in a Class 9b building where the number of square metres per person is 1 or less as specified in **D1.13**, have—
 - (aa) an energy reclaiming system that preconditions outside air; or
 - (bb) the ability to automatically modulate the mechanical ventilation *required* by **Part F4** in proportion to the number of occupants.

Table J5.2b MAXIMUM FAN MOTOR POWER TO AIR FLOW RATE RATIO

System static pressure (Pa)	Maximum fan <i>motor shaft power</i> to air flow rate ratio W/(L/s)	Maximum fan <i>motor input power</i> to air flow rate ratio W/(L/s)
Up to 200	0.55	0.73
300	0.75	1.0
400	0.95	1.27
500	1.15	1.5
600	1.4	1.9
700	1.6	2.1
800	1.8	2.4
900	2.0	2.7
1000	2.2	2.9

Deemed-to-Satisfy Provisions

Table J5.2b MAXIMUM FAN MOTOR POWER TO AIR FLOW RATE RATIO— *continued*

System static pressure (Pa)	Maximum fan <i>motor shaft power</i> to air flow rate ratio W/(L/s)	Maximum fan <i>motor input power</i> to air flow rate ratio W/(L/s)
Greater than 1000	2.5	3.3

Notes:

1. The maximum fan motor power to air flow rate ratio may be increased to that for the next higher system resistance where a fixed pitch and fixed speed fan is used.
2. The system static pressure includes all the resistance against which the fan must operate including integrated fan cowls, flaps and grilles.

- (iv) when serving over 40 vehicles in a *carpark*—
 - (A) be controlled by an atmospheric contaminant monitoring system in accordance with AS 1668.2; and
 - (B) maintain an average minimum air-change rate of 0.5 air changes per hour other than when the *carpark* is not occupied for a period of more than 2 hours.
- (c) The requirements of (a) and (b) must not inhibit—
 - (i) the smoke hazard management operation of *air-conditioning* and mechanical ventilation systems; and
 - (ii) essential ventilation such as for a garbage room, lift motor room, gas meter enclosure or gas regulator enclosure or the like.

J5.3 Time switch

- (a) A time switch in accordance with **Specification J6** must be provided to control each of the following:
 - (i) An *air-conditioning* system of more than 10 kW_r.
 - (ii) A ventilation system with an air flow rate of more than 1000 L/s.
 - (iii) A heating system of more than 10 kW_{heating}.
- (b) The requirements of (a) do not apply to—
 - (i) an *air-conditioning* system or ventilation system that serves only one *sole-occupancy unit* of—
 - (A) a Class 2 or 3 building; or
 - (B) a Class 4 part of a building; or
 - (C) a Class 9c *aged care building*; or
 - (ii) a building where *air-conditioning* or ventilation is needed for 24 hour occupancy such as a manufacturing process or emergency services.

J5.4 Heating and chilling systems

- (a) Systems that provide heating or chilling for *air-conditioning* systems must—

Deemed-to-Satisfy Provisions

- (i) have any *pipng*, vessels, heat exchangers or tanks containing heated or chilled fluid, other than those with insulation levels covered by Minimum Energy Performance Standards (MEPS), insulated in accordance with **Specification J5.4**; and
- (ii) where water is circulated by pumping at greater than 2 L/s—
 - (A) be designed so that the total of the *motor shaft power* to the *air-conditioning* pump is in accordance with **Table J5.4a**; and

Table J5.4a PUMP MAXIMUM MOTOR SHAFT POWER

Internal load for equipment and people (W/m ² of the <i>floor area</i> of the <i>conditioned space</i>)	Pump maximum <i>motor shaft power</i>	
	For a building of not more than 500 m ² <i>floor area</i> (W/m ²) of the <i>floor area</i> of the <i>conditioned space</i>)	For a building of more than 500 m ² <i>floor area</i> (W/m ²) of the <i>floor area</i> of the <i>conditioned space</i>)
Up to 100	2	3
101 to 150	3	4
151 to 200	3	6
201 to 300	5	8
301 to 400	7	11
More than 400	8	14

- (B) have the pump capable of varying its speed when it is—
 - (aa) operating for more than 3,500 hours per year; or
 - (bb) more than 11 kW of *motor shaft power*,
 except where the pump is needed to run at full speed for safe or efficient operation; and
 - (iii) if the system contains more than one water heater used for heating a building, chiller or coil, be capable of stopping the flow of water to those not operating.
- (b) A water heater, such as a boiler, that is part of an *air-conditioning* system, must achieve a thermal efficiency complying with **Table J5.4b** when tested in accordance with BS 7190.

Table J5.4b MINIMUM THERMAL EFFICIENCY OF A WATER HEATER

Fuel type	Rated capacity (kW _{heating})	Minimum gross thermal efficiency (%)
Gas	Less than 90	75
	90 to 750	80
	More than 750	83
Oil	Less than 90	76
	90 to 750	78
	More than 750	80

Deemed-to-Satisfy Provisions

- (c) Package *air-conditioning* equipment with a capacity of not less than 65 kW_r, including a split unit and a heat pump, must have an energy efficiency ratio complying with **Table J5.4c** when tested in accordance with AS/NZS 3823.1.2 at test condition T1.

Table J5.4c MINIMUM ENERGY EFFICIENCY RATIO FOR PACKAGED AIR-CONDITIONING EQUIPMENT

Equipment	Minimum energy efficiency ratio ($W_r/W_{input\ power}$)	
	65 kW _r to 95 kW _r capacity	More than 95 kW _r capacity
Air-conditioner — cooling	2.7	2.8
Heat pump — cooling	2.6	2.7

- (d) A refrigerant chiller over 125 kW_r capacity that is part of an *air-conditioning* system, must have an energy efficiency ratio complying with **Table J5.4d** when determined in accordance with ARI 550/590.

Table J5.4d MINIMUM ENERGY EFFICIENCY RATIO FOR REFRIGERANT CHILLERS

Equipment	Minimum energy efficiency ratio ($W_r/W_{input\ power}$)	
	For full load operation	For integrated part load
Water cooled chiller		
More than 125 kW _r but not more than 525 kW _r	4.2	5.2
More than 525 kW _r but not more than 1000 kW _r	4.5	5.6
More than 1000 kW _r	5.5	6.1
Air cooled or evaporatively cooled chiller		
More than 125 kW _r but not more than 525 kW _r	2.2	3.0
More than 525 kW _r	2.5	3.1

- (e) The fan motor of an air cooled condenser that is part of an *air-conditioning* system, other than one that is part of package *air-conditioning* equipment in (c), must not use more than—
- (i) 42 W of *motor shaft power*; or
 - (ii) 53 W of *motor input power*,
- for each kW of heat rejected from the refrigerant when determined in accordance with ARI 460.
- (f) The fan of a cooling tower that is part of an *air-conditioning* system must not use more than—
- (i) if a propeller or axial fan—
 - (A) 310 W of *motor shaft power* for each L/s of cooling water circulated; or
 - (B) 390 W of *motor input power* for each L/s of cooling water circulated; and

Deemed-to-Satisfy Provisions

- (ii) if a centrifugal fan, 590 W of *motor shaft power* for each L/s of cooling water circulated.
- (g) The fan of a closed circuit cooler that is part of an *air-conditioning* system must not use more than—
 - (i) if a propeller or axial fan—
 - (A) 500 W of *motor shaft power* for each L/s of cooled fluid circulated; or
 - (B) 625 W of *motor input power* for each L/s of cooled fluid circulated; and
 - (ii) if a centrifugal fan—
 - (A) 670 W of *motor shaft power* for each L/s of cooled fluid circulated; or
 - (B) 840 W *motor input power* for each L/s of cooled fluid circulated.
- (h) The fan of a evaporative condenser that is part of an *air-conditioning* system must not use more than—
 - (i) if a propeller or axial fan—
 - (A) 18 W of *motor shaft power* for each kW of heat rejected; or
 - (B) 22 W of *motor input power* for each kW of heat rejected; and
 - (ii) if a centrifugal fan—
 - (A) 22 W of *motor shaft power* for each kW of heat rejected; or
 - (B) 27 W of *motor input power* for each kW of heat rejected.
- (i) The spray water pump of a closed circuit cooler or evaporative condenser that is part of an *air-conditioning* system must not use more than 150 W of pump *motor shaft power* for each L/s of spray water circulated.

J5.5 Miscellaneous exhaust systems

- (a) A miscellaneous exhaust system with an air flow rate of more than 1000 L/s, that is associated with equipment having a variable demand such as a stove in a commercial kitchen or a chemical bath in a factory, must—
 - (i) have the means for the operator to—
 - (A) reduce the energy used, such as by a variable speed fan, and
 - (B) stop the motor when the system is not needed; and
 - (ii) be designed to minimise the exhausting of conditioned air.
- (b) The requirements of (a) do not apply—
 - (i) within a *sole-occupancy unit* of a Class 2 or 3 building, Class 4 part of a building or Class 9c *aged care building*; or
 - (ii) where additional exhaust ventilation is needed to balance the *required* outside air for ventilation; or
 - (iii) where air flow must be maintained for safe operation.

PART J6

ARTIFICIAL LIGHTING AND POWER

Deemed-to-Satisfy Provisions

J6.0 Deemed-to-Satisfy Provisions

VIC J6.0

- (a) Where a *Building Solution* is proposed to comply with the *Deemed-to-Satisfy Provisions*, *Performance Requirement JP1* is satisfied by complying with—
- (i) **J1.1** to **J1.6**; and
 - (ii) **J2.1** to **J2.5**; and
 - (iii) **J3.1** to **J3.7**; and
 - (iv) **J4.1** to **J4.4**; and
 - (v) **J5.1** to **J5.5**; and
 - (vi) **J6.1** to **J6.6**; and
 - (vii) **J7.1** to **J7.2**,
- (b) Where a *Building Solution* is proposed as an *Alternative Solution* to the *Deemed-to-Satisfy Provisions* of—
- (i) **J1.1** to **J1.6**; and
 - (ii) **J2.1** to **J2.5**; and
 - (iii) **J3.1** to **J3.7**; and
 - (iv) **J4.1** to **J4.4**; and
 - (v) **J5.1** to **J5.5**; and
 - (vi) **J6.1** to **J6.6**; and
 - (vii) **J7.1** to **J7.2**,

the relevant *Performance Requirements* must be determined in accordance with **A0.10**.

J6.1 Application of Part

The *Deemed-to-Satisfy Provisions* of this Part do not apply within a *sole-occupancy unit* of a Class 2 building or a Class 4 part of a building.

J6.2 Interior artificial lighting

- (a) In a Class 2, 3 or Class 9c *aged care building*—
- (i) artificial lighting must not exceed the maximum *lamp power density* in **Table J6.2a**, except that in a bathroom, dressing room or the like, an average artificial *light source efficacy* of not less than 40 Lumens/W may be used; and—
 - (ii) the maximum *lamp power density* in **Table J6.2a** may be increased by—
 - (A) 30% for enclosed areas of less than 20 m² *floor area*; and

Deemed-to-Satisfy Provisions

- (B) for other than a *sole-occupancy unit* in a Class 3 building, 40% where artificial lighting is switched by a motion detector or a lighting timer in accordance with **Specification J6**; and
- (C) 15% where artificial lighting is switched, in response to varying natural lighting levels, by a daylight sensor and dynamic lighting control device in accordance with **Specification J6**.

Table J6.2a MAXIMUM LAMP POWER DENSITY

Location	Maximum <i>Lamp power density</i> (W/m ²)
Within a Class 3 and 9c <i>aged care building sole-occupancy unit</i>	10
Within a dormitory of a Class 3 building used only for sleeping	5
Within other areas of a Class 2, 3 or 9c <i>aged care building</i> that are frequently occupied such as a lounge room or a dining room	8
Within public corridors, stairways and the like	7
Service areas such as plant rooms or store rooms	6
Employees' work areas such as reception areas	10

- (b) In a Class 5, 6, 7, 8, 9a or 9b building—
 - (i) for artificial lighting, the aggregate design illumination power load must not exceed the sum of the allowances obtained by multiplying the area of each space by the maximum *illumination power density* in **Table J6.2b**, except where the space is a shop of not more than 100 m² *floor area*, an average artificial *light source efficacy* of not less than 40 Lumens/W may be used; and—
 - (ii) the aggregate design illumination power load in (i) is the sum of the design illumination power loads in each of the spaces served; and
 - (iii) in determining the design illumination power load for (ii) the following must be used:
 - (A) Where there are multiple lighting systems serving the same space—
 - (aa) the total illumination power load of all systems; or
 - (bb) for a control system that permits only one system to operate at a time, the design illumination power load is—
 - (AA) based on the highest illumination power load; or
 - (BB) determined by the formula—

$$[H \times T/2 + P \times (100 - T/2)] / 100$$
 Where:
 - H = the highest illumination power load; and
 - T = the time for which the maximum illumination power load will occur, expressed as a percentage; and
 - P = the predominant illumination power load.

Deemed-to-Satisfy Provisions

- (B) Where there is track lighting—
- (aa) of extra low voltage, 80% of the power rating of the transformer; and
 - (bb) of mains voltage, 100 W per metre of track.
- (c) The requirements of (a) and (b) do not apply to the following:
- (i) Emergency lighting in accordance with Part E4.
 - (ii) Signage and display lighting within cabinets and display cases.
 - (iii) Lighting for accommodation within the residential part of a *detention centre*.
 - (iv) A heater where the heater also emits light.
 - (v) Lighting of a specialist process nature such as in an operating theatre, fume cupboard or clean workstation.
 - (vi) Lighting of performances such as theatrical or sporting.
 - (vii) Lighting for the permanent display and preservation of works of art or objects in a museum or gallery other than for retail sale, purchase or auction.

Table J6.2b MAXIMUM ILLUMINATION POWER DENSITY

Space	Maximum <i>illumination power density</i> (W/m ²)
Auditorium, church and public hall	10
Board room and conference room	8
Carpark - general	6
Carpark - entry zone (first 20 m of travel)	25
Circulation space and corridor	8
Control room, switch room, and the like	10
Courtroom	12
Entry lobby	15
Factory, industrial tasks and processes	17
Farm and rural building - general	7
Farm and rural building - dairy and shearing	15
Health-care - examination room	20
Health-care - patient ward	10
Health-care - children's ward	15
Kitchen and food preparation area	8
Laboratory	15
Library - general	12

Deemed-to-Satisfy Provisions

Table J6.2b MAXIMUM ILLUMINATION POWER DENSITY— continued

Space	Maximum <i>illumination power density</i> (W/m ²)
Library - reading room	10
Museum and gallery - circulation, cleaning and service lighting	8
Office - artificially lit to an ambient level of 200 lx or more	10
Office - artificially lit to an ambient level of less than 200 lx	7
Plant room	5
Public toilet	5
Restaurant, café, bar, hotel lounge and a space for the serving and consumption of food or drinks	20
Retail space including a museum and gallery whose purpose is the sale of objects	25
<i>School</i> - general purpose learning area	10
Storage with shelving no higher than 75% of the height of the aisle lighting	8
Storage with shelving higher than 75% of the height of the aisle lighting	10
Service area, locker room, staff room, cleaner's room, rest room and the like	3
Wholesale storage and display area	10
<p>Notes:</p> <ol style="list-style-type: none"> 1. In areas not listed above, the maximum <i>illumination power density</i> is: <ol style="list-style-type: none"> (a) For an illuminance of less than 160 lx, 13 W/m² (b) For an illuminance of 160 to 600 lx, 16 W/m² (c) For an illuminance of more than 600 lx, 20 W/m² 2. For illuminance levels greater than 600 lx, the maximum <i>illumination power density</i> can only apply to the location where that level is needed. 3. The maximum <i>illumination power density</i> may be increased by dividing it by the <i>illumination power density</i> adjustment factor in Table J6.2c where applicable. 	

Deemed-to-Satisfy Provisions

Table J6.2c ILLUMINATION POWER DENSITY ADJUSTMENT FACTOR

Item	Description	<i>Illumination power density adjustment factor</i>
Motion detector in accordance with Specification J6	(a) Where— (i) at least 75% of the <i>floor area</i> of a space is controlled by one or more motion detectors; or (ii) an area of less than 200 m ² is switched as a block by one or more detectors.	0.9
	(b) Where up to 6 lights are switched as a block by one or more detectors.	0.7
	(c) Where an area of a <i>carpark</i> of less than 500 m ² is switched as a block by one or more detectors.	0.7
	(d) Where up to 2 lights are switched as a block by one or more detectors.	0.55
Manual dimming system (Note 1)	Where at least 75% of the <i>floor area</i> of a space is controlled by manually operated dimmers.	0.95
Programmable dimming system (Note 2)	Where at least 75% of the <i>floor area</i> of a space is controlled by programmable dimmers.	0.85
Dynamic dimming system (Note 3)	Automatic compensation for lumen depreciation.	The design lumen depreciation factor; and (i) with fluorescent lights, no less than 0.9; or (ii) with high pressure discharge lights, no less than 0.8.
Fixed dimming (Note 4)	Where at least 75% of the <i>floor area</i> is controlled by fixed dimmers that reduce the overall lighting level and the power consumption of the lighting.	% of full power to which the dimmer is set multiplied by 0.95.

Deemed-to-Satisfy Provisions

Table J6.2c ILLUMINATION POWER DENSITY ADJUSTMENT FACTOR— continued

Item	Description	<i>Illumination power density adjustment factor</i>
Daylight sensor and dynamic lighting control device in accordance with Specification J6 – dimmed or stepped switching of lights adjacent <i>windows</i>	(a) Lights within the space adjacent to <i>windows</i> other than <i>roof lights</i> for a distance from the <i>window</i> equal to the depth of the floor to window head height.	0.5 (Note 5)
	(b) Where the total area of <i>roof lights</i> is less than 10% of the <i>floor area</i> .	0.6 (Note 5)
	(c) Where the total area of <i>roof lights</i> is 10% or more of the <i>floor area</i> .	0.5 (Note 5)
Room size (Note 6)	Room index not more than 0.7.	0.5
	Room index more than 0.7 but not more than 1.5.	0.7
	Room index more than 1.5 but not more than 3.0.	0.9
	Room index more than 3.0.	1.0

Notes:

1. Manual dimming is where lights are controlled by a knob, slider or other mechanism or where there are pre-selected scenes that are manually selected.
2. Programmed dimming is where pre-selected scenes or levels are automatically selected by the time of day, photoelectric cell or occupancy sensor.
3. Dynamic dimming is where the lighting level is varied automatically by a photoelectric cell to either proportionally compensate for the availability of daylight or the lumen depreciation of the lamps.
4. Fixed dimming is where lights are controlled to a level and that level cannot be adjusted by the user.
5. The *illumination power density* adjustment factor is only applied to lights controlled by that item. This adjustment factor does not apply to tungsten halogen or other incandescent sources.
6. The room index is an expression of the room proportion with respect to the lights and is determined by the formula:

$$L \times W / H_m(L + W)$$

Where:

L is the length of the room; and

W is the width of the room; and

H_m is the height that the fitting is mounted above the work surface.

Deemed-to-Satisfy Provisions

Table J6.2c ILLUMINATION POWER DENSITY ADJUSTMENT FACTOR— continued

Item	Description	<i>illumination power density adjustment factor</i>
7.	<p>Room size and a maximum of two other <i>illumination power density</i> adjustment factors can be applied to an area. Where more than one <i>illumination power density</i> adjustment factor (other than for room size) apply to an area, they are to be combined using the following formula:</p> $A \times (B + [(1 - B) / 2])$ <p>Where:</p> <p>A is the lowest applicable <i>illumination power density</i> adjustment factor; and</p> <p>B is the second lowest applicable <i>illumination power density</i> adjustment factor.</p>	

J6.3 Interior artificial lighting and power control

- (a) Artificial lighting of a room or space must be individually operated by a switch or other control device.
- (b) An occupant activated device, such as a room security device, a motion detector in accordance with **Specification J6**, or the like, must be provided in the *sole-occupancy unit* of a Class 3 building, other than where providing accommodation for the aged, to cut power to the artificial lighting, air-conditioner, local exhaust fans and bathroom heater when the *sole-occupancy unit* is unoccupied.
- (c) An artificial lighting switch or other control device in **(a)** must—
 - (i) if an artificial lighting switch, be located in a visible position—
 - (A) in the room or space being switched; or
 - (B) in an adjacent room or space from where the lighting being switched is visible; and
 - (ii) if in a building other than a Class 2 or 3 building or a Class 4 part, not operate lighting within an area of more than—
 - (A) 250 m² for a space of not more than 2000 m² *floor area*; or
 - (B) 1000 m² for a space of more than 2000 m² *floor area*.
- (d) Artificial lighting in a building or *storey* of a building, other than a Class 2 or 3 building or a Class 4 part, of more than 250 m² in *floor area* must be controlled by—
 - (i) a time switch in accordance with **Specification J6**; or
 - (ii) an occupant sensing device such as—
 - (A) a security key card reader; or
 - (B) a motion detector in accordance with **Specification J6**.
- (e) Artificial lighting adjacent to windows in a *storey* of a Class 5, 6 or 8 building, of more than 250 m² in *floor area* must be switched separately from artificial lighting not adjacent to windows.
- (f) The requirements of **(a)**, **(b)**, **(c)**, **(d)** and **(e)** do not apply to the following:

Deemed-to-Satisfy Provisions

- (i) Emergency lighting in accordance with **Part E4**
- (ii) Where artificial lighting is needed for 24-hour occupancy such as for a manufacturing process, an airport control tower or within a *detention centre*.
- (g) The requirements of **(d)** do not apply to artificial lighting in a Class 9a *patient care area* or a Class 9c *aged care building*.

J6.4 Interior decorative and display lighting

- (a) Interior decorative and display lighting, such as for a foyer mural or art display, must be controlled—
 - (i) separately from other artificial lighting; and
 - (ii) by a manual switch for each area other than when the operating times of the displays are the same in a number of areas such as in a museum, art gallery or the like, in which case they may be combined; and
 - (iii) by a time switch in accordance with **Specification J6** where the display lighting exceeds 7 kW.
- (b) Window display lighting must be controlled separately from other display lighting.

J6.5 Artificial lighting around the perimeter of a building

- (a) Artificial lighting around the perimeter of a building, must—
 - (i) be controlled by—
 - (A) a daylight sensor; or
 - (B) a time switch that is capable of switching on and off electric power to the system at variable pre-programmed times and on variable pre-programmed days; and
 - (ii) when the total perimeter lighting load exceeds 100 W—
 - (A) have an average *light source efficacy* of not less than 60 Lumens/W; or
 - (B) be controlled by a motion detector in accordance with **Specification J6**; and
 - (iii) when used for decorative purposes, such as facade lighting or signage lighting, have a separate time switch in accordance with **Specification J6**.
- (b) The requirements of **(a)(ii)** do not apply to the following:
 - (i) Emergency lighting in accordance with **Part E4**.
 - (ii) Lighting around a *detention centre*.

J6.6 Boiling water and chilled water storage units

Power supply to a boiling water or chilled water storage unit must be controlled by a time switch in accordance with **Specification J6**.

PART J7

HOT WATER SUPPLY

Deemed-to-Satisfy Provisions

VIC Part J7

J7.0 Deemed-to-Satisfy Provisions

- (a) Where a *Building Solution* is proposed to comply with the *Deemed-to-Satisfy Provisions*, *Performance Requirement JP1* is satisfied by complying with—
- (i) **J1.1** to **J1.6**; and
 - (ii) **J2.1** to **J2.5**; and
 - (iii) **J3.1** to **J3.7**; and
 - (iv) **J4.1** to **J4.4**; and
 - (v) **J5.1** to **J5.5**; and
 - (vi) **J6.1** to **J6.6**; and
 - (vii) **J7.1** to **J7.2**.
- (b) Where a *Building Solution* is proposed as an *Alternative Solution* to the *Deemed-to-Satisfy Provisions* of—
- (i) **J1.1** to **J1.6**; and
 - (ii) **J2.1** to **J2.5**; and
 - (iii) **J3.1** to **J3.7**; and
 - (iv) **J4.1** to **J4.4**; and
 - (v) **J5.1** to **J5.5**; and
 - (vi) **J6.1** to **J6.6**; and
 - (vii) **J7.1** to **J7.2**,
- the relevant *Performance Requirements* must be determined in accordance with **A0.10**.

J7.1 * * * * *

This clause has been deliberately left blank.

J7.2 Hot water supply

SA J7.2

A hot water supply system for food preparation and sanitary purposes, other than a solar hot water supply system in *climate zones* 1, 2 and 3, must be designed and installed in accordance with Section 8 of AS/NZS 3500.4.

PART J8

ACCESS FOR MAINTENANCE

Deemed-to-Satisfy Provisions

J8.0 Deemed-to-Satisfy Provisions

- (a) Where a *Building Solution* is proposed to comply with the *Deemed-to-Satisfy Provisions*, *Performance Requirement JP2* is satisfied by complying with **J8.1** and **J8.2**.
- (b) Where a *Building Solution* is proposed as an *Alternative Solution* to the *Deemed-to-Satisfy Provisions* of **J8.1** and **J8.2**, the relevant *Performance Requirements* must be determined in accordance with **A0.10**.

J8.1 Application of Part

The *Deemed-to-Satisfy Provisions* of this Part do not apply within a *sole-occupancy unit* of a Class 2 building or a Class 4 part of a building.

J8.2 Access for maintenance

NSW J8.2

Access must be provided to all plant, equipment and components that *require* maintenance in accordance with **Part I2**.

SPECIFICATION **J1.2** MATERIAL PROPERTIES

Deemed-to-Satisfy Provisions

1. Scope

This Specification lists the thermal properties of some common construction materials.

2. Construction Deemed-to-Satisfy

(a) **Table 2a** lists the thermal conductivity considered to be achieved by some common construction materials.

Table 2a THERMAL CONDUCTIVITY OF TYPICAL WALL, ROOF/CEILING AND FLOOR MATERIALS

Material description	Material density kg/m ³	Thermal conductivity W/m.K
1. Framing		
(a) Steel	7850	47.5
(b) Timber – kiln dried hardwood (across the grain)	677	0.16
(c) Timber – Radiata pine (across the grain)	506	0.10
2. Roof Cladding		
(a) Aluminium sheeting	2680	210
(b) Concrete or terra cotta tiles	1922	0.81
(c) Steel sheeting	7850	47.5
3. Wall Cladding		
(a) Aluminium sheeting	2680	210
(b) Autoclaved aerated concrete	350	0.10
	900	0.27
(c) Cement render (1 cement : 4 sand)	1570	0.53
(d) Clay bricks		
(i) Clay brick – 2.75 kg	1430	0.55
(ii) Clay brick – 3.25 kg	1690	0.65
(iii) Clay brick – 3.75 kg	1950	0.78
(e) Concrete blocks		
(i) 190 mm dense or 90 mm dense solid	1100/2200	1.1
(ii) 140 mm dense or 190 mm lightweight	1250/910	0.85
(iii) 90 mm dense hollow or 90 mm lightweight solid	1650/1800	0.75

Deemed-to-Satisfy Provisions

Table 2a THERMAL CONDUCTIVITY OF TYPICAL WALL, ROOF/CEILING AND FLOOR MATERIALS— continued

Material description	Material density kg/m ³	Thermal conductivity W/m.K
(iv) 140 mm lightweight	1050	0.67
(v) 90 mm lightweight	1360	0.55
(f) Fibre-cement	1360	0.25
(g) Gypsum plasterboard	880	0.17
(h) Pine weatherboards	506	0.10
(i) Plywood	530	0.14
(j) Solid concrete	2400	1.44
(k) Steel sheeting	7850	47.5
(l) Prestressed hollow core concrete panel	1680	0.80
4. Flooring Materials		
(a) Carpet underlay	-	0.04
(b) Carpet	-	0.05
(c) Prestressed hollow core concrete planks	1680	0.80
(d) Particleboard	640	0.12
(e) Plywood	530	0.14
(f) Timber – kiln dried hardwood (across the grain)	677	0.16
(g) Timber – Radiata pine (across the grain)	506	0.10
(h) Solid concrete	2400	1.44
(i) Vinyl floor tiles	2050	0.79
5. Other Materials		
(a) Air (still)	1.2	0.03
(b) Clay soil (10% moisture content)	1300	0.6
(c) PMMA (polymethylmethacrylate)	1180	1.00
(d) Polycarbonates	1200	0.2
(e) Sand (6% moisture content)	1800	1.64
(f) Soda lime glass	2500	1.0
Notes:		
1. For materials which incorporate cores or hollows in regular patterns (such as cored brickwork, hollow blockwork and cored floor or wall panels), the tabulated material densities and thermal conductivities are based on the gross density (mass divided by external dimensions).		
2. The <i>R-Value</i> of a material is determined by dividing the thickness of the material in metres by the thermal conductivity in W/m.K.		

Deemed-to-Satisfy Provisions

(b) **Table 2b** lists the *R-Values* considered to be achieved by air films and airspaces.

Table 2b TYPICAL R-VALUES FOR AIRSPACES AND AIR FILMS

Position of air space	Direction of heat flow	<i>R-Value</i>
1. Airspaces non-reflective unventilated		
In a roof with a pitch of not more than 5 ⁰	Up	0.15
	Down	0.22
In a roof with a ceiling that is parallel with a roof with a pitch more than 5 ⁰ and not more than 15 ⁰	Up	0.15
	Down	0.21
In a roof with a ceiling that is parallel with a roof with a pitch more than 22 ⁰ and not more than 45 ⁰	Up	0.15
	Down	0.18
In any roof space with a horizontal ceiling, with a pitch more than 5 ⁰	Up	0.18
	Down	0.218
In a wall	Horizontal	0.17
2. Airspaces non-reflective ventilated		
In any roof with a pitch not more than 5 ⁰ and 100 mm deep air space	Up	Nil
	Down	0.19
In any roof space with a horizontal ceiling, with a pitch more than 5 ⁰	Up	Nil
	Down	0.46
In a wall	Horizontal	0.14
3. Air films – Still air		
On a surface with a pitch of not more than 5 ⁰	Up	0.11
	Down	0.16
On a surface with a pitch of more than 5 ⁰ and not more than 30 ⁰	Up	0.11
	Down	0.15
On a surface with a pitch of more than 30 ⁰ and not more than 45 ⁰ 45° slope	Up	0.11
	Down	0.13
On a wall	Horizontal	0.12
4. Air films – Moving air		
Not more than 3 m/s wind	Any direction	0.04

Deemed-to-Satisfy Provisions

Table 2b TYPICAL R-VALUES FOR AIRSPACES AND AIR FILMS— continued

Position of air space	Direction of heat flow	<i>R-Value</i>
More than 3 m/s wind speed and not more than 7 m/s wind speed	Any direction	0.03
Note: <i>R-Values</i> are for a temperature of 10°C and temperature difference of 15K.		

- (c) The thermal properties considered to be achieved by reflective surfaces are—
- (i) within a wall—
 - (A) with an inner reflective surface of 0.05 emittance and a 20 mm airspace to the wall lining, an added *R-Value* of 0.48; and
 - (B) with an inner reflective surface of 0.05 emittance and a 70 mm airspace to the wall lining, an added *R-Value* of 0.43; and
 - (C) with an inner reflective surface of 0.05 emittance and a 70 mm airspace to the wall lining and an outer anti-glare reflective surface of 0.20 emittance and a 25 mm airspace to the wall cladding, an added *R-Value* of 0.95; and
 - (D) with an outer anti-glare reflective surface of 0.20 emittance and a 35 mm airspace to the wall cladding, an added *R-Value* of 0.50; and
 - (ii) within a roof where the *reflective insulation* is laid directly under the roof, those in **Table 2c**.

Table 2c TYPICAL THERMAL PROPERTIES FOR REFLECTIVE SURFACES AND AIRSPACES IN ROOFS

Emittance of added <i>reflective insulation</i>	Direction of heat flow	<i>R-Value</i> added by a reflective surface					
		Pitched roof ($\geq 10^\circ$) with horizontal ceiling		Flat, skillion or pitched roof ($< 10^\circ$) with horizontal ceiling	Pitched roof with cathedral ceiling		
		Ventilated roof space	Non-ventilated roof space		15° to not more than 25° pitch	more than 25° to not more than 35° pitch	more than 35° to 45° pitch
0.2 outer 0.05 inner	Downwards	1.21	1.12	1.28	0.96	0.86	0.66
0.2 outer 0.05 inner	Upwards	0.59	0.75	0.68	0.72	0.74	0.77
0.9 outer 0.05 inner	Downwards	1.01	0.92	1.06	0.74	0.64	0.44

Deemed-to-Satisfy Provisions

Table 2c TYPICAL THERMAL PROPERTIES FOR REFLECTIVE SURFACES AND AIRSPACES IN ROOFS— continued

Emittance of added reflective insulation	Direction of heat flow	<i>R-Value</i> added by a reflective surface					
		Pitched roof ($\geq 10^\circ$) with horizontal ceiling		Flat, skillion or pitched roof ($< 10^\circ$) with horizontal ceiling	Pitched roof with cathedral ceiling		
		Ventilated roof space	Non-ventilated roof space		15° to not more than 25° pitch	more than 25° to not more than 35° pitch	more than 35° to 45° pitch
0.9 outer 0.05 inner	Upward	0.40	0.55	0.49	0.51	0.52	0.53

- (d) A ventilated roof space is a roof space with—
- (i) gable vents, ridge vents, eave vents, roof vents or the like that—
 - (A) are evenly distributed to allow an unobstructed flow of air; and
 - (B) are located to ensure, where practicable, there are no dead airspaces; and
 - (C) have an aggregate fixed open area of not less than 1.0% of the ceiling area; or
 - (ii) not less than 2 wind-driven roof ventilators having an aggregate opening area of not less than 0.14 m² in conjunction with gable vents, ridge vents, eave vents, roof vents or the like having an aggregate fixed open area of not less than 0.2% of the ceiling area; or
 - (iii) a tiled roof without *sarking-type material* at roof level.

SPECIFICATION **J1.3** ROOF AND CEILING CONSTRUCTION

Deemed-to-Satisfy Provisions

1. Scope

This Specification describes the thermal performance of some common forms of roof and ceiling construction.

2. Construction Deemed-to-Satisfy

Figure 2 details the *R-Values* considered to be achieved by some common forms of roof and ceiling construction.

Figure 2 TYPICAL R-VALUES FOR ROOF AND CEILING CONSTRUCTION

Roof construction description	Item	Item description	<i>R-Value</i> Unventilated		<i>R-Value</i> Ventilated																																					
			Up	Down	Up	Down																																				
			<div style="display: flex; align-items: center;"> <div style="flex: 1;"> <p>(a) Roof 15° to 45° pitch – Horizontal ceiling – Metal cladding</p> </div> <table border="1" style="margin-left: 20px;"> <tr> <td>1.</td> <td>Outdoor air film (7 m/s)</td> <td>0.03</td> <td>0.03</td> <td>0.03</td> <td>0.03</td> </tr> <tr> <td>2.</td> <td>Metal cladding</td> <td>0.00</td> <td>0.00</td> <td>0.00</td> <td>0.00</td> </tr> <tr> <td>3.</td> <td>Roof airspace (non-reflective)</td> <td>0.18</td> <td>0.28</td> <td>0.00</td> <td>0.46</td> </tr> <tr> <td>4.</td> <td>Plasterboard, gypsum (10 mm, 880 kg/m³)</td> <td>0.06</td> <td>0.06</td> <td>0.06</td> <td>0.06</td> </tr> <tr> <td>5.</td> <td>Indoor air film (still air)</td> <td>0.11</td> <td>0.16</td> <td>0.11</td> <td>0.16</td> </tr> <tr> <td colspan="2" style="text-align: right;"><i>Total R-Value</i></td> <td>0.38</td> <td>0.53</td> <td>0.20</td> <td>0.71</td> </tr> </table> </div>							1.	Outdoor air film (7 m/s)	0.03	0.03	0.03	0.03	2.	Metal cladding	0.00	0.00	0.00	0.00	3.	Roof airspace (non-reflective)	0.18	0.28	0.00	0.46	4.	Plasterboard, gypsum (10 mm, 880 kg/m ³)	0.06	0.06	0.06	0.06	5.	Indoor air film (still air)	0.11	0.16	0.11	0.16	<i>Total R-Value</i>		0.38
1.	Outdoor air film (7 m/s)	0.03	0.03	0.03	0.03																																					
2.	Metal cladding	0.00	0.00	0.00	0.00																																					
3.	Roof airspace (non-reflective)	0.18	0.28	0.00	0.46																																					
4.	Plasterboard, gypsum (10 mm, 880 kg/m ³)	0.06	0.06	0.06	0.06																																					
5.	Indoor air film (still air)	0.11	0.16	0.11	0.16																																					
<i>Total R-Value</i>		0.38	0.53	0.20	0.71																																					

Deemed-to-Satisfy Provisions

Figure 2 TYPICAL R-VALUES FOR ROOF AND CEILING CONSTRUCTION— continued

Roof construction description	Item	Item description	R-Value Unventilated		R-Value Ventilated	
			Up	Down	Up	Down
			<p>(b) Roof 15° to 45° pitch – Horizontal ceiling – Clay tiles 19 mm</p> 			
1.	Outdoor air film (7 m/s)	0.03	0.03	0.03	0.03	
2.	Roof tile, clay or concrete (1922 kg/m ³)	0.02	0.02	0.02	0.02	
3.	Roof airspace (non-reflective)	0.18	0.28	0.00	0.46	
4.	Plasterboard, gypsum (10 mm, 880 kg/m ³)	0.06	0.06	0.06	0.06	
5.	Indoor air film (still air)	0.11	0.16	0.11	0.16	
		<i>Total R-Value</i>	0.40	0.55	0.22	0.73

Figure 2 TYPICAL R-VALUES FOR ROOF AND CEILING CONSTRUCTION

Roof construction description	Item	Item description	R-Value Unventilated	
			Up	Down
			<p>(c) Cathedral ceiling 15° to 45° pitch – 10 mm plaster on top of rafters – Metal external cladding</p> 	
1.	Outdoor air film (7 m/s)	0.03	0.03	
2.	Metal cladding	0.00	0.00	
3.	Roof airspace (30 mm to 100 mm, non-reflective)	0.15	0.18	
4.	Plasterboard, gypsum (10 mm, 880 kg/m ³)	0.06	0.06	
5.	Indoor air film (still air)	0.11	0.14	
		<i>Total R-Value</i>	0.35	0.41

Deemed-to-Satisfy Provisions

Figure 2 TYPICAL R-VALUES FOR ROOF AND CEILING CONSTRUCTION— continued

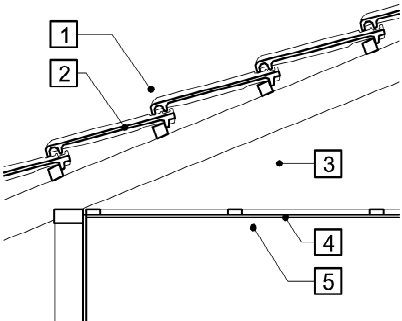
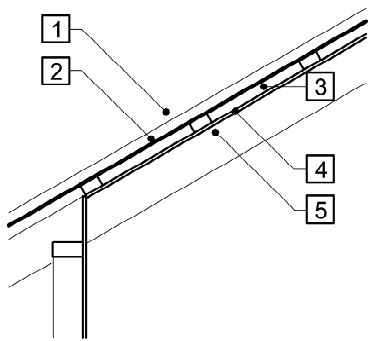
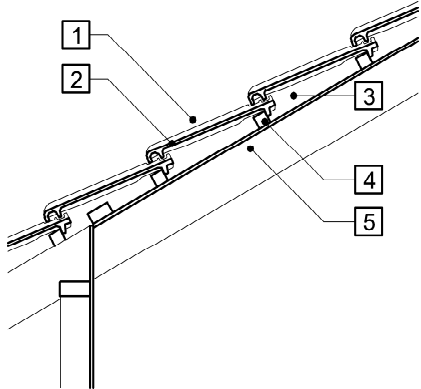
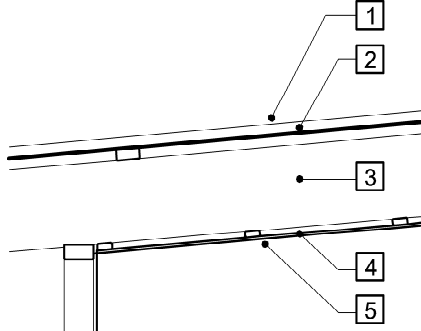
Roof construction description	Item	Item description	R-Value Unventilated	
			Up	Down
(d) Cathedral ceiling 15° to 45° pitch – 10 mm plaster on top of rafters – Tiles external cladding 	1.	Outdoor air film (7 m/s)	0.03	0.03
	2.	Roof tile, clay or concrete (1922 kg/m ³)	0.02	0.02
	3.	Roof airspace (30 mm to 100 mm, non-reflective)	0.15	0.18
	4.	Plasterboard, gypsum (10 mm, 880 kg/m ³)	0.06	0.06
	5.	Indoor air film (still air)	0.11	0.14
	<i>Total R-Value</i>			0.37
(e) Skillion roof less than 5° pitch – 10 mm plaster below rafters – Metal external cladding 	1.	Outdoor air film (7 m/s)	0.03	0.03
	2.	Metal cladding	0.00	0.00
	3.	Roof airspace (100 mm to 300 mm, non-reflective)	0.15	0.22
	4.	Plasterboard, gypsum (10 mm, 880 kg/m ³)	0.06	0.06
	5.	Indoor air film (still air)	0.11	0.16
	<i>Total R-Value</i>			0.35

Deemed-to-Satisfy Provisions

Figure 2 TYPICAL R-VALUES FOR ROOF AND CEILING CONSTRUCTION— continued

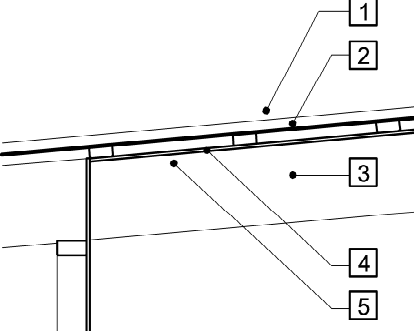
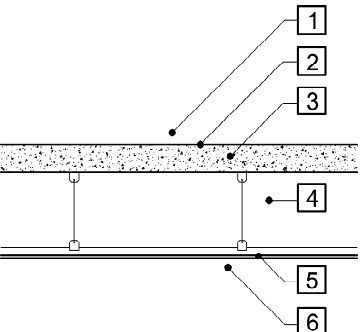
Roof construction description	Item	Item description	R-Value Unventilated		
			Up	Down	
(f) Skillion roof 5° to 15° pitch – 10 mm plaster on top of rafters – Metal external cladding 	1.	Outdoor air film (7 m/s)	0.03	0.03	
	2.	Metal cladding	0.00	0.00	
	3.	Roof airspace (30 mm to 100 mm non-reflective)	0.15	0.21	
	4.	Plasterboard, gypsum (10 mm, 880 kg/m ³)	0.06	0.06	
	5.	Indoor air film (still air)	0.11	0.16	
	<i>Total R-Value</i>			0.35	0.46
(g) 100 mm solid concrete roof to 5° – 10 mm plaster, suspended ceiling – Applied external waterproof membrane 	1.	Outdoor air film (7 m/s)	0.03	0.03	
	2.	Waterproof membrane, rubber synthetic (4 mm, 961 kg/m ³)	0.03	0.03	
	3.	Solid concrete, (100 mm, 2400 kg/m ³)	0.07	0.07	
	4.	Ceiling airspace (100 mm to 300 mm, non-reflective)	0.15	0.22	
	5.	Plasterboard, gypsum (10 mm, 880 kg/m ³)	0.06	0.06	
	6.	Indoor air film (still air)	0.11	0.16	
	<i>Total R-Value</i>			0.45	0.57

Deemed-to-Satisfy Provisions

Figure 2 TYPICAL R-VALUES FOR ROOF AND CEILING CONSTRUCTION— continued

Roof construction description	Item	Item description	<i>R-Value</i> Unventilated	
			Up	Down
<p>Notes:</p> <ol style="list-style-type: none"> 1. The <i>R-Value</i> of an item, other than an airspace, air film or air cavity, may be increased in proportion to the increased thickness of the item. 2. The <i>Total R-Value</i> of a form of construction may be increased by the amount that the <i>R-Value</i> of an individual item is increased. 3. Where an airspace is filled, the <i>R-Value</i> listed for the airspace must be deducted from the <i>Total R-Value</i> of the roof construction. 4. For information on a roof space that is considered to be ventilated, see Specification J1.2, Clause 2(d). 				

SPECIFICATION J1.5 WALL CONSTRUCTION

Deemed-to-Satisfy Provisions

1. Scope

This Specification describes the thermal performance of some common forms of external wall construction.

2. Construction Deemed-to-Satisfy

Figure 2 details the *R-Values* considered to be achieved by some common forms of wall construction.

Figure 2 TYPICAL R-VALUES FOR WALL CONSTRUCTION

External wall construction description	Item	Item description	<i>R-Value</i>
(a) Masonry veneer – 25 mm to 50 mm cavity, 10 mm internal plaster on 90 mm stud frame 	1.	Outdoor air film (7 m/s)	0.03
	2.	Masonry (See notes 3 and 4)	0.09
	3.	Cavity and airspace (115 to 140 mm, made up of 90 mm stud + 25 mm to 50 mm airspace non-reflective and unventilated)	0.17
	4.	Plasterboard, gypsum (10 mm, 880 kg/m ³)	0.06
	5.	Indoor air film (still air)	0.12
	<i>Total R-Value</i>		0.47
(b) Cavity masonry – 20 mm to 50 mm cavity, 10 mm internal plaster on battens or furring channels 	1.	Outdoor air film (7 m/s)	0.03
	2.	Masonry (See notes 3 and 4)	0.09
	3.	Masonry cavity (20 mm to 50 mm, non-reflective and unventilated)	0.17
	4.	Masonry (See note 4)	0.09
	5.	Airspace (20 mm to 35 mm, non-reflective and unventilated)	0.17
	6.	Plasterboard, gypsum (10 mm, 880 kg/m ³)	0.06
	7.	Indoor air film (still air)	0.12
<i>Total R-Value</i>		0.73	

Deemed-to-Satisfy Provisions

Figure 2 TYPICAL R-VALUES FOR WALL CONSTRUCTION— continued

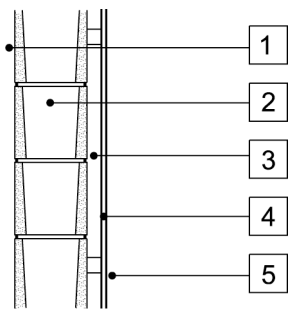
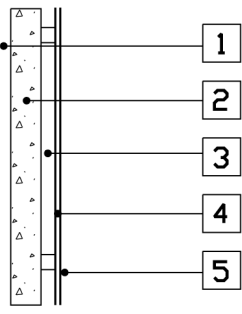
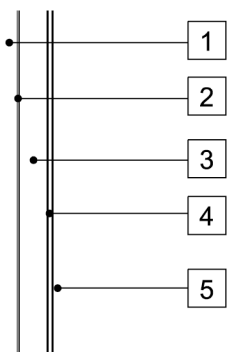
External wall construction description	Item	Item description	<i>R-Value</i>
(c) Denseweight hollow concrete block with internal plaster on battens or furring channels 	1.	Outdoor air film (7 m/s)	0.03
	2.	Denseweight hollow concrete block (See notes 3 and 4)	0.15
	3.	Airspace (20 mm to 40 mm non-reflective and unventilated)	0.17
	4.	Plasterboard, gypsum (10 mm, 880 kg/m ³)	0.06
	5.	Indoor air film (still air)	0.12
	<i>Total R-Value</i>		0.53
(d) 125 mm solid reinforced concrete (dense weight) – 10 mm internal plaster on battens or furring channels 	1.	Outdoor air film (7 m/s)	0.03
	2.	125 mm minimum solid reinforced concrete (See note 3)	0.09
	3.	Airspace (20 mm to 40 mm non-reflective and unventilated)	0.17
	4.	Plasterboard, gypsum (10 mm, 880 kg/m ³)	0.06
	5.	Indoor air film (still air)	0.12
	<i>Total R-Value</i>		0.47
(e) Timber wall – external 6 mm cement sheet cladding, 90 mm stud frame, 10 mm plaster 	1.	Outdoor air film (7 m/s)	0.03
	2.	Fibre cement (6 mm, 1360 kg/m ³)	0.03
	3.	Airspace (90 mm nonreflective and unventilated)	0.17
	4.	Plasterboard, gypsum (10 mm, 880 kg/m ³)	0.06
	5.	Indoor air film (still air)	0.12
	<i>Total R-Value</i>		0.41

Deemed-to-Satisfy Provisions

Figure 2 TYPICAL R-VALUES FOR WALL CONSTRUCTION— continued

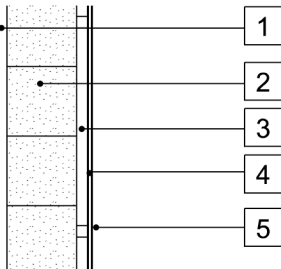
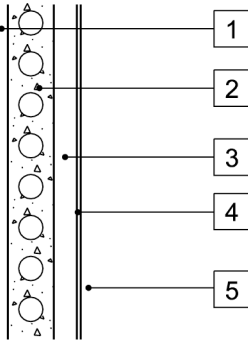
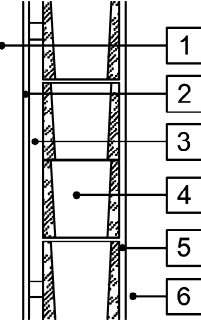
External wall construction description	Item	Item description	<i>R-Value</i>
(f) 200 mm autoclaved aerated concrete block – 10 mm internal plaster on battens or furring channels 	1.	Outdoor air film (7 m/s)	0.03
	2.	Autoclaved aerated concrete block (200 mm, 350 kg/m ³)	2.00
	3.	Airspace (20 mm to 40 mm non-reflective and unventilated)	0.17
	4.	Plasterboard, gypsum (10 mm, 880 kg/m ³)	0.06
	5.	Indoor air film (still air)	0.12
	<i>Total R-Value</i>		2.38
(g) 150 mm hollow-core concrete panels – 10 mm internal plaster on battens or furring channels 	1.	Outdoor air film (7 m/s)	0.03
	2.	Prestressed hollow-core concrete panels (150 mm, 1,680 kg/m ³ , 30% cores)	0.14
	3.	Airspace (20 mm to 40 mm non-reflective and unventilated)	0.17
	4.	Plasterboard, gypsum (10 mm, 880 kg/m ³)	0.06
	5.	Indoor air film (still air)	0.12
	<i>Total R-Value</i>		0.52
(h) Denseweight hollow concrete block with external 6 mm cement sheet cladding on battens or furring channels 	1.	Outdoor air film (7 m/s)	0.03
	2.	Fibre cement (6 mm, 1360 kg/m ³)	0.03
	3.	Airspace (20 mm to 40 mm non-reflective and unventilated)	0.17
	4.	Denseweight hollow concrete block (See note 4)	0.15
	5.	10 mm render	0.02
	6.	Indoor air film (still air)	0.12
	<i>Total R-Value</i>		0.52

Deemed-to-Satisfy Provisions

Figure 2 TYPICAL R-VALUES FOR WALL CONSTRUCTION— continued

External wall construction description	Item	Item description	R-Value
Notes:			
1. The <i>R-Value</i> of an item, other than an airspace, air film or air cavity, may be increased in proportion to the increased thickness of the item.			
2. The <i>Total R-Value</i> of a form of construction may be increased by the amount that an individual item is increased.			
3. The addition of 10 mm of render to a concrete or masonry wall will increase the <i>Total R-Value</i> by 0.02.			
4. (a) The typical <i>R-Value</i> in Figure 2(a) and (b) is for 90 mm denseweight concrete block.			
(b) The typical <i>R-Value</i> in Figure 2(c) and (h) is for 140 mm denseweight hollow concrete block.			
(c) The typical <i>R-Value</i> in Figure 2(d) is for 125 mm solid reinforced concrete (2400 kg/m ³).			
(d) Other typical <i>R-Values</i> for masonry and concrete are as follows and may be substituted for those above:			
90 mm clay brick:			
		(density 1430 kg/m ³)	0.16
		(density 1690 kg/m ³)	0.14
		(density 1950 kg/m ³)	0.12
110 mm clay brick:			
		(density 1430 kg/m ³ , 2.75 kg/brick)	0.20
		(density 1690 kg/m ³ , 3.25 kg/brick)	0.17
		(density 1950 kg/m ³ , 3.75 kg/brick)	0.14
Denseweight hollow concrete block:			
		110 mm	0.12
		190 mm	0.20
5. The <i>Total R-Values</i> in this Figure are for <i>external walls</i> . The <i>Total R-Value</i> for an internal wall of the same construction would be 0.09 greater because the <i>R-Value</i> for an outdoor air film would be replaced by that of an indoor air film.			
6. Where a cavity or airspace is filled, the <i>R-Value</i> listed for the cavity must be deducted from the <i>Total R-Value</i> of the wall.			

SPECIFICATION **J1.6** FLOOR CONSTRUCTION

Deemed-to-Satisfy Provisions

1. Scope

This Specification describes the thermal performance of some common forms of floor construction.

2. Construction Deemed-to-Satisfy

Figure 2 details the *R-Values* considered to be achieved by some common forms of floor construction, other than a concrete floor with an embedded floor heating system.

Figure 2 TYPICAL R-VALUES FOR FLOOR CONSTRUCTION (for a floor without a floor heating system)

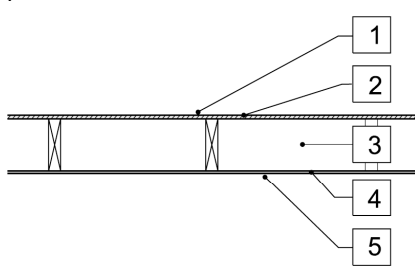
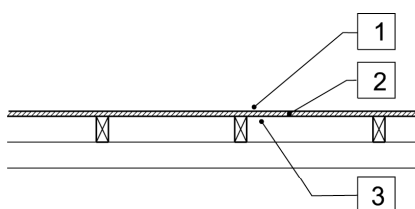
Floor construction description	Item	Item description	<i>R-Value</i>	
			Up	Down
(a) Timber internal floor, 10 mm internal plaster 	1.	Indoor air film (still air)	0.11	0.16
	2.	Particleboard flooring (19 mm, 640 kg/m ³)	0.15	0.15
	3.	Floor airspace, 100 mm to 300 mm (non reflective)	0.15	0.22
	4.	Plasterboard, gypsum (10 mm, 880 kg/m ³)	0.06	0.06
	5.	Indoor air film (still air)	0.11	0.16
	<i>Total R-Value</i>			0.58
(b) Timber, suspended ground floor, open sub-floor 	1.	Indoor air film (still air)	0.11	0.16
	2.	Particleboard flooring (19 mm, 640 kg/m ³)	0.15	0.15
	3.	Outdoor air film (7 m/s)	0.03	0.03
	<i>Total R-Value</i>			0.29

Deemed-to-Satisfy Provisions

Figure 2 TYPICAL R-VALUES FOR FLOOR CONSTRUCTION (for a floor without a floor heating system)— continued

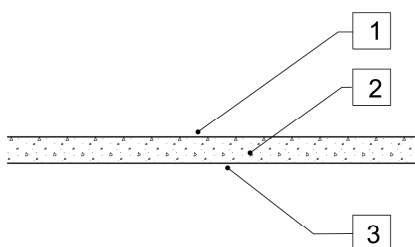
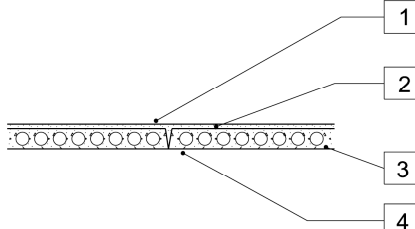
Floor construction description	Item	Item description	R-Value	
			Up	Down
(c) Solid concrete suspended slab, ground floor 	1.	Indoor air film (still air)	0.11	0.16
	2.	Solid concrete (150 mm, 2400 kg/m ³)	0.10	0.10
	3.	Outdoor air film (7 m/s)	0.03	0.03
	<i>Total R-Value</i>		0.24	0.29
(d) 150 mm hollow-core concrete planks, ground floor 	1.	Indoor air film (still air)	0.11	0.16
	2.	Concrete topping (60 mm, 2,400 kg/m ³)	0.04	0.04
	3.	Hollow-core concrete planks (150 mm, 1,680 kg/m ³ , 30% cores)	0.14	0.14
	4.	Outdoor air film (7 m/s)	0.03	0.03
	<i>Total R-Value</i>		0.32	0.37

Notes:

1. The *R-Value* of an item, other than an air space, air film or air cavity, may be increased in proportion to the increased thickness of the item.
2. The *Total R-Value* of a form of construction may be increased by the amount that an individual item is increased.
3. For floor types (c) and (d) that are located over an internal space, the *Total R-Value* can be calculated by replacing the value for outdoor air film (R0.03) on the underside of the floor with the value for indoor air film (R0.11).
4. The addition of 10 mm of render to the ceiling of a suspended internal concrete floor will increase the *Total R-Value* by 0.02.
5. Solid concrete slab includes concrete beam and infill floors and concrete precast permanent formwork panels.
6. Where an airspace is filled, the *R-Value* listed for the airspace must be deducted from the *Total R-Value* of the floor construction.

SPECIFICATION **J5.2** DUCTWORK INSULATION AND SEALING

Deemed-to-Satisfy Provisions

1. Scope

This Specification contains the requirements for the sealing and the insulating of supply and return ductwork used in a system that heats or cools a building.

2. Ductwork sealing

- (a) Heating or cooling ductwork and fittings must be sealed against air loss—
 - (i) by closing all openings in the surface, joints and seams of ductwork with adhesives, mastics, sealants or gaskets in accordance with the duct sealing requirements of AS 4254 for the static pressure in the system; or
 - (ii) for flexible ductwork at an operating static pressure of less than 500 Pa, with a draw band in conjunction with a sealant or adhesive tape.
- (b) The requirements of (a) do not apply to ductwork and fittings located within the only or last room that is served by the system.

3. Ductwork insulation

- (a) Ductwork and fittings for heating or cooling must be thermally insulated with insulation complying with AS/NZS 4859.1 to—
 - (i) achieve the *Total R-Value* specified in **Tables 3a** and **3b**; or
 - (ii) for flexible ductwork of no more than 3 m in length from an outlet or the like—
 - (A) comply with (i); or
 - (B) achieve a minimum *Total R-Value* of 1.0.
- (b) Insulation on ductwork conveying cold air must be protected by—
 - (i) a vapour barrier on the outside of the insulation; and
 - (ii) where the vapour barrier is a membrane, overlapping adjoining sheets of the membrane by 50 mm and bonding or taping the sheets together.
- (c) Ductwork insulation must—
 - (i) be protected against the effects of weather and sunlight; and
 - (ii) abut adjoining insulation to form a continuous barrier; and
 - (iii) be installed so that it maintains its position and thickness, other than at flanges and supports.
- (d) The requirements of (a) do not apply to—
 - (i) heating and cooling ductwork and fittings located within the only or last room that is served by the system; and
 - (ii) air registers, diffusers, outlets, grilles and flexible fan connections.

Deemed-to-Satisfy Provisions

Table 3a DUCTWORK AND FITTINGS—MINIMUM TOTAL R-VALUE (for systems of no more than 65 kW_r and 65 kW_{heating} capacity)

Ductwork element	Minimum <i>Total R-Value</i> for ductwork and fittings in each <i>climate zone</i>						
	Evaporative cooling system	Heating-only system or refrigerated cooling-only system			Combined heating and refrigerated cooling system		
		All <i>climate zones</i>	1, 3, 4, 6 and 7	2 and 5	8	1, 3, 4, 6 and 7	2 and 5
Ductwork	0.6	1.0	1.0	1.5	1.5 (see note)	1.0	1.5
Fittings	0.4						

Note:

The minimum *Total R-Value required* may be reduced by R0.5 for combined heating and refrigerated cooling systems in *climate zones* 1, 3, 4, 6 and 7 if the ducts are—

(a) under a suspended floor with an enclosed perimeter; or

(b) in a roof space that has insulation of not less than R0.5 directly beneath the roofing.

Table 3b DUCTWORK AND FITTINGS - MINIMUM TOTAL R-VALUE (For systems greater than 65 kW_r and 65 kW_{heating} capacity)

Location of ductwork and fittings	Minimum <i>Total R-Value</i> for ductwork and fittings in each <i>climate zone</i>				
	Evaporative cooling system	Heating system or refrigerated cooling system			
		All <i>climate zones</i>	1, 3 and 4	2 and 5	6 and 7
Within a <i>conditioned space</i>	Nil	1.0	1.0	1.3	1.5
All other locations	0.9	1.8 (see note)	1.5	1.8	2.0

Note:

The minimum *Total R-Value required* may be reduced by R0.5 for heating system or refrigerated cooling system ductwork and fittings in all other locations in *climate zones* 1, 3 and 4 if the ducts are—

(a) under a suspended floor with an enclosed perimeter; or

(b) in a roof space that has insulation of not less than R0.5 directly beneath the roofing.

SPECIFICATION **J5.4** INSULATING OF PIPING, VESSELS,
HEAT EXCHANGERS AND TANKS

Deemed-to-Satisfy Provisions

1. Scope

This Specification contains the requirements for the insulating of *pipings*, vessels, heat exchangers and tanks containing heated or chilled fluid.

2. Insulation

- (a) Insulation must—
- (i) be protected against the effects of weather and sunlight; and
 - (ii) be able to withstand the temperatures within the *pipings*, vessel, heat exchanger or tank; and
 - (iii) for *pipings*, achieve the *Total R-Value* in **Table 2**; and
 - (iv) for vessels, heat exchangers and tanks, achieve a minimum *Total R-Value* of—
 - (A) 2.5 if the content is low temperature brine or glycol; or
 - (B) 1.8 if the content is chilled water; or
 - (C) 1.3 if the content is heated water; or
 - (D) 2.5 if the content is steam.
- (b) Insulation on *pipings*, vessels, heat exchangers and tanks containing chilled fluid must be protected by a vapour barrier on the outside of the insulation.
- (c) The requirements of **(a)** do not apply to *pipings*—
- (i) located within the *conditioned space* where the *pipings* is to provide the heating or cooling to that space; or
 - (ii) encased within a concrete slab or panel which is part of a heating or cooling system.

Deemed-to-Satisfy Provisions

Table 2 PIPING - MINIMUM TOTAL R-VALUE

Location	Minimum <i>Total R-Value</i> for each <i>climate zone</i>		
	1, 2, 3 and 5	4, 6 and 7	8
1. Heating water <i>pip</i>ing for systems of no more than 65 kW_{heating} capacity			
(a) Located internally	0.2	0.2	0.2
(b) Located within a wall space, an enclosed sub-floor area or an enclosed roof space	0.3	0.45	0.6
(c) Located outside the building or in an unenclosed sub-floor area or an unenclosed roof space	0.3	0.6	0.6
2. Heating water <i>pip</i>ing for systems of more than 65 kW_{heating} capacity			
(a) Located internally	0.5	0.6	0.8
(b) Located within a wall space, an enclosed sub-floor area or an enclosed roof space	0.6	0.7	0.9
(c) Located outside the building or in an unenclosed sub-floor area or an unenclosed roof space	0.7	0.8	1.0
3. Cooling water <i>pip</i>ing for systems of more than 65 kW capacity but less than 250 kW_r capacity			
(a) Located internally	1.0	0.9	0.8
(b) Located within a wall space, an enclosed sub-floor area or an enclosed roof space	1.1	1.0	0.9
(c) Located outside the building or in an unenclosed sub-floor area or an unenclosed roof space	1.2	1.1	1.0
4. Cooling water <i>pip</i>ing for systems of more than 250 kW_r capacity			
(a) Located internally	1.5	1.2	1.0
(b) Located within a wall space, an enclosed sub-floor area or an enclosed roof space	1.6	1.3	1.1
(c) Located outside the building or in an unenclosed sub-floor area or an unenclosed roof space	1.8	1.4	1.3
Note: <i>Pip</i> ing to be insulated includes all flow and return <i>pip</i> ing, cold water supply <i>pip</i> ing within 500 mm of the connection to the heating or cooling system and pressure relief <i>pip</i> ing within 500 mm of the connection to the heating or cooling system.			

SPECIFICATION **J6**

**LIGHTING AND POWER CONTROL
DEVICES**

Deemed-to-Satisfy Provisions

1. Scope

This Specification contains the requirements for lighting and power control devices including timers, time switches, motion detectors and daylight control devices.

2. Lighting timers

A lighting timer must—

- (a) be located within 2 m of every entry door to the space; and
- (b) have an indicator light that is illuminated when the artificial lighting is off; and
- (c) not control more than—
 - (i) an area of 100 m² with a single push button timer; and
 - (ii) 95% of the lights in spaces of area more than 25 m²; and
- (d) be capable of maintaining the artificial lighting—
 - (i) for not less than 5 minutes and not more than 15 minutes unless it is reset; and
 - (ii) without interruption if the timer is reset.

3. Time switch

A time switch must be capable of—

- (a) switching on and off electric power to systems—
 - (i) at variable pre-programmed times and on variable pre-programmed days; and
 - (ii) limiting the period the system is switched on to 2 hours beyond the time for which the building is occupied; and
- (b) being overridden by—
 - (i) a manual switch or an occupant sensing device that senses a person's presence for a period of up to 2 hours, after which the time switch must resume control; or
 - (ii) an occupant sensing device such as a security card reader that overrides the time switch upon a person's entry and returns control to the time switch upon the person's exit.

4. Motion detectors

- (a) In a Class 2, 3 or 9c *aged care building* other than within a *sole-occupancy unit*, a motion detector must—
 - (i) be capable of sensing movement such as by infra-red, ultrasonic or microwave detection or by a combination of these means; and
 - (ii) be capable of detecting a person before they are 1 m into the space; and

Deemed-to-Satisfy Provisions

- (iii) other than within a *sole-occupancy unit* of a Class 3 building, not control more than—
 - (A) an area of 100 m²; and
 - (B) 95% of the lights in spaces of area more than 25 m²; and
- (iv) be capable of maintaining the artificial lighting when activated—
 - (A) for not less than 5 minutes and not more than 15 minutes unless it is reset; and
 - (B) without interruption if the motion detector is reset by movement.
- (b) In a Class 5, 6, 7, 8, 9a or 9b building, a motion detector must—
 - (i) be capable of sensing movement such as by infra-red, ultrasonic or microwave detection or by a combination of these means; and
 - (ii) be capable of detecting—
 - (A) a person before they have entered 1 m into the space; and
 - (B) movement of 500 mm within the useable part of the space; and
 - (iii) not control more than—
 - (A) in other than a *carpark*, an area of 500 m² with a single sensor or group of parallel sensors; and
 - (B) 75% of the lights in spaces using high intensity discharge; and
 - (iv) be capable of maintaining the artificial lighting when activated—
 - (A) for a minimum of 5 minutes and a maximum of 30 minutes unless it is reset; and
 - (B) without interruption if the motion detector is reset by movement; and
 - (v) have a manual override switch which—
 - (A) enables the lighting to that area, or a greater area, to be turned off; and
 - (B) is not capable of switching the lights permanently on.
- (c) When outside a building, a motion detector must—
 - (i) be capable of sensing movement such as by infra-red, ultrasonic or microwave detection or by a combination of these means; and
 - (ii) be capable of detecting a person within a distance from the light equal to—
 - (A) twice the mounting height; or
 - (B) 80% of the ground area covered by the light's beam; and
 - (iii) not control more than five lights; and
 - (iv) be operated in series with a photoelectric cell or astronomical time switch so that the light will not operate in daylight hours; and
 - (v) be capable of maintaining the artificial lighting when the switch is on for a minimum of 1 minute and a maximum of 10 minutes unless it is reset; and
 - (vi) have a manual override switch which is reset after a maximum period of 4 hours.

Deemed-to-Satisfy Provisions

5. Daylight sensor and dynamic lighting control device

A daylight sensor and dynamic control device for artificial lighting must—

- (a) for switching on and off—
 - (i) be capable of having the switching level set point adjusted between 50 and 1000 Lux; and
 - (ii) have—
 - (A) a delay of more than 2 minutes; or
 - (B) a differential of more than 50 Lux, and
- (b) for dimmed or stepped switching, be capable of reducing the power consumed by the controlled lighting in proportion to the incident daylight on the working plane either—
 - (i) continuously down to a power consumption that is less than 50% of full power; or
 - (ii) in no less than 4 steps down to a power consumption that is less than 50% of full power; and
- (c) have a manual override switch which enables the lighting in an area to be turned off but is not able to switch the lights permanently on or bypass the lighting controls.

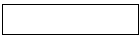

COMMONWEALTH OF AUSTRALIA

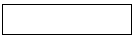

APPENDIX CONTENTS

APPENDIX COMMONWEALTH OF AUSTRALIA

Commonwealth of Australia

Footnote: Other Legislation Affecting Buildings

Footnote: OTHER LEGISLATION AFFECTING BUILDINGS

In addition to any applicable provisions of this Code, there are a number of other legislative technical requirements affecting the design, construction and/or performance of buildings that practitioners may need to be aware of, including, but not necessarily limited to, the following list. Additional legislative instruments such as regulations, codes and standards may exist under the legislation listed.

1. Aged Care Buildings

1.1 Administering agency:

Department of Health and Aging

Relevant legislation:

Aged Care Act 1997

1999 Certification Assessment Instrument

2. Australian Capital Territory

2.1 Administering agency:

Department of Transport and Regional Services

Relevant legislation:

Australian Capital Territory (Planning and Land Management) Act 1988

Parliament Act 1974

3. Child Care

3.1 Administering agency:

Department of Families, Community Services and Indigenous Affairs

Relevant legislation:

Child Care Act 1972

4. Christmas Island

4.1 Administering agency:

Department of Transport and Regional Services

Relevant legislation:

Casino Control Ordinance 1988

Casino Control Regulations 1988

Christmas Island Space Centre (APSC Proposal) Ordinance 2001

Christmas Island Space Centre (APSC Proposal) Regulations 2001

Gambling (Clubs) Ordinance 1978

Christmas Island Act 1958

5. Communications and Information Technology

5.1 Administering agency:

Department of Communications, Information Technology and the Arts

Relevant legislation:

Australian Postal Corporation Act 1989

National Transmission Network Sale Act 1998

Telecommunications Act 1997

Telstra Corporation Act 1991

6. Defence Buildings

6.1 Administering agency:

Department of Defence

Relevant legislation:

Defence Act 1903

Defence (Areas Control) Regulations 1989

Infrastructure Management

Defence Safety Manual

Contamination Manual

Defence Energy, Water and Waste Strategy

Manual of Fire Protection Engineering

Requirements for the Provision of Disabled Access and other Facilities for Disabled Persons in Defence Facilities

Defence Green Building Requirements

7. Disability Discrimination

7.1 Administering agency:

Attorney-General's Department

Relevant legislation:

Disability Discrimination Act 1992

8. Environment

8.1 Administering agency:

Department of the Environment and Water Resources

Relevant legislation:

Energy Efficiency in Government Operations (2006)

Environmental Protection and Biodiversity Conservation Act 1999

9. Federal Airports

9.1 Administering agency:

Department of Transport and Regional Services

Relevant Legislation:

Airports Act 1996

Airports Regulations 1997

Airports (Building Control) Regulations 1996

Airports (Control of On-Airport Activities) Regulations 1997

Airports (Environmental Protection) Regulations 1997

10. Jervis Bay Territory

10.1 Administering Agency

Department of Transport and Regional Services

Relevant Legislation

Jervis Bay Territory Acceptance Act 1915

11. Occupational Health and Safety

11.1 Administering Agency:

Department of Employment and Workplace Relations

Relevant Legislation:

Occupational Health and Safety Act 1991

Occupational Health and Safety (Safety Standards) Regulations 1994

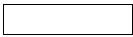

AUSTRALIAN CAPITAL TERRITORY

INTRODUCTION

The Australian Capital Territory BCA Appendix forms part of the ACT Building Code published in accordance with the provisions of the ACT Building Act 2004. This Appendix contains variations and additions to the Building Code of Australia which are necessary for the effective application of the Code in the Australian Capital Territory.

APPENDIX CONTENTS

APPENDIX AUSTRALIAN CAPITAL TERRITORY

Australian Capital Territory

A GENERAL PROVISIONS

ACT Specification A1.3 Documents Adopted by Reference
ACT AO2 Objective
ACT AF2.1 - AF2.2 Functional Statements
ACT AP2.1 - ACT AP2.2 Performance Requirements
ACT A2.0 Deemed-to-Satisfy Provisions
ACT A2.101 Control of litter on building sites
ACT A2.102 Waste management

D ACCESS AND EGRESS

ACT D1.101 Notices on fire-isolated stairs

G ANCILLARY PROVISIONS

ACT G1.1 Swimming Pools
ACT G2.2 Installation of appliances

Footnote: Other Legislation Affecting Buildings

SECTION A GENERAL PROVISIONS

PART A1 INTERPRETATION

ACT Specification A1.3 DOCUMENTS ADOPTED BY REFERENCE

Insert in Table 1 of Specification A1.3 the following:

ACT Table 1: SCHEDULE OF REFERENCED DOCUMENTS

No.	Date	Title	BCA Clause(s)
AS 1375	1985	Industrial fuel-fired appliances	ACT G2.2
AS 1692	1989	Tanks for flammable and combustible liquids	ACT G2.2
Development Control Code for Best Practice Waste Management in the ACT 1999			ACT A2.102

PART A2 ACCEPTANCE OF DESIGN AND CONSTRUCTION

Add ACT AO2 as follows:

OBJECTIVE

ACT AO2

The *Objective* of this Part is to—

- (a) prevent wind blown litter from building sites fouling roads and public land; and
- (b) safeguard people from injury caused by infection or contamination from solid waste.

Add ACT AF2.1 to ACT AF2.2 as follows:

FUNCTIONAL STATEMENTS

ACT AF2.1

Building litter must be prevented from spreading around and beyond the *site* boundary.

ACT AF2.2

Buildings must be provided with space and facilities for the collection, and safe, hygienic holding prior to disposal of solid waste arising from the intended use of the building.

Add ACT AP2.1 to ACT AP2.2 as follows:

PERFORMANCE REQUIREMENTS

ACT AP2.1

Sufficient containers must be provided on building sites to store building waste that is likely to become windblown.

ACT AP2.2

Provision must be made within buildings for the collection and temporary holding of solid waste. The design shall accommodate screening, volume of waste, disposal, logistics and access.

Add ACT A2.0 as follows:

ACT A2.0 Deemed-to-Satisfy Provisions

Performance Requirements **ACT AP2.1** to **ACT AP2.2** are satisfied by complying with **ACT A2.101** to **ACT A2.102**.

Add ACT A2.101 to ACT A2.103 as follows:

ACT A2.101 Control of litter on building sites

- (a) On site building waste must be stored in suitable size plastic or metal bins and removed from the *site* at regular intervals.
- (b) For the purpose of this clause, building waste includes plastic containers, plastic and paper wrappings, or any waste that can be carried by wind.

ACT A2.102 Waste management

Garbage facilities must be designed and constructed in accordance with the Development Control Code for Best Practice Waste Management in the ACT.

SECTION D ACCESS AND EGRESS

PART D1 PROVISION FOR ESCAPE

Add ACT D1.101 as follows:

ACT D1.101 Notices on fire-isolated stairs

- (a) Every *fire-isolated stairway* must have a notice displayed in a conspicuous position at the landing on each *storey* level to the effect of the following:

OFFENCES RELATING TO FIRE STAIRS

Under the Emergencies Act 2004 it is an offence to:

1. **Place anything in this stairway or any associated passageway leading to the exterior of the building which may impede the free passage of persons;**
2. **Interfere with or cause obstruction or impediment to the normal operation of fire doors providing access to this stairway; or**

3. Remove, damage or otherwise interfere with this notice

- (b) In any notice displayed in accordance with (a)—
- (i) the words “OFFENCES RELATING TO FIRE STAIRS” must be in letters not less than 20 mm in height;
 - (ii) all other letters and figures in the remainder of the notice must be not less than 3 mm in height; and
 - (iii) the notice must be clearly legible with lettering of a colour contrasting with the background embossed or cast into a permanent plate securely and permanently fixed to the wall.

SECTION G ANCILLARY PROVISIONS

PART G1 MINOR STRUCTURES AND COMPONENTS

Add ACT G1.1(c) and (d) as follows:

ACT G1.1 Swimming Pools

- (c) Indoor or outdoor permanent bathing, wading and *swimming pools* must—
- (i) where the capacity of the pool exceeds 10 m³—
 - (A) be of the recirculation type in which the water circulation is maintained through the pool by pumps, the water drawn from the pool being clarified and disinfected before being returned to the pool;
 - (B) have an outlet sump with antivortex cover or grating and have a skimming weir or overflow gutter or channel at high water level; and
 - (C) have means of egress provided in the form of ladders, steps in the floor of the pool or a ramp;
 - (ii) be capable of being completely emptied and any discharge or overflow and pool backwash filter must be connected to the sewer drainage system.
- (d) Pools in or forming part of buildings other than Class 1 buildings—
- (i) where in any part of the pool the depth is less than 1500 mm, the floor grade must not exceed a slope of 1 in 20;
 - (ii) permanent signs must be displayed on the side of the pool (or adjacent concourse for flush concourse waterline pools), showing the depth at 300 mm change intervals for the length of the pool and the depth at the deep and shallow ends.

PART G2 HEATING APPLIANCES, CHIMNEYS AND FLUES

Add ACT G2.2 as follows:

ACT G2.2 Installation of appliances

- (d) An industrial fuel-fired appliance: AS 1375.
- (e) Storage tanks and other associated fittings: AS 1692.

Footnote: OTHER LEGISLATION AFFECTING BUILDINGS

In addition to any applicable provisions of the Building Act 2004 and this Code, there are a number of other legislative technical requirements affecting the design, construction and/or performance of buildings that practitioners may need to be aware of, including, but not necessarily limited to, the following list. Additional legislative instruments such as regulations, codes and standards may exist under the legislation listed.

1. Construction Occupations

1.1 Administering Agency

ACT Planning and Land Authority

Relevant Legislation

Construction Occupations (Licensing) Act 2004

2. Dangerous Substances

2.1 Administering Agency

Chief Minister's Department

Department of Justice and Community Safety

Relevant Legislation

Dangerous Substances Act 2004

3. Electricity and Gas Safety

3.1 Administering Agency

ACT Planning and Land Authority

Relevant Legislation

Electricity Safety Act 1971

Gas Safety Act 2000

4. Environmental Protection and Nature Conservation

4.1 Administering Agency

Department of Territory and Municipal Services

Relevant Legislation

Environment Protection Act 1997

Nature Conservation Act 1980

5. Fences and Party Walls

5.1 Administering Agency

ACT Planning and Land Authority

Relevant Legislation

Common Boundaries Act 1981

6. Fire Safety

6.1 Administering Agency

Department of Justice and Community Safety

Department of Treasury

Relevant Legislation

Emergencies Act 2004

7. Heritage Conservation

7.1 Administering Agency

Department of Territory and Municipal Services

Relevant Legislation

Heritage Act 2004

8. Land Use and Development Control

8.1 Administering Agency

ACT Planning and Land Authority

Relevant Legislation

Planning and Development Act 2007

Unit Titles Act 2001

9. Liquor Premises

9.1 Administering Agency

Department of Justice and Community Safety

Relevant Legislation

Liquor Act 1975

10. Machinery, Scaffolding and Lifts

10.1 Administering Agency

Chief Minister's Department

Department of Justice and Community Safety

Relevant Legislation

Machinery Act 1949

Scaffolding and Lifts Act 1912

11. Occupational Health and Safety

11.1 Administering Agency

Chief Minister's Department
Department of Justice and Community Safety

Relevant Legislation

Occupational Health and Safety Act 1989
Work Safety Act 2008

12. Public Health

12.1 Administering Agency

ACT Health

Relevant Legislation

Public Health Act 1997

13. Roads and Public Places

13.1 Administering Agency

Department of Territory and Municipal Services

Relevant Legislation

Roads and Public Places Act 1937

14. Utilities

14.1 Administering Agency

ACT Planning and Land Authority
Department of Justice and Community Safety
Department of Territory and Municipal Services
Department of Treasury

Relevant Legislation

Utilities Act 2000

15. Waste

15.1 Administering Agency

Department of Territory and Municipal Services

Relevant Legislation

Waste Minimisation Act 2001

16. Water and Sewerage

16.1 Administering Agency

ACT Planning and Land Authority

Relevant Legislation

Water and Sewerage Act 2000

NEW SOUTH WALES

INTRODUCTION

The NSW Building Code technical package consists of-

- (i) the Building Code of Australia (BCA) Volume One and Volume Two; and
- (ii) the New South Wales BCA Appendix which contains variations to the requirements of the BCA and additional provisions applicable in New South Wales.

The technical package is accompanied by administrative provisions contained within the Environmental Planning and Assessment (EP & A) Act 1979 and the Environmental Planning and Assessment (EP & A) Regulation 2000.

APPENDIX CONTENTS

APPENDIX NEW SOUTH WALES

New South Wales

A GENERAL PROVISIONS

NSW A1.1 Definitions
NSW Specification A1.3 Standards Adopted by Reference

C FIRE RESISTANCE

NSW C1.10 Fire hazard properties
NSW C2.3 Large isolated buildings
NSW C2.5 Class 9a and 9c buildings
NSW C3.11 Bounding construction: Class 2, 3, 4 and 9b buildings
NSW Specification C1.10 Fire Hazard Properties

D ACCESS AND EGRESS

NSW D1.2 Number of exits required
NSW D1.6 Dimensions of exits
NSW D1.10 Discharge from exits
NSW Table 1.13 Area per person according to use
NSW D2.1 Application of Part
NSW D2.13 Treads and risers
NSW D2.15 Thresholds
NSW D2.16 Balustrades or other barriers
NSW D2.19 Doorways and doors
NSW D2.21 Operation of latch
NSW D2.101 Doors in path of travel in an entertainment venue

E SERVICES AND EQUIPMENT

Table E2.2b Specific Provisions
NSW Specification E2.2a Smoke Detectors and Alarm Systems
NSW E4.6 Direction signs

F HEALTH AND AMENITY

NSW FF2.1 Functional Statements
NSW FP2.6 Performance Requirements
NSW F2.7 Microbial (legionella) control
NSW F4.5 Ventilation of rooms

G ANCILLARY PROVISIONS

NSW G1.101 Provision for cleaning windows
NSW GO5 Objective
NSW GF5.1 Functional Statement
NSW GP5.1 Performance Requirements
NSW G5.2 Protection

H SPECIAL USE BUILDINGS

NSW H1.1 Application of Part

NSW Part H101 PLACES OF PUBLIC ENTERTAINMENT OTHER THAN TEMPORARY STRUCTURES AND DRIVE-IN THEATRES

NSW H101.1 Application of Part
NSW H101.2 Fire separation
NSW H101.3 Foyer space
NSW H101.4 Sprinkler systems for common foyers
NSW H101.5 Conventional stages
NSW H101.6 Non-conventional stages
NSW H101.7 Flying scenery
NSW H101.8 Load notice
NSW H101.9 * * * * *
NSW H101.10 Safety curtains
NSW H101.11 Seating in rows
NSW H101.12 Continental seating
NSW H101.13 Provision of guardrails
NSW H101.14 Guardrails
NSW H101.15 Dressing rooms
NSW H101.16 Storerooms
NSW H101.17 Projection suites
NSW H101.18 Basement storeys
NSW H101.19 Electric mains installation
NSW H101.20 Lighting
NSW H101.21 * * * * *
NSW H101.22 Automatic smoke-and-heat vents for stages
NSW H101.23 Solid fuel burning stoves and open fire places
NSW H101.24 Fuel gas cylinders

NSW Part H102 TEMPORARY STRUCTURES

NSW H102.1 Application of Part
NSW H102.2 Exits — Exclusions
NSW H102.3 Location of exits
NSW H102.4 Exits to be provided
NSW H102.5 Vertical clearances for exits
NSW H102.6 Curtains across exits
NSW H102.7 Curtains and blinds
NSW H102.8 Fabrics
NSW H102.9 Guardrails
NSW H102.10 Seating
NSW H102.11 Sanitary accommodation
NSW H102.12 Projection suites
NSW H102.13 Fireplaces and heating
NSW H102.14 Electrical services
NSW H102.15 Artificial lighting
NSW H102.16 Exit signs

NSW H102.17 Fire-fighting services

NSW Part H103 DRIVE-IN THEATRES

NSW H103.1 Application of Part
NSW H103.2 Speaker standards
NSW H103.3 Electrical services
NSW H103.4 Vehicular entrances
NSW H103.5 Lighting

I MAINTENANCE

NSW I1.1 Essential fire safety measures
NSW I1.2 Mechanical ventilation and hot water, warm water and cooling water systems
NSW I2 Energy Efficiency Installations

J ENERGY EFFICIENCY

NSW SUBSECTION J(A) ENERGY EFFICIENCY - CLASS 2 BUILDINGS AND CLASS 4 PARTS

NSW J(A)O1 Objective
NSW J(A)F1 Functional Statement
NSW J(A)P1 to NSW J(A)P4 Performance Requirements

NSW J(A)1 BUILDING FABRIC

NSW J(A)1.0 Deemed-to-Satisfy Provisions
NSW J(A)1.1 Application of Part
NSW J(A)1.2 Compliance with BCA provisions

NSW J(A)2 BUILDING SEALING

NSW J(A)2.0 Deemed-to-Satisfy Provisions
NSW J(A)2.1 Application of Part
NSW J(A)2.2 Compliance with BCA provisions

NSW J(A)3 AIR-CONDITIONING AND VENTILATING SYSTEMS

NSW J(A)3.0 Deemed-to-Satisfy Provisions
NSW J(A)3.1 Application of Part
NSW J(A)3.2 Compliance with BCA provisions

NSW J(A)4 HOT WATER SUPPLY

NSW J(A)4.0 Deemed-to-Satisfy Provisions
NSW J(A)4.1 Application of Part
NSW J(A)4.2 Compliance with BCA provisions

NSW J(A)5 ACCESS FOR MAINTENANCE

NSW J(A)5.0 Deemed-to-Satisfy Provisions
NSW J(A)5.1 Application of Part
NSW J(A)5.2 Access for maintenance

NSW SUBSECTION J(B) ENERGY EFFICIENCY - CLASS 3 BUILDINGS

NSW J(B)1 Compliance with BCA provisions
NSW J1.6 Floors of Class 3 buildings
NSW J3.1 Application of Part
NSW J8.2 Access for maintenance

Footnote: Other Legislation Affecting Buildings

SECTION A GENERAL PROVISIONS

PART A1 INTERPRETATION

NSW A1.1 Definitions

Insert definition for *aisle* as follows:

Aisle means a walkway at the end of *rows* of seating, not being *continental seating*, leading to a cross-over or to an egress doorway.

Insert definition for *auditorium* as follows:

Auditorium means a part of an *entertainment venue* used or intended to be used for the purposes of accommodating an audience to an entertainment.

Insert definition of *continental seating* as follows:

Continental seating means *rows* of seating in which the *rows* extend the full width of an *auditorium* without intervening *aisles*.

Insert definition of *cross-over* as follows:

Cross-over in relation to an *entertainment venue* or *temporary structure*, means a walkway between *aisles* or between an *aisle* and an egress doorway.

Vary definition for *designated bushfire prone area* as follows:

Designated bushfire prone area means land that:

- (a) has been designated under legislation; or
- (b) has been identified under an environmental planning instrument, development control plan or in the course of processing and determining a development application,

as land that can support a bushfire or is likely to be subject to bushfire attack.

Vary definition for *early childhood centre* as follows:

Early childhood centre means a preschool, kindergarten or child-minding centre for the care or training of more than 5 children.

Insert definition for *entertainment venue* as follows:

Entertainment venue is as defined in the Environmental Planning and Assessment Regulation 2000.

Insert definition of *film* as follows:

Film means a cinematograph *film* of a size of 35 mm or greater.

Insert definition of *flying scenery* as follows:

Flying scenery means scenery of a kind that is lifted above the *stage* floor by means of lines run from a *grid*.

Insert definition of *grid* as follows:

Grid means a framework from which lines are run for the purpose of lifting *flying scenery* above the *stage* floor.

Insert definition of *minimum lateral clearance* as follows:

Minimum lateral clearance means a permanently unobstructed space having a height above floor level of not less than 2000 mm and a width of not less than the specified measurement.

Insert definition of *projection suite* as follows:

Projection suite means such part of an *entertainment venue* as is designed to accommodate apparatus used for projecting *films*.

Insert definition of *row* as follows:

Row means a *row* of seating—

- (a) between a wall or other barrier and an *aisle*; or
- (b) between 2 *aisles*.

Insert definition of *special fire protection purpose* as follows:

Special fire protection purpose (as per Section 100B(6) of the Rural Fires Act 1997) means any of the following purposes:

- (a) a school,
- (b) a child care centre,
- (c) a hospital (including a hospital for the mentally ill or mentally disordered),
- (d) a hotel, motel or other tourist accommodation,
- (e) a building wholly or principally used as a home or other establishment for mentally incapacitated persons,
- (f) housing for older people or people with disabilities within the meaning of State Environmental Planning Policy No 5 - Housing for Older People or People with a Disability (now SEPP Seniors Living),
- (g) a group home within the meaning of State Environmental Planning Policy No 9 - Group Homes,
- (h) a retirement village,
- (i) any other purpose prescribed by the regulations (Rural Fires Regulation 2002).

Note: For application of this definition in the BCA, the term "school" does not include a college, university or similar tertiary educational establishment.

Delete definition of *stage* and insert NSW definition of *stage* as follows:

Stage means such part of an *entertainment venue* used by performers or speakers to present a performance to an audience.

Insert definition of *temporary structure* as follows:

Temporary structure means—

- (a) a booth, tent or other temporary enclosure, whether or not a part of the booth, tent or enclosure is permanent; or
- (b) a mobile structure.

NSW Specification A1.3 STANDARDS ADOPTED BY REFERENCE

In Table 1, insert additional reference as follows:

NSW Table 1: SCHEDULE OF REFERENCED DOCUMENTS

No.	Date	Title	BCA Clause
AS/NZS 1596	2002	The Storage and Handling of LP Gas	NSW H101.24.1
AS 2001 Part 5.4	1987	Methods of test for textiles Determination of dimensional change in laundering of textile fabrics and garments — Automatic machine method	NSW C1.10
AS/NZS 3000	2000	Electrical installations — Buildings, structures and premises (SAA wiring rules)	NSW H102.14
AS 3002	1985	Electrical installations — Shows and carnivals	NSW H102.14
NSW Rural Fire Service	The document in force under the Environmental Planning and Assessment Act, 1979	Planning for Bushfire Protection	NSW G5.2
SSL		Appraisal Specification FAS102	NSW H101.17.1

SECTION C FIRE RESISTANCE

PART C1 FIRE RESISTANCE AND STABILITY

Delete C1.10(b) and insert NSW C1.10(b) as follows:

NSW C1.10 Fire hazard properties

- (b) Paint or fire-retardant coatings must not be used in order to make a material comply with a *required fire hazard property*, except in respect of a material covered by **Clause 4(d)** and **(e)** of **NSW Specification C1.10**.

PART C2 COMPARTMENTATION AND SEPARATION

Delete C2.3(a) and substitute NSW C2.3(a)(i) and (ii) as follows:

NSW C2.3 Large isolated buildings

- (a) the building does not exceed 18 000 m² in *floor area* nor exceed 108 000 m³ in volume, if—
- (i) the building is Class 7 or 8, it contains not more than 2 *storeys* and is provided with *open space* complying with **C2.4(a)** not less than 18 m wide around the building; or
 - (ii) the building is a Class 5 to 9 and is protected throughout with a sprinkler system complying with **Specification E1.5** and perimeter vehicular access complying with **C2.4(b)** is provided; or

Delete C2.5(b) and insert NSW C2.5(b) as follows:

NSW C2.5 Class 9a and 9c buildings

- (b) A Class 9c *aged care building* must comply with the following:
- (i) A building must be divided into areas not more than 500 m² by smoke proof walls complying with **Specification C2.5**.
 - (ii) A *fire compartment* must be separated from the remainder of the building by *fire walls* and notwithstanding **Specification C1.1**, floors with an FRL of not less than 60/60/60.
 - (iii) Except for walls provided in accordance with **(b)(i)** and **(ii)**, non-loadbearing *internal walls*, and if a building is of Type C construction — all *internal walls*, between and bounding *sole-occupancy-units* and bounding a *public corridor* in a *resident use area* must:
 - (A) be lined on each side with standard grade plasterboard not less than 13 mm thick or a material with at least an equivalent level of fire protection; and
 - (B) if provided with cavity insulation, contain only *non-combustible* insulation; and
 - (C) extend to the underside of—
 - (aa) the floor next above; or
 - (bb) a ceiling lined with standard grade plasterboard not less than 13 mm thick or an equivalent non-combustible material; or
 - (cc) a *non-combustible* roof covering; and
 - (D) not incorporate any penetrations above door head height unless the penetrations are adequately stopped to prevent the free passage of smoke; and
 - (E) be smoke sealed with intumescent putty or other suitable material at any construction joint, space or the like between the top of the wall and the floor, ceiling or roof.
 - (iv) *Loadbearing internal walls* must comply with the requirements of **Specification C1.1** and **paragraphs (iii)(B), (C), (D) and (E)** above.
 - (v) The following ancillary use areas must be separated from the *sole-occupancy-units* by smoke proof walls complying with **Specification C2.5**:
 - (A) A kitchen and related food preparation areas having a combined floor area of more than 30 m².
 - (B) A laundry, where items of equipment are of the type that are potential fire sources (eg gas fire dryers).
 - (C) Storage rooms greater than 10 m² principally for the storage of administrative records.
 - (vi) Openings in *fire walls* must be protected as follows:
 - (A) Doorways — *self-closing* or *automatic* closing –/60/30 fire doors.
 - (B) Windows — *automatic* or permanently fixed closed –/60/– fire windows or –/60/– *automatic* fire shutters.

- (C) Other openings — construction having an FRL not less than –/60/–.

PART C3 PROTECTION OF OPENINGS

Delete C3.11(d) and substitute NSW C3.11(d) as follows:

NSW C3.11 Bounding construction: Class 2, 3, 4 and 9b buildings

- (d) Protection for a doorway *required* under (a), (b) or (c) must be at least—
- (i) in a building of Type A construction — a *self-closing* –/60/30 fire door; and
 - (ii) in a building of Type B or C construction — a *self-closing*, tight fitting, solid core door not less than 35 mm thick,
- except
- (iii) in a Class 3 building used as a *residential aged care building*—
 - (A) of Type A construction not protected by a sprinkler system — a –/60/30 fire door; or
 - (B) either—
 - (aa) of Type B or C construction; or
 - (bb) protected with a sprinkler system complying with **Specification E1.5**, a tight fitting, solid core door not less than 35 mm thick.
 - (iv) The doors referred to in (iii) must be—
 - (A) *self-closing*; or
 - (B) fitted with a free-arm action closing device which closes the door or causes the door to remain closed (without preventing manual re-opening), upon the detection of smoke by a detector located—
 - (aa) in a building protected with a sprinkler system complying with **Specification E1.5** — within the room; or
 - (bb) in a building not protected by a sprinkler system — within the room, and adjacent to the door in any common area or corridor to which the door opens.

Insert NSW C3.11(h) as follows:

- (h) In a Class 9b building used as an *entertainment venue*, openings in construction *required* to separate one space from another must be protected in accordance with **C3.4**.

NSW Specification C1.10 FIRE HAZARD PROPERTIES

Delete Clause 4(d) and insert new clauses (d) and (e), as follows:

4. Class 2, 3 and 9 buildings

- (d) in a Class 9b building used as an *entertainment venue*, and—
- (i) it is used to cover closed back upholstered seats in any part available to the public where—

- (A) smoking is permitted; or
- (B) flame is exposed in connection with the preparation of meals, have a *Spread-of-Flame Index* of not more than 6 and a *Smoke-Developed Index* of not more than 5;
- (ii) it is used to form a cinematograph screen, have—
 - (A) a *Flammability Index* no greater than 12, a *Spread-of-Flame Index* of 0 and a *Smoke-Developed Index* of not more than 7; and
 - (B) such screen must also have a supporting frame of metal construction;
- (iii) it is used as a curtain, blind or similar decor in any part available to the public, have a *Flammability Index* no greater than 6; and
- (iv) it is used as a cinematograph screen, curtain, blind or similar decor in any part available to the public, have a label affixed to a representative sample of each different material indicating, in legible characters—
 - (A) name of manufacturer;
 - (B) trade name and description of materials composition;
 - (C) retardant treatment (if any), name of applicator and date of application;
 - (D) AS 1530 Part 2 and/or AS/NZS 1530 Part 3 test number and its *Flammability*, *Spread-of-Flame* and *Smoke Developed Indices*; and
 - (E) approved methods of cleaning.
- (e) in the case of a material covered by 4(d) above, any fire-retardant coating used to make a material comply with a *required Flammability Index*, *Spread-of-Flame Index* or *Smoke Developed Index* must be—
 - (i) certified by its manufacturer or distributor as approved for use with the fabric to achieve the *required* indices; and
 - (ii) certified by its manufacturer or distributor to retain its retardancy effect after a minimum of 5 commercial dry cleaning or laundering operations carried out in accordance with AS 2001.5.4 — 1987, Procedure 7A, using ECE reference detergent; and
 - (iii) certified by the applicator as having been carried out in accordance with the manufacturer's specification.

SECTION D ACCESS AND EGRESS

PART D1 PROVISION FOR ESCAPE

Add D1.2(d)(vii) as follows:

NSW D1.2 Number of exits required

- (d)
 - (vii) any *storey* or *mezzanine* within an *auditorium* in an *entertainment venue*.

Insert NSW D1.6(f)(vi), and (h) as follows:

NSW D1.6 Dimensions of exits

- (f)
 - (vi) in a Class 9b building used as an *entertainment venue*—
 - (A) in parts of the building used by the public, the width of the *required exit* or path of travel, and the unobstructed width of each doorway must not be less than 1 m and not more than 3 m; and
 - (B) in other parts of the building, doorways must comply with **D1.6(f)**.
- (h) in a Class 9b building used as an *entertainment venue*—
 - (i) the aggregate width must be not less than 2 m plus 500 mm for every 50 persons or part in excess of 200; and
 - (ii) **D1.6(b), (c) and (d)** do not apply; and
 - (iii) where one or more paths of travel merge, the width of the combined path of travel must be not less than the sum of the *required* widths of those paths of travel; and
 - (iv) the *required* widths of the paths of travel connecting the *exits* from the building to a public road or *open space* must comply with **(iii)**.

Delete D1.10(f) and insert NSW D1.10(f) as follows:

NSW D1.10 Discharge from exits

- (f) In a Class 9b building used as an *entertainment venue*, at least half of the *required* number of *exits* from each *storey* or *mezzanine*, and at least half of the aggregate width of such *exits* must discharge otherwise than through the main entrance, or the area immediately adjacent to the main entrance of the building.

Vary Table D1.13 as follows:

NSW Table D1.13 AREA PER PERSON ACCORDING TO USE

Type of use	m ² per person
Delete “Theatres and public halls” and insert the following:	
<i>Places of public entertainment—</i>	
<i>other than auditorium</i>	1.2
<i>Auditorium—</i>	
standing area	0.5
removable seating	1.0
fixed seating	count seats
bench seating	450 mm/person

PART D2 CONSTRUCTION OF EXITS

Delete D2.1 and insert NSW D2.1 as follows:

NSW D2.1 Application of Part

- (a) Except for **D2.13**, **D2.14(a)** and **D2.16** the *Deemed-to-Satisfy Provisions* of this Part do not apply to the internal parts of a *sole-occupancy unit* in a Class 3 building; and
- (b) except for **D2.13**, **D2.14(a)**, **D2.16** and **D2.18**, the *Deemed-to-Satisfy Provisions* of this Part do not apply to the internal parts of a *sole-occupancy unit* in a Class 2 building or Class 4 part; and
- (c) in a Class 9b building used as an *entertainment venue*—
 - (i) **Clauses NSW D2.13(a)(ix)**, **(a)(x)**, and **(a)(xi)**, **NSW D2.15(c)**, **NSW D2.16(f)(v)**, and **NSW D2.19(b)(v)** apply to only those parts of the building used by the public; and
 - (ii) the general requirements of **Part D2** apply to all other parts of the building.

Insert NSW D2.13(a)(ix), (a)(x) and (a)(xi) as follows:

NSW D2.13 Treads and risers

- (a)
 - (ix) conspicuous edges to the treads of steps in a Class 9b building used as an *entertainment venue*; and
 - (x) in a Class 9b building used as an *entertainment venue*, not more than one helical stairway serving as a *required exit* and that stairway must—
 - (A) have a width of not less than 1500 mm;
 - (B) be of constant radius; and
 - (C) be constructed so that each tread, when measured 500 mm in from its narrow end, has a width of at least 280 mm; and
 - (xi) in a Class 9b building used as an *entertainment venue*, in a curved stairway serving as a *required exit*— an internal radius of not less than twice the width of the stair.

Renumber D2.15(c) to (d) and insert NSW D2.15(c) as follows:

NSW D2.15 Thresholds

- (c) in a Class 9b building used as an *entertainment venue*, the door sill of a doorway opening to a road, *open space*, external stair landing or external balcony is not more than 50 mm above the finished floor level to which the doorway opens; or
- (d) in other cases—
 - (i) the doorway opens to a road or *open space*, external stair landing or external balcony; and
 - (ii) the door sill is not more than 190 mm above the finished surface of the ground, balcony, or the like, to which the doorway opens.

Delete D2.16(f)(iv) and insert NSW D2.16(f)(iv) and (v) as follows:

NSW D2.16 Balustrades or other barriers

(f)

- (iv) For a balustrade or other barrier provided under **(e)**, the height above the floor must be not less than—
 - (A) 1 m; or
 - (B) 700 mm and a horizontal projection that extends not less than 1 m outwards from the top of the balustrade; or
 - (C) in a Class 9b building used as an *entertainment venue*, the height prescribed for guardrails in **NSW H101.14.2** and **NSW H102.9**.
- (v) For a balustrade in a Class 9b building used as an *entertainment venue*, the height above the nosings of the stair treads and the floors of ramps, and the floor of any access path, balcony, landing or the like, is not less than—
 - (A) 1 m when provided inside the building; and
 - (B) 1200 mm when provided externally to the building.

Insert NSW D2.19(b)(v) as follows:

NSW D2.19 Doorways and doors

(b)

- (v) in a Class 9b building used as an *entertainment venue*—
 - (A) must not be fitted with a collapsible gate, accordion door, turnstile or rigid barrier; and
 - (B) if fitted with a door, must be—
 - (aa) a swing door which opens in the direction of egress; and
 - (bb) doors hung in two folds where the unobstructed width of the doorway is more than 1 m; and
 - (C) a doorway or opening within sight of the audience but not intended for egress must have a notice displayed clearly indicating its purpose and such a notice must not be internally illuminated; and
 - (D) notwithstanding **(b)(iii)**, a sliding door may be fitted where—
 - (aa) it leads directly to a road or *open space* and forms a main entrance; and
 - (bb) it is capable of swinging in the direction of egress when pressure is applied to the inside face of the door; and
 - (cc) the door is provided with signage that clearly indicates to persons seeking egress, the potential for swinging the door open in an emergency.

Delete D2.21(b) and insert NSW D2.21(b), and (c) as follows:

NSW D2.21 Operation of latch

- (b) The requirements of (a) do not apply in a Class 9b building (other than a school, an early childhood centre or a building used for religious purposes) to a door in a *required exit*, forming part of a *required exit* or in the path of travel to a *required exit* serving a *storey* or room accommodating more than 100 persons, determined in accordance with **D1.13**, in which case it must be readily openable—
- (i) without a key from the side that faces a person seeking egress; and
 - (ii) by a single hand pushing action on a single device such as a panic bar located between 900 mm and 1.1 m from the floor; and
 - (iii) where a two-leaf door is fitted, the provisions of (i) and (ii) need only apply to one door leaf if the appropriate requirements of **D1.6** are satisfied by the opening of that one leaf; and
 - (iv) where the door is a door in a path of travel providing re-entry to the building from a balcony, terrace or the like, it may be fitted with key-operated fastenings only, the tongues of which must be locked in the retracted position whenever the building is occupied by the public, so the door can yield to pressure.
- (c) The requirements of (a) and (b) do not apply to a door serving a Class 9b building used as an *entertainment venue* where the following provisions apply to a door or gate used by the public—
- (i) on a door, the single device operating the latch or bolts must be a panic bar if those doors are to be secured; or
 - (ii) an *exit* door or gate used by the public as the main entrance may be fitted with key-operated fastenings only, the tongues of which must be locked in the retracted position whenever the building is occupied by the public so the door or gate can yield to pressure from within; or
 - (iii) a door from a balcony, terrace or the like, being a door in a path of travel providing re-entry to the building, may comply with the locking provision of (ii) above.

Add NSW D2.101 as follows:

NSW D2.101 Doors in path of travel in an entertainment venue

In a Class 9b building used as an *entertainment venue*, a doorway in a path of travel must comply with **NSW D2.19(b)(v)**.

SECTION E SERVICES AND EQUIPMENT

PART E2 SMOKE HAZARD MANAGEMENT

Delete Table E2.2b Class 9b Assembly buildings and substitute NSW Table E2.2b Class 9b buildings as follows:

NSW Table E2.2b SPECIFIC PROVISIONS

CLASS 6 BUILDINGS IN FIRE COMPARTMENTS MORE THAN 2000 m²:
The provisions of BCA Table E2.2b for Class 6 buildings are applicable in NSW.
CLASS 9b BUILDINGS
CLASS 9b ASSEMBLY BUILDINGS
The following provisions apply to all Class 9b <i>assembly buildings</i> :
<p>(a) Automatic shutdown:</p> <p>A building or part of a building used as an <i>assembly building</i> must be provided with <i>automatic</i> shutdown of any air-handling system (other than non-ducted individual room units with a capacity not more than 1000 l/s and miscellaneous exhaust air systems installed in accordance with Sections 5 and 11 of AS/NZS 1668.1) which does not form part of the smoke hazard management system, on the activation of—</p> <ul style="list-style-type: none"> (i) smoke detectors installed complying with Clause 5 of Specification E2.2a; and (ii) any other installed fire detection and alarm system, including a sprinkler system complying with Specification E1.5. <p>(b) Basements:</p> <p>A basement not counted in the <i>rise in storeys</i> in accordance with C1.2, less than 2000 m² used as an <i>assembly building</i> or part of an <i>assembly building</i> containing an <i>auditorium</i> or other public area, must be equipped with—</p> <ul style="list-style-type: none"> (i) an <i>automatic</i> smoke detection system in accordance with Specification E2.2a; or (ii) an <i>automatic</i> zone smoke control system in accordance with AS/NZS 1668.1 if the basement has more than one <i>fire compartment</i>; or if the basement forms part of a multi <i>fire compartmented</i> building served by the zone smoke control system; or (iii) a sprinkler system complying with Specification E1.5.

NSW Table E2.2b SPECIFIC PROVISIONS— continued

(c) Stages and backstages:

- (i) For the purposes of this Table, where a *stage* is separated from the *auditorium* by a proscenium wall incorporating a proscenium opening, a backstage room or area that is not separated from the *stage* by construction having an FRL of not less than 60/60/60, is taken to form part of the *stage*.
- (ii) A building or part of a building used as an *assembly building* which has a *stage*—
 - (A) with a *floor area* of more than 50 m² and not more than 150 m² must, over the *stage*, be provided with—
 - (aa) an *automatic* smoke exhaust system complying with **Specification E2.2b** (including **Figure 2.1**); or
 - (bb) roof mounted *automatic smoke-and-heat vents* complying with **NSW H101.22**, in a single *storey* building or the top *storey* of a multi *storey* building; or
 - (B) with a *floor area* of more than 150 m² must, over the *stage*, be provided with an *automatic* smoke exhaust system complying with **Specification E2.2b** (including **Figure 2.1**); or
 - (C) equipped with means of *flying scenery* must, over the *stage*, be provided with an *automatic* smoke exhaust system complying with **Specification E2.2b** (including **Figure 2.1**).

NIGHT CLUBS, DISCOTHEQUES, AND THE LIKE

A building or part of a building being a night club, discotheque or the like, must be provided with—

- (a) in an *auditorium*—
 - (i) an *automatic* smoke exhaust system complying with **Specification E2.2b**; or
 - (ii) roof mounted *automatic smoke-and-heat vents* complying with **Specification E2.2c**, in a single *storey* building or the top *storey* of a multi *storey* building; or
 - (iii) a sprinkler system complying with **Specification E1.5** with fast response sprinkler heads; and
- (b) in all other areas—
 - (i) where a building or part of a building has a *floor area* not more than 2000 m²—
 - (A) one of the smoke hazard management measures listed under (a) above; or
 - (B) an *automatic* smoke detection and alarm system complying with **Specification E2.2a**; or
 - (ii) where a building or part of a building has a *floor area* of more than 2000 m², smoke hazard management measures as provided for under 'Other Assembly Buildings' in **NSW Table E2.2b**.

Note: Paragraph (a) applies only to an *auditorium* designed principally to accommodate an audience to an entertainment.

NSW Table E2.2b SPECIFIC PROVISIONS— continued

EXHIBITION HALLS, MUSEUMS AND ART GALLERIES

A building or part of a building used as an exhibition hall, museum, art gallery or the like, must be provided with—

- (a) where the *floor area* is more than 2000 m² and not more than 3500 m²—
 - (i) an *automatic* smoke exhaust system complying with **Specification E2.2b**; or
 - (ii) roof mounted *automatic smoke-and-heat vents* complying with **Specification E2.2c** in a single *storey* building or the top *storey* of a multi *storey* building; or
 - (iii) a sprinkler system complying with **Specification E1.5**; and
- (b) where the *floor area* is more than 3500 m², a sprinkler system complying with **Specification E1.5** and—
 - (i) an *automatic* smoke exhaust system complying with **Specification E2.2b**; or
 - (ii) roof mounted *automatic smoke-and-heat vents* complying with **Specification E2.2c**, in a single *storey* building or the top *storey* of a multi *storey* building.

OTHER ASSEMBLY BUILDINGS

- (a) Unless otherwise described in (b), in a building or part of a building used as an *assembly building* (not being a night club, discotheque or the like; or an exhibition hall, museum or art gallery) where the *floor area* of a *fire compartment* is more than 2000 m², the *fire compartment* must be provided with—
 - (i) an *automatic* smoke exhaust system complying with **Specification E2.2b**; or
 - (ii) roof mounted *automatic smoke-and-heat vents* complying with **Specification E2.2c**, in a single *storey* building or the top *storey* of a multi *storey* building; or
 - (iii) if the *floor area* of the *fire compartment* is not more than 5000 m² and the building has a *rise in storeys* of not more than 2—
 - (A) an *automatic* smoke detection and alarm system complying with **Specification E2.2a**; or
 - (B) a sprinkler system complying with **Specification E1.5**.
- (b) The following buildings are exempt from the provisions of (a):
 - (i) Sporting complexes, (including sports halls, gymnasiums, *swimming pools*, ice and roller rinks, and the like) other than indoor sports stadiums with total spectator seating for more than 1000 persons.
 - (ii) Churches and other places used solely for religious worship.
 - (iii) *School* classrooms.

Note: Smoke hazard management provisions for an *assembly building* used for multiple purposes must comply with all the relevant provisions of **NSW Table E2.2b** according to usage.

NSW Specification E2.2a SMOKE DETECTORS AND ALARM SYSTEMS

Delete Clause 7(e) as follows:

7. System Monitoring

(e) (deleted)

PART E4 EMERGENCY LIGHTING, EXIT SIGNS AND WARNING SYSTEMS

Delete E4.6 and insert NSW E4.6 as follows:

NSW E4.6 Direction signs

If an *exit* is not readily apparent to persons occupying or visiting the building, then *exit* signs must be installed—

- (a) in appropriate positions in corridors, hallways, lobbies, foyers, auditoria, and the like, indicating the direction to a *required exit*; and
- (b) in a Class 9b building used as an *entertainment venue* — in any external egress path to a street where the *exit* does not open directly onto a street.

SECTION F HEALTH AND AMENITY

PART F2 SANITARY AND OTHER FACILITIES

Delete FF2.1(b) and replace with NSW FF2.1(b):

FUNCTIONAL STATEMENTS

NSW FF2.1

(b) (deleted)

Note.

Paragraph (b) of this Functional Statement is deleted from the BCA in NSW, as the installation of hot water, warm water and cooling water systems (and their operation and maintenance) is regulated in the Public Health (Microbial Control) Regulation, 2000, as amended by the Public Health (Microbial Control) Amendment (Miscellaneous) Regulation, 2003, under the Public Health Act, 1991.

Delete FP2.6 (and Limitation) and replace with NSW FP2.6:

PERFORMANCE REQUIREMENTS

NSW FP2.6

(deleted).

Note.

This Performance Requirement is deleted from the BCA in NSW, as the installation of hot water, warm water and cooling water systems (and their operation and maintenance) is regulated in the Public Health (Microbial Control) Regulation, 2000, as amended by the Public Health (Microbial Control) Amendment (Miscellaneous) Regulation, 2003, under the Public Health Act, 1991.

Delete F2.7:

NSW F2.7 Microbial (legionella) control

(deleted).

Note.

This clause is deleted from the BCA in NSW, as the installation of hot water, warm water and cooling water systems (and their operation and maintenance) is regulated in the Public Health (Microbial Control) Regulation, 2000, as amended by the Public Health (Microbial Control) Amendment (Miscellaneous) Regulation, 2003, under the Public Health Act, 1991.

PART F4 LIGHT AND VENTILATION

Delete F4.5(b) and insert NSW F4.5(b) as follows:

NSW F4.5 Ventilation of rooms

(b) a mechanical ventilation or air-conditioning system complying with AS 1668.2.

Note.

The reference to AS/NZS 3666.1 is deleted from the BCA in NSW, as the need to comply with this standard is regulated in the Public Health (Microbial Control) Regulation, 2000, as amended by the Public Health (Microbial Control) Amendment (Miscellaneous) Regulation, 2003, under the Public Health Act, 1991.

SECTION G ANCILLARY PROVISIONS

PART G1 MINOR STRUCTURES AND COMPONENTS

Add NSW G1.101 as follows:

NSW G1.101 Provision for cleaning windows

- (a) A building must provide for a safe manner of cleaning any *windows* located 3 or more *storeys* above ground level.
- (b) A building satisfies (a) where—

- (i) the *windows* can be cleaned wholly from within the building; or
- (ii) provision is made for the cleaning of the *windows* by a method complying with the Occupational Health and Safety Act 2000 and regulations made under that Act.

PART G5 CONSTRUCTION IN BUSHFIRE PRONE AREAS

Delete GO5 and insert NSW GO5 as follows:

OBJECTIVE

NSW GO5

The *Objective* of this Part is to—

- (a) safeguard occupants from injury; and
- (b) protect buildings,

from the effects of bushfire.

Application

NSW GO5 only applies to a Class 2 or 3 building, a Class 4 part of a building, or a Class 9 building that is a *special fire protection purpose*.

Delete GF5.1 and insert NSW GF5.1 as follows:

FUNCTIONAL STATEMENT

NSW GF5.1

A building constructed in a *designated bushfire prone area* is to provide a resistance to bushfire in order to reduce the danger to life and minimise the risk of the loss of the building.

Application

NSW GF5.1 only applies to a Class 2 or 3 building, a Class 4 part of a building, or a Class 9 building that is a *special fire protection purpose*.

Delete GP5.1 and insert NSW GP5.1 as follows:

PERFORMANCE REQUIREMENT

NSW GP5.1

A building that is constructed in a *designated bushfire prone area* must be designed and constructed to reduce the risk of ignition from a bushfire while the fire front passes.

Application

NSW GP5.1 only applies to a Class 2 or 3 building, a Class 4 part of a building, or a Class 9 building that is a *special fire protection purpose*.

Delete G5.2 and insert NSW G5.2 as follows:

NSW G5.2 Protection

A Class 2 building, a Class 3 building, a Class 4 part of a building or a Class 9 building that is a *special fire protection purpose* in a *designated bushfire prone area* must comply with the following:

- (a) AS 3959 except for Section 2 "Site Bushfire Attack Assessment" which is replaced by the site assessment methodology of Appendix 3 of Planning for Bushfire Protection; or
- (b) the requirements of (a) above as modified by the development consent following consultation with the NSW Rural Fire Service under section 79BA of the Environmental Planning and Assessment Act 1979; or
- (c) the requirements of (a) above as modified by development consent with a bushfire safety authority issued under section 100B of the Rural Fires Act 1997 for the purposes of integrated development.

SECTION H SPECIAL USE BUILDINGS

PART H1 THEATRES, STAGES AND PUBLIC HALLS

Delete H1.1 and insert NSW H1.1 as follows:

NSW H1.1 Application of Part

- (a) For a Class 9b building or part of a building that is not an *entertainment venue*—
 - (i) The *Deemed-to-Satisfy Provisions* of Part H1 apply to every enclosed Class 9b building or part of a building which—
 - (A) is a *school* assembly, church or community hall with a *stage* and any *backstage* area with a total *floor area* of more than 300m²; or
 - (B) otherwise, has a *stage* and any *backstage* area with a total *floor area* of more than 200m²; or
 - (C) has a *stage* with an associated rigging loft.
 - (ii) Notwithstanding (a)(i)—
 - (A) **H1.4** applies to every open or enclosed Class 9b building; and
 - (B) **H1.7** applies to every enclosed Class 9b building.

- (b) For a Class 9b building that is an *entertainment venue*, **NSW Part H101**, as follows, applies in replacement of Part H1:

NSW PART H101 PLACES OF PUBLIC ENTERTAINMENT OTHER THAN TEMPORARY STRUCTURES AND DRIVE-IN THEATRES

Note.

NSW Part H101 contains *Deemed-to-Satisfy Provisions* additional to those contained in **Sections C, D, E, F and G** for buildings containing or used as places of public entertainment other than temporary structures and drive-in theatres.

NSW H101.1 Application of Part

- (a) This Part applies to every *entertainment venue* as described in the Environmental Planning and Assessment Regulation 2000.
- (b) A reference to a theatre, *stage* or public hall in the BCA is a reference to an *entertainment venue* as defined in **NSW A1.1**.

NSW H101.2 Fire separation

If an *entertainment venue* forms part only of a building, then—

- (a) the whole of the *entertainment venue*; or
- (b) the part containing the *stage*, *backstage* area and *auditorium*,

must be separated from the other parts of the building by construction having an FRL of not less than 60/60/60.

NSW H101.3 Foyer space

Where an *entertainment venue* is used principally for the purpose of—

- (a) exhibiting *films*; or
- (b) conducting live *stage* productions,

foyer space (excluding stairways and concession areas) must be provided on the basis of at least 0.25 m² for each person that the *auditorium* accommodates.

NSW H101.4 Sprinkler systems for common foyers

In an *entertainment venue*, where multiple *auditoriums* have a foyer in common, the following applies—

- (a) If the foyer serves not more than 2 *auditoriums*; that foyer must be separated from any adjoining foyer by construction having an FRL of not less than 60/60/60.
- (b) If the foyer serves more than 2 *auditoriums*, a sprinkler system complying with **Specification E1.5** must be installed—
- (i) throughout the *storey* containing the foyer; and

- (ii) throughout each *storey* in the building below that *storey*.

NSW H101.5 Conventional stages

This clause applies to a conventional *stage*, that is, a *stage* which is separated from the *auditorium* by a proscenium wall incorporating a proscenium opening.

NSW H101.5.1 Extent of stage area

If a room or area is not separated from the remainder of a conventional *stage* by construction having an FRL of not less than 60/60/60, the room or area is, for the purposes of this Part, to be taken to form part of the *stage*.

NSW H101.5.2 Small stages

A *stage* which is more than 50 m² but not more than 150 m² in area must have 2 or more means of egress from the *stage* and *backstage* area provided otherwise than through the proscenium wall.

NSW H101.5.3 Large stages

A *stage* which is more than 150 m² in area—

- (a) must have installed directly above the *stage* a suitable sprinkler system complying with **Specification E1.5**; and
- (b) must have the proscenium opening protected by a safety curtain that complies with **NSW H101.10**; and
- (c) must have a line of open drenchers or open sprinklers provided above the proscenium opening on the *stage* side and in such a position as to be able to discharge over the inside face of the safety curtain; and
- (d) must have 2 or more means of egress from the *stage* and *backstage* area provided otherwise than through the proscenium wall.

NSW H101.5.4 Fire separation of stages

A *stage* which is more than 50 m² in area, and all areas below such a *stage*, must (with the exception of the proscenium opening) be separated from the *backstage* and the remainder of the building by construction having an FRL of not less than 60/60/60.

NSW H101.6 Non-conventional stages

This clause applies to a *stage* that is not a conventional *stage* within the meaning of **NSW H101.5**.

NSW H101.6.1 Small stages

A *stage* which is more than 50 m² but not more than 150 m² in area must have at least 2 means of egress from the *backstage* area.

NSW H101.6.2 Large stages

A *stage* which is more than 150 m² in area must have at least 2 means of egress from the *backstage* area.

NSW H101.7 Flying scenery

Where there is a *grid* or other means of *flying scenery* over—

- (a) a conventional *stage* or non-conventional *stage*—
 - (i) the *stage* must be provided with a sprinkler system complying with **Specification E1.5**; and
 - (ii) a fly gallery, bridge *grid*, rigging loft, tie gallery or electric light perch must—
 - (A) comply with AS 1657; and
 - (B) be of *non-combustible* construction;
 - (iii) a fly gallery must be provided with at least 2 means of egress, one on each side of the *stage*;
 - (iv) a *grid* or rigging loft must be provided with at least 2 means of egress;
 - (v) if exposed steel is used in the construction of a roof, fly or tie gallery, the roof, fly or tie gallery must be so designed that, in the event of its structural failure due to fire, the wall structure of the building will not be affected.
 - (vi) structural steel supporting the *stage* tower must be enclosed by masonry or concrete and have an FRL of not less than 120/120/120; and
- (b) in the case of a conventional *stage*, the following additional requirements apply:
 - (i) The proscenium wall must—
 - (A) have an FRL of not less than 120/120/120; and
 - (B) have the proscenium opening protected by a rigid safety curtain in accordance with **NSW H101.10.1**;
 - (ii) the walls forming the *stage* area, and the area beneath the *stage*, must be constructed of masonry or concrete and have an FRL of not less than 120/120/120.

NSW H101.8 Load notice

A notice indicating the actual distributed and concentrated load for which the *stage* floor has been designed must be conspicuously and permanently displayed in a position adjacent to the *stage* floor.

This notice must be in legible letters and figures—

- (a) at least 50 mm high; and
- (b) on a contrasting background.

NSW H101.9 * * * * *

This clause has been deliberately left blank.

NSW H101.10 Safety curtains

A safety curtain *required* by **NSW H101.5.3** must—

- (a) be made of *non-combustible* material; and

- (b) be so fitted that, when it is closed, it forms an efficient smoke seal between the *stage* and the *auditorium*; and
- (c) be capable of withstanding a pressure differential of 0.5 kPa over its entire surface area; and
- (d) be run on steel guides located on each side of the proscenium opening; and
- (e) remain engaged in its guides if the guides, together with their fittings and attachments and that part of the curtain engaged in the guides, are subjected to a pressure differential of 1 kPa; and
- (f) be of sufficiently robust construction to withstand damage by scenery, *stage* properties and falling debris; and
- (g) be capable of closing the proscenium opening within 30 seconds, either by gravity slide or by motor assisted mechanisms; and
- (h) have manual controls, located on each side of the *stage*, for the closing of the curtains; and
- (i) have a notice displayed adjacent to the operating controls, in clear and legible letters and symbols of adequate size, indicating its use and operation; and
- (j) when operated, actuate a distinctive warning alarm audible to persons on the *stage* and must not be reliant for its operation solely on the primary electricity supply; and
- (k) have the words “Safety Curtain” exhibited on the curtain in clear and legible letters of adequate size to enable them to be read from all parts of the *auditorium*.

NSW H101.10.1 Safety curtains—Additional requirements

A rigid safety curtain *required* by **NSW H101.7** must comply with the requirements of **NSW H101.10** and it must—

- (a) be vertically hung from steel cables;
- (b) be framed with structural steel that complies with AS 4100;
- (c) be sheeted and finished on both faces with sheet steel or other *non-combustible* material of such gauge, and so fastened to its frame, as to ensure that its frame is capable of withstanding distortion arising from heat; and
- (d) when closed, overlap the proscenium opening by not less than 300 mm at each side and by not less than 600 mm at the top.

NSW H101.11 Seating in rows

This clause does not apply to *continental seating* or seating at tables.

NSW H101.11.1 Number of seats

Subject to **NSW H101.11.5**, where seating is arranged in *rows*, the maximum of seats in each *row* must not exceed—

- (a) 8 where there is an *aisle* at one end only of the *row*; or
- (b) 16 where there are *aisles* on both ends of the *row*.

NSW H101.11.2 Chairs used for seating

Chairs used for seating must—

- (a) where they have arms, be at least 500 mm from centre to centre; and
- (b) where they do not have arms, be at least 450 mm from centre to centre; and
- (c) have a *minimum lateral clearance* of at least 300 mm between—
 - (i) the front of each chair and the back of the chair in front; or
 - (ii) if a guardrail is provided in front of the chairs, between the front of each chair and the guardrail; and
- (d) have a distance of at least 950 mm between the back of each chair and the back of the chair in front.

NSW H101.11.3 Chairs in auditoriums—Level floors

Chairs in an *auditorium* that has a level floor must be—

- (a) securely fastened to the floor; or
- (b) secured together in groups of not less than 4 and not more than 16.

NSW H101.11.4 Chairs in auditoriums—Sloping floors

Chairs in an *auditorium* having a sloping floor, or having stepped or inclined platforms, must be securely fastened to the floor or platform.

NSW H101.11.5 Radiating aisles in seating areas

Where seating is securely fastened to the floor and arranged in *rows* of concentric circles, semi-circles or segments of circles, with radiating *aisles*—

- (a) the number of seats in each row between 2 *aisles* must not exceed 24; and
- (b) each seat must—
 - (i) have a *minimum lateral clearance* of at least 325 mm between the front of the seat and the back of the seat in front; and
 - (ii) have a distance of at least 975 mm between the back of the seat and the back of the seat in front; and
- (c) the *rows* may be curved or straight.

NSW H101.11.6 Aisles and cross-overs

Where *aisles* and *cross-overs* are provided—

- (a) each *aisle* must have a width of at least 1000 mm and each *cross-over* must have a width of at least 1500 mm; and
- (b) the floor of each *aisle* must not have a grade of more than 1 in 8 at any part; and
- (c) if there is a step from a *row* to an *aisle* or from a landing to an *aisle*, the step must not project into the *aisle*.

NSW H101.11.7 Platforms and steps

Where an *aisle* contains platforms or steps—

- (a) the platforms and steps must extend for the full width of the *aisle*; and

- (b) if there are no intervening steps between levels of platforms, the height of the platform riser must not be more than 200 mm; and
- (c) if there are one or more intervening steps between levels of platforms—
 - (i) each riser must be at least 100 mm but not more than 200 mm high; and
 - (ii) each going must be at least 250 mm deep; and
 - (iii) risers and goings must be uniform; and
- (d) goings which are more than 450 mm deep at platform level must not have a grade of more than 1 in 50; and
- (e) at the entrance from the *aisle* to each *row* there must be a clear level floor space, extending the full width of the *aisle*, of at least 300 mm, measured from the back of the *row* in front; and
- (f) any going projecting in front of a seat adjacent to an *aisle* must be protected by a guardrail.

NSW H101.11.8 Stepped platforms

Where stepped platforms without chairs or stepped platforms with bench seats, are used for seating—

- (a) each platform must be at least 700 mm deep; and
- (b) each seating space must be at least 450 mm wide, measured along the front of the platform or bench seat; and
- (c) each seating space must be numbered consecutively; and
- (d) at the entrance from the *aisle* to each *row* there must be a clear level floor space, extending the full width of the *aisle*, of at least 300 mm, measured from the back of the *row* in front; and
- (e) any going projecting in front of a seat adjacent to an *aisle* must be protected by a guardrail; and
- (f) in the case of stepped platforms with bench seats, there must be at least 300 mm between the back of each seat and the front of the platform behind, or the front of the bench seat behind, whichever is the closer.

NSW H101.12 Continental seating

This Clause applies to *continental seating*.

NSW H101.12.1 Seating to be fastened

Seating must be securely fastened to the floor.

NSW H101.12.2 Maximum seats per row

The number of seats in a *row* must not exceed 120.

NSW H101.12.3 Depths of seating rows

The depth of each *row* of seating (that is, the distance between the back of the *row* in front or, if there is a guardrail in front, between the back of the *row* and the guardrail) must, in respect of a

row containing a number of seats specified in Column 1 of **Table H101.12** be not less than the distance specified in Column 2 of that Table in respect of that number of seats.

NSW H101.12.4 Clearance between rows

The *minimum lateral clearance* between each *row* of seating must, in respect of a *row* containing a number of seats specified in Column 1 of **Table H101.12** be not less than the clearance specified in Column 3 of that Table in respect of that number of seats.

NSW H101.12.5 Chairs used for seating

Chairs used for seating must comply with **NSW H101.11.2(a)** and **(b)**.

NSW H101.12.6 Egress Doorways

Egress doorways through the walls of the *auditorium*—

- (a) must have an aggregate width of at least twice the sum of the clearances specified in Column 3 of **Table H101.12** for each *row* of the *auditorium* to be served by those doorways; and
- (b) must be provided at each end of every fifth *row*, excluding the first 2 *rows* and the last 2 *rows* in the *auditorium* if those *rows* each contain no more than 16 seats; and
- (c) must lead—
 - (i) directly to a road or *open space*; or
 - (ii) into a foyer or other area giving access to a road or *open space*; and
- (d) must be provided with *exit* signs if the egress doorways are not sufficiently conspicuous.

NSW H101.12.7 Clear Areas

A clear area—

- (a) must be provided from each end of each *row* to an egress doorway in the wall of the *auditorium*; and
- (b) must have a width of at least—
 - (i) the sum of the clearances specified in Column 3 of **Table H101.12** for each such *row*; or
 - (ii) 500 mm, whichever is the greater; and
- (c) if it contains platforms or steps, must comply with **NSW H101.11.7(a)**, **(b)**, **(c)**, **(d)** and **(f)**.

NSW H101.12.8 Minimum clear space

At the entrance from a *row* to a clear area, there must be a clear level floor space having a width of at least the clearance specified for the *row* in Column 3 of **Table H101.12**.

NSW H101.12.9 Doors

A door fitted to the egress doorway in the wall of an *auditorium* must comply with **NSW D2.15** and **NSW D2.19**.

Table H101.12 SPACING OF AUDITORIUM SEATING

Column 1 Number of seats in <i>Rows</i>	Column 2 Depth of <i>Rows</i> (mm)	Column 3 Clearance between <i>Rows</i> (mm)
Not exceeding 16	950	300
17 - 30	975	325
31 - 45	1000	350
46 - 60	1025	375
61 - 75	1050	400
76 - 90	1075	425
91 - 105	1100	450
106 - 120	1125	475

NSW H101.13 Provision of guardrails

NSW H101.13.1 Location

Guardrails must be provided—

- (a) along the fascia of each balcony or box;
- (b) if there is a stepped floor, along the front edge of each *cross-over*; and
- (c) where **NSW H101.13.2** and **NSW H101.13.3** apply.

NSW H101.13.2 Fixed back seats

If seats with fixed backs are provided, guardrails that extend for the full width of the seating, must be provided at least 500 mm above the platform unless—

- (a) fixed seat backs of the next lower level project at least 500 mm above the level of the stepped platform; and
- (b) there is only one riser between the platform and the next lower *cross-over*.

NSW H101.13.3 Steps between platforms

If—

- (a) there is more than one intervening step in an *aisle* between levels of platforms, a guardrail must be provided (at a vertical height of at least 660 mm measured above the nosing of each tread and of the upper platform) to the sides of the *aisle* adjacent to those steps; and
- (b) there is more than one intervening step in an *aisle* between levels of platforms, and that *aisle* is along a wall, a continuous guardrail must be affixed to that wall at a height of at least 865 mm above the nosing of each tread; and
- (c) the end of a platform or the back of the highest platform does not abut a wall that extends at least 660 mm above the floor level of the platform, a guard rail not less than 660 mm high must be provided—

- (i) at the ends of the platform, extending from the front of the first riser to the back of the highest platform; and
- (ii) at the back of the highest platform, extending the full width of the platform; and
- (d) there is an inclined floor, the raised section of which is not bounded by walls at least 660 mm high, a guard rail must be provided that extends around the perimeter of the raised section at a height of at least 660 mm above the inclined floor level; and
- (e) seating at tables is provided on a stepped platform, a guardrail at least 500 mm high must be provided along the front edge of the platform.

NSW H101.14 Guardrails

This clause applies to seating areas.

NSW H101.14.1 Continental seating

Where a guardrail is provided in front of a *row* of chairs—

- (a) the distance between the back of each chair in that *row*, and the guardrail must be not less than the distance specified in Column 2 of **Table H101.12** for the number of chairs in that *row*;
- (b) the *minimum lateral clearance* between the front of each chair in that *row* and the guardrail must be not less than the clearance specified in Column 3 of **Table H101.12** for the number of chairs in that *row*.

NSW H101.14.2 Balconies and boxes

A guardrail provided along the fascia of a balcony or box—

- (a) if it is located at the foot of a stepped *aisle*, must have its top surface at least 900 mm above the floor of the balcony or box; and
- (b) if it is not located at the foot of a stepped *aisle*, must have its top surface at least 750 mm above the floor; and
- (c) if it has a ledge more than 70 mm wide, must have the top surface of the ledge sloping downwards towards the floor of the balcony or box at an angle of at least 30 degrees from the horizontal; and
- (d) must have an unperforated kerb or toe guard extending for at least 300 mm above the floor.

NSW H101.14.3 Cross-overs

A guardrail provided along the front edge of a cross-over on a stepped floor—

- (a) must be at least 750 mm high; and
- (b) must extend for the full distance between *aisles*, or between a wall and an *aisle*, or for such other distance as considered necessary.

NSW H101.15 Dressing rooms

A dressing room or 2 or more adjoining dressing rooms, having a total *floor area* of more than 50 m², must—

- (a) be separated from other parts of the building by construction having an FRL of not less than 60/60/60;
- (b) have at least 2 means of egress as remote from each other as possible, one of which must discharge—
 - (i) directly to a road or *open space*; or
 - (ii) through a fire-isolated *exit* to a road or *open space*.

NSW H101.16 Storerooms

A storeroom must be separated from other parts of the building by construction having an FRL of not less than 60/60/60.

NSW H101.17 Projection suites

- (a) This clause applies to *projection suites*.
- (b) A *projection suite* must be provided in an *entertainment venue* intended to be used for the showing of *films*.

NSW H101.17.1 Rooms to be provided

A *projection suite* in accordance with the staffing requirements of Schedule 3A of the Environmental Planning and Assessment Regulation 2000 must contain either—

- (a) a projection room and sanitary accommodation comprising at least 1 closet pan and 1 washbasin, where the *projection suite* is continually staffed; or
- (b) a projection room fitted with the following equipment—
 - (i) an *automatic* fire suppression system in accordance with SSL Appraisal Specification FAS 102 or a sprinkler system complying with AS 2118; and
 - (ii) a smoke detection system which will—
 - (A) comply with AS 1670.1 except for the provisions of Clause 3.26(f) - location where detectors not *required*; and
 - (B) be connected to a fire station or other approved monitoring service where arrangements are in place to initiate *fire brigade* response; and
 - (C) close down all shutters fitted to projection or observation ports; and
 - (D) activate sufficient general lighting to provide a minimum of 40 lux measured at floor level in any *auditorium* affected; and
 - (E) operate a public address system to automatically announce a suitable message from the management of the premises; and
 - (F) activate an audible alarm to immediately indicate to management the presence of smoke in the projection room.

NSW H101.17.2 Fire separation

A *projection suite* must be separated from all other internal parts of the building in which it is located by construction having an FRL of not less than 60/60/60.

NSW H101.17.3 Concession for protection of some openings

If a projection or observation port is not more than 0.1 m² in area—

- (a) a metal shutter not less than 1.5 mm thick may be fitted thereto instead of the protection *required* under **NSW C3.11**; and
- (b) any metal shutter or protection system provided must be equipped with a device to permit the closing of the shutter or protection system from easily accessible operating positions adjacent to each egress doorway from the projection room.

NSW H101.18 Basement storeys

Where an *entertainment venue* includes not more than 2 basement *storeys*—

- (a) all *required exits* from the basement must be enclosed in *non-combustible* construction, with the exception of the main entry or *exit*; and
- (b) any *auditorium* and other public areas in the basement must be equipped with an air-handling system that complies with AS 1668.2.

NSW H101.18.1 Basement storeys — More than two

If the *entertainment venue* includes more than 2 basement *storeys*—

- (a) the construction must be of at least Type B; and
- (b) all *required exits* from the basement must be enclosed in a *fire-resisting shaft* having an FRL as *required* by the relevant Type of construction; and
- (c) the building must be equipped with a sprinkler system complying with **Specification E1.5**.

NSW H101.19 Electric mains installation

NSW H101.19.1 Main switchboard

The switchboard containing the main isolation switch must—

- (a) be located in a position that is readily accessible to authorised persons, and to the *Fire Brigade* in the case of an emergency; and
- (b) be enclosed by construction having an FRL not less than 60/60/60.

NSW H101.19.2 Circuit protection

Protection of a final sub-circuit originating at a switchboard or distribution board must be by means of circuit breakers.

NSW H101.19.3 Separate sub-mains

Where an *entertainment venue* has its mains supply in common with that of another building or where it is a part of a building—

- (a) the *entertainment venue* must be served by a separate and independent sub-main from the main switchboard; and
- (b) each such sub-main, the consumer's main and the supply authority's conductors within the building must be protected against fire by means of—

- (i) mineral-insulated metal-sheathed cables or other cables that provide at least 2 hours' fire protection; or
- (ii) heavy-duty PVC conduit or metallic pipe, concrete encased in walls or slabs with a minimum of 50 mm cover; or
- (iii) heavy-duty PVC conduit or metallic pipe, buried at least 500 mm below ground level, for underground cabling.

NSW H101.20 Lighting

NSW H101.20.1 Lighting switches

- (a) Any switch controlling the lighting system must not be accessible.
- (b) Where, during normal use, general lighting may be dimmed or switched off, an override switch to switch on all the general lighting instantaneously must be installed in the *auditorium* in a position accessible to management.

NSW H101.20.2 Lighting levels

Where the lamps utilised in the general lighting are of a type that will not relight immediately after the restoration of the primary electricity supply to those lamps—

- (a) a time delay or other suitable means must be provided to maintain the emergency lighting for a period not less than that necessary to allow the general lighting lamps to restrike; or
- (b) lamps of a type that will provide immediate lighting must be installed and—
 - (i) arranged in such a manner as to ensure visual conditions not inferior to those *required* to be provided by the emergency lighting; and
 - (ii) capable of being switched in common with the general lighting and of being controlled also by the override switch *required* by **NSW H101.20.1(b)**.

NSW H101.20.3 Provision of aisle lighting

Where general lighting is to be either dimmed or extinguished when the public is in attendance and where the floor is stepped or at an inclination greater than 1 in 12, *aisle* lights must be provided to illuminate the length of each *aisle* and the tread of each step therein.

NSW H101.20.4 Aisle lighting power supply

Where an *aisle* light is installed in a seat frame, it must be supplied at a voltage of not more than 32 volts AC or 115 volts DC.

NSW H101.20.5 Aisle lighting alternative power supply

Aisle lighting must be provided with an alternative electricity supply that—

- (a) is capable of being *automatically* energised in the event of failure of the primary lighting electricity supply; and
- (b) complies with the provisions applying to emergency lighting.

NSW H101.21 * * * * *

This clause has deliberately been left blank.

NSW H101.22 Automatic smoke-and-heat vents for stages

An automatic *smoke-and-heat vent* system *required* by **NSW Table E2.2b** “*Stages* and *backstage*” must—

- (a) be capable of *automatic* operation by the inclusion of a heat sensing device designed to activate the system at a temperature of not more than 71°C; and
- (b) be capable of being released manually from positions at each side of the *stage* and of being fully activated from either position; and
- (c) have a notice, prominently displayed at each position referred to in **(b)**, clearly indicating the method of activation; and
- (d) have an openable area of not less than 1/10 of the total area of the *stage*.

NSW H101.23 Solid fuel burning stoves and open fire places.

Solid fuel burning stoves and open fire places must not be installed in premises designed for the purpose of—

- (a) exhibiting *films*; or
- (b) conducting live theatre productions.

NSW H101.24 Fuel gas cylinders

NSW H101.24.1 General

Fuel gas cylinders must—

- (a) be housed in an enclosure that is located outside the building; and
- (b) comply with the ventilation requirements of Clause 6.4.6 and 6.4.7 of AS/NZS 1596.

NSW H101.24.2 Fuel gas cylinder enclosures

An enclosure referred to in **NSW H101.24.1**—

- (a) must be located not less than 3 m from any *window*, door, vent or other opening; and
- (b) if located 3 m or more from a building must—
 - (i) have a concrete base; and
 - (ii) be constructed from heavy-gauge chain-wire mesh or other suitable material; and
 - (iii) be at least 1.8 m high; and
 - (iv) be so designed as to securely contain the fuel gas cylinders in a single line; and
 - (v) must be so designed as to allow cross ventilation; and
- (c) if located less than 3 m from a building must—
 - (i) have a concrete base; and
 - (ii) have 3 sides constructed from concrete or masonry; and
 - (iii) have a concrete roof; and
 - (iv) be so designed as to securely contain the fuel gas cylinders in a single line; and

- (v) have a hinged, heavy-gauge chain-wire door capable of being secured against unauthorised entry; and
- (vi) have its roof at least 600 mm above the uppermost fitting on any fuel gas cylinder housed therein.

NSW PART H102 TEMPORARY STRUCTURES

NSW H102.1 Application of Part

This Part applies to *temporary structures* used as *entertainment venues*.

NSW H102.2 Exits—Exclusions

In this clause, a reference to an entrance or *exit* does not include a reference to an entrance or *exit* provided for persons or animals performing in a *temporary structure*.

NSW H102.3 Location of exits

Exits must be so provided and arranged as to afford a ready means of egress from all parts of a *temporary structure*.

NSW H102.4 Exits to be provided

Without limiting the generality of **NSW H102.3**—

- (a) the number of *exits* to be provided for a *temporary structure* designed to accommodate a number of persons specified in Column 1 of **Table H102.4** must be not less than the number of *exits* specified in Column 2 of that Table in respect of that number of persons; and
- (b) the aggregate width of the *exits* to a *temporary structure* designed to accommodate a number of persons specified in Column 1 of **Table H102.4** must not be less than the width specified in Column 3 of that Table in respect of that number of persons.

NSW H102.5 Vertical clearances for exits

Every part of an entrance or *exit* must provide a minimum unobstructed height of 2000 mm and, where the entrance or *exit* is beneath a stepped seating platform, infilled risers or other approved overhead protection must be provided above the entrance or *exit*.

NSW H102.6 Curtains across exits

A flap or curtain used to cover an *exit* must be so designed that, when it is secured, it will not obstruct or impede egress.

NSW H102.7 Curtains and blinds

Curtains and blinds for use in a *temporary structure* must comply with **Clause 4 of NSW Specification C1.10**.

Table H102.4 NUMBER OF EXITS AND WIDTHS

Column 1 Accommodation provided	Column 2 Number of <i>exits required</i>	Column 3 Aggregate width of <i>exits</i>
1-25 persons	*1-2	1 000
26-50 persons	2	1 500
51-75 persons	2	2 000
76-100 persons	2	2 500
100-200 persons	2	3 000
201-400 persons	3	4 500
401-600 persons	4	6 000
601-800 persons	5	7 500
801-1000 persons	5	9 000
over 1000 persons	5 plus one additional <i>exit</i> for each additional 450 persons or part thereof.	9 000 plus 500 mm for each additional 50 persons or part thereof.
*Note:	(a) Where only one <i>exit</i> is provided that <i>exit</i> must be at least 1000 mm wide.	
	(b) Where 2 <i>exits</i> are provided each must be at least 500 mm wide.	

NSW H102.8 Fabrics

Fabric that is used in the construction of a *temporary structure* must have—

- (a) a *Flammability Index* of not more than 6 where used—
 - (i) within a height of 4 m of the base of the *temporary structure*; or
 - (ii) in an air-supported *temporary structure* without other supporting framework; and
- (b) a *Flammability Index* of not more than 25 in every other case.

NSW H102.9 Guardrails

A rigid guardrail must—

- (a) be provided at each end of a stepped or inclined platform, at least 750 mm high above the floor of the platform, and must extend—
 - (i) in the case of a stepped platform, from the front of the first riser; and
 - (ii) in the case of an inclined platform, from the front of the first *row* of seating, to the back of the highest platform and along the rear of that platform for its full width; and
- (b) not obstruct any *aisle*, *cross-over* or *exit*.

NSW H102.10 Seating

Seating must be provided in accordance with [NSW H101.11.1](#), [NSW H101.11.2](#), [NSW H101.11.3\(b\)](#), [NSW H101.11.5\(a\)](#), (c), [NSW H101.11.6\(a\)](#) and [NSW H101.11.8\(a\)](#), (b), (c) and (d).

NSW H102.11 Sanitary accommodation

Suitable sanitary accommodation must be provided at a location convenient to the *temporary structure*.

NSW H102.12 Projection suites

Any *projection suite* must comply with [NSW H101.17.2](#) and [NSW H101.17.3](#).

NSW H102.13 Fireplaces and heating

No fireplace or other form of heating equipment may be installed in a *temporary structure*, without the consent of the approval authority.

NSW H102.14 Electrical services

Electrical services connected to the local supply authority's mains, to a generating plant or to a battery supply must comply with—

- (a) the requirements of the local supply authority; and
- (b) AS 3002; and
- (c) where applicable, AS/NZS 3000; and
- (d) [NSW H101.19.1\(a\)](#) and [NSW H101.19.3\(a\)](#).

NSW H102.15 Artificial lighting

Artificial lighting must be provided, and must comply with [NSW H101.20.1](#) and [NSW H101.20.2](#).

NSW H102.15.1 Emergency lighting levels

Emergency lighting must be provided to the areas provided with artificial lighting under [NSW H102.15](#) and must include a sufficient number of lamps to give a minimum illumination of 0.2 lux at floor level.

NSW H102.15.2 Emergency lighting power supply

Where emergency lighting is provided, the capacity of the battery and charging system must be sufficient to provide the illumination *required* by [NSW H102.15.1](#) for—

- (a) half an hour, in respect of a *temporary structure* designed to accommodate not more than 1000 persons; and
- (b) 1 hour, in respect of a *temporary structure* designed to accommodate more than 1000 persons.

NSW H102.16 Exit signs

Exit signs must be provided above all *exits* and in such other locations as may be *required* by [NSW E4.6](#) and must comply with [E4.5](#) and [E4.8](#).

NSW H102.17 Fire-fighting services

- (a) Fire-fighting services and appliances must be so provided as to afford adequate protection and must be so located as the approving authority, on the advice of the Director-General of New South Wales Fire Brigades, may require.
- (b) Where *required* by the approving authority, the fire-fighting services and appliances must comply with [Part E1](#).

NSW PART H103 DRIVE-IN THEATRES

NSW H103.1 Application of Part

This Part applies to drive-in theatres.

NSW H103.2 Speaker standards

Speaker standards must—

- (a) be placed at a minimum of 5.5 m centres in a line along each parking ramp; and
- (b) be capable of being illuminated throughout any performance so as to be easily distinguishable at all times.

NSW H103.2.1 Lines of speaker standards

Lines of speaker standards along parking ramps must be placed at a distance of not less than 12.2 m apart.

NSW H103.3 Electrical services

The following electrical services must be installed underground—

- (a) the supply authority's conductors within the site and the consumer's mains, unless otherwise approved; and
- (b) electrical wiring external to any building on the site; and
- (c) all wiring to the speaker standards.

NSW H103.4 Vehicular entrances

Each public vehicular entrance to or exit from the drive-in theatre must be capable of being fully illuminated by flood lights that are so placed and so focussed as not to interfere with the vision of the driver of any motor vehicle.

NSW H103.5 Lighting

- (a) Driveways — Entrance and exit driveways, and the perimeter of the holding area, must be capable of being continuously illuminated by lamps capable of producing a minimum illumination of 0.5 lux at ground level.
- (b) Ramp areas — The whole of the ramp area of a drive-in theatre must be capable of being floodlit by means of area flood lights to an illumination of at least 10 lux.

SECTION I MAINTENANCE

PART I1 EQUIPMENT AND SAFETY INSTALLATIONS

Delete I1.1 and insert NSW I1.1 as follows:

NSW I1.1 Essential fire safety measures

Essential fire or other safety measures must be maintained and certified on an ongoing basis, in accordance with the provisions of the Environmental Planning and Assessment Regulation, 2000.

Delete I1.2:

NSW I1.2 Mechanical ventilation and hot water, warm water and cooling water systems

(deleted).

Note.

This clause is deleted from the BCA in NSW, as the maintenance of mechanical ventilation and hot water, warm water and cooling water systems, for the purposes of public health, is regulated in the Public Health (Microbial Control) Regulation, 2000, as amended by the Public Health (Microbial Control) Amendment (Miscellaneous) Regulation, 2003, under the Public Health Act, 1991.

PART I2 ENERGY EFFICIENCY INSTALLATIONS

Delete BCA PART I2 and insert the following:

NSW PART I2 Energy Efficiency Installations

(deleted)

NSW SECTION J ENERGY EFFICIENCY

Replace Section J with NSW Section J as follows:

Note 1.

NSW Section J consists of two Subsections J(A) and J(B).

NSW Subsection J(A) Energy Efficiency - Class 2 buildings and Class 4 parts

This Subsection contains energy efficiency requirements for Class 2 buildings and Class 4 parts of buildings.

The need for separating these requirements from the requirements for Class 3 buildings arises because, in NSW, Class 2 buildings and Class 4 parts of buildings are subject to BASIX (the Building Sustainability Index), however Class 3 buildings are not.

BASIX is the web-based planning tool designed to assess the potential performance of certain residential buildings against a range of sustainability indices including thermal comfort and energy. Commitments made under BASIX become a condition of the relevant development consent or complying development certificate.

BASIX applies in NSW to all new Class 1 and 2 buildings, and Class 4 parts of buildings; and to alterations and additions to buildings of those classes where the work is subject to BASIX and also where an applicant elects to comply with BASIX.

The provisions of NSW Subsection J(A) are therefore designed to complement requirements that arise under BASIX and which are implemented via the development consent. Where BASIX is not applied to alterations and additions to Class 1 and 2 buildings, and Class 4 parts of buildings, these provisions will also compliment council development controls that require energy efficiency measures to be incorporated as part of the alterations and additions.

NSW Subsection J(B) Energy Efficiency - Class 3 and Class 5 to 9 buildings

This subsection contains energy efficiency requirements for Class 3 and Class 5 to 9 buildings.

As Class 3 and Class 5 to 9 buildings are not subject to BASIX, NSW Subsection J(B) applies the provisions of the national Section J relevant to Class 3 and Class 5 to 9 buildings, with minor variations.

Note 2.

All definitions in Part A1 that are applicable to the national Section J are also applicable to NSW Section J.

NSW SUBSECTION J(A) ENERGY EFFICIENCY - CLASS 2 BUILDINGS AND CLASS 4 PARTS

OBJECTIVE

NSW J(A)O1

The *Objective* of this Section is to reduce greenhouse gas emissions by efficiently using energy.

Application:

NSW J(A)O1 only applies to a Class 2 building and Class 4 part of a building.

FUNCTIONAL STATEMENT

NSW J(A)F1

A building, including its services, is to be capable of efficiently using energy.

Application:

NSW J(A)F1 only applies to a Class 2 building and Class 4 part of a building.

PERFORMANCE REQUIREMENT

NSW J(A)P1

- (a) Thermal insulation in a building must be installed in a manner and have characteristics, which facilitate the efficient use of energy for artificial heating and cooling.
- (b) A building must have, to the degree necessary, thermal breaks installed between the framing and external cladding, to facilitate efficient thermal performance of the building envelope.

Application:

- (a) NSW J(A)P1(a) only applies to thermal insulation in a Class 2 building or Class 4 part of a building where a development consent specifies that the insulation is to be provided as part of the development.
- (b) In (a), the term development consent has the meaning given by the Environmental Planning and Assessment Act 1979.
- (c) NSW J(A)P1(b) only applies to a metal framed roof and a metal framed wall.

NSW J(A)P2

A building must have, to the degree necessary, a level of building sealing against air leakage to facilitate the efficient use of energy for artificial heating and cooling appropriate to—

- (a) the function and use of the building; and
- (b) the internal environment; and
- (c) the geographic location of the building.

Application:

NSW J(A)P2 only applies to a Class 2 building or Class 4 part of a building, except—

- (a) a building in *climate zones* 2 and 5 where the only means of *air-conditioning* is by using an evaporative cooler; and
- (b) a building *ventilation opening* that is necessary for the safe operation of a gas appliance; and
- (c) parts that cannot be fully enclosed

NSW J(A)P3

A building's *services* must have features that, to the degree necessary, facilitate the efficient use of energy appropriate to—

- (a) the function and use of the *service*; and
- (b) the internal environment; and
- (c) the geographic location of the building; and
- (d) the energy source of the *service*.

Application:

NSW J(A)P3 only applies to a Class 2 building or Class 4 part of a building.

NSW J(A)P4

A building, including its *services*, must have, to the degree necessary, features that facilitate the maintenance of systems and components appropriate to the function and use of the building.

Application:

NSW J(A)P4 only applies to a Class 2 building, except for a *sole-occupancy unit* in that building.

NSW PART J(A)1 BUILDING FABRIC

NSW J(A)1.0 Deemed-to-Satisfy Provisions

- (a) Where a *Building Solution* is proposed to comply with the *Deemed-to-Satisfy Provisions*, Performance Requirement **NSW J(A)P1** is satisfied by complying with **NSW J(A)1.1** and **NSW J(A)1.2**.
- (b) Where a *Building Solution* is proposed as an *Alternative Solution* to the *Deemed-to-Satisfy Provisions* of **NSW J(A)1.1** and **NSW J(A)1.2**, the relevant *Performance Requirements* must be determined in accordance with **A0.10**.

NSW J(A)1.1 Application of Part

- (a) The *Deemed-to-Satisfy Provisions* only apply to thermal insulation in a Class 2 building or Class 4 part of a building where a development consent or complying development certificate specifies that the insulation is to be provided as part of the development.
- (b) For alterations and additions, until 1 July 2006 when BASIX will apply, in addition to (a), the provision of insulation as part of the development may also be specified in an environmental planning instrument.
- (c) In (a) and (b), development consent, complying development certificate, environmental planning instrument, have the meaning given to these terms by the Environmental Planning and Assessment Act 1979.
- (d) The *Deemed-to-Satisfy* provisions of this Part for thermal breaks apply to all Class 2 buildings and Class 4 parts.

NSW J(A)1.2 Compliance with BCA provisions

- (a) Thermal insulation in Class 2 buildings and Class 4 parts of buildings must comply with the national BCA provisions of **J1.2 Thermal construction general**, except that the reference in **Clause J1.2** to "Where *required*", is deemed to refer to "Where a development consent specifies that insulation is to be provided as part of the development".
- (b) A thermal break must be provided between the external cladding and framing as follows -
 - (i) for a metal framed roof, in accordance with national BCA provisions of **J1.3(d)**; and
 - (ii) for a metal framed wall, in accordance with national BCA provisions of **J1.5(e)**

NSW PART J(A)2 BUILDING SEALING

NSW J(A)2.0 Deemed-to-Satisfy Provisions

- (a) Where a *Building Solution* is proposed to comply with the *Deemed-to-Satisfy Provisions, Performance Requirement NSW J(A)P2* is satisfied by complying with **NSW J(A)2.1** and **NSW J(A)2.2**.
- (b) Where a *Building Solution* is proposed as an *Alternative Solution* to the *Deemed-to-Satisfy Provisions* of **NSW J(A)2.1** and **NSW J(A)2.2**, the relevant *Performance Requirements* must be determined in accordance with **A0.10**.

NSW J(A)2.1 Application of Part

The *Deemed-to-Satisfy Provisions* of this Part apply to a Class 2 building and a Class 4 part of a building, but exclude—

- (a) a building in *climate zones* 2 and 5 where the only means of *air-conditioning* is by using an evaporative cooler; and
- (b) a building *ventilation opening* that is necessary for the safe operation of a gas appliance; and
- (c) parts of buildings that cannot be fully enclosed.

NSW J(A)2.2 Compliance with BCA provisions

Class 2 buildings and Class 4 parts of buildings must comply with the following national BCA provisions—

- (a) **J3.2** Chimneys and flues; and
- (b) **J3.3** Roof lights; and
- (c) **J3.4** External doors and windows; and
- (d) **J3.5** Exhaust fans; and
- (e) **J3.6** Construction of roofs, walls and floors; and
- (f) **J3.7** Evaporative coolers.

NSW PART J(A)3 AIR-CONDITIONING AND VENTILATING SYSTEMS

NSW J(A)3.0 Deemed-to-Satisfy Provisions

- (a) Where a *Building Solution* is proposed to comply with the *Deemed-to-Satisfy Provisions, Performance Requirement NSW J(A)P3* is satisfied by complying with **NSW J(A)3.1** and **NSW J(A)3.2**.
- (b) Where a *Building Solution* is proposed as an *Alternative Solution* to the *Deemed-to-Satisfy Provisions* of **NSW J(A)3.1** and **NSW J(A)3.2**, the relevant *Performance Requirements* must be determined in accordance with **A0.10**.

NSW J(A)3.1 Application of Part

The *Deemed-to-Satisfy Provisions* of this Part apply to a Class 2 building and a Class 4 part of a building.

NSW J(A)3.2 Compliance with BCA provisions

Class 2 buildings and Class 4 parts of buildings must comply with the following national BCA provisions, as applicable—

- (a) **J5.2** Air conditioning and ventilating systems; and
- (b) **J5.3** Time switch; and
- (c) **J5.4** Heating and cooling systems; and
- (d) **J5.5** Ancillary exhaust systems.

NSW PART J(A)4 HOT WATER SUPPLY

NSW J(A)4.0 Deemed-to-Satisfy Provisions

- (a) Where a *Building Solution* is proposed to comply with the *Deemed-to-Satisfy Provisions, Performance Requirement NSW J(A)P3* is satisfied by complying with **NSW J(A)4.1** and **NSW J(A)4.2**.
- (b) Where a *Building Solution* is proposed as an *Alternative Solution* to the *Deemed-to-Satisfy Provisions* of **NSW J(A)4.1** and **NSW J(A)4.2**, the relevant *Performance Requirements* must be determined in accordance with **A0.10**.

NSW J(A)4.1 Application of Part

The *Deemed-to-Satisfy Provisions* of this Part apply to a Class 2 building and a Class 4 part of a building.

NSW J(A)4.2 Compliance with BCA provisions

Class 2 buildings and Class 4 parts of buildings must comply with the national BCA provisions of **J7.2**.

NSW PART J(A)5 ACCESS FOR MAINTENANCE

NSW J(A)5.0 Deemed-to-Satisfy Provisions

- (a) Where a *Building Solution* is proposed to comply with the *Deemed-to-Satisfy Provisions, Performance Requirement NSW J(A)P4* is satisfied by complying with **NSW J(A)5.1** and **NSW J(A)5.2**.
- (b) Where a *Building Solution* is proposed as an *Alternative Solution* to the *Deemed-to-Satisfy Provisions* of **NSW J(A)5.1** and **NSW J(A)5.2**, the relevant *Performance Requirements* must be determined in accordance with **A0.10**.

NSW J(A)5.1 Application of Part

The *Deemed-to-Satisfy Provisions* of this Part apply to a Class 2 building except within a *sole-occupancy unit*.

NSW J(A)5.2 Access for maintenance

Access for maintenance must be provided to—

- (a) all *services* and their components, including—
 - (i) time switches and motion detectors; and
 - (ii) room temperature thermostats; and
 - (iii) plant thermostats such as on boilers or refrigeration units; and
 - (iv) outside air dampers; and
 - (v) reflectors, lenses and diffusers of light fittings; and
 - (vi) heat transfer equipment; and
- (b) adjustable or motorised shading devices.

NSW SUBSECTION J(B) ENERGY EFFICIENCY - CLASS 3 AND CLASS 5 TO 9 BUILDINGS

NSW J(B)1 Compliance with BCA provisions

Class 3 and Class 5 to 9 buildings must comply with all of the provisions of the national **Section J** that are applicable to the relevant classifications, except as varied by **NSW J1.6** for Class 3 buildings **NSW J3.1** and **NSW J8.2** for Class 3 and Class 5 to 9 buildings.

Delete J1.6(a) and substitute NSW J1.6(a) as follows:

NSW J1.6 Floors of Class 3 buildings

- (a) A suspended floor that is part of the building envelope of a Class 3 building -
 - (i) with an unenclosed perimeter, must achieve the *Total R-Value* specified in **NSW Table J1.6**;
 - (ii) with an enclosed perimeter, must achieve the *Total R-Value* specified in **NSW Table J1.6**;

- (iii) with an in-slab heating or cooling system, must be insulated under the slab and around the vertical edge of its perimeter with insulation having a minimum *R-Value* of not less than 1.0.

Note: Class 5 to 9 buildings must comply with national BCA provisions J1.6.

NSW Table J1.6 CLASS 3 BUILDINGS - SUSPENDED FLOOR FORMING PART OF BUILDING ENVELOPE - MINIMUM TOTAL R-VALUE

Class 3 buildings	<i>Climate Zone</i>			
	4	6	7	8
Unenclosed perimeter	0.9	0.9	0.9	2.5
Enclosed perimeter	0.9	0.9	0.9	1.5
Direction of heat flow	Downwards			

Add NSW J3.1(f) as follows:

NSW J3.1 Application of Part

- (f) parts of buildings that cannot be fully enclosed

Delete J8.2 and substitute NSW J8.2 as follows:

NSW J8.2 Access for maintenance

Access for maintenance must be provided to—

- (a) all *services* and their components, including—
 - (i) time switches and motion detectors; and
 - (ii) room temperature thermostats; and
 - (iii) plant thermostats such as on boilers or refrigeration units; and
 - (iv) outside air dampers; and
 - (v) reflectors, lenses and diffusers of light fittings; and
 - (vi) heat transfer equipment; and
- (b) adjustable or motorised shading devices.

Footnote: OTHER LEGISLATION AFFECTING BUILDINGS

In addition to any applicable provisions of the Environmental Planning and Assessment Act 1979, the Environmental Planning and Assessment Regulation 2000 and this Code, there is a variety of other regulatory provisions, including legislation, regulation and departmental policies that impose requirements affecting the design, construction and/or performance of buildings in NSW.

The following is a non-definitive list of such provisions. It does not include Commonwealth provisions that may apply in NSW, nor planning and environmental standards that may impose

building requirements in individual circumstances. It is meant as an indicative guide only and is not to be relied upon in any way as a substitute for further research, investigation and legal advice needed to determine building standards in individual circumstances.

1. Abattoirs, Knackeries and Meat Premises

1.1 Administering Agency

Department of Health

Relevant Legislation

Food Regulation 2004

2. Children's Services

2.1 Administering Agency

Department of Community Services

Relevant Legislation

Children's Services Regulation 2004

3. Crematoria, Vaults, Mortuary Churches etc.

3.1 Administering Agency

Department of Health

Relevant Legislation

Public Health (Disposal of Bodies) Regulation 2002

4. Crown Land — Construction Approval

4.1 Administering Agency

Department of Lands

Relevant Legislation

Crown Lands Act 1989

Crown Lands Regulation 2006

4.2 Administering Agency

Office of Emergency Services

Relevant Legislation

Rural Fires Act 1997

5. Dairies

5.1 Administering Agency

Department of Health

Relevant Legislation

Food Regulation 2004

6. Dangerous Goods (including Gas Installations)

6.1 Administering Agency

Department of Water and Energy

Relevant Legislation

Gas Supply Act 1996

Dangerous Goods (Gas Installations) Regulation 1998

6.2 Administering Agency

Workcover Authority

Relevant Legislation

Explosives Regulation 2005

Occupational Health and Safety Regulation 2001

7. Dining Rooms and Bars

7.1 Administering Agency

Department of Health

Relevant Legislation

Food Regulation 2004

8. Electrical Installations

8.1 Administering Agency

Department of Water and Energy

Relevant Legislation

Electricity (Consumer Safety) Regulation 2006

8.2 Administering Agency

Workcover Authority

Relevant Legislation

Occupational Health and Safety Regulation 2001

8.3 Administering Agency

Department of Energy, Utilities and Sustainability

Relevant Legislation

Electricity Supply (General) Regulation 2001

9. Fire Prevention in Existing Buildings

9.1 Administering Agency

Department of Planning

Relevant Legislation

Environmental Planning and Assessment Regulation 2000

10. Food Premises

10.1 Administering Agency

Department of Health

Relevant Legislation

Food Regulations 2004

11. Foundries

11.1 Administering Agency

Department of Water and Energy

Relevant Legislation

Gas Supply Act 1996

Dangerous Goods (Gas Installations) Regulation 1998

12. Historic Buildings

12.1 Administering Agency

Department of Planning

Relevant Legislation

Heritage Regulation 2005

13. Hospitals, Nursing Homes and Health Care Buildings

13.1 Administering Agency

Department of Health

Relevant Legislation

Day Procedure Centres Regulation 1996

Private Hospitals Regulation 1996

14. Hot Water Systems and Air Handling Systems

14.1 Administering Agency

Department of Health

Relevant Legislation

Public Health (Microbial Control) Regulation 2000

15. Lift Installations

15.1 Administering Agency

Workcover Authority

Relevant Legislation

Occupational Health and Safety Regulation 2001

16. Moveable Dwellings (in Caravan Parks)

16.1 Administering Agency

Department of Local Government

Relevant Legislation

Local Government Act 1993

16.2 Administering Agency

Department of Local Government

Department of Planning

Relevant Legislation

Local Government (Manufactured Home Estates, Caravan Parks, Camping Grounds and Moveable Dwellings) Regulation 2005

17. Occupational Health and Safety

17.1 Administering Agency

Workcover Authority

Relevant Legislation

Occupational Health and Safety Regulation 2001

18. Pharmacies

18.1 Administering Agency

Department of Health

Relevant Legislation

Pharmacy (General) Regulation 1998

19. Planning Controls

19.1 Administering Agency

Department of Planning

Relevant Legislation

Environmental Planning and Assessment Act 1979

Environmental Planning and Assessment Regulation 2000

20. Premises for Activities Involving Skin Penetration

20.1 Administering Agency

Department of Health

Relevant Legislation

Public Health (Skin Penetration) Regulation 2000

21. Sanitary Plumbing, Water Supply and Sewerage

21.1 Administering Agency

Department of Local Government

Relevant Legislation

Local Government Act 1993

Local Government (General) Regulation 2005

21.2 Administering Agency

Department of Water and Energy

Relevant Legislation

NSW Plumbing and Drainage Code 2006

22. Septic Tank Installations

22.1 Administering Agency

Department of Local Government

Relevant Legislation

Local Government Act 1993

Local Government (General) Regulation 2005

23. Sleeping Accommodation

23.1 Administering Agency

Department of Health

Relevant Legislation

Public Health (General) Regulation 2002

24. Smoking Restrictions

24.1 Administering Agency

Department of Health

Relevant Legislation

Smoke Free Environment Regulation 2007

25. Subdivision of Buildings

25.1 Administering Agency

Department of Lands

Relevant Legislation

Conveyancing Act 1919

Strata Schemes (Freehold Development) Act 1973

Strata Schemes (Leasehold Development) Act 1986

26. Swimming Pool Fences

26.1 Administering Agency

Department of Local Government

Relevant Legislation

Swimming Pools Act 1992

Swimming Pools Regulation 1998

27. Temporary Structures

27.1 Administering Agency

Department of Planning

Relevant Legislation

Environmental Planning and Assessment Act 1979

Environmental Planning and Assessment Regulation 2000

NORTHERN TERRITORY

INTRODUCTION

This Appendix contains variations and additions to the Building Code of Australia (BCA) provisions which are considered necessary for the effective application of the Code in the Northern Territory.

APPENDIX CONTENTS

APPENDIX NORTHERN TERRITORY

Northern Territory

A GENERAL PROVISIONS

NT Specification A1.3 Standards Adopted by Reference

B STRUCTURE

NT B1.4 Determination of structural resistance of materials and forms of construction

NT addition to Specification B1.2

E SERVICES AND EQUIPMENT

NT E1.5 Sprinklers

F HEALTH AND AMENITY

NT FO5 Objective

NT FF5.1 Functional Statement

NT FP5.1 - NT FP5.4 Performance Requirements

NT F5.0 Deemed-to-Satisfy Provisions

NT F5.1 Application of Part

NT F5.2 Weighted sound reduction index: Interpretation

NT F5.3 Sound insulation of floors between units

NT F5.4 Sound insulation of walls between units

NT F5.5 Walls between a bathroom, sanitary compartment, laundry or kitchen and a habitable room in adjoining unit

NT F5.6 Soil and waste pipes to be separated

NT F5.7 Isolation of pumps

NT F5.8 Walls between a bedroom and kitchen or laundry in a Class 9c building

NT Specification F5.2 Sound Insulation for Building Elements

NT Specification F5.5 Impact Sound - Test of Equivalence

H SPECIAL USE BUILDINGS

NT Part H101 Food Premises

NT H101.1 Application of Part

NT H101.2 Floors, walls and ceilings

NT H101.3 Pests and contaminants

NT H101.4 Washbasins

NT H101.5 Sinks

NT H101.6 Installation of equipment and fittings

NT H101.7 Drains

NT H101.8 Concealment of pipes

NT H101.9 Storage of materials and equipment
NT H101.10 Separation of work place
NT H101.11 Offensive material and trade waste
NT H101.12 Mechanical ventilation of kitchens

NT Part H102 Premises to be used for Activities Involving Skin Penetration

NT H102.1 Application of Part
NT H102.2 Sanitary facilities
NT H102.3 Washbasins

NT Part H103 Mortuaries

NT H103.1 Application of Part
NT H103.2 Layout of mortuary
NT H103.3 Construction of body preparation room
NT H103.4 Water supply and sewerage

I MAINTENANCE

NT I1.1 Safety measures
NT Part I2 Energy Efficiency Installations

J ENERGY EFFICIENCY

NT SECTION J Energy Efficiency

Footnote: Other Legislation Affecting Buildings

SECTION A GENERAL PROVISIONS

PART A1 INTERPRETATION

NT Specification A1.3 STANDARDS ADOPTED BY REFERENCE.

Insert in Table 1 of Specification A1.3 the following:

NT Table 1 SCHEDULE OF REFERENCED DOCUMENTS

No	Date	Title	BCA Clause(s)
AS/NZS 1170		Structural design actions	
Part 2	2002	Wind actions	NT Spec B1.2
AS 1851		Maintenance of fire protection equipment	NT 11.1
Part 1	1995	Portable fire extinguishers and fire blankets	
Part 2	1995	Fire hose reels	
Part 3	1997	Automatic fire sprinkler systems	
Part 4	1992	Fire hydrant installations	
Part 5	1981	Automatic smoke/heat venting systems	
Part 6	1997	Management procedures for maintaining the fire precaution features of air-handling systems	
Part 7	1984	Fire-resistant doorsets	
Part 8	1987	Automatic fire detection and alarm systems	
Part 10	1989	Emergency warning and intercommunication systems	
AS/NZS 2293		Emergency evacuation lighting for buildings	
Part 2	1995	Inspection and maintenance	NT 11.1
AS 3660		Termite management	
Part 1	2000	New building work	NT B1.4

SECTION B STRUCTURE

PART B1 STRUCTURAL PROVISIONS

Delete B1.4(i) and insert NT B1.4(i) as follows:

NT B1.4 Determination of structural resistance of materials and forms of construction

- (i) Termite risk management: where a *primary building element* is subject to attack by subterranean termites—
- (i) AS 3660.1 with additional protection measures to be used in areas where *Mastotermes Darwiniensis* are prevalent; and
 - (ii) for the purpose of this provision, a *primary building element* consisting entirely of, or a combination of, any of the following materials is considered not to be subject to termite attack:
 - (A) Steel, aluminium or other metals.
 - (B) Concrete.
 - (C) Masonry.
 - (D) Fibre-reinforced cement.
 - (E) Timber in areas where *Mastotermes Darwiniensis* are not prevalent—naturally termite resistant in accordance with Appendix C of AS 3660.1.
 - (F) Timber — preservative treated in accordance with Appendix D of AS 3660.1; and
 - (iii) where a termite risk management system in accordance with AS 3660.1 is used, a durable notice must be permanently fixed to the building in a prominent location, such as a meter box or the like, indicating—
 - (A) the method of termite risk management; and
 - (B) the date of installation of the system; and
 - (C) where a chemical barrier is used, its life expectancy as listed on the National Registration Authority label; and
 - (D) the installer's or manufacturer's recommendations for the scope and frequency of future inspections for termite activity.

NT ADDITION TO SPECIFICATION B1.2

Add clause NT 3 and clause NT 4 as follows –

NT3 Strengthened area

Where a residential building of Class 2, 3, 9a or 9c, in Region C as defined by AS/NZS 1170.2, is designed to be used by the Aged or Infirm it shall incorporate a “strengthened area” for use as shelter during cyclonic conditions and must comply with the following criteria:

(“strengthened area” is defined as the strengthening of an area to increase its potential to facilitate debris protection)

- (a) The *floor area* of the “strengthened area” is to be calculated at the rate of 1.2 m² per person normally accommodated within the building.
- (b) The minimum standard of debris protection to be achieved is represented by the following construction:
 - (i) 200 mm masonry block walls reinforced in accordance with the Northern Territory Deemed to Comply Standards (DTC) and core filled every core; or
Timber or steel framed walls clad internally and externally with 18 mm structural ply, screw fixed at 150 mm centres to studs, plates and noggins; and
 - (ii) Ceiling battens strapped to truss bottom chords or ceiling joists in accordance with the DTC Standard; and
18 mm structural ply screw fixed to ceiling battens at 150 mm centres; and
 - (iii) All doors serving the strengthened area are to be internal and are to be solid core, inward opening with barrel bolts fitted to the top and bottom; and
 - (iv) All *windows* protected with debris screens in accordance with DTC Standards.

NT4. Masonry veneer construction

Masonry veneer construction must be designed so that the structural framing, to which the masonry veneer is tied, will ensure the stability of the masonry veneer.

SECTION E SERVICES AND EQUIPMENT

PART E1 FIRE-FIGHTING EQUIPMENT

NT E1.5 Sprinklers

Insert provisions for Class 9a buildings in Table E1.5 as follows:

NT Table E1.5 REQUIREMENTS FOR SPRINKLERS

Occupancy	When sprinklers are required
Class 9a	if more than one <i>storey</i>

SECTION F HEALTH AND AMENITY

PART F5 SOUND TRANSMISSION AND INSULATION

Delete Part F5 and insert NT Part F5 as follows:

OBJECTIVE

NT FO5

The *Objective* of this Part is to safeguard occupants from illness or loss of amenity as a result of undue sound being transmitted—

- (a) between adjoining *sole-occupancy units*; and
- (b) from common spaces to *sole-occupancy units*.

Application:

NT FO5 only applies to a Class 2 or 3 building or a Class 9c *aged care building*.

FUNCTIONAL STATEMENT

NT FF5.1

A building element which separates *sole-occupancy units*, or separates a *sole-occupancy unit* from a common space within the building, is to be constructed to prevent undue sound transmission.

Application:

NT FF5.1 only applies to a Class 2 or 3 building or a Class 9c *aged care building*.

PERFORMANCE REQUIREMENTS

NT FP5.1

Floors separating *sole-occupancy units* must provide insulation against the transmission of airborne and impact generated sound sufficient to prevent illness or loss of amenity to the occupants.

Application:

NT FP5.1 only applies to a Class 2 or 3 building or a Class 9c *aged care building*.

NT FP5.2

Walls separating—

- (a) *sole-occupancy units*; or
- (b) a *sole-occupancy unit* from a plant room, lift *shaft*, stairway, *public corridor*, public lobby or the like,

must provide insulation against the transmission of airborne and impact generated sound sufficient to prevent illness or loss of amenity to the occupants.

Application:

NT FP5.2 only applies to a Class 2 or 3 building.

NT FP5.3

The *required* sound insulation of floors or walls must not be compromised by the incorporation or penetration of a pipe or other service element.

Application:

NT FP5.3 only applies to a Class 2 or 3 building or a Class 9c *aged care building*.

NT FP5.4

Walls separating—

- (a) *sole-occupancy units*; or
- (b) a *sole-occupancy unit* from a kitchen, bathroom, *sanitary compartment* (not being an associated ensuite), laundry, plant room or utilities room,

must provide insulation against the transmission of airborne sound sufficient to prevent illness or loss of amenity to the occupants; and

- (c) a *sole-occupancy unit* from a kitchen or laundry,

must provide insulation against the transmission of impact generated sound sufficient to prevent illness or loss of amenity to the occupants.

Application:

NT FP5.4 only applies to a Class 9c *aged care building*.

NT F5.0 Deemed-to-Satisfy Provisions

- (a)

Where a *Building Solution* is proposed to comply with the *Deemed-to-Satisfy Provisions, Performance Requirements NT FP5.1 to NT FP5.4* are satisfied by complying with **NT F5.1 to NT F5.8**.

- (b)

Where a *Building Solution* is proposed as an *Alternative Solution* to the *Deemed-to-Satisfy Provisions* of **NT F5.1 to NT F5.8**, the relevant *Performance Requirements* must be determined in accordance with **A0.10**.

NT F5.1 Application of Part

The *Deemed-to-Satisfy Provisions* of this Part apply to Class 2 and 3 buildings and Class 9c *aged care buildings*.

NT F5.2 Weighted sound reduction index: Interpretation

A form of construction *required* to have a certain weighted sound reduction index (R_w) must—

- (a) have the *required* value determined under AS/NZS 1276.1, or ISO 717.1; or
- (b) comply with **NT Specification F5.2**.

NT F5.3 Sound insulation of floors between units

A floor separating *sole-occupancy units* must have an R_w not less than 45.

NT F5.4 Sound insulation of walls between units

A wall must have an R_w not less than 45 if it separates—

- (a) *sole-occupancy units*; or
- (b) a *sole-occupancy unit* not within a Class 9c *aged care building* from a plant room, lift shaft, stairway, *public corridor*, hallway or the like.
- (c) a *sole-occupancy unit* in a Class 9c *aged care building* from a kitchen, bathroom, *sanitary compartment* (not being an associated ensuite), laundry, plant room or utilities room.

NT F5.5 Walls between a bathroom, sanitary compartment, laundry or kitchen and a habitable room in adjoining unit

- (a) Except for a Class 9c *aged care building*, a wall separating a bathroom, *sanitary compartment*, laundry or kitchen in one *sole-occupancy unit* from a *habitable room* (other than a kitchen) in an adjoining unit must—
 - (i) have an R_w of not less than 50; and
 - (ii) provide a satisfactory level of insulation against impact sound; and
 - (iii) not incorporate a duct which reduces the R_w of the wall to less than 50.
- (b) A wall satisfies **(a)(i)** and **(a)(ii)** if it is—
 - (i) in accordance with **NT Table F5.5**; or
 - (ii) for other than masonry, in 2 or more separate leaves without rigid mechanical connection except at their periphery; or
 - (iii) identical with a prototype that is no less resistant to the transmission of impact sound when tested in accordance with **NT Specification F5.5** than a wall listed in **NT Table F5.5**.

NT Table F5.5 CONSTRUCTION OF WALLS TO REDUCE IMPACT SOUND

<p>Cavity brickwork—</p> <p>Two leaves of 90 mm brick masonry with—</p> <ul style="list-style-type: none"> (i) all joints filled solid with mortar; and (ii) an air space not less than 40 mm between the leaves; and (iii) the leaves connected only by ties in accordance with AS 3700.
<p>Single leaf brickwork—</p>

NT Table F5.5 CONSTRUCTION OF WALLS TO REDUCE IMPACT SOUND— continued

<p>110 mm thick brick masonry with—</p> <ul style="list-style-type: none"> (i) each face rendered 13 mm thick; and (ii) 50 mm x 12 mm thick timber battens at not more than 610 mm centres fixed to each face but not recessed into the render; and (iii) one layer of 12 mm thick softboard nailed to the battens; and (iv) 6 mm thick medium density hardboard adhesive-fixed to the softboard.
<p>Concrete blockwork—</p> <p>190 mm thick concrete block masonry with—</p> <ul style="list-style-type: none"> (i) each face of the blocks fitted with 50 mm x 50 mm timber battens, spaced at not more than 610 mm centres, screw-fixed into resilient plugs with rubber inserts; and (ii) the space between the battens completely filled with mineral or glass wool blanket or batts not less than 50 mm thick; and (iii) the outer face of the battens finished with plasterboard not less than 10 mm thick or other material with a mass per unit area not less than 7.3 kg/m².

NT F5.6 Soil and waste pipes to be separated

If a soil or waste pipe, including a pipe that is embedded in or passes through a floor, serves or passes through more than one *sole-occupancy unit*—

- (a) the pipe must be separated from the rooms of any *sole-occupancy unit* by construction with an R_w not less than—
 - (i) 45 if the adjacent room is a *habitable room* (other than a kitchen); or
 - (ii) 30 if the adjacent room is a kitchen or any other room; and
- (b) a door or panel providing access to the pipe must not open into any *habitable room* (other than a kitchen); and
- (c) an access door or panel in any other part must be firmly fixed so as to overlap the frame or rebate of the frame by not less than 10 mm, be fitted with a sealing gasket along all edges and constructed of—
 - (i) wood, particleboard or blockboard not less than 38 mm thick; or
 - (ii) compressed fibre reinforced cement sheeting not less than 9 mm thick; or
 - (iii) other suitable material with a mass per unit area not less than 24.4 kg/m².

NT F5.7 Isolation of pumps

A flexible coupling must be used at the point of connection between the service pipes in a building and any circulating or other pump.

NT F5.8 Walls between a bedroom and kitchen or laundry in a Class 9c building

In addition to **NT F5.4**, a wall separating a *sole-occupancy unit* in a Class 9c *aged care building* from a kitchen or laundry must—

- (a) for other than masonry, be two or more separate leaves without rigid mechanical connection except at their periphery; or
- (b) be identical with a prototype that is no less resistant to the transmission of impact sound when tested in accordance with **NT Specification F5.5** than a wall listed in **Table 2 of NT Specification F5.2**.

SPECIFICATION **F5.2** SOUND INSULATION FOR BUILDING ELEMENTS

Deemed-to-Satisfy Provisions

1. Scope

This Specification lists the weighted sound reduction index (R_w) for some common forms of construction.

2. Construction deemed-to-satisfy

The forms of construction listed in **Table 2** are considered to have the R_w stated in that Table if installed as follows:

- (a) **Masonry**—Units must be laid with all joints filled solid, including those between the masonry and any adjoining construction.
- (b) **Concrete slabs**—Joints between concrete slabs and any adjoining construction must be filled solid.
- (c) **Plasterboard**—
 - (i) if one layer is *required* under this Specification, it must be screw-fixed to the studs with joints staggered on opposite faces; and
 - (ii) if 2 layers are *required*, the first layer must be fixed according to (i) and the second layer must be fixed to the first layer with nails, screws or adhesive so that the joints do not coincide with those of the first layer; and
 - (iii) joints between sheets or between sheets and any adjoining construction must be taped and filled solid; and
 - (iv) fire-protective grade plasterboard must be the special grade manufactured for use in *fire-resisting construction*.
- (d) **Steel studs and perimeter members**—
 - (i) the section of steel must be not less than 0.6 mm thick; and
 - (ii) studs must be not less than 63 mm in depth unless another depth is listed in **Table 2**; and
 - (iii) studs must be fixed to steel top and bottom plates of sufficient depth to permit secure fixing of the plasterboard; and
 - (iv) all steel members at the perimeter of the wall must be securely fixed to the adjoining structure and bedded in resilient compound or the joints must be caulked so that there are no voids between the steel members and the wall.

Deemed-to-Satisfy Provisions

Table 2 R_w APPLICABLE TO CONSTRUCTION

Construction	R _w (not less than)
WALLS	
Clay brickwork—	
(a) 230 mm thick in one or more leaves and with a mass per unit area of not less than 290 kg/m ²	45
(b) 110 mm thick rendered 13 mm thick on both sides with a mass per unit area of the unrendered wall being not less than 190 kg/m ²	45
(c) 110 mm thick, of semi-dry-pressed bricks and rendered 13 mm on one side, the mass per unit area of the unrendered wall being not less than 215 kg/m ²	45
(d) 110 mm thick, of extruded brick and rendered 13 mm on one side, the mass per unit area of the unrendered wall being not less than 180 kg/m ²	45
Concrete brickwork — 110 mm thick with a mass per unit area of not less than 195 kg/m ²	45
Concrete blockwork—	
(a) 190 mm thick with a mass per unit area of not less than 215 kg/m ²	45
(b) (i) 140 mm thick, the wall thickness of the blocks being not less than 44 mm and with— 50 mm x 50 mm timber battens spaced at not more than 610 mm centres screw-fixed on one face of the blocks into resilient plugs with rubber inserts between battens and the wall;	
(ii) the face of the battens clad with 13 mm thick standard plasterboard; and	
(iii) a mass per unit area of the whole system of not less than 220 kg/m ²	45
Concrete—	
(a) In-situ concrete — 125 mm thick and with a density of not less than 2200 kg/m ³	45
(b) In-situ concrete — 100 mm thick and with a density of not less than 2500 kg/m ³	45
(c) Precast concrete — 100 mm thick and without joints	45
Steel stud walling—	
(a) with 2 layers of 16 mm thick fire-protective grade plasterboard fixed to each face	45

Deemed-to-Satisfy Provisions

Table 2 R_w APPLICABLE TO CONSTRUCTION— continued

Construction	R_w (not less than)
(b) with—	45
(i) 1 layer of 13 mm thick fire-protective grade plasterboard fixed to one face, and before fixing, 50 mm thick mineral or glass wool blanket or batts stapled to the back of each sheet so that the sheet is completely covered; and	
(ii) 2 layers of 13 mm thick fire-protective grade plasterboard fixed to the other face	
(c) with—	45
(i) 1 layer of 16 mm fire-protective grade plasterboard fixed to one face; and	
(ii) 50 mm thick mineral or glass wool blanket or batts wedged firmly between the studs; and	
(iii) 2 layers of fire-protective grade plasterboard fixed to the other face, the inner layer being 16 mm thick and the outer layer being 13 mm	
(d) with 2 layers of 13 mm plasterboard on both sides of 75 mm studs	45
FLOORS—	
Concrete—	
(a) In-situ concrete slab — 125 mm thick and with a density of not less than 2200 kg/m ³	45
(b) In-situ concrete slab — 100 mm thick and with a density of not less than 2500 kg/m ³	45
(c) Pre-cast concrete slab — 100 mm thick and without joints	45
Timber — comprising—	
(a) timber joists not less than 175 mm x 50 mm; and	45
(b) 75 mm thick mineral or glass wool blanket or batts cut to fit tightly between joists and laid on 10 mm thick plasterboard fixed to underside of joists; and	
(c) 25 mm thick mineral or glass wool blanket or batts laid over entire floor, including tops of joists before flooring is laid; and	
(d) tongued-and-grooved boards not less than 19 mm thick, secured to 75 mm x 50 mm battens; and	
(e) the assembled flooring laid over the joists, but not fixed to them, with the battens lying between the joists	

Deemed-to-Satisfy Provisions

Table 2 R_w APPLICABLE TO CONSTRUCTION— continued

Construction	R _w (not less than)
DUCTS OR OTHER CONSTRUCTION SEPARATING SOIL AND WASTE PIPES FROM UNITS	
Masonry — not less than 90 mm thick	30
Plasterboard — 2 layers of plasterboard—	
(a) each 10 mm thick, fixed to timber studs not less than 75 mm x 50 mm and spaced at not more than 400 mm centres.	30
(b) each 13 mm thick, one on each side of steel studs not less than 50 mm deep and spaced at not more than 400 mm centres	30

SPECIFICATION F5.5 IMPACT SOUND — TEST OF EQUIVALENCE

Deemed-to-Satisfy Provisions

1. Scope

This Specification describes a method of test to determine the comparative resistance of walls to the transmission of impact sound.

2. Construction to be tested

- (a) The test is conducted on a specimen of prototype wall construction and on a specimen of one or other of the constructions specified in **NT Table F5.5**.
- (b) The testing of a construction specified in **NT Table F5.5** need not be repeated for subsequent comparisons provided complete records of the results, the test equipment and the technique of testing are kept so that identical equipment can be employed and an identical technique can be adopted in the testing of specimens of prototype wall construction.

3. Method

- (a) The wall constructions to be compared must be tested in accordance with AS 1191.
- (b) A horizontal steel platform 510 mm x 460 mm x 10 mm thick must be placed with one long edge in continuous and direct contact with the wall to be tested on the side of the wall on which the impact sound is to be generated.
- (c) A tapping machine complying with *ISO 140/6—1998 (E)* must be mounted centrally on the steel platform.
- (d) The sound transmission through the wall must be determined in accordance with AS 1191 except that the tapping machine as mounted on the steel platform must be used as the source of sound.
- (e) The impact sound pressure levels measured in the receiving room must be converted into normalised levels using a reference equivalent absorption area of 10 m².

SECTION H SPECIAL USE BUILDINGS

Insert NT Part H101 as follows:

NT PART H101 FOOD PREMISES

NT H101.1 Application of Part

- (a) This Part applies to all premises, rooms, compartments, or places used for the sale, preparation, packing, storing, handling, serving, supplying or conveying for sale of food.
- (b) This Part does not apply to tents, buildings or other structures used temporarily for serving meals to the public at any fair, show, race meeting or other public sports, games or amusements.

NT H101.2 Floors, walls and ceilings

- (a) Each floor, wall and ceiling of the premises must have a surface that is—
 - (i) durable, rigid, impervious to water, non-absorbent, non-toxic and smooth enough to be easily cleaned; and
 - (ii) free from cracks, crevices and other defects.
- (b) If the floor is subject to wet cleaning by hosing down or if activities are carried out where liquids are discharged on to the floor, the floor must be graded to trapped floor waste outlets connected to a drainage installation.
- (c) Each wall must be free from skirtings, architraves, picture rails or other ledges that could provide lodgement for dirt.
- (d) All angles between the walls and the floor must be coved to permit easy cleaning.
- (e) All angles between walls and all joints in walls must be sealed.
- (f) All walls and ceilings must be finished in light colour.
- (g) Subclauses (a), (b), (c), (d), (e) and (f) do not apply to areas used only by customers and they do not apply to walls and ceilings in a premises or place—
 - (i) used for the storage or display for sale of food that is wholly enclosed in protective packages;
 - (ii) used for the storage for sale of fruit and vegetables; or
 - (iii) in which all food for sale is completely enclosed and otherwise protected from contamination by processing plants, other appliances, or other means.

NT H101.3 Pests and contaminants

- (a) The exterior of a food premises must be constructed to exclude pests and contaminants.
- (b) Premises which are provided with—
 - (i) fly proof, external *windows* and *self-closing*, fly-proof doors, or
 - (ii) if customers are served outside the premises through an opening, an appliance for the elimination of flies and mechanical ventilation adequate to exhaust air through the opening at a rate of not less than 5 litres per second for each square metre of opening, satisfy (a) as it applies to insects.

NT H101.4 Washbasins

Each premises or place for preparation or storage of food for sale must be provided with not less than one washbasin, supplied with hot and cold water, in or within reasonable proximity of

those areas where the nature of the activities performed is such that hands are likely to be a source of contamination of food.

NT H101.5 Sinks

- (a) Each premises must be provided with a double bowl sink or tub of stainless steel supplied with—
 - (i) hot and cold water; and
 - (ii) an integral drainer on at least one side.
- (b) If a sink is installed within 300 mm of a vertical adjacent surface it must be fitted with an integral flashing to that vertical, adjacent surface to a height of not less than 150 mm.

NT H101.6 Installation of equipment and fittings

- (a) Each item of equipment or fitting in a premises which is not capable of being moved easily must be installed—
 - (i) so that the area underneath the item can be easily cleaned; or
 - (ii) on a solid base or plinth constructed of impervious material similar to the flooring material.
- (b) A plinth must be—
 - (i) not less than 75 mm high; and
 - (ii) finished to a smooth even surface and rounded at exposed edges to facilitate cleaning; and
 - (iii) coved at intersections with floor and walls.

NT H101.7 Drains

A grease trap or an untrapped opening connected directly with a drain or sewer, must not be installed in a room used for preparation, processing, packing or storing of food.

NT H101.8 Concealment of pipes

Where practicable, service pipes should be concealed beneath the surface of walls, floors, or ceilings, otherwise pipes are to be fixed clear of the wall, floor, or ceiling, at such distance as to facilitate cleaning.

NT H101.9 Storage of materials and equipment

Separate areas for the storage of fuel, cleaning compounds and general maintenance equipment must be provided so as to prevent the contamination of the product in the event of a spillage or any other form of breakdown.

NT H101.10 Separation of work place

Food premises must not have direct communication with a room containing sanitary facilities, sleeping quarters, laundry, bathroom or garage or a room where animals are housed.

NT H101.11 Offensive material and trade waste

If offensive material or trade waste is stored, a separate area must be provided which—

- (a) is easily cleanable; and
- (b) is graded to drain to a suitable drainage system; and
- (c) has available a supply of water under pressure.

NT H101.12 Mechanical ventilation of kitchens

In a commercial kitchen where food is prepared for sale, a mechanical ventilating exhaust system must be installed in accordance with [Part F4.12](#).

Insert NT Part H102 as follows:

NT PART H102 PREMISES TO BE USED FOR ACTIVITIES INVOLVING SKIN PENETRATION

NT H102.1 Application of Part

This part applies to premises for tattooing, ear-piercing, acupuncture and like activities.

NT H102.2 Sanitary facilities

- (a) Sanitary facilities for customers must be provided and must include not less than—
 - (i) one water closet; and
 - (ii) one washbasin.
- (b) Sanitary facilities must be separated from the workroom by—
 - (i) an air lock with *self-closing* entry door; or
 - (ii) a *self-closing* door.

NT H102.3 Washbasins

The area in which skin penetration is done must be provided with—

- (a) one wash basin for each 10, or part of 10 employees; and
- (b) an adequate supply of hot and cold water controlled by foot-operated or elbow-operated taps.

Insert NT Part H103 as follows:

NT PART H103 MORTUARIES

NT H103.1 Application of Part

This Part applies to any premises used for storage or preparation for burial, cremation or disposal by other means, of bodies of deceased persons.

NT H103.2 Layout of mortuary

- (a) A mortuary may be integral with the remainder of a building but must be separated physically from all public areas of that building.

- (b) Each mortuary at which bodies are prepared for burial, cremation or other disposal must be provided with a body preparation room—
 - (i) capable of being isolated from the remainder of the premises; and
 - (ii) having a *floor area* not less than 10 m².
- (c) A vehicle reception area or garage must be provided adjacent to and with direct access to the storage room or body preparation room to ensure that the transfer of uncoffined bodies is screened from public view.
- (d) Access to toilet and shower facilities from any other part of the mortuary premises must be only by way of an air lock.

NT H103.3 Construction of body preparation room

- (a) The floor must be—
 - (i) of impervious material with a smooth, unbroken surface; and
 - (ii) uniformly graded to a floor drain.
- (b) All walls and partitions must be of concrete or masonry with a smooth, unbroken finish for ease of cleaning.
- (c) All joints between the floor, walls, partitions, ceiling, ventilation grilles, fittings, pipework, *windows* and light fittings must be sealed with impervious material for ease of cleaning.
- (d) All joints between the floor and walls or partitions must be covered for ease of cleaning.
- (e) The body preparation room must be provided with at least one washbasin, fitted with elbow or foot-operated taps, and an adequate supply of hot and cold water.
- (f) The body preparation room must be provided with refrigerated storage facilities—
 - (i) with sufficient capacity for the storage of at least two adult bodies; and
 - (ii) capable of maintaining an internal temperature between 1°C and 5°C.

NT H103.4 Water supply and sewerage

Each mortuary with a body preparation room must be connected to—

- (a) a permanent water supply with a physical discontinuity between the water supply and all equipment, appliances, fittings and areas in the mortuary; and
- (b) a water carriage sewerage system.

SECTION I MAINTENANCE

PART I1 EQUIPMENT AND SAFETY INSTALLATIONS

Delete I1.1 and insert NT I1.1 as follows:

NT I1.1 Safety Measures

Safety measures in buildings must be maintained in accordance with the requirements of the following Australian Standards as appropriate:

- (a) AS 1851.1 Portable fire extinguishers
- (b) AS 1851.2 Fire hose reels

- (c) AS 1851.3 Automatic fire sprinkler systems
- (d) AS 1851.4 Fire hydrant installations
- (e) AS 1851.5 Automatic smoke/heat venting systems
- (f) AS 1851.6 Management procedures for maintaining the fire precaution features of air-handling systems
- (g) AS 1851.7 Fire-resistant door sets
- (h) AS 1851.8 Automatic fire detection and alarm systems
- (i) AS 1851.10 Emergency warning and intercommunication systems
- (j) AS/NZS 2293.2 Emergency evacuation lighting for buildings, Part 2 Inspection and maintenance

PART I2 ENERGY EFFICIENCY INSTALLATIONS

Delete Part I2 and insert the following:

NT PART I2 Energy Efficiency Installations

(deleted)

SECTION J ENERGY EFFICIENCY

SECTION J ENERGY EFFICIENCY

Delete Section J and insert the following:

NT Section J Energy Efficiency

(deleted)

Footnote: OTHER LEGISLATION AFFECTING BUILDINGS

In addition to any applicable provisions of the Building Act, Building Regulations and this Code, there are a number of other legislative technical requirements affecting the design, construction and/or performance of buildings that practitioners may need to be aware of, including, but not necessarily limited to, the following list. Additional legislative instruments such as regulations, codes and standards may exist under the legislation listed.

1. Accommodation/Food Premises/Skin Penetration Activities/Mortuaries

1.1 Administering Agency

Department of Health and Community Services

Relevant Legislation

Public Health Act

2. Child Care

2.1 Administering Agency

Department of Health and Community Services

Relevant Legislation

Community Welfare Act

Community Welfare (Child Care) Regulations

3. Crown Land

3.1 Administering Agency

Department of Planning and Infrastructure

Relevant Legislation

Crown Lands Act

4. Dangerous Goods

4.1 Administering Agency

Department of Employment, Education and Training

Relevant Legislation

Dangerous Goods Act

5. Electrical Installations

5.1 Administering Agency

Department of Employment, Education and Training

Relevant Legislation

Electrical Workers and Contractors Act

Electricity Reform Act

Electricity Reform (Safety and Technical) Regulations

6. Fences — dividing

6.1 Administering Agency

Department of Justice

Relevant Legislation

Fences Act

7. Fire Prevention

7.1 Administering Agency

Northern Territory Fire and Rescue Service

Relevant Legislation

Fire and Emergency Act

8. Gas Installations

8.1 Administering Agency

Department of Employment, Education and Training

Relevant Legislation

Work Health Act

Work Health (Occupational Health and Safety) Regulations

9. Historic Building

9.1 Administering Agency

Department of Natural Resources, Environment and the Arts

Relevant Legislation

Heritage Conservation Act

10. Liquor — licensing

10.0 Administering Agency

Department of Justice

Relevant Legislation

Liquor Act

11. Occupational Health and Safety

11.1 Administering Agency

Department of Employment, Education and Training

Relevant Legislation

Work Health Act

12. Places of Public Entertainment

12.1 Administering Agency

Department of Local Government, Housing and Sport

Council or Municipality

Relevant Legislation

Places of Public Entertainment Act

13. Planning Controls

13.1 Administering Agency

Department of Planning and Infrastructure

Relevant Legislation

Planning Act
Planning Scheme

14. Plumbing Installations

14.1 Administering Agency

Department of Planning and Infrastructure

Relevant Legislation

Plumbers and Drainers Licensing Act
Building Act

15. Stormwater Drainage (Municipal Roads)

15.1 Administering Agency

Council or Municipality in which building is located

Relevant Legislation

Local Government Act

16. Stormwater Drainage (Territory Roads)

16.1 Administering Agency

Department of Planning and Infrastructure

Relevant Legislation

Control of Roads Act

17. Swimming Pools

17.1 Administering Agency

Department of Local Government, Housing and Sport

Relevant Legislation

Swimming Pool Safety Act

18. Water Supply and Sewage Services

18.1 Administering Agency

Power and Water Corporation

Relevant Legislation

Water Supply and Sewerage Services Act

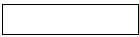

QUEENSLAND

INTRODUCTION

This Appendix contains variations and additions to the Building Code of Australia (BCA) provisions which are considered necessary for the effective application of the Code in Queensland and shall be treated as amendments to the Code.

APPENDIX CONTENTS

APPENDIX QUEENSLAND

Queensland

A GENERAL PROVISIONS

Qld Specification A1.3 Standards Adopted by Reference

B STRUCTURE

Qld B1.4 Determination of structural resistance of materials and forms of construction

G ANCILLARY PROVISIONS

Qld Part G101 CERTAIN ATTACHMENTS

Qld G101.1 Prevention of falls from buildings or structures

Footnote: Other Legislation Affecting Buildings

SECTION A GENERAL PROVISIONS

Qld Specification A1.3 STANDARDS ADOPTED BY REFERENCE

Insert in Table 1 of Specification A1.3 additional standards as follows:

Qld Table 1 SCHEDULE OF REFERENCED DOCUMENTS

No.	Date	Title	BCA clause(s)
AS 2626	1983	Industrial safety belts and harness — Selection, use and maintenance	Qld G101.1
		Queensland Forest Service of the Department of Primary Industries Construction timbers in Queensland - Properties and specifications for satisfactory performance of construction timbers in Queensland - Class 1 and 10 buildings (Houses, carports, garages, greenhouses and sheds).	Qld B1.4

SECTION B STRUCTURE

PART B1 STRUCTURAL PROVISIONS

After B1.4(f)(iii) insert Qld B1.4(f)(iv) as follows:

Qld B1.4 Determination of structural resistance of materials and forms of construction

- (f) Timber Construction:
- (iv) Timber used for structural purposes: a species scheduled for the appropriate use in Schedules A, B or C in Queensland Forest Service of the Department of Primary Industries Construction timbers in Queensland - Properties and specifications for satisfactory performance of construction timbers in Queensland - Class 1 and 10 buildings (Houses, carports, garages, greenhouses and sheds).

SECTION G ANCILLARY PROVISIONS

Add Qld Part G101 as follows:

QLD PART G101 CERTAIN ATTACHMENTS

Qld G101.1 Prevention of falls from buildings or structures

Where a person is exposed to the hazard of falling from a building or structure while cleaning or maintenance work is being carried out—

- (a) a work system designed to prevent such falls must be used; and
- (b) where safety belt anchorage points are used they must be positioned on the building or structure so that a lifeline or safety harness may be attached before proceeding to a point where it is possible to fall; and

(c) anchorage points for the attachment of safety harnesses must comply with AS 2626.

Footnote: OTHER LEGISLATION AFFECTING BUILDINGS

All legislative technical requirements affecting the design, construction and/or performance of buildings are consolidated into the Building Act 1975 and other legislative instruments under that Act, such as regulations, codes (including this Code) and standards.

SOUTH AUSTRALIA

INTRODUCTION

This Appendix contains variations and additions to the BCA provisions which are considered necessary for the effective application of the Code in South Australia.

These variations and additions are to be treated as amendments to the BCA and apply to the construction or alteration of all buildings requiring approval under the Development Act and Regulations 1993.

APPENDIX CONTENTS

APPENDIX SOUTH AUSTRALIA

INTRODUCTION

A GENERAL PROVISIONS

SA Specification A1.3 Standards Adopted by Reference

D ACCESS AND EGRESS

SA DP1 and SA DP7 Performance Requirements
SA D3.1 Application of Part
SA Table D3.2 Access to buildings
SA D3.4 Concessions

F HEALTH AND AMENITY

SA FP1.5, SA FP 1.6 and SA FP1.8 Performance Requirements
SA F1.0 Deemed-to-Satisfy Provisions
SA F1.7 Water proofing of wet areas in buildings
SA F1.9 Damp-proofing
SA F1.10 Damp-proofing of floors on the ground
SA F1.11 Provision of floor wastes
SA F2.3 Facilities for Class 3 to 9 buildings
SA Table F2.3 Sanitary Facilities in Class 3, 5, 6, 7, 8 and 9 buildings
SA F2.4 Facilities for people with disabilities
SA Table F2.4 Sanitary Facilities for people with disabilities

G ANCILLARY PROVISIONS

SA G5.1 Swimming pools
SA G5.2 Protection
SA G5.3 Additional Protection

SA Part G7 ACCESS FOR MAINTENANCE

SA GO7 Objective
SA GF7.1 and SA GF7.2 Functional Statements
SA GP7.1 and SA GP7.2 Performance Requirements
SA G7.0 Deemed-to-Satisfy Provisions
SA G7.1 Application of Part
SA G7.2 Access for window cleaning
SA G7.3 Access for inspection and maintenance between buildings

SA Part G8 MISCELLANEOUS PROVISIONS

SA GO8 Objective
SA GF8.1 Functional Statement
SA GP8.1 Performance Requirement

- SA G8.0 Deemed-to-Satisfy Provisions
- SA G8.1 Application of Part
- SA G8.2 Attachments to buildings

H SPECIAL USE BUILDINGS

SA Part H2 BULK GRAIN STORAGE FACILITIES

- SA H2.1 Application of Part
- SA H2.2 Concessions for bulk grain storage facilities

SA Part H3 FARM BUILDINGS

- SA H3.1 Application of Part
- SA H3.2 Concessions and additions for farm buildings

I MAINTENANCE

- SA I1.1 Safety installations
- SA I1.2 Mechanical ventilation and hot water, warm water and cooling water systems

J ENERGY EFFICIENCY

- SA JP3 Performance Requirement
- SA JV4 Verification Method

SA PART J3 BUILDING SEALING

- SA J3.1 Application of Part
- SA J3.3 Roof lights
- SA J3.4 Windows and doors
- SA J3.5 Exhaust fans
- SA J3.6 Construction of roofs, walls and floors
- SA J3.7 Evaporative coolers

SA PART J7 HEATED WATER SERVICES

- SA J7.0 Deemed-to-Satisfy Provisions
- SA J7.1 Application of Part
- SA J7.2 Complying Heated water services

Footnote: Other Legislation Affecting Buildings

SECTION A GENERAL PROVISIONS

PART A1 INTERPRETATION

SA A1.1 Definitions

Insert definition for *Energy Rating label* as follows:

Energy Rating label means an Energy Rating label as specified in AS 4552.

Insert definition for *Renewable Energy Certificates* as follows:

Renewable Energy Certificates means Renewable Energy Certificates issued under the Commonwealth Government's Mandatory Renewable Energy Target.

Insert definition for *rated hot water delivery* as follows:

Rated hot water delivery means rated hot water delivery as specified in AS 1056.

Insert in Table 1 of Specification A1.3 additional standards as follows:

SA Specification A1.3 STANDARDS ADOPTED BY REFERENCE

SA Table 1 SCHEDULE OF REFERENCED DOCUMENTS

No	Date	Title	BCA clause(s)
AS 1056		Storage water heaters	
Part 1	1991	General requirements	SA JV4
AS 1720		Timber structures	
Part 2	2006	Timber properties	SA G5.2
AS/NZS 1891		Industrial fall-arrest systems and devices	
Part 4	2000	Selection, use and maintenance	SA G7.2
AS 1926		Swimming pool safety	
Part 3	2003	Water reticulation systems	SA G1.1
AS 4234	1994	Solar water heaters — Domestic and heat pump — Calculation of energy consumption	SA JV4
AS 4552	2005	Gas water heaters	SA JV4
Department of Climate Change	2008	National Greenhouse Accounts (NGA) Factors	SA JV4
Minister's Specifications			
SA F1.7	2004	Water proofing of wet areas in buildings- Additional requirements	SA F1.7, SA F1.11
SA H2.2	1997	Construction of bulk grain storage facilities	SA H2.2
SA H3.2	2004	Concessions and additional requirements for farm buildings	SA H3.2

SA Table 1 SCHEDULE OF REFERENCED DOCUMENTS— continued

No	Date	Title	BCA clause(s)
SA 76	2000	Maintenance and testing of safety installations. Schedule of essential safety provisions	SA 11.1, SA 11.2

SECTION D ACCESS AND EGRESS

PART D1 PROVISION FOR ESCAPE

PERFORMANCE REQUIREMENT

SA DP1

Substitute application of *Performance Requirement DP1* as follows:

Application:

DP1(b), with respect to people with disabilities, only requires special provisions in—

- (a) A Class 3, 5, 6, 8 or 9 building; or
- (b) a Class 7 building other than a Class 7a *carpark* associated with a Class 2 building; or
- (c) a Class 10a building other than a Class 10a building associated with a Class 1 or 2 building or Class 4 part of a building; or
- (d) certain Class 2 buildings in developments consisting of 20 or more residential *sole-occupancy units*.

SA DP7

Substitute application of *Performance Requirement DP7* as follows:

Application:

DP7 only applies to—

- (a) A Class 3, 5, 6, 8 or 9 building; or
- (b) a Class 7 building other than a Class 7a *carpark* associated with a Class 2 building; or
- (c) a Class 10a building other than a Class 10a building associated with a Class 1 or 2 building or Class 4 part of a building; or
- (d) certain Class 2 buildings in developments consisting of 20 or more residential *sole-occupancy units*.

PART D3 ACCESS FOR PEOPLE WITH DISABILITIES

Delete D3.1 and substitute:

SA D3.1 Application of Part

This Part applies to all Class 3, 5, 6, 7, 8, 9 and 10a buildings and to certain Class 2 buildings where expressly referred to in [SA Table D3.2](#).

Insert in Table D3.2 the following:

SA Table D3.2 Access to buildings

SA Table D3.2 REQUIREMENTS FOR ACCESS FOR PEOPLE WITH DISABILITIES

Class of building	Provision for access
Class 2	
In developments consisting of 20 or more residential <i>sole-occupancy units</i>	To and within one residential <i>sole-occupancy unit</i> or 5% of the total number of residential <i>sole-occupancy units</i> provided, whichever is the greater

Add SA D3.4(e) as follows:

SA D3.4 Concessions

- (e) the whole of a Class 5, 6, 7 and 8 building if one or more *storeys* in the building is provided with access facilities as specified in [Table D3.2](#), and parts of those *storeys* are approved for the purpose of a person with disabilities having business in that building.

SECTION F HEALTH AND AMENITY

PART F1 DAMP AND WEATHERPROOFING

Delete FP1.5 and add SA FP1.5 as follows:

PERFORMANCE REQUIREMENTS

SA FP1.5

- (a) Moisture from the ground must be prevented from causing—
- (i) undue dampness or deterioration of building elements; and
 - (ii) unhealthy or dangerous conditions, or loss of amenity for occupants.
- (b) Barriers installed to prevent transfer of moisture from the ground must have—
- (i) high resistance to moisture penetration; and
 - (ii) high resistance to damage during construction; and
 - (iii) high resistance to degradation by dissolved salts.

Delete FP1.6 add SA FP1.6 as follows:

SA FP1.6

Accidental water overflow from a bathroom, laundry facility or the like must be prevented from penetrating to adjoining rooms or spaces.

After FP1.7 add SA FP1.8 as follows:

SA FP1.8

In laundries, bathrooms or rooms containing shower facilities the floors must be installed in a manner that will prevent accumulation of surface water which could create unhealthy or hazardous conditions.

Delete F1.0(b) and add SA F1.0(b) as follows:

SA F1.0 Deemed-to-Satisfy Provisions

- (b) With the exception of (a), *Performance Requirements FP1.1 to FP1.4, SA FP1.5, SA FP1.6, FP1.7 and SA FP1.8* are satisfied by complying with *F1.1 to F1.6, SA F1.7, SA F1.9 to SA F1.11, F1.12 and F1.13*.

Delete F1.7 and insert SA F1.7 as follows:

SA F1.7 Water proofing of wet areas in buildings

Water-proofing of wet areas in buildings must comply with AS 3740 and the additional requirements of Minister's Specification SA F1.7.

Delete F1.9(b) and insert SA F1.9(b) as follows:

SA F1.9 Damp-proofing

- (b) Damp-proof courses must exhibit long term resistance to degradation by dissolved salts in groundwater and consist of—
- (i) embossed black polyethylene film meeting the requirements of clause 7.6 of AS/NZS 2904; or
 - (ii) polyethylene coated aluminium meeting the requirements of clause 7.4 of AS/NZS 2904; or
 - (iii) bitumen impregnated materials of not less than 2.5 mm thickness, meeting the requirements of clause 7.5 of AS/NZS 2904, when used in walls not higher than 7.8 m above the level of the damp-proof course.

Delete F1.10 and insert SA F1.10 as follows:

SA F1.10 Damp-proofing of floors on the ground

- (a) If a floor of a room is laid on the ground or on fill, a damp-proofing membrane complying with Section 5.3.3 of AS 2870 must be installed.
- (b) A damp-proofing membrane need not be provided if—
- (i) weatherproofing is not *required*; or

- (ii) the floor is the base of a stair, lift or similar *shaft* which is adequately drained by gravitation or mechanical means.

Delete F1.11 and insert SA F1.11 as follows:

SA F1.11 Provision of floor wastes

Grading and draining of wet area floors must comply with Minister’s Specification SA F1.7.

PART F2 SANITARY AND OTHER FACILITIES

Delete F2.3(a) and insert SA F2.3(a) as follows:

SA F2.3 Facilities for Class 3 to 9 buildings

- (a) Sanitary facilities must be provided—
 - (i) for Class 3, 5, 6, 7, 8 and 9 buildings in accordance with **Table F2.3**, with the exception of Class 9b *schools*; and
 - (ii) for Class 9b *schools* in accordance with **SA Table F2.3**.

Vary Table F2.3 by deleting section 9b-*Schools* and replacing it with the following:

SA Table F2.3 Sanitary Facilities in Class 3, 5, 6, 7, 8 and 9 buildings

Class of Building	User	Max Number Served by									
		Closet Fixture(s)				Urinal(s)			Washbasin(s)		
		1	2	Each Extra- up to 100	Each Extra- over 100	1	2	Each Extra	1	2	Each Extra
9b — <i>Schools</i> , not being primary or secondary <i>schools</i>	Employees										
	Males	20	40	20	20	20	45	30	30	60	30
	Females	5	20	15	15				30	60	30
	Students										
	Males	30	70	70	70	30	70	35	20	40	40
	Females	10	20	20	20				20	40	40
9b — <i>schools</i> being primary and secondary <i>schools</i>	Employees										
	Males	10	30	20		10	30	20	15	30	20
	Females	6	15	10					15	30	20
	Students										
	Males	20	50	50	100	10	50	100	10	50	75
	Females	10	25	25	50				10	50	75

Class of Building	User	Max Number Served by								
		Closet Fixture(s)				Urinal(s)			Washbasin(s)	
		1	2	Each Extra- up to 100	Each Extra- over 100	1	2	Each Extra	1	2

Add the following notes to Table F2.3 and SA Table F2.3:

Additional NOTES to Table F2.3 and SA Table F2.3:

A unisex facility shall comprise of one closet pan, one washbasin and means of disposal of sanitary towels.

Buildings of more than one *storey* — in a building of more than one *storey*—

- (a) where more than 50 persons are employed in a single *storey*, sanitary facilities must be provided on that *storey*.
- (b) sanitary facilities must not be more than one *storey* away from any work area.

Other facilities — Occupational Health, Safety & Welfare Regulations require that showers and changing facilities be provided in some work places, depending on the nature of the work and working conditions of the employees.

Delete F2.4(a)(i) and insert SA F2.4(a)(i) as follows:

SA F2.4 Facilities for people with disabilities

- (a) Sanitary facilities must be provided in accordance with **SA Table 2.4** for—
 - (i) every Class 2, 3, 5, 6, 7, 8 and 9 building that is *required* by the *Deemed-to-Satisfy Provisions* of **Part D3** to be *accessible* to people with disabilities and may be calculated as part of the number of facilities *required* by **Table F2.3**; and

Delete Section of **Table F2.4** referring to Class 3 buildings and insert **SA Table F2.4** as follows:

SA Table F2.4 Sanitary Facilities for people with disabilities

Class of building	Minimum facility for use by people with disabilities
Classes 2 and 3 — In every <i>sole-occupancy unit</i> to which access for people with disabilities is <i>required</i>	<ul style="list-style-type: none"> (a) One closet pan and washbasin; and (b) one shower.

SECTION G ANCILLARY PROVISIONS

PART G1 MINOR STRUCTURES AND COMPONENTS

After G1.1(c) insert SA G1.1(d) and (e) as follows:

SA G1.1 Swimming pools

- (d) **Pump Intakes:** For the purpose of clause 5.1 of AS 1926.3, a skimmer box is an outlet.

- (e) **Warning Notice:** Wherever a manual shut-off valve is fitted to a secondary outlet from a *swimming pool*, a permanent label must be fixed to the valve. The label must be in capital letters not less than 25 mm high, in a colour contrasting with the background and printing that is resistant to ultra-violet light, water and pool chemicals, and state:

WARNING

**RE-OPEN THIS VALVE IMMEDIATELY AFTER USING A VACUUM CLEANER
THE POOL MUST NOT BE USED WHILE A VACUUM CLEANER IS IN USE**

PART G5 CONSTRUCTION IN BUSHFIRE PRONE AREAS

Delete G5.2 and insert SA G5.2

SA G5.2 Protection

A Class 2 or 3 building, and a Class 10 building that adjoins a Class 2 or 3 building, located in a *designated bushfire prone area*, must comply with—

- (a) the low category of bushfire attack provisions in **SA G5.3(a)** if the *site* is identified as a general bushfire risk area in a South Australian Development Plan; or
- (b) the medium category of bushfire attack provisions in AS 3959 and the additional requirements of **SA G5.3(b)** if the *site* is identified as a medium bushfire risk area in a South Australian Development Plan; or
- (c) the category of bushfire attack provisions assessed for the *site* in accordance with AS 3959 and the additional requirements of **SA G5.3(b)** if the *site* is identified as a high bushfire risk area in a South Australian Development Plan,

with the exception that seasoned or dry hardwood timber (as defined in AS 1720.2) with a minimum density at 12% moisture content of 650 kg/m³, may be used in lieu of fire retardant treated timber.

Add SA G5.3 as follows:

SA G5.3 Additional Protection

- (a) Bushfire protection must be provided in low bushfire attack categories (as determined from **SA G5.2**) as follows:
 - (i) Flooring systems must be—
 - (A) concrete slab on ground; or
 - (B) suspended concrete floor; or
 - (C) a framed floor, the underside of which is greater than 600 mm above ground level where the sub-floor space is completely protected by—
 - (aa) a *non-combustible* sheet material; or
 - (bb) a wall complying with AS 3959; or
 - (cc) a vertical *non-combustible* sheet material that extends around the perimeter of the floor from the underside of the lowest framing member to ground level; or
 - (dd) if fibre reinforced cement sheets are used as a *non-combustible* sheet material they must have a minimum thickness of 6 mm; or

- (D) a framed floor where any joist and/or bearer is less than 600 mm above finished ground level where—
- (aa) any timber bearers, joists or flooring are of fire-retardant-treated timber; or
 - (bb) the sub-floor space is fully enclosed with a wall complying with the medium bushfire attack category requirements of AS 3959 for an *external wall*; or
 - (cc) the sub-floor space is fully enclosed with *non-combustible* sheet material that extends not less than 400 mm above finished ground level and to the bottom of the wall cladding material. If fibre reinforced cement sheets are used for this purpose, the sheets must have a minimum thickness of 6 mm.
- (ii) Supporting posts, columns, stumps, piers and poles (except in sub-floor spaces enclosed by one of the methods described in (i)(D)) must be constructed from—
- (A) *non-combustible* material; or
 - (B) fire-retardant-treated timber for not less than 400 mm above finished ground level; or
 - (C) timber mounted on metal stirrups with a clearance of not less than 75 mm above finished ground or paving level.
- (iii) Vents to sub-floor spaces must be protected with spark guards made from corrosion resistant steel, bronze or aluminium mesh with a maximum aperture size of 1.8 mm.
- (iv) Verandahs and decks must be—
- (A) slab on ground or suspended concrete slab.
 - (B) any supporting posts or columns must comply with (a)(ii).
 - (C) any supporting walls must comply with the medium bushfire attack category requirements of AS 3959 for *external walls*, with the exception that wall cladding of *non-combustible* material or fire-retardant-treated timber must be provided within 400 mm of finished ground level, paving level or any balcony or deck with solid flooring.
 - (D) where sheeted or tongued and grooved solid flooring is used, the flooring system must comply with (a)(i).
 - (E) where a timber deck is used—
 - (aa) the gap between the timber deck flooring must not be less than 5 mm; and
 - (bb) to facilitate access for extinguishment, the perimeter of the deck must not be enclosed or access to the space beneath the deck impeded; and
 - (cc) the timber deck flooring must be separated from the remainder of the building in a manner that will not spread the fire into the building.
- (b) Additional bushfire protection must be provided in medium, high and extreme bushfire attack categories (as determined from SA G5.2) as follows—
- (i) a framed floor, the underside of which is greater than 600 mm above ground level must have the sub-floor space completely protected by—

- (A) a wall complying with AS 3959; or
 - (B) a *non-combustible* sheet material; or
 - (C) a vertical *non-combustible* sheet material that extends around the perimeter of the floor from the underside of the lowest framing member to ground level; or
 - (D) if fibre reinforced sheets are used as a *non-combustible* sheet material they must have a minimum thickness of 6 mm; and
- (ii) wall cladding of *non-combustible* material or fire-retardant timber must be provided within 400 mm of finished ground level, paving level or any balcony or deck with solid flooring; and
- (iii) penetrations through the roof cladding of vent pipes and the like must be sealed with a *non-combustible* collar or fire-retardant sealant.

Add SA Part G7 as follows:

SA PART G7 ACCESS FOR MAINTENANCE

OBJECTIVE

SA G07

The *Objectives* of this Part are—

- (a) to safeguard people from injury while cleaning *windows*; and
- (b) to safeguard people from injury or illness resulting from the creation of hazardous spaces between buildings.

FUNCTIONAL STATEMENTS

SA GF7.1

A building is to provide people with safe conditions for carrying out *window* cleaning operations.

SA GF7.2

The space between buildings must not allow hazardous conditions to arise due to accumulation of rubbish that cannot readily be removed.

PERFORMANCE REQUIREMENTS

SA GP7.1

Where any part of a *window* in a building is more than 5.5 m above ground level, provision must be made for safe access to the external surface of the *window* for minor maintenance and cleaning.

SA GP7.2

The space between buildings must be sufficient to allow access for inspection and maintenance, to avoid hazardous conditions arising due to accumulation of rubbish that could—

- (a) bridge termite barriers; or
- (b) harbour vermin; or
- (c) create a *fire hazard*.

SA G7.0 Deemed-to-Satisfy Provisions

Performance Requirements SA GP7.1 and *SA GP7.2* are satisfied by complying with *SA G7.1* to *SA G7.3*.

SA G7.1 Application of Part

The following provisions apply to Class 2 to 9 buildings.

SA G7.2 Access for window cleaning

Where any part of a *window* in a building is more than 5.5 m above ground level, access to the external surface of the *window* for minor maintenance and cleaning must be provided. Any of the following methods are acceptable—

- (a) by means of a moveable gantry; or
- (b) by means of reversible pivoting sashes, each of which has catches that secure the sash in either the normal or reversed position and give visual indication that the *window* is secure, provided that where a *window* sill is less than 900 mm above floor level, safety anchorages are provided; or
- (c) by means of safety harness, having all anchorages—
 - (i) designed and installed in accordance with AS/NZS 1891.4; and
 - (ii) constructed of approved corrosion resistant metal; or
- (d) by means of opening sashes, in which case the maximum reach to the farthest part of the *window* must not exceed 500 mm upwards or 1 m sideways or downwards and provided that where the *window* sill is less than 900 mm above floor level, safety anchorages are provided.

SA G7.3 Access for inspection and maintenance between buildings

Every part of an *external wall* of a building must be not less than 600 mm from—

- (a) the *external wall* of any other building on the same allotment, unless the two buildings are abutting; or

(b) any boundary of the allotment, unless that wall is on or abutting that boundary, unless the space between external columns is not infilled.

Add SA Part G8 as follows:

SA PART G8 MISCELLANEOUS PROVISIONS

OBJECTIVE

SA G08

The *Objective* of this Part is to safeguard people from injury resulting from hazardous conditions being created by building attachments.

FUNCTIONAL STATEMENT

SA GF8.1

A building is to be provided with safeguards to prevent a building attachment—

- (a) collapsing; and
- (b) creating hazardous conditions by its water run-off; and
- (c) affecting adjacent road safety conditions by its projection; and
- (d) creating a *fire hazard* above a street.

PERFORMANCE REQUIREMENT

SA GP8.1

An attachment to a building must incorporate features that will—

- (a) protect it against corrosion; and
- (b) collect and discharge its rainwater run-off safely; and
- (c) prevent its projection affecting adjacent road safety conditions or pedestrian traffic; and
- (d) provide resistance to the spread of fire if it overhangs a street boundary,

to a degree necessary to avoid creating hazardous conditions that may cause injury to people passing below or driving past.

SA G8.0 Deemed-to-Satisfy Provisions

Performance Requirement SA GP8.1 is satisfied by complying with **SA G8.1** and **SA G8.2**.

SA G8.1 Application of Part

The following provisions apply to Class 2 to 9 buildings.

SA G8.2 Attachments to buildings

- (a) An attachment to a building that is in the nature of a balcony or awning, bridge, gangway, hoarding or trade sign, sky sign, mast, flagpole, tower, aerial or antenna, lantern, cathead, crane, chimney, flue or duct, or an installation for cleaning and maintenance access must—
 - (i) have all metal parts of corrosion resistant metal, or other metal suitably protected;
 - (ii) not overhang any street boundary at a height less than 2.5 m above the footpath, or 4 m above the roadway; and
 - (iii) be provided with drainage to prevent rainwater or condensate falling onto or running across the footpath, unless either it is a retractable awning in the nature of a sun blind, or unless the total catchment area for run-off is less than 1.5 m².
- (b) A balcony or awning that overhangs a street boundary—
 - (i) must not extend closer than 450 mm to the kerb of the roadway; and
 - (ii) must be constructed of *non-combustible* or fire-retardant materials throughout, except that timber battens may be used to support the soffit lining.

SECTION H SPECIAL USE BUILDINGS

SA PART H2 BULK GRAIN STORAGE FACILITIES

SA H2.1 Application of Part

This Part applies to certain Class 7 buildings erected for commercial bulk handling and storage of granular materials such as grain, ore, or the like, where only a small number of occupants are present at one time.

SA H2.2 Concessions for bulk grain storage facilities

Compliance with Minister's Specification SA H2.2 — "Construction of bulk grain storage facilities" is deemed-to-satisfy the *Performance Requirements* of **Sections C, D, E and F**, as applicable, for cell type silos and large grain storage and handling sheds.

SA PART H3 FARM BUILDINGS

SA H3.1 Application of Part

This Part applies to Class 7 or 8 buildings used for certain farming purposes.

SA H3.2 Concessions and additions for farm buildings

Class 7 and 8 farm buildings complying with Minister's Specification SA H3.2 — 'Concessions and additional requirements for farm buildings' and all other relevant BCA *Deemed-to-Satisfy*

Provisions not varied by the Minister's Specification are deemed to satisfy the *Performance Requirements* of the BCA.

SECTION I MAINTENANCE

PART I1 EQUIPMENT AND SAFETY INSTALLATIONS

Delete I1.1 and insert SA I1.1 as follows:

SA I1.1 Safety installations

Safety measures must—

- (a) perform to a standard not less than the standard they were originally required to achieve; and
- (b) for those safety measures listed in **Tables I1.1 to I1.13**, perform to a standard not less than that determined using the corresponding BCA provisions as required at installation; and
- (c) safety measures listed in **Tables I1.1 to I1.11 and I1.13** are 'essential safety provisions' that must be maintained in accordance with regulation 76 of the Development Regulations 1993; and
- (d) Compliance with Minister's Specification SA 76 is deemed-to-satisfy (a), (b) and (c).

Delete I1.2 and insert SA I1.2 as follows:

SA I1.2 Mechanical ventilation and hot water, warm water and cooling water systems

Mechanical ventilation and hot water, warm water and cooling water systems in a building other than a system only serving a single *sole-occupancy unit* in a Class 2 or 3 building or Class 4 part must be maintained in accordance with item 3.6(f) of Minister's Specification SA 76.

SECTION J ENERGY EFFICIENCY

Insert SA JP3 as follows:

Performance Requirement

SA JP3

Heated water services must have greenhouse gas emission profiles not exceeding 300 kilograms of carbon dioxide equivalent per gigajoule of heated water (300 kgCO₂-e/GJ).

Limitation:

SA JP3 applies to heated water services that serve a single *sole-occupancy unit* in—

- (a) a Class 2 building; or

- (b) an alteration or an addition to a single *sole-occupancy unit* in a Class 2 building, that involves the installation of a new or replacement heated water service.

Insert SA JV4 after SA JP3 as follows:

Verification Method

SA JV4

Compliance with *Performance Requirement SA JP3* is verified when greenhouse gas emissions calculated using the method described below do not exceed the specified *Performance Requirement*.

- (a) Determine the peak daily thermal demand to be met by the heated water service (in MJ). This must be the value for either the large or small household demand, as specified for Zone 3, from Table A2 of Appendix A of AS 4234, subject to the restriction outlined in A4.1 of AS 4234.
- (b) Calculate the annual hot water demand (in GJ per year of delivered heat) by summing the daily hot water demand (in MJ) for each day of a continuous 365-day calendar year, and then multiplying the result by 0.001. For each day, the daily hot water demand is determined by multiplying the peak daily thermal demand by the relevant seasonal load profile load multiplier from Table A4 of AS 4234.
- (c) Calculate the annual energy used (in MJ) as follows:
 - (i) For **electric heated water services**, calculate the annual energy used (in MJ) to supply the annual hot water demand. The hourly and seasonal load profile shall be set out as in Table A3 and A4 and the cold water temperature for Zone 3 as in Table A5 of AS 4234. The calculation should use the actual performance parameters for the heated water service as measured in AS 1056.1.
 - (ii) For **natural gas or LPG heated water services**, calculate the annual energy used (in MJ) to supply the annual hot water demand. The hourly and seasonal load profile shall be set out as in Table A3 and A4 and the cold water temperature for Zone 3 as in Table A5 of AS 4234. The calculation should use the actual performance parameters for the heated water service as measured in AS 4552 and the calculation procedure in AS 4552.
 - (iii) For **solar heated water services (electric or gas boosted) and heat pump heated water services**, calculate the annual energy used (in MJ) to supply the annual hot water demand, as per the performance evaluation procedures in AS 4234.
 - (iv) For **other types of heated water services**, calculate annual energy used (in MJ) to supply the annual hot water demand as per the calculation procedure in AS 4234, based on the relevant load profiles defined in Tables A3, A4, A5 and A6 of AS 4234.
- (d) Calculate the annual greenhouse gas emissions (in kgCO₂-e/y) by multiplying the annual energy used for the heated water service (in MJ per year) by 0.001, and then multiplying the result by the relevant South Australian full fuel cycle greenhouse coefficient (in kgCO₂-e/GJ), as published in the most recent version of the Australian Government Department of Climate Change's National Greenhouse Accounts (NGA) Factors publication.

- (e) Calculate the average greenhouse gas emissions per unit of delivered heat (in kgCO₂-e/GJ) by dividing the annual greenhouse gas emissions (in kgCO₂-e/y) by the annual hot water demand (in GJ per year of delivered heat).

PART J3 BUILDING SEALING

Delete J3.1 and insert SA J3.1

SA J3.1 Application of Part

The Deemed-to-Satisfy Provisions of this Part do not apply to-

- (a) a permanent building *ventilation opening*, in a space where a gas appliance is located, that is necessary for the safe operation of a gas appliance; or
- (b) a Class 6, 7, 8 and 9b building that does not have a *conditioned space*; or
- (c) a building or space where the mechanical ventilation *required* by **Part F4** provides sufficient pressurisation to prevent infiltration; or
- (d) an atrium or solarium that is not a *conditioned space* and is separated from the remainder of the building by an *envelope*.

Delete J3.3(a) and insert SA J3.3(a)

SA J3.3 Roof lights

- (a) In a Class 5 to 9 building, a *roof light* must be sealed, or capable of being sealed, when serving a *conditioned space* or a *habitable room*.

Delete J3.4 and insert SA J3.4

SA J3.4 Windows and doors

- (a) In Class 2 and 3 buildings and Class 4 parts of buildings, external swing doors must be fitted with a draught protection device to the bottom edge of each leaf.
- (b) In a Class 5 to 9 building, a seal to restrict air infiltration must be fitted to each edge of a door, openable *window* or the like forming part of—
 - (i) the *envelope* of a *conditioned space*; or
 - (ii) the external fabric of a *habitable room* or public area.
- (c) The requirements of **(a)** and **(b)** do not apply to—
 - (i) a *window* complying with AS 2047; or
 - (ii) a louvre door, louvre *window*, or other such opening; or
 - (iii) a fire door or smoke door; or
 - (iv) a roller shutter door, roller shutter grille or other security door or device installed only for out-of-hours security.
- (d) A seal required by **(b)** may be a foam or rubber compressible strip, fibrous seal or the like.
- (e) A main entrance to a Class 5 to 9 building, if leading to a *conditioned space*, must have an airlock, *self-closing* door, revolving door or the like, other than—
 - (i) where the *conditioned space* has a *floor area* of not more than 50 m²; or

- (ii) where a café, restaurant, open front shop or the like has—
 - (A) a 3 m deep un-conditioned zone between the main entrance, including an open front, and the *conditioned space*; and
 - (B) all other entrances to the café, restaurant, open front shop or the like, have *self-closing* doors.

Delete J3.5 and insert SA J3.5

SA J3.5 Exhaust fans

A miscellaneous exhaust fan, such as a bathroom or domestic kitchen exhaust fan, must be fitted with a sealing device such as a self-closing damper or the like when serving a *conditioned space* or a *habitable room*.

Delete J3.6(a) and insert SA J3.6(a)

SA J3.6 Construction of roofs, walls and floors

- (a) In a Class 5 to 9 building, roofs, walls, floors and any opening such as a *window*, door or the like must be constructed to minimise air leakage in accordance with **(b)** when forming part of the—
 - (i) *envelope* of a *conditioned space*; or
 - (ii) the external fabric of a *habitable room* or public area.

Delete J3.7 and insert SA J3.7

SA J3.7 Evaporative coolers

An evaporative cooler must be fitted with a self-closing damper or the like when serving a heated space, a *habitable room* or a public area of a building.

SA PART J7 HEATED WATER SERVICES

Delete Part J7 and insert SA Part J7 as follows:

SA J7.0 Deemed-to-Satisfy Provisions

Performance Requirement SA JP3 is satisfied by complying with SA J7.1 and SA J7.2.

SA J7.1 Application of Part

The following provisions apply to heated water services that serve a single *sole-occupancy unit* in—

- (a) a Class 2 building; or
- (b) an alteration or an addition to a single *sole-occupancy unit* in a Class 2 building, that involves the installation of a new or replacement heated water service.

SA J7.2 Complying heated water services

A heated water service must be one of the following:

- (a) An electric heated water service with a **rated hot water delivery**, if applicable, of 700 litres or less.

- (b) A natural gas or LPG heated water service (instantaneous, continuous flow or storage) that has an **Energy Rating label** of 2.5 stars or more and a tank volume, if applicable, of 700 litres or less.

Note:

Energy Ratings are provided for each model of gas heated water service in the Australian Gas Association Directory of certified gas appliances and components.

- (c) A solar heated water service (electric, natural gas or LPG boosted) or heat pump heated water service (air source or solar boosted), with a total tank volume of 700 litres or less, that is eligible for any number of *Renewable Energy Certificates*.

Note:

Numbers of *Renewable Energy Certificates* are provided for each model of solar heated water service, and are listed in Schedule 7, Part 2 of the (Commonwealth) Renewable Energy (Electricity) Regulations 2001.

- (d) A wood combustion heated water service, with no additional heating mechanisms, with a total tank volume of 700 litres or less.

- (e) A wood combustion boosted solar heated water service, with no additional heating mechanisms, with a total tank volume of 700 litres or less.

Note:

The design and installation of heated water services in South Australia is regulated by Directions issued by the South Australian Water Corporation pursuant to Regulation 17 of the Waterworks Regulations 1996.

Footnote: OTHER LEGISLATION AFFECTING BUILDINGS

In addition to any applicable provisions of the Development Act 1993, the Development Regulations 1993 and this Code, there are a number of other legislative technical requirements affecting the design, construction and/or performance of buildings that practitioners may need to be aware of, including, but not necessarily limited to, the following list. Additional legislative instruments such as regulations, codes and standards may exist under the legislation listed.

1. Abattoirs

1.1 **Administering agency:**

Department of Health

Relevant legislation:

Food Act 2001

Food Regulation 2002

1.2 **Administering agency:**

Department of Primary Industries and Resources

Relevant legislation:

Primary Produce (Food Safety Schemes) Act 2004

Primary Produce (Food Safety Schemes)(Meat Industry) Regulations 2006

2. Accommodation

2.1 Administering agency:

Department for Families and Communities

Relevant legislation:

Supported Residential Facilities Act 1992

Supported Residential Facilities Regulations 1994

3. Asbestos Removal

3.1 Administering agency:

SafeWork SA, Department of the Premier and Cabinet

Relevant legislation:

Occupational Health, Safety and Welfare Act 1986

Occupational Health, Safety and Welfare Regulations 1995

4. Children's Services

4.1 Administering agency:

Department of Education and Children's Services

Relevant legislation:

Children's Services Act 1985

Children's Services (Child Care Centre) Regulations 1998

5. Crown Land

5.1 Administering agency:

Department for Environment and Heritage

Relevant legislation:

Crown Lands Act 1929

6. Dairies

6.1 Administering agency:

Department of Primary Industries and Resources

Relevant legislation:

Primary Produce (Food Safety Schemes) Act 2004

Primary Produce (Food Safety Schemes)(Dairy Industry) Regulations 2005

7. Dangerous Goods

7.1 Administering agency:

Department of Health

Relevant legislation:

- Controlled Substances Act 1984
- Controlled Substances (Pesticides) Regulations 2003
- Controlled Substances (Poisons) Regulations 1996

7.2 **Administering agency:**

Safework SA, Department of the Premier and Cabinet

Relevant legislation:

- Dangerous Substances Act 1979
- Dangerous Substances Regulations 2002
- Explosives Act 1936
- Explosives Regulations 1996
- Explosives (Fireworks) Regulations 2001
- Explosives (Security Sensitive Substances) Regulations 2006

8. Electrical Installations

8.1 **Administering agency:**

Office of the Technical Regulator, Department of Transport, Energy and Infrastructure

Relevant legislation:

- Electricity Act 1996
- Electricity (General) Regulations 1997

9. Fences

9.1 **Administering agency:**

Department of Justice

Relevant legislation:

- Fences Act 1975

10. Fire Prevention in Existing Buildings

10.1 **Administering agency:**

Planning SA, Department of Primary Industries and Resources

Relevant legislation:

- Development Act 1993
- Development Regulations 1993

10.2 **Administering agency:**

SA Fire and Emergency Services Commission

Relevant legislation:

Fire and Emergency Services Act 2005
Fire and Emergency Services Regulations 2005

11. Food Premises

11.1 Administering agency:

Department of Health

Relevant legislation:

Food Act 2001

Food Regulations 2002

12. Gas Installations

12.1 Administering agency:

Office of the Technical Regulator, Department of Transport, Energy and Infrastructure

Relevant legislation:

Gas Act 1997

Gas Regulations 1997

13. Historic Buildings

13.1 Administering agency:

Department for Environment and Heritage

Relevant legislation:

Heritage Places Act 1993

14. Housing

14.1 Administering agency:

Department for Families and Communities

Relevant legislation:

Housing Improvement Act 1940

Housing Improvement (Standards) Regulations 1992

15. Hospitals, Nursing Homes and Health Care Buildings

15.1 Administering agency:

Department of Health

Relevant legislation:

South Australian Health Commission Act 1976

South Australian Health Commission (Private Hospitals) Regulations 2000

16. Licensed Premises

16.1 Administering agency:

Office of Liquor and Gambling Commissioner, Department of Justice

Relevant legislation:

Liquor Licensing Act 1997

Liquor Licensing (General) Regulations 1997

17. Lift Installations

17.1 Administering agency:

Safework SA, Department of the Premier and Cabinet

Relevant legislation:

Occupational Health, Safety and Welfare Act 1986

Occupational Health, Safety and Welfare Regulations 1995

18. Movable Dwellings (in caravan parks)

18.1 Administering agency:

Office of Consumer and Business Affairs, Attorney General's Department

Relevant legislation:

Residential Tenancies Act 1995

Residential Tenancies (General) Regulations 1995

19. Occupational Health and Safety

19.1 Administering agency:

SafeWork SA, Department of the Premier and Cabinet

Relevant legislation:

Occupational Health, Safety and Welfare Act 1986

Occupational Health, Safety and Welfare Regulations 1995

20. Pharmacies

20.1 Administering agency:

Department of Health

Relevant legislation:

Pharmacists Act 1991

Pharmacists Regulations 2006

21. Prisons and Jails

21.1 Administering agency:

Department for Correctional Services

Relevant legislation:

Correctional Services Act 1982

22. Radiation Safety

22.1 Administering agency:

Environmental Protection Authority

Relevant legislation:

Radiation Protection and Control Act 1982

Radiation Protection and Control (Ionising Radiation) Regulations 2000

23. School (non-government)

23.1 Administering agency:

Department of Education and Children's Services

Relevant legislation:

Education Act 1972

24. Sanitary Plumbing, Water Supply and Sewerage

24.1 Administering agency:

South Australian Water Corporation

Relevant legislation:

Sewerage Act 1929

Sewerage Regulations 1996

Waterworks Act 1932

Waterworks Regulations 1996

25. Septic Tank and Grey Water Installations

25.1 Administering agency:

Department of Health

Relevant legislation:

Public and Environmental Health Act 1987

Public and Environmental Health (Waste Control) Regulations 1995

26. Smoking Restrictions

26.1 Administering agency:

Department of Health

Relevant legislation:

Tobacco Products Regulation Act 1997

Tobacco Products Regulations 2004

27. Subdivision of Property

27.1 Administering agency:

Land Services Group, Department for Transport, Energy and Infrastructure

Relevant legislation:

Community Titles Act 1996

Community Titles Regulations 1996

Real Property Act 1886

Real Property (Land Division) Regulations 1995

Strata Titles Act 1988

Strata Titles Regulations 2003

28. Waste management and environment protection

28.1 Administering agency:

Environment Protection Authority

Relevant legislation:

Environment Protection Act 1993

Environment Protection (General) Regulations 1994

28.2 Administering agency:

SA Water Corporation

Relevant legislation:

Sewerage Act 1929

Sewerage Regulations 1996

TASMANIA

INTRODUCTION

The Tasmania BCA Appendix includes variations from the requirements of the 2009 edition of the Building Code of Australia (BCA) and additional requirements resulting from the consolidation in Tasmania of all building-related regulations into the BCA.

The variations from the requirements of the BCA apply to the construction or alteration of all buildings in Tasmania and the extra requirements apply to all workplaces and special-use buildings.

APPENDIX CONTENTS

APPENDIX TASMANIA

Tasmania

A GENERAL PROVISIONS

Tas A1.1 Definitions
Tas Specification A1.3 Standards Adopted By Reference

E SERVICES AND EQUIPMENT

Tas EO1 Objectives
Tas EF1.2 Functional Statements
Tas EP1.7 Performance Requirements
Tas E1.0 Deemed-to-Satisfy Provisions
Tas E1.101 Fire detection and alarm system

F HEALTH AND AMENITY

Tas Table F2.3 Sanitary Facilities in Class 3, 5, 6, 7, 8 and 9 buildings
Tas F2.101 Non-flushed Urinals
Tas F2.102 Installation of Closet Fixtures
Tas F4.101 Fixed Natural Ventilation

G ANCILLARY PROVISIONS

TAS PART G1 MINOR STRUCTURES AND COMPONENTS

Tas GO1 Objectives
Tas GF1.4 to GF1.6 Functional Statements
Tas GP1.5 to GP1.9 Performance Requirements
Tas G1.0 Deemed-to-Satisfy Provisions
Tas G1.1 Swimming Pools

TAS PART G2 HEATING APPLIANCES, FIREPLACES, CHIMNEYS AND FLUES

Tas G02 Objective
Tas GF2.1 Functional Statement
Tas GP2.1 Performance Requirement
Tas G2.2 Installation of appliances

TAS PART G101 PROJECTIONS OVER WAYS

Tas G101.1 Construction and location of projections over ways
Tas G101.2 Protection of Ways

H SPECIAL USE BUILDINGS

Tas Part H101 - Tas Part H121 Objectives

TAS PART H101 WORKPLACES

- Tas H101.1 Application of Part
- Tas H101.2 Floor area
- Tas H101.3 Floor surfaces
- Tas H101.4 Floor drainage
- Tas H101.5 Floor covering
- Tas H101.6 Overhead clearance
- Tas H101.7 Lighting
- Tas H101.8 Ventilation
- Tas H101.9 Toilet facilities
- Tas H101.10 Hand washing facilities
- Tas H101.11 Shower facilities
- Tas H101.12 Change rooms
- Tas H101.13 Dining rooms
- Tas H101.14 Rest rooms
- Tas H101.15 First aid rooms and health centres
- Tas H101.16 Doors

TAS PART H102 FOOD PREMISES

- Tas H102 O1 Objective
- Tas H102 F1 Functional Statement
- Tas H102 P1 to H102 P12 Performance Requirements
- Tas H102.0 Application of Part
- Tas H102.1 Deemed-to-Satisfy Provisions
- Tas H102.2 General Requirements
- Tas H102.3 Pests and contaminants
- Tas H102.4 Drains and Pipes
- Tas H102.5 Offensive material and trade waste
- Tas H102.6 Ventilation
- Tas H102.7 Lighting
- Tas H102.8 Floors, walls and ceilings
- Tas H102.9 Separation of work place
- Tas H102.10 Washbasins
- Tas H102.11 Sinks
- Tas H102.12 Design, construction and installation of fixtures, fittings and equipment
- Tas H102.13 Storage of materials and equipment
- Tas H102.14 Food store
- Tas H102.15 Meat Premises
- Tas H102.16 Dairy produce
- Tas H102.17 Refrigerated and cooling chambers

TAS PART H103 DINING ROOMS AND BAR ROOMS

- Tas H103.1 Application of Part
- Tas H103.2 Sanitary facilities
- Tas H103.3 Separation from other areas

TAS PART H104 * * * * *

TAS PART H105 * * * * *

TAS PART H106 MEAT PREMISES

- Tas H106.1 Application of Part
- Tas H106.2 Premises Processing Animals and Meat

TAS PART H107 FARM DAIRY PREMISES

- Tas H107.1 Application of this Part
- Tas H107.2 Milking Sheds and Holding Yards
- Tas H107.3 Milk Receiving Area and Milk Storage Room
- Tas H107.4 Water supply

TAS PART H108 PHARMACIES

- Tas H108.1 Application of Part
- Tas H108.2 Definition
- Tas H108.3 Pharmacy premises
- Tas H108.4 Dispensary
- Tas H108.5 Security of dispensary

TAS PART H109 HOSPITALS AND NURSING HOMES

- Tas H109.1 Application of Part
- Tas H109.2 Floor area of wards and bedrooms
- Tas H109.3 Floor and walls
- Tas H109.4 Grab rails
- Tas H109.5 Insect proofing

TAS PART H110 PREMISES USED FOR ACTIVITIES INVOLVING SKIN PENETRATION

- Tas H110.1 Application of Part
- Tas H110.2 Sanitary facilities
- Tas H110.3 Washbasins

TAS PART H111 DENTAL SURGERIES AND CHIROPRACTORS' PREMISES

- Tas H111.1 Application of Part
- Tas H111.2 Waiting room
- Tas H111.3 Floor, walls and ceiling
- Tas H111.4 Disposal of liquid wastes

TAS PART H112 MORTUARIES

- Tas H112.1 Application of Part
- Tas H112.2 Layout of mortuary
- Tas H112.3 Construction of body preparation room
- Tas H112.4 Water supply and sewerage

TAS PART H113 FOUNDRIES

- Tas H113.1 Application of Part
- Tas H113.2 General
- Tas H113.3 Cupola charging platform
- Tas H113.4 Deep moulds and pits
- Tas H113.5 Pot furnaces

**TAS PART H114 PREMISES FOR MANUFACTURE OR PROCESSING OF GLASS
REINFORCED PLASTICS**

- Tas H114.1 Application of Part
- Tas H114.2 Separation from other buildings
- Tas H114.3 Rise in storeys
- Tas H114.4 Maximum floor areas
- Tas H114.5 Required exits
- Tas H114.6 Hand laminating and spray depositing
- Tas H114.7 Ventilation
- Tas H114.8 Smoke and heat roof vents

TAS PART H115 PREMISES FOR PRODUCTION OR PROCESSING OF ISOCYANATES

- Tas H115.1 Application of Part
- Tas H115.2 Areas of work places
- Tas H115.3 Separation from other areas and buildings
- Tas H115.4 Rise in storeys
- Tas H115.5 Maximum floor areas
- Tas H115.6 Required exits
- Tas H115.7 Bulk stores for polyols and isocyanates
- Tas H115.8 Curing room

**TAS PART H116 PREMISES FOR ELECTRO-PLATING ELECTRO-POLISHING,
ANODISING OR ETCHING**

- Tas H116.1 Application of Part
- Tas H116.2 Floors
- Tas H116.3 Height of plating area
- Tas H116.4 Air space
- Tas H116.5 Ceiling construction

TAS PART H117 PREMISES FOR LEAD PROCESSING

- Tas H117.1 Application of Part
- Tas H117.2 Floors
- Tas H117.3 Height of lead processing areas
- Tas H117.4 Air space and floor space
- Tas H117.5 Interior of lead processing areas
- Tas H117.6 Dust collection
- Tas H117.7 Isolation of certain processes
- Tas H117.8 Drying room shelves
- Tas H117.9 Washing facilities
- Tas H117.10 Change rooms

TAS PART H118 BOOTHS FOR SPRAY PAINTING OR SPRAY COATING

- Tas H118.1 Application of Part
- Tas H118.2 Design and construction of booths

TAS PART H119 ELECTRICITY DISTRIBUTION SUBSTATIONS

- Tas H119.1 Application of Part
- Tas H119.2 Building-type substations

TAS PART H120 PREMISES FOR STORAGE OF DANGEROUS GOODS

- Tas H120.1 Application of Part
- Tas H120.2 Interpretation
- Tas H120.3 Class of dangerous goods
- Tas H120.4 Premises for storage of dangerous goods
- Tas H120.5 Workrooms
- Tas H120.6 Exits
- Tas H120.7 Explosion vents
- Tas H120.8 Spill Collection Bunds
- Tas H120.9 Electrical equipment

TAS PART H121 HAIRDRESSERS' PREMISES

- Tas H121.1 Application of Part
- Tas H121.2 Size of operating section
- Tas H121.3 Premises in a residence
- Tas H121.4 Sanitary facilities

TAS PART H122 CENTRE-BASED CHILD CARE FACILITIES

- Tas H122 O1 Objective
- Tas H122 F1 Functional Statement
- Tas H122 P1 to H122 P3 Performance Requirements
- Tas H122.0 Application of Part
- Tas H122.1 Deemed-to-Satisfy Provisions
- Tas H122.2 Indoor play space
- Tas H122.3 Outdoor play space
- Tas H122.4 Sleep space
- Tas H122.5 Sanitary facilities
- Tas H122.6 Nappy changing facilities
- Tas H122.7 Laundry facilities
- Tas H122.8 Floor surfaces
- Tas H122.9 Food preparation facilities
- Tas H122.10 Reception, administration and staff respite areas
- Tas H122.11 Storage facilities
- Tas H122.12 Lighting and ventilation
- Tas H122.13 Fire safety
- Tas H122.14 Glazing and windows
- Tas H122.15 Heating and Cooling
- Tas H122.16 Fences and barriers

TAS PART H123 TEMPORARY STRUCTURES

- Tas H123 O1 Objective
- Tas H123 F1 Functional Statement
- Tas H123 P1 to H123 P14 Performance Requirements
- Tas H123.0 Application of Part
- Tas H123.1 Deemed-to-Satisfy Provisions
- Tas H123.2 Structure
- Tas H123.3 Fire resisting material
- Tas H123.4 Access
- Tas H123.5 Exits and entrances
- Tas H123.6 Barriers
- Tas H123.7 Emergency lighting
- Tas H123.8 Exit signs
- Tas H123.9 Fire fighting equipment
- Tas H123.10 Sanitary facilities

Tas H123.11 Lighting
Tas H123.12 Ventilation
Tas H123.13 Electrical
Tas H123.14 Heating appliances
Tas H123.15 Seating

Footnote: Other Legislation Affecting Buildings

SECTION A GENERAL PROVISIONS

PART A1 INTERPRETATION

Tas A1.1 Definitions

Insert definition for *Babies* as follows:

Babies are children from 0 – 12 months.

Insert definition for *centre-based care class 1 facility* as follows:

Centre-based care class 1 facility is a facility for children from 0 – 5 years.

Insert definition for *centre-based care class 2 facility* as follows:

Centre-based care class 2 facility is a facility for children from 5 – 12 years.

Insert definition for *child-based child care facility* as follows:

Centre-based child care facility means a *centre-based care class 1 facility* or a *centre-based care class 2 facility*.

Vary the definition for *early childhood centre* as follows:

Early childhood centre means a preschool, kindergarten or *centre-based child care facility*.

Insert definition for *infants* as follows:

Infants are children from 0 – 5 years.

Insert definition for *public* as follows:

Public includes any person working in an enclosed public place.

Insert definition for *temporary structure* as follows:

Temporary structure includes any—

- (a) booth, tent or other temporary enclosure, whether or not part of the booth, tent or enclosure is permanent; or
- (b) temporary seating structure; or
- (c) other structure prescribed under the *Building Act 2000*.

Insert definition for *Toddlers* as follows:

Toddlers are children from 1 – 3 years.

Tas Specification A1.3 STANDARDS ADOPTED BY REFERENCE

Insert in Table 1 the following:

TAS Table 1 SCHEDULE OF REFERENCED DOCUMENTS

No.	Date	Title	BCA Clause(s)
AS 1187	1996	Refrigerated bulk milk tanks	Tas H107.3
AS/NZS 1596	2002	The storage and handling of LP Gas	Tas H120.4
AS 1657	1992	Fixed platforms, walkways, stairways and ladders — Design, construction and installation	Tas H113.3

TAS Table 1 SCHEDULE OF REFERENCED DOCUMENTS— continued

No.	Date	Title	BCA Clause(s)
AS/NZS 1668		The use of ventilation and air-conditioning in buildings	
Part 1	1998	Fire and smoke control in multi-compartment buildings	Tas H102.6
AS 1668		The use of mechanical ventilation and air-conditioning in buildings	
Part 2	1991	Mechanical ventilation for acceptable indoor-air quality	Tas H102.6
AS/NZS 1680		Interior lighting	Tas H101.7, Tas H102.7
Part 2.4	1997	Industrial tasks and processes Amdt 1	
Part 2.5	1997	Hospitals and medical tasks	
AS 1680		Interior lighting	Tas H101.7 Tas H102.7
Part 1	1990	General principles and recommendations Amdt 1	
Part 2.1	1993	Circulation spaces and other general areas	
Part 2.2	1994	Office and screen based tasks	
Part 2.3	1994	Education and training facilities	
AS 1940	1993	The storage and handling of flammable and combustible liquids	Tas H120.4
AS 2022	2003	Anhydrous ammonia — storage and handling.	Tas H120.4
AS 2381		Electrical equipment for explosive atmospheres — Selection, installation and maintenance	Tas H120.9
Part 1	1999	General requirements	
Part 2	1993	Flameproof enclosure Amdt 1	
Part 6	1993	Increased safety	
Part 7	1989	Intrinsic safety	
AS 2430		Classification of hazardous areas	Tas H120.5
Part 1	1987	Explosive gas atmospheres	
AS 2507	1998	The storage and handling of pesticides	Tas H120.4
AS 2658	2003	LP Gas - Portable and mobile appliances	Tas H123.14

TAS Table 1 SCHEDULE OF REFERENCED DOCUMENTS—continued

No.	Date	Title	BCA Clause(s)
AS 2714	1993	The storage and handling of hazardous chemical materials — Class 5.2 substances — Organic peroxides	Tas H120.4
AS/NZS 2927	2001	The storage and handling of liquefied chlorine gas Amdt 1	Tas H120.4
AS/NZS 3002	2002	Electrical installations — shows and carnivals	Tas H123.13
AS/NZS 3760	2001	In-service safety inspection and testing of electrical equipment	Tas H123.13
AS 3780	1994	Storage and handling of corrosive substances	Tas H120.4
AS/NZS 4013	1999	Domestic solid fuel burning appliances — Method for determination of flue gas emission	Tas G2.2, Tas H123.14
AS/NZS 4114		Spray painting booths, designated spray painting areas, and paint mixing rooms	
Part 1	2003	Design, construction and testing	Tas H118.2
AS 4464	1997	Hygienic production of game meat for human consumption	Tas H106.2
AS 4465	2001	Construction of premises and hygienic production of poultry meat for human consumption	Tas H106.2
AS 4466	1997	Hygienic production of rabbit meat for human consumption	Tas H106.2
AS 4674	2004	Design, construction and fit-out of food premises (Clauses 4.2 and 4.3)	Tas H102.12
AS 4696	2002	Hygienic production and transportation of meat and meat products for human consumption	Tas H106.2
AS 5008	2001	Hygienic rendering of animal products	Tas H106.2
AS 5010	2001	Hygienic production of ratite (emu/ostrich) meat for human consumption	Tas H106.2
AS 5011	2001	Hygienic production of natural casings for human consumption	Tas H106.2
AS 5601	2002	Gas Installations	Tas H120.4
Export Control (Processes Food) Orders			Tas H102.16

TAS Table 1 SCHEDULE OF REFERENCED DOCUMENTS—continued

No.	Date	Title	BCA Clause(s)
		Aurora Energy's Distribution Substation Design and Construction Standard	Tas H119.1, Tas H119.2
		Tasmania Code of Practice Hygienic Production of Pet Food	Tas H106.2

SECTION E SERVICES AND EQUIPMENT

PART E1 FIRE FIGHTING EQUIPMENT

After EO1(c) insert *Objective* Tas EO1(d) as follows:

OBJECTIVES

Tas EO1

(d) limit property and environmental damage caused by a fire.

After EF1.1 insert *Functional Statement* Tas EF1.2 as follows:

FUNCTIONAL STATEMENTS

Tas EF1.2

A building is to be provided with a system to alert the *fire brigade* of a fire in the building.

After EP1.6 insert *Performance Requirement* Tas EP1.7 as follows:

PERFORMANCE REQUIREMENTS

Tas EP1.7

An *automatic* fire detection system must be installed to the degree necessary to alert the *fire brigade* of fire so that fire fighting operations may be undertaken at the earliest possible time appropriate to—

- (a) the building functions and use; and
- (b) the *fire hazard*; and
- (c) the height of the building; and
- (d) the building *floor area*.

Limitation:

Tas EO1(d), Tas EF1.2 and Tas EP1.7 only applies to:

- (a) a Class 5 building or Class 6 building having an aggregate *floor area* of more than 1000 m²; and
- (b) a Class 7 building having a *floor area* of more than 1000 m² in which furniture is stored; and
- (c) a Class 8 building which is a special *fire hazard* building and in which more than 25 persons are employed; and
- (d) a Class 9b building which is a *school* or *early childhood centre* or a creche which-
 - (A) is of more than 1 *storey*; or
 - (B) has a storey with a *floor area* more than 500 m²; and
- (e) a Class 9b building which is a theatre.

Delete E1.0 and insert Tas E1.0 as follows:

Tas E1.0 Deemed-to-Satisfy Provisions

Performance Requirements EP1.1 to EP 1.6 and **Tas EP1.7** are satisfied by complying with **E1.1 to E1.10** and **Tas E1.101**.

After E1.10 insert Tas E1.101 as follows:

Tas E1.101 Fire detection and alarm system

An *automatic* fire detection and alarm system must comply with **Clauses 4 and 7 of Specification E2.2a**.

SECTION F HEALTH AND AMENITY

PART F2 SANITARY FACILITIES

Tas Table F2.3 Sanitary Facilities in Class 3, 5, 6, 7, 8 and 9 Buildings

Delete the Note in Table F2.3 alongside Early child-hood centres and replace it with the following:

- Note: If the centre accommodates children under 4 years of age the facilities for use by those children must be—
- (a) junior pans; and
 - (b) wash basins with a rim height not exceeding 600 mm.

After F2.8 insert Tas F2.101 as follows:

Tas F2.101 Non-flushed Urinals

Non-flushed urinals not connected to a sewerage system must comply with **Tas F2.102**.

After Tas F2.101 insert Tas F2.102 as follows:

Tas F2.102 Installation of Closet Fixtures

- (a) If a sufficient sewerage system is not available, an authorised alternative means of disposal of sewage, may be installed.
- (b) If sanitary facilities are not water-flushed, the following provisions apply:
 - (i) A pit latrine, an incinerating toilet, a chemical toilet, a removable pan or a non-flushing urinal must not be within 2 m of a building containing habitable rooms.
 - (ii) The floor on which a removable pan is placed must be impervious.
 - (iii) A room containing a composting toilet must be separated from habitable rooms by way of a permanently ventilated air lock (which may be a circulation space).
 - (iv) The minimum ventilation *required* under (iii) shall be the greater of—
 - (A) 8000 mm²; or
 - (B) 1/500th of the *floor area* of the circulation space.
 - (v) Access for maintenance or removal of waste from a composting toilet must be by way of an access door which opens directly to the outside of the building.

PART F4 LIGHT AND VENTILATION

After F4.12 insert Tas F4.101 as follows:

Tas F4.101 Fixed Natural Ventilation

- (a) Except if mechanical ventilation or air-conditioning is provided, in rooms and areas listed in **Tas Table F4.101**, a fixed opening, of aggregate size not less than that shown in the Table, must be provided in addition to any adjustable opening.

TAS TABLE F4.101 FIXED NATURAL VENTILATION

Building Class	Room to be ventilated	Size of fixed opening/floor area
2, 3 and 4	(i) Common stairways	1/500
	(ii) Communal laundries	1/500
7	Rooms for storage of polluting or noxious substances	1/350
8	All rooms	1/500*
9a	Store rooms	1/500
9b	(i) Assembly halls in schools	1/250
	(ii) Workshops in schools	1/250

TAS TABLE F4.101 FIXED NATURAL VENTILATION— continued

Building Class	Room to be ventilated	Size of fixed opening/floor area
Other than Class 2, 4	(i) Pantries for food preparation rooms	1/500
	(ii) Washrooms	1/500*
	(iii) Sanitary compartments	1/350*
	(iv) Locker, meal and change rooms	1/500*
	(v) Boiler rooms	1/500*
	(vi) Plant, machinery rooms	1/250*
	(vii) Electrical switchboard rooms	1/250*
	(viii) Battery rooms (other than lead acid)	1/500*
Note: Not less than half of the fixed natural ventilation must be provided as high in the room as possible but not less than 2 m above the floor.		

- (b) Fixed natural ventilation may be provided by means of—
- (i) openings in walls, clear of obstructions other than louvres or grilles; or
 - (ii) ceiling ventilators, including skylights and roof ventilators.
- (c) Where a fixed ventilation opening is associated with a duct, that duct must have a clear open way at least twice the *required* area of the opening.
- (d) Openings for fixed natural ventilation must be placed so as to let air out and, if the air entering by or around doors or by other openings is insufficient for adequate ventilation, additional openings for the entry of air must be provided.

SECTION G ANCILLARY PROVISIONS

PART G1 MINOR STRUCTURES AND COMPONENTS

After GO1(e) insert *Objective* Tas GO1(f), (g) and (h) as follows:

OBJECTIVES

Tas GO1(f)

safeguard people from illness or injury arising from the use of a *swimming pool*.

Tas GO1(g)

safeguard people from illness or injury when using a way.

Tas GO1(h)

protect a way.

After GF1.3 insert *Functional Statements* Tas GF1.4, Tas GF1.5 and Tas GF1.6 as follows:

FUNCTIONAL STATEMENTS

Tas GF1.4

Swimming pools must provide for the health and safety of swimmers and others.

Tas GF1.5

Projections over ways must not pose a danger to persons using the way nor to adjoining buildings.

Tas GF1.6

Buildings located adjacent to a way must not unduly affect the integrity of the way.

After GP1.4 insert *Performance Requirements* Tas GP1.5 to Tas GP1.9 as follows:

PERFORMANCE REQUIREMENTS

Tas GP1.5

Swimming pools must be suitable and safe to use and be provided with appropriate facilities.

Tas GP1.6

Projections over ways must be constructed and located to provide safe passage along the way and reduce the spread of fire and the potential for collapse.

Tas GP1.7

Roofs of buildings and attachments to buildings must not allow stormwater to reach the way except by way of a drain.

Tas GP1.8

Excavations must be protected to prevent any part of a way from subsiding into them.

Tas GP1.9

Footings of a building must not project on to a way except if they are at sufficient depth.

Limitation

Tas GP1.5 does not apply to a *swimming pool* associated with a Class 2 building.

Delete G1.0(b) and insert Tas G1.0(b) as follows:

Tas G1.0(b) Deemed-to-Satisfy Provisions

Performance Requirements GP1.2 to *GP 1.4* and *Tas GP1.5* to *Tas GP1.9* are satisfied by complying with *G1.1* and *G1.2*.

After G1.1(b) insert Tas G1.1(c) to (i) as follows:

Tas G1.1 Swimming Pools

- (c) *Swimming pools* for the use of the public, a club, or an association, or in connection with Class 3, 5, 6, 7, 8 or 9 buildings must—
- (i) be constructed of durable materials with smooth finishes;
 - (ii) have sides vertical;
 - (iii) in that part of the pool where the water depth is not more than 1.5 m, have the bottom or floor slope not steeper than 1 vertical to 15 horizontal;
 - (iv) have the depth of water marked clearly and conspicuously on each side of the pool (at the shallow end and at the deep end);
 - (v) not have diving boards installed where the water depth is less than 3.5 m;
 - (vi) have scum-gutters with opening not less than 150 mm if they are to provide hand-holds; and
 - (vii) have the floor or bottom of the pool, except for the guide lines, of such colours that the light reflectance is not less than 60%.
- (d) For a public *swimming pool* or pool in which competitions are held—
- (i) all steps into the pool must be recessed;
 - (ii) fittings must not project into the water area;
 - (iii) piping must not be bracketed to the sides to provide hand-holds;
 - (iv) surrounding concourses must be provided not less than 2 m wide, with a suitable non-slip surface, graded away from the pool and drained to waste; and
 - (v) dressing rooms with sanitary accommodation must be so located that bathers pass through that accommodation enroute to the *swimming pool*.
- (e) If the volume of a *swimming pool* exceeds 15 m³—
- (i) an adequate water recirculation, disinfection and filtration system must be installed;
 - (ii) the inlet and outlet openings in a *swimming pool* for the purpose of water recirculation must be so located that water movement is continuous from inlet to outlet;
 - (iii) * * * * *
 - (iv) recirculation of water in a *swimming pool* must be so designed that the pool contents are recirculated not less than once in the period shown in **Tas Table G1.1(e)**; and
 - (v) water filtration rates must not exceed 12 250 L/m² of sand filter bed per hour, or an equivalent rate in other filter media.

Tas TABLE G1.1(e) RECIRCULATION OF WATER IN SWIMMING POOLS

Pool Type	Period
Outdoor <i>Swimming pool</i>	6 hours
Indoor <i>Swimming pool</i>	4 hours
Wading Pool	2 hours

(f) Where no other suitable sanitary accommodation is provided, sanitary facilities must be provided in accordance with **Tas Table G1.1(h)**.

TAS TABLE G1.1(h) SANITARY FACILITIES AT SWIMMING POOLS

	Maximum Number Served by—					
	Closet Fixtures		Urinals		Wash Basins	
	1	Each Extra	1	Each Extra	1	Each Extra
Males	60	60	60	60	60	60
Females	40	40	-	-	60	60

(g) Where no other suitable shower facilities are provided, showers must be provided so that each shower serves up to 40 persons.

PART G2 HEATING APPLIANCES, FIREPLACES, CHIMNEYS AND FLUES

Delete *Objective* GO2(a) and insert Tas GO2(a) as follows:

Objective

Tas GO2

- (a) safeguard people from illness or injury caused by—
- (i) fire and emissions from combustion appliances installed within a building; and
 - (ii) malfunction of a pressure vessel installed within a building; and

Delete *Functional Statement* GF2.1 and insert Tas GF2.1 as follows:

FUNCTIONAL STATEMENT

Tas GF2.1

Combustion appliances using controlled combustion located in a building are to be installed in a way which reduces the likelihood of fire and harmful emissions spreading beyond the appliance.

Delete *Performance Requirement* GP2.1(c) and insert Tas GP2.1(c) as follows:

PERFORMANCE REQUIREMENT

Tas GP2.1

- (c) so that hot products of combustion will not—
- (i) escape through the walls of the associated components; and
 - (ii) discharge in a position that will cause fire to spread to nearby *combustible* materials or allow smoke to penetrate through nearby *windows*, ventilation inlets, or the like; and
 - (iii) in the case of solid-fuel burning appliances, be discharged above appropriate emission limits.

Delete G2.2(b) and insert Tas G2.2(b) as follows:

Tas G2.2

- (b) Domestic solid-fuel burning appliances — Emissions: AS/NZS 4013
Installations: AS/NZS 2918.

After Part G5 insert Tas Part G101 as follows:

TAS PART G101 PROJECTIONS OVER WAYS

Tas G101.1 Construction and location of projections over ways

- (a) In this Part the following meanings apply:

Awning means a cover projecting from a building to provide shelter or shade for people outside the building.

Balcony means a permanent projection from a building, designed to be walked, stood or sat on, and which is not roofed.

Kerb-line means the line of the carriageway edge of the kerb or, where there is no kerb, the line of the carriageway edge of the kerb if there was one.

Verandah means a permanent, roofed projection from a building, designed to be walked, stood or sat on.

Way includes a public road, street, alley or footpath.

- (b) Every bridge connecting buildings over a *way* must be of *non-combustible* material.
- (c) Every *awning* and *balcony* which projects over a *way* must be supported entirely from the building to which it is attached.
- (d) A *verandah* must not project over a *way*.
- (e) Every part of a building which projects over a *way* must comply with **Tas Table G101.1**.

Tas TABLE G101.1 PROJECTIONS OVER WAYS

Heights above ground or footpath level:

Awnings

2.7 m

Tas TABLE G101.1 PROJECTIONS OVER WAYS— continued

Shades or sunblinds (when not in use), signs, lamps or the like.	2.4 m
Other projections	3.0 m
Maximum Distance of projection over a way:	
<i>Awnings—</i>	
(i) <i>non-combustible</i>	not beyond a line 450 mm from the plumb of the kerb-line
(ii) <i>combustible</i>	1.0 m
<i>Balconies—</i>	
	1.0 m
<i>Other projections—</i>	
(i) in streets more than 15 m wide	900 mm
(ii) in streets not more than 15 m wide	600 mm
Note:	
<p>(i) A door, gate, <i>window</i>, sash, or shutter is not deemed to open outwards unless, when open to its utmost extent, some part of it projects beyond the boundary line of the <i>way</i>.</p> <p>(ii) The total width of all the oriel <i>windows</i> and turrets projecting onto a <i>way</i> in any wall of any <i>storey</i> of a building, taken together, must not exceed 3/5 of the length of that wall on the level of that <i>storey</i>.</p>	

- (f) Any *combustible awning* which projects over a *way* must not extend to within 1.5 m of an adjoining building.

After Tas G101.1 insert Tas G101.2 as follows:

Tas G101.2 Protection of Ways

- (a) Every roof of a building, and every *verandah*, *balcony*, or other similar projection or projecting *window* must be so designed and built as to prevent stormwater from it from dropping on, running over, or seeping under any *way*.
- (b) The roof of any *awning* that extends more than 1.0 m over a *way* must be drained to a down pipe.
- (c) Down pipes from *awnings—*
- (i) must not project beyond the boundary of a *way*; and
 - (ii) must be of steel or provided with a protective cover to a height of 2 m from the path.
- (d) Any excavation must be protected, by shoring or otherwise, as necessary to prevent subsidence into the excavation of any part of a *way* adjoining it.
- (e) Footings must not extend beyond the boundary of a *way* other than as shown in **Tas Table G101.2**.

Tas TABLE G101.2 PROJECTION OF FOOTINGS

Depth of top of footing below ground level	Maximum permissible projection
Less than 1.3 m	Nil
1.3 m to 3.0 m	450 mm
Exceeding 3.0 m	750 mm

SECTION H SPECIAL USE BUILDINGS

Insert *Objectives* for Tas Part H101 as follows:

OBJECTIVES

Tas Part H101 Workplaces

Every workplace must be constructed in a manner that will provide for the safety, health and welfare of workers using that workplace.

Tas Part H102 * * * * *

This clause has deliberately been left blank.

Insert *Objectives* for Tas Part H103 as follows:

Tas Part H103 Dining Rooms and Bar Rooms

Dining rooms and bar rooms must provide for the comfort, convenience and health of customers.

Tas Part H104 * * * * *

This clause has deliberately been left blank.

Tas Part H105 * * * * *

This clause has deliberately been left blank.

Insert *Objectives* for Tas Part H106 as follows:

Tas Part H106 Meat Premises

Meat premises must be constructed in such a manner that—

- (a) does not jeopardise animal welfare; and
- (b) provides for hygienic processing of animals; and
- (c) ensures the wholesomeness of meat and meat products.

Insert *Objectives* for Tas Part H107 as follows:

Tas Part H107 Farm Dairy Premises

Dairies must be constructed in such a manner that contamination of milk can be avoided.

Insert *Objectives* for Tas Part H108 as follows:

Tas Part H108 Pharmacies

Pharmacies must be able to be secured against entry and the interior must be able to be supervised by a pharmacist.

Insert *Objectives* for Tas Part H109 as follows:

Tas Part H109 Hospitals and Nursing Homes

Hospitals and nursing homes must be able to be easily cleaned and must have adequate space for patients.

Insert *Objectives* for Tas Part H110 as follows:

Tas Part H110 Premises Used for Activities Involving Skin Penetration

Premises used for activities involving skin penetration must provide for cleanliness of staff and comfort of customers.

Insert *Objectives* for Tas Part H111 as follows:

Tas Part H111 Dental Surgeries and Chiropractors' Premises

Dental surgeries and chiropractors' premises must be able to be easily cleaned and must have a waiting room for patients.

Insert *Objectives* for Tas Part H112 as follows:

Tas Part H112 Mortuaries

Mortuaries must be constructed in a manner that will ensure the health of staff and the general public.

Insert *Objectives* for Tas Part H113 as follows:

Tas Part H113 Foundries

Foundries must provide for the comfort and safety of workers on the premises.

Insert *Objectives* for Tas Part H114 as follows:

Tas Part H114 Premises for Manufacture or Processing of Glass Reinforced Plastic

Premises for manufacture or processing of glass reinforced plastic must—

- (a) provide for the safety and comfort of workers; and
- (b) be constructed in a manner that will avoid the spread of fire within the building and to other buildings.

Insert *Objectives* for Tas Part H115 as follows:

Tas Part H115 Premises for the Production or Processing of Isocyanates

Premises for the production or processing of isocyanates must—

- (a) provide for the safety and comfort of workers; and
- (b) be constructed in a manner that will avoid the spread of fire within the building and to other buildings.

Insert *Objectives* for Tas Part H116 as follows:

Tas Part H116 Premises for Electro-plating, Electro-polishing, Anodising or Etching

Premises for electro-plating, electro-polishing, anodising or etching must—

- (a) provide for the safety and comfort of workers; and
- (b) be constructed in a manner that will prevent the escape of liquids and atmospheric contaminants to other areas of the building.

Insert *Objectives* for Tas Part H117 as follows:

Tas Part H117 Premises for Lead Processing

Premises for lead processing must—

- (a) provide for the safety and comfort of workers; and
- (b) be constructed in a manner that will minimise the lodgement of dust and must be capable of being flushed with water.

Insert *Objectives* for Tas Part H118 as follows:

Tas Part H118 Booths for Spray-painting or Spray-coating

Booths for spray-painting or spray-coating must—

- (a) be constructed of *non-combustible* materials;
- (b) have adequate means of escape; and
- (c) have suitable means of extracting harmful fumes from the booth.

Insert *Objectives* for Tas Part H119 as follows:

Tas Part H119 Electricity Distribution Substations

Building-type electricity distribution substations must be housed in buildings that are tamper-proof, vermin-proof and weatherproof, and have adequate means of escape.

Insert *Objectives* for Tas Part H120 as follows:

Tas Part H120 Premises for Storage of Dangerous Goods

Premises for storage of dangerous goods must—

- (a) provide for the safety and comfort of workers in the premises; and

- (b) be constructed so as not to be a danger to other people or buildings.

Insert [Objectives](#) for Tas Part H121 as follows:

Tas Part H121 Hairdressers' Premises

Hairdressers' premises must be of adequate size and amenity.

After Part H1 insert Tas Part H101 as follows:

TAS PART H101 WORKPLACES

Tas H101.1 Application of Part

This Part is applicable to every building or part of a building used as a workplace.

Tas H101.2 Floor area

- (a) The [floor area](#) of each office must be 7 m² or sufficient to provide 4 m² for each occupant, whichever is the greater.
- (b) Each floor plan dimension of any room which is a workplace must be greater than 2.5 m.

Tas H101.3 Floor surfaces

- (a) Every floor in a work place must have an even, unbroken slip-resistant surface, free from holes, indentations, projections or other obstructions that might create tripping or stumbling hazards.
- (b) Where the nature of the process is such that spillage of liquids is likely to occur, or where it is necessary for the floors to be cleansed with water or other liquids—
- (i) the floors must be surfaced with materials that are impervious to the penetration of liquids likely to be spilt or used in the process of cleaning; and
 - (ii) the joints between the floors and the walls must be sealed with an impervious material and finished in such a manner that the joint is concavely rounded.

Tas H101.4 Floor drainage

- (a) Floors in a workplace must be graded to drain off liquids which must be carried away and disposed of by means of open paved channels, covered drains or pipes.
- (b) Floors graded as shown in [Tas Table H101.4](#) satisfy (a).

Tas TABLE H101.4 SLOPES OF FLOORS FOR DRAINAGE

Wash (or hose-down) areas	1:25
Wet (or mop-down) areas	1:50
Dry areas	1:100

- (c) Where the effluent from drains is likely to be offensive it must be intercepted by suitable deodorising tanks.
- (d) Wherever practicable, drains to carry off spilt liquids should be planned so that the liquids are intercepted close to the point of spillage and not allowed to spread over the working surface of the floor.

Tas H101.5 Floor covering

- (a) Where workers stand in substantially the one location while working on a floor of brick, metal, stone or other similar material, those floors or sections thereof, must be covered with—
- (i) wood, rubber, linoleum, resilient types of plastic tiles;
 - (ii) suitable compositions containing asphalt, rubber, cork, magnesite; or
 - (iii) other semi-resilient, thermally non-conductive materials on which the workers may stand.
- (b) Fixed coverings for local sections of floors must be inset flush with the main floor.

Tas H101.6 Overhead clearance

Pipes, fixtures and similar objects running above a passage or walkway must be fixed at a height to provide a clear distance not less than 2.1 m measured from the floor to the lowest part of the object.

Tas H101.7 Lighting

Interior lighting in a workplace must comply with the relevant requirements in AS/NZS 1680 Parts 2.4 and 2.5 and AS 1680 Parts 1, 2.1, 2.2, and 2.3.

Tas H101.8 Ventilation

Every workplace must be ventilated to remove offensive gases, vapours, fumes, dust or other airborne impurities.

Tas H101.9 Toilet facilities

- (a) Where practicable, toilet facilities must be located in the same building as the workplace or change room that they serve.
- (b) Toilet facilities which are not located in the same building as the workplace they serve must—
- (i) be sited within the boundary of the premises;
 - (ii) be housed in a fully roofed and clad building;
 - (iii) be located at a distance not greater than 100 m from any workplace they serve; and
 - (iv) have provided, at every entrance doorway giving direct access to the interior of the building, a full length door fitted with a suitable locking device.
- (c) Every closet must be fitted with a door capable of being fastened on the inside.

Tas H101.10 Hand washing facilities

- (a) Hand washing facilities must be located in change rooms or in wash rooms accessible to change rooms and must be placed where they can be conveniently used by persons before eating meals and after using toilet facilities.

- (b) Where hand washing facilities are located in a change room, the *floor area* allowed for the change room must be increased by the area *required* for the washing equipment and its use.
- (c) Hand washing facilities include wash basins, wash troughs and circular ablution fountains.

Tas H101.11 Shower facilities

- (a) Where the work engaged upon is such that a change of clothing is necessary, showers with hot and cold running water must be provided at the rate of not less than shown in **Tas Table H101.11**.

Tas TABLE H101.11 SHOWERS IN WORK PLACES

Hot, arduous or dirty industries:	1 for every 15 employees
Light, clean industries:	1 for every 25 employees

- (b) Shower rooms must be located immediately adjacent to change rooms and urinal facilities, but urinal facilities may be provided in male shower rooms.
- (c) Separate and distinct shower accommodation must be provided for male and female employees.

Tas H101.12 Change rooms

Where change rooms are *required* by *Regulation 116(1)(b)* of the *Workplace Health and Safety Regulations 1998*, they must comply with **Tas Table H101.12**.

Tas TABLE H101.12 CHANGE ROOMS

Minimum area of room-	
for each person requiring to change clothes:	0.5 m ²
for each person not requiring to change clothes:	0.3 m ²
Minimum free floor space-	
between lockers facing one another:	1.5 m
between locker face and a wall:	1.0 m
free <i>floor area</i> :	2.0 m ²

Tas H101.13 Dining rooms

- (a) In any work place which is a factory or shop a dining area or dining room must be provided as set out in **Tas Table H101.13**.

Tas TABLE H101.13 DINING AREAS AND DINING ROOMS

<p>For 10 or less employees: a suitable dining area separate from any working area:</p> <p style="padding-left: 40px;">Dining areas must be provided with adequate and hygienic facilities for the washing of eating utensils and for the storage of utensils where they will be protected from dust or vermin.</p>
--

Tas TABLE H101.13 DINING AREAS AND DINING ROOMS— continued

For more than 10 employees: a conveniently located dining room separate from any work room or work area:

Dining rooms must be equipped with a dish washing sink supplied with hot and cold water, draining board and cupboards in which foodstuffs and crockery can be stored free from dust and vermin, except that the provision of running water shall not apply where a reticulated water service cannot be made available.

NOTE: Where up to 15 persons of the same sex are employed, a combined change room/dining room may be provided.

- (b) In buildings to be used as offices, there must be provided on each *storey*, in a location accessible to all tenants, an area containing a dish washing sink supplied with hot and cold water, cupboard storage for food stuffs and utensils, and facilities for boiling water. Such areas must not be located in toilets, wash-rooms, or change rooms.

Tas H101.14 Rest rooms

Where 20 or more females are employed, a separate rest room, with convenient access to sanitary accommodation, must be provided in accordance with [Tas Table H101.14](#).

Tas TABLE H101.14 FLOOR AREAS OF REST ROOMS

m ² of <i>floor area</i> :	6	9	12	15	Each extra 3
Max. number of females served:	100	200	300	400	200
NOTE:	Where a first aid room or health centre is provided the rest room may be adjacent to it or part of it.				

Tas H101.15 First aid rooms and health centres

- (a) In every workplace, other than a shop or office, where the number of employees working on the premises exceeds 300 at any time, a self-contained health centre must be provided, at ground level if practicable, with *floor area* not less than 45 m², which includes—
- (i) treatment room with a *floor area* of at least 14 m²;
 - (ii) separate waiting room;
 - (iii) separate recovery room;
 - (iv) separate combined office and consulting room;
 - (v) toilet with air lock and washbasin with clean, hot and cold, running water;
 - (vi) store room or adequate storage cupboards; and
 - (vii) walls, floors and ceilings impervious to moisture, easy to clean, free from cracks, ledges and sharp angles and finished in a light colour.
- (b) In every workplace where the number of employees exceeds 150 at any time and where a health centre has not been provided, a first aid room must be provided, suitably located with convenient access, readily accessible to sanitary accommodation, having a *floor area* not less than 14 m² and clearly marked "FIRST AID".

Tas H101.16 Doors

- (a) **Roller-shutter door:** Every power operated, roller-shutter door must be fitted with a continuous-pressure, manual switch for control of downward movement.
- (b) **Automatic-closing doors:** A suitable switch, controlled by a photoelectric device, must be fitted to stop or reverse the closing travel if a person or object should obtrude into the line of travel of the closing door.
- (c) **Sliding-door:** Every sliding door must be installed in such a manner that it will not derail or over-run its normal travel.

After Tas Part H101 insert Tas Part H102 as follows:

TAS PART H102 FOOD PREMISES

OBJECTIVE

Tas H102 O1

The *Objective* of this Part is to facilitate the safe manufacture, preparation, storage or packing of food for sale for human consumption.

Application:

- (a) **Tas H102 O1** applies to any premises where food intended for human consumption is manufactured, processed or sold and to which the following apply-
 - (i) *Food Act 2003*; or
 - (ii) *Liquor and Accommodation Act 1990*.
- (b) **Tas H102 O1** includes, but is not limited to-
 - (i) bakehouses;
 - (ii) bar service areas;
 - (iii) premises for boning, curing, canning, mincing, pre-packing or other similar processes of preparation of meat for sale;
 - (iv) retail meat premises;
 - (v) eating houses and tea shops;
 - (vi) fish shops;
 - (vii) kitchens in eating houses, restaurants, guest houses, motels and hotels;
 - (viii) rooms for processing, manufacturing, packing, etc of fruit and vegetables, dairy products, ice blocks, ices, meat-for-sale, or other fish;
 - (ix) shellfish processing premises;
 - (x) take-away-food stores; and
 - (xi) breweries and wineries.
- (c) In **Tas H102 O1**, words and meanings as defined in the *Food Act 2003*, *Food Standards Code* and *Liquor and Accommodation Act 1990* apply.

Limitations:

Tas H102 O1 does not apply to—

- (a) boarding houses or the like classified as Class 1 buildings; or
- (b) tents, buildings or other structures used temporarily for serving meals to the public at any fair, show, race meeting or other public sports, games or amusements; or
- (c) dairies covered by **Tas H107**; or
- (d) live shellfish premises where live shellfish are being packed or handled for transport or transferral to shellfish processing premises.

FUNCTIONAL STATEMENT**Tas H102 F1**

Each building or part of a building constructed as a food premise must be able to be used in such a manner that minimises opportunities for food contamination.

Application:

- (a) **Tas H102 F1** applies to any premises where food intended for human consumption is manufactured, processed or sold and to which the following apply-
 - (i) *Food Act 2003*; or
 - (ii) *Liquor and Accommodation Act 1990*.
- (b) **Tas H102 F1** includes, but is not limited to-
 - (i) bakehouses;
 - (ii) bar service areas;
 - (iii) premises for boning, curing, canning, mincing, pre-packing or other similar processes of preparation of meat for sale;
 - (iv) retail meat premises;
 - (v) eating houses and tea shops;
 - (vi) fish shops;
 - (vii) kitchens in eating houses, restaurants, guest houses, motels and hotels;
 - (viii) rooms for processing, manufacturing, packing, etc of fruit and vegetables, dairy products, ice blocks, ices, meat-for-sale, or other fish;
 - (ix) shellfish processing premises;
 - (x) take-away-food stores; and
 - (xi) breweries and wineries.
- (c) In **Tas H102 F1**, words and meanings as defined in the *Food Act 2003*, *Food Standards Code* and *Liquor and Accommodation Act 1990* apply.

Limitations:

Tas H102 F1 does not apply to—

- (a) boarding houses or the like classified as Class 1 buildings; or

- (b) tents, buildings or other structures used temporarily for serving meals to the public at any fair, show, race meeting or other public sports, games or amusements; or
- (c) dairies covered by **Tas H107**; or
- (d) live shellfish premises where live shellfish are being packed or handled for transport or transferral to shellfish processing premises.

PERFORMANCE REQUIREMENTS

Tas H102 P1

The design and construction of food premises must:

- (a) be appropriate for the activities for which the premises are used; and
- (b) provide adequate space for the activities to be conducted on the food premises and for the fixtures, fittings and equipment used for those activities; and
- (c) permit the food premises to be effectively cleaned and, if necessary, sanitized; and
- (d) to the extent that is practicable:
 - (i) exclude dirt, dust, odours, fumes, smoke and other contaminants;
 - (ii) not permit the entry of pests; and
 - (iii) not provide harbourage for pests.

Tas H102 P2

- (a) Food premises must have an adequate supply of water if water is to be used at the food premises for any of the activities conducted on the food premises.
- (b) A food business must use potable water for all activities that use water that are conducted on the food premises.

Limitation:

If a food business demonstrates that the use of non-potable water for a purpose will not adversely affect the safety of the food handled by the food business, subclause (b) does not apply.

Tas H102 P3

Food premises must have a sewage and waste water disposal system that—

- (a) will effectively dispose of all sewage and waste water; and
- (b) is constructed and located so that there is no likelihood of the sewage and waste water polluting the water supply or contaminating food.

Tas H102 P4

Food premises must have facilities for the storage of garbage and recyclable matter that—

- (a) adequately contain the volume and type of garbage and recyclable matter on the food premises; and

- (b) enclose the garbage or recyclable matter, if this is necessary to keep pests and animals away from it; and
- (c) are designed and constructed so that they may be easily and effectively cleaned.

Tas H102 P5

Food premises must have sufficient natural or mechanical ventilation to remove fumes, smoke and vapours from the food premises.

Tas H102 P6

Food premises must have lighting systems that provide sufficient natural or artificial light for the activities conducted on the food premises.

Tas H102 P7

- (a) Floors must be designed and constructed in a way that is appropriate for the activities conducted on the food premises.
- (b) Floor must—
 - (i) be able to be effectively cleaned; and
 - (ii) be unable to absorb grease, food particles or water; and
 - (iii) be laid so that there is no ponding of water; and
 - (iv) to the extent that is practicable, be unable to provide harbourage for pests.

Application:

The requirements for floors apply to the floors of all areas used for food handling, cleaning, sanitizing and personal hygiene except the following areas:

- (a) dining areas; and
- (b) drinking areas; and
- (c) other areas to which members of the public usually have access.

Limitation:

The following floors do not have to comply with sub-clause (b)—

- (i) floors of temporary food premises, including ground surfaces, that are unlikely to pose any risk of contamination of food handled on the food premises; and
- (ii) floors of food premises that are unlikely to pose any risk of contamination of food handled on the food premises provided the food business has obtained approval for their use.

Tas H102 P8

Walls and ceilings—

- (a) must be designed and constructed in a way that is appropriate for the activities conducted on the food premises; and
- (b) must be provided where they are necessary to protect food from contamination; and
- (c) provided in accordance with sub-clause (b) must be—

- (i) sealed to prevent the entry of dirt, dust and pests; and
- (ii) unable to absorb grease, food particles or water; and
- (iii) be able to be easily and effectively cleaned; and
- (d) must—
 - (i) be able to be effectively cleaned; and
 - (ii) to the extent that is practicable, be unable to provide harbourage for pests.

Application:

The requirements for walls and ceilings apply to the walls and ceilings of all areas used for food handling, cleaning, sanitizing and personal hygiene except the following areas:

- (a) dining areas; and
- (b) drinking areas; and
- (c) other areas to which members of the public usually have access.

Tas H102 P9

- (a) Food premises must have hand washing facilities that are located where they can be easily accessed by food handlers—
 - (i) within areas where food handlers work if their hands are likely to be a source of contamination of food; and
 - (ii) if there are toilets on the food premises—immediately adjacent to the toilets or toilet cubicles.
- (b) Hand washing facilities must be—
 - (i) permanent fixtures; and
 - (ii) provided with a supply of warm running potable water; and
 - (iii) of a size that allows easy and effective hand washing; and
 - (iv) clearly designated for the sole purpose of washing hands, arms and face.

Tas H102 P10

Fixtures, fittings and equipment must—

- (a) be adequate for the production of wholesome food; and
- (b) be fit for their intended use; and
- (c) be designed, constructed, located and installed, and equipment must be located and, if necessary, installed, so that—
 - (i) there is no likelihood that they will cause food contamination; and
 - (ii) they are able to be easily and effectively cleaned; and
 - (iii) adjacent floors, walls, ceilings and other surfaces are able to be easily and effectively cleaned; and
 - (iv) to the extent that is practicable, they do not provide harbourage for pests; and
- (d) have food contact surfaces—

- (i) able to be easily and effectively cleaned and, if necessary, sanitized if there is a likelihood that they will cause food contamination; and
- (ii) unable to absorb grease, food particles and water if there is a likelihood that they will cause food contamination; and
- (iii) made of a material that will not contaminate food.

Tas H102 P11

Food premises must have adequate storage facilities—

- (a) for the storage of items that are likely to be the source of contamination of food, including chemicals, clothing and personal belongings; and
- (b) located where there is no likelihood of stored items contaminating food or food contact surfaces.

Tas H102 P12

All refrigerated or cooling chambers must be constructed so that stored products will not be contaminated.

Application:

- (a) **Tas H102 P1** to **P12** applies to any premises where food intended for human consumption is manufactured, processed or sold and to which the following apply-
 - (i) *Food Act 2003*; or
 - (ii) *Liquor and Accommodation Act 1990*.
- (b) **Tas H102 P1** to **P12** includes, but is not limited to-
 - (i) bakehouses;
 - (ii) bar service areas;
 - (iii) premises for boning, curing, canning, mincing, pre-packing or other similar processes of preparation of meat for sale;
 - (iv) retail meat premises;
 - (v) eating houses and tea shops;
 - (vi) fish shops;
 - (vii) kitchens in eating houses, restaurants, guest houses, motels and hotels;
 - (viii) rooms for processing, manufacturing, packing, etc of fruit and vegetables, dairy products, ice blocks, ices, meat-for-sale, or other fish;
 - (ix) shellfish processing premises;
 - (x) take-away-food stores; and
 - (xi) breweries and wineries.
- (c) In **Tas H102 P1** to **P12**, words and meaning as defined in the *Food Act 2003*, *Food Standards Code* and *Liquor and Accommodation Act 1990* apply.

Limitations:

Tas H102 P1 to **P12** do not apply to—

- (a) boarding houses or the like classified as Class 1 buildings; or

- (b) tents, buildings or other structures used temporarily for serving meals to the public at any fair, show, race meeting or other public sports, games or amusements; or
- (c) dairies covered by **Tas H107**; or
- (d) live shellfish premises where live shellfish are being packed or handled for transport or transferral to shellfish processing premises.

DEEMED-TO-SATISFY PROVISIONS

Tas H102.0 Application of Part

- (a) This Part applies to any premises where food intended for human consumption is manufactured, processed or sold and to which the following apply—
 - (i) *Food Act 2003*; or
 - (ii) *Liquor and Accommodation Act 1990*.
- (b) This Part includes, but is not limited to—
 - (i) bakehouses;
 - (ii) bar service areas;
 - (iii) premises for boning, curing, canning, mincing, pre-packing or other similar processes of preparation of meat for sale;
 - (iv) retail meat premises;
 - (v) eating houses and tea shops;
 - (vi) fish shops;
 - (vii) kitchens in eating houses, restaurants, guest-houses, motels and hotels;
 - (viii) rooms for processing, manufacturing, packing, etc of fruit and vegetables, dairy products, ice blocks, ices, meat-for-sale or other fish;
 - (ix) shellfish processing premises;
 - (x) take-away-food stores; and
 - (xi) breweries and wineries.
- (c) This Part does not apply to—
 - (i) boarding houses or the like classified as Class 1 buildings; or
 - (ii) tents, buildings or other structures used temporarily for serving meals to the public at any fair, show, race meeting or other public sports, games or amusements; or
 - (iii) dairies covered by **Tas Part H107**; or
 - (iv) live shellfish premises where live shellfish are being packed or handled for transport or transferral to shellfish processing premises.
- (d) In this Part, words and meanings as defined in the *Food Act 2003*, *Food Standards Code* and *Liquor and Accommodation Act 1990* apply.

Tas H102.1 Deemed-to-Satisfy Provisions

Performance Requirements Tas H102 P1 to *Tas H102 P12* are satisfied by complying with the relevant provisions of *Tas H102.0* to *Tas H102.17*.

Tas H102.2 General Requirements

- (a) The provision of—
- (i) close-fitting windows and doors; and
 - (ii) air intakes that do not draw in contaminated air; and
 - (iii) air locks and self-closing doors to separate toilet areas, laundries and living areas from food handling areas; or
 - (iv) mechanical ventilation that removes sources of contamination,
- satisfies *Tas H102 P1(d)(i)*.
- (b) The provision of—
- (i) self-closing or pest-screened external doors; and
 - (ii) mesh screens at opening windows or other ventilation openings; and
 - (iii) sealing to drains, grease traps and ventilation pipes; and
 - (iv) sealing to openings where pipes pass through external walls; and
 - (v) the installation of pest-proof flashings to doors,
- satisfies *Tas H102 P1(d)(ii)*.
- (c) The provision of—
- (i) vermin-proof sealing; or
 - (ii) filling; or
 - (iii) access for inspection and cleaning of boxed-in areas,
- satisfies *Tas H102 P1(d)(iii)*.

Tas H102.3 Pests and contaminants

Premises where customers are served outside the premises through an opening, that has an appliance for the elimination of flies and mechanical ventilation adequate to exhaust air through the opening at a rate of not less than 5 litres per second for each square metre of opening, satisfies *Tas H102 P1(d)*.

Tas H102.4 Drains and Pipes

Premises satisfy *Tas H102 P3* where—

- (a) A grease trap, a gully trap or an untrapped opening connected directly with a drain or sewer, is not installed in a room used for preparation, processing, packing or storing of food for sale; and
- (b) as far as is practicable, service pipes are concealed beneath the surface of walls, floors or ceilings, or are fixed clear of the wall, floor or ceiling, at such distance as to facilitate cleaning.

Tas H102.5 Offensive material and trade waste

Where offensive material or trade waste is stored, a separate area or room which—

- (a) is paved and easily cleanable; and
 - (b) is graded to drain to a suitable drainage system; and
 - (c) has available a supply of water under pressure,
- satisfies [Tas H102 P4](#).

Tas H102.6 Ventilation

A mechanical ventilating exhaust system complying with the requirements of AS/NZS 1668.1 and AS 1668.2 satisfies [Tas H102 P5](#).

Tas H102.7 Lighting

A lighting system that complies with AS 1680.1 and AS/NZS 1680.2.4 satisfies [Tas H102 P6](#).

Tas H102.8 Floors, walls and ceilings

- (a) A floor, wall or ceiling that is—
 - (i) durable, rigid, impervious to water, non-absorbent, non-toxic and smooth enough to be easily cleaned; and
 - (ii) free from cracks, crevices and other defects,satisfies [Tas H102 P7](#) and [Tas H102 P8](#).
- (b) A floor subject to wet cleaning by hosing down or where liquids are discharged on to the floor, graded to trapped floor waste outlets connected to a drainage installation, satisfies [Tas H102 P7](#).
- (c) Walls that—
 - (i) are free from skirtings, architraves, picture rails or other ledges that could provide lodgement for dirt; and
 - (ii) the angles between the walls and the floor are coved to permit ease of cleaning; and
 - (iii) the angles between walls and all joints in walls are sealed,satisfy [Tas H102 P8\(c\)](#).
- (d) Walls and ceilings that are finished in light colour, and if painted, are washable, satisfy [Tas H102 P8\(d\)](#).
- (e) Sub-clauses [\(a\)](#), [\(b\)](#), [\(c\)](#) and [\(d\)](#) do not apply to areas used only by customers and they do not apply to walls and ceilings in a premises or places—
 - (i) used for the storage or display for sale of food that is wholly enclosed in protective packages; and
 - (ii) used for the storage for sale of fruit and vegetables; or
 - (iii) in which all food for sale is completely enclosed and otherwise protected from contamination by processing plants, other appliances, or other means.

Tas H102.9 Separation of work place

A room where food for sale is processed, manufactured, prepared, deposited, treated, stored or packed, that does not have direct communication with a room containing sanitary facilities, living quarters, laundry, bathroom or garage or a room where animals are housed, satisfies [Tas H102 P8\(b\)](#).

Tas H102.10 Washbasins

Premises or places for preparation or storage of food for sale provided with not less than one washbasin, supplied with hot and cold water through a common outlet, in or within reasonable proximity of those areas where the nature of the activities performed is such that hands are likely to be a source of contamination of food, satisfy [Tas H102 P9](#).

Tas H102.11 Sinks

- (a) Where equipment and utensils are required to be manually cleaned and sanitized, or food preparation requires a sink, premises that are provided with a suitably sized double bowl sink for equipment washing and a separate suitably sized sink for food preparation of stainless steel supplied with—
 - (i) hot and cold water; and
 - (ii) an integral drainer on at least one side or a third bowl,satisfies [Tas H102 P10](#).
- (b) A sink installed adjacent to a wall or other vertical surface, that is fitted with an integral flashing to that wall or vertical surface to a height of not less than 150 mm, satisfies [Tas H102 P10](#).
- (c) A sink provided with an integral surround not less than 150 mm wide except on sides with an integral flashing as in (b), satisfies [Tas H102 P10](#).

Tas H102.12 Design, construction and installation of fixtures, fittings and equipment

- (a) The provision of fixtures, fittings and equipment designed, constructed and installed in accordance with Clause 4.2 and Clause 4.3 of AS 4674 satisfies [Tas H102 P10](#).
- (b) The provision of—
 - (i) automatic equipment that uses water to sanitize utensils or other equipment and only operate for the purposes of sanitation when the water is at a temperature that will sanitize the utensils or equipment; or
 - (ii) a sink that meets [Tas H102.11](#),satisfies [Tas H102 P10](#).

Tas H102.13 Storage of materials and equipment

Separate areas for the storage of fuel, cleaning compounds and general maintenance equipment provided so as to prevent the contamination of the product in the event of a spillage or any other form of breakdown, satisfies [Tas H102 P11](#).

Tas H102.14 Food store

An eating house provided with a dry-food store, satisfies [Tas H102 P11](#).

Tas H102.15 Meat Premises

- (a) Premises used for the preparation or sale of red meat, other than those licensed under the *Meat Hygiene Act 1985*, that comply with—
- (i) Tas Part H106; or
 - (ii) the provisions of [Tas H102.2](#) to [Tas H102.13](#) and [Tas H102.17](#), satisfy in relation to building construction, the requirements of [Tas H102 P1](#) to [P12](#).

Tas H102.16 Dairy produce

Definition:

- (a) **Dairy produce** means milk, cream, butter, cheese, condensed milk, ice-cream, yoghurt and any other product of milk and includes margarine and dairy blend.
- (b) Premises designed and constructed in compliance with the Export Control (Processed Food) Orders satisfy the special requirements of this code for premises to be used for the manufacture of *dairy produce*.

Tas H102.17 Refrigerated and cooling chambers

The construction of a refrigerated chamber or cooling chamber installed in premises for storage of food complying with the requirements for that premises, satisfies [Tas H102 P12](#) where they have—

- (a) internal and external panels adhered directly to the insulating core material to form an integral wall section with tight fitting edges resistant to penetration by liquids; and
- (b) every joint caulked with a water-resistant, flexible sealer and finished in such a manner as to prevent migration of liquids into the core; and
- (c) every intersection of walls with floors and walls with walls covered with a radius not less than 25 mm; and
- (d) exposed slot-head screws or open-headed pop rivets filled with sealer; and
- (e) service pipes and conduits concealed in floors, walls or ceilings, if practicable, or fixed on brackets to provide clearances of not less than 25 mm between the pipe and a wall and 100 mm between the pipe and a floor; and
- (f) fittings not fixed over exposed pipes nor in a position to make difficult the cleaning of the pipe and surrounding area; and
- (g) rat proof construction, and any inaccessible spaces between the low temperature room and surrounding walls, ceilings and fixtures proof against rats and vermin; and
- (h) floors graded, as shown in [Tas Table H102.17\(h\)](#), to drains located outside the chamber as near as practicable to the door opening; and
- (i) drainage from cooling units within the chamber constructed in accordance with [Tas Table H102.17\(i\)](#), draining to a trapped outlet located outside the chamber.

Tas TABLE H102.17(h) FLOOR DRAINAGE OF REFRIGERATED OR COOLING CHAMBERS

	FLOOR SLOPE
Active chillers	not less than 1:50
Other chambers	not less than 1:100

Tas TABLE H102.17(i) DRAINAGE FROM COOLING UNITS WITHIN REFRIGERATED CHAMBERS OR COOLING CHAMBERS

Wall-mounted cooling units - drain water must be contained and removed by either a wall-mounted channel or a spoon drain located under the coil.
Floor-mounted cooling units - drain water must be confined by kerbs, of a height not less than 150 mm, and directed to a trapped drain outlet.
Ceiling-mounted cooling units - drain water must be confined by suitable insulated drip trays directly connected to the drainage system.

After Tas Part H102 insert Tas Part H103 as follows:

TAS PART H103 DINING ROOMS AND BAR ROOMS

Tas H103.1 Application of Part

This Part applies to all dining rooms and bar rooms (excluding bar service areas) in licensed premises covered by the *Liquor and Accommodation Act 1990*.

Tas H103.2 Sanitary facilities

- (a) Separate sanitary facilities for males and females must be provided in close proximity to each dining room and bar room in licensed premises.
- (b) Where the sanitary facilities are not accessed from within the dining room or bar area, reasonable fixed protection from the elements must be provided.

Tas H103.3 Separation from other areas

A dining room must not have direct opening to sanitary facilities, living quarters, a laundry, bathroom or garage or a room where animals are housed.

TAS PART H104 * * * * *

This Part has been deliberately left blank.

TAS PART H105 * * * * *

This Part has been deliberately left blank.

After Tas Part H105 insert Tas Part H106 as follows:

TAS PART H106 MEAT PREMISES

Tas H106.1 Application of Part

This Part is applicable to—

- (a) meat premises processing animals, including game and poultry, and producing meat and meat products for human consumption; and
- (b) pet food works licensed under *Meat Hygiene Act 1985*

Tas H106.2 Premises Processing Animals and Meat

Premises used for the processing of animals and meat for human consumption must comply with the relevant Parts and Sections of the Australian Standards listed below—

- (a) Hygienic Production and Transportation of Meat and Meat Products for Human Consumption, AS 4696 - Part 7, Sections 19 to 21.
- (b) Hygienic Production of Game Meat for Human Consumption, AS 4464 - Sections 6 and 8.
- (c) Construction of Premises and Hygienic Production of Poultry Meat for Human Consumption, AS 4465 - Part A, Sections 3 to 12.
- (d) Hygienic Production of Rabbit Meat for Human Consumption, AS 4466 - Section 5.
- (e) Hygienic Rendering of Animal Products, AS 5008 - Section 4
- (f) Hygienic Production of Ratite (Emu/Ostrich) Meat for Human Consumption, AS 5010 - Section 5.
- (g) Hygienic Production of Natural Casings for Human Consumption, AS 5011 - Section 4.
- (h) Tasmania Code of Practice for Hygienic Production of Pet Food - Section 5.

After Tas Part H106 insert Tas Part H107 as follows:

TAS PART H107 FARM DAIRY PREMISES

Tas H107.1 Application of this Part

This part is applicable to every farm dairy as covered by the *Tasmanian Dairy Industry Act 1994*.

Tas H107.2 Milking Sheds and Holding Yards

- (a) The walls (including the walls of the pit of a herringbone design milking shed) must be non absorbent and easy to clean.
- (b) The floor of a holding yard and a milking shed must be non absorbent, easy to clean and free-draining.
- (c) The lighting of a holding yard and a milking shed must be adequate for proper milking.

- (d) The working space in a milking shed is to be sufficient to minimise the risk of contamination of milk during milking.
- (e) Effluent from a holding yard and a milking shed is to be drained to a suitable point for disposal.
- (f) The requirements of (a), (b) and (c) are satisfied if—
 - (i) the walls are constructed of well-compacted smooth finish concrete or other material sealed to be impervious to moisture; and
 - (ii) the floors are constructed of well-compacted smooth finish concrete and graded to a drain; and
 - (iii) joints between wall sections and walls and floors are sealed to prevent entry of water and pests; and
 - (iv) artificial lighting is designed to comply with AS 1680.

Tas H107.3 Milk Receiving Area and Milk Storage Room

- (a) A Milk Receiving Area and Milk Storage Room must—
 - (i) have internal surfaces that are smooth, non-absorbent, free-draining and easy to clean; and
 - (ii) be constructed so as to prevent the entry of dust, insects, pests, birds and animals; and
 - (iii) have adequate artificial lighting that—
 - (A) is located to provide a clear view of the milk for grading and measuring purposes; and
 - (B) the lights over a bulk vat are to be protected to prevent glass entering the vat if the light is broken; and
 - (C) have switches appropriately located at the milk collection areas; and
 - (iv) have adequate ventilation to aid the drying of floors and walls between milkings.
- (b) The requirements of (a) are satisfied if—
 - (i) the floors are constructed of well-compacted smooth finish concrete and graded to a drain; and
 - (ii) the internal surfaces are smooth, sealed and washable; and
 - (iii) joints between wall sections and walls and floors are sealed to prevent entry of water and pests; and
 - (iv) artificial lighting is designed to comply with AS 1680; and
 - (v) all openings are fitted with doors, windows or screens; and
 - (vi) the milk is stored in a bulk storage tank which complies with AS 1187; and
 - (vii) ventilation is provided in accordance with F4.5.

Tas H107.4 Water supply

An adequate and suitable supply of water must be available for plant sanitation, teat washing, milk cooling and vat rinsing.

After Tas Part H107 insert Tas Part H108 as follows:

TAS PART H108 PHARMACIES

Tas H108.1 Application of Part

This Part applies to all pharmacies to which the *Pharmacy Regulations 1966* apply.

Tas H108.2 Definition

In this Part the following meaning applies—

Dispensary means the room or area within a pharmacy or other premises which a registered pharmaceutical chemist uses for the compounding or dispensing of prescriptions, medicines or drugs.

Tas H108.3 Pharmacy premises

- (a) Each premises used as a pharmacy must have—
- (i) a *dispensary* for the compounding or dispensing of drugs and for the storage of material used in dispensing;
 - (ii) space for the storage of narcotic substances and poisons as *required* by the *Poisons Regulations 1975*;
 - (iii) a place for unpacking containers or cases and goods; and
 - (iv) a room for storing merchandise not used in dispensing.
- (b) A pharmacy may have an area set aside for retailing merchandise that is not compounded or dispensed.

Tas H108.4 Dispensary

- (a) A *dispensary* must be located—
- (i) within a pharmacy in a position to enable a person in the *dispensary* to supervise the *dispensary*, storage areas for narcotic substances and poisons, the entrances to unpacking areas and areas for storing other substances, and the retail area; and
 - (ii) separate from any place where goods are unpacked or where general merchandise, not used in dispensing, is stored.
- (b) Each *dispensary* must be provided with—
- (i) a sink and drainage board of impervious material moulded or manufactured in one piece;
 - (ii) a reticulated supply of hot and a cold water capable of providing to the sink adequate quantities of water for dispensing purposes; and
 - (iii) space for a dispensing bench with a working area not less than 1.4 m².

Tas H108.5 Security of dispensary

- (a) Every *dispensary* and enclosure set aside for the storage of narcotic substances and poisons must be able to be secured against entry.
- (b) If a *dispensary* is located in a pharmacy that is capable of being secured against entry at all times while the *dispensary* is not in use, then the *dispensary* is deemed to be secured against entry.

After Tas Part H108 insert Tas Part H109 as follows:

TAS PART H109 HOSPITALS AND NURSING HOMES

Tas H109.1 Application of Part

This Part applies to every hospital or nursing home.

Tas H109.2 Floor area of wards and bedrooms

The *floor area* of each ward or bedroom must be sufficient to provide not less than—

- (a) 9 m² in a one-bed ward or bedroom; or
- (b) 7.5 m² for each patient or resident accommodated in any other ward or bedroom.

Tas H109.3 Floor and walls

- (a) The surface finish of all floors and walls within the building must have a smooth impervious and non-toxic finish.
- (b) The junctions between floors and walls must be covered for ease of cleaning.
- (c) In operating theatres, all junctions of walls with walls and of walls with ceilings must be covered.
- (d) Provided the requirements of [Specification C1.10](#) are met, the walls and floors complying with (a) may have suitable coverings.

Tas H109.4 Grab rails

Every toilet closet, bath and shower alcove for use by patients or residents must be fitted with grab rails.

Tas H109.5 Insect proofing

Each external opening must be fly-screened except where the openings are fitted with *self-closing* doors or with doors provided with suitable insect repellent devices.

After Tas Part H109 insert Tas Part H110 as follows:

TAS PART H110 PREMISES USED FOR ACTIVITIES INVOLVING SKIN PENETRATION

Tas H110.1 Application of Part

This Part applies to premises for tattooing, ear-piercing, acupuncture and like activities, which require a "public health risk activity" licence under the *Public Health Act 1997*.

Tas H110.2 Sanitary facilities

Sanitary facilities for customers must be provided and must include not less than—

- (a) one water closet; and
- (b) one washbasin.

Tas H110.3 Washbasins

The area in which skin penetration is done must be provided with—

- (a) one wash basin for each 10, or part of 10 employees; and
- (b) an adequate supply of hot and cold water controlled by foot-operated or other suitable means which allows the use of a tap without hand contact.

After Tas Part H110 insert Tas Part H111 as follows:

TAS PART H111 DENTAL SURGERIES AND CHIROPRACTORS' PREMISES

Tas H111.1 Application of Part

This Part applies to premises to be used—

- (a) as a dental surgery and covered by the *Dental Regulations 1983*; or
- (b) in the practice of chiropractic and covered by the *Chiropractors Regulations 1984*.

Tas H111.2 Waiting room

Each dental surgery and chiropractor's premises must have a separate waiting room.

Tas H111.3 Floor, walls and ceiling

The floor, walls and ceiling of a dentist's surgery and each room used in conjunction with that surgery or in a chiropractor's premises must be finished with materials which enable easy cleaning and disinfecting.

Tas H111.4 Disposal of liquid wastes

The operating section of a dental surgery must have adequate means for the disposal of waste water, other liquids and infected matter.

After Tas Part H111 insert Tas Part H112 as follows:

TAS PART H112 MORTUARIES

Tas H112.1 Application of Part

This Part applies to any premises used for the storage or preparation for burial, cremation or disposal by other means, of bodies of deceased persons.

Tas H112.2 Layout of mortuary

- (a) A mortuary may be integral with the remainder of a building but must be separated physically from all public areas of that building.
- (b) Each mortuary at which bodies are prepared for burial, cremation or other disposal must be provided with a body preparation room—
 - (i) capable of being isolated from the remainder of the premises; and

- (ii) having a *floor area* not less than 10 m².
- (c) A vehicle reception area or garage must be provided adjacent to and with direct access to the storage room or body preparation room to ensure that the transfer of uncoffined bodies is screened from public view.
- (d) Access to toilet and shower facilities from any other part of the mortuary premises must be only by way of an air lock.

Tas H112.3 Construction of body preparation room

- (a) The floor must be—
 - (i) of impervious material with a smooth, unbroken surface; and
 - (ii) uniformly graded to a floor drain.
- (b) All walls and partitions must be of concrete or masonry with a smooth, unbroken finish for ease of cleaning.
- (c) All joints between the floor, walls, partitions, ceiling, ventilation grilles, fittings, pipework, *windows* and light fittings must be sealed with impervious material for ease of cleaning.
- (d) All joints between the floor and walls or partitions must be covered for ease of cleaning.
- (e) The body preparation room must be provided with at least one washbasin, fitted with elbow or foot-operated taps, and an adequate supply of hot and cold water.
- (f) The body preparation room must be provided with refrigerated storage facilities—
 - (i) with sufficient capacity for the storage of at least two adult bodies; and
 - (ii) capable of maintaining an internal temperature between 1° and 5°C.

Tas H112.4 Water supply and sewerage

Each mortuary with a body preparation room must be connected to—

- (a) a permanent water supply with a physical discontinuity, provided by a registered break tank or reduced pressure zone device, between the water supply and all equipment, appliances, fittings and areas in the mortuary; and
- (b) a water carriage sewerage system.

After Tas Part H112 insert Tas Part H113 as follows:

TAS PART H113 FOUNDRIES

Tas H113.1 Application of Part

This Part is applicable to every building or premises in which foundry operations are undertaken.

Tas H113.2 General

- (a) Every floor in a foundry must be level and, in places other than where molten metal is poured, must be composed of concrete or similar material or wooden blocks.
- (b) Every part of a foundry must be not less than 4.2 m high—
 - (i) where a ceiling is provided, measured from the floor to the ceiling; or

- (ii) where a ceiling is not provided, measured from the floor to the lowest part of the roof.

Tas H113.3 Cupola charging platform

- (a) The floors of cupola charging platforms must be—
 - (i) of heavy timber or non-slip steel plate;
 - (ii) securely fixed in position; and
 - (iii) level.
- (b) All parts of the cupola charging platform must be covered by a roof not less than 3 m above the platform.
- (c) A cupola charging platform must have—
 - (i) a wall, not less than 1 m high, measured from the floor of the platform, constructed to surround the platform; and
 - (ii) the sides between the top of the wall and the roof suitably waterproofed and ventilated.
- (d) A properly constructed access stair or ramp must be provided to give access to every cupola charging platform and must comply with AS 1657.

Tas H113.4 Deep moulds and pits

Deep moulds or pits, for permanent use—

- (a) must be lined with bricks, concrete, or other suitable material in such a manner as to provide adequate reinforcement and to keep the pit or mould in a dry condition; and
- (b) must be securely fenced by means of a wall of adequate construction, railings or chains and stanchions raised, in each case, to a height not less than 1 m above the surface of the surrounding floor.

Tas H113.5 Pot furnaces

Where pot furnaces are below ground level, the pit must be covered by a substantial grating at the point at which metal is removed from the furnace, and must at all other points be securely fenced as in [Tas H113.4\(b\)](#).

After Tas Part H113 insert Tas Part H114 as follows:

TAS PART H114 PREMISES FOR MANUFACTURE OR PROCESSING OF GLASS REINFORCED PLASTICS

Tas H114.1 Application of Part

This Part is applicable to every building in which glass reinforced plastics are manufactured or processed.

Tas H114.2 Separation from other buildings

A building for manufacture or processing of glass fibre plastics must be—

- (a) separated from other buildings or parts of an occupancy by means of impervious walls with FRL at least 120/120/120; or
- (b) separated from all other buildings by a clear space of not less than 6 m.

Tas H114.3 Rise in storeys

The building must be of single *storey* construction.

Tas H114.4 Maximum floor areas

The *floor area* of any building or fire-separated section must not exceed the relevant maximum *floor area* set out in **Tas Table H114.4**.

Tas TABLE H114.4 MAXIMUM FLOOR AREA (m²) OF BUILDINGS FOR MANUFACTURE OR PROCESSING OF GLASS REINFORCED PLASTICS OR ISOCYANATES

	Type of construction of building—		
	Type A	Type B	Type C
Not Sprinklered	1500	1200	1000
Sprinklered	6000	5000	3000

Tas H114.5 Required exits

- (a) Each fire-separated section of a building which is a work place must have at least two *exits* for escape purposes and the number and location of the *exits* must be such that any point on the floor is not further than 20 m from one of the *exits*.
- (b) Only *exits* with vertically hinged swinging doors may be considered as *exits* for the purposes of this clause.

Tas H114.6 Hand laminating and spray depositing

The walls and floors of areas to be used for hand laminating and spray depositing must be constructed of *non-combustible* materials.

Tas H114.7 Ventilation

- (a) Mechanical or natural ventilation must be via low-level, exhaust ducting in a wall and a fixed, open, floor-level, fresh-air inlet ducting in the opposite wall such as to ensure a cross flow of the ventilation air over the complete working area.
- (b) Mechanical ventilation must provide not less than 6 air changes per hour.
- (c) The ventilation fan and exhaust ducting must be arranged in such a manner as to—
 - (i) produce a negative pressure within any exhaust ducting within the work place so that a leak in the ducting will not vent exhaust air back to the work place; and
 - (ii) vent the exhaust air to the atmosphere so as to prevent recirculation of that exhaust air.

Tas H114.8 Smoke and heat roof vents

Each fire-separated section must be provided with *automatic* smoke and heat roof vents.

After Tas Part H114 insert Tas Part H115 as follows:

TAS PART H115 PREMISES FOR PRODUCTION OR PROCESSING OF ISOCYANATES

Tas H115.1 Application of Part

This Part is applicable to every building in which isocyanate production or processing is undertaken.

Tas H115.2 Areas of work places

Work places in which an isocyanate industry is carried on must be divided into the following divisional areas:

- (a) Administration and staff amenities.
- (b) Workshop.
- (c) Bulk stores.
- (d) Curing room.
- (e) Processing plant.
- (f) Raw materials plant.
- (g) Manufacture.

Tas H115.3 Separation from other areas and buildings

- (a) Each of the divisional areas *required* by **Tas H115.2** other than the administration and staff amenities building, must be—
 - (i) separated from each of the other divisional areas by means of an impervious wall with an FRL not less than 120/120/120; or
 - (ii) separated from all other buildings by a clear space of not less than 6 m.
- (b) Notwithstanding the distance requirements of **(a)**, bulk stores of polyols and bulk stores of isocyanates must comply with the requirements of the *Dangerous Goods (General) Regulations 1998*.

Tas H115.4 Rise in storeys

The building must be of single *storey* construction.

Tas H115.5 Maximum floor areas

The *floor area* of any building or fire-separated section must not exceed the area shown in **Tas Table H114.4**.

Tas H115.6 Required exits

- (a) Every building or divisional area of a work place must have not less than 2 *exits* for escape purposes.
- (b) The number and location of the *exits* must be such that any point on the floor is not more than 20 m from one of the *exits*.
- (c) Only *exits* with vertically hinged swinging doors may be considered as *exits* for the purposes of this clause.

Tas H115.7 Bulk stores for polyols and isocyanates

- (a) A bulk store for polyols must be constructed from *non-combustible* materials and have a smooth impervious concrete floor and it must protect the polyols from direct exposure to the sun's radiation.
- (b) A bulk store for isocyanates must—
 - (i) be constructed from *non-combustible* materials, have a smooth impervious concrete floor, and must protect the isocyanate containers from direct exposure to the sun; and
 - (ii) if it is used for storage of either TDI or HDI and is not an open sided building, be fitted with mechanical ventilation so that the TLV is not exceeded at any time provided that the ventilation must provide not less than 6 air changes per hour.
- (c) The area around both a polyol bulk store and an isocyanate bulk store must be bunded, the bund or bunds must ensure separation of the polyol and isocyanate areas and each bund must have a capacity of 10% more than the storage capacity of the largest tank it protects.

Tas H115.8 Curing room

The curing room for the storage of newly produced flexible polyurethane foam must be constructed of *non-combustible* materials with a smooth impervious concrete floor and fitted *automatic* fire vents in the roof.

After Tas Part H115 insert Tas Part H116 as follows:

TAS PART H116 PREMISES FOR ELECTRO-PLATING ELECTRO-POLISHING, ANODISING OR ETCHING

Tas H116.1 Application of Part

This Part is applicable to every building where any of the processes of electro-plating, electro-polishing, anodising or etching are undertaken.

Tas H116.2 Floors

The floor of every plating area must be—

- (a) so graded as to—
 - (i) permit easy flushing with water; and

- (ii) prevent liquids from flowing from the area into other parts of the work place; and
- (b) chemically resistant to the solutions used in the process.

Tas H116.3 Height of plating area

Every part of a plating area must be not less than 2.7 m in height—

- (a) measured from the floor to the ceiling if a ceiling is provided; or
- (b) measured from the floor to the lowest part of the roof if a ceiling is not provided.

Tas H116.4 Air space

In every plating area there must be not less than 14 m³ of air space for each person employed and, in the calculation of such space, the height taken into account must not exceed 4.2 m.

Tas H116.5 Ceiling construction

The ceiling of a plating area must be so constructed as to prevent, so far as is practicable, atmospheric contaminants from escaping into rooms or work places, situated above the level of the ceiling.

After Tas Part H116 insert Tas Part H117 as follows:

TAS PART H117 PREMISES FOR LEAD PROCESSING

Tas H117.1 Application of Part

This Part is applicable to every building in which lead processes are used.

Tas H117.2 Floors

- (a) The floor of every work place where a lead process is used must be—
 - (i) so constructed of concrete or other suitable material as to be smooth and impervious to fluids; and
 - (ii) graded and properly drained to permit flushing with water.
- (b) The material of which the floor is constructed must be applied to the walls to a height of not less than 75 mm in such a fashion that the angle between the walls and the floor is coved for easy cleaning.

Tas H117.3 Height of lead processing areas

Every part of a lead processing area must be not less than 2.7 m in height—

- (a) where a ceiling is provided, measured from the floor to the ceiling; or
- (b) where a ceiling is not provided, measured from the floor to the lowest part of the roof.

Tas H117.4 Air space and floor space

- (a) In every lead processing area there must be not less than 14 m³ of air space for each person employed therein, and in the calculation of such space the maximum height taken must be not greater than 4.2 m; and

- (b) total floor space for the persons employed in such area, exclusive of space used for storage, must be not less than 3.3 m² for each person so employed.

Tas H117.5 Interior of lead processing areas

- (a) The inner surfaces of the walls of every lead processing area must be of a smooth material impervious to fluids and must not contain any projections on which dust may lodge; and
- (b) the interior construction of the ceiling or roof must, so far as is practicable, be such that dust will not settle on it.

Tas H117.6 Dust collection

Any areas in which dust-forming lead materials are manipulated, moved or treated must be served by a mechanical exhaust ventilation system capable of safely and effectively collecting all dust.

Tas H117.7 Isolation of certain processes

Where any process of pasting of electric accumulator plates or drying of paste plates, or melting down of pasted plates or of formation with tacking in the electric accumulator industry or of manipulation of dry oxide of lead, is to be carried on in the same room as any other lead process, the processes of pasting, drying, melting, formation or manipulation must be isolated from one another and from any other lead process—

- (a) by a partition extending from the floor to the ceiling in the case of a room having a ceiling not more than 3.6 m in height, or to a height of 2.7 m in any other case; or
- (b) by some other suitable method.

Tas H117.8 Drying room shelves

The racks or shelves provided in any drying room must not be more than 2.6 m from the floor nor more than 650 mm in width except that, in the case of racks or shelves set or drawn from both sides, the total width must not exceed 1.3 m.

Tas H117.9 Washing facilities

Washing facilities served with running hot and cold water for the use of all employees engaged in a lead process must be provided consisting of—

- (a) one washbasin for each 5 employees, or part thereof; and
- (b) one shower bath for each 8 employees, or part thereof.

Tas H117.10 Change rooms

In every work place in which lead is processed there must be provided two suitable furnished change rooms for the use of employees as follows—

- (a) one of the change rooms must be used for taking off, storing, and putting on of the street clothing of employees;
- (b) the other of the change rooms must be used for the taking off, storing, and putting on of overalls and other clothing worn in any work room;

- (c) each change room must be so constructed and situated as to prevent the entry into the room of dust or fumes generated in a workroom; and
- (d) each change room must be in close proximity to the washing facilities *required* in **Tas H117.9**.

After Tas Part H117 insert Tas Part H118 as follows:

TAS PART H118 BOOTHES FOR SPRAY PAINTING OR SPRAY COATING

Tas H118.1 Application of Part

This Part is applicable to every building in which spray painting or spray coating is undertaken.

Tas H118.2 Design and construction of booths

A spray painting booth is to be designed and constructed to comply with AS/NZS 4114.1 Spray Painting Booths, designated spray painting areas and paint mixing rooms. Part 1: Design, construction and testing.

After Tas Part H118 insert Tas Part H119 as follows:

TAS PART H119 ELECTRICITY DISTRIBUTION SUBSTATIONS

Tas H119.1 Application of Part

This Part is applicable to every surface building type electricity distribution substation as defined in Aurora Energy's "Distribution Substation Design and Construction Standard".

Tas H119.2 Building-type substations

A building-type electricity distribution substation which complies with the building design and construction requirements of Aurora Energy's "Distribution Substation Design and Construction Standard" satisfies this Part.

After Tas Part H119 insert Tas Part H120 as follows:

TAS PART H120 PREMISES FOR STORAGE OF DANGEROUS GOODS

Tas H120.1 Application of Part

This Part applies to every building used for the storage of dangerous goods covered by the *Dangerous Goods Act 1998* except for explosives.

Tas H120.2 Interpretation

The words “dangerous goods”, “explosive” and “flammable liquid” have the same meaning as in the *Dangerous Goods Act 1998*.

Tas H120.3 Class of dangerous goods

The classification of dangerous goods will be as prescribed in the *Dangerous Goods (General) Regulations 1998*.

Tas H120.4 Premises for storage of dangerous goods

- (a) A building must comply with the relevant Australian Standard, applicable to the storage of dangerous goods listed below—
- (i) Class 3 flammable liquids: AS 1940
 - (ii) Pesticides: AS 2507
 - (iii) Liquefied petroleum gas: AS/NZS 1596
 - (iv) Gas installations: AS 5601
 - (v) Anhydrous ammonia: AS 2022
 - (vi) Chlorine: AS/NZS 2927
 - (vii) Organic peroxides: AS 2714
 - (viii) Class 8 substances-Corrosives: AS 3780
- (b) Except as provided in (a) a room, or space, for the storage of dangerous goods must be on the ground floor and may be—
- (i) attached to an *external wall* of a building; or
 - (ii) located within a building; or
 - (iii) separate from any building.
- (c) A room, or space, attached to or located within a building must be separated from the remainder of the building by one or more walls, each having an FRL not less than 240/240/240.
- (d) Every *external wall* of a room used for the handling or storage of dangerous goods, if not *required* to have an FRL, must be *non-combustible*.
- (e) If a storage area attached to an *external wall* of a building is a space without walls, other than the separating wall, the fire protected separating wall must extend for a distance of 5 m on each side of the common part of the wall or to the end of the wall, whichever is less.
- (f) Unless the wall *required* in (c) extends, over its full length, to the underside of the roof covering, the ceiling of a room, or space, for the storage of dangerous goods must have FRL not less than 180/180/180.
- (g) The floor surface of a room, or space, for the storage of dangerous goods must be—
- (i) of hardwood or a *non-combustible* material; and
 - (ii) resistant to attack by, and compatible with the dangerous goods stored in the room or space; and
 - (iii) of impervious construction.

- (h) Where a Class 2.1 flammable gas cylinder is to be stored in a recess enclosed by walls and a ceiling, the side opposite the cylinder safety valve must allow for the free unimpeded discharge of gas from the safety valve.
- (i) The requirement of (h) is satisfied if the side is provided with a secure full height open *non-combustible* mesh or similar open material access door or enclosure with openings sufficient to prevent interference to the installation.
- (j) Except as *required* in (h) and (i), the provisions of the Australian Standards shall apply in cases of conflict between these provisions and those in the following section of this Appendix.

Tas H120.5 Workrooms

A workroom for industrial or commercial use of dangerous goods must—

- (a) be located in accordance with AS 2430 Part 1 from any *fire source feature*; and
- (b) have all doors opening outwards; and
- (c) have passages of escape clear of machinery or other plant.

Tas H120.6 Exits

- (a) *Exits* must be provided in accordance with **Part D1**.
- (b) Any door in a wall, separating a room or space for storage and handling of dangerous goods from another room, must have an FRL in accordance with **Specification C1.1** but not less than 120/120/120.

Tas H120.7 Explosion vents

- (a) A room, or space, in which dangerous goods are stored must be provided with natural or mechanical ventilation so that any vapour generated within the storage is diluted with and removed by air passing through the storage area. Air dilution of the vapour should be sufficient to maintain the storage below the lower explosive limits and recommended workplace exposure standards.
- (b) The requirements of (a) are satisfied if ventilation provided to the room or space in which the dangerous goods are stored is in accordance with the ventilation requirements of AS 1940.

Tas H120.8 Spill Collection Bunds

- (a) A spill collection bund must be provided for all liquid dangerous goods stored in a room or space.
- (b) For Class 3 dangerous goods the bund must comply with the requirements of AS 1940.
- (c) For liquid dangerous goods other than Class 3, the spill collection bund—
 - (i) must be capable of containing 100% of the largest package or tank plus 25% of the storage capacity up to 10 000 L together with 10% of the storage capacity greater than 10 000 L; and
 - (ii) may form part of the room or space or may be separate; and
 - (iii) must be constructed of materials that are impervious to the dangerous goods it is to contain.
- (d) Separate bunds must be provided for dangerous goods that are incompatible.

Tas H120.9 Electrical equipment

Any electrical equipment in a room or space used for the storage of dangerous goods is to comply with the provisions outlined in AS 2430 Part 1 and AS 2381 Part 1, 2, 6 and 7.

After Tas Part H120 insert Tas Part H121, as follows:

TAS PART H121 HAIRDRESSERS' PREMISES

Tas H121.1 Application of Part

This Part applies to any building or part of a building used as a hairdressers' premises.

Tas H121.2 Size of operating section

The operating section of a hairdressers' premises must have—

- (a) any floor plan dimension not less than 2.5 m; and
- (b) a *floor area* sufficient to enable the operations to proceed without inconvenience to the operators or the customers.

Tas H121.3 Premises in a residence

A hairdressers' premises located in a residence must—

- (a) be isolated from the living quarters; and
- (b) have direct access from a public place.

Tas H121.4 Sanitary facilities

Except where sanitary facilities are available for common use, every hairdressers' premises which has more than 5 operating seats must be provided with one water closet and one washbasin for use by customers.

After Tas Part H121 insert Tas Part H122 as follows:

TAS PART H122 CENTRE-BASED CHILD CARE FACILITIES

OBJECTIVE

Tas H122 O1

The *Objective* of this Part is to regulate the physical specification of a *centre-based child care facility* at which child care or a child care service is operated or provided.

FUNCTIONAL STATEMENT

Tas H122 F1

A *centre-based child care facility* must be designed and constructed to provide a safe environment and provide for the health, safety and well-being of the children, parents and staff using the centre.

PERFORMANCE REQUIREMENTS

Tas H122 P1

The design and construction of a *centre-based child care facility* must to the degree necessary, provide an environment that is spacious enough to prevent overcrowding, and supports a range of daily activities and routines including–

- (a) indoor playing; and
- (b) outdoor playing; and
- (c) sleeping.

Tas H122 P2

A *centre-based child care facility*, must to the degree necessary, have sufficient space and facilities to ensure a healthy, safe and comfortable environment for children, staff and parents including–

- (a) sanitary facilities; and
- (b) nappy changing facilities; and
- (c) laundry facilities; and
- (d) food preparation facilities; and
- (e) reception, administration and staff facilities; and
- (f) storage facilities; and
- (g) suitable–
 - (i) floor surfaces; and
 - (ii) lighting and ventilation; and
 - (iii) fire safety provisions; and
 - (iv) windows and glazing; and
 - (v) heating and cooling.

Tas H122 P3

A *centre-based child care facility* must to the degree necessary, have fencing around the perimeter of any outdoor play space, and any identified hazard isolated by fences, barriers and gates.

Application:

Tas H122 O1, **Tas H122 F1** and **Tas H122 P1** to **Tas H122 P3** apply to a *centre-based child care facility* licensed under the *Child Care Act 2001*.

DEEMED-TO-SATISFY PROVISIONS**Tas H122.0 Application of Part**

This Part applies to a *centre-based child care facility* licensed under the *Child Care Act 2001*.

Tas H122.1 Deemed-to-Satisfy Provisions

- (a) *Performance Requirement Tas H122 P1* is satisfied by complying with the relevant provisions of **Tas H122.2** to **Tas H122.4**.
- (b) *Performance Requirement Tas H122 P2* is satisfied by complying with the relevant provisions of **Tas H122.5** to **Tas H122.15**.
- (c) *Performance Requirement Tas H122 P3* is satisfied by complying with the relevant provisions of **Tas H122.16**.

Tas H122.2 Indoor play space

- (a) A *centre-based child care facility* is to be provided with an indoor playroom or area with a floor area allowing a clear unencumbered play space of at least 3.25 m² for each child cared for in the room or area.
- (b) When calculating the clear unencumbered indoor play space required in (a) any passageway or thoroughfare, kitchen in a *centre-based care class 1 facility*, toilet or shower area, storage area (including cupboards, children's lockers / bag hooks, bookcases, storage / art trolleys or the like), areas through which doors may swing, cot rooms (including areas where fixed cots will be used or stored) or any other ancillary area is not to be included.
- (c) The indoor play space in a *centre-based child care facility* is to be directly accessible to the toilet facilities.

Tas H122.3 Outdoor play space

- (a) A *centre-based care class 1 facility* is to be provided with a minimum outdoor play space of 7 m² of unencumbered space per child cared for in the centre.
- (b) A *centre-based care class 2 facility* is to be provided with a minimum outdoor play space of 12 m² of unencumbered space per child cared for in the centre.
- (c) When calculating the unencumbered outdoor play space required by (a) or (b) any storage shed or other fixed item that prevents children from using the space is not to be included.
- (d) The requirements of (a) or (b) may be reduced in a built up area if determined by the State licensing authority for child care services that the lesser requirement will not impact negatively on children using the centre.

- (e) The outdoor play space of a *centre-based child care facility* is to be directly accessible to the indoor play space.

Tas H122.4 Sleep space

- (a) A *centre-based care class 1 facility* is to be provided with a sleep room or area additional to the play space with a floor area allowing a clear unencumbered space of at least 2 m² for—
- (i) each child 12 month and under cared for in the centre; and
 - (ii) half the number of children aged one year cared for in the centre.
- (b) The provisions of (a)(ii) are not *required* where children over 12 months and under 2 years attend a centre where care is only provided for up to four hours per day for any individual child.
- (c) Where the sleep area requirements of (a) are contained in a separate room, a viewing panel is to be provided into the room to allow direct and easy monitoring of the children sleeping.

Tas H122.5 Sanitary facilities

Toilets, hand basins, and baths, are to be provided in a *centre-based child care facility* in accordance with F2.3.

Tas H122.6 Nappy changing facilities

- (a) In a *centre-based care class 1 facility* where children under 3 years are cared for, a nappy changing area is to be provided with—
- (i) a change bench; and
 - (ii) hot and cold water supply to all fittings; and
 - (iii) a hand basin; and
 - (iv) a bath in accordance with F2.3; and
 - (v) a slop hopper, sluice, additional toilet or other device for the disposal of liquid or solid waste; and
 - (vi) fixed or retractable steps, for toddlers to climb up onto the change bench.
- (b) Where the nappy change requirements of (a) are separated from the play area a viewing panel is to be provided into the play area from the nappy change area to allow direct monitoring of the children in the play area.
- (c) A nappy change area *required* by (a) is to be ventilated to remove offensive odours.
- (d) Where elbow action taps are provided to the bath required by (a)(iv) a hand basin required by (a)(iii) may be deleted from the nappy changing area.

Tas H122.7 Laundry facilities

- (a) A *centre-based care class 1 facility* is to be provided with facilities for sanitary storage of soiled clothes, nappies and linen pending laundering or disposal.
- (b) In addition to the requirements of (a), a *centre-based care class 1 facility* where children under 3 years are cared for is to be provided with a laundry facility in accordance with **F2.3(g)(iii)(A)**.

Tas H122.8 Floor surfaces

The floor surface in a toilet or wet area of a *centre-based child care facility* is to be impervious to the penetration of liquids and is to have a slip-resistant surface.

Tas H122.9 Food preparation facilities

- (a) A *centre-based care class 1 facility* is to be provided with—
- (i) a kitchen with facilities in accordance with **F2.3(g)(i)**; and
 - (ii) space for a stove or microwave located in the kitchen; and
 - (iii) hot and cold water.
- (b) The requirement of **(a)(ii)** is not *required* where the care provided to children is for 4 hours or less a day.
- (c) In a *centre-based care class 1 facility* where children under 2 years are cared for, the facilities *required* by **(a)** are to be adjacent to or part of a babies / toddlers room, or additional separate facilities are to be provided in or adjacent to the babies / toddlers room.
- (d) The additional separate facilities *required* by **(c)** are to include—
- (i) a sink with hot and cold water supply; and
 - (ii) a space for a refrigerator; and
 - (iii) a space for a facility for heating babies' bottles and food.
- (e) Where facilities are provided in accordance with **(a)**, the facilities are to be protected by a door or gate with childproof latches to prevent access to the facilities by children.
- (f) A *centre-based care class 2 facility* is to be provided with—
- (i) a sink with hot and cold water supply; and
 - (ii) a space for a refrigerator.

Tas H122.10 Reception, administration and staff respite areas

In a *centre-based child care facility* where children are cared for more than 4 hours a day an area is to be provided for—

- (a) the administration of the centre; and
- (b) private consultation with parents; and
- (c) the respite of staff.

Tas H122.11 Storage facilities

In a *centre-based child care facility* adequate and safe storage is to be provided for—

- (a) children's personal belongings; and
- (b) play equipment, resources and materials; and
- (c) administrative records; and
- (d) cleaning equipment and materials.

Tas H122.12 Lighting and ventilation

A *centre-based child care facility* is to be provided with–

- (a) natural lighting in accordance with **F4.1(d)** and **F4.2**; and
- (b) Ventilation in accordance with **F4.5**.

Tas H122.13 Fire safety

A *centre-based child care facility* is to be provided with–

- (a) An automatic fire detection system in accordance with **Tas EP1.7**, **Tas E1.0** and **Tas E1.101**; or
- (b) a smoke alarm system in accordance with **Clause 3 of Specification E2.2a** where the centre is–
 - (i) only one storey; and
 - (ii) the floor area of the storey is not more than 500 m²; and
- (c) *required exits* in accordance with **D1.2**; and
- (d) portable fire extinguishers in accordance with **E1.6**.

Tas H122.14 Glazing and windows

- (a) The glazing in a *centre-based child care facility* is to be in accordance with **B1.4(h)**.
- (b) The sills of 50% of the *windows* in a play room or the like used by children in a *centre-based care class 1 facility* are to be located at a level to optimise the view of the outdoor environment by children and staff.
- (c) In a *centre-based care class 1 facility* where it is possible for a child to fall through an openable *window* 600 mm or more above the ground surface and the *window* opens more than 100 mm, a lock, secured screen or other device is to be fitted to the *window*.
- (d) Where awning windows are used in a *centre-based child care facility*, they are to be located at a level to prevent injury to staff and children using the building and the outdoor play space.

Tas H122.15 Heating and Cooling

In a *centre based child care facility*–

- (a) heating and or cooling is to be provided to the areas that are occupied by children to maintain a safe and comfortable temperature to the areas of between 16°C to 20°C; and
- (b) where heating units and fans are used, they are to be safely situated, to prevent access and injury to children.

Tas H122.16 Fences and barriers

- (a) Any outdoor play space in a *centre-based care class 1 facility* is to be enclosed on all sides with fences and other barriers, which have an effective perpendicular height of at least 1200 mm, and together with any gates and fittings comply with AS 1926.1.
- (b) In a *centre-based child care class 1 facility* where there is child access to a deck, patio, landing or the like and to a stair or ramp, and there is a difference in level of 600 mm or

more, a barrier is to be provided in accordance with **D2.16(f)** and **D2.16(g)(ii)**, except that any openings in the barrier must not permit a 100 mm sphere to pass through the barrier.

- (c) In a *centre-based child care class 2 facility* where there is child access to a deck, patio, landing or the like and to a stair or ramp, and there is a difference in level of 1000 mm or more, a barrier is to be provided in accordance with **D2.16(f)** and **D2.16(g)(ii)**.
- (d) Any *swimming pool* associated with a *centre-based child care facility* is to have a suitable barrier to restrict access by young children to the immediate pool surrounds in accordance with AS 1926 - Part 1 and Part 2.

After Tas Part H122 insert Tas Part H123 as follows:

TAS PART H123 TEMPORARY STRUCTURES

OBJECTIVE

Tas H123 O1

The objective of this Part is to safeguard the *public* who assemble for public events in *temporary structures* and other persons who use *temporary structures* from illness or injury.

FUNCTIONAL STATEMENT

Tas H123 F1

A *temporary structure* is to—

- (a) withstand the combination of loads and other actions to which it may reasonably be subjected; and
- (b) be of materials that resists the spread of fire so that occupants have time to evacuate safely without being overcome by the effect of a fire; and
- (c) be provided with—
 - (i) safe, equitable and dignified access for the people using the structure; and
 - (ii) means of evacuation that allow occupants time to evacuate safely without being overcome by the effects of an emergency; and
 - (iii) a safe and hazard free environment for the people using the structure; and
 - (iv) adequate lighting upon failure of normal lighting during an emergency; and
 - (v) adequate means for occupants to identify exits and paths of travel to an exit; and
 - (vi) fire fighting equipment for occupants to undertake fire-fighting operation if a fire occurs; and
 - (vii) sanitary facilities for personal hygiene for the people using the structure; and

- (viii) natural or artificial lighting to enable the safe use and movement of people using the structure; and
 - (ix) means of ventilation with outdoor air which will maintain adequate air quality; and
- (d) have any—
- (i) electrical services in or associated with the structure installed in a manner that provides adequate safety for occupants; and
 - (ii) heating appliances located in the structure installed in a way that reduces the likelihood of fire and harmful emissions spreading beyond the appliance; and
 - (iii) temporary seating located in or associated with the structure able to withstand the combination of loads and other actions to which they may reasonably be subjected to and provide a safe means of evacuation in an emergency.

PERFORMANCE REQUIREMENTS

Tas H123 P1

A *temporary structure* must, to the degree necessary, be capable of sustaining at an acceptable level of safety and serviceability the most adverse combination of loads and other actions to which it may reasonably be expected to be subjected.

Tas H123 P2

The material used in a *temporary structure* must, to the degree necessary, be capable of resisting the spread of fire to limit the generation of smoke and heat, and any toxic gases likely to be produced.

Tas H123 P3

- (a) Access must be provided to the degree necessary, to enable safe, equitable and dignified movement of people to and within a *temporary structure*.
- (b) So that people can move safely to and within a *temporary structure*, it must have—
 - (i) walking surfaces with safe gradients; and
 - (ii) stairways and ramps with slip-resistant walking surfaces; and
 - (iii) suitable handrails where necessary to assist and provide stability to people using a stairway or ramp.

Tas H123 P4

- (a) *Exits* must be provided to the degree necessary, from a *temporary structure* to enable the safe evacuation of occupants, with their number, location and dimensions being appropriate to the—
 - (i) travel distances to *exits*; and
 - (ii) number, mobility and other characteristics of the occupants; and
 - (iii) function or use of the structure.

- (b) So that occupants can safely evacuate a *temporary structure*, paths of travel to *exits* must have dimensions appropriate to the—
- (i) number, mobility and other characteristics of the occupants; and
 - (ii) function or use of the structure.

Tas H123 P5

Where a person could fall 1 m or more, due to a sudden change of level within or associated with a *temporary structure*, a barrier must to the degree necessary, be provided which must be—

- (a) continuous and extend for the full extent of the hazard; and
- (b) of a height to protect the people from accidentally falling from the level; and
- (c) constructed to prevent the people from falling through the barrier; and
- (d) capable of restricting the passage of children; and
- (e) of strength and rigidity to withstand the foreseeable impact of the people and where appropriate, the static pressure of the people pressing against it.

Tas H123 P6

A level of illumination for safe evacuation from a *temporary structure* in an emergency must be provided, to the degree necessary, appropriate to the—

- (a) function or use of the structure; and
- (b) size of the structure; and
- (c) distance of travel to an *exit*.

Tas H123 P7

To facilitate evacuation from a *temporary structure* suitable signs or other means of identification must, to the degree necessary—

- (a) be provided to identify the location of *exits*; and
- (b) guide the occupants to *exits*; and
- (c) be clearly visible to the occupants; and
- (d) operate in the event of power failure for sufficient time for the occupants to safely evacuate.

Tas H123 P8

Fire equipment must be installed in a *temporary structure* to the degree necessary, to allow the occupants to undertake initial attack on a fire appropriate to the—

- (a) function or use of the structure; and
- (b) fire hazard

Tas H123 P9

Sanitary facilities for personal hygiene must be provided in a convenient location associated with a *temporary structure*, to the degree necessary, appropriate to the—

- (a) function or use of the structure; and

- (b) number and gender of the occupants; and
- (c) disability or other particular needs of the occupants.

Tas H123 P10

Lighting must be installed to the degree necessary, to provide a level of illumination appropriate to the function or use of a *temporary structure* to enable safe use and movement by the occupants.

Tas H123 P11

Ventilation must be provided to the degree necessary, to a level appropriate to the function or use of a *temporary structure*.

Tas H123 P12

Electrical services must be installed to the degree necessary, to provide a level of safety appropriate to the environment and function or use of a *temporary structure* by the occupants.

Tas H123 P13

Where provided in a *temporary structure*, a heating appliance and its associated components must be installed to the degree necessary—

- (a) to withstand the temperatures likely to be generated by the appliance; and
- (b) so that it does not raise the temperature of any structural element to a level that would adversely affect the element's physical or mechanical properties or function; and
- (c) so that hot products of combustion will not—
 - (i) escape through the walls of the associated components; and
 - (ii) discharge to a position that will cause fire to spread to nearby combustible materials or allow smoke to penetrate the *temporary structure*; and
 - (iii) in the case of solid-fuel burning appliances, be discharged above appropriate emission limits.

Tas H123 P14

A *temporary structure* of tiered seating must be designed and constructed to the degree necessary, to provide for the safety of the occupants and orderly means of evacuation in an emergency.

Application:

Tas H123 O1, **Tas H123 F1** and **Tas H123 P1** to **P14** only applies to a *temporary structure* that—

- (a) is used by the *public* as a place of assembly as described in the *Public Health Act 1997*; and
- (b) is a *temporary structure* as described in the *Building Act 2000*.

DEEMED-TO-SATISFY PROVISIONS

Tas H123.0 Application of Part

This Part only applies to a *temporary structure* that–

- (a) is used by the *public* as a place of assembly as described in the *Public Health Act 1997*; and
- (b) is a *temporary structure* as described in the *Building Act 2000*.

Tas H123.1 Deemed-to-Satisfy Provisions

Performance Requirements Tas H123 P1 to *Tas H123 P14* are satisfied by complying with the relevant provisions of *Tas H123.0* to *Tas H123.15*.

Tas H123.2 Structure

- (a) A *temporary structure* must be capable of resisting loads and actions determined in accordance with the following:
 - (i) Dead and live loads and load combinations: AS 1170.1 or AS/NZS 1170.1
 - (ii) Wind loads: AS 1170.2 or AS/NZS 1170.2.
- (b) Materials and forms of construction used in a *temporary structure* must as far as practicable comply with the relevant Australian Standard.

Tas H123.3 Fire resisting material

Roof and wall coverings to a *temporary structure* (including any lining or internal materials) must not be more than the Spread-of-Flame Index and the Smoke-Developed Index values in **Table Tas H123.3**:

TABLE Tas H123.3

Component	Spread of Flame Index	Smoke Developed Index
Roof covering (ceiling); or	6	3
Roof covering (ceiling); & walls; and	0	7
Walls (including lining material); or	6	5
Walls (including lining material)	0	7
Note:		
The <i>spread-of-flame</i> and <i>smoke-developed index</i> are interrelated. When reading the table, the <i>spread-of-flame index</i> for a component determines the <i>smoke-developed index</i> for the component. If the <i>spread-of-flame index</i> for components is zero, then a higher <i>smoke-developed index</i> is permitted.		

Tas H123.4 Access

- (a) Access for people with disabilities must be provided to and within a *temporary structure* by means of a continuous path of travel.
- (b) Access for people with disabilities must be provided to:
 - (i) any public sanitary facilities; and
 - (ii) all areas normally used by the *public* but excluding those areas only used by persons working in the *temporary structure*.
- (c) If fixed seating is provided, in a *temporary structure*, wheelchair spaces must be provided not less than—
 - (i) 1 wheelchair space for up to 100 seats; and
 - (ii) 2 wheelchair spaces for 100 - 200 seats; and
 - (iii) an additional wheelchair space for each additional 200 seats or part thereof.
- (d) Parts of the *temporary structure* required to be accessible must comply with AS 1428.1.

Tas H123.5 Exits and entrances

- (a) *Exits* to be provided to a *temporary structure* must be not less than the number of *exits* and aggregate width specified in **Table Tas H123.5** for the number of persons accommodated.
- (b) *Exits* are to be distributed as evenly as practicable around a *temporary structure*.
- (c) The maximum travel distance to an *exit* must as far as practicable, not be more than 20 m where only one *exit* is provided and 40 m where more than one *exit* is provided.
- (d) Every part of an entrance or *exit* must provide a minimum unobstructed height of 2000 mm and, where the entrance or *exit* is beneath a stepped seating platform, infilled riser or other projections, and overhead protection must be provided above the entrance or path of travel to the *exit*.
- (e) A flap or curtain used to cover an exit must be so designed that, when it is secured, it will not obstruct or impede egress.

Tas TABLE H123.5

Number of exits and width		
Accommodation Provided (persons)	Number of <i>Exits Required</i>	Aggregate Width of <i>Exits</i> (mm)
1-25	1	1000
26-50	1	1500
51-75	2	2000
76-100	2	2500
101-200	3	3000
201-400	3	4000
401-600	4	6000

Tas TABLE H123.5— continued

Number of exits and width		
Accommodation Provided (persons)	Number of <i>Exits Required</i>	Aggregate Width of <i>Exits</i> (mm)
601-800	5	8000
801-1000	5	9000
over 1000	5 plus one additional <i>exit</i> for each additional 450 persons or part thereof.	9000 plus 500 mm for each additional 50 persons or part thereof.

Note:

(a) Where only one *exit* is provided that *exit* must be at least 1000 mm wide.

(b) Where 2 *exits* are provided each must be at least 1000 mm wide.

(c) Width may be reduced by 250 mm at doorways.

Tas H123.6 Barriers

A rigid barrier with no openings more than 125 mm wide must—

- (a) be provided at least 1000 mm high above the floor of a platform used as a *temporary structure*, and extend in the case of
 - (i) a stepped platform, from the front of the first riser to the back of the platform and along the rear of that platform for its full width; and
 - (ii) an inclined platform, from the front of the first row of seating to the back of the highest platform and along the rear of that platform for its full width; and
 - (iii) any other platform which is more than 1m above the surrounding surface, other than a performance stage, to each side of the platform; and
- (b) not obstruct any aisle, cross-over or *exit*.

Tas H123.7 Emergency lighting

An emergency lighting system must as far as practicable—

- (a) be installed in any enclosed area of a *temporary structure* more than 300 m² in area; and
- (b) comply with AS 2293.1.

Tas H123.8 Exit signs

Exit signs must as far as practicable be provided above all *exits* and comply with AS 2293.1.

Tas H123.9 Fire fighting equipment

Portable fire extinguishers must as far as practicable be—

- (a) provided in a *temporary structure* as listed in **Table Tas H123.9** ; and
- (b) be selected, located and distributed in accordance with Section 1, 2, 3, and 4 of AS 2444.

TABLE Tas H123.9

Requirements for extinguishers	Risk class (as defined in AS 2444)
All <i>temporary structure</i>	(a) To cover Class A fire risks: (b) To cover Class B fire risks in locations where flammable liquids in excess of 20 litres are stored or used (not including liquid held in fuel tanks or vehicles); (c) To cover fire risks involving live electrical equipment (E). (d) To cover Class F fire risks involving cooking oils and fats in cooking areas:

Tas H123.10 Sanitary facilities

Sanitary facilities must as far as practicable be provided, within a 50 m distance from a *temporary structure* according to the numbers set out in **Table Tas H123.10**.

TABLE Tas H123.10

Sanitary Facilities									
	Closet Fixtures			Urinals			Washbasins		
	1	2	Each extra	1	2	Each extra	1	2	Each extra
Sanitary facilities to be provided									
Number of males	100	300	200	50	100	50*	50	200	200
Number of females	25	50	50**	-	-	-	50	150	200
*Where the number of male patrons exceeds 250, not less than 5 urinals must be provided plus one additional urinal for every additional 100 males in excess of 250. **Where the number of female patrons exceeds 250, not less than 6 closet fixtures must be provided plus one additional closet fixture for every 100 females in excess of 250. A unisex facility must be provided for people with disabilities and this facility must comply with AS 1428.1.									

Tas H123.11 Lighting

- (a) Natural or artificial lighting must be provided to all enclosed areas in a *temporary structure*.
- (b) Natural lighting must as far as practicable be not less than 10% of the floor area of the enclosed area.
- (c) The artificial lighting system must as far as practicable comply with the relevant provisions of AS 1680 Parts 1, 2.0, 2.1, 2.2 and 2.3.

Tas H123.12 Ventilation

- (a) Natural ventilation or mechanical ventilation must be provided to all enclosed areas in a *temporary structure*.
- (b) Natural ventilation must as far as is practicable consist of openings or devices which can be opened with an aggregate opening of not less than 5% of the floor area of the enclosed area.
- (c) Mechanical ventilation must as far as practicable comply with the relevant provisions of AS 1668.2.

Tas H123.13 Electrical

- (a) All electrical installations in a *temporary structure* must be installed in accordance with AS/NZS 3002.
- (b) All electrical equipment in a *temporary structure* must be tested in accordance with AS 3760.

Tas H123.14 Heating appliances

The installation of a stove, heater or similar appliance in a *temporary structure* must as far as practicable comply with the following standards:

- (a) Domestic oil-fired appliances – Installation: AS 1691.
- (b) Domestic solid-fuel burning appliances – Emissions: AS/NZS 4013
Installation: AS/NZS 2918.
- (c) Pressure equipment: AS/NZS 1200.
- (d) L P gas portable mobile appliances: AS 2658.

Tas H123.15 Seating

A seating area in a *temporary structure* must as far as practicable comply with **H1.4**.

Footnote: OTHER LEGISLATION AFFECTING BUILDINGS

All legislative technical requirements affecting the design, construction and/or performance of buildings are consolidated into the Building Act 2000 and other legislative instruments under that Act, such as regulations, codes (including this Code) and standards.

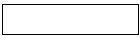

VICTORIA

INTRODUCTION

This Appendix contains variations and additions to the Building Code of Australia (BCA) provisions which are considered necessary for the effective application of the Code in Victoria and shall be treated as amendments to the Code.

APPENDIX CONTENTS

APPENDIX VICTORIA

Victoria

A GENERAL PROVISIONS

- Vic A1.1 Definitions
- Vic Specification A1.3 Standards Adopted by Reference

D ACCESS AND EGRESS

- Vic D1.4 Exit travel distances
- Vic D1.6 Dimensions of exits and paths of travel to exits
- Vic D2.21 Operation of latch

E SERVICES AND EQUIPMENT

- Vic Table E1.5 Requirements for Sprinklers
- Vic Specification E1.5 Fire Sprinkler Systems
- Vic Specification E2.2a Smoke Detection and Alarm Systems

F HEALTH AND AMENITY

- Vic FF2.2 Functional Statements
- Vic FP2.2 - Vic FP2.3 Performance Requirements
- Vic F2.0 Deemed-to-Satisfy Provisions
- Vic F2.3 Facilities in Class 3 to 9 buildings
- Vic Table F2.3 Sanitary Facilities in Class 3, 5, 6, 7, 8 and 9 Buildings
- Vic F2.5 Construction of sanitary compartments
- Vic F2.101 First aid rooms
- Vic FO3 Objective
- Vic FF3.1 Functional Statement
- Vic FP3.1 Performance Requirement
- Vic F3.0 Deemed-to-Satisfy Provisions
- Vic F3.101 Childrens services - size of rooms
- Vic F3.102 Class 3 buildings - size of rooms
- Vic F3.103 Class 3, 9a and 9c residential aged care buildings - size of rooms
- Vic F4.1 Provision of natural light
- Vic F4.2 Methods and extent of natural lighting

G ANCILLARY PROVISIONS

- Vic G1.1 Swimming pools

H SPECIAL USE BUILDINGS

Vic Part H101 CLASS 3, CLASS 9a and CLASS 9c RESIDENTIAL AGED CARE BUILDINGS

- Vic HP101.1 - HP101.3 Performance Requirements
- Vic H101.0 Deemed-to-Satisfy Provisions
- Vic H101.1 Application of Part
- Vic H101.2 Doorway width
- Vic H101.3 Windows
- Vic H101.4 Grab rails and handrails
- Vic H101.5 Water temperature
- Vic H101.6 Electronic communications system
- Vic H101.7 Electrical power outlets

Vic Part H102 PLACES OF PUBLIC ENTERTAINMENT

- Vic HP102.1 - HP102.3 Performance Requirements
- Vic H102.0 Deemed-to-Satisfy Provisions
- Vic H102.1 Application of Part
- Vic H102.2 Temporary tiered seating, concourses and embankments
- Vic H102.3 Motor vehicle racing
- Vic H102.4 Sanitary and amenity facilities

Vic Part H103 FIRE SAFETY IN CLASS 2 AND CLASS 3 BUILDINGS

- Vic H103.1 Fire safety in Class 2 and Class 3 Buildings

Vic Part H104 CLASS 9b CHILDREN'S SERVICES

- Vic HP104.1 - HP104.3 Performance Requirements
- Vic H104.0 Deemed-to-Satisfy Provisions
- Vic H104.1 Application of Part
- Vic H104.2 Doorways to a children's room
- Vic H104.3 Window sill height
- Vic H104.4 Children's services - outdoor play space

J ENERGY EFFICIENCY

- Vic JV1 Verification Methods

VIC Part J1 BUILDING FABRIC

- Vic J1.0 Deemed-to-Satisfy Provisions
- Vic J1.1 Application of Part

VIC Part J2 GLAZING

- Vic J2.0 Deemed-to-Satisfy Provisions
- Vic J2.1 Application of Part

VIC Part J3 BUILDING SEALING

- Vic J3.0 Deemed-to-Satisfy Provisions
- Vic J3.1 Application of Part

VIC Part J4 AIR MOVEMENT

- Vic J4.0 Deemed-to-Satisfy Provisions
- Vic J4.1 Application of Part

VIC Part J5 AIR CONDITIONING AND VENTILATION SYSTEMS

Vic J5.0 Deemed-to-Satisfy Provisions

VIC Part J6 ARTIFICIAL LIGHTING AND POWER

Vic J6.0 Deemed-to-Satisfy Provisions

VIC Part J7 HOT WATER SUPPLY

Footnote: Other Legislation Affecting Buildings

SECTION A GENERAL PROVISIONS

PART A1 INTERPRETATION

Vary A1.1 as follows:

Vic A1.1 Definitions

Add the definition of “*children’s service*” as follows:

Children’s service means a service providing care or education for 5 or more children under the age of 6 years in the absence of their parents or guardians—

- (a) for fee or reward; or
- (b) while the parents or guardians of the children use services or facilities provided by the proprietor of the service,

but does not include a service where the children are—

- (a) patients in a hospital which is a registered funded agency under the Health Services Act 1988; or
- (b) students enrolled at a preparatory level or above at—
 - (i) a State school within the meaning of the Education Act 1958; or
 - (ii) a school within the meaning of Section 35 of the Education Act 1958; or
- (c) recipients of protection, care or accommodation being provided by a community service or secure welfare service established under Section 57 of the Children and Young Persons Act 1989 or a community service approved under Section 58 of that Act; or
- (d) clients of a registered service or a residential program within the meaning of the Intellectually Disabled Person’s Services Act 1986; or
- (e) children being cared for or educated in their own home or by a relative of the children.

Substitute the definition of “*early childhood centre*” as follows:

Early childhood centre means a *children’s service*.

Add the definition of “*hotel offering shared accommodation*” as follows:

Hotel offering shared accommodation means a hotel which has any *sole-occupancy units* that can be shared by unrelated persons.

Add the definition of “*residential care building*” as follows:

Residential care building means a building which is a place of residence where 10% or more of persons who reside there need physical assistance in conducting their daily activities and to evacuate the building during an emergency (including any residential care service, State funded residential care service or supported residential service as defined in the Health Services Act 1988 and an *aged care building*) but does not include—

- (a) a hospital; or
- (b) a dwelling in which 2 or more members of the same family and not more than 2 other persons would ordinarily be resident; or
- (c) a place of residence where only one resident needs physical assistance in conducting their daily activities and to evacuate the building during an emergency.

Add the definition of “*restricted children’s service*” as follows:

Restricted children’s service means a *restricted children’s service* as defined in the Children’s Services Regulations 1998.

Add the definition of “*shared accommodation building*” as follows:

Shared accommodation building means a Class 3 building having—

- (a) more than one *sole-occupancy unit* of which any *sole-occupancy unit* has sleeping facilities capable of accommodating 3 or more unrelated persons; or
- (b) sleeping facilities capable of accommodating 13 or more unrelated persons,

that is a boarding-house, chalet, guest house, lodging-house, backpacker accommodation or the like, or a residential part of a *hotel offering shared accommodation* but does not include a *residential care building*, a motel or a residential part of a *school*, *health-care building* or detention centre.

Vary Specification A1.3 Table 1 as follows:

VIC Specification A1.3 STANDARDS ADOPTED BY REFERENCE

Insert in Vic Table 1 of Specification A1.3 the following additional and revised clause references and additional documents:

Vic Table 1 SCHEDULE OF REFERENCED DOCUMENTS

No.	Date	Title	BCA Clause(s)
AS 1926		Swimming pool safety	
Part 1	1993	Fencing for swimming pools Amdt 1, June 2000	Vic G1.1, Vic H104.4
Part 2	1995	Location of fencing for private swimming pools	Vic G1.1
AS 2118		Automatic fire sprinkler systems	
Part 4	1995	Residential	Vic Spec E1.5, Vic H103.1
CAMS—Track operator’s safety guide			
Edition 2	June 1993	Confederation of Australian Motor Sport	Vic H102.3
Supported residential services design guidelines			
Second edition	July 2006	Department of Human Services	Vic H101.4, Vic H101.5
Residential fire safety systems			
Practice Note 2008–07	May 2008	Building Commission	Vic Spec E2.2a, Vic H103.1

Vic Table 1 SCHEDULE OF REFERENCED DOCUMENTS— continued

No.	Date	Title	BCA Clause(s)
Emergency communication systems			
Practice Note 2008–08	May 2008	Building Commission	Vic H103.1

SECTION D ACCESS AND EGRESS

PART D1 PROVISION FOR ESCAPE

Substitute the lead-in to D1.4(d) as follows:

Vic D1.4 Exit travel distances

- (d) **Class 9 buildings** — in a *patient care area* in a Class 9a building and in a *children's service*—

Delete D1.6(f)(iv) as follows:

Vic D1.6 Dimensions of exits and paths of travel to exits

(f)

- (iv) (Deleted)

PART D2 CONSTRUCTION OF EXITS

Add Vic D2.21 (a)(vi) as follows:

Vic D2.21 Operation of latch

- (a)(vi) is an exit door from a *children's service* which does not open to an outdoor space enclosed in accordance with **Vic H104.4**, in which case the device must be located between 1.5 m and 1.65 m above the floor and the door must be *self-closing*.

SECTION E SERVICES AND EQUIPMENT

PART E1 FIRE FIGHTING EQUIPMENT

Delete reference to Class 9c *aged care building* and add references to *shared accommodation buildings* and *residential care buildings* in **Table E1.5** and substitute Note (3) of **Table E1.5** as follows:

VIC Table E1.5 REQUIREMENTS FOR SPRINKLERS

Occupancy	When sprinklers are required
<i>Residential care buildings</i>	In all buildings.
<i>Shared accommodation buildings</i>	In all buildings.
(3) For the purposes of this Table, occupancies of excessive fire hazard comprise buildings which contain-	

VIC Table E1.5 REQUIREMENTS FOR SPRINKLERS— continued

Occupancy	When sprinklers are required
<p>(a) hazardous process risks including the following:</p> <ul style="list-style-type: none"> (i) aircraft hangars. (ii) electrical/electronic manufacturing and assembly (predominantly plastic components). (iii) fire-lighter manufacturing. (iv) fireworks manufacturing. (v) flammable liquid spraying. (vi) foam plastic goods manufacturing and/or processing. (vii) foam rubber goods manufacturing and/or processing. (viii) hydrocarbon based sheet product manufacturing and/or processing. (ix) nitrocellulose and nitrocellulose goods manufacturing. (x) paint and varnish works, solvent based. (xi) plastic goods manufacturing and/or processing works. (xii) resin and turpentine manufacturing. (xiii) vehicle repair shops. <p>(b) <i>combustible</i> goods with an aggregate volume exceeding 2000 m³ and stored to a height greater than 4 m such as the following:</p> <ul style="list-style-type: none"> (i) aerosol packs with flammable contents. (ii) cartons and associated packing material excluding cartons with densely packed non-combustible content. (iii) electrical appliances where the components are predominantly plastic. (iv) foamed rubber or plastics including wrappings or preformed containers. (v) paper products. (vi) plastic, rubber, vinyl and other sheets in the form of offcuts, random pieces or rolls. (vii) textiles raw and finished. (viii) timber products. 	

Substitute Clause 2(b) of Specification E1.5 as follows:

Vic Specification E1.5 FIRE SPRINKLER SYSTEMS

2. Adoption of AS 2118

- (b) for a Class 2 or 3 building or a *residential care building* other than a Class 9c *aged care building*: AS 2118.4 as applicable; or

Substitute Clause 4(e) of Specification E2.2a as follows:

Vic Specification E2.2a SMOKE DETECTION AND ALARM SYSTEMS

4. Smoke detection system

- (e) In a Class 9c *aged care building*—
- (i) if the building accommodates more than 20 residents, manual call points must be installed in paths of travel so that no point on a floor is more than 30 m from a manual call point; and
 - (ii) indication of the zone where the smoke detection system has actuated must be achieved by one of the following:
 - (A)
 - (aa) remote automatic indication of each zone must be given in each smoke compartment; and
 - (bb) indication of (aa) must be indicated on remote annunciator panels with alpha-numeric displays with a minimum of 20 characters of 9 mm minimum height; or
 - (B)
 - (aa) indication of the zone where the smoke detection system has actuated must be communicated via a suitable interface with the fire indicator panel to a portable remote communication device; and
 - (bb) at least one such portable remote communication device per smoke compartment must be provided to staff nominated by the owner or operator and properly instructed as to the duties and responsibilities involved; and
 - (cc) the portable remote communication device may be a pager with alpha-numeric display or portable telephone handset with capability of receiving alpha-numeric display.

Substitute Clause 7(b) and (c) of Specification E2.2a as follows:

7. System monitoring

- (b) A smoke detection system in a Class 9a *health-care building*, if the building accommodates more than 20 patients, unless the building is sprinklered and the sprinkler system is permanently connected to a fire station, or other approved monitoring service with a direct data link to a fire station, in accordance with Practice Note 2008-07.
- (c) (deleted).

SECTION F HEALTH AND AMENITY

PART F2 SANITARY AND OTHER FACILITIES

Substitute application of *Functional Statement* FF2.2 as follows:

FUNCTIONAL STATEMENTS

Application:

FF2.2 only applies to—

- (a) a Class 2 building or a Class 4 part of a building; and
- (b) a Class 9a *health-care building*; and
- (c) a Class 9c *aged care building*; and
- (d) a *children's service* other than a *restricted children's service*.

Substitute application of *Performance Requirement* FP2.2 as follows:

PERFORMANCE REQUIREMENTS

Application:

FP2.2 only applies to—

- (a) a Class 2 building or a Class 4 part of a building; and
- (b) a Class 9a *health-care building*; and
- (c) a Class 9c *aged care building*; and
- (d) a *children's service* other than a *restricted children's service*.

Add Vic FP2.3(d) as follows:

VIC FP2.3

- (d) in a *children's service*, a space for a refrigerated storage facility.

Substitute Vic F2.0 as follows:

DEEMED-TO-SATISFY PROVISIONS

Vic F2.0 Deemed-to-Satisfy Provisions

Performance Requirements FP2.1 to FP2.6 are satisfied by complying with F2.1 to F2.8 and Vic F2.101.

Amend reference to Class 9c *aged care buildings* in Table F2.1 as follows:

Vic Table F2.1 Provision of sanitary facilities in residential buildings

<p>Class 9c (<i>aged care buildings</i>)</p> <p>Facilities for residents—</p> <p>For each building or group of buildings—</p> <ul style="list-style-type: none"> (a) a closet pan and wash basin for each 6 residents or part thereof for whom private facilities are not provided; and (b) a shower for each 7 residents or part thereof for whom private facilities are not provided; and (c) a suitable bath, fixed or mobile on each residential storey, located in a <i>resident use area</i>. <p>Other facilities—</p> <ul style="list-style-type: none"> (a) one kitchen or other adequate facility for the preparation and cooking or reheating of food including a kitchen sink and washbasin; and (b) laundry facilities for the cleansing and drying of linen and clothing or adequate facilities for holding and dispatch or treatment of soiled linen and clothing and the like and the receipt and storage of clean linen; and (c) one clinical hand washing basin for each 16 residents or part thereof. <p>Note: Urinals must not be taken into consideration in calculating the number of facilities.</p>

Substitute F2.3(g) as follows:

Vic F2.3 Facilities in Class 3 to 9 buildings

- (g) A *children's service* must be provided with—
 - (i) one kitchen with facilities for the preparation and cooking of food for children including washing up facilities and a space for refrigerated food storage facilities; and
 - (ii) if the service accommodates children younger than 3 years of age—
 - (A) except in a *restricted children's service*, a laundry facility comprising a washtub and space in the same room for a washing machine; and
 - (B) a bench-type baby bath, with hot and cold water connected, and a nappy change bench in close proximity; and
 - (iii) except in a *restricted children's service*, one bath or shower-bath.

Vary Table F2.3 as follows:

Vic Table F2.3 Sanitary Facilities in Class 3, 5, 6, 7, 8 and 9 Buildings

User Group	Closet Pans		Urinals		Washbasins	
	Design Occupancy	Number	Design Occupancy	Number	Design Occupancy	Number
Class 9b — <i>children's services</i>						
Children	1 — 30	2			1 — 30	2
	> 30	Add 1 per 15			>30	Add 1 per 15
Notes: 1. Closet pans for use by children must be junior toilets, except that those in a <i>restricted children's service</i> may be adult height toilets if they are fitted with a removable seat suitable for children and a wide and stable step in front. 2. Except in a <i>restricted children's service</i> , the closet pans must be located in relation to children's rooms and outdoor play spaces so that children using toilets can be observed by staff from children's rooms and outdoor play space. 3. Washbasins for use by children must have a rim height not exceeding 600 mm, except that those in a <i>restricted children's service</i> may be adult height washbasins if they are provided with a wide and stable step in front.						

Add Vic F2.5(c) as follows:

Vic F2.5 Construction of sanitary compartments

- (c) In a *children's service*, other than a *restricted children's service*, closet pans situated in a group for use by children must be separated from one another by means of partitions extending from between 150 mm to 250 mm above the floor to a height of not less than 900 mm or more than 1.5 m above the floor.

Add Vic F2.101 as follows:

Vic F2.101 First aid rooms

- (a) If an *assembly building*, place of public entertainment (as defined in the Building Act 1993) or an *open spectator stand* accommodates more than 5000 spectators at an arena, sportsground, showground, racecourse, cricket ground, football ground, coursing ground, motor racing arena, or the like, a suitable room or rooms must be provided in accordance with **Table F2.101** for use by para-medical attendants for first aid purposes.

Table F2.101 FIRST AID ROOMS

Spectator Capacity	Number of Rooms
5 001–10 000	1
10 001–15 000	2
15 001–30 000	3
each extra 15 000 or part thereof	1

- (b) **Conditions:** First aid rooms *required* by (a) must—
- (i) be distributed as uniformly as possible throughout the *assembly building* or *open spectator stand*; and
 - (ii) be convenient to a public road; and
 - (iii) be readily accessible from within and outside the arena or ground; and
 - (iv) have a *floor area* of not less than 24 m²; and
 - (v) be provided with a suitable wash basin or sink.

PART F3 ROOM SIZES

Substitute FO3 as follows:

OBJECTIVE

Vic FO3

The *Objective* of this Part is to safeguard occupants from injury or loss of amenity caused by inadequate size of a room or space.

Substitute FF3.1 as follows:

FUNCTIONAL STATEMENT

Vic FF3.1

A building is to be constructed with sufficient size in a room or space suitable for the intended use.

Substitute FP3.1 as follows:

PERFORMANCE REQUIREMENT

Vic FP3.1

A *habitable room* or space must have sufficient size to enable the room or space to fulfil its intended use.

Substitute Vic F3.0 as follows:

DEEMED-TO-SATISFY PROVISIONS

Vic F3.0 Deemed-to-Satisfy Provisions

Performance Requirement Vic FP3.1 is satisfied by complying with **F3.1** and **Vic F3.101** to **Vic F3.103**.

Add Vic F3.101 as follows:

Vic F3.101 Children's services — size of rooms

- (a) A children's room in a *children's service* must have a *floor area* allowing a clear space of at least 3.3 m² for each child using that room.
- (b) When calculating the clear space *required* by (a) any passageway or thoroughfare less than 3 metres wide, kitchen, toilet or shower area, storage area (including cupboards), areas through which doors may swing, cot rooms (including areas where fixed cots will be used or stored) or any other ancillary area must not be included.

Add Vic F3.102 as follows:

Vic F3.102 Class 3 buildings — size of rooms

A *habitable room* in a Class 3 building (other than a *residential aged care building*)—

- (a) must have a *floor area* of at least 7.5 m²; or
- (b) may have a *floor area* less than 7.5 m² provided the room has light and ventilation not less than that *required* for a room having a *floor area* of 7.5 m².

Add Vic F3.103 as follows:

Vic F3.103 Class 3, 9a and 9c residential aged care buildings — size of rooms

In a *residential aged care building*—

- (a) each bedroom must have a *floor area* of not less than 12 m² per occupant; and
- (b) all other common *habitable rooms* (other than kitchens) must have a *floor area* of not less than 7.5 m² with—
 - (i) in a Class 3 hostel or supported residential services building or Class 9c *aged care building* an aggregate *floor area* of not less than 3.5 m² per occupant; or
 - (ii) in a Class 9a nursing home an aggregate *floor area* of not less than 2.5 m² per occupant.

PART F4 LIGHT AND VENTILATION

Delete F4.1(d) and insert Vic F4.1(d) as follows:

Vic F4.1 Provision of natural light

- (d) **Class 9b buildings** — to all general purpose classrooms in primary or secondary *schools* and all playrooms or the like for the use of children in a *children's service* other than a *restricted children's service*.

Substitute F4.2(b) and delete F4.2(c) as follows:

Vic F4.2 Methods and extent of natural lighting

- (b) In a Class 2, 3 or 9 building or Class 4 part of a building a *required window* that faces a boundary of an adjoining allotment or a wall of the same building or another building on the allotment must not be less than a horizontal distance from that boundary or wall that is the greater of—
- (i) generally — 1 m; and
 - (ii) in a *patient care area* or other room used for sleeping purposes in a Class 9a or Class 9c building — 3 m; and
 - (iii) 50% of the square root of the exterior height of the wall in which the *window* is located, measured in metres from its sill.
- (c) (deleted).

SECTION G ANCILLARY PROVISIONS

PART G1 MINOR STRUCTURES AND COMPONENTS

Substitute G1.1(b) as follows:

Vic G1.1 Swimming pools

- (b) **Safety barriers:** A *swimming pool* associated with a Class 2 or 3 building or Class 4 part of a building or a *children's service*, with a depth of water more than 300 mm, must have fencing or other barriers in accordance with AS 1926 Parts 1 and 2.

SECTION H SPECIAL USE BUILDINGS

Add Vic Part H101 as follows:

Vic Part H101 CLASS 3, CLASS 9a AND CLASS 9c RESIDENTIAL AGED CARE BUILDINGS

Application:

This Part only applies to Class 3, Class 9a and Class 9c *residential aged care buildings*.

Note.

Vic Part H101 — Class 3, Class 9a and Class 9c Residential Aged Care Buildings contains additional *Deemed-to-Satisfy Provisions* for Sections D and F for Class 3, Class 9a and Class 9c *residential aged care buildings* as well as additional *Performance Requirements* and associated *Deemed-to-Satisfy Provisions*.

PERFORMANCE REQUIREMENTS

Vic HP101.1

The temperature of water supplied to baths and showers for use by residents must be controlled to avoid the risk of scalding whilst ensuring the stored water temperature does not encourage the growth of Legionella Bacteria.

Vic HP101.2

An electronic communication system must be provided to enable residents and staff to summon assistance in *habitable rooms* (other than kitchens), water closets, shower rooms and bathrooms.

Vic HP101.3

Sufficient general purpose outlets must be provided for electrical appliances in bedrooms in locations that obviate the need for extension leads.

DEEMED-TO-SATISFY PROVISIONS

Vic H101.0 Deemed-to-Satisfy Provisions

Performance Requirements Vic HP101.1 to HP101.3 and relevant *Performance Requirements* in **Sections D** and **F** are satisfied by complying with **Vic H101.1 to Vic H101.7**.

Vic H101.1 Application of Part

The *Deemed-to-Satisfy Provisions* of this Part apply to Class 3, Class 9a and Class 9c *residential aged care buildings*.

Vic H101.2 Doorway width

- (a) The clear width of all bedroom entrance doorways must be not less than 900 mm.
- (b) The clear width of all other doorways must be not less than 800 mm.

Vic H101.3 Windows

- (a) The sill height of *windows* in *habitable rooms* (except kitchens) must be not more than 900 mm above the floor.
- (b) Openable *windows* must be provided with flyscreens.

Vic H101.4 Grab rails and handrails

- (a) Grab rails must be provided in association with every closet fixture, shower or bath in accordance with the Supported Residential Services Design Guidelines.
- (b) Handrails must be provided along both sides of every common passageway or common corridor used by residents and they must be—

- (i) fixed not less than 50 mm clear of the wall; and
- (ii) where practicable, continuous for their full length.

Vic H101.5 Water temperature

The hot water temperature must comply with the minimum design parameters of the Supported Residential Services Design Guidelines.

Vic H101.6 Electronic communications system

A communication system must—

- (a) contain a back-up power supply; and
- (b) have a control that enables the call to be cancelled manually at the point of origin only; and
- (c) incorporate a device at the point of origin that indicates the system has operated; and
- (d) incorporate an indication panel in the manager's office or staff area that clearly identifies the point of origin of a call; and
- (e) have an audible tone that has a continuous signal until deactivated at the point of origin; and
- (f) be operational at all times; and
- (g) have two call points in each en-suite or combined shower/water closet with one call point located in the shower recess and the other on the wall beside the closet pan ahead of the bowl rim; and
- (h) have call points (other than those mentioned in (g)) which are located—
 - (i) within the reach of a resident whilst in bed; and
 - (ii) in all common *habitable rooms*; and
 - (iii) in all bathrooms, *sanitary compartments* and shower rooms where the call point must be of waterproof construction and within reach of any fallen resident.

Vic H101.7 Electrical power outlets

General purpose outlets must be provided as follows:

- (a) In bedrooms with one occupant—two general purpose outlets provided on a minimum of two walls.
- (b) For each additional occupant—two general purpose outlets provided at the head of each additional bed.

Add Vic Part H102 as follows:

Vic Part H102 PLACES OF PUBLIC ENTERTAINMENT

Application:

This Part applies to all places of public entertainment as defined in the Building Act 1993 and prescribed in regulation 1102 of the Building Regulations 2006.

Note.

Vic Part H102 — Places of Public Entertainment contains additional deemed-to-satisfy and *Performance Requirements* for Sections B, D and F for places of public entertainment.

PERFORMANCE REQUIREMENTS

Vic HP102.1

Temporary tiered seating stands and embankments must be designed using engineering principles and constructed to provide for the safety of the patrons and orderly means of evacuation in an emergency.

Vic HP102.2

Every place of public entertainment where motor vehicle racing takes place must be provided with suitable barriers and guard rails to protect the public from injury.

Vic HP102.3

Sufficient sanitary and amenity facilities must be provided at places of public entertainment for use by patrons.

DEEMED-TO-SATISFY PROVISIONS

Vic H102.0 Deemed-to-Satisfy Provisions

Performance Requirements **Vic HP102.1** to **HP102.3** are satisfied by complying with **Vic H102.1** to **Vic H102.4**.

Vic H102.1 Application of Part

The *Deemed-to-Satisfy Provisions* of this Part apply to all places of public entertainment.

Vic H102.2 Temporary tiered seating, concourses and embankments

Temporary tiered seating stands and embankments must be designed and constructed as follows:

- (a) Temporary tiered seating, concourses and embankments must comply with the *Deemed-to-Satisfy Provisions* of **Section B**, **Section D** and **Clause H1.4(a)(ii)**, **(iii)** and **(b)**.
- (b) The maximum slope of tiered seating must not exceed 34 degrees when measured from the horizontal plane.
- (c) Aisles must be evenly spaced throughout the structure and have—
 - (i) a minimum width of 1 m; and

- (ii) the aggregate of aisle widths leading to an *exit* must be not less than the *required* width of that *exit*; and
- (iii) no one aisle may serve more than—
 - (A) 120 patrons where individual seating with backs is provided; or
 - (B) 200 patrons in any other case.
- (d) When applying the balustrading requirements of the *Deemed-to-Satisfy Provisions* of **Section D**, the height of plat balustrading that directly abuts seating (i.e. with no aisle between the seat and the balustrading) must be measured from the plat or seat base whichever is the higher.
- (e) Transverse aisles must be provided at a horizontal distance of not more than 10 m between any row of seats.
- (f) All individual moveable seats must be—
 - (i) fixed in groups of not less than four; and
 - (ii) not used in stepped or ramped seating areas.
- (g) For any spectators' embankment—
 - (i) where the rear slope exceeds 1 in 5, a guard rail must be installed with no openings except at the heads of steps or ramps; and
 - (ii) where the forward or front slope exceeds 1 in 8, the embankment must be stepped with plats not less than 500 mm wide and risers not greater than 230 mm high.
- (h) Guard rails must be installed to protect any fence, balustrade or railing associated with stepped or ramped standing spaces where excess pressure is expected from spectators.

Vic H102.3 Motor vehicle racing

Motor vehicle racing barriers and guard rails must be provided so as to comply with the following:

- (a) CAMS "Track Operators Safety Guide".
- (b) For stock car racing, barriers installed—
 - (i) on the outer amend of the track: a continuous concrete, close boarding or long guard barrier having a height of not less than 900 mm; and
 - (ii) on all curved sections of the track within 3 m of the barrier described in (i): a stout welded or woven wire mesh fence adequately supported having a height of not less than 1.8 m above the adjacent spectators viewing areas; and
 - (iii) between the public viewing area and the fence described in (ii): a suitable crowd barrier that will prevent spectators entering within 1.2 m of that fence.

Vic H102.4 Sanitary and amenity facilities

Sanitary and amenity facilities in places of public entertainment must be provided as follows:

- (a) In places other than buildings:
 - (i) One closet fixture for every 200 female patrons or part thereof.
 - (ii) One closet fixture or urinal for every 200 male patrons or part thereof, at least 30% of which must be in the form of closet fixtures.

- (iii) One washbasin for every 200 patrons or part thereof.
 - (iv) For use by disabled persons, one unisex facility within the meaning of **Part F2** of the BCA for every 100 closet fixtures or part thereof *required* under **(i)** and **(ii)**.
 - (v) One drinking fountain or drinking tap for every washbasin *required* under **(iii)**.
 - (vi) First aid facilities in accordance with **Vic F2.101**.
- (b) In buildings, as *required* to comply with **Part F2**.

Add Vic Part H103 as follows:

Vic Part H103 FIRE SAFETY IN CLASS 2 AND CLASS 3 BUILDINGS

Note:

There are no *Performance Requirements* for Vic Part H103 — Fire Safety in Class 2 and Class 3 Buildings as the Part contains only additional *Deemed-to-Satisfy Provisions* for **Sections C, D** and **E** for Class 2 and Class 3 buildings.

Vic H103.1 Fire safety in Class 2 and Class 3 buildings

- (a) A Class 2 or Class 3 building not more than 25 m in *effective height* that has a sprinkler system complying with **Specification E1.5** installed throughout the building may be constructed in accordance with **(b)** provided that—
- (i) where a sprinkler system complying with AS 2118.4, as applicable, is installed in the building, the system must be permanently connected with a direct data link or other approved monitoring system to a fire station or fire station dispatch centre in accordance with Practice Note 2008-07 if—
 - (A) it has more than 100 sprinkler heads; or
 - (B) in the case of a *residential care building*, the building will accommodate more than 32 residents; and
 - (ii) the sprinkler system is fitted with sprinklers complying with Clause 2.6 of AS 2118.4 in bedrooms; and
 - (iii) an *automatic* smoke detection and alarm system is installed in accordance with **Specification E2.2a**, except that it need not be connected to a fire station and in the case of a *residential care building* must be installed in accordance with—
 - (A) **Specification E2.2a Clause 4**; or
 - (B)
 - (aa) **Specification E2.2a Clause 3** provided **Clause 3 (c)(ii)** is applied as if the building was not protected with a sprinkler system; and
 - (bb) Practice Note 2008-07; and
 - (iv) in a *residential care building*, the *automatic* smoke detection and alarm system and the sprinkler system are connected to an alarm panel constructed in accordance with Practice Note 2008-07; and
 - (v) fire orders are provided in a Class 3 building in accordance with **G4.9**.
- (b) Subject to compliance with **(a)**, the following concessions are permissible:
- (i) **C3.11** — deletion of the requirement for *self-closing* fire doors or solid-core doors (except those opening to fire-isolated *exits*).

- (ii) **Specification C1.1** — deletion of the requirement for *internal walls* to have an FRL subject to compliance with **Clause 2.2 of Specification C1.1**, except that walls bounding *public corridors* must be—
 - (A) clad in *non-combustible* material; and
 - (B) extend to the underside of a *non-combustible* roof covering or to the underside of the ceiling and be designed to minimise smoke spread to the corridor; and
 - (C) not incorporate any penetrations above door head height unless the penetrations are adequately stopped to prevent the free passage of smoke.
- (iii) **D1.3** — deletion of the requirement for stairways that serve not more than 5 *storeys* to be *fire-isolated stairways* provided—
 - (A) the stairway is smoke enclosed with construction that complies with **D2.6** (except **D2.6(a)** and **(b)(i)**); and
 - (B) in a Class 3 building, *storeys* 4 and 5 are served by a minimum of 2 smoke enclosed stairways.
- (iv) **D1.4(a)(i)(A)** — except in a *residential care building*, the maximum distance of travel may be increased from 6 m to 12 m.
- (v) **D1.5(c)(i)** — except in a *residential care building*, the maximum distance between alternative *exits* may be increased from 45 m to 60 m.
- (vi) **E1.3** — deletion of the requirement for internal fire hydrants in buildings that have a *rise in storeys* of not more than 5 provided—
 - (A) an external fire hydrant is installed in accordance with **E1.3** except that in a *residential care building*, the nozzle at the end of the length of hose need only reach the entry door of any *sole-occupancy unit* to be considered as covering the floor area within the *sole-occupancy unit*; or
 - (B) a dry fire main fitted with standard fire hydrant heads is installed in the building provided that—
 - (aa) each fire hydrant head is located in accordance with **E1.3** and fitted with a blank cap or plug; and
 - (bb) the pipework is installed in accordance with **E1.3** (as if it were a fire main suitable for that building) except that it does not need to be connected to a water supply; and
 - (cc) a booster inlet connection is provided in accordance with **E1.3**; and
 - (dd) an external fire hydrant is located within 60 m of the booster connection.
- (vii) **E1.4** — deletion of the requirement for fire hose reels in buildings that have a *rise in storeys* of not more than 5 provided the building is protected by—
 - (A) fire hydrants that comply with **E1.3**; or
 - (B) dry fire mains in accordance with **(vi)(B)**.
- (viii) **E4.9** — deletion of the requirement for a sound system and intercom system for emergency purposes in a *residential care building* provided an intercom system with override public address facility is installed in accordance with Practice Note 2008-08.

Add Vic Part H104 as follows:

Vic Part H104 CLASS 9b CHILDREN'S SERVICES

Application:

This Part only applies to Class 9b *children's services*.

Note:

Vic Part H104 — Class 9b Children's Services contains additional *Performance Requirements* and *Deemed-to-Satisfy Provisions* for **Sections D, F and G** for Class 9b *children's services*.

PERFORMANCE REQUIREMENTS

Vic HP104.1

The number and location of doorways to a children's room must take into account the mobility of children in the event that emergency egress or entry is required.

Vic HP104.2

A children's room must have sufficient windows located to provide a view for children.

Vic HP104.3

The design and height of fencing or other barriers around any outdoor play space (including the design of gates and fittings, and the proximity of the barriers to any permanent structure on the property) must ensure that children cannot go through, over or under the fencing or other barriers.

DEEMED-TO-SATISFY PROVISIONS

Vic H104.0 Deemed-to-Satisfy Provisions

Performance Requirements **Vic HP104.1** to **HP104.3** and relevant *Performance Requirements* in **Sections D** and **F** are satisfied by complying with **Vic H104.1** to **Vic H104.4**.

Vic H104.1 Application of Part

The *Deemed-to-Satisfy Provisions* of this Part apply to Class 9b *children's services*.

Vic H104.2 Doorways to a children's room

A children's room must have a doorway, or in the case of every such room accommodating more than 21 children at least two doorways as widely separated as possible, providing direct access to or from—

- (a) an outdoor play area; or
- (b) a passage leading to the outside; or
- (c) a fire-isolated *exit*.

Vic H104.3 Window sill height

The sills of 50% of *required windows* in children's rooms must be located not more than 1 m above floor level.

Vic H104.4 Children's services—outdoor play space

Any outdoor play space in a *children's service* must be enclosed on all sides with fences or other barriers, at least 1.5 m high measured from ground level and, together with any gates and fittings, except those on doors to the *children's service*, complying with AS 1926 Part 1.

Insert SECTION J ENERGY EFFICIENCY

SECTION J ENERGY EFFICIENCY

Delete JV1(a) and insert Vic JV1(a) as follows:

Vic JV1 Verification using a stated value

- (a)
 - (i) For a Class 2 building, other than its *services*, compliance with **JP1** is verified when it is determined using a thermal calculation method that—
 - (A) each *sole-occupancy unit* has an energy rating of not less than 3 stars; and
 - (B) the average energy rating of all of the *sole-occupancy units* is not less than 5 stars.
 - (ii) For a Class 4 part of a building, other than its *services*, compliance with **JP1** is verified when it is determined using a *thermal calculation method* that the *sole-occupancy unit* has an energy rating of not less than 4 stars.

PART J1 BUILDING FABRIC

Delete J1.0 and insert Vic J1.0 as follows:

Vic J1.0 Deemed-to-Satisfy Provisions

- (a) Where a *Building Solution* is proposed to comply with the *Deemed-to-Satisfy Provisions, Performance Requirement JP1* is satisfied by complying with—
 - (i) **Vic J1.1, J1.2 to J1.6**; and
 - (ii) **Vic J2.1, J2.2 to J2.5**; and

- (iii) **Vic J3.1, J3.2 to J3.7**; and
 - (iv) **Vic J4.1, J4.2 to J4.4**; and
 - (v) **J5.1 to J5.5**; and
 - (vi) **J6.1 to J6.6**.
- (b) Where a *Building Solution* is proposed as an *Alternative Solution* to the *Deemed-to-Satisfy Provisions* of—
- (i) **Vic J1.1, J1.2 to J1.6**; and
 - (ii) **Vic J2.1, J2.2 to J2.5**; and
 - (iii) **Vic J3.1, J3.2 to J3.7**; and
 - (iv) **Vic J4.1, J4.2 to J4.4**; and
 - (v) **J5.1 to J5.5**; and
 - (vi) **J6.1 to J6.6**,
- the relevant *Performance Requirements* must be determined in accordance with **A0.10**.

Delete J1.1 and insert Vic J1.1 as follows:

Vic J1.1 Application of Part

The *Deemed-to-Satisfy Provisions* of this Part apply to building elements forming the *envelope* of a Class 3 to 9 building other than—

- (a) a Class 7, 8 or 9b building that does not have a *conditioned space*; or
- (b) an atrium or solarium that is not a *conditioned space* and is separated from the remainder of the building by an *envelope*.

PART J2 GLAZING

Delete J2.0 and insert Vic J2.0 as follows:

Vic J2.0 Deemed-to-Satisfy Provisions

- (a) Where a *Building Solution* is proposed to comply with the *Deemed-to-Satisfy Provisions*, *Performance Requirement JP1* is satisfied by complying with—
 - (i) **Vic J1.1, J1.2 to J1.6**; and
 - (ii) **Vic J2.1, J2.2 to J2.5**; and
 - (iii) **Vic J3.1, J3.2 to J3.7**; and
 - (iv) **Vic J4.1, J4.2 to J4.4**; and
 - (v) **J5.1 to J5.5**; and
 - (vi) **J6.1 to J6.6**.
- (b) Where a *Building Solution* is proposed as an *Alternative Solution* to the *Deemed-to-Satisfy Provisions* of—
 - (i) **Vic J1.1, J1.2 to J1.6**; and
 - (ii) **Vic J2.1, J2.2 to J2.5**; and
 - (iii) **Vic J3.1, J3.2 to J3.7**; and

(iv) **Vic J4.1, J4.2 to J4.4**; and

(v) **J5.1 to J5.5**; and

(vi) **J6.1 to J6.6**,

the relevant *Performance Requirements* must be determined in accordance with **A0.10**.

Delete J2.1 and insert Vic J2.1 as follows:

Vic J2.1 Application of Part

The *Deemed-to-Satisfy Provisions* of this Part apply to elements forming the *envelope* of a Class 3 to 9 building other than—

- (a) a Class 7, 8 or 9b building that does not have a *conditioned space*; or
- (b) an atrium or solarium that is not a *conditioned space* and is separated from the remainder of the building by an *envelope*.

PART J3 BUILDING SEALING

Delete J3.0 and insert Vic J3.0 as follows:

Vic J3.0 Deemed-to-Satisfy Provisions

- (a) Where a *Building Solution* is proposed to comply with the *Deemed-to-Satisfy Provisions*, *Performance Requirement JP1* is satisfied by complying with—
 - (i) **Vic J1.1, J1.2 to J1.6**; and
 - (ii) **Vic J2.1, J2.2 to J2.5**; and
 - (iii) **Vic J3.1, J3.2 to J3.7**; and
 - (iv) **Vic J4.1, J4.2 to J4.4**; and
 - (v) **J5.1 to J5.5**; and
 - (vi) **J6.1 to J6.6**.
- (b) Where a *Building Solution* is proposed as an *Alternative Solution* to the *Deemed-to-Satisfy Provisions* of—
 - (i) **Vic J1.1, J1.2 to J1.6**; and
 - (ii) **Vic J2.1, J2.2 to J2.5**; and
 - (iii) **Vic J3.1, J3.2 to J3.7**; and
 - (iv) **Vic J4.1, J4.2 to J4.4**; and
 - (v) **J5.1 to J5.5**; and
 - (vi) **J6.1 to J6.6**,

the relevant *Performance Requirements* must be determined in accordance with **A0.10**.

Delete J3.1 and insert Vic J3.1 as follows:

Vic J3.1 Application of Part

The *Deemed-to-Satisfy Provisions* of this Part apply to elements forming the *envelope* of a Class 3 to 9 building, other than—

- (a) a building in *climate zones* 1, 2, 3 and 5 where the only means of *air-conditioning* is by using an evaporative cooler; or
- (b) a permanent building *ventilation opening* needed in a space where a gas appliance is located that is necessary for the safe operation of a gas appliance; or
- (c) a Class 6, 7, 8 and 9b building that does not have a *conditioned space*; or
- (d) a building or space where the mechanical ventilation *required* by Part F4 provides sufficient pressurisation to prevent infiltration; or
- (e) an atrium or solarium that is not a *conditioned space*; and is separated from the remainder of the building by an *envelope*.

PART J4 AIR MOVEMENT

Delete J4.0 and insert Vic J4.0 as follows:

Vic J4.0 Deemed-to-Satisfy Provisions

- (a) Where a *Building Solution* is proposed to comply with the *Deemed-to-Satisfy Provisions, Performance Requirement JP1* is satisfied by complying with—
 - (i) **Vic J1.1, J1.2 to J1.6**; and
 - (ii) **Vic J2.1, J2.2 to J2.5**; and
 - (iii) **Vic J3.1, J3.2 to J3.7**; and
 - (iv) **Vic J4.1, J4.2 to J4.4**; and
 - (v) **J5.1 to J5.5**; and
 - (vi) **J6.1 to J6.6**.
- (b) Where a *Building Solution* is proposed as an *Alternative Solution* to the *Deemed-to-Satisfy Provisions* of—
 - (i) **Vic J1.1, J1.2 to J1.6**; and
 - (ii) **Vic J2.1, J2.2 to J2.5**; and
 - (iii) **Vic J3.1, J3.2 to J3.7**; and
 - (iv) **Vic J4.1, J4.2 to J4.4**; and
 - (v) **J5.1 to J5.5**; and
 - (vi) **J6.1 to J6.6**,
 the relevant *Performance Requirements* must be determined in accordance with **A0.10**.

Delete J4.1 and insert Vic J4.1 as follows:

Vic J4.1 Application of Part

The *Deemed-to-Satisfy Provisions* of this Part apply to a *habitable room* in a *sole-occupancy unit* of a Class 4 part of a building.

PART J5 AIR CONDITIONING AND VENTILATION SYSTEMS

Delete J5.0 and insert Vic J5.0 as follows:

Vic J5.0 Deemed-to-Satisfy Provisions

- (a) Where a *Building Solution* is proposed to comply with the *Deemed-to-Satisfy Provisions*, *Performance Requirement JP1* is satisfied by complying with—
- (i) **Vic J1.1, J1.2 to J1.6**; and
 - (ii) **Vic J2.1, J2.2 to J2.5**; and
 - (iii) **Vic J3.1, J3.2 to J3.7**; and
 - (iv) **Vic J4.1, J4.2 to J4.4**; and
 - (v) **J5.1 to J5.5**; and
 - (vi) **J6.1 to J6.6**.
- (b) Where a *Building Solution* is proposed as an *Alternative Solution* to the *Deemed-to-Satisfy Provisions* of—
- (i) **Vic J1.1, J1.2 to J1.6**; and
 - (ii) **Vic J2.1, J2.2 to J2.5**; and
 - (iii) **Vic J3.1, J3.2 to J3.7**; and
 - (iv) **Vic J4.1, J4.2 to J4.4**; and
 - (v) **J5.1 to J5.5**; and
 - (vi) **J6.1 to J6.6**,
- the relevant *Performance Requirements* must be determined in accordance with **A0.10**.

PART J6 ARTIFICIAL LIGHTING AND POWER

Delete J6.0 and insert Vic J6.0 as follows:

Vic J6.0 Deemed-to-Satisfy Provisions

- (a) Where a *Building Solution* is proposed to comply with the *Deemed-to-Satisfy Provisions*, *Performance Requirement JP1* is satisfied by complying with—
- (i) **Vic J1.1, J1.2 to J1.6**; and
 - (ii) **Vic J2.1, J2.2 to J2.5**; and
 - (iii) **Vic J3.1, J3.2 to J3.7**; and
 - (iv) **Vic J4.1, J4.2 to J4.4**; and
 - (v) **J5.1 to J5.5**; and
 - (vi) **J6.1 to J6.6**.
- (b) Where a *Building Solution* is proposed as an *Alternative Solution* to the *Deemed-to-Satisfy Provisions* of—
- (i) **Vic J1.1, J1.2 to J1.6**; and
 - (ii) **Vic J2.1, J2.2 to J2.5**; and

- (iii) **Vic J3.1, J3.2 to J3.7**; and
- (iv) **Vic J4.1, J4.2 to J4.4**; and
- (v) **J5.1 to J5.5**; and
- (vi) **J6.1 to J6.6**,

the relevant *Performance Requirements* must be determined in accordance with **A0.10**.

Delete Part J7 HOT WATER SUPPLY

Footnote: OTHER LEGISLATION AFFECTING BUILDINGS

In addition to any applicable provisions of the Building Act 1993, Building Regulations 2006 and this Code, there are a number of other legislative technical requirements affecting the design, construction and/or performance of buildings that practitioners may need to be aware of, including, but not necessarily limited to, the following list. Additional legislative instruments such as regulations, codes and standards may exist under the legislation listed.

1. Abattoirs and Knackeries

1.1 Administering Agency

Department of Primary Industries

Relevant Legislation

Meat Industry Act 1993

Meat Industry Regulations 2005

2. Accommodation – Residential (Boarding Houses, Guest Houses, Hostels, Motels)

2.1 Administering Agency

Department of Human Services

Municipal council

Relevant Legislation

Health Act 1958

Health (Prescribed Accommodation) Regulations 2001

3. Accommodation - Supported Residential Services

3.1 Administering Agency

Department of Human Services

Relevant Legislation

Health Services Act 1988

Health Services (Supported Residential Services) Regulations 2001

Supported Residential Service Design Guidelines

4. Alpine Resorts

4.1 Administering Agency

Department of Planning and Community Development

Alpine Resorts Management Boards

Relevant Legislation

Alpine Resorts (Management) Act 1997

5. Asbestos Removal

5.1 Administering Agency

Victorian WorkCover Authority

Environment Protection Authority

Relevant Legislation

Occupational Health and Safety Act 2004

Environment Protection Act 1970

6. Children's Services

6.1 Administering Agency

Department of Education and Early Childhood Development

Relevant Legislation

Children's Services Act 1996

Children's Services Regulations 1998

7. Crematoria, Mausolea, Vaults, etc.

7.1 Administering Agency

Department of Human Services, Cemeteries and Crematoria Program, Public Health Branch (crematoria, mausolea)

Cemetery Trusts (vaults)

Relevant Legislation

Cemeteries and Crematoria Act 2003

Cemeteries and Crematoria Regulations 2005

8. Crown Land

8.1 Administering Agency

Department of Planning and Community Development

Crown Land committees of management

Relevant Legislation

Crown Land (Reserves) Act 1978

9. Dairies

9.1 Administering Agency

Dairy Food Safety Victoria

Relevant Legislation

Dairy Act 2000

10. Dangerous Goods

10.1 Administering Agency

Victorian WorkCover Authority

Relevant Legislation

Dangerous Goods Act 1985

Dangerous Goods (Explosives) Regulations 2000

Dangerous Goods (HCDG) Regulations 2005

Dangerous Goods (Storage and Handling) Regulations 2000

Codes of practice published by the WorkCover Authority

11. Electrical Installations

11.1 Administering Agency

Energy Safe Victoria

Electrical transmission and distribution companies

Relevant Legislation

Electricity Industry Act 2000

Electricity Industry (Residual Provisions) Act 1993

Electricity Safety Act 1998

State Electricity Commission Act 1958

Electricity Safety (Installations) Regulations 1999

Electricity Safety (Network Assets) Regulations 1999

Standards Australia Wiring Rules, AS/NZS 3000/3013

12. Fences - dividing

12.1 Administering Agency

Department of Justice

Relevant Legislation

Fences Act 1968

13. Fire Prevention in Existing Buildings

13.1 Administering Agency

Municipal council

Relevant Legislation

Building Act 1993

Building Regulations 2006

14. Food Premises

14.1 Administering Agency

Department of Human Services

Municipal council

Relevant Legislation

Food Act 1984

15. Gas Installations

15.1 Administering Agency

Energy Safe Victoria

Relevant Legislation

Gas Industry Act 2001

Gas Safety Act 1997

Gas Safety (Gas Installation) Regulations 1999

AS5601 – 2004 Gas Installations

16. Historic Buildings

16.1 Administering Agency

Department of Planning and Community Development

Executive Director under the Heritage Act 1995

Relevant Legislation

Heritage Act 1995

17. Hospitals, Nursing Homes and Health Care Buildings

17.1 Administering Agency

Department of Human Services

Relevant Legislation

Health Act 1958

Mental Health Act 1986

18. Lift Installations

18.1 Administering Agency

Victorian WorkCover Authority

Relevant Legislation

Occupational Health and Safety Act 2004
Occupational Health and Safety Regulations 2007
AS1735 Lifts, escalators and moving walks

19. Moveable Dwellings (in Caravan Parks)**19.1 Administering Agency**

Department of Justice
Municipal council

Relevant Legislation

Residential Tenancies Act 1997
Residential Tenancies (Caravan Parks and Moveable Dwellings
Registration and Standards) Regulations 1999

20. Occupational Health and Safety**20.1 Administering Agency**

Victorian WorkCover Authority

Relevant Legislation

Occupational Health and Safety Act 2004
Occupational Health and Safety Regulations 2007
Codes of practice published by the WorkCover Authority

21. Pharmacies**21.1 Administering Agency**

Department of Human Services
Pharmacy Board of Victoria

Relevant Legislation

Pharmacy Practice Act 2004
Pharmacy Practice Regulations 2005
Guidelines for Good Pharmaceutical Practice 2004

22. Planning Controls**22.1 Administering Agency**

Department of Planning and Community Development
Municipal council

Relevant Legislation

Planning and Environment Act 1987

Planning schemes

23. Prisons and Jails

23.1 Administering Agency

Department of Justice

Corrections Victoria

Relevant Legislation

Corrections Act 1986

24. Radiation Safety

24.1 Administering Agency

Department of Human Services, Radiation Safety Program, Public Health Branch

Relevant Legislation

Radiation Act 2005

Radiation Regulations 2007

25. Schools (Non-Government)

25.1 Administering Agency

Department of Education and Early Childhood Development

Registered Schools Board

Relevant Legislation

Education and Training Reform Act 2006

26. Sanitary Plumbing, Water Supply and Sewerage

26.1 Administering Agency

Plumbing Industry Commission

Relevant Legislation

Building Act 1993

Plumbing Regulations 2008

Plumbing Code of Australia

AS/NZS3500 National Plumbing and Drainage Code

27. Septic Tank Installations

27.1 Administering Agency

Environment Protection Authority

Municipal council

Relevant Legislation

Environment Protection Act 1970

Guidelines For Environmental Management: Code of Practice-Onsite wastewater management

28. Smoking Restrictions

28.1 Administering Agency

Department of Human Services

Municipal council

Relevant Legislation

Tobacco Act 1987

29. Subdivision of Buildings

29.1 Administering Agency

Department of Planning and Community Development

Municipal council

Relevant Legislation

Subdivision Act 1988

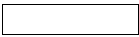

WESTERN AUSTRALIA

Western Australia has no variations or additions to the Building Code of Australia Volume One.

APPENDIX CONTENTS

APPENDIX WESTERN AUSTRALIA

Western Australia

Footnote: Other Legislation Affecting Buildings

Footnote: OTHER LEGISLATION AFFECTING BUILDINGS

In addition to any applicable provisions of the Local Government (Miscellaneous Provisions) Act 1960, Building Regulations 1989 and this Code, there are a number of other legislative technical requirements affecting the design, construction and/or performance of buildings that practitioners may need to be aware of, including, but not necessarily limited to, the following list. Additional legislative instruments such as regulations, codes and standards may exist under the legislation listed.

1. Building

1.1 Administering Agency

Builders Registration Board

Relevant Legislation

Builders Registration Act 1939

2. Caravan Parks and Camping Grounds

2.1 Administering Agency

Department of Local Government and Regional Development

Relevant Legislation

Caravan Park and Camping Grounds Act 1995

Caravan Park and Camping Grounds Regulations 1997

3. Child Care

3.1 Administering Agency

Department for Communities

Relevant Legislation

Child Care Services Act 2007

Child Care Services Regulations 2007

Child Care Services (Child Care) Regulations 2006

Child Care Services (Family Day Care) Regulations 2006

Child Care Services (Outside School Hours Care) Regulations 2006

Child Care Services (Outside School Hours Family Day Care) Regulations 2006

4. Fences

4.1 Administering Agency

Department of Housing and Works

Relevant Legislation

Dividing Fences Act 1961

5. Health

5.1 Administering Agency

Department of Health

Relevant Legislation

Health Act 1911

Health Act (Laundries & Bathrooms) Regulations

Health Act (Swimming Pools) Regulations 1964

Health (Air Handling and Water Systems) Regulations 1994

Health (Asbestos) Regulations 1992

Health (Construction Work) Regulations 1973

Construction Camp Regulations

Health (Public Buildings) Regulations 1992

Health (Treatment of Sewage and Disposal of Effluent and Liquid Waste) Regulations 1974

Health (Rottnest Island) By-laws 1989

Health (Food Hygiene) Regulations 1993

Sewerage (Lighting, Ventilation and Construction) Regulations 1971

Model By-Laws Series 'A' and earlier versions where adopted by Local Government

Health Local Laws where adopted by Local Government

6. Heritage

6.1 Administering Agency

Heritage Council of Western Australia

Relevant Legislation

Heritage of Western Australia Act 1990

7. Hospitals and Health Services

7.1 Administering Agency

Department of Health

Relevant Legislation

Hospitals and Health Services Act 1927

8. Housing

8.1 Administering Agency

Department of Housing and Works

Relevant Legislation

Housing Act 1980

9. Land

9.1 Administering Agency

Western Australian Land Information Authority

Relevant Legislation

Strata Titles Act 1985

10. Occupational Health and Safety

10.1 Administering Agency

Department of Consumer and Employment Protection

Relevant Legislation

Occupational Safety and Health Act 1984

11. Planning Controls

11.1 Administering Agency

Department for Planning and Infrastructure

Relevant Legislation

Planning and Development Act 2005

Planning and Development (Consequential and Transitional Provisions) Act 2005

12. Public Works

12.1 Administering Agency

Department of Housing and Works

Relevant Legislation

Public Works Act 1902

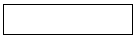

INDEX . ABBREVIATIONS AND SYMBOLS

Index

Abbreviations

Symbols

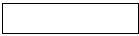

SUPERSEDED

INDEX . ABBREVIATIONS AND SYMBOLS

CONTENTS

INDEX ABBREVIATIONS AND SYMBOLS

Index

Abbreviations and Symbols

INDEX (TO DEEMED-TO-SATISFY PROVISIONS)

A

Access for people with disabilities

D3.0 Deemed-to-Satisfy Provisions

D3.1 Application of Part

D3.2 General building access requirements

D3.3 Parts of buildings to be accessible

D3.4 Concessions

D3.5 Carparking

D3.6 Identification of accessible facilities, services and features

D3.7 Hearing augmentation

D3.8 Tactile indicators

SPEC-D3.6 Specification D3.6 Braille and Tactile Signs

Access for people with disabilities, Braille

D3.6 Identification of accessible facilities, services and features

SPEC-D3.6 Specification D3.6 Braille and Tactile Signs

Access for people with disabilities, carpark

D3.5 Carparking

Access for people with disabilities, hearing augmentation

D3.7 Hearing augmentation

Access for people with disabilities, tactile indicators

D3.8 Tactile indicators

Access for people with disabilities, tactile signs

D3.6 Identification of accessible facilities, services and features

SPEC-D3.6 Specification D3.6 Braille and Tactile Signs

Aged care building

C2.5 Class 9a and 9c buildings

D2.19 Doorways and doors

E3.8 Aged care buildings

SPEC-C2.5 Specification C2.5 Smoke-Proof Walls in Health-Care and Aged Care Buildings

Aged care building, lift

E3.8 Aged care buildings

Aged care building, smoke proof wall

SPEC-C2.5 Specification C2.5 Smoke-Proof Walls in Health-Care and Aged Care Buildings

Air movement, energy efficiency

J4.0 Deemed-to-Satisfy Provisions

J4.2 Air movement

Air-conditioning, energy efficiency

J5.0 Deemed-to-Satisfy Provisions

J5.2 Air-conditioning and ventilation systems

J5.3 Time switch

J5.4 Heating and chilling systems

J5.5 Miscellaneous exhaust systems

Airlock

F4.9 Airlocks

Aisle lights

H1.7 Aisle lights in theatres

Alpine area

G4.0 Deemed-to-Satisfy Provisions

G4.1 Application of Part

G4.3 External doorways

G4.4 Emergency lighting

G4.5 External ramps

G4.6 Discharge of exits

G4.7 External trafficable structures

G4.8 Fire-fighting services and equipment

G4.9 Fire orders

Aluminium construction

B1.4 Determination of structural resistance of materials and forms of construction

Artificial lighting, energy efficiency

J6.0 Deemed-to-Satisfy Provisions

J6.2 Interior artificial lighting

J6.3 Interior artificial lighting and power control

J6.4 Interior decorative and display lighting

J6.5 Artificial lighting around a building

J6.6 Boiling water and chilled water storage units

SPEC-J6 Specification J6 Lighting and Power Control Devices

Atrium

- C1.0** Deemed-to-Satisfy Provisions
- C2.0** Deemed-to-Satisfy Provisions
- C3.0** Deemed-to-Satisfy Provisions
- D1.0** Deemed-to-Satisfy Provisions
- D2.0** Deemed-to-Satisfy Provisions
- D3.0** Deemed-to-Satisfy Provisions
- E2.0** Deemed-to-Satisfy Provisions
- G3.1** Atriums affected by this Part
- SPEC-G3.8** Specification G3.8 Fire and Smoke Control Systems in Buildings Containing Atriums

Atrium construction

- G3.1** Atriums affected by this Part
- G3.2** Dimensions of atrium well
- G3.3** Separation of atrium by bounding walls
- G3.4** Construction of bounding walls
- G3.5** Construction at balconies
- G3.6** Separation at roof
- G3.7** Means of egress
- G3.8** Fire and smoke control systems

Atrium construction, fire and smoke control

- G3.8** Fire and smoke control systems

Atrium, fire and smoke control

- SPEC-G3.8** Specification G3.8 Fire and Smoke Control Systems in Buildings Containing Atriums

Attachments, fire resistance

- SPEC-C1.1-2.4** Specification C1.1 Fire-Resisting Construction

B

Balcony, verandah

- SPEC-C1.1-2.5** Specification C1.1 Fire-Resisting Construction

Balustrade

- D2.16** Balustrades or other barriers

BCA application

- A0.1** Adoption
- A0.10** Relevant Performance Requirements
- A0.2** BCA Volumes
- A0.3** BCA Structure
- A0.4** Compliance with the BCA
- A0.5** Meeting the Performance Requirements
- A0.6** Objectives and Functional Statements
- A0.7** Deemed-to-Satisfy Provisions
- A0.8** Alternative Solutions
- A0.9** Assessment Methods
- A1.2** Adoption of Standards and other references
- A1.3** Referenced Standards, etc
- A1.4** Differences between referenced documents and the BCA
- A1.5** Compliance with all Sections of BCA
- A1.6** Application of the BCA to a particular State or Territory
- A1.7** Language

BCA application, Language

- A1.7** Language

BCA application, Standards

- A1.2** Adoption of Standards and other references
- A1.3** Referenced Standards, etc
- A1.4** Differences between referenced documents and the BCA
- SPEC-A1.3** Specification A1.3 Documents Adopted By Reference

BCA application, State/Territory Appendices

- A1.6** Application of the BCA to a particular State or Territory

Bounding construction

- C3.11** Bounding construction: Class 2, 3 and 4 buildings

Braille

- D3.6** Identification of accessible facilities, services and features
- SPEC-D3.6** Specification D3.6 Braille and Tactile Signs

Building classification

- A3.1** Principles of classification
- A3.2** Classifications
- A3.3** Multiple classification
- A3.4** Parts with more than one classification

Building classification, multiple

[A3.3](#) Multiple classification

[A3.4](#) Parts with more than one classification

Building elements, fire resistance

[SPEC-A2.3](#) Specification A2.3 Fire-Resistance of Building Elements

Building fabric, energy efficiency

[J1.0](#) Deemed-to-Satisfy Provisions

Building occupant warning system

[E2.0](#) Deemed-to-Satisfy Provisions

[SPEC-E2.2a](#) Specification E2.2a Smoke Detection and Alarm Systems

Building sealing, energy efficiency

[J3.0](#) Deemed-to-Satisfy Provisions

[J3.2](#) Chimneys and flues

[J3.3](#) Roof lights

[J3.4](#) External windows and doors

[J3.5](#) Exhaust fans

[J3.6](#) Construction of roofs, walls and floors

Buildings, united

[A4.1](#) When buildings are united

[A4.2](#) Alterations in a united building

Bushfire prone area

[G5.0](#) Deemed-to-Satisfy Provisions

[G5.1](#) Application of Part

[G5.2](#) Protection

C

Carpark

[D3.5](#) Carparking

[F4.11](#) Carparks

[SPEC-C1.1-3.9](#) Specification C1.1 Fire-Resisting Construction

[SPEC-C1.1-4.2](#) Specification C1.1 Fire-Resisting Construction

[SPEC-C1.1-5.2](#) Specification C1.1 Fire-Resisting Construction

Carpark, access for people with disabilities

[D3.5](#) Carparking

Carpark, Class2, 3

[SPEC-C1.1-2.8](#) Specification C1.1 Fire-Resisting Construction

Carpark, Type A construction

SPEC-C1.1-3.9 Specification C1.1 Fire-Resisting Construction

Carpark, Type B construction

SPEC-C1.1-4.2 Specification C1.1 Fire-Resisting Construction

Carpark, Type C construction

SPEC-C1.1-5.2 Specification C1.1 Fire-Resisting Construction

Carpark, ventilation

F4.11 Carparks

Ceiling fan, energy efficiency

J4.4 Ceiling fans and evaporative coolers

Ceilings

A2.5 Resistance to the incipient spread of fire

Ceilings, fire resisting

A2.5 Resistance to the incipient spread of fire

Columns

C3.17 Columns protected with lightweight construction to achieve an FRL

Columns, protected with lightweight construction

C3.17 Columns protected with lightweight construction to achieve an FRL

Composite steel and concrete construction

B1.4 Determination of structural resistance of materials and forms of construction

Concrete construction

B1.4 Determination of structural resistance of materials and forms of construction

Construction joints

C3.16 Construction joints

Construction joints, protection

C3.16 Construction joints

Curtain wall, panel wall

SPEC-C1.1-2.5 Specification C1.1 Fire-Resisting Construction

D

Damp and weatherproofing

- F1.0** Deemed-to-Satisfy Provisions
- F1.1** Stormwater drainage
- F1.10** Damp-proofing of floors on the ground
- F1.11** Provision of floor wastes
- F1.12** Sub-floor ventilation
- F1.13** Glazed assemblies
- F1.5** Roof coverings
- F1.6** Sarking
- F1.7** Water proofing of wet areas in buildings
- F1.9** Damp-proofing

Damp and weatherproofing, floor waste

- F1.11** Provision of floor wastes

Damp and weatherproofing, glazing

- F1.13** Glazed assemblies

Damp and weatherproofing, roof coverings

- F1.5** Roof coverings

Damp and weatherproofing, sarking

- F1.6** Sarking

Damp and weatherproofing, stormwater drainage

- F1.1** Stormwater drainage

Damp and weatherproofing, sub-floor ventilation

- F1.12** Sub-floor ventilation

Damp and weatherproofing, wet areas

- F1.7** Water proofing of wet areas in buildings

Definitions

- A1.1** Definitions

Door, direction of swing

- D2.20** Swinging doors

Door, latch

- D2.21** Operation of latch

Door, sign

- D2.23** Signs on doors

Door, sliding, revolving etc

D2.19 Doorways and doors

Doorway, protection in bounding construction

C3.11 Bounding construction: Class 2, 3 and 4 buildings

Ductwork, energy efficiency

SPEC-J5.2 Specification J5.2 Ductwork Insulation and Sealing

SPEC-J5.2-1 Specification J5.2 Ductwork Insulation and Sealing

SPEC-J5.2-2 Specification J5.2 Ductwork Insulation and Sealing

SPEC-J5.2-3 Specification J5.2 Ductwork Insulation and Sealing

E

Early fire hazard indices

SPEC-A2.4 Specification A2.4 Fire Hazard Properties

SPEC-C1.10 Specification C1.10 Fire Hazard Properties - General

Earthwall construction

B1.4 Determination of structural resistance of materials and forms of construction

Electrical supply equipment

C2.13 Electricity supply system

Emergency (electrical) equipment

C2.13 Electricity supply system

Emergency lift

E3.4 Emergency lifts

Emergency lighting

E4.0 Deemed-to-Satisfy Provisions

E4.2 Emergency lighting requirements

E4.3 Measurement of distance

E4.4 Design and operation of emergency lighting

Emergency warning and intercommunication system

E4.0 Deemed-to-Satisfy Provisions

Energy efficiency

J1.0 Deemed-to-Satisfy Provisions

Energy efficiency, access for maintenance

J8.0 Deemed-to-Satisfy Provisions

J8.2 Access for maintenance

Energy efficiency, air movement

J4.0 Deemed-to-Satisfy Provisions

J4.2 Air movement

Energy efficiency, air-conditioning

J5.0 Deemed-to-Satisfy Provisions

J5.2 Air-conditioning and ventilation systems

J5.3 Time switch

J5.4 Heating and chilling systems

J5.5 Miscellaneous exhaust systems

J6.6 Boiling water and chilled water storage units

Energy efficiency, artificial lighting

J6.0 Deemed-to-Satisfy Provisions

J6.2 Interior artificial lighting

J6.3 Interior artificial lighting and power control

J6.4 Interior decorative and display lighting

J6.5 Artificial lighting around a building

SPEC-J6 Specification J6 Lighting and Power Control Devices

SPEC-J6-1 Specification J6 Lighting and Power Control Devices

SPEC-J6-2 Specification J6 Lighting and Power Control Devices

SPEC-J6-3 Specification J6 Lighting and Power Control Devices

SPEC-J6-4 Specification J6 Lighting and Power Control Devices

SPEC-J6-5 Specification J6 Lighting and Power Control Devices

Energy efficiency, building fabric

J1.0 Deemed-to-Satisfy Provisions

Energy efficiency, building sealing

J3.0 Deemed-to-Satisfy Provisions

Energy efficiency, ceiling fan

J4.4 Ceiling fans and evaporative coolers

Energy efficiency, ductwork

SPEC-J5.2 Specification J5.2 Ductwork Insulation and Sealing

SPEC-J5.2-1 Specification J5.2 Ductwork Insulation and Sealing

SPEC-J5.2-2 Specification J5.2 Ductwork Insulation and Sealing

SPEC-J5.2-3 Specification J5.2 Ductwork Insulation and Sealing

Energy efficiency, evaporative cooler

J3.7 Evaporative coolers

J4.4 Ceiling fans and evaporative coolers

Energy efficiency, floor construction

J1.6 Floors

SPEC-J1.6 Specification J1.6 Floor Construction

SPEC-J1.6-1 Specification J1.6 Floor Construction

SPEC-J1.6-2 Specification J1.6 Floor Construction

Energy efficiency, glazing

J2.0 Deemed-to-Satisfy Provisions

J2.1 Application of Part

J2.2 Applicable glazing provisions

J2.3 Glazing - Method 1

J2.4 Glazing - Method 2

Energy efficiency, hot water supply

J7.0 Deemed-to-Satisfy Provisions

J7.2 Hot water supply

Energy efficiency, maintenance

I2.0 Deemed-to-Satisfy Provisions

I2.1 Application of Part

I2.2 Components of services

Energy efficiency, material

SPEC-J1.2-1 Specification J1.2 Material Properties

SPEC-J1.2-2 Specification J1.2 Material Properties

Energy efficiency, material properties

SPEC-J1.2 Specification J1.2 Material Properties

SPEC-J1.2-1 Specification J1.2 Material Properties

SPEC-J1.2-2 Specification J1.2 Material Properties

Energy efficiency, piping, vessels, heat exchangers and tanks

SPEC-J5.4 Specification J5.4 Insulating of Piping, Vessels, Heat Exchangers and Tanks

SPEC-J5.4-1 Specification J5.4 Insulating of Piping, Vessels, Heat Exchangers and Tanks

SPEC-J5.4-2 Specification J5.4 Insulating of Piping, Vessels, Heat Exchangers and Tanks

Energy efficiency, power control

J5.3 Time switch

J6.0 Deemed-to-Satisfy Provisions

J6.3 Interior artificial lighting and power control

SPEC-J6 Specification J6 Lighting and Power Control Devices

SPEC-J6-1 Specification J6 Lighting and Power Control Devices

SPEC-J6-2 Specification J6 Lighting and Power Control Devices

SPEC-J6-3 Specification J6 Lighting and Power Control Devices

SPEC-J6-4 Specification J6 Lighting and Power Control Devices

SPEC-J6-5 Specification J6 Lighting and Power Control Devices

Energy efficiency, roof and ceiling construction

J1.3 Roof and ceiling construction

SPEC-J1.3 Specification J1.3 Roof and Ceiling Construction

SPEC-J1.3-1 Specification J1.3 Roof and Ceiling Construction

SPEC-J1.3-2 Specification J1.3 Roof and Ceiling Construction

Energy efficiency, roof lights

J1.4 Roof lights

Energy efficiency, sealing of chimneys and flues

J3.2 Chimneys and flues

Energy efficiency, sealing of exhaust fans

J3.5 Exhaust fans

Energy efficiency, sealing of external windows and doors

J3.4 External windows and doors

Energy efficiency, sealing of roof lights

J3.3 Roof lights

Energy efficiency, sealing of roofs, walls and floors

J3.6 Construction of roofs, walls and floors

Energy efficiency, shading

J2.5 Shading

Energy efficiency, thermal construction

J1.2 Thermal construction general

Energy efficiency, ventilation opening

J4.3 Ventilation openings

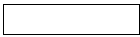

SUPERSEDED
INDEX . ABBREVIATIONS AND SYMBOLS

Energy efficiency, ventilation systems

- J5.0** Deemed-to-Satisfy Provisions
- J5.2** Air-conditioning and ventilation systems
- J5.3** Time switch
- J5.5** Miscellaneous exhaust systems

Energy efficiency, Verification Method

- JV1** Verification Methods JV1 - JV3
- JV3** Verification Methods JV1 - JV3
- SPEC-JV** Specification JV Annual Energy Consumption Calculation

Energy efficiency, wall construction

- J1.5** Walls
- SPEC-J1.5** Specification J1.5 Wall Construction
- SPEC-J1.5-1** Specification J1.5 Wall Construction
- SPEC-J1.5-2** Specification J1.5 Wall Construction

Evaporative cooler, energy efficiency

- J3.7** Evaporative coolers
- J4.4** Ceiling fans and evaporative coolers

Exit

- C3.8** Openings in fire-isolated exits
- C3.9** Service penetrations in fire-isolated exits
- D1.0** Deemed-to-Satisfy Provisions
- D1.1** Application of Part
- D1.10** Discharge from exits
- D1.11** Horizontal exits
- D1.13** Number of persons accommodated
- D1.14** Measurement of distances
- D1.15** Method of measurement
- D1.16** Plant rooms and lift machine rooms: Concession
- D1.2** Number of exits required
- D1.3** When fire-isolated exits are required
- D1.4** Exit travel distances
- D1.5** Distance between alternative exits
- D1.6** Dimensions of exits and paths of travel to exits
- D1.7** Travel via fire-isolated exits
- D1.8** External stairways or ramps in lieu of fire-isolated exits
- D1.9** Travel by non-fire-isolated stairways or ramps
- D2.0** Deemed-to-Satisfy Provisions

Exit, alternative exit

- D1.5** Distance between alternative exits

Exit, construction

- D2.0** Deemed-to-Satisfy Provisions
 - D2.1** Application of Part
 - D2.10** Pedestrian ramps
 - D2.11** Fire-isolated passageways
 - D2.12** Roof as open space
 - D2.13** Goings and risers
 - D2.14** Landings
 - D2.15** Thresholds
 - D2.16** Balustrades or other barriers
 - D2.17** Handrails
 - D2.18** Fixed platforms, walkways, stairways and ladders
 - D2.19** Doorways and doors
 - D2.2** Fire-isolated stairways and ramps
 - D2.20** Swinging doors
 - D2.21** Operation of latch
 - D2.22** Re-entry from fire-isolated exits
 - D2.23** Signs on doors
 - D2.3** Non-fire-isolated stairways and ramps
 - D2.4** Separation of rising and descending stair flights
 - D2.5** Open access ramps and balconies
 - D2.6** Smoke lobbies
 - D2.7** Installations in exits and paths of travel
 - D2.8** Enclosure of space under stairs and ramps
 - D2.9** Width of stairways

Exit, construction, balustrade

- D2.16** Balustrades or other barriers

Exit, construction, door sign

- D2.23** Signs on doors

Exit, construction, door threshold

- D2.15** Thresholds

Exit, construction, doorway and door

- D2.19** Doorways and doors

Exit, construction, enclosure of space

- D2.8** Enclosure of space under stairs and ramps

Exit, construction, fire-isolated passageway

D2.11 Fire-isolated passageways

Exit, construction, fire-isolated stairway and ramp

D2.2 Fire-isolated stairways and ramps

Exit, construction, fixed platforms, walkways, stairways and ladders

D2.18 Fixed platforms, walkways, stairways and ladders

Exit, construction, handrail

D2.17 Handrails

Exit, construction, installations in exits

D2.7 Installations in exits and paths of travel

Exit, construction, installations in path of travel

D2.7 Installations in exits and paths of travel

Exit, construction, landing

D2.14 Landings

Exit, construction, latch

D2.21 Operation of latch

Exit, construction, non-fire-isolated stairway and ramp

D2.3 Non-fire-isolated stairways and ramps

Exit, construction, open access ramp or balcony

D2.5 Open access ramps and balconies

Exit, construction, ramp

D2.10 Pedestrian ramps

Exit, construction, re-entry

D2.22 Re-entry from fire-isolated exits

Exit, construction, rising and descending stair flights

D2.4 Separation of rising and descending stair flights

Exit, construction, smoke lobby

D2.6 Smoke lobbies

Exit, construction, stairway

D2.13 Goings and risers

Exit, construction, swinging door

D2.20 Swinging doors

Exit, construction, use of roof

D2.12 Roof as open space

Exit, construction, width of stairway

D2.9 Width of stairways

Exit, dimensions

D1.6 Dimensions of exits and paths of travel to exits

Exit, discharge

D1.10 Discharge from exits

Exit, external stairs in lieu

D1.8 External stairways or ramps in lieu of fire-isolated exits

Exit, fire-isolated

C3.8 Openings in fire-isolated exits

C3.9 Service penetrations in fire-isolated exits

D1.3 When fire-isolated exits are required

D1.7 Travel via fire-isolated exits

Exit, fire-isolated, protection of openings

C3.8 Openings in fire-isolated exits

Exit, fire-isolated, service penetrations

C3.9 Service penetrations in fire-isolated exits

Exit, horizontal

D1.11 Horizontal exits

Exit, measurement of distance

D1.14 Measurement of distances

Exit, method of measurement of distance

D1.15 Method of measurement

Exit, non-fire-isolated

D1.9 Travel by non-fire-isolated stairways or ramps

Exit, number of persons accommodated

D1.13 Number of persons accommodated

Exit, number required

D1.2 Number of exits required

Exit, plant room lift machine room

D1.16 Plant rooms and lift machine rooms: Concession

Exit, re-entry

D2.22 Re-entry from fire-isolated exits

Exit, sign

- E4.0** Deemed-to-Satisfy Provisions
- E4.5** Exit signs
- E4.6** Direction signs
- E4.7** Class 2 and 3 buildings and Class 4 parts: Exemptions
- E4.8** Design and operation of exit signs

External stairs

- D1.8** External stairways or ramps in lieu of fire-isolated exits

External wall

- C1.11** Performance of external walls in fire
- C3.2** Protection of openings in external walls
- C3.3** Separation of external walls and associated openings in different fire compartments
- SPEC-C1.11** Specification C1.11 Performance of External Walls in Fire

External wall, fire resistance

- C1.11** Performance of external walls in fire

External wall, performance in fire

- SPEC-C1.11** Specification C1.11 Performance of External Walls in Fire

External wall, protection of path of travel

- D1.7** Travel via fire-isolated exits

F

Fire compartmentation

- C2.2** General floor area and volume limitations

Fire compartmentation and separation

- C2.0** Deemed-to-Satisfy Provisions
- C2.1** Application of Part
- C2.5** Class 9a and 9c buildings
- C2.7** Separation by fire walls

Fire compartmentation and separation, aged care building

- C2.5** Class 9a and 9c buildings

Fire compartmentation and separation, fire wall

- C2.7** Separation by fire walls

Fire compartmentation and separation, health-care building

- C2.5** Class 9a and 9c buildings

Fire control centre

E1.8 Fire control centres

SPEC-E1.8 Specification E1.8 Fire Control Centres

Fire door

C3.6 Sliding fire doors

Fire door, construction

SPEC-C3.4 Specification C3.4 Fire Doors, Smoke Doors, Fire Windows and Shutters

Fire door, sliding

C3.6 Sliding fire doors

Fire extinguisher

E1.6 Portable fire extinguishers

Fire fighting equipment

E1.0 Deemed-to-Satisfy Provisions

E1.10 Provision for special hazards

E1.3 Fire hydrants

E1.4 Fire hose reels

E1.5 Sprinklers

E1.6 Portable fire extinguishers

E1.8 Fire control centres

E1.9 Fire precautions during construction

Fire fighting equipment, fire control centre

E1.8 Fire control centres

Fire fighting equipment, fire extinguisher

E1.6 Portable fire extinguishers

Fire fighting equipment, fire hose reel

E1.4 Fire hose reels

Fire fighting equipment, fire hydrant

E1.3 Fire hydrants

Fire fighting equipment, fire precautions during construction

E1.9 Fire precautions during construction

Fire fighting equipment, fire sprinkler system

E1.5 Sprinklers

Fire fighting equipment, provisions for special hazards

E1.10 Provision for special hazards

Fire hazard properties

A2.4 Fire hazard properties

C1.10 Fire hazard properties

SPEC-A2.4 Specification A2.4 Fire Hazard Properties

SPEC-C1.10 Specification C1.10 Fire Hazard Properties - General

SPEC-C1.10a Specification C1.10a Fire Hazard Properties - Floors, Walls and Ceilings

Fire hose reel

E1.4 Fire hose reels

Fire hydrant

E1.3 Fire hydrants

Fire precautions during construction

E1.9 Fire precautions during construction

Fire resistance

A2.3 Fire-resistance of building elements

C1.0 Deemed-to-Satisfy Provisions

C1.1 Type of construction required

C1.11 Performance of external walls in fire

C1.2 Calculation of rise in storeys

C1.3 Buildings of multiple classification

C1.4 Mixed types of construction

C1.5 Two storey Class 2, 3 or 9c buildings

C1.6 Class 4 parts of buildings

C1.7 Open spectator stands and indoor sports stadiums

C1.8 Lightweight construction

SPEC-A2.3 Specification A2.3 Fire-Resistance of Building Elements

Fire resistance, external wall

C1.11 Performance of external walls in fire

Fire resistance, lightweight construction

C1.8 Lightweight construction

Fire resistance, type of construction

C1.1 Type of construction required

C1.5 Two storey Class 2, 3 or 9c buildings

C1.6 Class 4 parts of buildings

C1.7 Open spectator stands and indoor sports stadiums

Fire separation

- C2.10** Separation of lift shafts
- C2.11** Stairways and lifts in one shaft
- C2.12** Separation of equipment
- C2.13** Electricity supply system
- C2.6** Vertical separation of openings in external walls
- C2.8** Separation of classifications in the same storey
- C2.9** Separation of classifications in different storeys

Fire separation, electrical supply equipment

- C2.13** Electricity supply system

Fire separation, equipment

- C2.12** Separation of equipment

Fire separation, lift and stairway shaft

- C2.11** Stairways and lifts in one shaft

Fire separation, lift shaft

- C2.10** Separation of lift shafts

Fire separation, multiple classification in different storeys

- C2.9** Separation of classifications in different storeys

Fire separation, multiple classification in same storey

- C2.8** Separation of classifications in the same storey

Fire separation, openings in external wall

- C2.6** Vertical separation of openings in external walls

Fire shutter, construction

- SPEC-C3.4** Specification C3.4 Fire Doors, Smoke Doors, Fire Windows and Shutters

Fire sprinkler system

- E1.5** Sprinklers
- SPEC-E1.5** Specification E1.5 Fire Sprinkler Systems

Fire stopping, service penetrations

- SPEC-C3.15** Specification C3.15 Penetration of Walls, Floors and Ceilings by Services

Fire wall

- C2.7** Separation by fire walls
- C3.5** Doorways in fire walls
- C3.6** Sliding fire doors

Fire wall, protection of doorway

- C3.5** Doorways in fire walls

Fire window, construction

SPEC-C3.4 Specification C3.4 Fire Doors, Smoke Doors, Fire Windows and Shutters

Fire-isolated passageway, construction

D2.11 Fire-isolated passageways

Fire-resisting construction

SPEC-C1.1 Specification C1.1 Fire-Resisting Construction

Fire-resisting construction, attachments

SPEC-C1.1-2.4 Specification C1.1 Fire-Resisting Construction

Fire-resisting construction, carpark

SPEC-C1.1-2.8 Specification C1.1 Fire-Resisting Construction

Fire-resisting construction, concessions

SPEC-C1.1-2.5 Specification C1.1 Fire-Resisting Construction

Fire-resisting construction, fire-source feature

SPEC-C1.1-2.1 Specification C1.1 Fire-Resisting Construction

Fire-resisting construction, lintel

SPEC-C1.1-2.3 Specification C1.1 Fire-Resisting Construction

Fire-resisting construction, mezzanine floor

SPEC-C1.1-2.6 Specification C1.1 Fire-Resisting Construction

Fire-resisting construction, residential aged care building

SPEC-C1.1-2.9 Specification C1.1 Fire-Resisting Construction

Fire-resisting construction, shaft

SPEC-C1.1-2.7 Specification C1.1 Fire-Resisting Construction

Fire-resisting construction, support of another part

SPEC-C1.1-2.2 Specification C1.1 Fire-Resisting Construction

Fire-resisting construction, Type A

SPEC-C1.1-3 Specification C1.1 Fire-Resisting Construction

Fire-resisting construction, Type B

SPEC-C1.1-4 Specification C1.1 Fire-Resisting Construction

Fire-resisting construction, Type C

SPEC-C1.1-5 Specification C1.1 Fire-Resisting Construction

Fire-retardant coating

C1.10 Fire hazard properties

Fire-source feature

SPEC-C1.1-2.1 Specification C1.1 Fire-Resisting Construction

Fireplace

G2.0 Deemed-to-Satisfy Provisions

G2.3 Open fireplaces

Floor area and volume limitations

C2.2 General floor area and volume limitations

C2.3 Large Isolated Buildings

Floor area and volume limitations, type of construction

C2.2 General floor area and volume limitations

C2.3 Large Isolated Buildings

Floor construction, energy

SPEC-J1.6-1 Specification J1.6 Floor Construction

SPEC-J1.6-2 Specification J1.6 Floor Construction

Floor construction, energy efficiency

J1.6 Floors

SPEC-J1.6 Specification J1.6 Floor Construction

Floor waste

F1.11 Provision of floor wastes

Flooring, particle board

B1.4 Determination of structural resistance of materials and forms of construction

G

Glazing

B1.4 Determination of structural resistance of materials and forms of construction

F1.13 Glazed assemblies

Glazing, energy efficiency

J2.0 Deemed-to-Satisfy Provisions

J2.1 Application of Part

J2.2 Applicable glazing provisions

J2.3 Glazing - Method 1

J2.4 Glazing - Method 2

Going and risers, stairway

D2.13 Goings and risers

H

Handrail

D2.17 Handrails

Health-care building

C2.5 Class 9a and 9c buildings

SPEC-C2.5 Specification C2.5 Smoke-Proof Walls in Health-Care and Aged Care Buildings

Health-care building, smoke-proof wall

SPEC-C2.5 Specification C2.5 Smoke-Proof Walls in Health-Care and Aged Care Buildings

Hearing augmentation

D3.7 Hearing augmentation

Heating appliance

G2.0 Deemed-to-Satisfy Provisions

G2.2 Installation of appliances

Heating appliance, fireplace

G2.3 Open fireplaces

Heating appliance, incinerator

G2.4 Incinerator rooms

Horizontal exit

C3.7 Protection of doorways in horizontal exits

D1.11 Horizontal exits

Horizontal exit, protection

C3.7 Protection of doorways in horizontal exits

Hot water supply, energy efficiency

J7.0 Deemed-to-Satisfy Provisions

J7.2 Hot water supply

I

Impact sound

SPEC-F5.5 Specification F5.5 Impact Sound - Test of Equivalence

Incinerator

G2.0 Deemed-to-Satisfy Provisions

G2.4 Incinerator rooms

K

Kitchen exhaust

F4.12 Kitchen local exhaust ventilation

L

Landing, construction

[D2.14](#) Landings

Language

[A1.7](#) Language

Large isolated buildings

[C2.3](#) Large Isolated Buildings

[C2.4](#) Requirements for open spaces and vehicular access

Legionella control

[F2.7](#) Microbial (legionella) control

Lift

[C3.10](#) Openings in fire-isolated lift shafts

[E3.0](#) Deemed-to-Satisfy Provisions

[E3.2](#) Stretcher facility in lifts

[E3.3](#) Warning against use of lifts in fire

[E3.4](#) Emergency lifts

[E3.5](#) Landings

[E3.6](#) Facilities for people with disabilities

[E3.7](#) Fire service controls

[E3.8](#) Aged care buildings

Lift and stairway shaft

[C2.11](#) Stairways and lifts in one shaft

Lift cars

[SPEC-C1.10a](#) Specification C1.10a Fire Hazard Properties - Floors, Walls and Ceilings

Lift shaft

[B1.4](#) Determination of structural resistance of materials and forms of construction

[C2.10](#) Separation of lift shafts

Lift, aged care building

[E3.8](#) Aged care buildings

Lift, emergency

[E3.4](#) Emergency lifts

Lift, fire service control

[E3.7](#) Fire service controls

Lift, landing

[E3.5](#) Landings

Lift, openings in fire-isolated shaft

C3.10 Openings in fire-isolated lift shafts

Lift, people with disabilities

E3.6 Facilities for people with disabilities

Lift, stretcher facility

E3.2 Stretcher facility in lifts

Lift, warning

E3.3 Warning against use of lifts in fire

Light

F4.0 Deemed-to-Satisfy Provisions

Light, artificial

F4.4 Artificial lighting

Light, natural

F4.1 Provision of natural light

F4.2 Methods and extent of natural lighting

F4.3 Natural light borrowed from adjoining room

Lightweight construction

C1.8 Lightweight construction

C3.17 Columns protected with lightweight construction to achieve an FRL

SPEC-C1.8 Specification C1.8 Structural Tests for Lightweight Construction

Lightweight construction, protection of columns

C3.17 Columns protected with lightweight construction to achieve an FRL

Lightweight construction, structural tests

SPEC-C1.8 Specification C1.8 Structural Tests for Lightweight Construction

Lintel

SPEC-C1.1-2.3 Specification C1.1 Fire-Resisting Construction

M

Maintenance

I1.0 Deemed-to-Satisfy Provisions

I1.1 Safety measures

I1.2 Mechanical ventilation and hot water, warm water and cooling water systems

I2.0 Deemed-to-Satisfy Provisions

I2.1 Application of Part

I2.2 Components of services

Masonry construction

B1.4 Determination of structural resistance of materials and forms of construction

Materials

A2.1 Suitability of materials

A2.2 Evidence of suitability

A2.3 Fire-resistance of building elements

A2.4 Fire hazard properties

C1.10 Fire hazard properties

C1.12 Non-combustible materials

SPEC-A2.3 Specification A2.3 Fire-Resistance of Building Elements

SPEC-A2.4 Specification A2.4 Fire Hazard Properties

SPEC-C1.10 Specification C1.10 Fire Hazard Properties - General

SPEC-C1.10a Specification C1.10a Fire Hazard Properties - Floors, Walls and Ceilings

Materials, fire hazard properties

A2.4 Fire hazard properties

C1.10 Fire hazard properties

SPEC-A2.4 Specification A2.4 Fire Hazard Properties

SPEC-C1.10 Specification C1.10 Fire Hazard Properties - General

Materials, fire resistance

A2.3 Fire-resistance of building elements

SPEC-A2.3 Specification A2.3 Fire-Resistance of Building Elements

Materials, non-combustible

C1.12 Non-combustible materials

Materials, suitability

A2.1 Suitability of materials

A2.2 Evidence of suitability

Mezzanine

C1.2 Calculation of rise in storeys

Mezzanine floor

SPEC-C1.1-2.6 Specification C1.1 Fire-Resisting Construction

Minor structure

G1.0 Deemed-to-Satisfy Provisions

G1.1 Swimming pools

G1.2 Refrigerated chambers, strong-rooms and vaults

Minor structure, refrigerated chamber, strong room, vault

G1.2 Refrigerated chambers, strong-rooms and vaults

Minor structure, swimming pool

G1.1 Swimming pools

Multiple classification

A3.3 Multiple classification

A3.4 Parts with more than one classification

C1.3 Buildings of multiple classification

Multiple classification in different storeys

C2.9 Separation of classifications in different storeys

Multiple classification in same storey

C2.8 Separation of classifications in the same storey

N

Non required, stairway, ramp, escalator

D1.12 Non-required stairways, ramps or escalators

Non-combustible materials

C1.12 Non-combustible materials

Number of persons accommodated

D1.13 Number of persons accommodated

O

Open space

C2.4 Requirements for open spaces and vehicular access

Open spectator stand, indoor sports stadium

C1.7 Open spectator stands and indoor sports stadiums

SPEC-C1.1-3.8 Specification C1.1 Fire-Resisting Construction

Openings in external wall

C2.6 Vertical separation of openings in external walls

Openings, method of protection

C3.4 Acceptable methods of protection

Openings, protection, service penetrations in floors and ceilings

C3.0 Deemed-to-Satisfy Provisions

C3.1 Application of Part

C3.10 Openings in fire-isolated lift shafts

C3.12 Openings in floors and ceilings for services

C3.13 Openings in shafts

C3.15 Openings for service installations

C3.16 Construction joints

C3.2 Protection of openings in external walls

C3.3 Separation of external walls and associated openings in different fire compartments

C3.4 Acceptable methods of protection

C3.5 Doorways in fire walls

C3.6 Sliding fire doors

C3.7 Protection of doorways in horizontal exits

C3.8 Openings in fire-isolated exits

C3.9 Service penetrations in fire-isolated exits

Openings, protection, atrium

C3.0 Deemed-to-Satisfy Provisions

Openings, protection, construction joints

C3.16 Construction joints

Openings, protection, doorway in fire wall

C3.5 Doorways in fire walls

C3.6 Sliding fire doors

Openings, protection, doorway in horizontal exit

C3.7 Protection of doorways in horizontal exits

Openings, protection, external wall

C3.2 Protection of openings in external walls

C3.3 Separation of external walls and associated openings in different fire compartments

Openings, protection, fire-isolated exit

C3.8 Openings in fire-isolated exits

Openings, protection, in fire-isolated lift shaft

C3.10 Openings in fire-isolated lift shafts

Openings, protection, openings in shaft

C3.13 Openings in shafts

Openings, protection, service penetrations

C3.15 Openings for service installations

Openings, protection, service penetrations in fire-isolated exit

C3.9 Service penetrations in fire-isolated exits

Openings, protection, service penetrations in floors and

C3.12 Openings in floors and ceilings for services

Openings, protection, theatre, stage and public hall

C3.0 Deemed-to-Satisfy Provisions

P

Path of travel

D1.6 Dimensions of exits and paths of travel to exits

D2.7 Installations in exits and paths of travel

Path of travel, dimensions

D1.6 Dimensions of exits and paths of travel to exits

Path of travel, installations within

D2.7 Installations in exits and paths of travel

Path of travel, protection of external wall

D1.7 Travel via fire-isolated exits

People with disabilities, lift

E3.6 Facilities for people with disabilities

People with disabilities, sanitary facilities

F2.2 Calculation of number of occupants and fixtures

F2.4 Facilities for people with disabilities

Piling

B1.4 Determination of structural resistance of materials and forms of construction

Piping, vessels, heat exchangers and tanks, energy

SPEC-J5.4 Specification J5.4 Insulating of Piping, Vessels, Heat Exchangers and Tanks

SPEC-J5.4-1 Specification J5.4 Insulating of Piping, Vessels, Heat Exchangers and Tanks

SPEC-J5.4-2 Specification J5.4 Insulating of Piping, Vessels, Heat Exchangers and Tanks

Power control, energy efficiency

J5.3 Time switch

J6.0 Deemed-to-Satisfy Provisions

J6.3 Interior artificial lighting and power control

SPEC-J6 Specification J6 Lighting and Power Control Devices

Primary production

B1.4 Determination of structural resistance of materials and forms of construction

Proscenium wall

H1.3 Proscenium wall construction

SPEC-H1.3 Specification H1.3 Construction of Theatres with Proscenium Walls

Public corridor

C2.14 Public corridors in Class 2 and 3 buildings

Pumps

F5.7 Sound isolation of pumps

R

Ramp

D2.10 Pedestrian ramps

D2.8 Enclosure of space under stairs and ramps

Refrigerated chamber, strong room, vault

G1.2 Refrigerated chambers, strong-rooms and vaults

Residential aged care building

SPEC-C1.1-2.9 Specification C1.1 Fire-Resisting Construction

Resistance to the incipient spread of fire

A2.5 Resistance to the incipient spread of fire

Rise in storeys

C1.2 Calculation of rise in storeys

Roof and ceiling construction, energy

SPEC-J1.3-1 Specification J1.3 Roof and Ceiling Construction

SPEC-J1.3-2 Specification J1.3 Roof and Ceiling Construction

Roof and ceiling construction, energy efficiency

J1.3 Roof and ceiling construction

SPEC-J1.3 Specification J1.3 Roof and Ceiling Construction

Roof construction

B1.4 Determination of structural resistance of materials and forms of construction

Roof coverings

F1.5 Roof coverings

Roof lights, energy efficiency

J1.4 Roof lights

Rooflight

SPEC-C1.1-3.6 Specification C1.1 Fire-Resisting Construction

Room size

F3.0 Deemed-to-Satisfy Provisions

F3.1 Height of rooms and other spaces

S

Sanitary and other facilities

F2.0 Deemed-to-Satisfy Provisions

F2.1 Facilities in residential buildings

F2.2 Calculation of number of occupants and fixtures

F2.3 Facilities in Class 3 to 9 buildings

F2.4 Facilities for people with disabilities

F2.5 Construction of sanitary compartments

F2.6 Interpretation: Urinals and washbasins

F2.7 Microbial (legionella) control

F2.8 Waste management

Sanitary and other facilities, construction of sanitary compartment

F2.5 Construction of sanitary compartments

Sanitary and other facilities, legionella control

F2.7 Microbial (legionella) control

Sanitary and other facilities, urinals and washbasins

F2.6 Interpretation: Urinals and washbasins

Sanitary and other facilities, waste management

F2.8 Waste management

Sarking

F1.6 Sarking

Service penetrations

C3.12 Openings in floors and ceilings for services

C3.15 Openings for service installations

C3.9 Service penetrations in fire-isolated exits

Service penetrations, fire-isolated exits

C3.9 Service penetrations in fire-isolated exits

Service penetrations, protection of openings

C3.12 Openings in floors and ceilings for services

C3.15 Openings for service installations

SPEC-C3.15 Specification C3.15 Penetration of Walls, Floors and Ceilings by Services

Shading, energy efficiency

J2.5 Shading

Shaft

C3.13 Openings in shafts

SPEC-C1.1-2.7 Specification C1.1 Fire-Resisting Construction

Shaft, enclosure

SPEC-C1.1-2.7 Specification C1.1 Fire-Resisting Construction

Shaft, protection of openings

C3.13 Openings in shafts

Smoke alarm system

SPEC-E2.2a Specification E2.2a Smoke Detection and Alarm Systems

Smoke and heat vents

SPEC-E2.2c Specification E2.2c Smoke-and-Heat Vents

Smoke detection and alarm system

E2.0 Deemed-to-Satisfy Provisions

SPEC-E2.2a Specification E2.2a Smoke Detection and Alarm Systems

Smoke door, construction

SPEC-C3.4 Specification C3.4 Fire Doors, Smoke Doors, Fire Windows and Shutters

Smoke exhaust system

SPEC-E2.2b Specification E2.2b Smoke Exhaust Systems

Smoke hazard management

E2.0 Deemed-to-Satisfy Provisions

E2.1 Application of Part

E2.2 General requirements

E2.3 Provision for special hazards

Smoke hazard management system

SPEC-E2.2b Specification E2.2b Smoke Exhaust Systems

SPEC-E2.2c Specification E2.2c Smoke-and-Heat Vents

Smoke hazard management system, smoke and heat vents

SPEC-E2.2c Specification E2.2c Smoke-and-Heat Vents

Smoke hazard management system, smoke exhaust system

SPEC-E2.2b Specification E2.2b Smoke Exhaust Systems

Smoke hazard management, special hazards

E2.3 Provision for special hazards

Smoke lobby

D2.6 Smoke lobbies

Smoke separation

C2.14 Public corridors in Class 2 and 3 buildings

Smoke separation, public corridor

C2.14 Public corridors in Class 2 and 3 buildings

Smoke-proof wall

SPEC-C2.5 Specification C2.5 Smoke-Proof Walls in Health-Care and Aged Care Buildings

Soil and waste pipes

F5.6 Sound insulation rating of services

Sound system and intercom system for emergency purposes

E4.9 Emergency warning and intercommunication system

Sound transmission and insulation

F5.0 Deemed-to-Satisfy Provisions

F5.1 Application of Part

F5.2 Determination of airborne sound insulation ratings

F5.3 Determination of impact sound insulation ratings

F5.4 Sound insulation rating of floors

F5.5 Sound insulation rating of walls

F5.6 Sound insulation rating of services

F5.7 Sound isolation of pumps

SPEC-F5.2 Specification F5.2 Sound Insulation for Building Elements

SPEC-F5.5 Specification F5.5 Impact Sound - Test of Equivalence

Sound transmission and insulation, impact sound

SPEC-F5.5 Specification F5.5 Impact Sound - Test of Equivalence

Sound transmission and insulation, pumps

F5.7 Sound isolation of pumps

Sound transmission and insulation, soil and waste pipes

F5.6 Sound insulation rating of services

Sound transmission and insulation, sound insulation for building elements

SPEC-F5.2 Specification F5.2 Sound Insulation for Building Elements

Special hazards

E1.10 Provision for special hazards

E2.3 Provision for special hazards

Special hazards, smoke hazard management

E2.3 Provision for special hazards

Stairway, construction

D2.13 Goings and risers

D2.14 Landings

D2.8 Enclosure of space under stairs and ramps

D2.9 Width of stairways

Stairway, construction, landing

D2.14 Landings

Stairway, construction, width

D2.9 Width of stairways

Stairway, goings and risers

D2.13 Goings and risers

Stairway, ramp, escalator

D1.12 Non-required stairways, ramps or escalators

SPEC-D1.12 Specification D1.12 Non-Required Stairways, Ramps and Escalators

Stairway, ramp, escalator, non-required

SPEC-D1.12 Specification D1.12 Non-Required Stairways, Ramps and Escalators

Stairway, rising and descending stair flights

D2.4 Separation of rising and descending stair flights

Standards

A1.2 Adoption of Standards and other references

A1.3 Referenced Standards, etc

A1.4 Differences between referenced documents and the BCA

SPEC-A1.3 Specification A1.3 Documents Adopted By Reference

State/Territory Appendices

A1.6 Application of the BCA to a particular State or Territory

Steel column

SPEC-C1.1-2.5 Specification C1.1 Fire-Resisting Construction

Steel construction

B1.4 Determination of structural resistance of materials and forms of construction

Stormwater drainage

F1.1 Stormwater drainage

Structural

B1.0 Deemed-to-Satisfy Provisions

B1.1 Resistance to actions

B1.2 Determination of individual actions

B1.3 Loads

B1.4 Determination of structural resistance of materials and forms of construction

Structures on roof

SPEC-C1.1-2.5 Specification C1.1 Fire-Resisting Construction

Sub-floor ventilation

F1.12 Sub-floor ventilation

Suitability of materials

A2.1 Suitability of materials

A2.2 Evidence of suitability

Support of another part

SPEC-C1.1-2.2 Specification C1.1 Fire-Resisting Construction

Swimming pool

G1.1 Swimming pools

T

Tactile indicators

D3.8 Tactile indicators

Tactile signs

D3.6 Identification of accessible facilities, services and features

SPEC-D3.6 Specification D3.6 Braille and Tactile Signs

Tanks

SPEC-J5.4-1 Specification J5.4 Insulating of Piping, Vessels, Heat Exchangers and Tanks

SPEC-J5.4-2 Specification J5.4 Insulating of Piping, Vessels, Heat Exchangers and Tanks

Termites

B1.4 Determination of structural resistance of materials and forms of construction

Theatre, stage and public hall

- C1.0** Deemed-to-Satisfy Provisions
- C2.0** Deemed-to-Satisfy Provisions
- C3.0** Deemed-to-Satisfy Provisions
- D1.0** Deemed-to-Satisfy Provisions
- D2.0** Deemed-to-Satisfy Provisions
- D3.0** Deemed-to-Satisfy Provisions
- H1.1** Application of Part
- H1.2** Separation
- H1.3** Proscenium wall construction
- H1.4** Seating area
- H1.5** Exits from theatre stages
- H1.6** Access to platforms and lofts
- H1.7** Aisle lights in theatres
- SPEC-H1.3** Specification H1.3 Construction of Theatres with Proscenium Walls

Theatre, stage and public hall, proscenium wall

- SPEC-H1.3** Specification H1.3 Construction of Theatres with Proscenium Walls

Thermal construction

- J1.2** Thermal construction general

Threshold, doorway

- D2.15** Thresholds

Tilt-up construction

- SPEC-C1.11** Specification C1.11 Performance of External Walls in Fire

Timber column

- SPEC-C1.1-2.5** Specification C1.1 Fire-Resisting Construction

Timber construction

- B1.4** Determination of structural resistance of materials and forms of construction

Type A construction

- SPEC-C1.1-3** Specification C1.1 Fire-Resisting Construction

Type A construction, carpark

- SPEC-C1.1-3.9** Specification C1.1 Fire-Resisting Construction

Type A construction, open spectator stand, indoor sports stadium

- SPEC-C1.1-3.8** Specification C1.1 Fire-Resisting Construction

Type A construction, rooflight

- SPEC-C1.1-3.6** Specification C1.1 Fire-Resisting Construction

Type B construction

SPEC-C1.1-4 Specification C1.1 Fire-Resisting Construction

Type B construction, carpark

SPEC-C1.1-4.2 Specification C1.1 Fire-Resisting Construction

Type C construction

SPEC-C1.1-5 Specification C1.1 Fire-Resisting Construction

Type C construction, carpark

SPEC-C1.1-5.2 Specification C1.1 Fire-Resisting Construction

Type of construction

C1.1 Type of construction required

C1.2 Calculation of rise in storeys

C1.3 Buildings of multiple classification

C1.4 Mixed types of construction

C1.5 Two storey Class 2, 3 or 9c buildings

C1.6 Class 4 parts of buildings

C1.7 Open spectator stands and indoor sports stadiums

C2.2 General floor area and volume limitations

C2.3 Large Isolated Buildings

Type of construction, mixed

C1.4 Mixed types of construction

Type of construction, multiple classification

C1.3 Buildings of multiple classification

Type of construction, rise in storeys

C1.2 Calculation of rise in storeys

U

United buildings

A4.1 When buildings are united

A4.2 Alterations in a united building

V

Vehicular access

C2.4 Requirements for open spaces and vehicular access

Ventilation

- F4.0** Deemed-to-Satisfy Provisions
- F4.11** Carparks
- F4.12** Kitchen local exhaust ventilation
- F4.5** Ventilation of rooms
- F4.6** Natural ventilation
- F4.7** Ventilation borrowed from adjoining room
- F4.8** Restriction on position of water closets and urinals
- F4.9** Airlocks

Ventilation opening, energy efficiency

- J4.3** Ventilation openings

Ventilation systems, energy efficiency

- J5.0** Deemed-to-Satisfy Provisions
- J5.2** Air-conditioning and ventilation systems
- J5.3** Time switch
- J5.5** Miscellaneous exhaust systems

Ventilation, carpark

- F4.11** Carparks

Ventilation, kitchen exhaust

- F4.12** Kitchen local exhaust ventilation

Verification Method, energy efficiency

- JV1** Verification Methods JV1 - JV3
- JV3** Verification Methods JV1 - JV3
- SPEC-JV** Specification JV Annual Energy Consumption Calculation

W

Wall construction, energy

- SPEC-J1.5-1** Specification J1.5 Wall Construction
- SPEC-J1.5-2** Specification J1.5 Wall Construction

Wall construction, energy efficiency

- J1.5** Walls
- SPEC-J1.5** Specification J1.5 Wall Construction

Water closets and urinals

- F4.8** Restriction on position of water closets and urinals
- F4.9** Airlocks

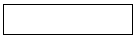

SUPERSEDED
INDEX . ABBREVIATIONS AND SYMBOLS

Wet areas

F1.7 Water proofing of wet areas in buildings

SUPERSEDED
INDEX . ABBREVIATIONS AND SYMBOLS

ABBREVIATIONS AND SYMBOLS

Abbreviations and Symbols used in the BCA include:

ABBREVIATIONS

ABCB	Australian Building Codes Board
AISC	Australian Institute of Steel Construction
ALGA	Australian Local Government Association
AS	Australian Standard
ASTM	American Society for Testing and Materials
BCA	Building Code of Australia
BCC	Building Codes Committee
C_{SHGC}	Constant for solar heat gain
CSIRO	Commonwealth Scientific and Industrial Research Organisation
C_U	Constant for conductance
FRL	Fire Resistance Level
GRP	glass fibre reinforced polyester
ISO	International Organisation for Standardisation
NATA	National Association of Testing Authorities
PVC	polyvinyl chloride
R_w	weighted sound reduction index
SHGC	Solar Heat Gain Coefficient
STC	Sound Transmission Class
UPVC	unplasticized polyvinyl chloride
U-Value	Thermal transmittance

SYMBOLS (SI UNITS)

dB(A)	decibels "A" scale weighting network
°C	degree(s) Celsius
°CDB	degree(s) Celsius Dry Bulb
°CWB	degree(s) Celsius Wet Bulb
J/kg.K	Joules per kilogram per degree Kelvin
K	kelvin(s)
kg	kilogram(s)
kg/m	kilogram(s) per metre

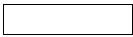

SUPERSEDED
INDEX . ABBREVIATIONS AND SYMBOLS

kg/m ²	kilogram(s) per square metre
kg/m ³	kilogram(s) per cubic metre
kPa	kilopascal(s)
kW/m ²	kilowatt(s) per square metre
kW _{heating}	kilowatt(s) of heating
kWr	kilowatt(s) of refrigeration
L	litre(s)
L/s	litre(s) per second
L/s.m ²	litre(s) per second square metre
Lumens/W	Lumens per Watt
lx	lux
m	metre(s)
m ²	square metre(s)
m ³	cubic metre(s)
MJ/m ² .annum	MegaJoules per square metre annum
m/s	metre(s) per second
m ³ /s	cubic metre(s) per second
mm	millimetre(s)
mm ²	square millimetre(s)
µm	micrometer
MW	megawatt(s)
N	newton(s)
Pa	pascal(s)
W	Watt(s)
W/m.K	Watts per metre per degree Kelvin
W/m ²	Watts per square metre

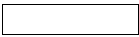

HISTORY OF BCA ADOPTION

CONTENTS

HISTORY OF BCA ADOPTION

History of BCA Adoption

- 1.0 Adoption of BCA96
- 1.1 Amendment No. 1
- 1.2 Amendment No. 2
- 1.3 Amendment No. 3
- 1.4 Amendment No. 4
- 1.5 Amendment No. 5
- 1.6 Amendment No. 6
- 1.7 Amendment No. 7
- 1.8 Amendment No. 8
- 1.9 Amendment No. 9
- 1.10 Amendment No. 10
- 1.11 Amendment No. 11
- 1.12 Amendment No. 12
- 1.13 Amendment No. 13
- 2.0 Adoption of BCA2004
- 3.0 Adoption of BCA2005
- 4.0 History of adoption of BCA2006
- 5.0 History of adoption of BCA2007
- 6.0 History of adoption of BCA2008
- 7.0 History of adoption of BCA2009

HISTORY OF BCA ADOPTION

1.0 Adoption of BCA96

The 1996 edition of the BCA was adopted as set out in Table Amdt 1.0.

Table 1.0 History of adoption of BCA96

Administration	Adoption Date
Australian Government	1 July 1997
Australian Capital Territory	1 July 1997
New South Wales	1 July 1997
Northern Territory	7 January 1998
Queensland	1 July 1997
South Australia	1 January 1998
Tasmania	1 July 1997
Victoria	1 August 1997
Western Australia	1 July 1997

1.1 Amendment No. 1

(a) Amendment No. 1 of the 1996 edition of the BCA was adopted as set out in Table 1.1.

Table 1.1 History of adoption of Amendment No. 1 of the BCA96

Administration	Adoption Date
Australian Government	1 July 1997
Australian Capital Territory	1 July 1997
New South Wales	1 July 1997
Northern Territory	7 January 1998
Queensland	1 July 1997
South Australia	1 January 1998
Tasmania	1 July 1997
Victoria	1 August 1997
Western Australia	1 July 1997

(b) The purpose of Amendment No. 1 is to—

- (i) correct minor typographical errors including spelling, punctuation and layout; and
- (ii) include reference to a Certificate of Conformity issued by the ABCB in A2.2; and
- (iii) change the reference to the Standards Mark Certificate to refer to JAS–ANZ in A2.2; and

- (iv) update references to Standards.

Note:

Only substantive typographical corrections are noted in the margin.

1.2 Amendment No. 2

- (a) Amendment No. 2 of the 1996 edition of the BCA was adopted as set out in Table 1.2.

Table 1.2 History of adoption of Amendment No. 2 of the BCA96

Administration	Adoption Date
Australian Government	1 January 1998
Australian Capital Territory	1 January 1998
New South Wales	27 February 1998
Northern Territory	7 January 1998
Queensland	1 January 1998
South Australia	1 January 1998
Tasmania	1 January 1998
Victoria	1 January 1998
Western Australia	1 January 1998

- (b) The purpose of Amendment No. 2 is to—
 - (i) correct minor typographical errors; and
 - (ii) update references to Standards.

1.3 Amendment No. 3

- (a) Amendment No. 3 of the 1996 edition of the BCA was adopted as set out in Table 1.3.

Table 1.3 History of adoption of Amendment No. 3 of the BCA96

Administration	Adoption Date
Australian Government	1 July 1998
Australian Capital Territory	1 July 1998
New South Wales	1 July 1998
Northern Territory	1 July 1998
Queensland	1 July 1998
South Australia	13 July 1998
Tasmania	1 July 1998
Victoria	1 July 1998
Western Australia	1 July 1998

- (b) The purpose of Amendment No. 3 is to—

- (i) incorporate the outcomes of the 1997 ABCB Variations Conference; and
- (ii) update references to Standards; and
- (iii) include minor technical changes.

1.4 Amendment No. 4

- (a) Amendment No. 4 of the 1996 edition of the BCA was adopted by the Australian Government, States and Territories as set out in Table 1.4.

Table 1.4 History of adoption of Amendment No. 4 of the BCA96

Administration	Adoption Date
Australian Government	1 January 1999
Australian Capital Territory	17 May 1999
New South Wales	1 February 1999
Northern Territory	1 January 1999
Queensland	1 January 1999
South Australia	1 January 1999
Tasmania	1 January 1999
Victoria	1 January 1999
Western Australia	1 January 1999

- (b) The purpose of Amendment No. 4 is to—
 - (i) update references to Standards; and
 - (ii) include minor technical changes.

Note:

Only substantive typographical corrections are noted in the margin.

1.5 Amendment No. 5

- (a) Amendment No. 5 of the 1996 edition of the BCA was adopted as set out in Table 1.5.

Table 1.5 History of adoption of Amendment No. 5 of the BCA96

Administration	Adoption Date
Australian Government	1 July 1999
Australian Capital Territory	3 November 1999
New South Wales	1 August 1999
Northern Territory	1 July 1999
Queensland	1 July 1999
South Australia	1 July 1999
Tasmania	1 July 1999

Table 1.5 History of adoption of Amendment No. 5 of the BCA96— continued

Administration	Adoption Date
Victoria	1 July 1999
Western Australia	1 July 1999

- (b) The purpose of Amendment No. 5 is to—
- (i) update references to Standards; and
 - (ii) include minor technical changes; and
 - (iii) amend clauses to improve clarity and to reduce the possibility of differences in interpretation; and
 - (iv) expand on the requirements for sub-floor ventilation based on climatic conditions.

Note:

Only substantive typographical corrections are noted in the margin.

1.6 Amendment No. 6

- (a) Amendment No. 6 of the 1996 edition of the BCA was adopted as set out in Table 1.6.

Table 1.6 History of adoption of Amendment No. 6 of the BCA96

Administration	Adoption Date
Australian Government	1 January 2000
Australian Capital Territory	10 February 2000
New South Wales	1 January 2000
Northern Territory	1 January 2000
Queensland	1 January 2000
South Australia	17 January 2000
Tasmania	1 January 2000
Victoria	1 January 2000
Western Australia	1 January 2000

- (b) The purpose of Amendment No. 6 is to—
- (i) update references to Standards; and
 - (ii) expand on the requirements for carparking for people with disabilities; and
 - (iii) replace Sound Transmission Class (STC) with weighted sound reduction index (R_w) within Part F5; and
 - (iv) include minor technical changes.

Note:

Only substantive typographical corrections are noted in the margin.

1.7 Amendment No. 7

(a) Amendment No. 7 of the 1996 edition of the BCA was adopted as set out in Table 1.7.

Table 1.7 History of adoption of Amendment No. 7 of the BCA96

Administration	Adoption Date
Australian Government	1 July 2000
Australian Capital Territory	10 July 2000
New South Wales	1 July 2000
Northern Territory	1 July 2000
Queensland	1 July 2000
South Australia	1 July 2000
Tasmania	1 July 2000
Victoria	1 July 2000
Western Australia	1 July 2000

(b) The purpose of Amendment No. 7 is to—

- (i) update references to Standards; and
- (ii) include requirements for non-required and private stairways; and
- (iii) include minor technical changes.

Note:

Only substantive typographical corrections are noted in the margin.

1.8 Amendment No. 8

(a) Amendment No. 8 of the 1996 edition of the BCA was adopted as set out in Table 1.8.

Table 1.8 History of adoption of Amendment No. 8 of the BCA96

Administration	Adoption Date
Australian Government	1 January 2001
Australian Capital Territory	11 January 2001
New South Wales	1 January 2001
Northern Territory	1 January 2001
Queensland	1 January 2001
South Australia	1 January 2001
Tasmania	1 January 2001
Victoria	1 January 2001
Western Australia	1 January 2001

(b) The purpose of Amendment No. 8 is to—

- (i) update references to Standards; and
- (ii) include minor technical changes; and
- (iii) achieve greater consistency between both Volumes of the BCA for stairway construction.

Note:

Only substantive typographical corrections are noted in the margin.

1.9 Amendment No. 9

- (a) Amendment No. 9 of the 1996 edition of the BCA was adopted as set out in Table 1.9.

Table 1.9 History of adoption of Amendment No. 9 of the BCA96

Administration	Adoption Date
Australian Government	1 July 2001
Australian Capital Territory	12 July 2001
New South Wales	1 July 2001
Northern Territory	1 July 2001
Queensland	1 July 2001
South Australia	2 July 2001
Tasmania	1 July 2001
Victoria	1 July 2001
Western Australia	1 July 2001

- (b) The purpose of Amendment No. 9 is to—
 - (i) update references to Standards; and
 - (ii) include minor technical changes; and
 - (iii) clarify which glazed assemblies must comply with AS 2047 and which must comply with AS 1288.

Note:

Only substantive typographical corrections are noted in the margin.

1.10 Amendment No. 10

- (a) Amendment No. 10 of the 1996 edition of the BCA was adopted as set out in Table 1.10.

Table 1.10 History of adoption of Amendment No. 10 of the BCA96

Administration	Adoption Date
Australian Government	1 January 2002
Australian Capital Territory	1 January 2002
New South Wales	1 January 2002

Table 1.10 History of adoption of Amendment No. 10 of the BCA96— continued

Administration	Adoption Date
Northern Territory	1 January 2002
Queensland	1 January 2002
South Australia	1 January 2002
Tasmania	1 January 2002
Victoria	1 January 2002
Western Australia	1 January 2002

- (b) The purpose of Amendment No. 10 is to—
- (i) update references to Standards; and
 - (ii) clarify that windows must comply with AS 2047 for resistance to water penetration; and
 - (iii) subject to certain conditions, allow a non-fire-isolated stairway to connect an additional storey; and
 - (iv) update signage required for people with disabilities, including the need for signs to contain Braille and tactile information; and
 - (v) include minor technical changes.

Note:

Only substantive typographical corrections are noted in the margin.

1.11 Amendment No. 11

- (a) Amendment No. 11 of the 1996 edition of the BCA was adopted as set out in Table 1.11.

Table 1.11 History of adoption of Amendment No. 11 of the BCA96

Administration	Adoption Date
Australian Government	1 July 2002
Australian Capital Territory	1 July 2002
New South Wales	1 July 2002
Northern Territory	1 July 2002
Queensland	1 July 2002
South Australia	1 July 2002
Tasmania	1 July 2002
Victoria	1 July 2002
Western Australia	1 July 2002

- (b) The purpose of Amendment No. 11 is to—
- (i) update references to Standards; and
 - (ii) transfer public policy matters, with respect to structural adequacy, from the AS 1170 series to the BCA; and

- (iii) introduce Class 7a, 7b and 9c classifications; and
- (iv) update the provisions for residential buildings used for the accommodation of the aged to align with the Commonwealth Aged Care Act, 1997; and
- (v) include minor technical changes.

Note:

Only substantive typographical corrections are noted in the margin.

1.12 Amendment No. 12

- (a) Amendment No. 12 of the 1996 edition of the BCA was adopted as set out in Table 1.12.

Table 1.12 History of adoption of Amendment No. 12 of the BCA96

Administration	Adoption Date
Australian Government	1 January 2003
Australian Capital Territory	1 January 2003
New South Wales	1 January 2003
Northern Territory	1 January 2003
Queensland	1 January 2003
South Australia	1 January 2003
Tasmania	1 January 2003
Victoria	1 January 2003
Western Australia	1 January 2003

- (b) The purpose of Amendment No. 12 is to—
 - (i) update references to Standards; and
 - (ii) apply the swimming pool safety provisions to swimming pools associated with Class 4 parts as well as Class 2 and 3 buildings; and
 - (iii) allow the use of either the 1989 editions or the 2002 editions of the 1170 series of standards; and
 - (iv) include minor technical changes.

Note:

Only substantive typographical corrections are noted in the margin.

1.13 Amendment No. 13

- (a) Amendment No. 13 of the 1996 edition of the BCA was adopted as set out in Table 1.13.

Table 1.13 History of adoption of Amendment No. 13 of the BCA96

Administration	Adoption Date
Australian Government	1 July 2003
Australian Capital Territory	1 July 2003

Table 1.13 History of adoption of Amendment No. 13 of the BCA96— continued

Administration	Adoption Date
New South Wales	1 July 2003
Northern Territory	1 July 2003
Queensland	1 July 2003
South Australia	To be advised
Tasmania	1 July 2003
Victoria	1 July 2003
Western Australia	1 July 2003

- (b) The purpose of Amendment No. 13 is to—
- (i) update references to Standards; and
 - (ii) reform the provisions for fire hazard properties of materials; and
 - (iii) revise a requirement for the use of non-combustible materials; and
 - (iv) include additional requirements for the protection of electrical switchboards which sustain electricity supply to emergency equipment; and
 - (v) include minor changes to the requirements for aged care buildings; and
 - (vi) include minor technical changes.

Note:

Only substantive typographical corrections are noted in the margin.

2.0 Adoption of BCA 2004

- (a) The 2004 edition of the BCA was adopted as set out in Table 2.0.

Table 2.0 History of adoption

Administration	Adoption Date
Australian Government	1 May 2004
Australian Capital Territory	1 May 2004
New South Wales	1 May 2004
Northern Territory	1 May 2004
Queensland	1 May 2004
South Australia	1 May 2004
Tasmania	1 May 2004
Victoria	1 May 2004
Western Australia	1 May 2004

- (b) The purpose of BCA 2004 is to—
- (i) update references to Standards; and
 - (ii) update references from BCA 96 to BCA 2004; and

- (iii) include a Performance Requirement considering human impact with glazing; and
- (iv) reform the provisions for sound insulation; and
- (v) reform the maintenance provisions; and
- (vi) include minor technical changes.

3.0 Adoption of BCA 2005

- (a) The 2005 edition of the BCA was adopted as set out in Table 3.0.

Table 3.0 Adoption of BCA 2005

Administration	Adoption Date
Australian Government	1 May 2005
Australian Capital Territory	1 May 2005
New South Wales	1 May 2005
Northern Territory	1 May 2005
Queensland	1 May 2005
South Australia	1 May 2005
Tasmania	1 May 2005
Victoria	1 May 2005
Western Australia	1 May 2005

- (b) The purpose of BCA 2005 is to—
 - (i) update references to Standards; and
 - (ii) clarify when fire sprinklers are required to be installed in buildings; and
 - (iii) update the provisions for waterproofing of wet areas; and
 - (iv) include energy efficiency measures for Class 2 and 3 buildings and Class 4 parts; and
 - (v) more closely align the requirements for lifts with those of Occupational Health and Safety legislation; and
 - (vi) include minor technical changes.

4.0 History of adoption of BCA 2006

- (a) The 2006 edition of the BCA was adopted as set out in Table 4.0.

Table 4.0 Adoption of BCA 2006

Administration	Adoption Date
Australian Government	1 May 2006
Australian Capital Territory	1 May 2006

Table 4.0 Adoption of BCA 2006— continued

Administration	Adoption Date
New South Wales	1 May 2006 (except that the date for mandatory compliance with Section J provisions for Class 5 to 9 buildings is 1 November 2006)
Northern Territory	1 May 2006
Queensland	1 May 2006
South Australia	1 May 2006, except for Part I2 and Section J which were adopted on 1 August 2006
Tasmania	1 May 2006
Victoria	1 May 2006
Western Australia	1 May 2006

- (b) The purpose of BCA 2006 is to—
- (i) update schedule of referenced documents; and
 - (ii) include a national testing regime for cladding in cyclonic areas; and
 - (iii) withdraw of AS1530.3 tests on floor materials and floor coverings and wall and ceiling linings; and
 - (iv) include energy efficiency measures for Class 5 to 9 buildings; and
 - (v) include minor technical changes.

5.0 History of adoption of BCA 2007

- (a) The 2007 edition of the BCA was adopted by the Commonwealth, States and Territories as set out in Table 5.0.

Table 5.0 Adoption of BCA 2007

Administration	Adoption Date
Australian Government	1 May 2007
Australian Capital Territory	1 May 2007
New South Wales	1 May 2007
Northern Territory	1 May 2007
Queensland	1 May 2007
South Australia	1 May 2007
Tasmania	1 May 2007
Victoria	1 May 2007
Western Australia	1 May 2007

- (b) The purpose of BCA 2007 is to—
- (i) update references to other documents; and

- (ii) update energy efficiency provisions including providing additional information; and
- (ii) include minor technical changes.

6.0 History of adoption of BCA 2008

- (a) The 2008 edition of the BCA was adopted by the Commonwealth, States and Territories as set out in Table 6.0.

Table 6.0 Adoption of BCA 2008

Administration	Adoption Date
Australian Government	1 May 2008
Australian Capital Territory	1 May 2008
New South Wales	1 May 2008
Northern Territory	1 May 2008
Queensland	1 May 2008
South Australia	1 May 2008
Tasmania	1 May 2008
Victoria	1 May 2008
Western Australia	1 May 2008

- (b) The purpose of BCA 2008 is to—
 - (i) update references to other documents; and
 - (ii) due to changes in the types of detectors now available, rather than only allowing the use of a heat detectors when smoke detector would be unsuitable in the atmosphere, to also allow the use of any type of detector deemed suitable by AS 1670.1; and
 - (iii) clarify the intent of the BCA when a service penetrates a building element required to have an FRL; and
 - (iv) amend the requirements for door handle heights to be consistent with AS 1428.1; and
 - (v) align some BCA terms with current industry terminology; and
 - (vi) include lists of other Commonwealth, State and Territory legislation affecting buildings; and
 - (vii) include suitable provisions for swimming pool water recirculation systems; and
 - (viii) include minor technical changes.

7.0 History of adoption of BCA 2009

- (a) The 2009 edition of the BCA was adopted by the Commonwealth, States and Territories as set out in Table 7.0.

Table 7.0 Adoption of BCA 2009

Administration	Adoption Date
Australian Government	1 May 2009
Australian Capital Territory	1 May 2009
New South Wales	1 May 2009
Northern Territory	1 May 2009
Queensland	1 May 2009
South Australia	1 May 2009
Tasmania	1 May 2009
Victoria	1 May 2009
Western Australia	1 May 2009

- (b) The purpose of BCA 2009 is to—
- (i) update references to other documents; and
 - (ii) after expiry of the agreed transition period, except for the 1993 edition of AS 1170.4, delete all references to the older loading standards contained in the AS 1170 series and consequently, all provisions referring to them; and
 - (iii) clarify the application of the vertical separation provisions; and
 - (iv) clarify the intent of separation of equipment; and
 - (v) simplify the wire balustrade provisions, including the addition of a *Verification Method*; and
 - (vi) clarify the provisions for the construction of sanitary compartments to enable an unconscious occupant to be removed; and
 - (vii) clarify the height of rooms in an attic and with a sloping ceiling; and
 - (viii) further update the energy efficiency provisions; and
 - (ix) include minor technical changes.

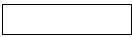

SUPERSEDED
LIST OF AMENDMENTS

LIST OF AMENDMENTS

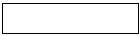

SUPERSEDED
LIST OF AMENDMENTS

CONTENTS

LIST OF AMENDMENTS
List of Amendments Volume One

SUPERSEDED
LIST OF AMENDMENTS

LIST OF AMENDMENTS - BCA 2009 - VOLUME ONE

This set of notes has been prepared by the Australian Building Codes Board to assist BCA users in identifying changes incorporated in the 2009 edition of Volume One of the BCA (BCA 2009).

The notes provide a description of major changes made from the previous edition of the BCA. If additional information is required to assist in understanding, interpreting or applying the provisions of BCA 2009, reference should be made to the Guide to the BCA.

While the Australian Building Codes Board has attempted to include all major changes made from the previous edition of the BCA Volume One, the Board does not give any warranty nor accept any liability in relation to the contents of this list of amendments.

BCA Reference	Change and Commentary	
Section A		
A1.1	The following definitions have been inserted or amended:	
	Air-conditioning	Clarification added that "air-conditioning" does not include a service that directly cools or heats cold rooms and hot rooms.
	Assembly building	Examples of types of assembly buildings added.
Figure A1.1	Climate zone map	The climate zone map in Figure A1.1 has been updated.
Table A1.1	In Victoria, the climate zone for Bairnsdale has been changed to 6.	
	Conditioned space	A Class 6 building where the input power to an air-conditioning system is not more than 15 W/m ² has been added to the spaces not considered to be a "conditioned space".
	Fire hazard properties	Clarification added on which fire hazard properties must be determined as defined in A1.1 and which must be determined in accordance with Specification A2.4.
	Fire-source feature	The far boundary of lakes and rivers added to the list of features considered to be a fire-source feature.
	Glazing	The intent of the definition has been clarified by referring to the "envelope" of the building rather than the "external fabric" of the building.
	Illumination power density	Clarification added that the power used by floor standing lamps, desk lamps or work station lamps plugged into socket outlets and for intermittent use is not included when determining the illumination power density.
	Lamp power density	Clarification added that the power used by floor standing lamps, desk lamps or work station lamps plugged into socket outlets and for intermittent use is not included when determining the lamp power density.
	Sarking-type material	Clarification added that a sarking-type material includes reflective insulation.

SUPERSEDED
LIST OF AMENDMENTS

BCA Reference	Change and Commentary
A1.3(d)	New provision inserted clarifying that where a document listed in Specification A1.3 is subject to publication of a new edition, the new edition need not be complied with in order to comply with the Deemed-to-Satisfy Provisions.
A2.4	Clarification added on which fire hazard properties must be determined as defined in A1.1 and which properties must be determined in accordance with Specification A2.4.
A3.2	Class 6: Clarification added that Class 6 includes bar areas other than those that are an assembly building.
Specification A1.3 Table 1	<p>The following references have been inserted or amended:</p> <p>AS/NZS 1170 Part 1 Amdt 2 to AS/NZS 1170 "Structural design actions" Part 1 "Permanent, imposed and other actions" referenced.</p> <p>AS 1170 Part 1 After the expiry of the agreed transition period, reference to AS 1170 "Minimum design loads on structures" Part 1 "Dead and live loads and load combinations" 1989 has been deleted.</p> <p>AS 1170 Part 2 After the expiry of the agreed transition period, reference to AS 1170 "Minimum design loads on structures" Part 2 "Wind loads" 1989 has been deleted.</p> <p>AS 1170 Part 3 After the expiry of the agreed transition period, reference to AS 1170 "Minimum design loads on structures" Part 3 "Snow loads" 1990 has been deleted.</p> <p>Note: The ABCB expects to delete reference to AS 1170 "Minimum design loads on structures" Part 4 "Earthquake loads" 1993 as part of the changes for BCA 2010.</p> <p>AS 1684 Part 2 Amdt 1 to AS 1684 "Residential timber-framed construction" Part 2 "Non-cyclonic areas" referenced.</p> <p>AS 1684 Part 3 Amdt 1 to AS 1684 "Residential timber-framed construction" Part 3 "Cyclonic areas" referenced.</p> <p>AS 1684 Part 4 Amdt 1 to AS 1684 "Residential timber-framed construction" Part 4 "Simplified — non-cyclonic areas" referenced.</p> <p>AS 1720 Part 1 The notes to AS 1720 "Timber structures" Part 1 "Design methods" have been deleted due to deletion of all references to the older loading standards contained in the AS 1170 series.</p> <p>AS 2419 Part 1 As a consequence of changes to C2.12, reference to that provision has been included for AS 2419 "Fire hydrant installations', Part 1 "System design, installation and commissioning".</p> <p>AS 3700 The notes to AS 3700 "Masonry structures" have been deleted as a consequence of changes to B1.4.</p>

SUPERSEDED
LIST OF AMENDMENTS

BCA Reference	Change and Commentary
AS/NZS 4859 Part 1	The note to AS/NZS 4859 "Materials for the thermal insulation of buildings", Part 1 "General criteria and technical provisions" allowing test and calculation reports demonstrating compliance with the standard carried out prior to the introduction of Amdt 1 has been removed after the expiry of the agreed transition period.
ABCB	Reference to the ABCB "Protocol for House Energy Rating Software Version 2005.1" has been deleted after the agreed transition period with the 2006.1 version.
Section B	
BP1.1(b)(xv)	Termite actions have been included as one of the actions to which a building may reasonably be subjected.
B1.0(a)	With the deletion of the older loading standards except for the 1993 edition of AS 1170.4, the provision has been amended to clarify that the relevant Performance Requirements are satisfied — <ul style="list-style-type: none"> • by complying with B1.1, B1.2 and B1.4; or • for the earthquake resistance component of the Performance Requirements, by complying with B1.3 and B1.4.
B1.3	With the deletion of the older loading standards except for the 1993 edition of AS 1170.4, the provision has been amended to only refer to determination of earthquake loads. All other references to superceded loading standards have been removed.
B1.4	With the deletion of the older loading standards except for the 1993 edition of AS 1170.4, the provision has been amended to require earthquake actions on masonry structures to be determined in accordance with AS 1170.4 (2007). This means that AS 1170.4 (1993) cannot be used to determine earthquake actions for masonry structures.
Specification B1.2, Clause 1	Both references to AS 1170.2 deleted due to the deletion of all references to the older loading standards contained in the AS 1170 series.
Section C	
C2.4(b)(i)	Clarification added that the vehicular access must provide continuous access for emergency vehicles around the entire building.
C2.5(b)(ii)	C2.7 has been added to the provisions which are overridden by C2.5(b)(ii) which requires a floor separating a fire compartment in a Class 9c building from the remainder of the building to have an FRL of 60/60/60. C2.7(c)(i) requires a floor separating fire compartments to have the same FRL as a fire wall, which is not intended to apply in this case.
C2.6(c)	New provision inserted clarifying the meaning of window or other opening when used in C2.6.
C2.7(a)(iii)	The term "roof sarking" has been replaced with the defined term "sarking-type material" to clarify that reflective insulation or other flexible membranes used for waterproofing, vapour proofing or thermal reflectance may cross a fire wall.

SUPERSEDED
LIST OF AMENDMENTS

BCA Reference	Change and Commentary
C2.12(a)	<ul style="list-style-type: none"> • The exemption for the separation of lift motors and lift control panels to be separated by construction having an FRL of not less than 120/-/-, has been moved from (a)(i) to (d)(ii) so that all the required FRL's are contained together in (d). • Clarification has been added to (ii) that the generators referred to are only those that are used to sustain emergency equipment operating in the emergency mode. • The reference to central smoke control plant has been moved to be a separate listed item. This has resulted in the subsequent items being re-numbered. • Clarification has been added in the new (v) that the battery or batteries referred to are only those that are installed in the building and that have a voltage exceeding 24 volts and a capacity exceeding 10 ampere hours.
C2.12(b)	To be consistent with the wording of (a), the provision has been amended to refer to equipment that need not be separated in accordance with (a).
C2.12(c)	Reference has been made to AS 2419.1 — Fire hydrant installations, instead of a general reference to E1.3.
C2.12(d)	The provision has been redrafted to require the separating construction between a lift shaft or motor room and the remainder of the building to have an FRL of not less than 120/-/-.
C3.2(a)	C3.2(a) has been deleted, to allow openings in external walls to be any distance from a fire-source feature. Consequently, the NSW variation to this provision has been deleted and the remaining subclauses have been re-numbered.
C3.2(b)(ii) (New C3.2(a)(ii))	As a consequence of the changes to the definition of "fire-source feature", reference to a river, lake or the like has been added.
C3.4(a)	To assist in the readability of the provision, it has been restructured. There has been no technical change other than clarifying that the automatic windows and fire shutters must be automatic closing and that sprinkler protection of other openings is not permitted where the opening consists of a void.
Specification C1.1, Clause 3.1(c)(iii)	The term "roof sarking" has been replaced with the defined term "sarking-type material" to clarify that reflective insulation or other flexible membranes used for waterproofing, vapour proofing or thermal reflectance may cross an internal wall required to have an FRL.
Specification C1.1, Clause 4.1(d)(iii)	The term "roof sarking" has been replaced with the defined term "sarking-type material" to clarify that reflective insulation or other flexible membranes used for waterproofing, vapour proofing or thermal reflectance may cross an internal wall required to have an FRL.
Specification C1.1, Clause 4.3(b)	New sub-clause inserted allowing the concession for Class 2 buildings to apply where one storey is used solely for carparking. The concession is similar to that contained in clause 3.10(b). However, allowance of an additional storey has not been included due to the maximum rise in storeys of a Class 2 building of Type B construction being 2.

SUPERSEDED
LIST OF AMENDMENTS

BCA Reference	Change and Commentary
Specification C1.1, Clause 5.1(d)(iii)	The term "roof sarking" has been replaced with the defined term "sarking-type material" to clarify that reflective insulation or other flexible membranes used for waterproofing, vapour proofing or thermal reflectance may cross an internal wall required to have an FRL.
Specification C2.5, Clause 3(b)(iii)	Amended to clarify that all penetrations of the ceiling are to be sealed against the free passage of smoke.
Section D	
DV1	New Verification Method inserted setting procedures for the testing of wire balustrades as an alternative to complying with the relevant Deemed-to-Satisfy Provisions contained in D2.16.
D1.3(a)	Clarification added that the extra storey included in Class 2 or 3 buildings can be of any classification.
D1.3(b)(iii)	Clarification added that the extra storey included in Class 5 to 9 buildings can be of any classification.
D2.16(a) and (b)	<ul style="list-style-type: none"> • All situations where subclause (a) does not apply have been consolidated into a new subclause (b). Consequently, all the remaining subclauses have been re-numbered. • Clarification added that the requirement to provide a balustrade or other barrier does not apply to a retaining wall unless the retaining wall unless it is associated with a delineated path of access to a building from a road, or between buildings.
D2.16(i)(ii)	Reference to Note 4 in Table D2.16a added.
D2.16(i)(iii)(C)	Maximum spacing between rails for a continuous vertical wire balustrade increased from 800 mm to 900 mm to allow a wider range of balustrade designs.
Table D2.16a	Table amended by revising some tension values, providing a greater range of wires and wire spacings, deleting galvanised wire, deleting deflection values (now in new Table D2.16c), and providing additional notes.
Table D2.16b	Table amended by revising the wire spacings, providing new tension values to each wire listed and providing additional notes.
Table D2.16c	New table included providing only deflection values. The table has been derived from the old Table D2.16a but with revised values.
D2.17(a)(v)	Wording amended for consistency with (a)(iv).
Section E	
E1.4	<ul style="list-style-type: none"> • Clarification added that fire hose reels need not be located within 4 m of every exit or adjacent to every fire hydrant. Additional fire hose reels may also be installed remote from exits and hydrants if necessary to achieve the system coverage specified in AS 2441. • The circumstances under which an extended fire hose may pass through a doorway fitted with a fire or smoke door have been restructured and elaborated with no technical change.

SUPERSEDED
LIST OF AMENDMENTS

BCA Reference	Change and Commentary
Specification E1.5, Clause 2(d)	The phrase "as applicable" has been added as AS 2118.4 systems can only be used if the Class 9c building is not greater than 4 storeys in height.
Table E2.2a	In the part of the Table dealing with Class 7a buildings, clarification has been added that fans with metal blades suitable for operating at normal temperatures may be used instead of fans required to operate at elevated temperatures as required by Clause 4.8.1 of AS 1668.1.
Specification E2.2a, Clause 3(b)	Clarification added that any type of detector is not required in a kitchen or other area if the kitchen or other area is sprinklered.
Specification E2.2a, Clause 4(b)	Clarification added that any type of detector is not required in a kitchen or other area if the kitchen or other area is sprinklered.
Specification E2.2a, Clause 4(d)(i)(B)	For consistency with similar provisions, clarification has been added that where the use of the area is likely to result in smoke detectors causing spurious signals, any other detector deemed suitable in accordance with AS 1670.1 may be installed in lieu of smoke detectors.
Section F	
F2.5(b) and new Figure F2.5	Reference to new Figure F2.5 inserted to provide clarification on the measurement of the 1.2 m clear space.
F3.1(a)	For Class 2 or 3 buildings and Class 4 parts, amended to specify the minimum ceiling height for attic rooms, rooms with a sloping ceiling or where there is a projection below the ceiling line.
Part F5	The Queensland variation flag has been deleted due to the variation being deleted from the Queensland Appendix.
Section I	
IP2.1 Limitation	The limitation has been amended to clarify that IP2.1 does not apply to services serving only one sole-occupancy unit of a Class 2 building or only a Class 4 part of a building.
Section J	
JV3 Verification	With the removal of JV2 at BCA 2008, the application of JV3 has been extended so that it now applies to all Class 3 to 9 buildings.
Part J2	The title of the Part has been amended to "Glazing" to more closely reflect the contents of the Part.
J2.3(a) and (b)	Clarification added that when a mezzanine is included in a storey, it is included when calculating glazing allowances for the storey.
J2.4(a)	<ul style="list-style-type: none"> • Amended so that the glazing in each storey must be assessed separately in accordance with (b) and (c) for both the glazing in the external fabric facing each orientation and for the glazing in the internal fabric using the south orientation energy constants and shading multipliers. • Clarification added that when a mezzanine is included in a storey, it is included when calculating glazing allowances for the storey.

SUPERSEDED
LIST OF AMENDMENTS

BCA Reference	Change and Commentary
Table J2.4c	Additional heating shading multipliers added for climate zones 4 and 5, zones 6 and 7 and zone 8 for more than 1200 mm but less than 1800 mm.
Table J2.4c, notes	<ul style="list-style-type: none"> • Due to the changes to the Table, the reference in note 1 to "1200 mm" has been changed to "1800 mm". • New note added advising users that for glazing in the internal fabric to use the appropriate value for the south orientation sector with a P/H value of 2.0.
Table J2.4d	Additional cooling shading multipliers added for climate zones 1, 2 and 3, zones 4 and 5, zones 6 and 7 and zone 8 for more than 1200 mm but less than 1800 mm.
Table J2.4d, notes	<ul style="list-style-type: none"> • Due to the changes to the Table, the reference in note 1 to "1200 mm" has been changed to "1800 mm". • New note added advising users that for glazing in the internal fabric to use the appropriate value for the south orientation sector with a P/H value of 2.0.
J3.4(d)(ii)(B)	Typographical correction.
J3.6(a)	<ul style="list-style-type: none"> • Ceilings have been added to the list of elements required to be sealed to minimise air leakage. • Reference to "conditioned space" removed as the definition of "envelope" refers to separation of conditioned and non-conditioned spaces.
J4.2(b)(iii)	Clarification added that the ventilation opening to the adjoining room need only comply with Table J4.2 for the floor area of the adjoining room and the proportion of the habitable room that is ventilated from the adjoining room.
J5.2(a)(vi) and new Table J5.2a	Amended to better cover more conventional systems due to the existing provisions being found to be too restrictive for specialised applications where there is a high internal load such as a computer suite or a telephone exchange. The changes include the addition of a new Table J5.2a.
J5.2(a)(vii)(A)	The reference to J5.4(c) has been deleted due to that provision setting refrigeration performance and not fan efficiency as covered by J5.2(a)(vii). The subsequent provisions have been re-numbered.
J5.2(b)(i)	Due to the occupants of sole-occupancy units in Class 2 buildings and Class 4 parts of buildings usually controlling any mechanical ventilation system, the provision has been amended to exempt these parts of a building from the requirement for such systems to be capable of being inactivated when the building is not occupied.
J5.2(b)(iii)(A)	As a consequence of the change of Table number, the reference to Table J5.2 has been amended to Table J5.2b.
Table J5.2	As a consequence of the inclusion of new Table J5.2a, Table J5.2 has been re-numbered Table J5.2b.

SUPERSEDED
LIST OF AMENDMENTS

BCA Reference	Change and Commentary
J5.3	<p>Amended to limit the requirement for a time switch so that one is not required where the air-conditioning or ventilation system serves a sole-occupancy unit in a Class 2 or 3 building, a Class 4 part of a building or a Class 9c building. The reason for this is that Class 2 buildings and Class 4 parts are privately owned residential buildings and likely to be closely controlled by the occupants. The sole-occupancy units of a Class 3 building are already controlled by an occupant activated device and likely to be controlled by the occupant when they are in residence while staff and public areas are likely to be in use. Class 9c buildings are also likely to be closely controlled 24 hours a day.</p> <p>Likewise, a time switch is not required where air-conditioning or ventilation is needed for 24 hour occupancy as it is likely to be of little use.</p>
J5.4(a)(ii)(A) and new Table J5.4a	<p>Rather than specify the total motor shaft power to an air-conditioning pump depending on the floor area of the building, a new Table J5.4a, has been included. The new table also includes allowance for the internal load of equipment and people as well as the floor area of the building.</p>
J5.4(b)	<ul style="list-style-type: none"> • Clarification has been added that the water heater being referred to is only one that is part of an air-conditioning system. • As a consequence of the change of Table number, the reference to Table J5.4a has been amended to Table J5.4b.
Previous Table J5.4a	<p>As a consequence of the inclusion of new Table J5.4a, the previous Table J5.4a has been re-numbered Table J5.4b.</p>
J5.4(c)	<p>As a consequence of the change of Table number, the reference to Table J5.4b has been amended to Table J5.4c.</p>
Previous Table J5.4b	<p>As a consequence of the inclusion of new Table J5.4a, the previous Table J5.4b has been re-numbered Table J5.4c.</p>
J5.4(d)	<ul style="list-style-type: none"> • Clarification added that the provision only applies to a refrigerant chiller that is part of an air-conditioning system. • As a consequence of the change of Table number, the reference to Table J5.4c has been amended to Table J5.4d.
Previous Table J5.4c	<p>As a consequence of the inclusion of new Table J5.4a, the previous Table J5.4c has been re-numbered Table J5.4d.</p>
J5.4(e)	<ul style="list-style-type: none"> • Clarification added that the provision only applies to a fan motor of an air cooled condenser that is part of an air-conditioning system. • Amended to specify maximum motor shaft power and input power that is realistic and achievable.
J5.4(f)	<ul style="list-style-type: none"> • Clarification added that the provision only applies to a fan of a cooling tower that is part of an air-conditioning system. • Amended to specify maximum motor shaft power and input power that is realistic and achievable.

SUPERSEDED
LIST OF AMENDMENTS

BCA Reference	Change and Commentary
J5.4(g)	<ul style="list-style-type: none"> Clarification added that the provision only applies to a fan of a closed circuit cooler that is part of an air-conditioning system. Amended to specify maximum motor shaft power and input power that is realistic and achievable.
J5.4(h)	<ul style="list-style-type: none"> Clarification added that the provision only applies to a fan of an evaporative condenser that is part of an air-conditioning system. Amended to specify maximum motor shaft power and input power that is realistic and achievable.
J5.4(i)	Clarification added that the provision only applies to a spray water pump of a closed circuit cooler or an evaporative condenser that is part of an air-conditioning system.
J6.2(a)(ii)(A)	Clarification added that the 30% increase in the lamp power density only applies when floor areas of less than 20 m ² are enclosed.
Table J6.2c Note 7	Clarification added that the application of the two illumination power density adjustment factors that can be applied to an area, excludes the room size.
J6.3(a)	Class 3 buildings removed from subclause, effectively requiring switches or other devices for artificial lighting to all rooms and spaces in all Class 2 to Class 9 buildings.
J6.3(c)	<ul style="list-style-type: none"> Reference to other control device has been added. In (i), clarification added that the requirements apply to an artificial lighting switch. (ii) amended so that the requirements only apply to buildings other than a Class 2 or 3 building or a Class 4 part.
J6.3(d)	Clarification added that the requirements only apply to buildings other than Class 2 or 3 buildings or a Class 4 part.
J6.3(g)	A reference to a Class 9c aged care building has been added so that the requirements of (d) do not apply to those buildings.
J6.5(a)(i)	Rewritten for clarification including re-numbering. Reference to Specification J6 has been deleted.
Specification J1.2, Table 2b	Where available, typical R-Values have been included in a revised Table.
Specification J1.2, Table 2c	<ul style="list-style-type: none"> The existing 3 pitches for cathedral-type ceilings have been replaced with a progression of ranges. The term "reflective insulation" in the heading of the first column has been italicised because it is a defined term.
Specification J1.2, Clause 2(d)	To align with Volume Two, requirements for a ventilated roof space have been added.

SUPERSEDED
LIST OF AMENDMENTS

BCA Reference	Change and Commentary
Specification J1.3, Figure 2(a), (b), (c) and (d)	<ul style="list-style-type: none"> To align with Tables 2b and 2c above, and as applicable to AS 2050 "Installation of roof tiles", the roof slope lower range limit has been reduced to 15°. To align with Volume Two, requirements for a ventilated roof space have been added in note 4.
Specification J5.2, Clause 2(a)(ii)	Clarification added that it is only necessary for the ductwork to be sealed with a draw band in conjunction with either a sealant or adhesive tape.
Specification J5.2, Clause 2(b)	Clarification added that the exemption applies to the ductwork and fittings located within the only room or the last room that is served by the ductwork.
Specification J5.2, Clause 3(a)(ii)	The intent has been clarified that flexible ductwork not longer than 3 m from an outlet must achieve the Total R-Value specified in Tables 3a and 3b (which refer to evaporative cooling systems, heating-only systems, refrigerated-only systems and combined heating and refrigerated cooling systems) or achieve a Total R-Value of 1.0.
Specification J5.2, Clause 3(d)(i)	Clarification added that the exemption for the ductwork not to be thermally insulated applies to the ductwork and fittings located within the only room or the last room that is served by the ductwork.
Specification J5.2, Table 3b	As a consequence of the changes to Clause 3(d)(i), the reference to "other than where the space is the only or last space served" is unnecessary and has been deleted.
Specification J5.4, Clause 2(a)(ii)	Reference to vessels, heat exchangers and tanks has been added due to the Specification including such items.
Specification J6 Clause 3(b)(i) and (ii)	Occupant sensing devices added as well as devices such as a security card reader.
ACT Appendix	
ACT G1.103	Provisions for awnings and projections deleted.
Footnote	Footnotes for "Land Use and Development Control", "Occupational Health and Safety" and "Utilities" updated.
NSW Appendix	
NSW A1.1	The following definitions have been inserted or amended:
Auditorium	The definition has been amended.
Entertainment venue	New definition inserted to replace definition of "place of public entertainment".
Place of public entertainment	Definition deleted. It has been replaced with new definition of "entertainment venue". Consequently, the term "place of public entertainment" has been replaced with the term "entertainment venue" throughout the NSW Appendix.

SUPERSEDED
LIST OF AMENDMENTS

BCA Reference	Change and Commentary	
	Public entertainment	Definition deleted. It is no longer necessary.
	Stage	The definition has been amended.
NSW C3.2	Due to the deletion of C3.2(a) from the main BCA, the NSW variation has been deleted.	
NSW Table E2.2b	<ul style="list-style-type: none"> • The heading of "Night Clubs, Discotheque, and Other Licensed Premises Providing Entertainment" amended to "Night Clubs, Discotheque, and the Like". • The first sentence in this part of the Table has been amended to reflect this change. • In the section titled "Other Assembly Buildings", the term "a night club, discotheque or other licensed premises providing entertainment" amended to "a nightclub, discotheque or the like". 	
NSW Section J	A number of references to Subsection J(A) and J(B) have been corrected by adding "NSW".	
Footnote	New footnote 8.3 inserted.	
NT Appendix		
NT Table 1	<p>The following references have been inserted or amended:</p> <p>AS 1170 Part 2 - 1989 The 1989 edition of AS 1170 "Minimum design loads on structures", Part 2 "Wind loads" has been deleted as it is no longer referenced in the NT Appendix.</p>	
Queensland Appendix		
Qld Part F5	Part deleted.	
Qld Specification F5.2	Specification deleted.	
Qld Specification F5.5	Specification deleted.	
SA Appendix		
SA A1.1	<p>The following definitions have been inserted:</p> <p>Energy Rating label A new definition of "Energy Rating label" inserted.</p> <p>Renewable Energy Certificate A new definition of "Renewable Energy Certificate" inserted.</p> <p>Rated hot water delivery A new definition of "rated hot water delivery" inserted.</p>	
SA Table 1	<p>The following references have been inserted or amended:</p> <p>AS 1056 Part 1 The 1991 edition of AS 1056 "Storage water heaters", Part 1 "General requirements" has been referenced.</p> <p>AS 1720 Part 2 The 2006 edition of AS 1720 "Timber structures", Part 2 "Timber properties" has been referenced.</p>	

SUPERSEDED
LIST OF AMENDMENTS

BCA Reference	Change and Commentary	
	AS 4234	The 1994 edition of AS 4234 "Solar water heaters — Domestic and heat pump — Calculation of energy consumption" has been referenced.
	AS 4552	The 2005 edition has been referenced and the title corrected to "Gas fired water heaters for hot water supply and/or central heating".
	Department of Climate Change	The 2008 edition of "National Greenhouse Accounts (NGA) Factors" has been referenced.
SA G5.2	Amended to include requirements for Class 10 buildings adjoining Class 2 and 3 buildings located in a designated bushfire prone area.	
SA G5.3	Amended to include requirements for low bushfire attack categories as well as medium, high and extreme bushfire attack categories.	
SA JP3	New Performance Requirement and Limitation inserted limiting greenhouse gas emissions for heated water services.	
SA JV4	New Verification Method inserted.	
SA Part J7	Amended to include deemed-to-satisfy provisions for heated water services.	
Tasmania Appendix		
Tas Table 1	The following references have been inserted or amended:	
	AS/NZS 3500 Part 2.2	Reference to AS/NZS "National plumbing and drainage code", Part 2.2 "Sanitary plumbing and draining — acceptable solutions" deleted because it is no longer referenced in the Tasmania Appendix.
	AS/NZS 4220	Reference to AS/NZS "Bunk beds" deleted because it is no longer referenced in the Tasmania Appendix.
Tas G1.1	<ul style="list-style-type: none"> • (f) and (g) have been deleted due to the provisions for chlorine rooms being covered by Tas H120.4(a)(vi) and AS 2927. • Consequently, the existing (h) has been renumbered (g). 	
Tas H101.8	<ul style="list-style-type: none"> • (b) has been deleted due the provisions being covered in the main BCA. • Consequently, the numbering of (a) has been deleted. 	
Tas H102 O1 Application and Limitation	The Limitation has been amended as result of the deregulation of the Part applying to shellfish premises where live shellfish are packed.	
Tas H102 F1 Application and Limitation	The Limitation has been amended as result of the deregulation of the Part applying to shellfish premises where live shellfish are packed.	
Tas H102 P12 Application and Limitation	The Limitation has been amended as result of the deregulation of the Part applying to shellfish premises where live shellfish are packed.	
Tas 102.0	The provision has been amended as result of the deregulation of the Part applying to shellfish premises where live shellfish are packed.	

SUPERSEDED
LIST OF AMENDMENTS

BCA Reference	Change and Commentary
Tas H109.4	<ul style="list-style-type: none"> • The heading has been amended to "Grab rails". • (b) has been deleted due to the provisions being covered by D2.17(b) in the main BCA. • Consequently, the numbering of (a) has been deleted.
Tas H109.6	The provision has been deleted due to water temperature supplied to these facilities being covered by Plumbing legislation.
Tas H110.2	<ul style="list-style-type: none"> • (b) has been deleted due to separation of these facilities being covered in a workplace by F4.8 and F4.9 in the main BCA. • Consequently, (a) has been restructured.
Tas H113.2(c)	The provision has been deleted due to the safety requirements for roof lights being covered by AS 1288 and AS/NZS 1562.3.
Tas H122.2(c)	Clarification added that the indoor play space in a centre-based child care facility must be directly accessible to the toilet facilities.
Tas H122.3(e)	Clarification added that the outdoor play space of a centre-based child care facility must be directly accessible to the indoor play space.
Tas 122.4(a)(ii)	The term "over 12 months and under 2 years" has been replaced with the term "aged one year".
Tas 122.5	The term "Table" has been deleted.
Tas 122.6(a)(iv)	The term "Table" has been deleted.
Tas 122.11	The term "and safe" has been inserted to apply to the storage.
Victoria Appendix	
Vic D2.21	As a consequence of changes to D2.21 in BCA 2008, Vic D2.21(g) has been re-numbered Vic D2.21 (a)(vi).
Vic Part H102 Application	The reference to "Building (Interim) Regulations 2005" has been updated to "the Building Regulations 2006".
Part J2	For consistency with the change to the main BCA, the title of the Part has been updated to "Glazing".
Footnote	<ul style="list-style-type: none"> • Footnote for "Asbestos Removal" has been inserted. Consequently, the following footnotes have been renumbered. • Footnotes for "Radiation Safety", "Sanitary Plumbing, Water Supply and Sewerage" and "Septic Tank Installations" updated.
Abbreviations and Symbols	
um	Corrected to "µm".
History of BCA Adoption	
7.0	Clause 7.0 and Table 7.0 have been added in order to set out the adoption dates of the 2009 edition of the BCA in each State and Territory and to summarise the purpose of the changes from BCA 2008.