

SUPERSEDED

Guide

to the **BCA**

Class 2 to Class 9 Buildings



ABC

Australian
Building
Codes
Board

SUPERSEDED

SUPERSEDED

GUIDE

Guide to the **BCA**

Class 2 to Class 9 Buildings



ABCB

Australian
Building
Codes
Board

SUPERSEDED

CONTENTS AND FEATURES

General Table of Contents

Introduction

GENERAL TABLE OF CONTENTS

	Page
Contents and Features	1
General Table of Contents	
Introduction	
A General Provisions	2,001
A0 Application	
A1 Interpretation	
A2 Acceptance of Design and Construction	
A3 Classifications of Buildings and Structures	
A4 United Buildings	
B Structure	4,001
B1 Structural Provisions	
C Fire Resistance	6,001
C1 Fire Resistance and Stability	
C2 Compartmentation and Separation	
C3 Protection of Openings	
D Access and Egress	10,001
D1 Provision for Escape	
D2 Construction of Exits	
D3 Access for People with Disabilities	
E Services and Equipment	13,001
E1 Fire-Fighting Equipment	
E2 Smoke Hazard Management	
E3 Lift Installations	
E4 Emergency Lighting, Exit Signs and Warning Systems	
F Health and Amenity	16,001
F1 Damp and Weatherproofing	
F2 Sanitary and Other Facilities	
F3 Room Sizes	

	Page
F4 Light and Ventilation	
F5 Sound Transmission and Insulation	
G Ancillary Provisions	19,001
G1 Minor Structures and Components	
G2 Heating Appliances, Fireplaces, Chimneys and Flues	
G3 Atrium Construction	
G4 Construction in Alpine Areas	
G5 Construction in Bushfire Prone Areas	
H Special Use Buildings	21,001
H1 Theatres, Stages and Public Halls	
I Maintenance	23,001
I1 Equipment and Safety Installations	
Filing Record	

INTRODUCTION

The Guide

The Guide to the Building Code of Australia (the Guide) is a companion manual to the Building Code of Australia 1996 (BCA). It is intended as a reference book for people seeking clarification, illustrations, or examples, of what are sometimes complex BCA provisions.

The two books should be read together. However, the comments in this Guide should not be taken to override the BCA. Unlike the BCA, which is adopted by legislation, this Guide is not called up into legislation. As its title suggests, it is for guidance only. Readers should note that States and Territories may have variations to BCA provisions. This Guide does not cover those variations. For advice on these matters contact your State or Territory building control administration.

This Guide covers only Volume One of the BCA and primarily deals with Class 2 to Class 9 buildings. Volume Two of the BCA contains guidance notes throughout and diagrams and hence is not included in the Guide. Provisions from previous versions of the BCA are occasionally referred to and are clearly marked 'BCA 1990'.

To assist readers, most of the information in this Guide — including section headings, abbreviations and symbols — is formatted as closely as possible to that in BCA.

Example

Imagine a developer or engineer etc — referred to in the Guide as the building proponent — with a query about the standards needed for the installation of electricity-supply systems. The first step is to record the details of the relevant BCA provision on electricity-supply systems and turn to the corresponding section in the Guide. To illustrate this: in the BCA, comments on electricity-supply systems are partly dealt with under **Section C - Fire Resistance (Clause C2.13)**. In the Guide, readers should turn to **Section C** for information. The Guide does not note all related clause numbers but only provides explanation to the clauses that may need elaboration.

Readers will also note that the BCA Deemed-to-Satisfy Provisions list only the minimum requirements that are acceptable as meeting the Performance Requirements.

The Guide generally explains the intent behind the provisions, and why building proponents, need to meet such standards. For example, the Guide clarifies why certain fire-resistance levels (FRLs) are required. It also assists readers by referring them to other related topics or sections in the Guide.

Not all the clauses and sub-clauses in the BCA are covered in the Guide. Those not dealt with have been found to be self-explanatory. The Guide contains a number of examples - some written, others in diagram form - which help illustrate provisions. These examples are not absolute, as they cannot take into account every possible permutation of a building proposal. Again, they are intended as a guide only. Other clauses of the BCA must be complied with.

The information in this Guide is provided by the Australian Building Codes Board (ABCB) and is intended as an information service primarily for building professionals. It is published in conjunction with CCH Australia Limited.

Because the Guide does not have regulatory force, neither the ABCB nor CCH Australia Ltd accept any responsibility for its contents when applied to specific buildings or any liability which may result from its use.

Performance-based regulatory system

The BCA Introduction gives a brief sketch of the new performance-based code's aims and content but it does not outline how it will work in practice. The main aim of the BCA is to maintain acceptable standards of building construction in Australia by promoting a performance-based BCA.

It describes how the building code is adopted by legislation and maintained by the ABCB. It explains the ABCB position in relation to governments, and how it is comprised of public officers and building industry representatives, a vital mix of private and public input. Assisting the ABCB on technical matters is its peak technical advisory body; the Building Codes Committee (BCC).

The BCA outlines what standards Australian buildings and building materials must adhere to in order to meet legislative requirements. This ensures our buildings are structurally sufficient and safe, and of benefit to the whole community.

There is a focus in the BCA on encouraging innovative alternative building solutions that comply with the code. This is because the ABCB wants to encourage cost effectiveness and accessibility within the building industry, while still maintaining optimum and safety-conscious standards.

Feedback

The Guide, as with the BCA, is under continual review and is amended as necessary every six months. Readers are invited to provide feedback to the ABCB Office on difficulties in understanding the Guide or where more information should be provided. The address is:

The Publications Officer
Australian Building Codes Board
GPO Box 9839
Canberra ACT 2601

How to use and File

The format and filing methods of the Guide are similar to that of the BCA. For information regarding these aspects refer to the BCA.

NOTE: Figures within the Guide have been prepared especially or taken from the BCA.

SECTION **A**

GENERAL PROVISIONS

- A0** **Application**
- A1** **Interpretation**
- A2** **Acceptance of Design and Construction**
- A3** **Classification of Buildings and Structures**
- A4** **United Buildings**

SECTION A CONTENTS

	Page
Part A0	2,021
Application	
A0.1	Adoption
A0.2	BCA Volumes
A0.3	BCA Structure
A0.4	Compliance with the BCA
A0.5	Meeting the Performance Requirements
A0.6	Objectives and Functional Statements
A0.7	Deemed-to-Satisfy Provisions
A0.8	Alternative Solutions
A0.9	Assessment Methods
Part A1	2,051
Interpretation	
A1.1	Definitions
A1.2	Adoption of Standards and other references
A1.3	Referenced Standards, etc
A1.4	Differences between referenced documents and the BCA
A1.5	Compliance with all Sections of BCA
A1.6	Application of the BCA to a particular State or Territory
A1.7	Language
Part A2	2,351
Acceptance of Design and Construction	
A2.1	Suitability of materials
A2.2	Evidence of suitability
A2.3	Fire-resistance of building elements
A2.4	Fire hazard properties
A2.5	Resistance to the incipient spread of fire
Part A3	2,401
Classification of Buildings and Structures	
A3.1	Principles of classification
A3.2	Classifications
A3.3	Multiple Classification
A3.4	Parts with more than one classification

	Page
Part A4	
United Buildings	2,551
A4.1	When buildings are united
A4.2	Alterations in a united building
Specifications	2,601
A1.3	Standards Adopted by Reference
A2.3	Fire-Resistance of Building Elements
A2.4	Fire Hazard Property Test for Assemblies

PART **A0** APPLICATION

A0.1 Adoption

Intent

To specify, as far as possible, the adoption date of Volume One of the BCA.

There are two ways States and Territories adopt the BCA. The majority of the State and Territory administrations adopt the BCA as it is amended from time-to-time and published by the ABCB, while the remaining Administrations need to amend their legislation each time an amendment is made to the BCA.

Some jurisdictions adopted the BCA96 on 1 July 1997. However, legislative timetables in other jurisdictions meant it was adopted on a later date. Refer to history of amendments in the BCA for the adoption dates of past amendments. Any queries on this matter should be referred to the relevant State/Territory body responsible for building regulatory legislation.

A0.2 BCA Volumes

Intent

To clarify the coverage of each Volume of the BCA.

BCA matters regarding Class 2–9 buildings are in Volume One of the BCA. Matters regarding Class 1 and generally Class 10 buildings are in Volume Two.

However, readers will occasionally come across subjects mentioned in both Volumes.

For instance, the BCA has no requirements regarding access or facilities for people with disabilities in Class 1 buildings. However, it requires access and facilities for people with disabilities in certain Class 10a buildings, eg public toilets in parks. These are included in Volume One.

Volume One also explains how access and facilities for people with disabilities are to be provided for certain Class 3–9 buildings.

Ordinarily, swimming pools and their fencing are classifiable as Class 10b buildings and are mainly attached to Class 1 buildings. However, they can be appurtenant to other buildings. Accordingly, the provisions regarding their construction are included in both Volumes One and Two (See Part **G1** of Volume One). Apart from access for people with disabilities and

swimming pools requirements, all other requirements for Class 10 buildings are found in Volume Two.

A0.3 BCA Structure

Intent

To clarify the structure of the BCA.

References to parts of the BCA hierarchy are often referred to in the BCA and the Guide. To make things easier, and to cut down on repetition, the hierarchy is explained here in some detail. There are four main parts to this hierarchy. They are BCA:

- **Objectives;**
- **Functional Statements;**
- **Performance Requirements;** and
- **Building Solutions** comprising;
 - **Deemed-to-Satisfy Provisions;** and
 - **Alternative Solutions.**

A0.4 Compliance with the BCA

Intent

To state how a Building Solution will comply with the BCA.

A **Building Solution** must achieve the **Performance Requirements** if it is to comply with the BCA.

A **Building Solution** may be partly a **Deemed-to-Satisfy Provision** and partly an **Alternative Solution**. However, no matter what method is chosen, building proponents need to always meet the **Performance Requirements** of the BCA.

A0.5 Meeting the Performance Requirements

Intent

To state how a Building Solution will achieve compliance with the Performance Requirements.

Performance Requirements outline the levels of accomplishment different buildings must attain. These requirements have been developed to meet both the BCA **Objectives** and **Functional Statements**. The **Performance Requirements** are the only BCA hierarchy levels where compliance is compulsory under building control legislation.

The means by which a building proponent complies with the BCA **Performance Requirements** is known as a **Building Solution**.

There are two main parts of a **Building Solution**: **Deemed-to-Satisfy Provisions** and **Alternative Solutions**.

A0.6 Objectives and Functional Statements

Intent

To state that the Objectives and Functional Statements are informative.

These levels of the hierarchy are informative only, and are included in the BCA to provide an aid to interpreting the content and intent of the **Performance Requirements** and the **Deemed-to-Satisfy Provisions**.

Objectives set out what the community expects of a building.

Functional Statements describe how it is proposed that the building will be designed and constructed to meet those community expectations.

A0.7 Deemed-to-Satisfy Provisions

Intent

To state that compliance with the Deemed-to-Satisfy Provisions is deemed to achieve compliance with the Performance Requirements.

Deemed-to-Satisfy Provisions make up the bulk of the BCA. If any designer, builder or the like, does not want to develop a new means of achieving **Performance Requirements**, they can choose to adopt one of the solutions known as **Deemed-to-Satisfy Provisions**.

A0.8 Alternative Solutions

Intent

To state the process for proving that an Alternative Solution complies with the BCA.

A building proponent may decide to meet the **Performance Requirements** via a route which is not included in a **Deemed-to-Satisfy Provision**. This is referred to as an **Alternative Solution**.

Options are available for people wishing to use **Alternative Solutions** to meet a **Performance Requirement**.

For example: building proponents who wish to know what has to be done to satisfy the fire-safety **Performance Requirements** of a particular building can either follow the **Deemed-to-Satisfy Provisions** or adhere to one of the proven **Alternative Solutions**. For **Alternative Solutions** they might, for example, refer to:

- the Fire Safety Guidelines (Edition 2001) published by the Australian Building Codes Board; or
- the Fire Brigade Intervention Model (FBIM) as developed by the Australasian Fire Authorities Council (AFAC) to assist with determining fire brigade response times.

Such alternative guidelines may be endorsed by the Board as appropriate and safe yardsticks.

They are examples of **Alternative Solutions** at work and demonstrate the flexibility of the BCA.

A0.9 Assessment Methods

Intent

To state the Assessment Methods to be used to prove whether or not a Building Solution achieves the Performance Requirements.

Assessment Methods are the means by which a building proponent proves that an application for a building permit meets all requirements.

BCA **Assessment Methods** include:

- a method which accords with the requirements of **A2.2**;
- a **Verification Method** listed in the BCA (refer to **CV1** and **CV2** in the BCA); or
- a **Verification Method** which is not listed in the BCA.

The third form of a **Verification Method** might include:

- calculations, using analytical methods or mathematical models;
- tests, using a technical procedure, either on site or in a laboratory, to directly measure the extent **Performance Requirements** are achieved; or
- any other method, including an inspection (and inspection report).

All **Verification Methods** must be acceptable to the appropriate authority.

Sometimes, **appropriate authorities** — such as the local council etc — also use **Assessment Methods** to determine whether an application has met all requirements. For instance, when processing a building permit, authorities might check to see that a qualified expert has offered an opinion, and, most importantly, found the application to comply with the BCA. This is just one of many options available to such authorities.

If a conflict arises between an applicant and an authority over an application, then the relevant

State or Territory body should be contacted.

You will notice that the BCA refers to **Applications and Limitations**. These terms are merely used to show when an **Objective, Functional Statement and Performance Requirement** applies or does not apply.

The term **‘to the degree necessary’** also appears frequently. This phrase is used to show that provisions can differ according to various elements which appropriate authorities may take into consideration when assessing building applications.

For instance, it could be argued that if the fire compartment of a building is quite small then perhaps it is not necessary to install a fire-hose reel system. This is borne out by the **Deemed-to-Satisfy Provision** of **E1.4** which states that such a system is only compulsory in a building having a floor area greater than 500m².

So, there are different ways of satisfying BCA requirements. Sometimes, however, the route to understanding compliance can be daunting and a little confusing. This Guide is intended to provide you with a better understanding of the BCA.

PART **A1** INTERPRETATION

A1.1 Definitions

Intent

To define the precise meaning of key words and expressions for the purposes of Volume One of the BCA.

Where a definition in the BCA has been considered to be self-explanatory, it has not been included in this guide.

Accessible

Used in provisions regarding access for people with disabilities. See Part **D3** and **F2.4**.

Accessway

A path of travel suitable for use by people with disabilities. It is an abbreviation from [AS 1428.1](#) which defines the term continuous accessible path of travel (accessway) and for non-ambulatory people, this accessible path shall not incorporate any step, stairway, turnstile, revolving door escalator or other impediment which would prevent it from being safely negotiated by people with disabilities.

Aged care building

The definition describes a residential building for the accommodation of the aged. These buildings are the homes of the residents. To be an aged care building the residents must be provided with personal care services and 24 hour assistance to evacuate. The definition applies to Class 9c aged care buildings. If a building does not satisfy the definition, then for BCA purposes it is not an aged care building and cannot be constructed as one. Such a building would potentially be an ordinary Class 3 or 9a building and would need to comply with the relevant provisions.

The BCA contains a number of specific provisions for Class 9c aged care buildings.

Alpine area

Areas generally subject to snow, or places where snow can add a significant load to buildings, or cause difficulties with egress. See [Figure G4.1](#).

Alternative Solution

See Part **A0**.

Assembly building

Describes buildings classifiable as Class 9b buildings. If a building is not included in the BCA list, it is not an assembly building.

Assessment Method

See Part **A0**.

Atrium and atrium well

An atrium can pose unique fire and smoke hazards. As such, the BCA lists **Deemed-to-Satisfy Provisions** for their construction.

An atrium is created by the connection of 2 or more storeys by an opening in the floor. It also includes the space not fire-separated from the rest of the building. The atrium well is that part extending through the openings in the floors. See **Figure A1.1(AT)**.

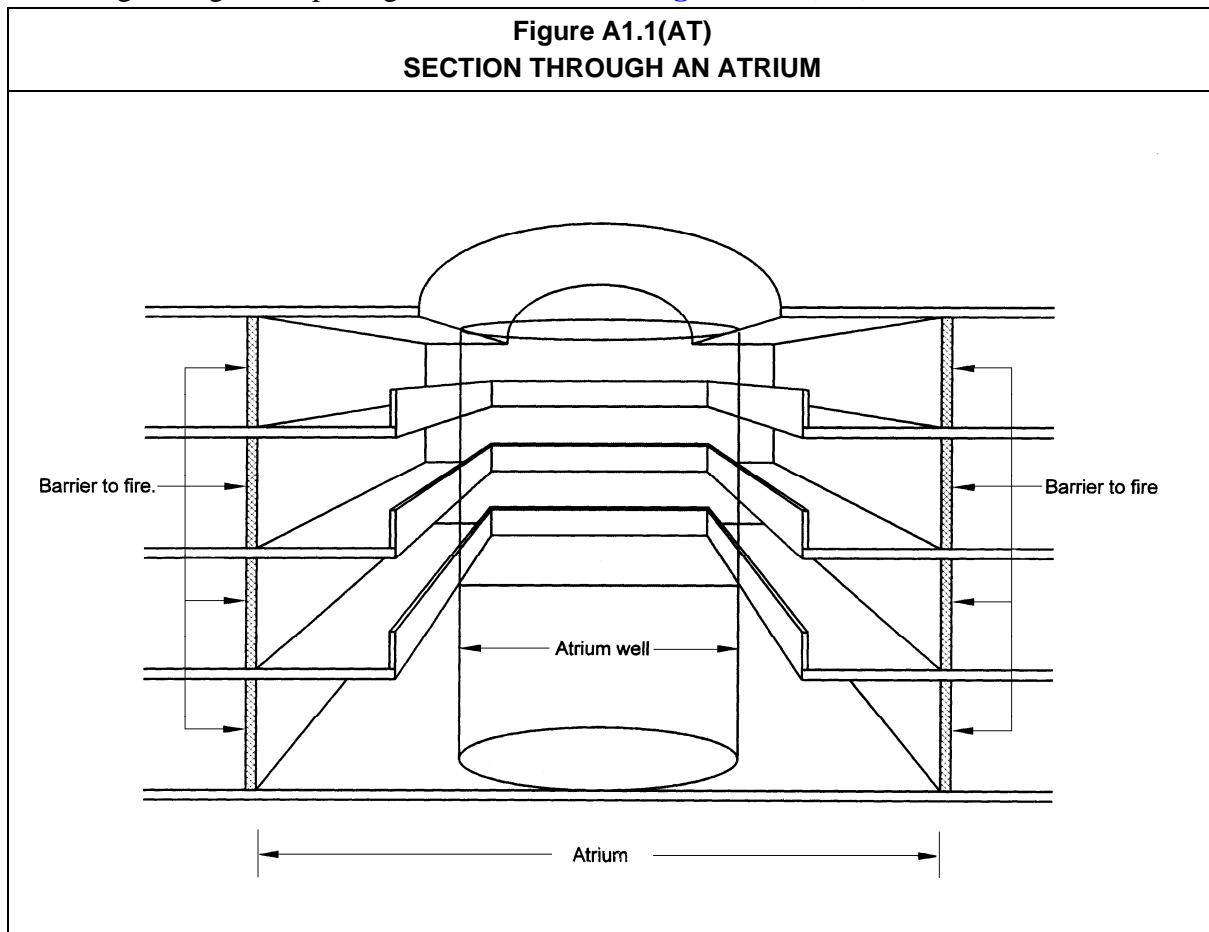

Average recurrence interval

Refers to a set number of years when a rainstorm of a particular intensity can statistically be expected to occur. If a 10-year period is set, the expected rainstorm would be less intense than if a 50-year period is set. Statistically, a heavier storm is more likely to occur every 50 years than every 10 years.

This term is used in the design of stormwater drainage systems. See **FP1.1** and **FP1.2**. Also refer to **AS 3500**, or *Australian Rainfall and Run-off*, published by the Institution of Engineers (Australia).

Backstage

A1.1

There are special provisions for backstage areas because of the high fire load posed by scenery and props.

Building Solution

See Part **A0**.

Carpark

A carpark can be a whole, or part, of a building. It is any building not associated with a Class 1 building and accommodates more than three vehicles on one storey. It is not a 'private garage'.

Example

A building could be a carpark if:

- it is either a stand-alone Class 7a building, or it is appurtenant to any other building (excluding a Class 1 building); or
- it is intended to park four-or-more trucks or other vehicles and it is not used for ancillary purposes other than a carpark.

Certificate of Accreditation

A Certificate of Accreditation is issued by a State or Territory accreditation authority and is evidence that a building material, method of construction or design (subject to any specified conditions or limitations) is accepted within that State or Territory as complying with the BCA. Certificates of Accreditation are no longer issued by the ABCB. Certificates issued by the ABCB under the previous scheme are no longer valid.

Certificate of Conformity

A Certificate of Conformity issued under the ABCB scheme is evidence that a building material, method of construction or design (subject to any specified conditions or limitations) is accepted within all States and Territories as complying with the BCA.

Combustible

A test done in accordance with [AS 1530.1](#) will determine if a material is combustible. If materials used in an assembly contain combustible components, then the assembly is combustible. See also **C2.12**.

Common wall

A common wall can be on one allotment or straddle a boundary. However, it must be common to adjoining buildings. Some jurisdictions consider a 'party wall' a common wall. See your building regulatory body. Where the expressions 'internal wall' and 'external wall' are used, they are specifically defined to exclude a 'common wall'.

Construction activity actions

This definition is used in **Part B** and only refers to construction activities that may have an effect on the final building design such as stacking of materials or floor to floor propping.

Curtain wall

A curtain wall is a facade fixed to the exterior of the building and may not be supported within frames at each storey. See **Panel Wall**.

Deemed-to-Satisfy Provisions

See Part **A0**.

Designated bushfire prone area

Bushfire prone areas may be designated by a power under legislation. See your building regulatory body.

Early childhood centre

Are also known as crèches and child care centres.

Effective height

Measures the height of a building for safety purposes. Effective height is measured from the lowest storey providing direct egress to a road or open space (this will usually be the level at which the fire brigade would enter) — to the floor of the top storey. Plant rooms and spaces at the top of the building used for maintenance purposes are not included in effective height. See **Figure A1.1(EH)**.

Figure A1.1(EH)
ELEVATION SHOWING EFFECTIVE HEIGHT OF A BUILDING

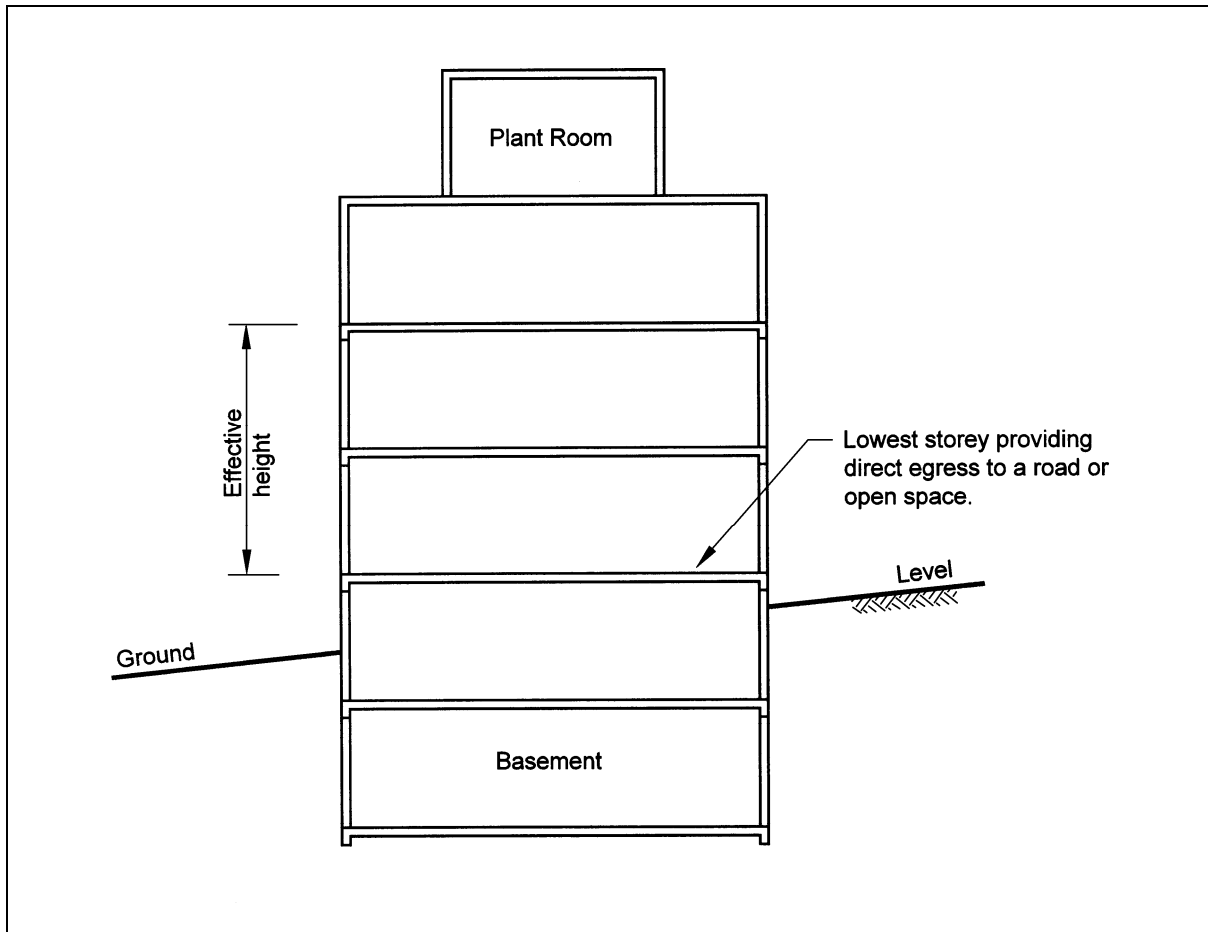

Equivalent

An **Alternative Solution** may achieve compliance with the **Performance Requirements** by achieving *equivalence* with the **Deemed-to-Satisfy Provisions**.

Evacuation route

The path a person uses to evacuate a building. It starts at the most remote part of a building and finishes at a 'safe place'. This can be in the building, or a road or open space. It is not always the point of exit from a building.

An evacuation route includes the evacuation path within a sole-occupancy unit of a Class 2 or Class 3 building or Class 4 part of a building, as well as an exit from such a unit. This term is different from a path of travel to an exit, which begins at the door to such sole-occupancy units.

Evacuation time

Is the calculated time from when an emergency begins until the last occupant reaches a 'safe place'.

It includes the time taken for any alarm to detect a fire and give warning. Added to this is the time taken for occupants to start to evacuate the building.

This 'time' will depend on a number of factors, some of which may be influenced by an 'emergency management system', including:

- the type of alarm or warning given;
- whether the occupant initially recognises the alarm or warning;
- whether the occupant decides to investigate or ignore the alarm;
- whether the occupant decides to warn other people in the building;
- the time taken for all occupants to move through the building until reaching a 'safe place'.

Exit

An exit can be any of the building elements listed. It must lead to a road or open space or a horizontal exit leading to another fire compartment.

An exit starts at the beginning of the first relevant building element listed in the definition.

Examples

The start of an exit includes:

- the top of the first riser in a required open stairway;
- the doorway leading into a required fire-isolated stairway, fire-isolated ramp or fire-isolated passageway; and
- a required doorway which leads directly to a road or open space.

The exit finishes when a person reaches, as the specific circumstances require:

- a road or open space;
- in the case of a horizontal exit, another fire compartment, which in turn leads to a road or open space; or
- in the case of a non-fire-isolated stairway or ramp, the level providing direct egress to a road or open space.

Expert Judgement

Expert judgement may be used to assess a **Building Solution** against the relevant **Performance Requirements**, or against the **Deemed-to-Satisfy Provisions** if use is being made of an equivalence **Assessment Method**.

External wall

An external wall is on the outside of a building and usually requires weatherproofing (**Part F1**).

It is possible for a wall to be partially an external wall and partially an internal wall. (See [Figure A1.1\(EW\)](#)). Where the expressions ‘internal wall’ and ‘external wall’ are used, they exclude a ‘common wall’.

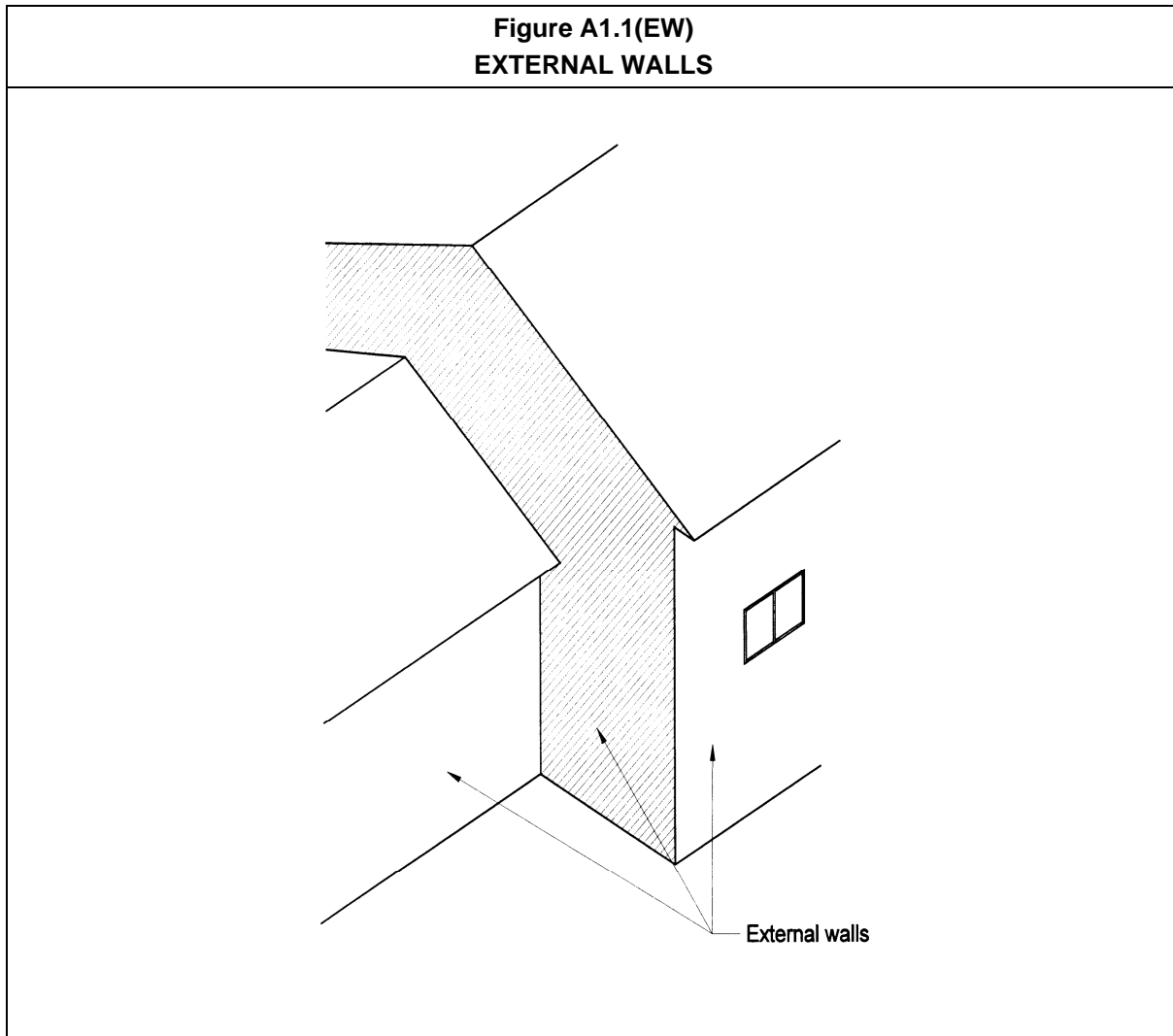

Fire brigade

This term only refers to statutory authorities established under an Act of Parliament having as one of its functions the protection of life and property from fire and other emergencies. It may be a professional brigade with full-time fire-fighters, or a volunteer brigade. Many companies employ their own private fire services. The standard of these private fire services varies greatly. They are excluded from the definition of a fire brigade.

Fire compartment

A fire compartment contains walls, floors and the like creating a compartment (or 'box') of any shape used to limit the spread of fire to another compartment or part of a building.

Example

If any floor has an opening for an open stairway or escalator, a fire could spread through the opening - that floor would not form the boundary of a fire compartment.

If there are no distinct fire barriers erected, then the whole building forms a fire compartment.

If an **Alternative Solution** is used, the building elements used to form a fire compartment must have appropriate fire separation from the remainder of the building as determined by fire engineering principles. Note that FRLs are only used in the **Deemed-to-Satisfy Provisions**.

If the **Deemed-to-Satisfy Provisions** of Part **C3** are used, the building element used to form a fire compartment must have the fire-resistance level (FRL) of a fire wall required by **Specification C1.1**.

Sole-occupancy units are not generally regarded as fire compartments except for **E1.4** for fire hose reels.

Fire-isolated passageway

A fire-isolated passageway protects people within a passageway from fire while evacuating. The whole passageway must be fire-protected from a fire outside the passage, including the floor, walls, ceiling, roof, any doors or other openings. The **Deemed-to-Satisfy Provisions** for fire-isolated passageways are in **D2.11**. The provisions relating to the protection of openings are in **C3.8**.

Fire-isolated ramp

See fire-isolated passageway.

Fire-isolated stairway

See fire-isolated passageway.

Fire-protective covering

While not fire rated, these elements have been found to provide nominal protection from the spread of fire of at least 20-30 minutes.

The BCA lists materials deemed to be fire-protective coverings. The fixing in each case must accord with normal trade practice. There must be no gaps at the joints in the sheets, and the joints must be sealed in the usual manner. Standard grade 10 mm or 13 mm plasterboard is not acceptable as a fire-protective covering.

Fire-resistance level (FRL)

Used only in the **Deemed-to-Satisfy Provisions**, the FRL of a building element is determined by conducting the Standard Fire Test on a prototype in accordance with [AS 1530.4](#).

Example

If the BCA requires a building element to have an FRL of 120/60/30, this means that the element must maintain, when tested in accordance with [AS 1530.4](#):

- structural adequacy for a period of 120 minutes;
- integrity for a period of 60 minutes; and
- insulation for a period of 30 minutes.

Fire-resisting

Applies to fire-resisting building elements, including structural members and non-loadbearing components, such as cladding, doors, windows and the like.

Fire safety system

These systems may be active systems, passive systems, or any combination of the two.

Examples

Some examples of fire safety systems:

Active systems

- early warning and intercommunication systems;
- emergency lighting;
- exit signs;
- sprinkler systems;
- fire hydrant systems;
- fire hose reel systems;
- smoke and heat vents;
- mechanical smoke-exhaust systems; and
- portable fire extinguishers.

Passive systems

- fire-isolated stairways, ramps and passageways;
- fire walls; and
- other fire-resisting building elements.

Fire-source feature

Used in **Deemed-to-Satisfy Provisions** to describe a possible fire source external to the building from which a fire could spread to the building. See **Figure A1.1(FSF)**.

A fire-source feature includes the far side of the road, and the side or rear boundary of an allotment. These represent the worst-case scenario for the spread of fire from another building. Even if a building on an adjacent allotment is set back from a boundary, the BCA assumes it could be demolished and another building constructed on the boundary.

Figure A1.1(FSF)
ALLOTMENT PLAN SHOWING FIRE-SOURCE FEATURES

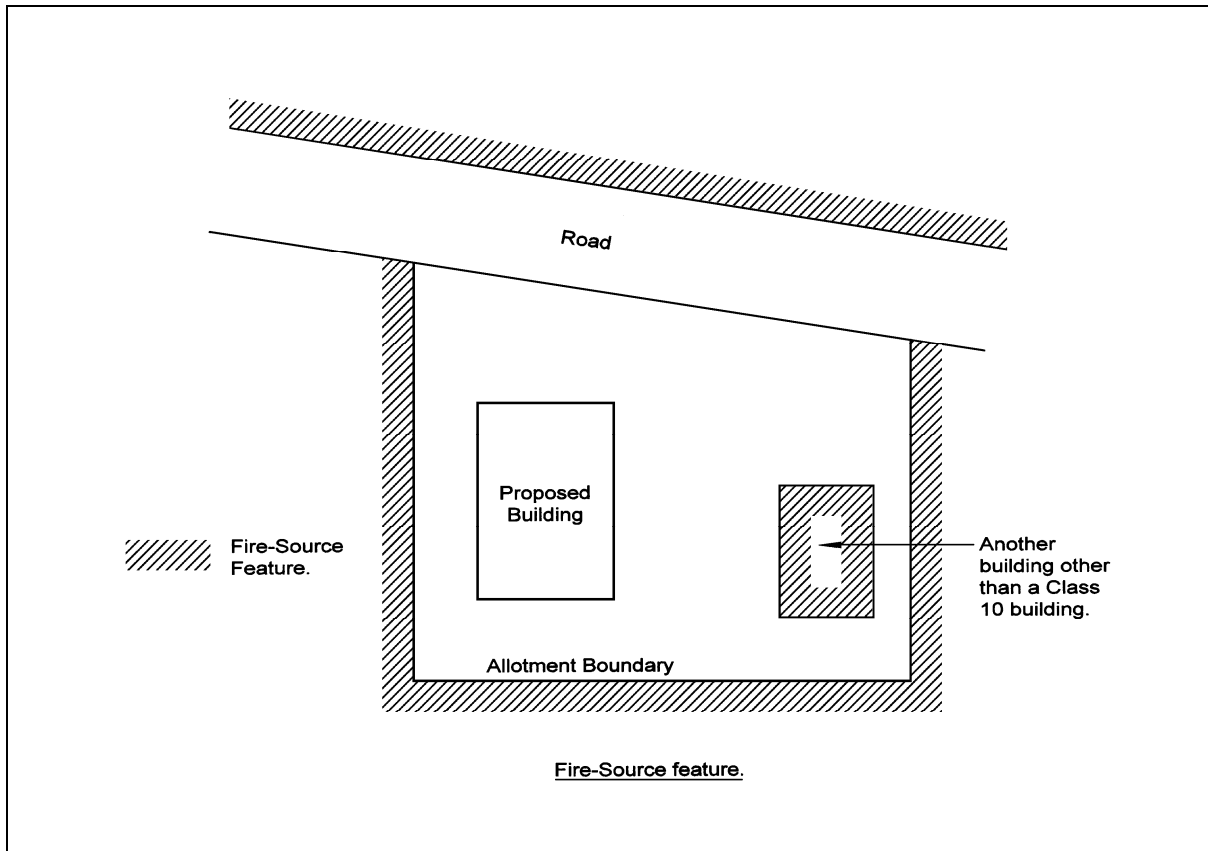

Note that the term ‘fire-source feature’ does not necessarily apply to a building - it relates to a potential source of fire. That potential may be realised in the future construction of a building. For this reason, the fire-source feature is not simply a line on the ground, nor a point at the top of a building; it is a continuous plane rising above that line or point.

In this sense:

- a line drawn out horizontally from a building to a fire-source feature will hit that feature; and
- form a 90° angle with a line drawn down from the point at which it hits the fire-source feature to the ground, or the top of the adjoining building.

However, some **Deemed-to-Satisfy Provisions** of the BCA limit the height above a building at which the fire-source feature remains active (see **Clause 2.1** of **Specification C1.1**).

The reason for the exclusion of Class 10 buildings on the same allotment is that they are generally small and have a low fire load.

Fire wall

Fire walls separate fire compartments. To avoid the spread of fire to another part of the building, a fire wall must extend from the fire-rated floor of a storey to the underside of the fire-rated floor above, or to a non-combustible roof covering.

A ‘fire-resisting’ wall is not necessarily a ‘fire wall’. A fire wall can sometimes be an external wall. See **C2.7** and **Figure C2.7(3)** of this Guide.

Flammability Index

A test performed in accordance with **AS 1530.2** will determine the flammability index of a material.

Flight

A flight is the part of a stairway that has a continuous slope created by the nosing line of the stair treads. Quarter landings are not considered part of a flight. However, winders are considered part of a flight. See **Figure A1.1(FLI)**.

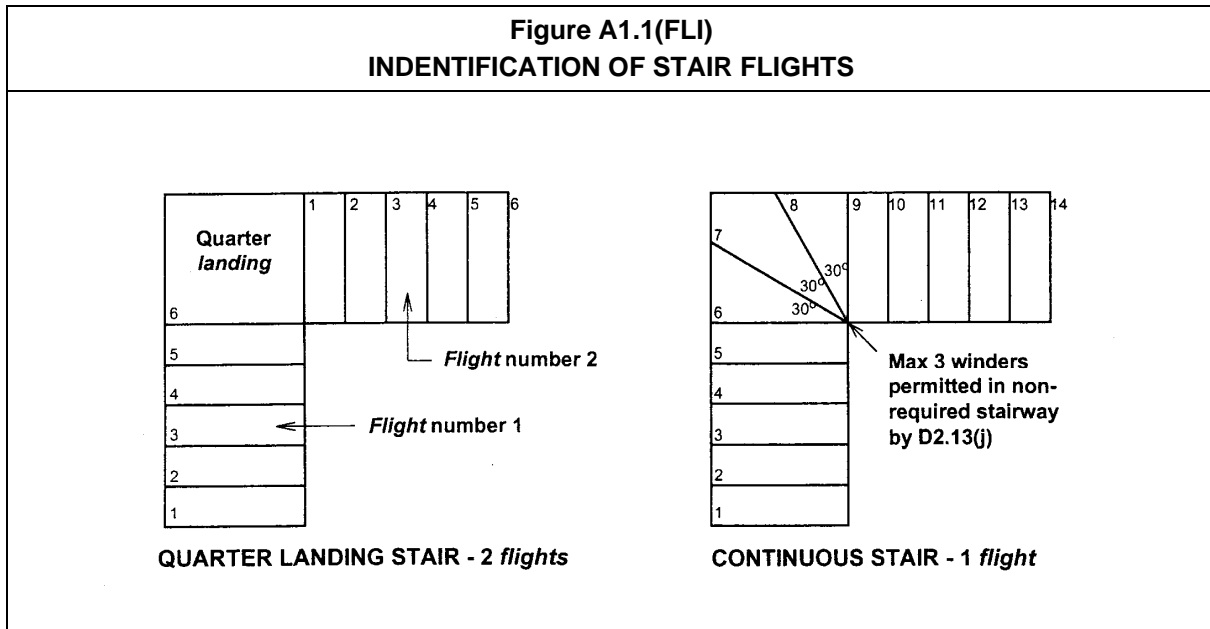

Floor area

When applied to a building or storey, the floor area includes all the space capable of being used. It includes any roofed area, canopy, verandah or covered walkway, etc.

Floor area is used in a number of different contexts in the BCA. It is therefore necessary to define each of these contexts:

- In relation to a building — the sum of the areas of all storeys.
- In relation to a storey — the floor area of the storey includes any enclosing walls. Where there is no enclosing wall in a part of a storey, those areas which may be used for storage, or other purposes, by occupants must be included as appropriate. It therefore includes any roofed area, including a canopy, verandah or covered way if it contributes to the functioning of the building. Internal walls, columns, shafts or the like are not deducted.

See **Figure A1.1(FA)(1)**.

- In relation to a room — the bounding walls determine the limits of the floor area. Internal walls, columns or the like are not deducted. See **Figure A1.1(FA)(2)**.
- In relation to a fire compartment — the fire compartment may not be bounded by walls in all places. If this is the case and a roofed area contributes to the fire load, it should be considered as part of the floor area. See **Figure A1.1(FA)(3)**.
- In relation to an atrium — see **Figure A1.1(FA)(4)**.

Figure A1.1(FA)(1)
PLAN SHOWING FLOOR AREA OF A STOREY

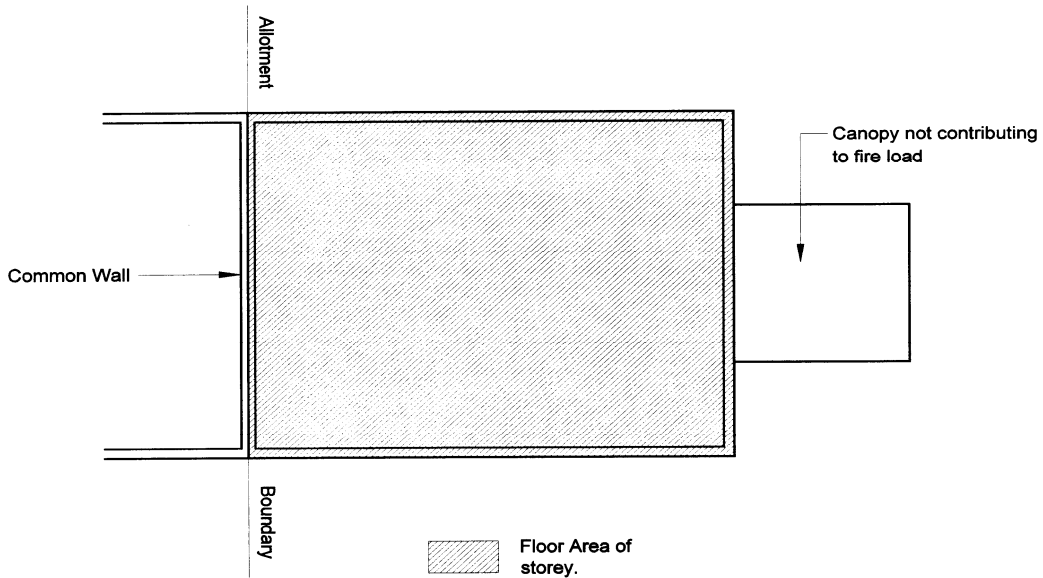

Figure A1.1(FA)(2)
PLAN SHOWING FLOOR AREA OF A ROOM

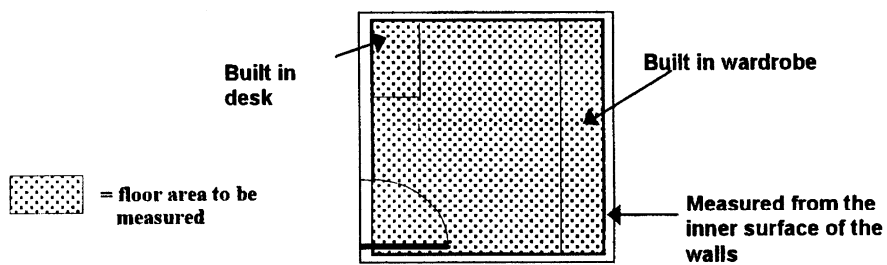
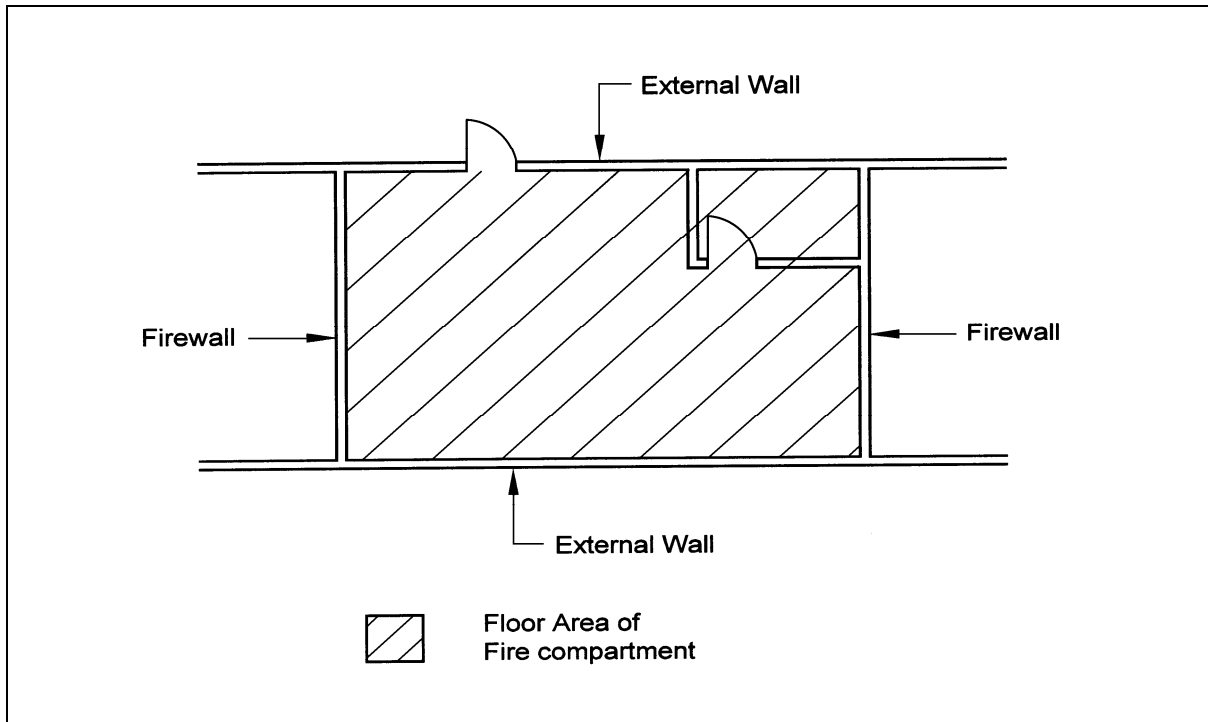

Figure A1.1(FA)(3)
PLAN SHOWING FLOOR AREA OF A FIRE COMPARTMENT



Functional Statement

See Part **A0**.

Habitable room

Only applies to Class 2 and Class 3 buildings and Class 4 parts of buildings.

Health-care building

Used in the classification of a Class 9a building. It refers to buildings needing special evacuation requirements, because some occupants may need to be assisted during an emergency evacuation.

Health-care buildings include day-care surgeries or procedure units. They are distinguished from a doctor's or dentist's surgery, because if an evacuation became necessary in these places, patients would probably not need assistance in evacuating.

In a health-care building, patients may be incapable of movement, and require the assistance of another person to evacuate. They might also require medical supervision for a while after treatment.

Health-care buildings are not to be interpreted to include aged care buildings. It should be noted that the BCA contains differing requirements for Class 9a health-care buildings and Class 9c aged care buildings.

Illuminance

Used only in the **Performance Requirements** of Part **F4** to describe the amount of natural and artificial light required for a building.

The test under [AS 1530.4](#) considers that a building element has failed the integrity criterion when either the element collapses, or the element develops cracks, fissures or other openings through which flames or hot gases can pass.

Internal wall

All walls that are not external walls are internal walls.

Lightweight construction

The BCA lists building materials of ‘lightweight construction’. These materials need protection to preserve their integrity from fire and other damage. This is because they are more susceptible to damage than other forms of fire protection. For example, masonry thicker than 70mm and materials like concrete, which typically do not contain soft materials, are not deemed to be lightweight construction. See [C1.8](#) and [Specification C1.8](#).

Mezzanine

A ‘mezzanine’ must be part of a room. If an intermediate floor is enclosed by a wall it is no longer within another room, and is therefore no longer a mezzanine. Such rooms are sometimes called ‘mezzanines’ by the layperson. This does not mean they are classified as such by the BCA. See [Figure A1.1\(ME\)](#).

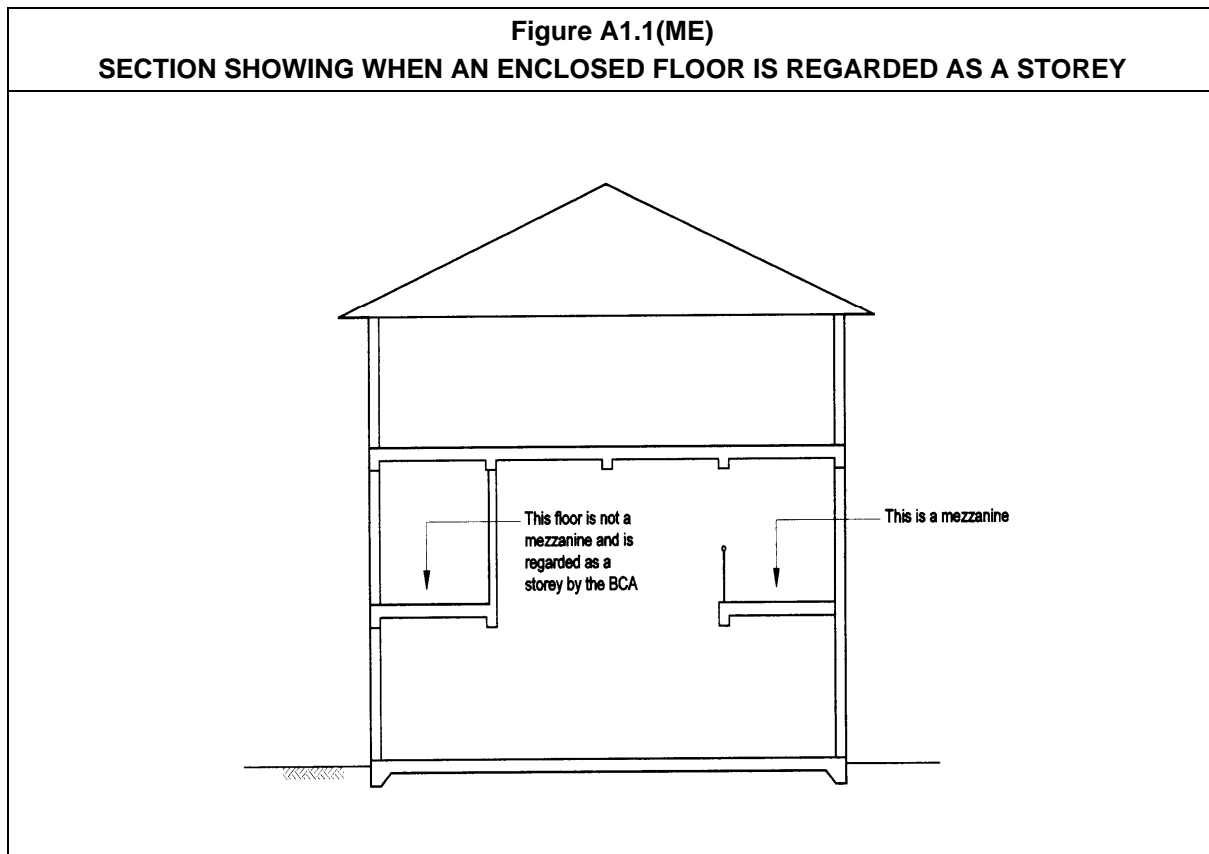

Objective

See Part **A0**.

Open-deck carpark

The **Deemed-to-Satisfy Provisions** contain a number of concessions for open-deck carparks. The concessions are based on the amount of natural ventilation available. Ventilation is needed for the dissipation of car fumes and also for heat and smoke during a fire. An open-deck carpark may be a whole, or part, of a building.

Open space

Egress from a building must be to a road or open space. An open space must be open to the sky and connect directly to a public road. See **D2.12**.

Open spectator stand

Traditionally called a 'grandstand'. The **Deemed-to-Satisfy Provisions** contain a number of concessions for open spectator stands. Concessions are based on the amount of natural ventilation, at the front of these stands, during a fire. They may be a whole, or part, of a building.

Other property

Used to describe nearby buildings and land requiring protection for structural, fire or drainage reasons. The purpose of including a road as part of 'other property' is that in certain parts of the BCA, a road, or the people using it, may need protection.

Example

The BCA takes into consideration protection from collapse of a building or any part of it on to the road, and in some States and Territories protection from collapse of a road into a building/construction excavation.

Panel wall

The difference between a panel wall and a curtain wall is that a panel wall is supported at each storey, and a curtain wall is not.

Patient-care area

Includes 'ward areas' and 'treatment areas'.

Performance Requirement

See Part **A0**.

Personal care service

Personal care services include any combination of the listed services. The definition is used in defining an aged care building. (See comments on the definition of **aged care building**).

Primary building element

Those materials and constructions subject to attack by termites causing structural problems. This includes stairs and ramps. Excluded are building elements which provide bracing to a wall, but this is not designed as part of their function. An example would be plasterboard not required for bracing or an external cladding.

Private garage

To be classified as a private garage (and therefore a Class 10a building or part), a structure can only accommodate a maximum of three vehicles, unless the garage is associated with a Class 1 building.

A building designed to accommodate three-or-less vehicles carries a comparatively low fire load, even if used commercially. Thus, there is not much difference between the fire risk from a domestic private garage and one used commercially.

If a garage is not associated with a Class 1 building, and accommodates more than three vehicles, it is a carpark and therefore a Class 7 building or part.

Professional engineer

Includes a professional engineer eligible for registration with the Institution of Engineers (Australia) under classification NPER3. Some States and Territories define 'professional engineer' differently. Such definitions override the BCA definition.

Public corridor

Not all corridors and hallways are public corridors. A public corridor must be enclosed and provide egress from more than one sole-occupancy unit. Examples include passages leading from hotel suites, lift lobbies and foyers in high-rise buildings. Public corridors can be required to provide egress to a required exit.

Registered Testing Authority

A Registered Testing Authority is an organisation authorised to give an opinion on the use of a material, construction or design.

Registered Testing Authorities include: the National Building Technology Centre (NBTC) and the CSIRO Division of Building, Construction and Engineering (DBC&E).

The NBTC replaces the Experimental Building Station (EBS), and is now run by the CSIRO. EBS and NBTC documentation is still acceptable, if current.

Authorities are registered by the National Association of Testing Authorities (NATA). NATA publishes a directory explaining which authorities are registered to carry out what tests. International organisations are also recognised by NATA; a directory also details these organisations.

Required

When used in the **Performance Requirements**, the term means required to meet the **Performance Requirement**. When used in the **Deemed-to-Satisfy Provisions**, it means required to meet those provisions.

Residential aged-care building

Applies only to buildings housing residents with mental or physical impairments caused by the ageing process. Such impairments require that patients need assistance in their daily lives.

People are employed to assist and care for these residents. Hence, the building requirements aim to provide a more amenable environment for the residents.

The definition applies to Class 3 and Class 9a buildings. The BCA contains a number of concessions for Class 3 residential aged-care buildings. See **C3.11** and **Specification C1.1**.

Resident use area

Only applies to Class 9c buildings.

Resistance to the incipient spread of fire

Refers to the ability of a ceiling to prevent the spread of fire and thermally insulate the space between the ceiling and the roof, or floor above. 'Resistance to the incipient spread of fire' is superior to 'fire-resistance' because it requires a higher standard of heat insulation. Refer to [AS 1530.4](#).

Rise in storeys

C1.2 describes how to calculate the rise in storeys.

Safe place

A safe place provides a final refuge from a fire, such as a road or open space at the end of an exit. It can also be a temporary 'haven' or 'refuge' to protect people while they are evacuating during a fire. The term is only used in the **Performance Requirements**. Safe places can be inside or outside a building, and must provide a person with protection from a fire and then allow them to safely escape to a road or open space.

Example

- fire-isolated stairways;
- fire-isolated ramps;
- fire-isolated passageways; and
- an adjacent fire compartment.

Self-closing

Applies to doors which are smoke or fire doors and the like. In each case it is important that the doors be fitted with a device that immediately closes them after manual opening, and keeps them closed to stop the spread of fire and/or smoke during a fire situation.

Service station

An outlet which sells petrol and has an area for servicing motor vehicles. The whole service station can be classified as a Class 6 building. The definition also applies to a car dealership which contains an area for the servicing of vehicles.

Shaft

The definition includes the top and bottom as well as the walls.

Smoke-and-heat vent

Can be automatically opened as necessary, or permanently fixed open. See Parts **C2** and **E2**.

Smoke-Developed Index

A test in accordance with [AS/NZS 1530.3](#) determines the Smoke-Developed Index of a material. The index is based on a logarithmic scale of 0 to 10. A lower index number indicates better performance.

Sole-occupancy unit

A sole-occupancy unit is an area within a building for the exclusive use of the occupier. It is irrelevant if the area is occupied by an individual, or by two or more people, or by a company.

Example

Examples of sole-occupancy units include individual flats in a block of flats; a suite or unit in a hotel or motel; bedrooms in an aged care building; a shop in a shopping centre; and an office occupied by an individual owner or tenant in an office building.

Areas that do not comprise a sole-occupancy unit are those intended and available for the use of more than one tenant (what is often called a ‘common space’). Examples include a laundry; TV room; entertainment room; and kitchen in a block of flats or a boarding house.

Spread-of-Flame Index

A test in accordance with [AS/NZS 1530.3](#) determines the Spread-of-Flame Index of a material. The index is based on a logarithmic scale of 0 to 10. A lower index number indicates better performance.

Standard Fire Test

[AS 1530.4](#) contains details of the Standard Fire Test. The test is used to determine the FRL of a building element. The results are recorded in order as: structural adequacy, integrity and insulation.

Storey

Figure A1.1(ST) illustrates that a storey extends from the floor level of the subject area to the floor level above, or, if the storey is at the top of the building, to the ceiling or roof. It is not unusual for people to simply regard the ceiling or the bottom of the storey above as the top of a storey.

The listed exceptions for a storey are normally small areas with a low fire load and low occupation.

Structural adequacy

Structural adequacy is the first criterion used when specifying an FRL. It is used only in relation to the FRL of a building element. See the example under ‘insulation’ definition.

Figure A1.1(ST)
SECTION SHOWING STOREYS IN A BUILDING

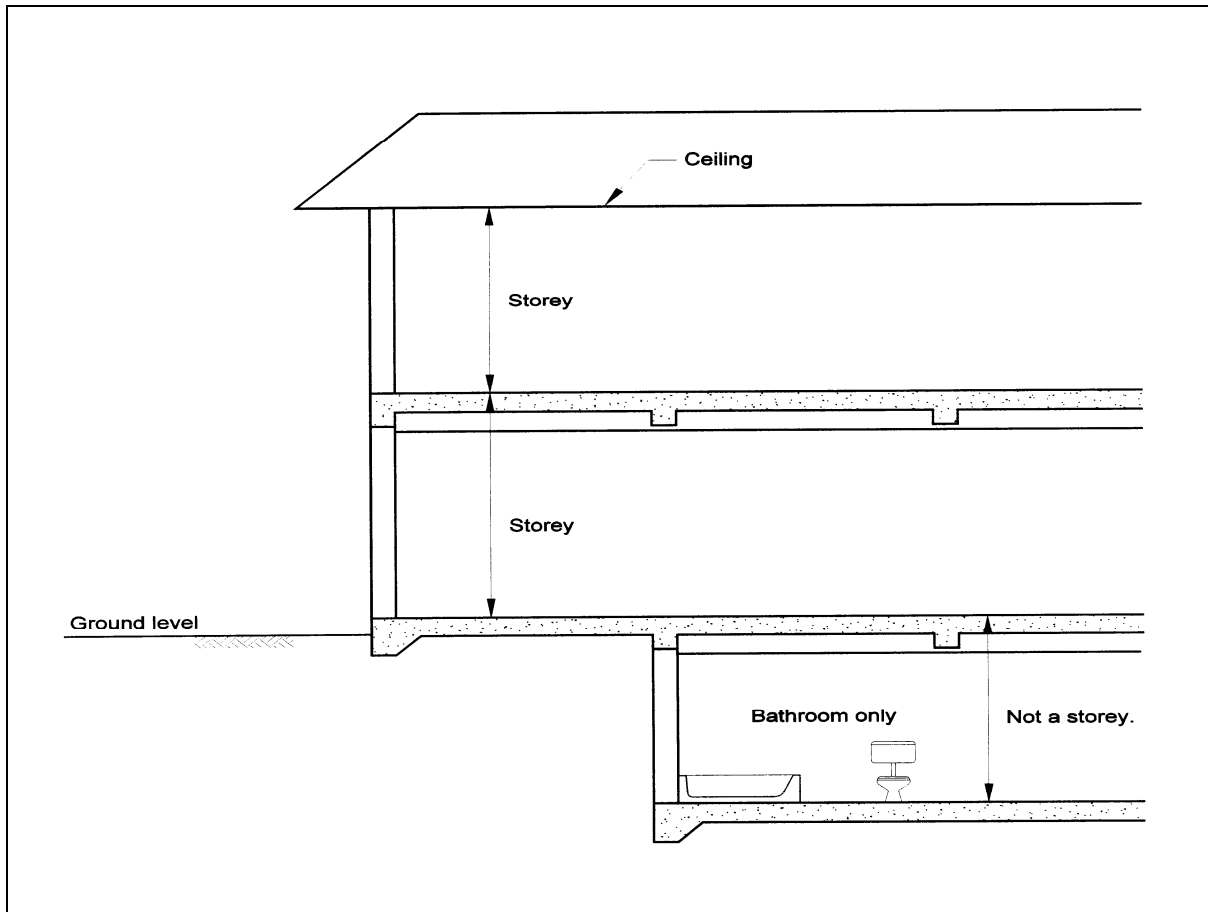

Swimming pool

Applies to swimming and wading pools, and spas (excluding units such as spa baths emptied after each use). For provisions see Part **G1**. These provisions do not apply to all swimming pools.

Treatment area

Part of a 'patient-care area'. In a treatment area, a patient undergoes treatment (eg an operation), which may result in the patient being unable to evacuate without assistance in an emergency such as a fire.

Verification Method

See Part **A0**.

Ward area

Part of a 'patient-care area'. It includes a hospital or nursing-home ward and the nursing stations associated with such wards. Also, any associated living areas, such as bath and shower rooms, toilets, TV rooms, activity rooms and the like.

Window

A window must be capable of allowing light into a building, even when closed. Any transparent or translucent glass pane, brick or block, or a roof light or the like, is a window.

A1.2 Adoption of Standards and other references

Intent

To indicate the elements of any referenced documents which are not included as part of the adoption process.

A1.2 only applies to the **Deemed-to-Satisfy Provisions** of the BCA.

A1.2 means that contractual matters or clauses defining responsibilities of various parties, and matters in Australian Standards or other codes not appropriate for adoption in the BCA are not included when a standard is called up in a **Deemed-to-Satisfy Provision**.

A1.3 Referenced Standards, etc

Intent

To specify that the editions or issues of referenced documents adopted by the BCA are those listed in **Specification A1.3**, to the extent stated in the Specification.

Specification A1.3 is only mandatory to **Deemed-to-Satisfy Provisions**. However, referenced documents are only applicable to the BCA provision that references the document.

A building proponent undertaking an **Alternative Solution** can use any element or edition of any document, if they help satisfy the **Performance Requirements**. They do not need to use the documents listed in **Specification A1.3**.

Specification A1.3 lists the specific edition of the Standard or other document adopted, including any amendments considered appropriate for the **Deemed-to-Satisfy Provisions**. Other editions of (or amendments to) the referenced document are not adopted, and have no standing under the BCA.

A1.4 Differences between referenced documents and the BCA

Intent

To state that the provisions of the BCA take precedence over any referenced document, such as an Australian Standard.

The following is the precedence, or pecking order, for documents used in the building regulatory system. Any State or Territory Act or regulation which adopts the BCA takes precedence over any BCA provision. The BCA, in turn, takes precedence over any referenced document.

A1.5 Compliance with all Sections of BCA

Intent

To specify that all Class 2-9 buildings must comply with all the relevant provisions of the BCA, as specified in the BCA.

All the provisions that apply to a particular building must be satisfied. Relevant exemptions and limitations are noted within the BCA provisions. See [A1.6](#).

A1.6 Application of the BCA to a particular State or Territory

Intent

To detail what the BCA is comprised of in each State and Territory.

State and Territory variations and additions are part of the BCA and are included as an Appendix to the BCA.

A1.7 Language

Intent

To state the meaning of certain specified expressions.

When the BCA refers to a building, that reference can be to the whole, or any part, of the building. Whether this provision applies depends on the circumstances of that case.

Example

A hotel (Class 3) built in conjunction with offices (Class 5), as can often be the case with large hotel developments in central city areas. In this case a decision must be made as to whether the whole building is Class 3. This would usually be the case if the office component

A is less than 10% of the floor area of the particular storey the remainder of which is a Class 3. Once the classification is determined, the BCA provisions for that classification are applied.

number of the **Performance Requirements** of the BCA use the expression '**to the degree necessary**'. This expression provides flexibility by allowing appropriate authorities to determine the degree of compliance necessary in a particular case.

For example, an authority might judge that an item need not be installed, or a particular level of performance be achieved. The expression is often supported by examples in this Guide.

PART **A2** ACCEPTANCE OF DESIGN AND CONSTRUCTION

A2.1 Suitability of materials

Intent

To explain the quality of work and materials needed to construct a building to meet BCA requirements.

A building must meet BCA requirements. This means that:

- all people involved with construction must work skilfully in accordance with good trade practice; and
- all materials must be of a quality to fulfil their function/s within the building.

A2.1 only applies to matters normally covered by the BCA.

Example

Permit authorities would ordinarily not apply **A2.1** to such matters as:

- plastering — other than for fire rating, water proofing of wet areas, and noise insulation; or
- painting — other than that required for weatherproofing an external wall.

While **A2.1** outlines quality of work and material demands, sometimes additional conditions may be required by:

- other Commonwealth, State or Territory legislation; and
- contracts that include either specific quality requirements, or requirements for specific materials and the like.

A2.2 Evidence of suitability

Intent

To detail evidence which may support a claim that a material, construction or design achieves a Performance Requirement or Deemed-to-Satisfy Provision.

A2.2 is subject to compliance with **A2.3** and **A2.4**.

Fire-resistance level — A2.3

If a proposal uses a **Deemed-to-Satisfy Provision** which requires a building element to have an FRL, then **A2.2** may be used to provide evidence to support the proposal. However this alone is not enough. The FRL must be determined in accordance with **Specification A2.3**.

Early Fire Hazard Index — A2.4

If a proposal uses a **Deemed-to-Satisfy Provision** which requires a building element to have an Early Fire Hazard Index, then **A2.2** may be used to provide evidence to support the proposal. Again, this alone is not enough. In this case, the Early Fire Hazard Index must be determined in accordance with **Specification A2.4**.

A2.2 represents the minimum level of documentary evidence needed to show that a material, construction or design meets BCA requirements. There will be times when this evidence will need to be produced and sighted. The evidence can be required by:

- an appropriate authority;
- a party to a construction contract; or
- a person certifying compliance with the BCA.

There is an onus, on any party submitting such evidence, to clearly indicate what is required from that evidence. If a building proponent does not produce exactly what is required, the evidence may be rejected.

Sources of supporting evidence

There are several specifically named sources of evidence available for use. However, other sources of evidence may be used if the appropriate authority is satisfied that they are suitable.

Registered Testing Authority — A2.2(a)(i)

This source of evidence relates to materials or construction.

A report from this source must:

- show that the material or construction has been submitted to specifically listed tests;
- set out the test results; and
- include any other information which demonstrates that the subject of the report is suitable for use.

Certificates of Conformity or Accreditation — A2.2(a)(ii)

This source of evidence applies to materials, construction and designs.

Certificates issued by the ABCB are called Certificates of Conformity. They are issued for building products and systems deemed in accordance with the BCA. Certificates must be current and are not acceptable if expired.

Certification and accreditation authorities issue Certificates of Conformity or Accreditation. They are the basis of detailed technical evidence that the material, construction or design complies with BCA provisions.

Certificates may be for known building products, constructions, designs or new and innovative systems.

Professional engineer — **A2.2(a)(iii)**

Evidence gained from this source applies to materials, construction and designs.

Approval can be gained by:

- a professional engineer, as defined in the BCA, who is required to have ‘appropriate experience and competence’; or
- any other person who is ‘appropriately’ qualified.

In both cases, the term ‘appropriately’ means a person whose qualifications satisfy an appropriate authority.

(Where evidence is requested by another party under a contract, ‘appropriate’ means in the opinion of that party).

The engineer or technical person should have suitable experience in the area/s being tested. For example, it would not be acceptable for a structural engineer to report on a mechanical ventilation matter. A recently graduated engineer would not report on a complex structural matter concerning a high-rise city building.

The Joint Accreditation System of Australia and New Zealand — **A2.2(a)(iv)**

This source of evidence applies to materials, construction and designs. JAS-ANZ, as it is known, is the peak organisation for the accreditation of third-party certification bodies.

A certificate of conformity issued by any group (including Standards Australia) that bears accreditation from JAS-ANZ is an acceptable form of evidence.

The Scientific Services Laboratory (SSL) — **A2.2(a)(v)**

The SSL tests and accredits fire-safety products. It keeps a register of these products. Appropriate authorities may request a current SSL Product Listing Data Sheet as part of a request under **A2.2**.

A2.2(a)(vi) allows for the use of alternative forms of documentary evidence to those included in **A2.2**, as long as they comply with certain specified conditions.

An example of this arises when an authority carries out an inspection of a building site. The inspection alone would not be acceptable as evidence. However, if the authority compiled a written report of the inspection then it may comply with the requirements of **A2.2(a)(vi)**.

All copies of documents provided as evidence must be unabridged copies of the originals. No part can be left incomplete.

A2.3 Fire-resistance of building elements

Intent

To state that, for the purposes of the Deemed-to-Satisfy Provisions, **Specification A2.3** must be used to provide a basis for determining the fire-resistance level (FRL) of a building element.

See section titled Suitability of materials **A2.2**. Refer to comments on fire-resistance of building elements.

A2.4 Fire hazard properties

Intent

To state that, for the purposes of the Deemed-to-Satisfy Provisions, **Specification A2.4** must be used to provide a basis for determining fire hazard properties.

See section titled Suitability of materials **A2.2**. Refer to comments on fire hazard properties which includes:

- Flammability Index.
- Spread-of-Flame Index.
- Smoke-Developed Index.

A2.5 Resistance to the incipient spread of fire

Intent

To establish, for the purposes of the Deemed-to-Satisfy Provisions, the method of determining the resistance to the incipient spread of fire.

The Deemed-to-Satisfy Provisions of the BCA contain a number of provisions requiring a ceiling to have a resistance to the incipient spread of fire to the space above itself. This provision sets out the method of determining the incipient spread of fire. The method is based on the method of determining the FRL of a building element and use of the Standard Fire Test.

PART **A3** CLASSIFICATION OF BUILDINGS AND STRUCTURES

A3.1 Principles of classification

Intent

To state the basis of any decision regarding the classification of a building or part of a building.

The use of a building determines its classification. Use is determined on the basis of its design, construction or adaptation.

A3.2 Classifications

Intent

To categorise buildings of similar risk levels based on use, hazard and occupancy.

Classification is a process for understanding risks in a building or part, according to its use. It must be correctly undertaken to achieve BCA aims as appropriate to each building in each circumstance.

It is possible for a single building to have parts with different classifications. Part of a building can also have more than one classification. Where there is any conflict between what requirements the part should comply with, the more stringent requirement applies.

Where it is unclear which classification should apply, appropriate authorities have the discretion to decide. They base their decision on an assessment of the building proposal.

They will look at what classification the building most closely resembles. They will also take into account the likely fire load. Plus, the likely consequences of any risks to the safety, health and amenity of people using the building.

Appropriate authorities will also look at any relevant court decisions or determinations of the State or Territory body responsible for considering appeals on building classification matters.

It should be noted that appeals body determinations and, in some States and Territories, certain court decisions are usually not precedent creating. Such decisions are determined on a case-by-case basis.

Class 1

Class 1 buildings are covered in Volume Two of the BCA. While this Guide does not address Volume Two, for purposes of clarity, Class 1 and Class 10 buildings are briefly explained here. Class 1 buildings are not located above or below another dwelling, or another class of building other than a private garage.

A sole-occupancy unit used for residential purposes located over another sole-occupancy unit used for residential purposes will always be a Class 2 or Class 3 building (depending on the circumstances). It cannot be a Class 1 building.

A single Class 1 dwelling can be made up of more than one building. For example, it may include what is ordinarily called a house, plus one or more habitable ‘outbuildings’ such as sleepouts. (Note that a habitable building such as a sleepout cannot be classified as a Class 10 building).

The height or number of storeys of a Class 1 building makes no difference to its classification. The separating wall between adjoining Class 1 dwellings must start from the ground level.

Class 1b

A Class 1b building is a small guesthouse, boarding house or the like. Guest, boarding, or lodging houses which do not meet the criteria for a Class 1b building are classifiable as Class 3 buildings.

The Class 1b classification can attract concessions applicable to Class 3 buildings. These concessions allow people to rent out rooms in a house, or run a bed and breakfast, without having to comply with the more stringent Class 3 requirements.

The reasoning is that the smaller size of the building and its lower number of occupants represents reduced fire risks.

Apart from their use, the primary difference between Class 1a and Class 1b buildings is that the latter is required to have a greater number of smoke detectors. These differences are set out in Volume 2 of the BCA.

Class 2

A Class 2 building is one which includes more than one dwelling, each of which is generally solely occupied by one or more people to the exclusion of others.

Such buildings must not be otherwise classified as a Class 1 or Class 3 building or Class 4 part. See [Figure A3.2\(1\)](#) for some configurations of Class 1 and Class 2 buildings.

Where a sole-occupancy residential unit is located above another sole-occupancy residential unit, the building containing the units can be either a Class 2 or a Class 3 building, depending on the other circumstances of the building proposal.

Class 2 buildings can be single storey attached dwellings. Where there is any common space below such dwellings, they are Class 2 (and cannot be Class 1) irrespective of whether the space below is a storey or not (see [Figure A3.2\(2\)](#)).

Class 2 buildings can be attached to buildings of another Class. The attached Class 2 buildings need not be attached to one another, and need not be more than a single storey.

When two or more dwellings are attached to another Class, they cannot be Class 4 parts, as any building can only contain one Class 4 dwelling.

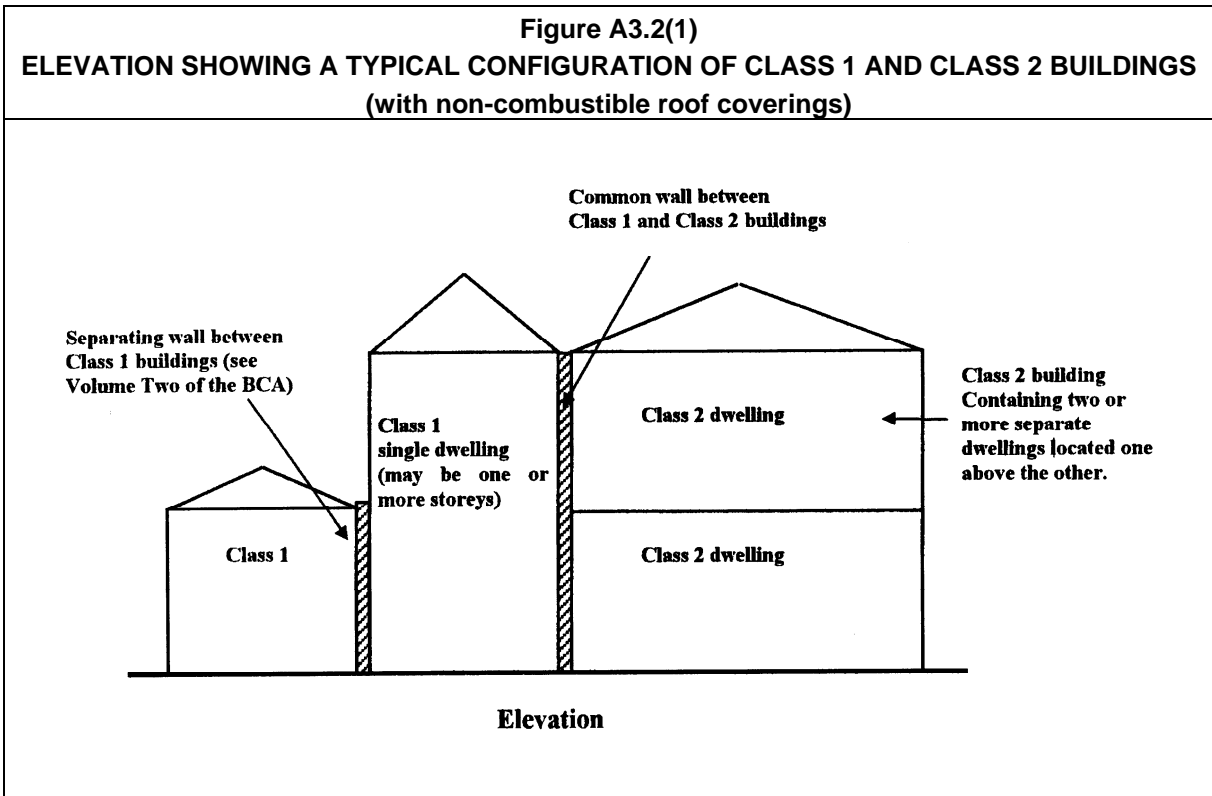

Class 3

Class 3 buildings provide accommodation for unrelated people. The length of stay is unimportant.

Some exceptions to this classification include: certain bed and breakfast accommodation, boarding houses, guest houses, hostels, or lodging houses and the like which fall within the concession provided for Class 1b buildings.

Also, any sized building can be classified as Class 1 or Class 2 if it is used to house any number of unrelated people who jointly own or rent it, or share it on a non-rental basis with an owner or tenant.

It is not unusual for a manager's, owner's or caretaker's dwelling attached to a Class 3 building to be thought of as a Class 4 part of the Class 3 building. However, a Class 4 part of a building can only be part of a Class 5-9 building.

Accordingly, such dwellings are either classified as Class 1, Class 2 or Class 3, depending on the circumstances of the building proposal.

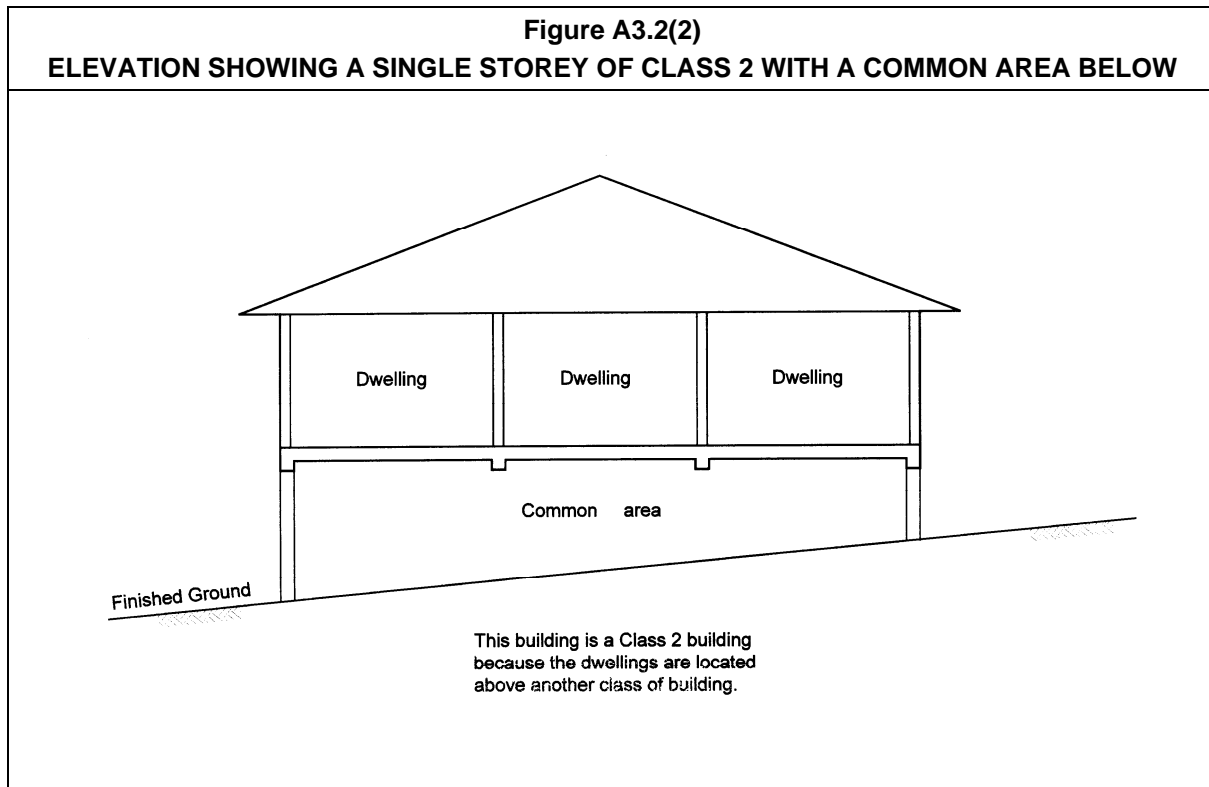

Examples

Class 3 buildings include:

- the residential parts of hotels and motels;
- hotel or motel caretakers', managers' or owners' flats, noting that under certain circumstances such dwellings could be Class 1, Class 2 or Class 3 buildings;
- dormitory accommodation, in schools or elsewhere, noting that a dormitory is generally (but not always) considered to be a sole-occupancy unit;
- bed and breakfast accommodation, a boarding house, guest house, hostel, or lodging house;
- backpackers' accommodation;
- a building which houses elderly people or other people who require special care. (In some States or Territories it is not acceptable for a Class 1b building to be used to house

elderly people or other people who require special care - it is recommended the local building regulatory body be consulted); and

- workers' quarters, including shearers' or fruit pickers' accommodation, or hotel workers' accommodation.

Class 4

Class 4 classification applies to some types of accommodation located within a Class 5-9 building.

Examples

The most common include a caretaker's flat within a building; and accommodation over or otherwise connected to a shop

A Class 4 part cannot be located within a Class 1, Class 2 or Class 3 building.

There can only be one Class 4 dwelling in a building. If there are two or more dwellings, they are Class 1, Class 2, or possibly Class 3. These Class 1, Class 2 or Class 3 parts need not be attached to one another, nor be more than a single storey.

Where a Class 4 part of a building is rented out for accommodation purposes, it retains its Class 4 classification. However, if any other part of the principal building is used for accommodation, for example, the attached shop is converted into an additional flat, both flats become classifiable as Class 2 or, depending on their use, possibly Class 3.

Class 5

Class 5 buildings include: professional chambers or suites, lawyers' offices, government offices, advertising agencies and accountants' offices.

Class 6

A Class 6 building is a building where goods or services are directly sold or supplied to the public.

Service stations are Class 6 buildings. These are outlets used for the servicing of cars and the selling of fuel or other goods.

The expression ‘service station’ is not intended to cover buildings where panel beating, auto electrical, muffler replacement, tyre replacement and the like are solely carried out. Such buildings should be classified as Class 6, Class 7 or Class 8 buildings as the appropriate authority sees fit.

Class 7a

There are two basic types of Class 7 building. The first is a carpark as defined in the BCA. The BCA classifies this type of building as a Class 7a building.

Class 7b

The second basic type of Class 7 building is a building used for storage, often referred to as a ‘warehouse’. This type of building also includes those used for the display of goods or produce for sale by wholesale. ‘Wholesale’ means sale to people in the trades or in the business of ‘on-selling’ goods and services to another party (including the public). The BCA classifies this type of building as a Class 7b building.

Class 8

The most common way to describe a Class 8 building is as a ‘factory’. However, this can give a simplistic impression of the types of building which can fall within this classification.

For example:

- some laboratories, despite their often small size, have been included as Class 8 buildings principally because of their high fire hazard;
- buildings used for altering or repairing (except service stations, which are specifically included in **A3.2** as Class 6 buildings);
- potteries;
- food manufacturers (but not restaurants, which are specifically included in **A3.2** as Class 6 buildings); and
- buildings used for the packing of produce.

Class 9a

Class 9a buildings are health-care buildings, including day-care surgeries or procedure units and the like. See definition of health-care building.

Laboratories which are part of a Class 9a building are Class 9a, despite the general classification of laboratories as Class 8 buildings.

Class 9b

Class 9b buildings are assembly buildings. These buildings can include:

- theatres, cinemas and halls, churches, schools, early childhood centres, kindergartens, preschools and child-minding centres;
- indoor cricket, tennis and basketball centres;
- snooker halls;
- bus and railway stations.

Class 9c

Class 9c buildings are aged care buildings which may contain residents who have various care level needs.

The Class 9c classification recognises that many residents progress through a continuum of care needs from low to high. Many older people enter residential care with low care needs, but, as they age, require higher levels of care. In the past, such progression often necessitated the transfer of a hostel resident to a nursing home. This frequently had negative consequences for the health and well-being of the resident, for whom the hostel accommodation was home. It also led, at times, to the separation of couples with differing care needs.

Building designers should note that Class 3 buildings include hostels for the accommodation of the aged, and Class 9a buildings include nursing homes. It is important to be aware, however, that construction of Class 3 or 9a buildings may restrict the options available to the operators of a facility in relation to the profile of the residents they wish to accommodate. Where the potential exists for residents of varying care needs to be accommodated, consideration of the Class 9c provisions may be appropriate. The Class 9c classification allows for any mix of low and high care residents and is intended to allow the mix to change, as the residents' care needs change over time, without the need to obtain any further consent or approval from the building regulatory authority.

Multi-care level facilities are for residents who may require the full range of care services outlined by the Aged Care Act. Hence, it is not intended to restrict the resident type and provides maximum flexibility for service providers, residents and the community.

The BCA provisions for Class 9c aged care buildings are based on minimal on duty on-site staff being available at any time. However, it is recognised that the staff numbers vary throughout the course of any one day, due to the care needs of the residents and the functioning of the facility. It is also recognised that the specific care needs of the residents may result in a greater minimum number of staff.

Class 10a

Class 10a buildings are non-habitable buildings. See [Figure A3.2\(3\)](#) for an indication of some Class 10 building configurations.

Figure A3.2(3)
EXAMPLES OF CLASS 10 BUILDINGS

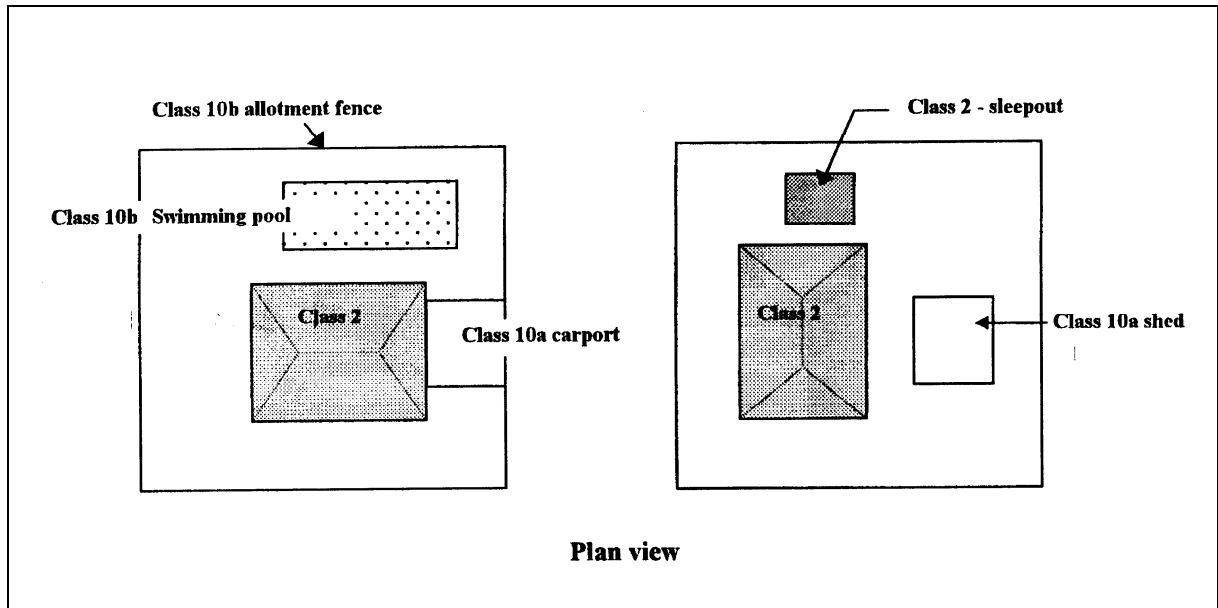

Class 10b

Class 10b structures are non-habitable structures.

There is no requirement for Class 10 buildings to be appurtenant to a building of any other class. For example, a small shed standing on its own on an allotment and a toilet block in a park.

A habitable 'outbuilding' which is appurtenant to another building is generally part of that building. Again, habitable 'outbuildings' cannot be classified as Class 10 buildings.

Examples

- A sleepout on the same allotment as a Class 2 building is part of the Class 2 building.
- A detached entertainment room on the same allotment as a Class 2 building, perhaps associated with a swimming pool, is part of the Class 2 building.
- A small toolshed, used for trade-related hobbies for non-commercial purposes or home repairs, on the same allotment as a Class 2 building, would be classified as a Class 10 building.

Some States or Territories may exempt some Class 10 buildings or structures (often on the basis of height or size) from the need to have a building permit. Queries on this matter should be referred to the State or Territory body responsible for regulatory matters.

Difficult classifications

Class 2 or Class 3?

There is a fine line between a Class 2 building and a Class 3 building with a bathroom and cooking equipment in its units. For example, when does a motel unit (probably Class 3) become a holiday flat (probably Class 2) and vice versa?

In general, an assessment will be based on the most likely use of the building by appropriate authorities.

Class 3 buildings represent a higher risk level, and therefore require higher safety levels. In a case where the classification is unclear, perceived risks inherent in the use of the building will be scrutinised.

Class 6 or Class 7b?

Class 7b buildings include those used to sell goods on the wholesale market, whereas Class 6 buildings are used to sell goods to the public.

Some establishments claim to sell goods to both the wholesale and retail markets. As a rule, however, if the general public has access to the building, it is considered a 'shop', and therefore a Class 6 building.

Farm buildings

In some States or Territories, appropriate authorities may classify farm buildings as Class 10a, which covers non-habitable buildings. They would only make this decision if a classification of Class 7b or Class 8 would not be more appropriate.

When making their decision they consider the building's size, purpose, operations and the extent to which people are employed in the building.

A3.3 Multiple classification

Intent

To permit a building to have more than one classification.

Under **A3.3(a)**, if 10% or less of the floor area of a storey is used for a purpose which could be classified differently to the remainder of that storey, that part may be classified as being the same as the remainder. Laboratories and sole-occupancy units in Class 2, 3 or 4 parts are excluded from this concession. The reason is that laboratories are considered to have a high fire hazard potential and classifying them with the remainder of the building could, in a majority of cases, endanger occupants of the other part of the building which have a lower fire hazard potential. Also, the intent is not to allow sole-occupancy units in Class 2, 3 or 4 parts to be regarded as another Class such as Class 6 and then not have any fire or sound insulation between the units and any other classification which may have a high fire load and could endanger the occupants of the Class 2, 3 or 4 part.

If the storey has a very large floor area, the 10% or less concession area may also be large, even though the rest of the building is classifiable as a building which ordinarily has a lower risk potential.

Example

An example of the application of this area concession could be as follows:

- if a single storey factory has an office which takes up 8% of the whole storey's floor area, the entire building (including the office) can be classified as being Class 8; however
- if that office area takes up 12% of the storey's floor area, that area must be classified as Class 5, and the remainder of the building as Class 8.

Under **A3.3(b)** and **(c)** Classes 1a and 1b, 7a and 7b, 9a, 9b and 9c, and 10a and 10b are separate classifications, and if joined together or in close proximity may require fire separation in certain situations. In the BCA, when the designation 'a', 'b' or 'c' is not applied, the reference is to all buildings of the general class (for example, 'Class 9b' refers only to Class 9b buildings, but 'Class 9' refers to Class 9a, Class 9b and Class 9c buildings).

Plant, machinery and lift motor rooms

Under **A3.3(d)** a plant room, machinery room, lift motor room or boiler room, have the same classification as the part of the building they are in.

These kinds of rooms do not need to be ancillary or subordinate to the part of the building they are in. (That is, the 10% criterion is not applicable).

There are specific provisions for these kinds of rooms. For example, **Section C** requires some of them to be fire separated from the remainder of the building (eg see **C2.13** with regard to elements of the electricity supply system).

A3.4 Parts with more than one classification

Intent

To permit a part of a building to have more than one classification.

Under **A3.4(a)** each part of a building (including the entire building) may have more than one classification. This means, for example, that it is permissible to classify part of a building as a Class 6/7 building, or a Class 5/6 building, or whatever is appropriate.

It is expected that this approach may be taken by a builder who is uncertain of what the precise use of a building will be after its sale, or to maximise the flexibility of the building's use.

Under **A3.4(b)** where a building has more than one classification the more stringent Class requirements will apply.

PART A4 UNITED BUILDINGS

A4.1 When buildings are united

Intent

To specify that where adjacent buildings are joined through openings in walls, they need not meet additional requirements if they jointly comply with the BCA as if a single building.

It is not unusual for authorities to receive plans proposing the joining of two or more buildings. Joining of buildings could be achieved by breaking openings through walls, or by joining the buildings by a tunnel, bridge or covered walkway.

When joined, if the buildings jointly comply with all the requirements of the BCA applying as if they were a single building, they become a united building.

United buildings are not required to comply with additional BCA provisions. For example, any new openings do not require any form of fire protection not required of a single building.

Note, however, an external wall, which as a result of an interconnection becomes an internal wall, must comply with the requirements for an internal wall.

Interconnected buildings which do not jointly comply with all the requirements applicable to a single building, remain as separate buildings.

This raises the possible need for fire doors, or other forms of protection to be fitted to the new openings.

Multiple allotments or ownership

The BCA does not concern itself with actually prohibiting or permitting the uniting of buildings in separate ownership or on separate allotments. Such matters are dealt with by the relevant local bodies.

Example of connection by bridge

In this example, Building A is connected to Building B by bridge C. There are four different options for designing such a proposal.

The first is a united building

A, B and C are considered as a single structure and comply with the BCA.

The second is three separate buildings

A, B and C are a fire-source feature to each of the others, and are separated by fire walls with the openings protected at the points of connection. In this case, C may require independent support and separate egress to a road or open space, that is not through Buildings A or B. In

this case, attention should also be paid to the length of the bridge, as regards distance of travel to an exit.

The third option is the bridge as a portion of Building A

In this option, A and C are one building, meeting all requirements of the BCA as a single or united building. B is a separate building, with suitable fire separation, including fire-doors at the point of interconnection. Bridge C could be supported off Building A, but not off Building B.

The fourth option is having the bridge as a portion of Building B

In this option, B and C are one building, meeting all requirements of the BCA as a single or united building. A is a separate building, with suitable fire separation, including fire doors at the point of interconnection. Bridge C could be supported off Building B, but not off Building A.

In some cases, C will link A and B across a public road, including laneways and the like. Special approvals may be required from various relevant authorities. However, in such cases:

- if C is supported by means other than off A and B, such support will generally only be permitted if there is no obstruction of the public road;
- care will need to be taken in calculating the distance of travel to an exit if travel is required to be over C and the road is wide; and
- fire-separation may be necessary at each end of the bridge.

If the last stipulation is the case, the following matters need consideration:

- the bridge would probably need to be of fire-rated construction because combustible construction could provide a ready path for the transfer of fire, and non-combustible construction could, in a major fire, distort and collapse onto the road;
- the designer needs to take care that the bridge does not negate the fire separation between the storeys of the building.

A4.2 Alterations in a united building

Intent

To specify that where buildings, united in accordance with A4.1, cease to be connected following alterations or any other building work, each disconnected building must comply with the BCA as a single building.

SPECIFICATION **A1.3****STANDARDS ADOPTED BY
REFERENCE****1 Schedule of referenced documents****Intent**

Provide a listing of documents in Volume One.

The documents listed in this schedule are referenced in the **Deemed-to-Satisfy Provisions** of the BCA

Referenced documents and Australian Standards

Most referenced documents are Australian Standards, prefixed by AS. Some are jointly produced with New Zealand, and these are prefixed by AS/NZS. There are several non-Australian Standards referenced, and these are found at the end of **Table 1**.

The adoption of referenced documents

The BCA is quite precise when specifying the version of any referenced document. New, or amendments to existing referenced Australian Standards and other referenced documents are not automatically adopted.

Documents do not become part of the BCA until they have been referenced in **Table 1**. This enables the ABCB to review the documents and make sure they are not unduly onerous or economically inappropriate before being adopted into the BCA.

How to use Table 1

Column 1 includes the number of the referenced document. In the case of some that are not Australian Standards, it includes an identifying acronym. In several cases, references are only made to specific parts of a document. Here, the relevant part number is included.

Column 2 includes the date the document was released. This distinguishes the document from earlier and later versions.

Column 3 includes the title of the referenced document. In those cases where a specific part has been referenced, the title of the part is noted. Where amendments to the document are included, the number and date of the amendments are listed.

Column 4 includes the BCA provision by which the document is referenced.

Referenced documents and Deemed-to-Satisfy

No referenced documents need to be used in an **Alternative Solution**. However, a building proponent may use such documents if they wish. The documents could be used to show

achievement with the **Performance Requirements** or equivalence with the **Deemed-to-Satisfy Provisions**.

Examples of reference documents other than Australian Standards

AISC guidelines

The Australian Institute of Steel Construction (AISC) guidelines for assessment of fire-resistance of structural members is a referenced document.

These guidelines detail requirements for the design of steel composite and non-composite members and connections to resist the effects of fire. They also explain required FRLs.

The guidelines are consistent with those being proposed by the Steel Structures Code, but have been extended to cover composite members.

ASTM D3018-90

The American Society for Testing and Materials (ASTM) document covers asphalt shingles which meet the Class A fire exposure tests in Test Method E108.

CSIRO-NTBC Bulletin 5 - Earth-wall construction, 4th edition

This bulletin sets out requirements for, and capabilities of, earth-walled construction for Australian conditions. Earth-wall construction includes the pise (rammed earth), adobe (mud brick), and pressed soil-block methods. Earth walls complying with this bulletin can be used for any of the classes of building under the BCA.

SSL Register of accredited products

A Scientific Services Laboratory (SSL) document lists fire-protection equipment tested and appraised by recognised laboratories. This appraisal is carried out to Australian Standards or, in their absence, to other acceptable Standards. Listing of equipment by SSL also requires that there be competent suppliers, spare parts and technical support.

SPECIFICATION **A2.3** FIRE-RESISTANCE OF BUILDING ELEMENTS

1 Use of **Specification A2.3**

Deemed-to-Satisfy Provisions often require building elements to have an FRL. **Specification A2.3** explains how these FRLs are to be determined and, in conjunction with **Table 1**, spells out how FRLs apply to specific building elements and materials.

2 Fire-resistance level

An FRL is expressed in terms of figures that cover structural adequacy, integrity and insulation.

Examples

A loadbearing wall may require an FRL of 120/60/30 — meaning that in the Standard Fire Test the wall must retain its:

- structural adequacy for at least 120 minutes;
- integrity for at least 60 minutes; and
- insulation properties for at least 30 minutes.

A non-loadbearing wall, however, may require an FRL of -/120/120 — meaning that in a Standard Fire Test the wall is not required to retain any structural adequacy criterion. However, the wall must maintain its:

- integrity for at least 120 minutes; and
- insulation properties for at least 120 minutes

3 **AS 1530.4** — Standard Fire Test

Specification A2.3 requires that a prototype of an element being tested must be subjected to the Standard Fire Test, ie the Fire-resistance tests of Elements of Building Construction in **AS 1530.4**.

4 Non-loadbearing elements (**Clause 6** of **Specification A2.3**)

A non-loadbearing element need not comply with an FRL's structural adequacy requirement.

5 **Table 1** — FRLs deemed to be achieved

Some building elements have been tested and their FRLs calculated. Where these are known, they are included in **Table 1**.

Research results are generally available from the manufacturers who sponsor the tests. These results and other research will form the basis of future amendments to **Table 1**.

In recent years, a number of the Standards Australia structural codes have included provisions for the calculation of FRLs. Some more complicated building elements have many combinations and permutations, and reference to specific Australian Standards is necessary.

SPECIFICATION A2.4**FIRE HAZARD PROPERTY TEST
FOR ASSEMBLIES****1 Scope****Intent**

To establish the tests required by **Clause 2(d)(ii)** of Specification C1.10.

This clause deals with the installation of materials and the installation of an assembly of materials where the central core of the assembly is shielded from the effects of fire.

2 Form of test**Intent**

To establish the tests required for early fire-hazard properties on assemblies of materials.

Specification A2.4 requires two tests in accordance with **Clause 2(a)** and **Clause 2(b)**. They are respectively: [AS/NZS 1530.3](#) for Spread-of-Flame Index and Smoke-Developed Index; and [AS 1530.4](#) for the ability to prevent ignition and to screen the core material from free air.

The test in accordance with [AS 1530.4](#) is conducted on composite members or assemblies, as specified in **Clause 2(d)** of **Specification C1.10**. It is also used to test if any material in the member or assembly may ignite during the 10 minutes specified by **Clause 2(d)(iii)**.

3 Test specimens**Intent**

To specify the details required for the test specimen.

The material to be tested must include all joints, perforations, recesses, and the like. These parts may affect not only its early fire-hazard properties, but are also more likely to affect the passage of air and fire to the material's inner core. The requirements for the test specimen apply to both tests required by **Clause 2**.

4 Concession

Intent

To provide a concession for the re-testing of joints, perforations, recesses, and the like which have been previously tested.

Clause 4 is based on the assumption that **Clause 2** tests would be passed by joints, perforations and recesses, which will be smaller in the building member to be used on site than those in the member tested. The concession in **Clause 4** applies to both the tests in **Clause 2**.

5 Smaller specimen permitted

Intent

To allow smaller test specimens when testing for the ability to prevent ignition and screen the core material from free air when appropriate.

The smaller test specimen allowed by **Clause 5** only applies to the [AS 1530.4](#) test required by **Clause 2(b)**.

The smaller test specimen is allowed for practical reasons in the test rig. This is on the basis that the test will affect the specimen in an identical manner to the on-site building member.

The results from a smaller test specimen are limited to those specified by the testing laboratory. In accordance with **Specification A2.4**, only a Registered Testing Authority may conduct the test.

SECTION **B**

STRUCTURE

B1 **Structural Provisions**

SECTION B CONTENTS

	Page
Part B1 Structural Provisions	4,021
Objective BO1	
Functional Statement BF1.1	
Performance Requirement BP1.1 - BP1.2	
B1.0 Deemed-to-Satisfy Provisions	
B1.1 Resistance to actions	
B1.2 Determination of individual actions	
B1.3 Determination of structural resistance of materials and forms of construction	

PART B1 STRUCTURAL PROVISIONS

Objective

BO1

The Objective is based on the belief that people should not be subject to risk of injury from a building suffering structural failure — **BO1(a)**. Nor should there be any amenity loss caused by structural behaviour — **BO1(b)**. Additionally, other property should not be at risk of physical damage caused by structural failure — **BO1(c)**.

The term ‘structural behaviour’ as used in **BO1(b)** can describe deflections, creep, vibration, settlement and the like. Problems with structural behaviour fall short of actual structural failure.

Example

A building could have excessive deflection of a window lintel which causes the glass to shatter. This could interfere with the building’s use without causing it to collapse.

‘Loss of Amenity’ refers to the loss of a person’s ability to use a building in the manner intended.

Example

Structural deflections could cause a building’s doors to stick, and thus detract from a person’s ability to move about the building.

Functional Statement

BF1.1

In order to achieve **BO1**, a building must withstand any combination of loads to which it may reasonably be subjected. **BF1.1** clarifies that the BCA structural provisions are intended to cover buildings and structures.

Performance Requirement

BP1.1

BP1.1 consists of two parts:

- performance attributes that a building is required to have; and
- a list of actions to be considered in association with these attributes.

Performance attributes

BP1.1(a) uses the term 'to the degree necessary' to indicate that the requirements are not absolute.

BP1.1(a)(i) is concerned with the ultimate limit states of buildings in terms of strength and overall stability. For structural designs based on standards, the risk of structural failure per year is of the order of 10^{-6} and the estimated notional probability of failure of individual components is of the order of 10^{-3} to 10^{-4} (for a 50 year reference period).

Progressive collapse is included in **BP1.1(a)(ii)** to account for situations where small accidents may have serious consequences which are not proportional to the original cause.

Example

An example of this occurrence was the collapse of a block of flats in Ronan Point, in London, England where:

- a gas explosion blew out a load-bearing external wall; which
- resulted in the floor above failing due to loss of support; which
- resulted in the wall above failing due to the loss of support by the floor, and so on all the way up the building; and
- the building failed like 'a house of cards', where one card was removed, and the remainder progressively collapsed.

BP1.1(a)(iii) is concerned with the serviceability limit states in terms of local damage, deformation, vibration and degradation. Degradation is included because the issue of durability must be considered. The risk of serviceability failure historically is of the order of 10^{-1} to 10^{-2} . The acceptable level of serviceability is subjective. The design for serviceability therefore depends to a large extent on professional judgement.

Damage to other properties referred to in **BP1.1(a)(iv)** may be caused by reasons other than structural. Physical damage to other properties caused by structural failure is not likely if **BP1.1(a)(i)** to **(iii)** are met.

List of actions

BP1.1(b) lists actions to which a building 'may reasonably be subjected'. All possible actions cannot be listed. 'Engineering judgement' may need to be used to determine all likely actions and in accessing the likely effects of those actions.

Example

Buildings and structures should be able to withstand the effects of wind, rain or snow. However, they would not be expected to withstand the impact of a crashing aeroplane.

BP1.1(b)(xiv) uses the defined term 'construction activity actions'. The term only refers to construction activities that may have an effect on the final design such as stacking or propping. The safety of the building during construction is normally controlled by occupational health and safety authorities.

BP1.2

BP1.2 states the principles for the determination of the structural resistance of materials and forms of construction.

BP1.1

It should be noted that the construction activities referred to in **BP1.2(a)** may be more than those contained in the defined term of 'construction activity actions'. For example, welding of structural steel might cause distortion or change the characteristics of the steel, and hence need to be accounted for. For this reason, the defined term has not been used in **BP1.2(a)**.

PART B1 STRUCTURAL PROVISIONS

Deemed-to-Satisfy Provisions

B1.0 Deemed-to-Satisfy Provisions

Intent

To clarify that BP1.1 will be satisfied if compliance is achieved with **B1.1 to B1.3**.

B1.1 Resistance to actions

Intent

To specify the criteria for achieving compliance with **BP1.1** and **BP1.2**.

A building or structure must be designed to resist the most critical effect resulting from different combinations of actions. The actions must be combined taking into account the characteristics of the actions and the probability of the simultaneous occurrence of two or more actions. The levels of reliability of the structure when subject to combined actions should be consistent with the levels of reliability implicit in the design events for natural phenomenon (see comments on **Table B1.2(b)**). When designing for the maximum combined actions, a principle frequently adopted is that the maximum is likely to occur when at least one of the actions is at its maximum value.

B1.2 Determination of individual actions

Intent

To specify the principles for the determination of each action referred to in **BP1.1(b)**.

Construction activity actions

The term 'construction activity action' only refers to construction activities that may need to be accounted for in the final design such as stacking of materials and floor to floor propping.

Table B1.2a

A generic description of building types has been provided to which Importance Levels have been assigned. The 'Importance Level' concept is applicable to building structural safety only. More specific examples are provided in the following Table. The examples are not exhaustive.

Importance Level	Examples of building types
1	Farm buildings Isolated minor storage facilities Minor temporary facilities.
2	Low rise residential construction Buildings and facilities below the limits set for Importance Level 3.
3	Buildings and facilities where more than 300 people can congregate in one area Buildings and facilities with primary school, secondary school or day care facilities with capacity greater than 250 Buildings and facilities with a capacity greater than 500 for colleges or adult educational facilities Health care facilities with a capacity of 50 or more residents but not having surgery or emergency treatment facilities Jails and detention facilities Any occupancy with an occupant load greater than 5000 Power generating facilities, water treatment and waste water treatment facilities, any other public utilities not included in Importance Level 4 Buildings and facilities not included in Importance Level 4 containing hazardous materials capable of causing hazardous conditions that do not extend beyond property boundaries.
4	Buildings and facilities designated as essential facilities Buildings and facilities with special post disaster functions Medical emergency or surgery facilities Emergency service facilities: fire, rescue, police station and emergency vehicle garages Utilities required as backup for buildings and facilities of Importance Level 4 Designated emergency shelters Designated emergency centres and ancillary facilities Buildings and facilities containing hazardous materials capable of causing hazardous conditions that extend beyond property boundaries

Importance levels must be assigned on a case by case basis.

Example

A hospital may be of Importance Level 4 if it is the only hospital in an area. The same hospital may be of Importance Level 3 if it is one of many in an area.

A general method for the determination of the Importance level of any building is to assess the hazard to human life and the impact on the public in the event of building failure as follows:

Building Importance Levels					
		Impact on the public			
		I (Low)	II (Moderate)	III (Substantial)	IV (Extreme)
Hazard To Human Life	A (Low)	1	2	2	3
	B (Moderate)	2	2	3	3
	C (Substantial)	2	3	3	4
	D (Extreme)	3	3	4	4

The annual probability of exceedance varies with the type of action.

Example

Building failures due to earthquake or cyclone may be widespread and therefore have more impact on the public than say thunderstorms, that affect relatively smaller areas.

Table B1.2b

The annual probabilities of exceedance in **Table B1.2(b)** originated from calibrations derived from experience with minor adjustments carried out to achieve consistency.

B1.3 Determination of structural resistance of materials and forms of construction

Intent

To specify deemed-to-satisfy materials and forms of construction.

If the materials and construction listed in **B1.3** are used, they must comply with the requirements outlined in the relevant sub-clauses.

The structural performance of a building is dependent, not only on the determining of the applicable actions, but also on the methods used to determine resistance to those actions. **B1.3** provides a list of material design standards that can be used together with **B1.2**.

For designers seeking structural compliance via 'Alternative Solutions', a major principle in determining structural resistance is that the reliability level of the structure or its components may be at least equal to that already achieved in the Deemed-to-Satisfy Provisions. For a more

complete explanation, the reader is referred to ISO 2394 – General principles on reliability of structures.

B1.3(h) clarifies which type of glazed assemblies must comply with [AS 2047](#) and which must comply with [AS 1288](#). The reference to heritage windows is intended to apply to windows in heritage buildings. The method of determining a heritage building is normally covered by the relevant State or Territory authority.

B1.3(i) only applies where a ‘primary building element’ is considered susceptible to attack by subterranean termites. ‘Primary building element’ excludes from the coverage of **B1.3(i)** building elements which may provide some bracing to a wall, but it is not required as part of their primary function. An example would be plasterboard not required for bracing or external cladding.

B1.3(i)(i) deems that several specified primary building elements are not subject to termite attack.

B1.3(i)(ii) only requires the attachment of a notice regarding the method or system used to protect against termite attack where that method or system is one described in [AS 3660.1](#).

B1.3(m) allows structures used for primary production in rural areas to comply with [AS 2867](#). This standard allows deflections not permitted in other buildings or structures in other areas. This recognises that there are occasionally acceptable differentials in safety and amenity requirements, depending on use and location.

SECTION **C**

FIRE RESISTANCE

- C1** **Fire Resistance and Stability**
- C2** **Compartmentation and Separation**
- C3** **Protection of Openings**

SECTION C CONTENTS

	Page
Section C Fire Resistance	6,021
Objective CO1	
Functional Statements CF1 — CF2	
Performance Requirements CP1 — CP9	
Verification Methods CV1 — CV2	
Part C1 Fire Resistance and Stability	6,301
C1.0 Deemed-to-Satisfy Provisions	
C1.1 Type of construction required	
C1.2 Calculation of rise in storeys	
C1.3 Buildings of multiple classification	
C1.4 Mixed types of construction	
C1.5 Two storey Class 2, 3 or 9c buildings	
C1.6 Class 4 parts of buildings	
C1.7 Open spectator stands and indoor sports stadiums	
C1.8 Lightweight construction	
C1.9 * * * * *	
C1.10 Fire hazard properties	
C1.11 Performance of external walls in fire	
C1.12 Non-combustible materials	
Part C2 Compartmentation and Separation	6,301
C2.0 Deemed-to-Satisfy Provisions	
C2.1 Application of Part	
C2.2 General floor area and volume limitations	
C2.3 Large isolated buildings	
C2.4 Requirements for open spaces and vehicular access	
C2.5 Class 9a and 9c buildings	
C2.6 Vertical separation of openings in external walls	
C2.7 Separation by fire walls	
C2.8 Separation of classifications in the same storey	
C2.9 Separation of classifications in different storeys	

	Page
C2.10	Separation of lift shafts
C2.11	Stairways and lifts in one shaft
C2.12	Separation of equipment
C2.13	Electricity supply system
C2.14	Public corridors in Class 2 and 3 buildings
Part C3	Protection of Openings 6,851
C3.0	Deemed-to-Satisfy Provisions
C3.1	Application of Part
C3.2	Protection of openings in external walls
C3.3	Separation of external walls and associated openings in different fire compartments
C3.4	Acceptable methods of protection
C3.5	Doorways in fire walls
C3.6	Sliding fire doors
C3.7	Protection of doorways in horizontal exits
C3.8	Openings in fire-isolated exits
C3.9	Service penetrations in fire-isolated exits
C3.10	Openings in fire-isolated lift shafts
C3.11	Bounding construction: Class 2, 3 and 4 buildings
C3.12	Openings in floors and ceilings for services
C3.13	Openings in shafts
C3.14	* * * * *
C3.15	Openings for service installations
C3.16	Construction joints
C3.17	Columns protected with lightweight construction to achieve an FRL
Specifications	8,001
C1.1	Fire-Resisting Construction
C1.8	Structural Tests for Lightweight Construction
C1.10	Fire Hazard Properties
C1.11	Performance of External Walls in Fire
C2.5	Smoke-proof walls in health-care and aged care buildings
C3.4	Fire Doors, Smoke Doors, Fire Windows and Shutters

C3.15 Penetration of Walls, Floors and Ceilings by Services

SECTION C FIRE RESISTANCE

Objective

CO1

Basis of Objective

This Objective is based on the belief that a building should:

- provide people with an environment which, during a fire, will minimise the risk of them suffering illness or injury;
- provide people with an evacuation route which will minimise the risk of them suffering illness or injury while escaping a fire;
- facilitate the role of emergency services personnel, such as the fire brigade, if it becomes necessary for them to undertake such operations as fire-fighting and search and rescue;
- assist in minimising the risk of fire spreading from one building to another; and
- not have a structural failure during a fire that results in damage to another building, allotment or road.

Spread of fire

There is a continuing debate regarding the means by which the BCA should minimise the risk of fire spreading from one building to another. Should the greater degree of fire protection be in the building on fire, or should it be in the building at potential risk of the fire spreading?

Generally, the BCA provisions aim to minimise the spread of fire from the building on fire, but there are some provisions that limit the spread of fire from an adjacent building.

Consequently, **CO1(d)** states that the spread of fire is to be avoided ‘between buildings’ — that is, in either direction.

Protection of other property

The BCA is principally designed to maximise (within reasonable bounds) the safety, health and amenity of people in and around buildings. Protection of property, either the subject building or what is termed ‘other property’, is not generally a primary aim of the BCA — although it may sometimes be a consequence of the provisions of the BCA.

However, there are some exceptions to this rule, and the inclusion of ‘other property’ in **CO1(e)** is one of these. In this context, a building is expected to maintain the level of structural sufficiency necessary to prevent it causing damage to any other property as a result of fire. The reason **CO1(e)** concerns itself with the protection of other property is primarily

because fire from a building should not pose a serious risk to the health, safety and amenity of the public or occupants of another building. See **A1.1** for definition of ‘other property’.

Functional Statements**CF1****Structural stability**

A building must remain structurally stable during a fire to:

- allow the occupants to safely evacuate;
- allow the fire brigade to undertake search and rescue, if necessary, and fire-fighting operations; and
- avoid damage to another building, allotment or road.

Instability may not contravene the BCA

So long as a building does not endanger life or other property, and the BCA's structural stability criteria have been satisfied, then the building may become structurally unstable after a fire and still comply with the objectives of **Section C**. It could even collapse, provided none of the building falls in a way that endangers the public or causes damage to another building. For example, if a building falls onto a road, it could endanger the safety of the public and would therefore not achieve the Functional Statement.

CF2**Spread of fire**

A building must have in-built safeguards to prevent the spread of fire:

- to allow sufficient time for the occupants to safely evacuate;
- to allow the fire brigade to undertake search and rescue, if necessary, and fire-fighting operations;
- in Class 2 or Class 3 buildings or Class 4 parts used as sole-occupancy units that provide sleeping accommodation to allow sufficient time for the occupants to safely evacuate;
- to an adjoining fire compartment; and
- from one building to another building.

Spread of fire may not contravene the BCA

So long as a building fire does not endanger life or other property, and the BCA's spread of fire criteria have been satisfied, then the building may burn and still comply with the aims of **Section C**.

Performance Requirements

CP1

Structural stability required during fire

CP1 sets structural stability requirements for building elements during a fire.

CP1 does not make any reference to a fire-resistance level (FRL). FRLs are only included as part of the Deemed-to-Satisfy Provisions.

It may be found by a building proponent using an Alternate Solution that FRLs to building elements are not necessary as other means, such as the use of active systems, satisfy the Performance Requirements.

'To the degree necessary'

CP1 uses the term 'to the degree necessary'. This word usage is designed to provide flexibility in the way this provision is implemented. The intended meaning of the term 'to the degree necessary' in **CP1** and other Performance Requirements, is explained in **A1.7**.

It means that the BCA recognises that different building elements require differing degrees of structural stability during a fire. The expression is intended to allow the appropriate authority to determine the degree of compliance necessary in each particular case.

Any decision made in this context can extend to not requiring an item to be installed or a particular level of performance to be achieved, if that is the appropriate action to be taken.

'Appropriate to'

The structural stability must be 'appropriate to' the criteria listed in **CP1**, which relate to such factors as:

- the likelihood or risk of a fire occurring in the building;
- the load, intensity and potential danger of any fire in the building;
- the difficulty of evacuation and/or rescue;
- a structural element's exposure to fire in another building, or risk of spreading a fire to another building;
- the fire safety systems in the building, which can affect the rate of fire spread (eg if a

sprinkler system is installed in a building, it could either extinguish the fire or reduce its growth rate);

- the size of a fire and the difficulties in effecting an evacuation;

- the fire-fighting operations of the fire brigade; and
- the consequences of the failure of the element (another way of expressing this is to consider that if the element fails, could it result in the failure of another element).
- the time taken from the start of the emergency to the occupants reaching a safe place.

While assessment of a building proposal must have regard to the differing needs of each building element, the proposal must make sure that the elements have an appropriate structural stability during a fire so that:

- the fire does not endanger the occupants by entering escape routes; and
- the fire does not endanger fire fighters while they are undertaking search and rescue operations.

Examples

The following are two examples of what may or may not be ‘appropriate’. They should not be regarded as absolute, or applicable in all circumstances.

Commercial poultry building

The building concerned is a commercial poultry building which is single storey and occupied by only a few workers, who are likely to know the building well. The building is situated a long distance from any other building and has direct routes to the exit doors.

In such a case, the building elements may not need to be fire protected under **CP1** because the occupants would be able to evacuate quickly and if the building collapses, there is little likelihood of it damaging another building.

High-rise office building

The building concerned is a central city high-rise office building. It is located on the street alignment and close to other similar buildings. In such a case, the structural failure of any of the building elements could lead to danger to building occupants and the general public, failure of building elements intended to protect another building, or the collapse of another element which relies on the first element for structural support.

In this example, building elements may require a high level of protection under **CP1**.

In both cases, the ability of the fire brigade to control a fire also needs to be considered when considering the implications of **CP1**.

If the proposal being considered involves a Building Solution that is taking advantage of the Deemed-to-Satisfy Provisions, the Deemed-to-Satisfy Provisions contain detailed requirements for the fire protection of building elements.

If an Alternative Solution to the Deemed-to-Satisfy Provisions in **Section C** is being used, it may be appropriate to assess it using the **Section C** Deemed-to-Satisfy Provisions for guidance

purposes. It is stressed, however, that compliance with the Deemed-to-Satisfy Provisions is not compulsory if alternative means can be found to satisfy the appropriate authority that the Performance Requirements will be achieved. The building proponent should refer to **A0.9** for guidance on acceptable assessment methods for determining compliance with the Performance Requirements.

PERFORMANCE PROVISIONS

CP2**Spread of fire**

CP2 deals with the spread of fire both within the building and between buildings, and which does not only result from the structural failure of a building element.

CP2 does not make any reference to a fire-resistance level (FRL). FRLs are only included as part of the Deemed-to-Satisfy Provisions. However, proponents of an Alternative Solution should note, if they so wish. See **CF2**.

CP2(a)(i) aims to avoid a situation where fire either endangers occupants evacuating by way of exits, or impedes the capacity of emergency services personnel to access the building and fight the fire or rescue occupants.

CP2(a)(ii) aims to minimise the risk of people in Class 2 and Class 3 buildings and Class 4 parts, for example, if they were sleeping and consequently having difficulty escaping a fire. For this reason, **CP2(a)(ii)** requires that sole-occupancy units and corridors used for escaping be provided, to the degree necessary, with protection to avoid the spread of fire.

CP2(a)(iii) aims to minimise the risk of fire spreading from one building to another that could endanger the occupants of both buildings and impede the actions of the fire brigade. See **CV1** and **CV2** for two means of verifying, under certain circumstances, whether or not the requirements of **CP2(a)(iii)** will be achieved. Other assessment methods for determining compliance with the Performance Requirements are in **A0.9**.

CP2(a)(iv) aims to minimise the risk of fire spreading through a building that could endanger the occupants, and impede the actions of the fire brigade.

CP2(a) uses the term ‘to the degree necessary’. This word usage is designed to provide flexibility in the way this provision is implemented.

It means that the BCA recognises that different building elements require differing degrees of protection to avoid the spread of fire. The expression is intended to allow the appropriate authority to determine the degree of compliance necessary in each particular case after considering each building scenario.

Any decision made in this context can extend to not requiring an item to be installed or a particular level of performance to be achieved, if that is the appropriate action to be taken.

Building elements must be appropriate to avoid spread of fire, taking into consideration the matters listed in **CP2(b)** including:

- the likelihood or risk of a fire occurring in the building;
- the size, load or intensity of any fire in the building;
- the difficulty of evacuation and/or rescue;
- the building's exposure to fire in another building, or risk of spreading a fire to another building;
- the fire safety systems in the building, which can affect the rate of fire spread (eg if a sprinkler system is installed in a building, it will either extinguish the fire or reduce its growth rate);
- the size of a fire and the difficulties in effecting an evacuation;
- the fire-fighting operations of the fire brigade and the resources available to it;
- the consequences of the failure of the element (another way of expressing this is to consider that if the element fails, could it result in the failure of another element); and
- the time taken from the start of the emergency to the occupants reaching a safe place.

If an Alternative Solution to the Deemed-to-Satisfy Provisions in **Section C** is being used, it may be appropriate to assess it using the **Section C** Deemed-to-Satisfy Provisions for guidance purposes. It is stressed, however, that compliance with the Deemed-to-Satisfy Provisions is not compulsory if alternative means can be found to satisfy the appropriate authority that the Performance Requirements will be achieved. The building proponent should refer to **A0.9** for guidance on acceptable assessment methods for determining compliance with the Performance Requirements.

Examples

The following are two very simple examples of what may or may not be 'appropriate'. They should not be regarded as absolute, or applicable in all circumstances.

Commercial poultry building

The building concerned is a commercial poultry building which is single storey and is occupied by only a few workers, who are likely to know the building well. The building is situated some distance from any other building and has direct routes to the exit doors.

In such a case, the building elements may not need to be protected against the spread of fire under **CP2(a)** because the building is:

- only one fire compartment;
- people are not sleeping in the building; and
- there is little likelihood of the spread of fire to another building because of the large distance to any other building.

High-rise office building

The building concerned is a central city high-rise office building. It is located on the street alignment and close to other similar buildings.

In such a case, the spread of a fire needs to be avoided because:

- the occupants will take some time to evacuate the building, so there is a need to protect the escape routes;
- there is a need for protection from the spread of a fire between each storey, because each storey is intended to be a separate fire compartment; and
- a fire could easily spread between buildings, because they are close together.

In this example, building elements may require a high level of protection against the spread of fire under **CP2(a)**.

In both cases, the ability of the fire brigade to control a fire would also need to be considered when considering the implications of satisfying **CP2(a)**.

If the proposal being considered involves a Building Solution that is taking advantage of the Deemed-to-Satisfy Provisions, the Deemed-to-Satisfy Provisions contain detailed requirements for the fire protection of building elements.

CP3

Spread of fire and smoke in a patient care area

CP3 deals with the spread of fire and smoke within a patient care area of a Class 9a building.

If a fire occurs in a health-care building, most patients would be unable to leave their beds, or may require assistance to evacuate the building. It is therefore important that the areas of the health-care building used by patients in beds be protected from fire in another part of the building.

See definition of 'health-care building' in **A1.1**.

Spread of fire and smoke in aged care buildings

CP3 also applies in Class 9c aged care buildings. In this case it applies throughout the whole building, not just in the resident use areas. This is because if a fire occurs in an aged care building, some residents would be unable to leave their beds, or may require assistance to evacuate the building.

CP4

Fire hazard properties of materials

CP4 deals with the fire hazard properties of materials used in the construction of a building. These include such matters as their smoke, toxic gas and heat generation capacities.

CP4 uses the term 'to the degree necessary'. This word usage is designed to provide flexibility in the way this provision is implemented.

It means that the BCA recognises that different materials and assemblies must resist the spread of fire to limit the generation of smoke, heat and toxic gases to differing degrees, depending on the circumstances of their use. The expression is intended to allow the appropriate authority to determine the degree of compliance necessary in each particular case after consideration of the building scenario.

Any decision made in this context can extend to not requiring an item to be installed or particular level of performance to be achieved, if that is the appropriate action to be taken.

The materials used in the building must be appropriate to avoid the spread of fire and the generation of smoke, heat and toxic gases after consideration of the matters listed in **CP4**. The reason for each of these matters is as follows:

- If the occupants can evacuate in a short time, then the smoke, heat and toxic gases generated prior to the completion of the evacuation will be less likely to have an impact on the safety of the occupants than if a longer evacuation time is required.
- The number, mobility and other characteristics of the occupants influence the time taken for the evacuation of the building. If the number of occupants is large, or they are not mobile, such as patients in a hospital or residents of an elderly people's home, the evacuation time could be long. Such an evacuation time may allow the fire to develop and generate greater amounts of smoke, heat and toxic gases that will endanger the safety of the occupants trying to evacuate.
- The function or use of the building has an impact on the types of materials and linings that are part of the building's fire load. This directly influences the rate of spread of any fire in the building.
- Any active fire safety system installed in the building, such as a sprinkler system, may limit the spread of fire and allow additional time for the evacuation of the occupants.

The Deemed-to-Satisfy Provision applicable to **CP4** is **C1.10**. **C1.10** limits the early fire hazard characteristics of materials susceptible to the effects of flame or heat, particularly during the early stages of a fire.

If an Alternative Solution to the Deemed-to-Satisfy Provisions in **Section C** is being used, it may be appropriate to assess it using the **Section C** Deemed-to-Satisfy Provisions for guidance purposes. It is stressed, however, that compliance with the Deemed-to-Satisfy Provisions is not compulsory if alternative means can be found to satisfy the appropriate authority that the Performance Requirements will be achieved. The building proponent should refer to **A0.9** for guidance on acceptable assessment methods for determining compliance with the Performance Requirements.

CP5

'Tilt-up construction'

CP5 is intended to overcome a problem observed when a fire has occurred in a building of 'tilt-up construction', and the panels have collapsed outwards, either during the fire or shortly after with little or no warning, endangering public safety, health, amenity and fire fighting operations.

A wide variety of structural systems and materials are possible to achieve this.

CP5 is only applicable to walls that could collapse as complete panels and, therefore, is not applicable to concrete and clay masonry walls, and the like, because such walls tend to fail in portions, rather than as complete panels.

The height limitation of 2 storeys is based upon the observation that the problem only seems to occur in low-rise buildings. This is due to taller buildings usually having fire rated floors and other building elements to restrain wall panels during a fire.

CP6

Hazardous service equipment

Certain types of equipment installed in buildings, such as boilers and the like, have a high fire potential. Other types of equipment, such as transformers and batteries, have a high potential for explosion. **CP6** aims to minimise the risk of a fire spreading from such equipment to other parts of the building.

CP6 uses the term ‘to the degree necessary’. This word usage is designed to provide flexibility in the way this provision is implemented.

It means that the BCA recognises that different equipment requires differing levels of protection, depending on the circumstances within which it is used and installed. The expression is intended to allow the appropriate authority to determine the degree of compliance necessary in each particular case.

Any decision made in this context can extend to not requiring an item to be installed or a particular level of performance to be achieved, if that is the appropriate action to be taken.

CP7

Emergency equipment must continue to operate

CP7 is intended to protect emergency equipment from the spread of fire within a building. It is important that emergency equipment continues to operate to the required level during an emergency. The length of time it should continue to operate will depend on the particular equipment.

Examples

CP7 requires that the emergency equipment continue to operate for as long as it is needed. Some examples of where protection may be required include:

- the protection of central smoke control plant required to operate in a fire for sufficient time for the occupants to evacuate; and
- the protection of the power supply to emergency lifts for sufficient time for the use of the lifts.

CP7 uses the term ‘to the degree necessary’. This word usage is designed to provide flexibility in the way this provision is implemented.

It means that the BCA recognises that different emergency equipment requires differing levels of protection, depending on the circumstances within which it is used and installed. The expression is intended to allow the appropriate authority to determine the degree of compliance necessary in each particular case.

Any decision made in this context can extend to not requiring an item to be installed or a particular level of performance to be achieved, if that is the appropriate action to be taken.

CP8

Openings and penetrations

CP8 requires openings and penetrations in building elements to resist the spread of fire.

CP8 should be read in conjunction with **CP2**. **CP8** deals with any opening or penetration within a building element, and **CP2** deals with the building element itself.

CP8 uses the term ‘to the degree necessary’. This word usage is designed to provide flexibility in the way this provision is implemented.

It means that the BCA recognises that different building elements require differing levels of protection, depending on the circumstances within which they are used and installed. The expression is intended to allow the appropriate authority to determine the degree of compliance necessary in each particular case.

Any decision made in this context can extend to not requiring an item to be installed or a particular level of performance to be achieved, if that is the appropriate action to be taken.

CP9

Fire brigade access essential

The attending fire brigade must, in many cases, have access to and around a building during a fire, to undertake search and rescue and fire-fighting operations.

Access for the fire brigade should take into consideration such matters as:

- The size and type of the brigade vehicles likely to be required to fight a fire in the building. Consideration should be given to ensuring that the access is wide enough for a large fire truck, able to support the truck’s weight, and incorporate a suitable hard stand area if the brigade needs to use pump units to fight the fire.

- The need for the brigade to fight the fire, considering such factors as the size and type of the building, the nature of any fire safety systems in the building, and the contents of the building.

CP9 uses the term ‘to the degree necessary’. This word usage is designed to provide flexibility in the way this provision is implemented.

It means that the BCA recognises that buildings need different types of fire brigade access. These differences depend on the matters listed in **CP9**.

Any decision made in this context can extend to not requiring an item to be installed or a particular level of performance to be achieved, if that is the appropriate action to be taken.

Any access for the fire brigade must be appropriate to their needs and the type of vehicles and equipment to be used, having regard to the matters listed in **CP9**:

- the likelihood or risk of a fire occurring in the building;
- the size, load or intensity of any fire in the building; and
- the fire safety systems in the building, which can affect the rate of fire spread (eg if a sprinkler system is installed in a building, it will either extinguish the fire or reduce its growth rate).

Examples

The following examples indicate circumstances where fire brigade access may not be necessary:

- A small building, with a low level of occupancy and a low fire load may not require access.
- A building located in an area that does not have an operational fire service, or where the fire service is unlikely to reach the building during the course of a fire.

If the proposal being considered involves a Building Solution that is taking advantage of the Deemed-to-Satisfy Provisions, the Deemed-to-Satisfy Provisions contain detailed requirements regarding fire brigade access.

If an Alternative Solution to the Deemed-to-Satisfy Provisions in **Section C** is being used, it may be appropriate to assess it using the **Section C** Deemed-to-Satisfy Provisions for guidance purposes. It is stressed, however, that compliance with the Deemed-to-Satisfy Provisions is not compulsory if alternative means can be found to satisfy the appropriate authority that the Performance Requirements will be achieved. The building proponent should refer to **A0.9** for guidance on acceptable assessment methods for determining compliance with the Performance Requirements.

Verification Methods**CV1****Buildings on adjoining allotments**

CV1 is a means to verify whether or not a building proposal achieves the requirements of **CP2(c)** in minimising the risk of fire spreading between buildings on adjoining allotments. A fire in one building should not cause the spread of fire to another building, because such fire spread potentially endangers public safety, health and amenity.

It is not compulsory for a designer to use **CV1**. The designer has the choice of using:

- **CV1** to verify that a proposal achieves **CP2(c)**;
- the Deemed-to-Satisfy Provisions of Part **C3**; or
- another means of verifying that **CP2(c)** will be achieved.

If **CV1** is used to calculate the level of heat flux, it is important to calculate the level at all the points referred to in **Table CV1**. The maximum level is not necessarily at the boundary. The size and shape of the openings will influence the level of heat flux.

Whether a material will ignite from radiant heat depends on the amount of heat and whether an ignition source (such as a spark) is present.

Examples

The following values give some typical examples of the amount of radiant heat necessary to ignite common materials used in buildings and their construction. Note, these figures should not be taken to be absolute, and may be subject to a range of variables.

- **Timber**
 - Ignition in the absence of a spark 35 kw/m²
 - Ignition in the presence of a spark 20 kw/m²
- **Curtain materials**
 - Ignition in the absence of a spark 20 kw/m²
 - Ignition in the presence of a spark 10 kw/m²

There are three mechanisms for transferring heat:Conduction

Conduction is the transfer of heat from one source to the other when they are in contact.

Convection

Takes place when the flames or fire plume carry the heat to another body. Convection includes the carrying of embers from a burning body that can cause ignition of a second body.

Radiation

Radiation is the transfer of heat from one body to another. In essence this involves one body putting out enough heat to heat up another body without any form of contact, either directly or by way of flames or embers.

Radiation is the main mechanism for heat and fire spread between buildings.

By way of techniques developed in the field of physics, it is possible to calculate the amount of heat given off by a burning building. The answer depends on a number of factors, including:

- the distance from the building;
- the size and shape of the openings in the building;
- the temperature of the fire, which will depend on the —
 - size of the fire, and
 - type of materials burning; and
- the emissivity of any glass in openings in the building. The emissivity is, in comparatively simple terms, a measure of radiant heat reduction through a window opening. The maximum value is 1, but lower figures may be appropriate, depending on such factors as:
 - whether the opening is drencher protected, or
 - whether the opening is a fire window.

CV2**Buildings on the same allotment**

CV2 is essentially the same as **CV1**, except that it deals with the spread of fire between two buildings on the same allotment.

It is not compulsory for a designer to use **CV2**. The designer has the choice of using:

- **CV2** to verify that a proposal achieves **CP2(c)**;
- the Deemed-to-Satisfy Provisions of Part **C3**; or
- another means of verifying that **CP2(c)** will be achieved.

The figures in **Table CV2** are essentially the same as those in **Table CV1**, if an assumption is made that the boundary dividing the buildings to which **Table CV1** is applied is half way between each building.

For further information on the use of **CV2**, refer to the comments on **CV1**.

PART C1 FIRE RESISTANCE AND STABILITY

Objective

Functional Statements

Performance Requirements

The Objective, Functional Statements and Performance Requirements for **Section C** are at the beginning of **Section C**.

Deemed-to-Satisfy Provisions

C1.0 Deemed-to-Satisfy Provisions

Intent

To clarify that the requirements of **CP1 to CP9** will be satisfied if a building complies with Parts **C1**, **C2** and **C3**, and Parts **G3** and **H1**, if applicable.

Most buildings

C1.0 clarifies that for most buildings compliance with Parts **C1**, **C2** and **C3** will achieve compliance with **CP1 to CP9**. The exceptions to this general rule are as follows:

- If the building contains an atrium, it must comply with Part **G3** in addition to Parts **C1**, **C2** and **C3**.
- If the building comprises of a theatre, stage or public hall it must comply with Part **H1** in addition to Parts **C1**, **C2** and **C3**.
- If the building contains an atrium and one or more theatre, stage or public hall, it must comply with Parts **C1**, **C2**, **C3**, **G3** and **H1**.

C1.1 Type of construction required

Intent

To establish the minimum fire-resisting construction required for Class 2-9 buildings.

Minimum type of construction required

C1.1(a) sets out the minimum type of fire-resisting construction required by the **Deemed-to-Satisfy Provisions** for all Class 2–9 buildings.

C1.1(b) explains that Type A construction is the most fire-resistant, Type C construction is the least fire-resistant, and Type B construction falls between these two.

Class and height (rise in storeys)

Table C1.1 explains that the required type of construction of a building depends on risk levels as indicated by the Class of building and the building's height as indicated by the rise in storeys. Note that there could be other factors that need to be considered. For example, **C2.2** and **Table C2.2** examine the maximum permissible size of fire compartments or atriums in buildings for specific types of construction.

Class of building

The Class of building is a measure of the building's likely:

- use;
- fire load;
- population; and
- mobility of the occupants, such as whether they are sleeping or alert.

Example

Research indicates that if a fire occurs while a person is asleep, the smell of the smoke will not wake them. Response times in residential buildings are longer than in other types of buildings. The BCA thus requires a higher type of construction in residential buildings. See **Table C1.1**.

Height of building (rise in storeys)

The height (rise in storeys) of the building is relevant as a measure of likely evacuation times and evacuation difficulty.

Types of construction and Alternative Solutions

When using an **Alternative Solution**, Part **C1** does not apply and there is no need to refer to the types of construction. Nonetheless, if building proponents using **Alternative Solutions** wish to use Part **C1** as part of the solution, they can.

C1.2 Calculation of rise in storeys

Intent

To establish a method for the calculation of the rise in storeys of a building, as a means of helping determine a building's required type of construction.

What is the rise in storeys? — C1.2(a)

Under **C1.2(a)**, the rise in storeys is the sum of the greatest number of storeys at any part of the external walls of a building and any storeys within the roof space above ground level. The reason for the inclusion of any storey within the roof space is that the storey may not have any external walls such as occur with a hip roof.

C1.2(a)(i) and **(ii)** distinguish between the situation where the part of the external walls is within the allotment (in which case it is calculated above finished ground level — **C1.2(a)(i)**), or on the allotment boundary (in which case it is calculated above finished ground level at that point — **C1.2(a)(ii)**).

The rise in storeys is the criteria used to determine the type of construction. This is because the rise in storeys has an impact on:

- the risk of exposure to radiant heat from a fire in another building;
- the risk of emitting radiant heat to another building; and
- the risk to occupants who may need to travel down a stairway to safely evacuate the building.

Definition of storey

'Storey' is defined in **A1.1**. It is advisable to refer to this definition before calculating the rise in storeys of a building.

Calculation of rise in storeys

The calculation of the rise in storeys includes larger mezzanines (see **C1.2(d)(i)**) and situations where two or more mezzanines can create a similar impact to larger mezzanines (see **C1.2(d)(ii)**) because of their potential fire load).

The calculation excludes machinery or similar plant rooms at the top of the building because they do not add significantly to the building's fire load (see **C1.2(b)(i)**) and storeys below ground level in particular circumstances outlined in **Figure C1.2(1)**. This is because basements are not exposed to radiant heat from a fire in another building, nor do they emit any significant heat horizontally (see **C1.2(b)(ii)**).

Figure C1.2(1) illustrates when a storey below ground level is included in the calculation of the rise in storeys of the building.

Class 7 or 8 with internal storey height over 6 metres — C1.2(c)

Under **C1.2(c)**, a Class 7 or Class 8 building with more than one storey above ground level (see **C1.2(c)(i)**) and which has an internal storey height of 6 metres or more is, from the point of view of potential fire load, considered to be the equivalent to 2 storeys (see **C1.2(c)(ii)**).

Examples of calculating rise in storeys

Figure C1.2(2) illustrates some examples of calculating the rise in storeys of a building.

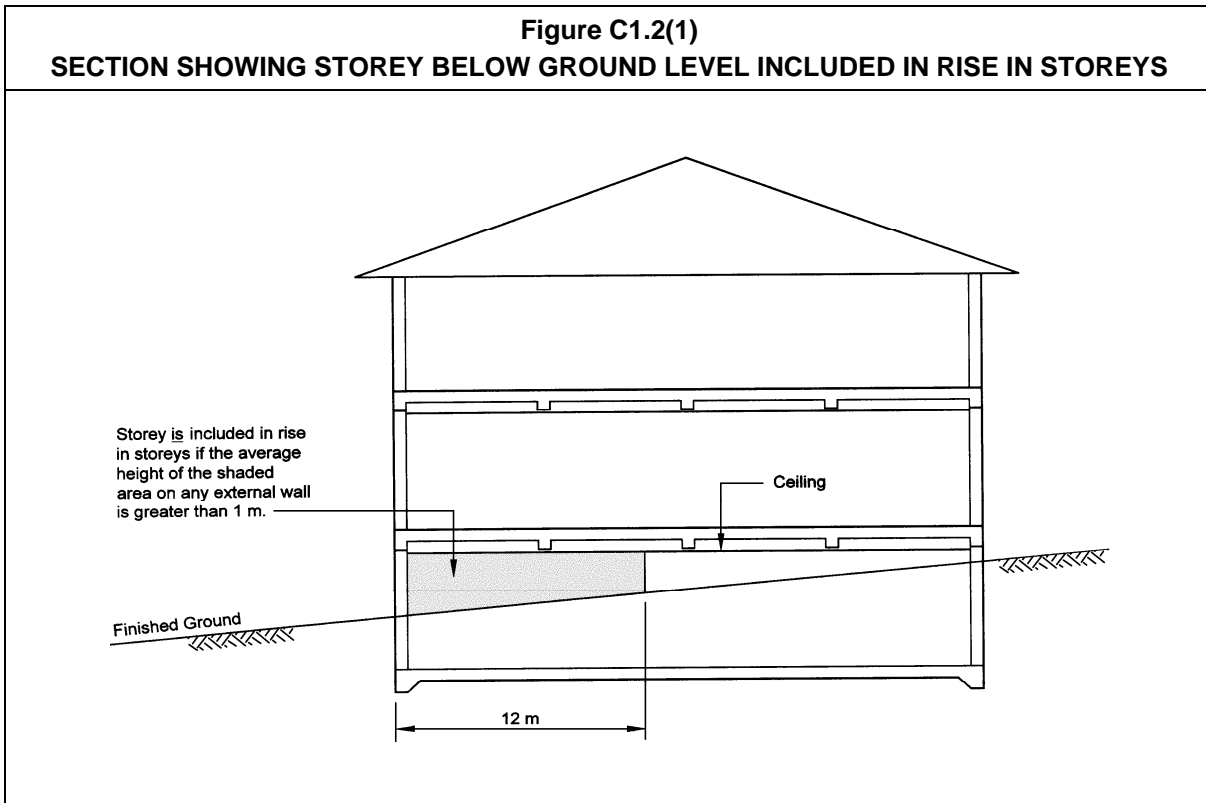

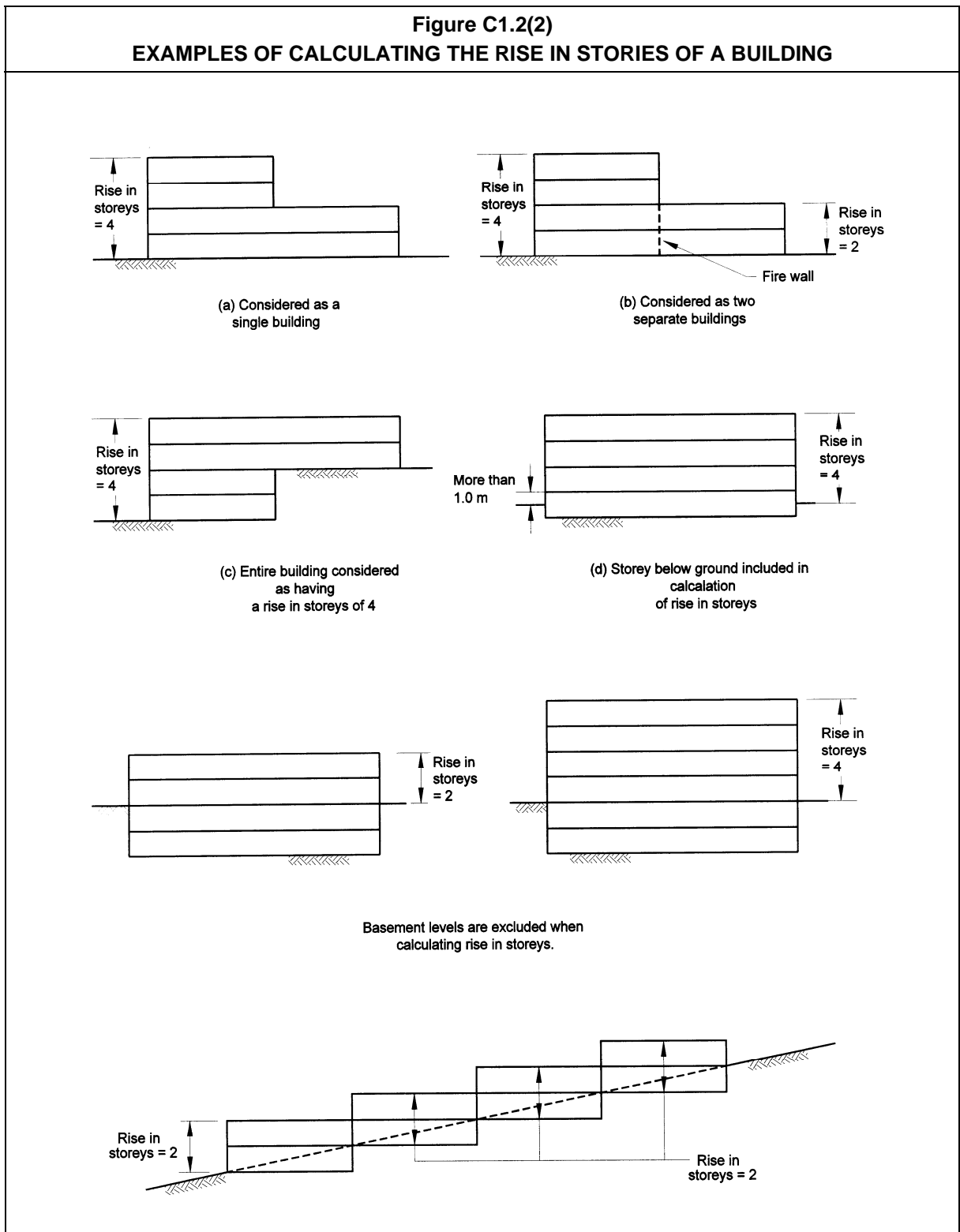

C1.3 Buildings of multiple classification

Intent

To establish the type of construction required for a building that contains more than one Class.

Procedure for determining type of construction

In a building comprising multiple classifications, the type of construction applicable to the classification of the top storey applies to all the storeys below it. **Figure C1.3(1)** illustrates this. This method is used to determine the type of construction only, and not the FRLs required for the different classifications.

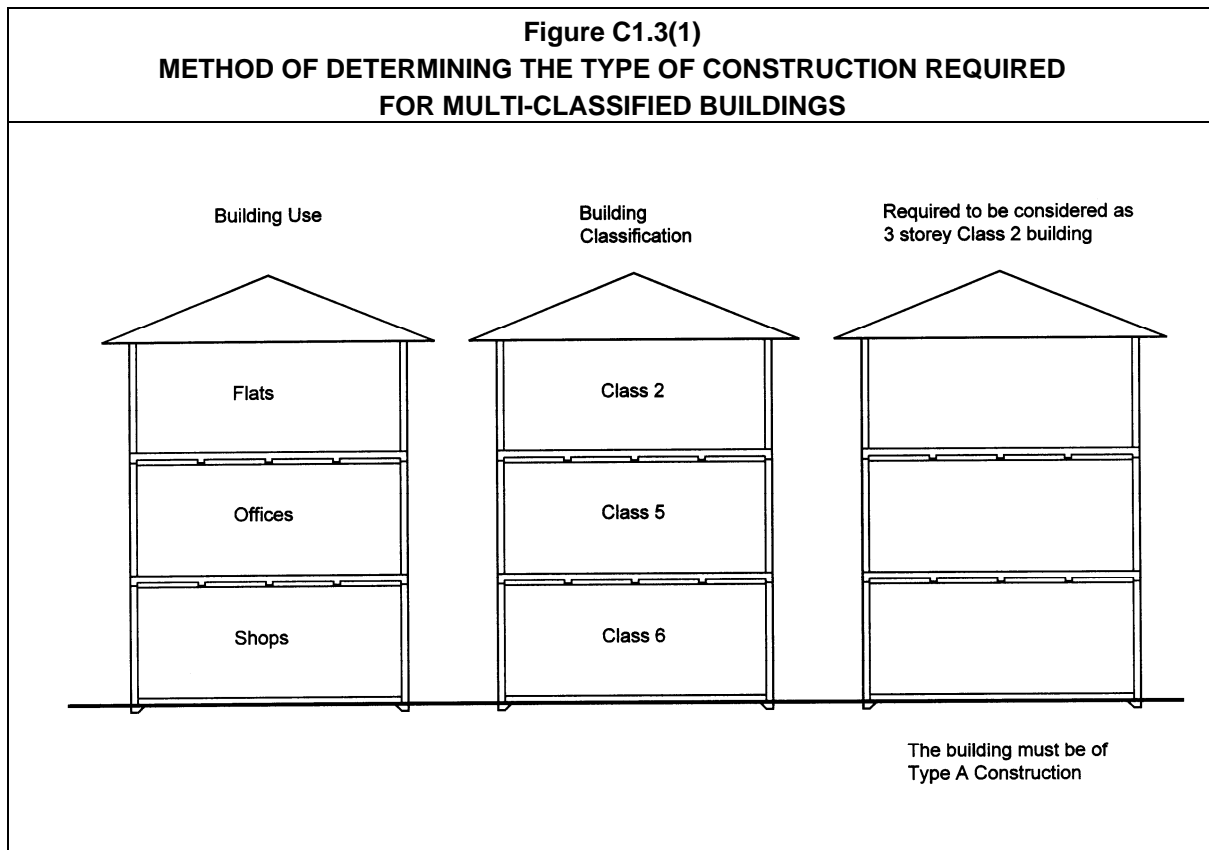

Where a Class 4 part comprises the top storey

To determine the type of construction required when a Class 4 part of a building occupies the whole of the top storey, the class of the next highest storey should be applied to the top storey.

C1.6 must be used to determine the appropriate FRLs for the building elements in the Class 4 part of the building. See **Figure C1.3(2)**.

Example

In a 3 storey building with the lower 2 storeys of Class 5 and the top storey entirely of Class 4 the Class 5 classification would be applied to the top storey. Thus the required type of construction by the use of **Table C1.1** would be Type B construction.

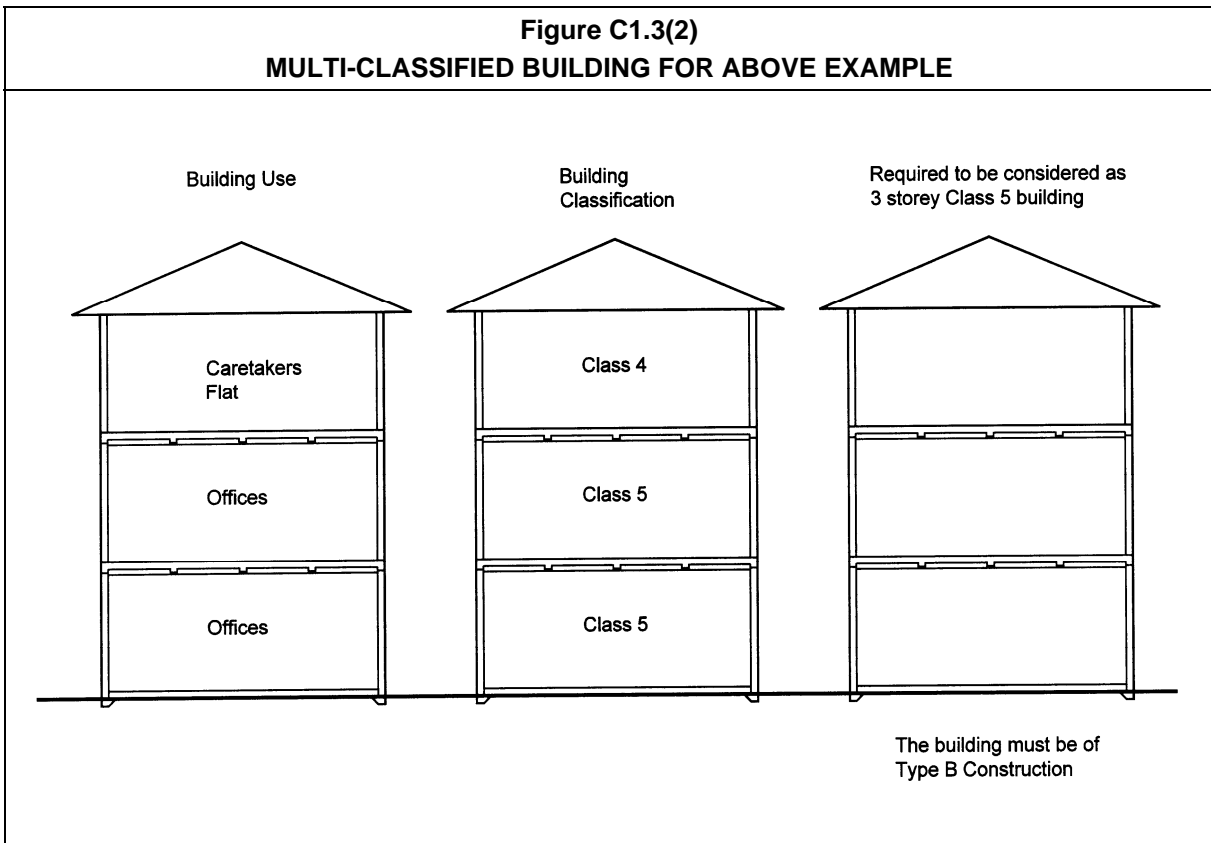

C1.4 Mixed types of construction

Intent

To specify the circumstances in which a building may be of more than one type of construction.

Separation by a fire wall

The only circumstance in which the Deemed-to-Satisfy Provisions allow a building to be of different types of construction is when the types are separated from one another by a fire wall as described in **C2.7(b)**.

Different types must not be above one another

In no case do the **Deemed-to-Safety Provisions** allow different types of construction to be above one another.

C1.5 Two storey Class 2, 3 or 9c buildings**Intent**

To grant concessions for–

- low-rise Class 2 and Class 3 buildings provided with a good means of egress; and
- sprinkler protected Class 9c aged care buildings.

Low-rise Class 2 and Class 3 buildings

The concession for Class 2 and Class 3 buildings is made on the basis that the level of risk to occupants does not warrant the full application of the type of construction requirements.

The circumstances outlined in **C1.5(a)** and **(b)** are alternative options. They do not have to both exist to bring the **C1.5** concession into operation.

The concession also applies to a building containing a mixture of Class 2 and Class 3.

Figure C1.5 illustrates an example of the use of the concession allowed by **C1.5**.

Low-rise Class 9c buildings

The concession for Class 9c buildings recognises the benefits of sprinkler systems and differences between Types A, B and C construction.

C1.6 Class 4 parts of buildings**Intent**

To specify that Class 4 parts of buildings are subject to the same requirements for fire-resistance levels (FRLs) and separation as would apply to Class 2 parts in similar circumstances.

Class 4 FRLs the same as Class 2

The reason for requiring the same FRL for a Class 4 as a Class 2 building is because the two different classifications have similar fire loads.

In a building fire, the people most at risk include those who are sleeping. It is therefore important that the residential part of the building be fire separated from the other parts. The

fire-resistance levels (FRLs) required for structural elements in a Class 4 part of a building are identified in **Tables 3, 4 or 5** of **Specification C1.1**.

PART C1 – FIRE RESISTANCE AND STABILITY

Figure C1.5
EXAMPLE OF THE CONCESSION ALLOWED BY C1.5

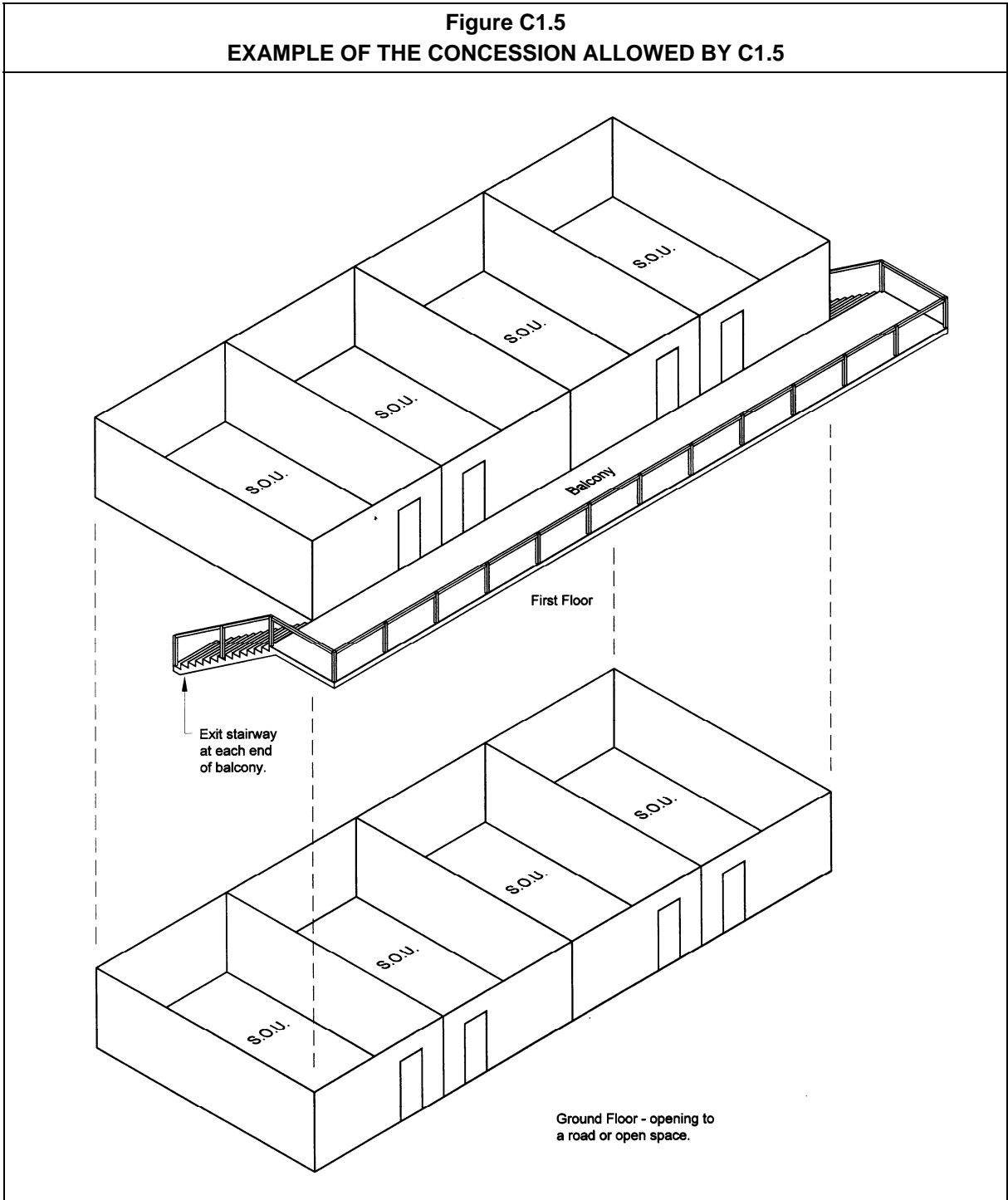

C1.7 Open spectator stands and indoor sports stadiums

Intent

To grant a concession for open spectator stands and indoor sports stadiums.

Indoor sports stadiums

Under specified circumstances (see **C1.7(a)**), an indoor sports stadium may be of Type C construction.

The reason for this concession is that although an indoor sports stadium may have a high population, particularly during an event, it generally has a lower fire load than other Class 9b buildings. For example, in most stadiums:

- large areas are usually inaccessible to the public (being taken up as part of the sporting events); and
- the finishes are generally spartan.

Open spectator stand

Under specified circumstances (see **C1.7(a)**), an open spectator stand may be of Type C construction. The reason for this concession is that an open spectator stand generally has a low fire load, even though it may have a high population, particularly during an event; and is open at the front thereby not allowing the build up of smoke and heat.

Tier of seating — **C1.7(b)** and **Figure C1.7**

C1.7(b) refers to a ‘tier of seating’. This describes the levels of seating in an open spectator stand. **Figure C1.7** illustrates a single tiered open spectator stand, and a two tiered open spectator stand.

C1.8 Lightweight construction

Intent

To specify the requirements for the use of lightweight construction in:

- circumstances which require walls with a fire-resistance level (FRL);
- certain high use buildings; and
- fire-resisting covering of steel columns or the like.

Definition of ‘lightweight construction’

Refer to **A1.1** for the definition of ‘lightweight construction’.

Figure C1.7
SINGLE TIERED AND TWO TIERED SEATING IN AN OPEN SPECTATOR STAND

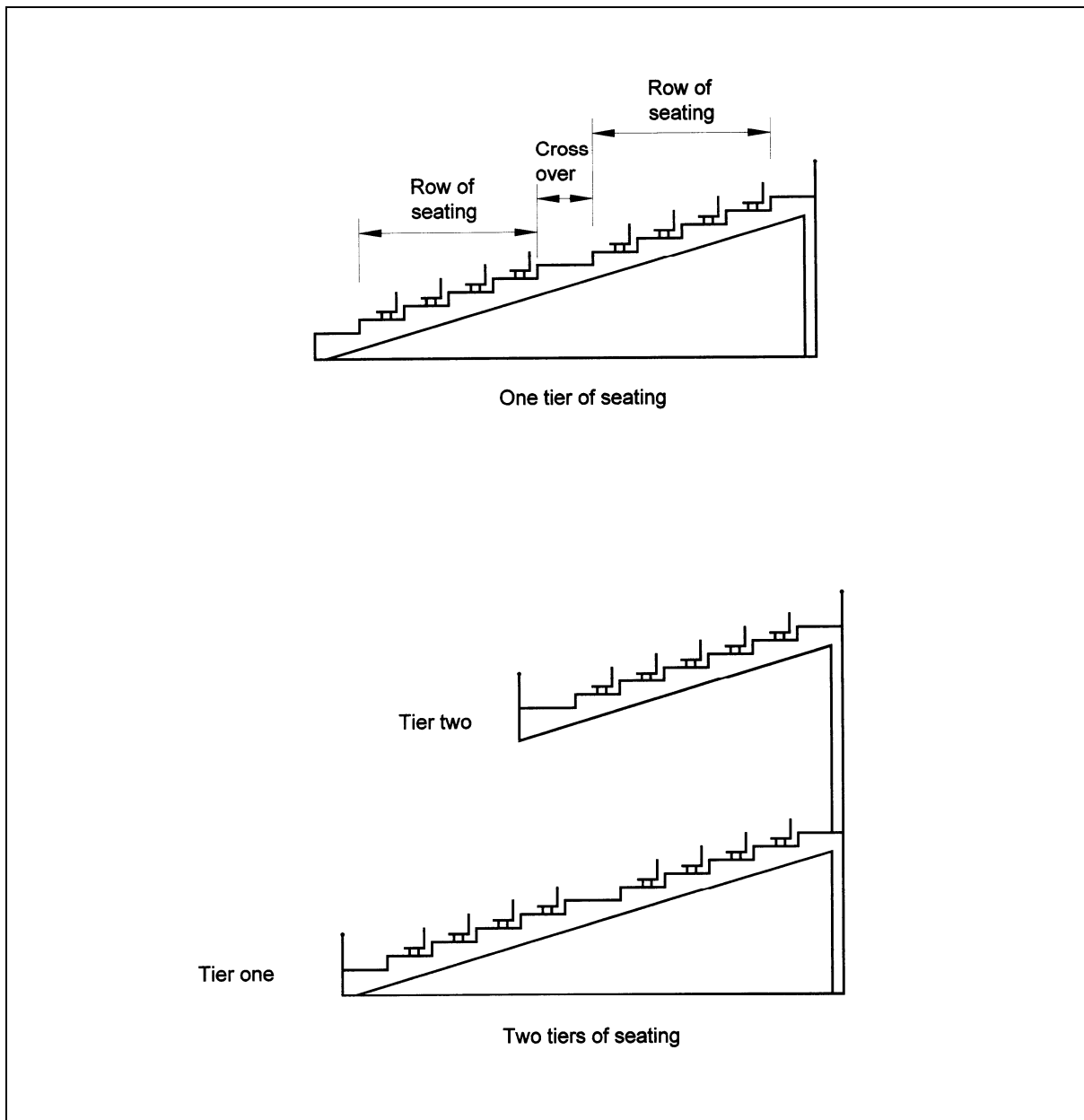

Lightweight construction needs protection

Lightweight construction needs protection to preserve its integrity from mechanical damage in a fire or other situation where it may be particularly subject to risk of damage. This is because

it is generally more susceptible to damage than other forms of wall construction, such as concrete (which does not contain soft materials) and masonry thicker than 70 mm.

Specification C1.8

To make sure lightweight construction performs correctly, **C1.8** states that it must comply with **Specification C1.8**. This Specification sets down tests which such construction must satisfy.

Walls required to have an FRL — C1.8(a)(i)

Lightweight construction used in any wall system required to have a FRL must comply with **Specification C1.8** (see **C1.8(a)(i)**).

Walls not required to have an FRL — C1.8(a)(ii)

Lightweight construction must also comply with **Specification C1.8** if it is used in a wall system which is not required to have a FRL, but is specifically listed in **C1.8(a)(ii)** or in a building specifically listed in **C1.8(a)(ii)**.

There is no requirement to comply with **Specification C1.8** where lightweight construction is used for walls which:

- are not listed in **C1.8(a)(ii)**; and
- are in buildings which are not listed in **C1.8(a)(ii)**; and
- do not require fire-resistance levels.

Fire-resisting covering of steel columns — C1.8(b)

C1.8(b) sets out the circumstances under which lightweight construction is permitted to be used as a fire-resisting covering for steel columns and the like.

C1.9 * * * * *

In BCA 1990, this provision related to Class 1 and Class 10 buildings, which are now covered in Volume Two of BCA96. This is the reason why **C1.9** of BCA96 has been left blank, in accordance with the decision to retain the numbering of BCA 1990 for BCA96.

C1.10 Fire Hazard Properties

Intent

To stipulate the minimum fire hazard properties of materials susceptible to the effects of flame or heat.

Occupants must be able to evacuate

It is important that the spread of fire and the development of smoke be limited during a fire until building occupants have had time to evacuate. See **CP4**.

Specification C1.10

Materials and assemblies must comply with **Specification C1.10**. The core of **Specification C1.10** is the fire hazard properties tested in accordance with **AS 1530 Parts 1 and 2** and **AS/NZS 1530 Part 3**, specifically the Flammability Index, Spread-of-Flame Index, and Smoke-Developed Index.

C1.11 Performance of external walls in fire**Intent**

To minimise the risk of any concrete external wall collapsing outwards as a complete panel during a fire.

See the comments on **CP5** for the reasons for **C1.11**; and why **C1.11** only applies to a building having a rise in storeys of 1 or 2.

Specification C1.11

Specification 1.11 contains:

- detailed solutions to avoid the potential collapse, as whole panels, of concrete external walls in a building with a rise in storeys of 2 or less; and
- minimum design loads which panel connections must resist during a fire, to minimise the risk of panels collapsing outwards.

C1.12 Non-combustible materials**Intent**

To permit the use of certain materials which are known to provide acceptable levels of fire safety.

C1.12 lists materials deemed to be non-combustible. These materials may be used wherever a material is required to be non-combustible. In some instances the material may contain combustible components. The materials listed are not intended to apply to fire place hearths required by **G2.3**.

PART C2 COMPARTMENTATION AND SEPARATION

Objective

Functional Statements

Performance Requirements

The Objective, Functional Statements and Performance Requirements are at the beginning of [Section C](#).

Deemed-to-Satisfy Provisions

C2.0 Deemed-to-Satisfy Provisions

Intent

To clarify that the requirements of [CP1 to CP9](#) will be satisfied if a building complies with Parts [C1](#), [C2](#) and [C3](#), and Parts [G3](#) and [H1](#), if applicable.

[C2.0](#) clarifies that for most buildings compliance with Parts [C1](#), [C2](#) and [C3](#) will achieve compliance with [CP1 to CP9](#). The exceptions to this general rule are set out below:

- If the building contains an atrium, it must comply with Part [G3](#) in addition to Parts [C1](#), [C2](#) and [C3](#).
- A building which comprises a theatre, stage or public hall must comply with Part [H1](#) in addition to Parts [C1](#), [C2](#) and [C3](#).
- If the building contains an atrium and one or more of a theatre, stage or public hall, it must comply with Parts [C1](#), [C2](#), [C3](#), [G3](#) and [H1](#).

C2.1 Application of Part

Intent

To clarify that the floor area limitations of Part [C2](#) do not apply to certain buildings.

The floor area limitations of Part [C2](#) do not apply to a carpark containing a sprinkler system complying with [Specification E1.5](#), an open-deck carpark or an open spectator stand.

C2.2 General floor area and volume limitations

Intent

To limit the size of any fire in a building by limiting the size of the floor area and volume of a fire compartment.

Allowable size of the fire compartment

Under **C2.2(a)** and **Table C2.2**, the allowable size of the fire compartment depends on two things. The first is the type of construction, which is a measure of a building's ability to resist a fire. The second is the classification of the building, which is an indicator of a building's potential fire load.

Example

In the case of a Class 7 building which has an area of 3 000 m², **C2.2** enables three potential solutions. The building can be:

- Type C construction if it is divided into fire compartments with areas less than those specified in **Table C2.2**, or if use can be made of the concessions and requirements of **C2.3(a)**; or
- Type A or Type B construction, because the area of the building falls within that permitted under **Table C2.2**.

Machinery and plant rooms

Under **C2.2(b)**, machinery and plant rooms at the top of a building are not included in the calculation of a building's floor area or volume of a fire compartment. The BCA assumes that such rooms represent a low risk to people in case of fire because of the generally:

- low fire load;
- low number of people who use them; and
- as the occupants of most buildings evacuate downwards, a fire in a plant room at the top of a building will generally not interfere with the ability to evacuate.

Atriums

Under **C2.2(c)**, in an atrium, the area of the atrium well above the floor of the atrium is excluded from the volume calculation because there is space in which to store materials, thus it is assumed that it does not contribute to the fire load. See **Part G3**.

Class 9c buildings

Table C2.2 allows sprinkler protected Class 9c buildings to have a maximum fire compartment size of–

- if the building is of Type A construction – 8 000 m²; or
- if the building is of Type B construction – 5 000 m²; or
- if the building is of Type C construction – 3 000 m².

Buildings of mixed classifications

C2.2 makes no reference to the use of **Table C2.2** for a building containing mixed classifications. The table specifies the maximum allowable floor area of certain buildings.

To calculate the maximum permissible floor area, firstly take the percentage of each classification as a proportion of the actual floor area of the building.

Then, use this percentage to calculate the proportion of the maximum floor area permitted for that classification in **Table C2.2** and then add each of those calculations together to come to a maximum permitted floor area for the combined classifications. To see this illustrated in simpler terms refer to the example below.

Example

Figure C2.2 shows a building of Type C construction containing a factory (Class 8) with an office (Class 5) at the front. The total area of the building is 2 100 m².

The area of the Class 8 portion of the building is 80% (1 680 m²) of the floor area of the whole building (that is, the combined Class 8 and Class 5 portions).

The area of the Class 5 portion of the building is 20% (420 m²) of the floor area of the whole building (that is, the combined Class 8 and Class 5 portions).

To determine if such a building complies with **Table C2.2**, the following calculations are necessary:

- Maximum area of Class 8 allowed by Table C2.2 = **2 000 m²**
- The percentage of Class 8 is 80% = 80% of 2 000 m² = **1 600 m²**
- Maximum area of Class 5 allowed by Table C2.2 = **3 000 m²**
- The percentage of Class 5 is 20% = 20% of 3 000 m² = **600 m²**
- Maximum allowable floor area = 1 600 + 600 = **2 200 m²**

The maximum allowable floor area of the building is **2 200 m²**. Therefore, the building in this example complies with **Table C2.2**. The fact that the Class 8 portion exceeds 1 600 m² is irrelevant for the purposes of this process. However, that portion is not permitted to exceed 2 000 m².

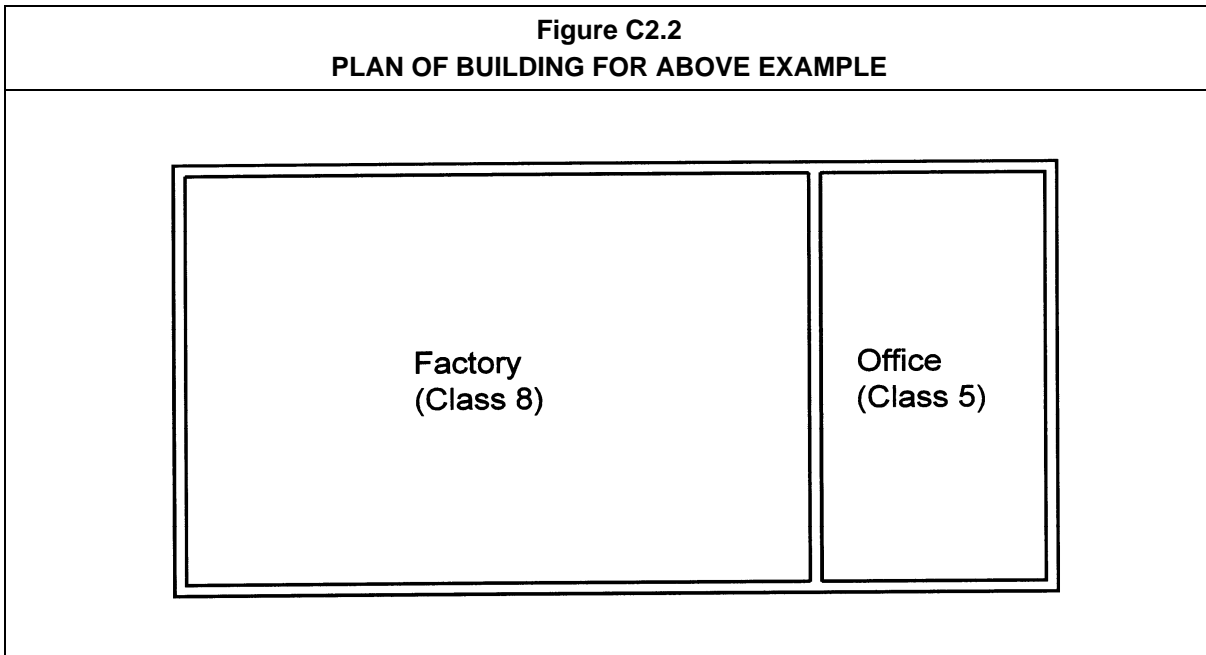

C2.3 Large isolated buildings

Intent

To grant concessions for large isolated buildings from the floor area and volume limitations.

Up to 18 000 m² floor area and 108 000 m³ volume

Under **C2.3(a)**, a building with a floor area of 18 000 m² or less and a volume of 108 000 m³ or less is permitted to have fire compartments which exceed the requirements of **Table C2.2**, if it complies with the requirements outlined below as applicable:

- Where the building is either Class 7 or Class 8, and is 2 storeys or less, has open space around the building which is not less than 18 metres wide in compliance with **C2.4(a)** and has one of the following specified systems—
 - automatic fire detection or alarm system (see **C2.3(a)(i)(A)**);
 - automatic smoke exhaust system (see **C2.3(a)(i)(B)**);
 - automatic smoke-and-heat ventilation system (see **C2.3(a)(i)(C)**); or
 - natural ventilation system (see **C2.3(a)(i)(D)**).
- Where the building is Class 5-9 (including Class 7 and Class 8), has a sprinkler system complying with **Specification E1.5** and has vehicular access complying with **C2.4(b)**, as set out in **C2.3(b)**.

Over 18 000 m² in floor area or 108 000 m³ in volume

Under **C2.3(b)**, a building with a floor area of more than 18 000 m² or a volume of more than 108 000 m³ is permitted to have fire compartments which exceed the requirements of **Table C2.2** if it is protected with a sprinkler system complying with **Specification E1.5**, has vehicular access complying with **C2.4(b)**, and:

- where there is a ceiling height of 12 metres or less, has either a specified smoke exhaust system, or a smoke-and-heat ventilation system (see **C2.3(b)(i)**); and
- where there is a ceiling height of more than 12 metres, has a specified smoke exhaust system (see **C2.3(b)(ii)**).

More than one building on allotment

Where there is more than one building on the allotment, each building may have fire compartments which exceed the requirements of **Table C2.2**, if each building complies with **C2.3(a)** or **C2.3(b)**, or if the buildings are closer than 6 metres, they both must comply with **C2.3(a)** or **C2.3(b)**, as applicable, as if they were one building.

If the buildings are separated by a fire wall complying with **C2.7**, the entire building, regardless of the level of fire compartmentation, must comply with **C2.3(a)** or **C2.3(b)**, as applicable.

If more than two buildings are located on the same allotment and greater than 6 m apart, each individual building must comply with **C2.3(a)** or **C2.3(b)**, as applicable.

Roller shutters

Roller shutters and doors can be used for smoke venting purposes under **C2.3(a)(i)(D)** if they are 'readily openable'. A building proponent must satisfy the appropriate authority that such roller shutters and doors achieve the 'readily openable' requirement.

However, if the openings are also used for egress purposes, they must comply with the requirements of such provisions as **D2.19** and **D2.21**.

C2.4 Requirements for open spaces and vehicular access

Intent

To set the minimum requirements for open space around a building and the provision of vehicular access for the fire brigade.

The reason for the open space requirement is to minimise the risk of a fire spreading to another building.

C2.4(a) specifies the compliance criteria for the open space required under **C2.3**. The open space must be wholly within the allotment. However, the open space may also include

everything except what is beyond a line drawn six metres from the farthest edge of a road, river or public place adjoining the allotment.

The open space must also include the vehicular access required by **C2.4(b)**, not be used for storage or processing and not be built on, except as specified.

This provision requires the making of a ‘performance-style’ judgement. It is the responsibility of the building proponent to satisfy the appropriate authority that any buildings on the open space will not unduly impede the activities of the fire brigade, nor add to the risk of fire spreading to a building on an adjoining allotment.

Figure C2.4 illustrates compliance with **C2.4**.

The reason for the fire brigade vehicular access is to enable the brigade to intervene to fight the fire, assist with evacuation, and stop the spread of a fire to another building. The vehicular access also provides other emergency services personnel, such as ambulance officers, with the ability to access the building as necessary.

C2.4(b) specifies the compliance criteria for the vehicular access required by Part **C2**.

The required vehicular access must have access from the public road system (see **C2.4(b)(i)**) and must have the width, height and loadbearing capacity to allow the passage and parking of fire brigade vehicles (see **C2.4(b)(ii)** and **(iv)**).

It must also have the necessary pedestrian access to the building (see **C2.4(b)(iii)**). This access may be from a public road which otherwise complies with the various requirements of **C2.4(b)** (see **C2.4(b)(v)**).

To achieve compliance with these provisions it is advisable to check with the local fire brigade, due to the varying sizes and type of equipment and vehicles that may be required to fight a fire.

C2.5 Class 9a and 9c buildings

Intent

To protect patients in a health-care building and residents in an aged care building from the spread of fire and smoke.

General

It should be noted that **C2.5(a)** applies to Class 9a health-care buildings. **C2.5(b)** only applies to Class 9c aged care buildings.

Class 9a buildings — evacuation difficulties

Residents or patients of Class 9a buildings are often unable to evacuate a building without assistance. They may be incapable of walking or bedridden. It is important to make sure that fire and smoke only affects small areas of the building.

C2.5(a)(i) requires compartmentation for the control of smoke and fire.

Figure C2.4
EXAMPLES OF COMPLIANCE WITH C2.4

Sprinkler system
throughout building.

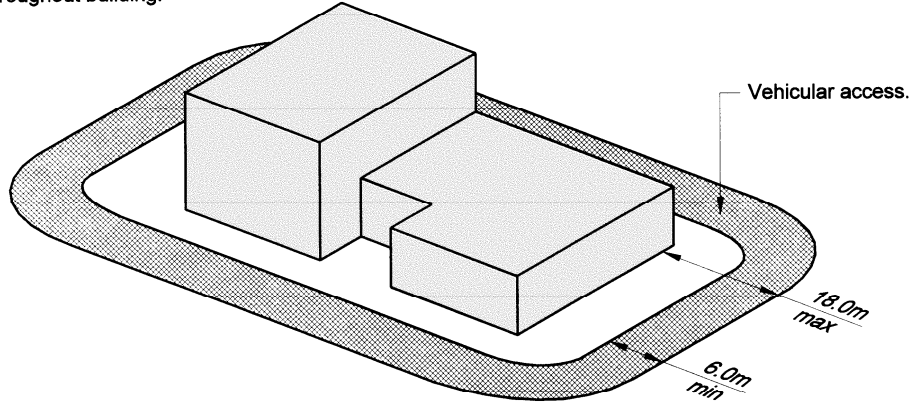

a) Floor area 18,000m² max, volume 108,000m³ max.

Sprinkler system
throughout building plus
smoke exhaust.

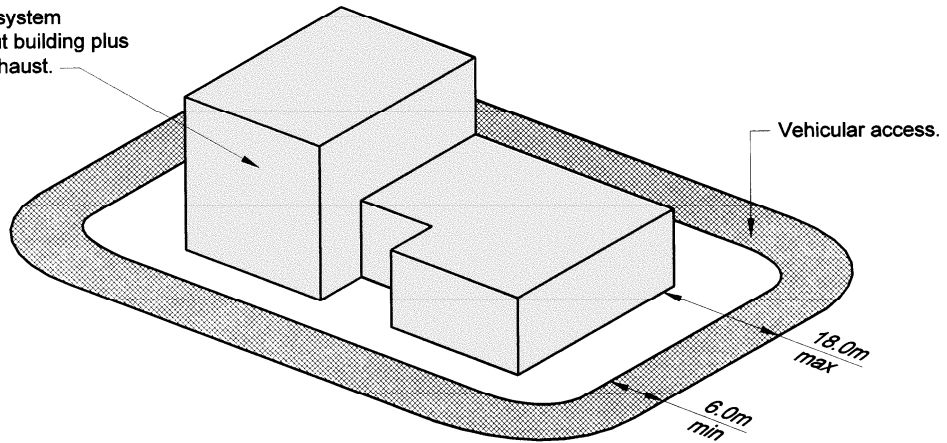

b) Floor area 18,000m² min, volume 108,000m³ min.

C2.5(a)(ii) and **(iii)** require sub-compartmentation in certain areas to allow for the staged evacuation of patients from the building. However, usually successful evacuation depends on assistance being provided to evacuees by an adequate number of staff.

The requirements for smoke proof walls and doors are contained in **Specification C2.5**.

C2.5(a)(iv) and **(v)** make it necessary to separate potential sources of fire from any patient care area. **C2.5(a)(iv)** has construction requirements for fire compartments in Class 9a buildings.

Figure C2.5 illustrates one means of complying with **C2.5**.

The first part of the figure shows how the administrative area of a hospital has been separated from the patient care area by a fire wall because the patient care area has a floor area of 2000 m², the maximum permitted under **C2.5(a)(i)**.

The second part of the figure shows how the ward area must be subdivided into areas with a maximum floor area of 1 000 m² by a wall with an FRL of 60/60/60.

Some floors of Class 9a buildings may require an FRL

Compliance with **C2.5(a)(iv)(B)** may require a floor in a Class 9a building of Type B construction to have a fire-resistance level (FRL). The reason for this is that it is important to inhibit the spread of fire between floors. Separation of storeys in a Class 9a building also requires any openings in external walls to be vertically separated in accordance with **C2.6**.

Class 9c buildings — evacuation difficulties

Residents of Class 9c buildings are often unable to evacuate without assistance. They may be incapable of walking or bedridden. It is therefore important to make sure that fire and smoke only affects small areas of the building, hence allowing residents sufficient time should evacuation be necessary.

Some walls and floors of Class 9c buildings may require an FRL

C2.5(b)(ii) requires certain walls and floors in Class 9c buildings to have a fire-resistance level (FRL). The reason for this is that it is important to inhibit the spread of fire for resident and occupant safety.

Compartmentation of Class 9c aged care buildings

The compartmentation required by fire rated and smoke proof walls for Class 9c aged care buildings is similar to that required for Class 9a buildings.

The required compartmentation and sub-compartmentation of Class 9c aged care buildings are to allow for the staged evacuation of residents from the building. However, successful evacuation usually depends on assistance being provided to evacuees by an adequate number of staff. The BCA provisions for Class 9c aged care buildings are based on minimal on duty on-site staff being available at any time.

C2.5(b)(i) requires a Class 9c aged care building to be subdivided into areas with a maximum area of 500 m² by smoke walls complying with **Specification C2.5**. No further subdivision of the fire compartments by smoke or fire rated walls is required. This recognises the benefits of sprinkler systems that must be installed in all Class 9c buildings.

Figure C2.5
PLAN SHOWING ONE METHOD OF COMPLYING WITH C2.5(a) FOR CLASS 9a BUILDINGS

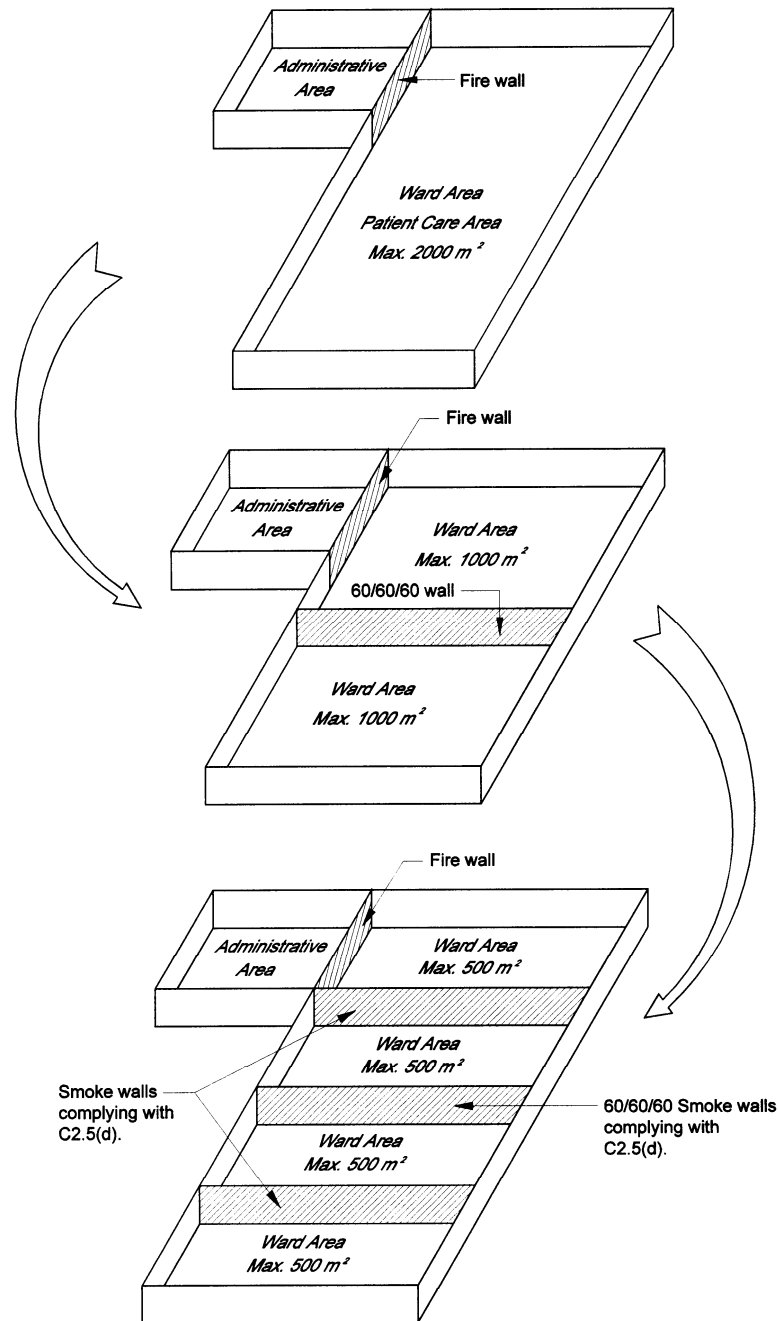

C2.6 Vertical separation of openings in external walls

Intent

To minimise the risk of fire spreading from one floor to another via openings in external walls in buildings of Type A construction.

Buildings of Type A construction

C2.6 generally applies to buildings of Type A construction and Class 9a buildings of Type B construction, because they are the only buildings required to provide fire separation between floors. This separation is achieved by the floor being required to have a fire-resistance level (FRL). It applies to openings above one another in different storeys if they are within a horizontal distance of 450 mm of each other.

It does not apply to:

- sprinkler protected buildings because the sprinklers should prevent the fire developing to the stage where it could spread to the floor above;
- openings in a fire-isolated stair shaft. This is because the stair shaft is not considered to be separate storeys and it is assumed that fire spread between floors will not occur via the stairway; or
- open-deck carparks and open spectator stands. This is because it is unlikely that fire would spread between floors in these types of buildings as their open construction allows the dissipation of the effects of fire.

In addition, Class 9a buildings of Type B construction require openings in external walls to be vertically separated in accordance with **C2.6** as if the building was Type A construction (see **C2.5(e)(ii)**). This can be achieved either by the construction methods outlined below or the installation of sprinklers in the building. The reason for this is that it is important to inhibit the spread of fire between floors in Class 9a buildings.

Protection of vertically separated openings

C2.6 requires the vertical separation of openings in external walls (see **C2.6(a)** and **(b)**) of buildings of Type A construction which do not have a sprinkler system complying with **Specification E1.5**. The vertical separation of openings can be achieved by either of the following methods:

- a non-combustible spandrel or other non-combustible vertical construction having an overall height of 900 mm or more, extending at least 600 mm or more above the upper surface of the intervening floor, and having an FRL of 60/60/60 (see **C2.6(a)(i)**) as shown in **Figure C2.6(1)**; or
- a non-combustible horizontal projection having an outwards projection from the external face of the wall of 100 mm or more, an extension along the wall beyond the openings of at least 450 mm, and having an FRL of 60/60/60 (see **C2.6(a)(iv)**) as shown in **Figure C2.6(2)**.

If the external wall of the building is a glass curtain wall, **C2.6(a)(iii)** contains specific provisions to stop or limit the spread of fire and smoke between the glass and the edge of the concrete floor. The details are shown in **Figure C2.6(3)**.

Although it could be argued that the spandrel or vertical projection should have the same FRL as the floor separating the storeys, this has not been found to be necessary.

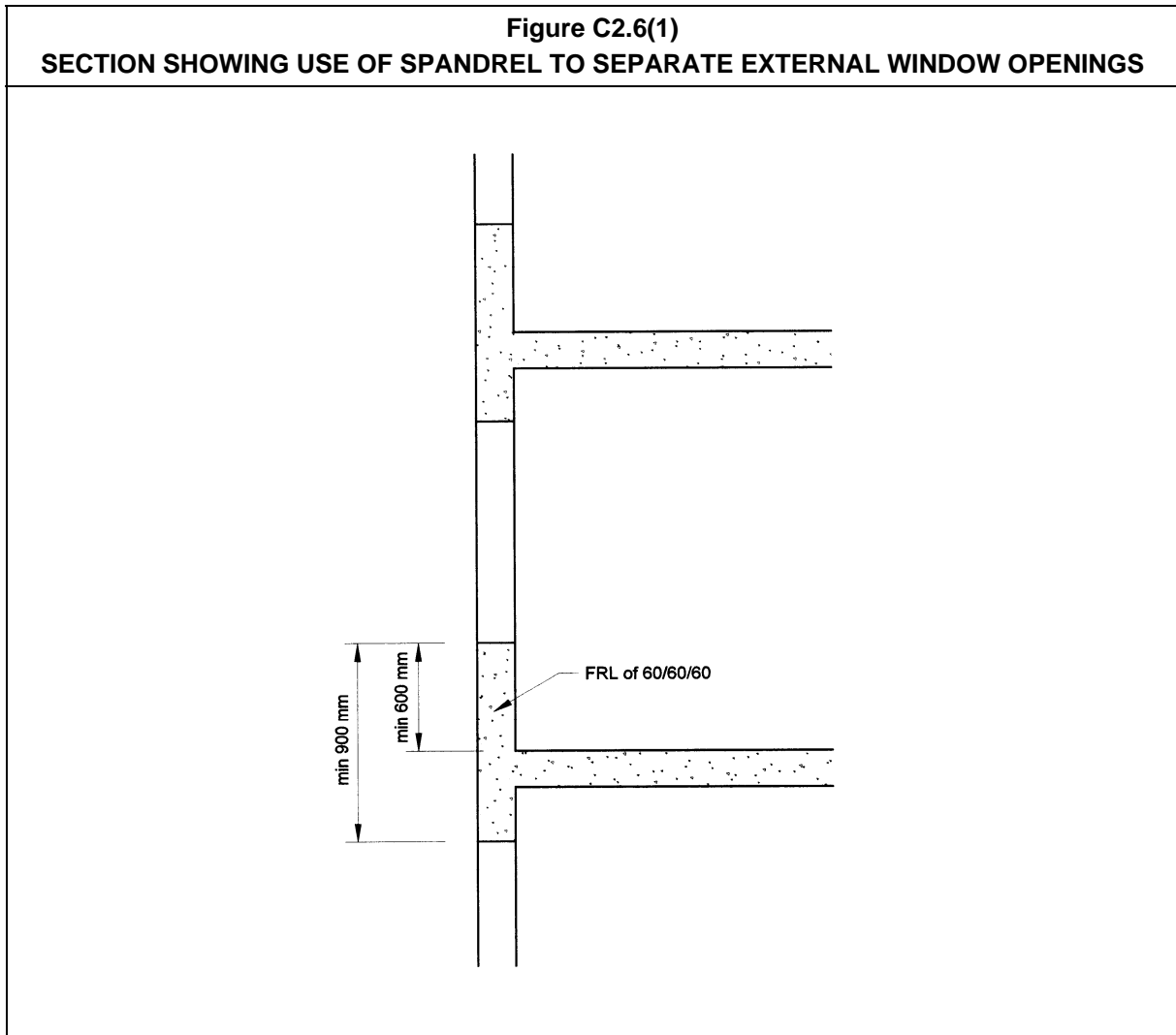

Figure C2.6(2)
EXAMPLE SHOWING USE OF SLAB OR HORIZONTAL CONSTRUCTION
TO SEPARATE EXTERNAL WINDOW OPENINGS

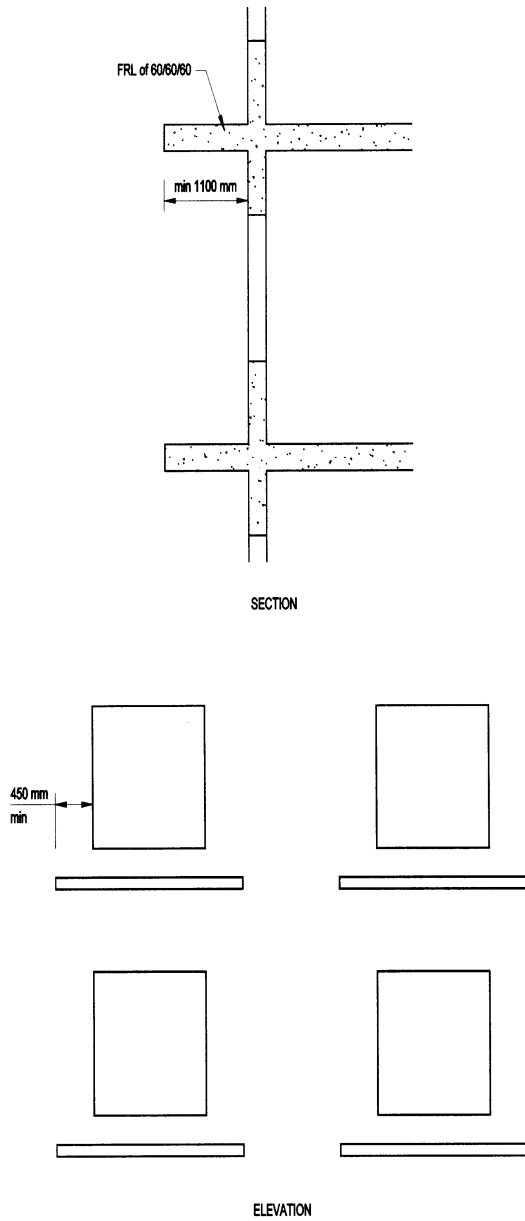
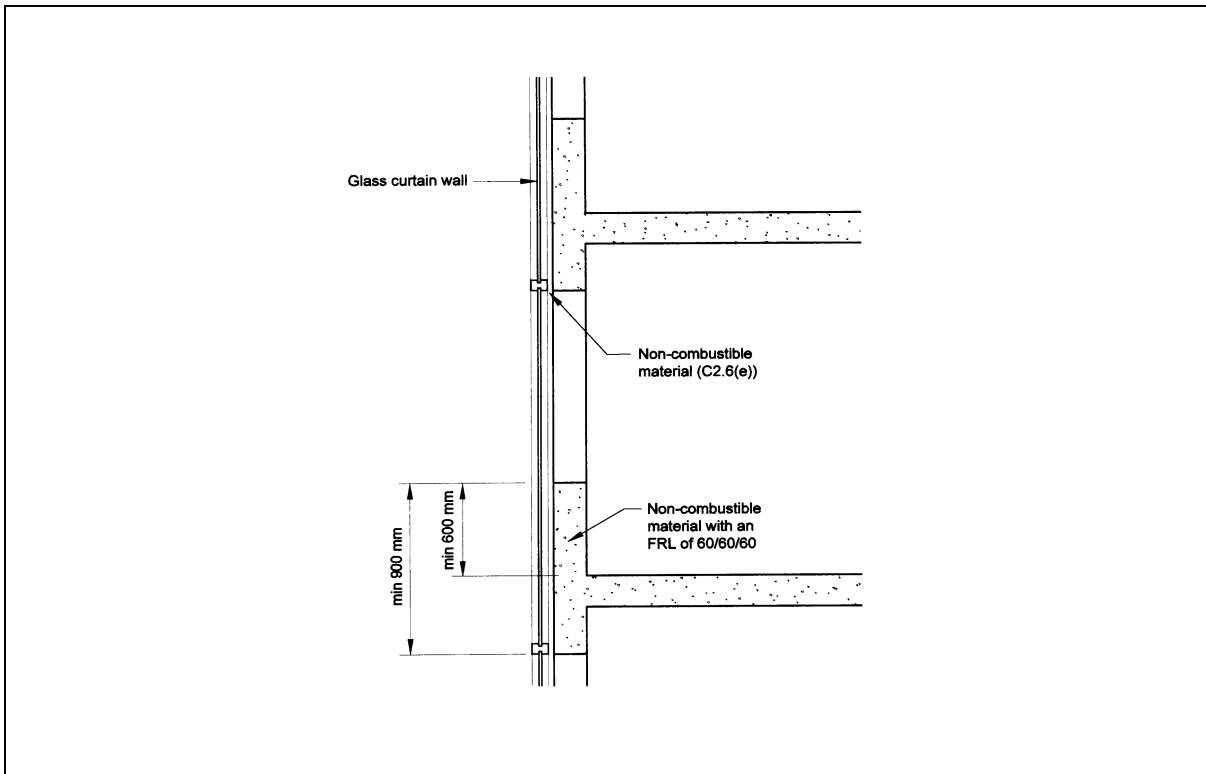

Figure C2.6(3)
SECTION SHOWING SEPARATION OF EXTERNAL
WINDOW OPENINGS IN A CURTAIN WALL



C2.7 Separation by fire walls

Intent

To explain that buildings separated by a fire wall may be considered as fire compartments or be regarded as separate buildings.

Construction

C2.7(a) outlines how a fire wall is to be constructed.

C2.7(a)(i) sets out the required FRL of a fire wall. If any part adjoining the fire wall is required to have a higher FRL, the fire wall must achieve the higher FRL. The exception occurs if an adjoining part is an open-deck or sprinklered carpark that complies with the concessions set out in **Table 3.9, 4.2** or **5.3** of **Specification C1.1**.

C2.7(a)(ii) requires all openings in fire walls to comply with Part **C3**. This includes: doorways in fire walls, protection of doorways in horizontal exits, and openings for service penetrations (applicable for any services which penetrate or pass through a fire wall).

Figure C2.7(1)
EXAMPLE OF METHOD OF SEPARATING A BUILDING
BY A FIRE WALL IN ACCORDANCE WITH C2.7(B)(ii)

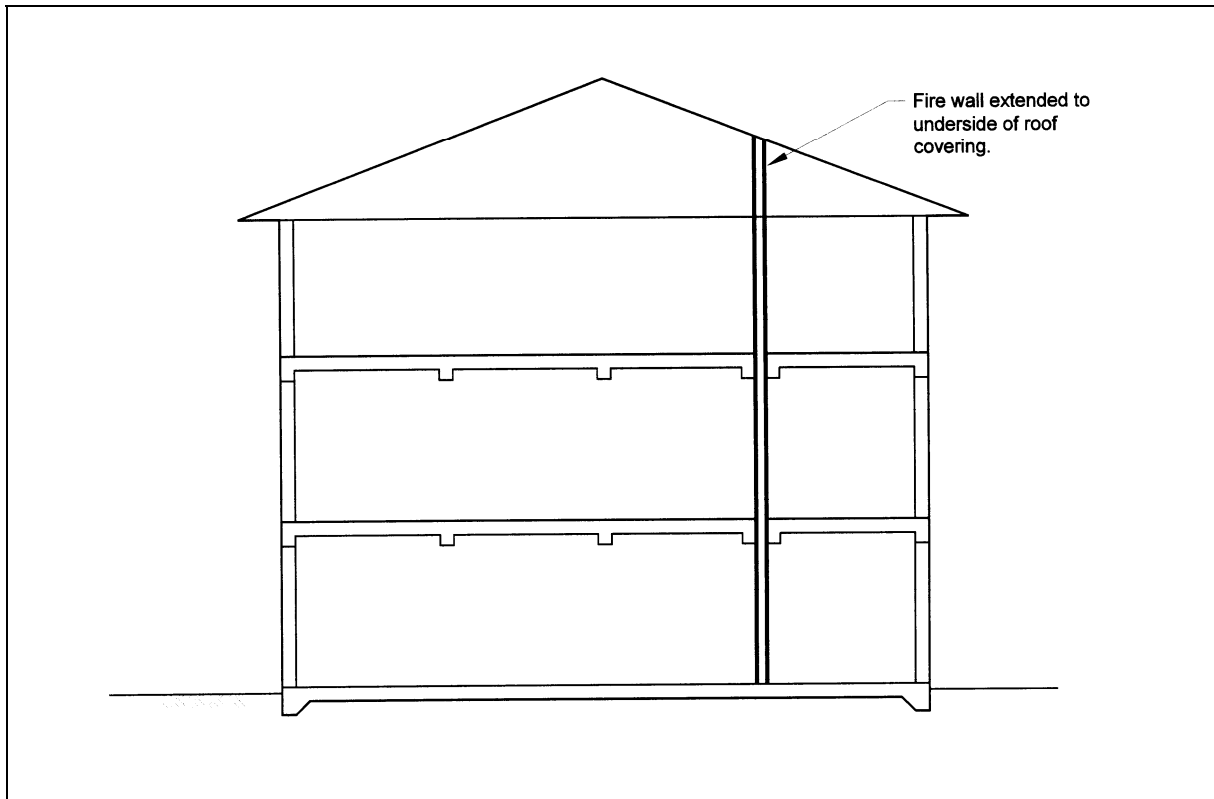

C2.7(a)(iii) indicates which building elements are permitted to pass through or cross a fire wall and prohibits the use of any building element if it reduces the fire wall's FRL below that required. Hence, elements that pass through or cross a fire wall have to be part of the fire wall's tested prototype.

C2.7(a)(iii) grants an exemption to its requirements for small roof battens.

Separation of buildings

C2.7(b) indicates the extent a fire wall divides a building into separate buildings for the **Deemed-to-Satisfy Provisions** of **Sections C, D and E** (see **Figure C2.7(1)**).

The fire wall must extend through all storeys and similar spaces which are common to the subject parts of the building, and any adjoining part of the building, through to the underside of any roof covering (see **C2.7(b)(ii)**).

C2.7(b) outlines the requirements for the extent of a fire wall that separates adjoining parts of a building where the roofs are at a different levels.

If buildings, with different roof levels divided by a fire wall, are to be treated as two separate buildings, the fire wall must extend up to the underside of the highest roof or not less than 6 m above the covering of the lowest roof.

Alternatively, **C2.7(b)** allows the fire wall not to extend 6 m above the lower roof if the roof to the lower level building:

- has the FRL prescribed for the fire wall by **Specification C1.1** and no openings are located within 3 m of any wall located above the lower roof; or
- the lower roof is non-combustible and the part of the building below has a sprinkler system complying with **Specification E1.5** installed.

Separation of fire compartments

C2.7(c) clarifies that a fire wall built in accordance with **C2.7(a)** can be considered to divide a building into different fire compartments for the purpose of **Sections C, D and E** (see **Figure 2.7(2)**).

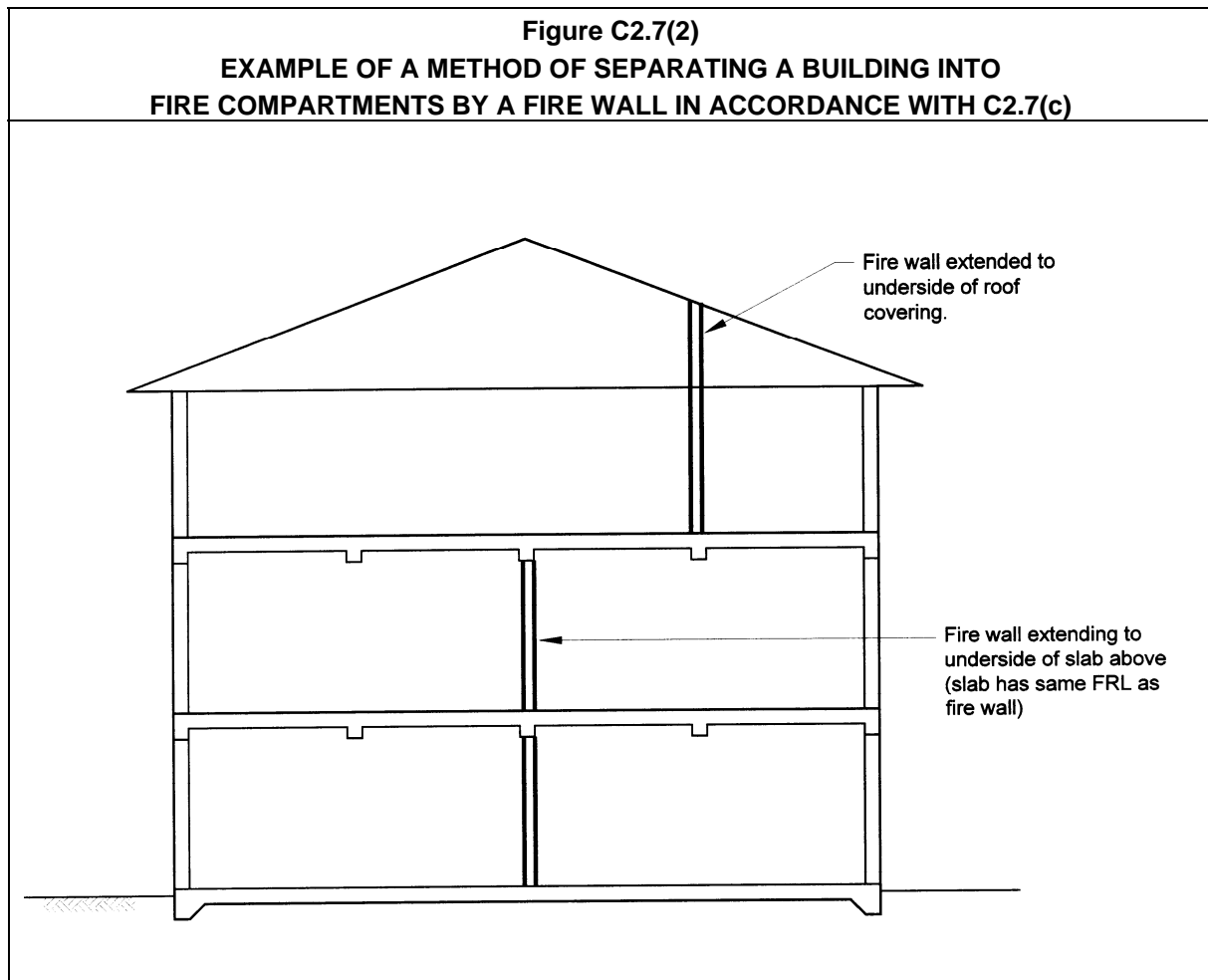

For a fire wall to compartment a building it must extend to the underside of any roof covering or between floors that have an equivalent FRL to the fire wall.

If the buildings being separated into fire compartments by a fire wall have different roof levels there is no requirement to extend the fire wall to the underside of the higher roof level or above the lower roof level. This is because the fire wall serves as a means to limit the floor area of the building. When a fire wall is applied in this case, the building cannot be treated as two separate buildings for the purpose of **Sections C, D and E** of the BCA.

Figure C2.7(2) illustrates the case where two fire walls divide storeys but do not align, therefore not meeting the requirements of **C2.7(b)**. In this case, the building cannot be regarded as two buildings divided by a fire wall.

Figure C2.7(3) illustrates a circumstance where a fire wall can be an external wall. This is important to note because of a possible reading of the definition of ‘fire wall’ which indicates that a fire wall would always be an internal wall.

C2.8 Separation of classifications in the same storey

Intent

To minimise the risk of a fire in one classification on a storey causing the failure of building elements in another classification on the same storey.

Fire spread between classifications

The fire-resistance level (FRL) required for building elements varies, depending on the expected fire load. This load is measured in the BCA by the building classification. With these differing FRLs, it is important that a fire in one classification does not cause the failure of building elements in any other classification.

There are two options to stop a fire spreading from one classification to another classification on the same storey:

- use the highest of the two fire-resistance levels (FRLs) required for each building element in that storey (see **C2.8(a)**); or
- place a fire wall between the two different classifications (see **C2.8(b)** and **(c)**). In a building of mixed classification **C2.8(b)** clarifies that for Type A and Type B construction the FRL is the higher of that specified in **Table 3** or **4** but for Type C construction it is the FRL specified in **Table 5**. This is because the FRL for firewalls in Type C construction is the same for all Classes.

Figure C2.8(1) illustrates some examples of fire walls separating different classifications within the same storey of a building. In the first diagram, the public corridor must be fire-separated from the Class 6 part (as shown) or the Class 5 part to achieve total fire-separation between the different classifications. If a doorway is located in the fire wall, it must comply with **C3.5**.

Figure C2.7(3)
EXAMPLE OF FIRE WALL USED AS AN EXTERNAL WALL TO SEPARATE
TWO BUILDINGS IN ACCORDANCE WITH C2.7(B)(iii)

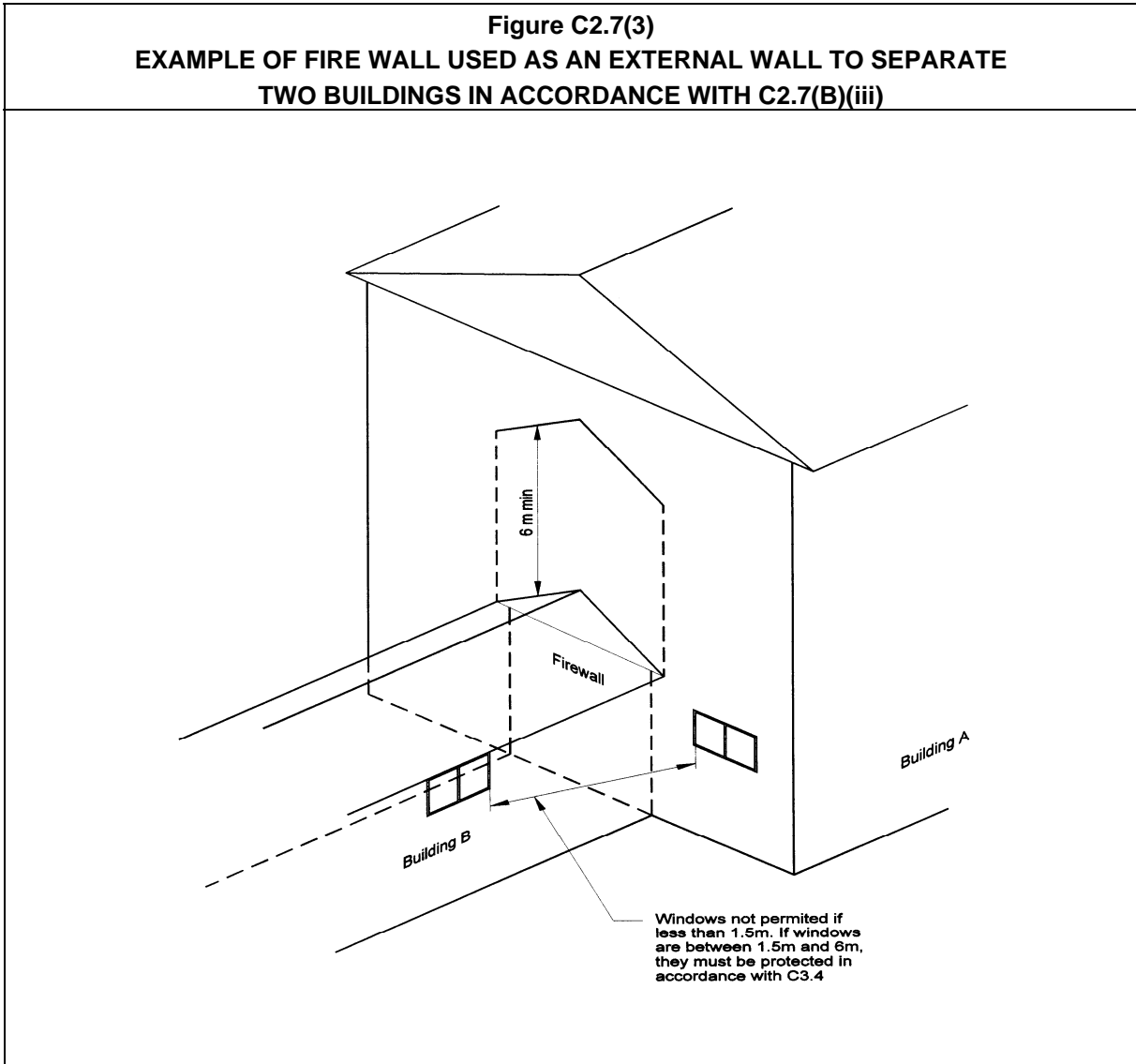
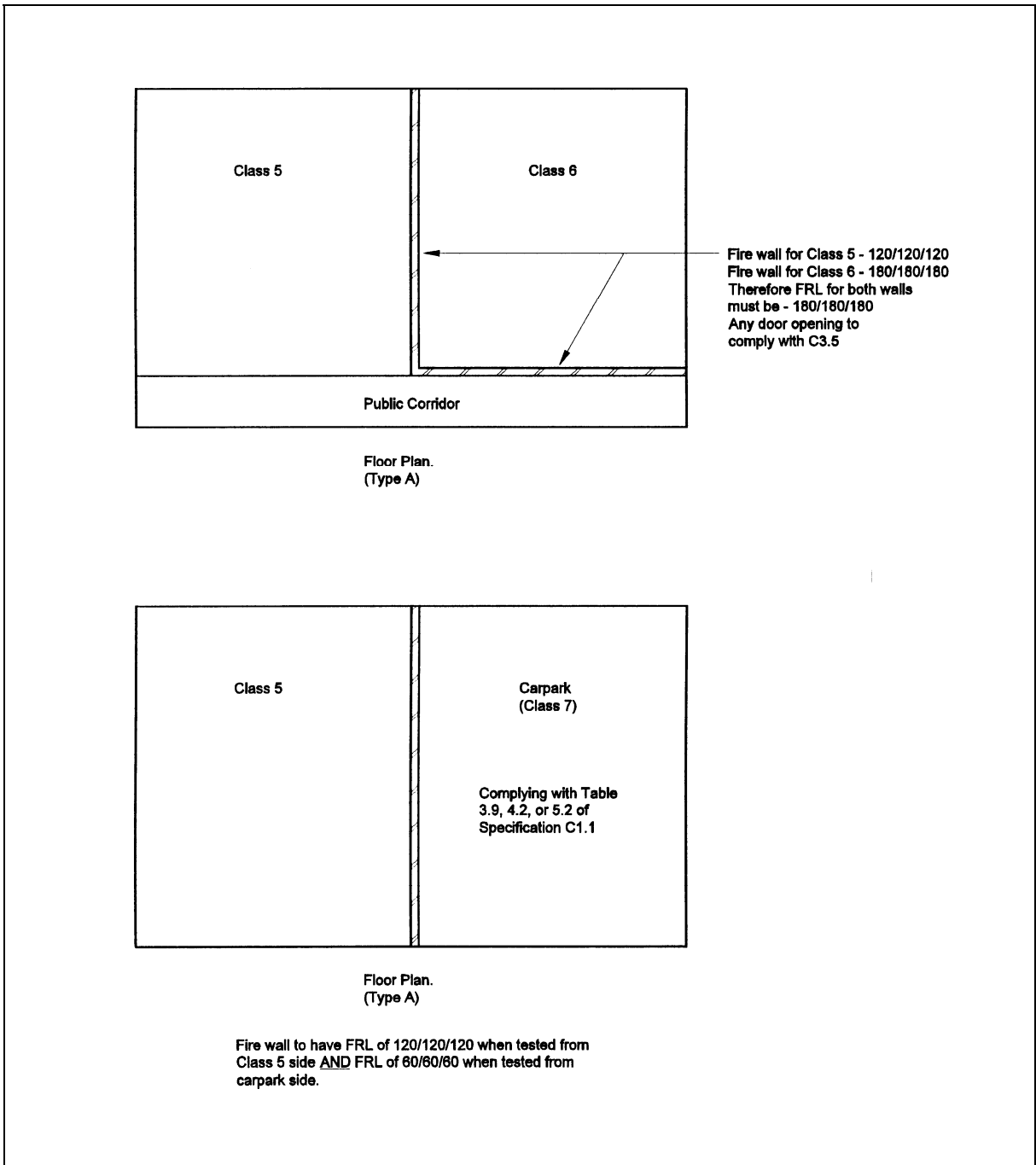
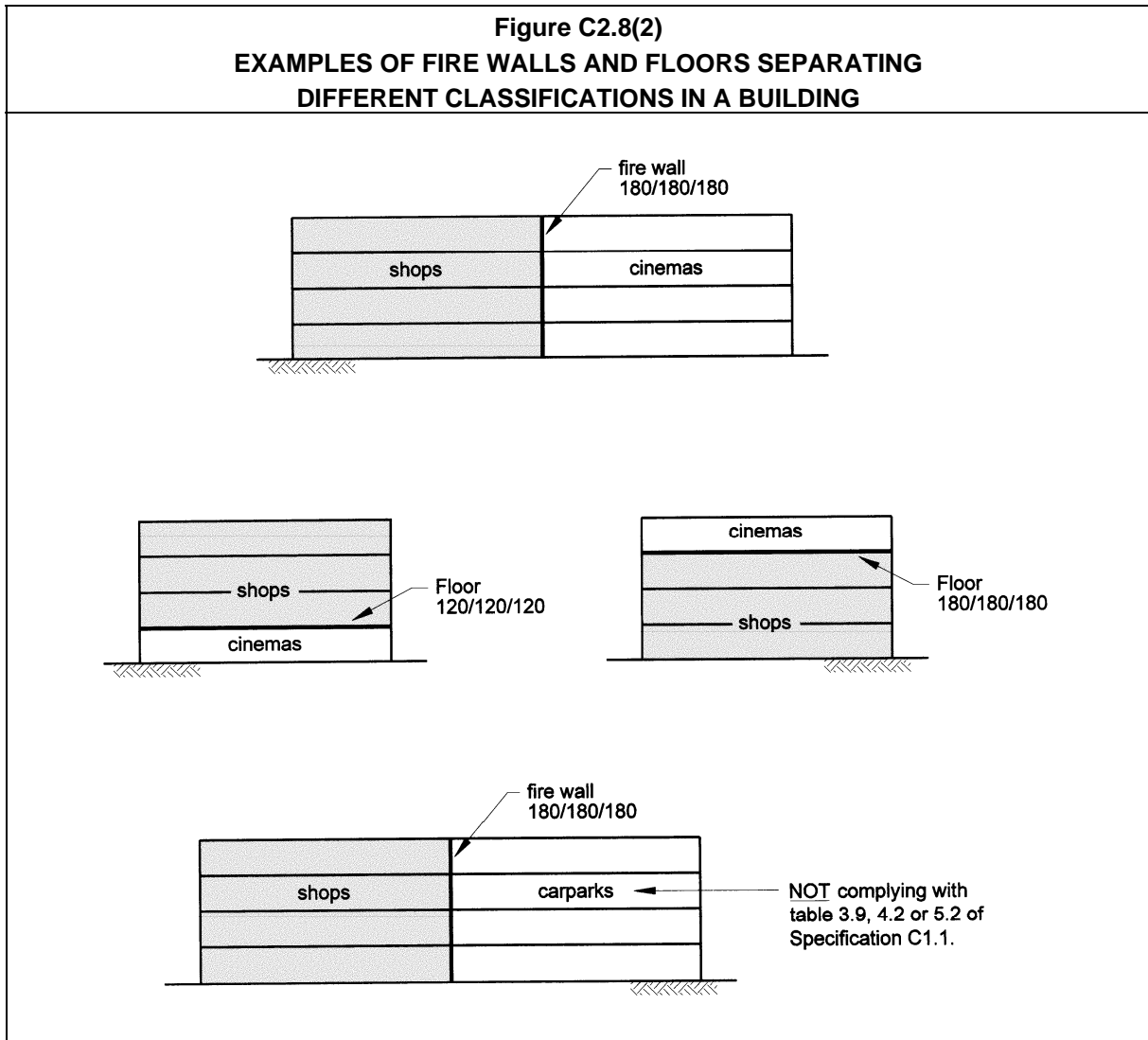

Figure C2.8(1)
PLAN SHOWING FIRE WALLS SEPARATING
DIFFERENT CLASSIFICATIONS IN THE SAME STOREY IN ACCORDANCE WITH C2.8



The diagrams in **Figure C2.8(2)** illustrate examples of fire walls separating different classifications within the same storey of a multi-storey building and floors separating different classifications.



C2.9 Separation of classifications in different storeys

Intent

To minimise the risk of a fire in one classification causing the failure of building elements in another classification in a different storey.

C2.9 specifies the required separation between parts of a building which are of a different classification, situated one above the other.

The aim of **C2.9** is for the fire load of a storey to determine the fire protection of the floor above it. A fire on one storey will affect the storey above to a greater degree than any storey below.

C2.9(a) sets out the requirements for buildings of Type A construction. **Figure C2.9** illustrates an example of the required fire-resistance level (FRL) of floors in a 3 storey building required to be of Type A construction.

C2.9(b) sets out the requirements for buildings of Type B and Type C construction. However, note that **C2.9(b)** is only applicable where one of the parts being separated is Class 2, Class 3 or Class 4 and **Specification C1.1 Clauses 4.1(i)** and **5.1(e)** require floors to be protected if the building is Class 2, 3 or 9.

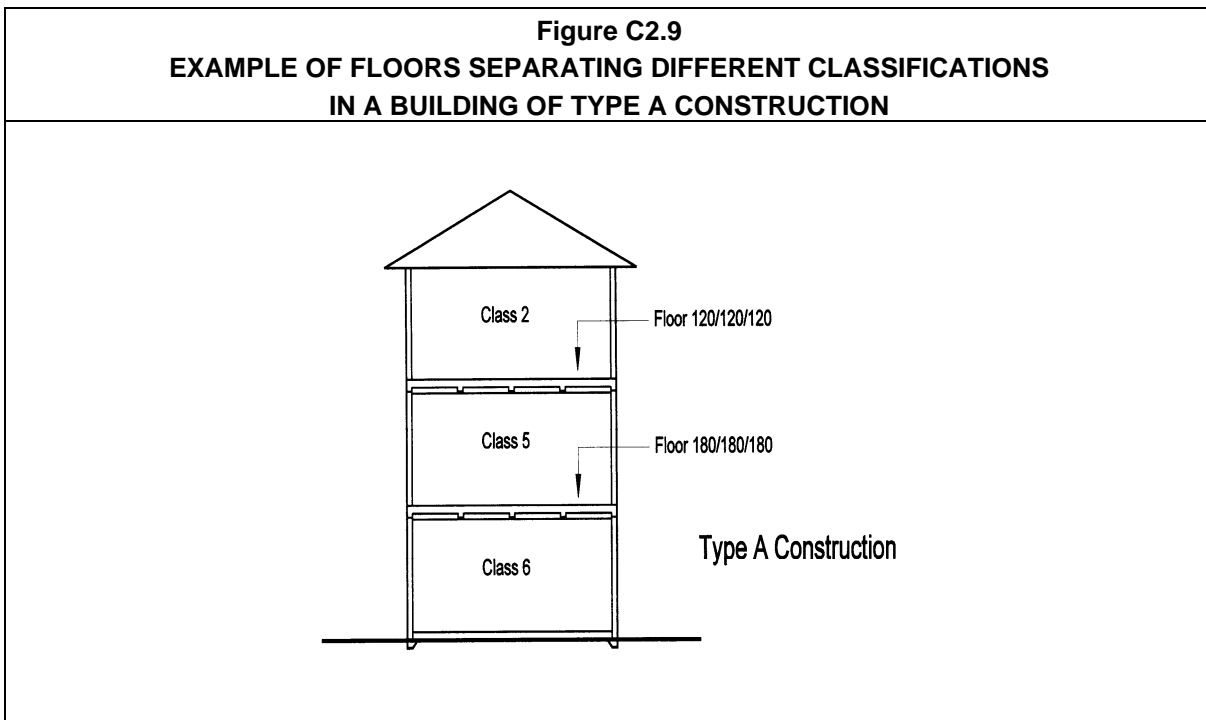

C2.10 Separation of lift shafts

Intent

To minimise the risk of a fire spreading from one floor to another floor of a building by way of a lift opening.

The approach adopted in **C2.10** for lift shafts is similar to that adopted by the BCA for stairway shafts.

C2.10 applies to all classes of buildings and specifies the protection requirements for openings both for lift landing doors and services.

Lifts in Type A and B Construction

In any building required to be of Type A construction, the lift shaft walls must have the relevant fire-resistance level (FRL) prescribed by **Table 3** of **Specification C1.1**. It does not matter what Class the building is, nor whether the shaft walls are loadbearing.

In any building required to be of Type B construction, the lift shaft walls must have the relevant FRL prescribed by **Table 4** of **Specification C1.1** if they are loadbearing. If they are non-loadbearing they must be of non-combustible construction.

As all emergency lifts are required to be fire separated from the remainder of the building, **C2.10(c)** clarifies that the lift shaft is to have an FRL of not less than 120/120/120.

C2.10(d) only applies to fire-isolated lift shafts. Lift landing doors and indicator panels are covered by **C3.10**. Openings for other services must comply with any other appropriate provisions in **Part C3**.

If a lift is wholly in an atrium, it is not required to be in a fire-isolated shaft. This is because the atrium comprises a single fire compartment.

Patient care and resident areas

Any lift in a patient care area in a Class 9a building, or a resident use area in a Class 9c building is to be in a fire-isolated shaft. In a Class 9a or 9c building that is required to be of Type A or B construction it is to have an FRL of 120/120/120. In a Class 9a or 9c building of Type C construction the shaft is to have an FRL of 60/60/60.

Lifts in Type C construction

Apart from emergency lifts and lifts in patient care and resident use areas, lifts need not be in a fire-isolated shaft if the building is of Type C construction. This is because such buildings are not required to have fire-rated floors or any fire compartmentation between storeys.

C2.11 Stairways and lifts in one shaft

Intent

To maintain a safe evacuation route for people using a fire-isolated stairway, by separating the stairway shaft from the lift shaft.

Lift shafts do not offer the same fire protection to occupants as fire-isolated stairway shafts. This is because lift landing doors to shafts have no insulation properties and do not seal against smoke to the same extent as fire doors to stairway shafts. Also, many lift over-runs are places where rubbish or other combustible materials may accumulate and are therefore potential fire-sources.

C2.12 Separation of equipment

Intent

To limit the spread of fire from service equipment having a high fire hazard or potential for explosion and to ensure emergency equipment continues to operate during a fire.

C2.12 is part of the **Deemed-to-Satisfy Provisions** for **CP6** and **CP7**.

The types of equipment referred to in **C2.12(a)(i)** and **(ii)** and **C2.12(c)** need to continue to operate during an emergency, such as a fire. It is therefore important to stop the spread of fire to this equipment.

The requirement under **C2.12(c)** that on-site fire pumps comply with **E1.3**, rather than **C2.12(d)**, recognises the importance of this equipment to fire-fighting.

The types of equipment referred to in **C2.12(a)(iii)** and **(iv)** have a high explosive potential. It is important that any fire in this type of equipment does not spread to other parts of the building. Not all equipment is required to be protected. Examples are listed in **C2.12(b)**. This equipment is either designed to withstand high temperatures during a fire, or is required to be protected by other parts of the BCA.

Under **C2.12(d)**, the minimum fire-resistance level (FRL) for construction used to separate the equipment listed in **C2.12(a)** from the remainder of the building is 120/120/120, with -/120/30

fire doors. However, if **Specification C1.1** (particularly **Tables 3, 4 or 5**) requires a higher FRL, then that higher FRL applies.

C2.13 Electricity supply system

C2.11

Intent

To limit the spread of fire from electrical equipment and to enable the uninterrupted operation of emergency equipment during a fire.

C2.13 is part of the **Deemed-to-Satisfy Provisions** for **CP6** and **CP7**.

Certain types of electrical equipment have a high potential for explosion as well as fire. **C2.13(a)** requires that the doorways to sub-stations be protected with -/120/30 fire doors to avoid the spread of any fire from the electrical equipment.

Some State and Territory authorities may have additional requirements for the construction of electricity sub-stations. See relevant State or Territory Appendix to the BCA.

To enable the required emergency equipment to continue to operate during any emergency, the following must be achieved:

- The main switchboard referred to in **C2.13(b)** must be separated from other parts of the building by construction having a fire-resistance level (FRL) of 120/120/120, and any door openings protected with -/120/30 fire doors.
- The electrical conductors referred to in **C2.13(c)** must comply with the appropriate sections of [AS/NZS 3013](#) — Wiring installations — Wiring systems for specific applications, or be protected by fire rated construction with an FRL of 120/120/120.

C2.14 Public corridors in Class 2 and 3 buildings**Intent**

To minimise the risk of long public corridors in Class 2 and Class 3 buildings becoming smoke logged.

In a building fire, certain people are subject to greater risks than others, for example, the very young, elderly, people with disabilities, and those who are asleep.

In a Class 2 or Class 3 building there is a very high risk that building occupants will be asleep when a fire occurs. It is important that they be able to safely evacuate the building. To assist in the safe evacuation, long public corridors should not become smoke logged.

C2.14 therefore requires the division of the public corridors into 40 metre lengths, by smoke walls and smoke doors. The details of the smoke walls are set out in **Specification C2.5**, and details for the smoke doors are set out in **Specification C3.4**.

PART **C3** PROTECTION OF OPENINGS

Objective

Functional Statements

Performance Requirements

The Objectives, Functional Statements and Performance Requirements for **Section C** are at the beginning of **Section C**.

Deemed-to-Satisfy Provisions

C3.0 Deemed-to-Satisfy Provisions

Intent

To clarify that the requirements of **CP1 to CP9** will be satisfied if the building complies with Parts **C1**, **C2** and **C3**, and Parts **G3** and **H1**, if applicable.

See **Deemed-to-Satisfy Provisions** for Part **C1**. The same applies here.

C3.1 Application of Part

Intent

To clarify which openings must comply with the Deemed-to-Satisfy Provisions of Part **C3**.

Openings listed in **C3.1(a)** need not comply with the Deemed-to-Satisfy Provisions of Part **C3**.

Openings listed in **C3.1(b)(i)** and **(ii)** must comply with the relevant Part **C3** Deemed-to-Satisfy Provisions.

C3.2 Protection of openings in external walls

Intent

To require any opening in external walls to be protected, only where the wall is required to have an FRL, to prevent the spread of fire from the boundary of an adjoining allotment, or one building to another building on the same allotment.

C3.2 applies to all Class 2–9 buildings, even those protected by a sprinkler system. The provisions only apply to openings which are exposed to a fire source feature (ie. an allotment boundary or another building on the same allotment).

Any openings in the external walls of buildings separated by fire walls must comply with **C3.2**. In this case, each building is a fire-source feature to the other building (see **Figure C3.2**).

Location of openings

Openings are prohibited in external walls required to have a fire-resistance level (FRL) where the walls are within one metre of a fire-source feature in a building that has a rise in storeys of 1 (see **C3.2(a)(i)**), or within 1.5 metres of a fire-source feature in a building that has a rise in storeys of more than 1 (see **C3.2(a)(ii)**).

The reason openings are setback these distances is due to the fact that radiant heat is still transferred through an opening, even a fire protected window. If a building proponent wishes to locate an opening within the distances specified, advantage should be taken of the Alternative Solution approach, perhaps using Verification Methods **CV1** and **CV2**.

Protection of openings

Openings in an external wall must be protected if within 3 metres of a side or rear boundary (see **C3.2(b)(i)**). Or, under **C3.2(b)(ii)**, if they are within 6 metres of the far boundary of an adjoining road, if the opening is located in a storey above, or a reasonable distance from ground level. Openings must also be protected if they are within 6 metres of another non-Class 10 building on the allotment (see **C3.2(b)(iii)**).

In regards to the protection of openings under **C3.2(b)**, an assessment is required to determine a ‘reasonable’ distance from ground level, on a case by case basis. Discussions with the approval authority may be required in this regard.

Figure C3.2

PLAN SHOWING WHEN C3.2 REQUIRES PROTECTION OF OPENINGS IN AN EXTERNAL WALL

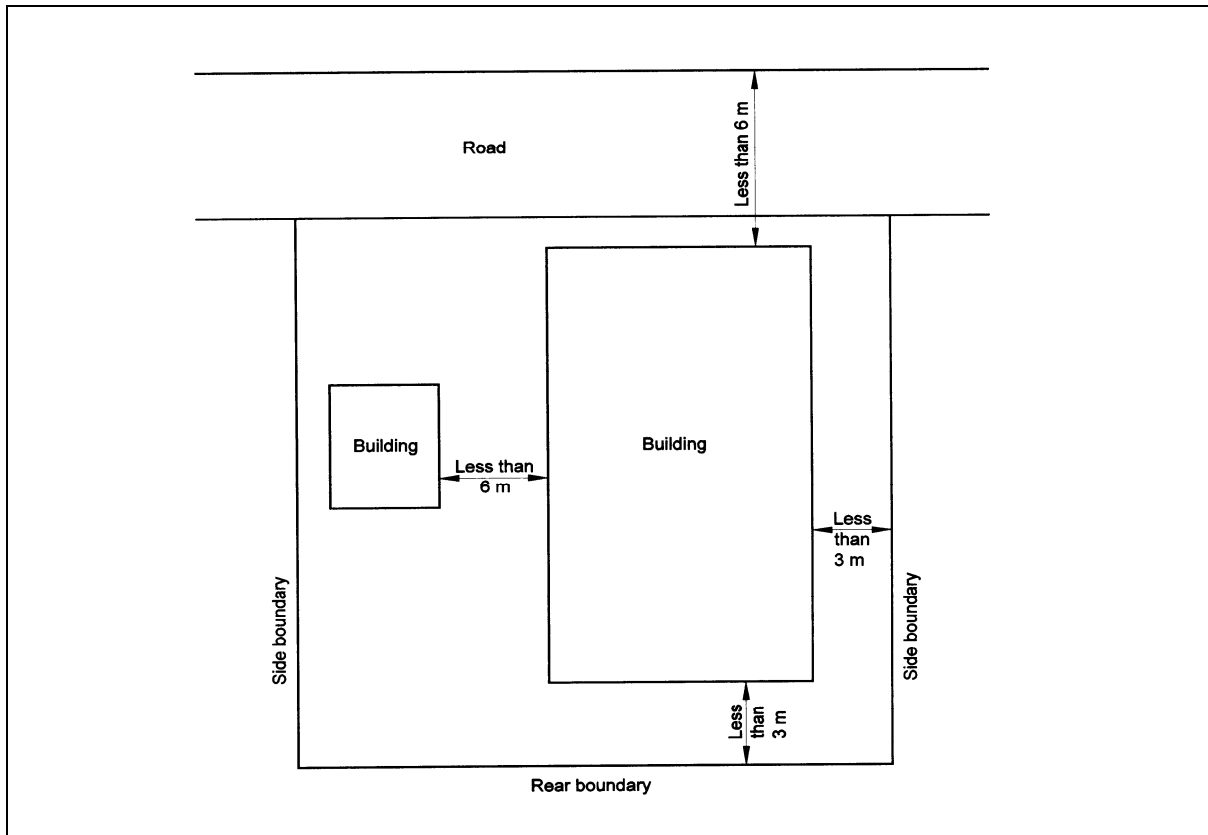

Under **C3.2(c)**, openings in an external wall must be limited to the size specified, if the openings are required to be protected under **C3.2(b)**. This is unless the openings are in a Class 9b open spectator stand.

C3.3 Separation of external walls and associated openings in different fire compartments

Intent

To limit the spread of fire between fire compartments through external walls and the openings in them.

Figure C3.3 illustrates the use of **Table C3.3**.

When the walls are at an angle of 180° or greater, the distance between them may be zero because the effects of radiant heat between the walls is negligible. In practice, the distance between such walls is likely to equal the width of the fire wall.

Sole-occupancy units in Class 2 and Class 3 buildings are not fire compartments to which **C3.3** applies.

Figure C3.3
PLAN SHOWING ILLUSTRATION OF TABLE C3.3

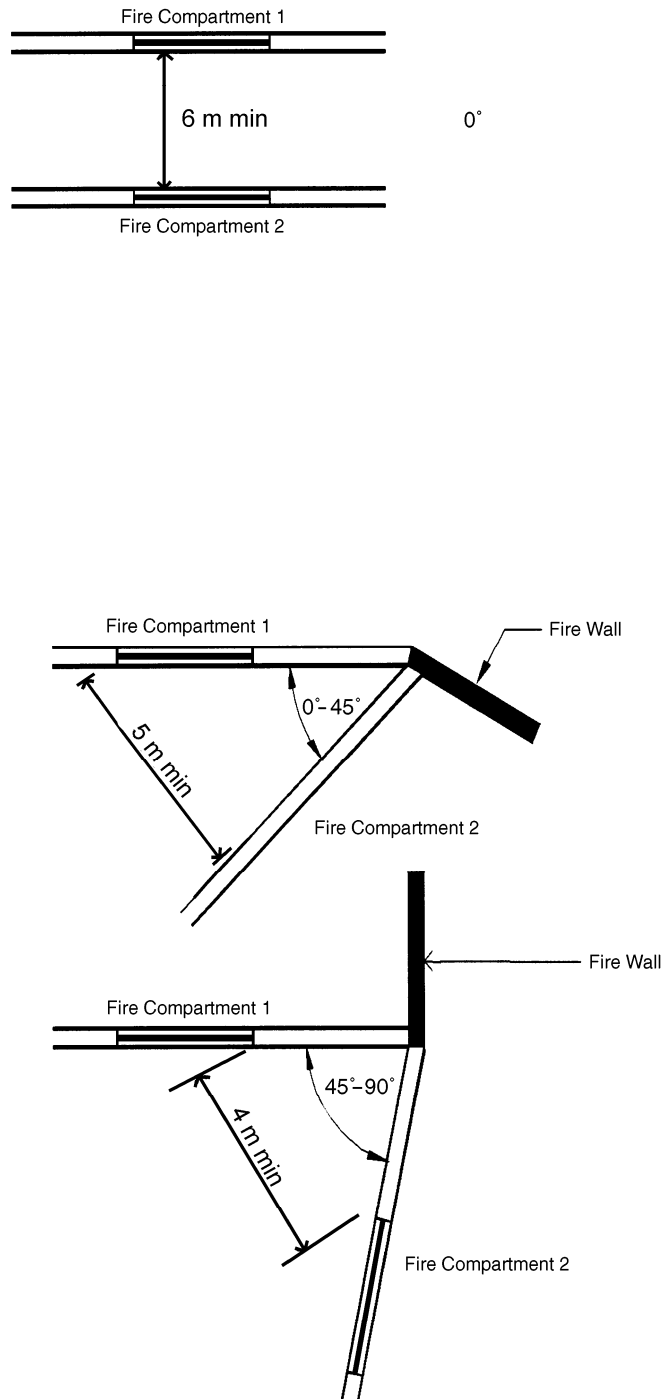

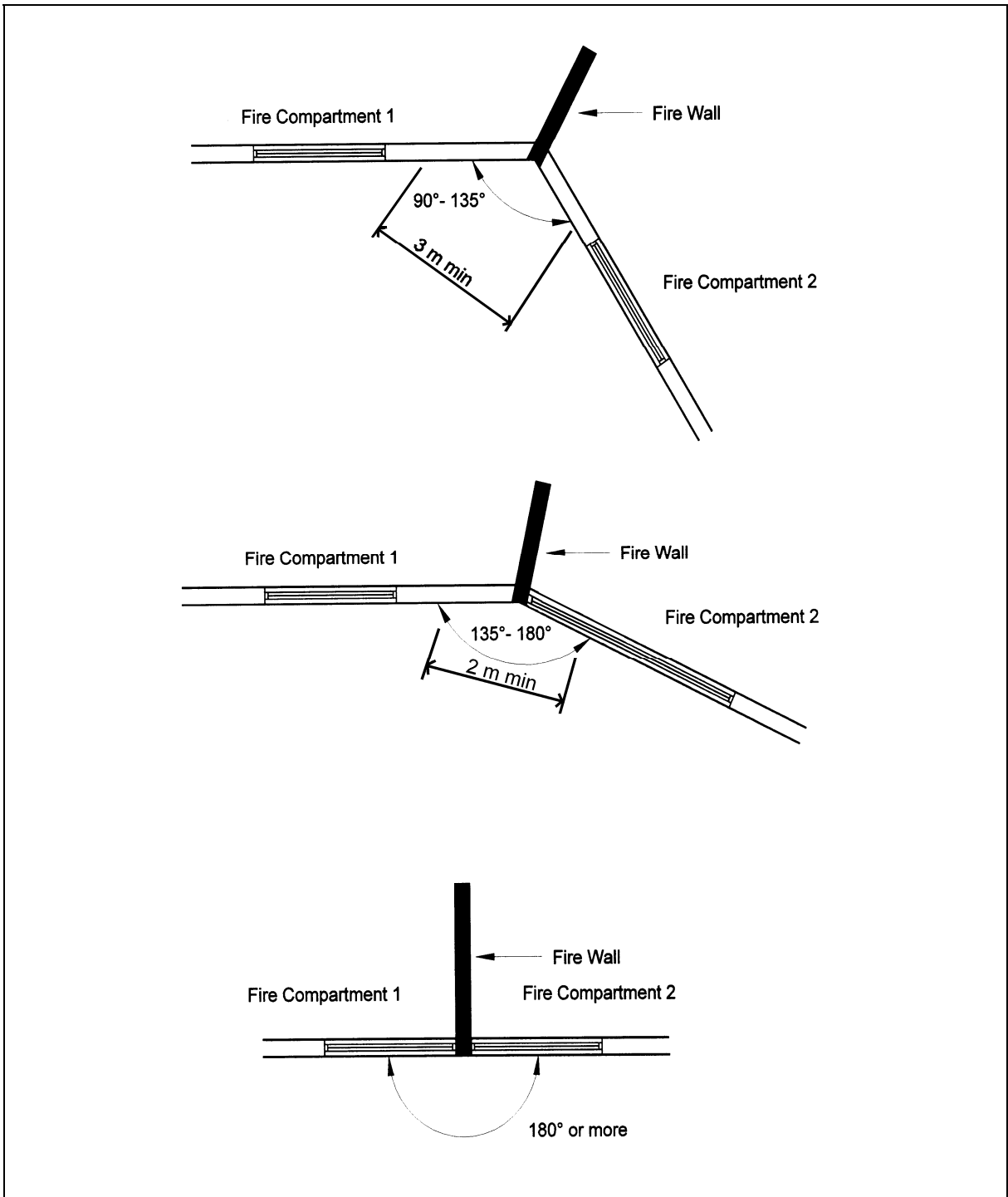

C3.3 only applies to external walls. It does not apply to fire walls separating fire compartments. (A fire wall is not always an internal wall. See **Figure C2.7(3)** of this Guide).

C3.4 Acceptable methods of protection

Intent

To set out acceptable methods of protection required for different types of openings in a building.

C3.4(a) applies where protection is required to doorways, windows and other openings.

C3.4(b) requires fire doors, fire windows and fire shutters to comply with **Specification C3.4**.

C3.4 is referred to by a number of the BCA's **Deemed-to-Satisfy Provisions**. Some of these provisions will specify whether or not a required sprinkler system must be internal or external. Where external wall wetting sprinklers are proposed, it may be designed using AS 2118.2, even though that Australian Standard is not referenced in the BCA. Please note that there are certain limitations that apply to AS 2118.2, such as the types of glazing applicable and location of sprinkler heads.

Examples

Examples of the references to **C3.4** in the other Deemed-to-Satisfy Provisions include the following:

- **C3.2** refers to **C3.4** for the protection required for openings in the external walls of a building located close to a fire-source feature.
- **C3.3** allows the distance between openings in the external walls of a fire compartment to be closer than allowed by **Table C3.3** if they are protected in accordance with **C3.4**.
- **C3.8** requires the protection of certain window openings in fire-isolated exits.
- **D1.7(c)(ii)**, regarding travel from an exit point of discharge within 6 metres of an opening in an external wall.
- **D1.8**, regarding travel past openings within 6 metres of an external stairway.

C3.4(a)(i) clarifies that wall wetting sprinklers are only to be used with doors that are self-closing or automatic closing.

C3.4(a)(ii) clarifies that wall-wetting sprinklers are only to be used with automatic closing windows or permanently closed windows.

C3.5 Doorways in fire walls

Intent

To maintain the integrity of fire walls by limiting the spread of fire through doorways.

If the opening in the fire wall is for a horizontal exit, refer to **C3.7**.

When a doorway is installed in a fire wall, to achieve the same fire separation as the wall, **C3.5(a)** allows the use of:

- two fire doors, one on each side of the doorway;
- two fire shutters, one on each side of the doorway;
- one fire door and one fire shutter, one on each side of the doorway;
- a single fire door; or
- a single fire shutter.

(See **C3.5(a)(i)**, **C3.5(a)(ii)** and **C3.5(a)(iii)**)

In each option, the single fire door or shutter, or any of the combinations of the two, must have the same fire-resistance level (FRL) as the fire wall. (This is except for the insulation criterion, which must be at least 30 minutes)

When determining the required FRL of the fire door or shutter, **Clause 6 of Specification A2.3** states that non-loadbearing elements need not comply with the structural adequacy criterion. A fire door or shutter is normally regarded as a non-loadbearing element.

Example

Consider the case of a fire wall required to have an FRL of 240/240/240. After taking into account the concession allowed by **Clause 6 of Specification A2.3**, **C3.5** allows any doorway in that wall to be protected by:

- two -/120/30 fire doors, one on each side of the doorway;
- two -/120/30 fire shutters, one on each side of the doorway;
- a -/120/30 fire door and a -/120/30 shutter door, one on each side of the doorway;
- a single -/240/30 fire door; or
- a single -/240/30 fire shutter.

Closure of fire doors and shutters

C3.5(b)(i) states that any fire door or shutter required under **C3.5(a)** must be either self-closing or automatic-closing. If automatic closing, it must be initiated by smoke detectors, or (in specified circumstances) heat detectors (see **C3.5(b)(ii)**). These detectors must be in accord with the relevant provisions of **AS 1670.1**, and located as specified in **C3.5(b)(ii)**.

Under **C3.5(b)(iii)**, the activation of any other required suitable fire alarm system (including a complying sprinkler system), in either of the fire compartments separated by the fire wall, must operate the automatic closing of the fire door or shutter.

A smoke detector can give false alarms if the atmosphere contains particles such as steam or other vapours that obscure vision (eg kitchens, carparks, etc.). If a smoke detector is likely to give a false alarm due to the atmospheric conditions, then a heat detector should be used to comply with **C3.5(b)(ii)**.

Figure C3.5 illustrates the requirements of C3.5.

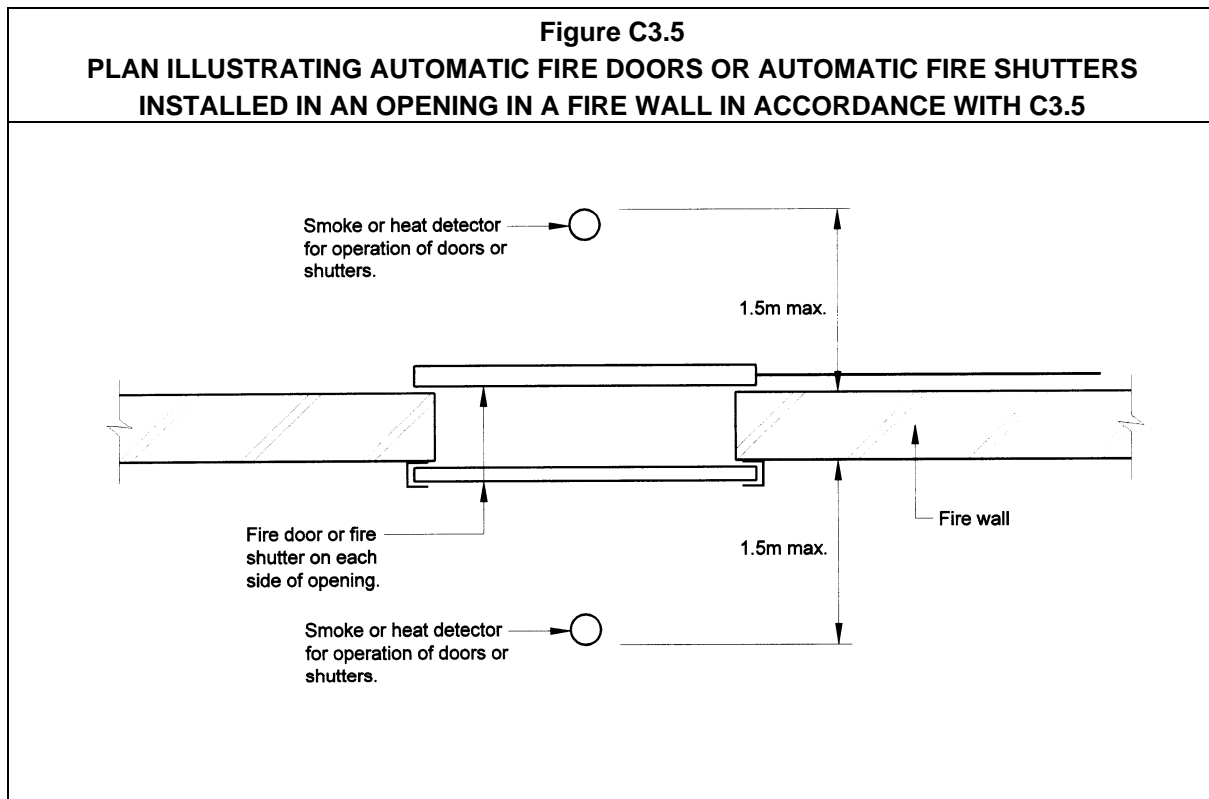

C3.6 Sliding fire doors

Intent

To avoid danger to occupants caused by the automatic closing of a sliding fire door.

It is an acceptable and frequently used option to protect an opening in a fire wall by a sliding fire door held open by an electromagnetic device. However, sliding fire doors tend to be quite large and heavy, presenting a potential danger to occupants passing through while it is closing. To reduce the danger to building occupants the rate of the door's closing is limited and must be by the de-activation of an electromagnetic device (see C3.6(a)(i)).

In the event of a power failure, the electromagnetic device must also fail-safe so that the door closes thereby maintaining the integrity of the fire wall (see C3.6(a)(ii)).

Warning lights and signs are required to be installed on each side of the door by C3.6(a)(iii) and (iv) to indicate the presence and operation of the fire door. C3.6(b) requires the electromagnetic device to deactivate and the warning system to operate when there is a fire in a fire compartment on either side of the fire wall. This process must be activated by either smoke detectors or heat detectors (in specific circumstances) installed in accordance with the relevant provisions of AS/NZS 1905.1 and AS 1670.1 (see C3.6(b)(i)).

C3.6

The activation of any other required suitable fire alarm system (including a complying sprinkler system) in either of the fire compartments must also cause the automatic closing of the fire door (see **C3.6(b)(ii)**).

A smoke detector can give false alarms (see comments on **C3.5**). Heat detectors complying with **C3.6(b)(i)** should be used in these circumstances.

C3.7 Protection of doorways in horizontal exits

Intent

To provide occupants using a horizontal exit with the same protection as those using a fire-isolated exit.

Types of doors permissible

The use of fire shutters are prohibited in a horizontal exit by **D2.19(b)**. Similarly, **D2.19(c)** does not permit sliding doors to be used as horizontal exits.

There are some concessions to these prohibitions (see **D2.19**).

The fire doors used for horizontal exits, as referred to in **C3.7**, must swing in the direction of travel (as required by **D2.20**).

If the horizontal exit applies in both directions (ie the doorway may be used to escape from either fire compartment to the other), the installation of two doors may be necessary (see **Figure C3.7**).

Buildings other than Class 7 and 8

Unless it is located in a Class 7 or Class 8 building, a doorway which is part of a horizontal exit must be protected by a single fire door complying with **C3.7(a)(i)**.

Two fire doors in Class 7 and 8

The reason for allowing two fire doors to be installed in a doorway in Class 7 and Class 8 buildings is because single fire doors with the required fire-resistance level (FRL) are heavy and difficult to open. In combination, the two fire doors must achieve an equivalent FRL to the fire wall.

If two fire doors are installed in a doorway in a Class 7 or Class 8 building, it may be necessary to install a small lobby to allow for the swing of the doors (see **Figure C3.7**).

C3.7(b)(i) has the same requirements for fire doors as **C3.5**. Refer to the comments made in **C3.5** for application to **C3.7(a)**.

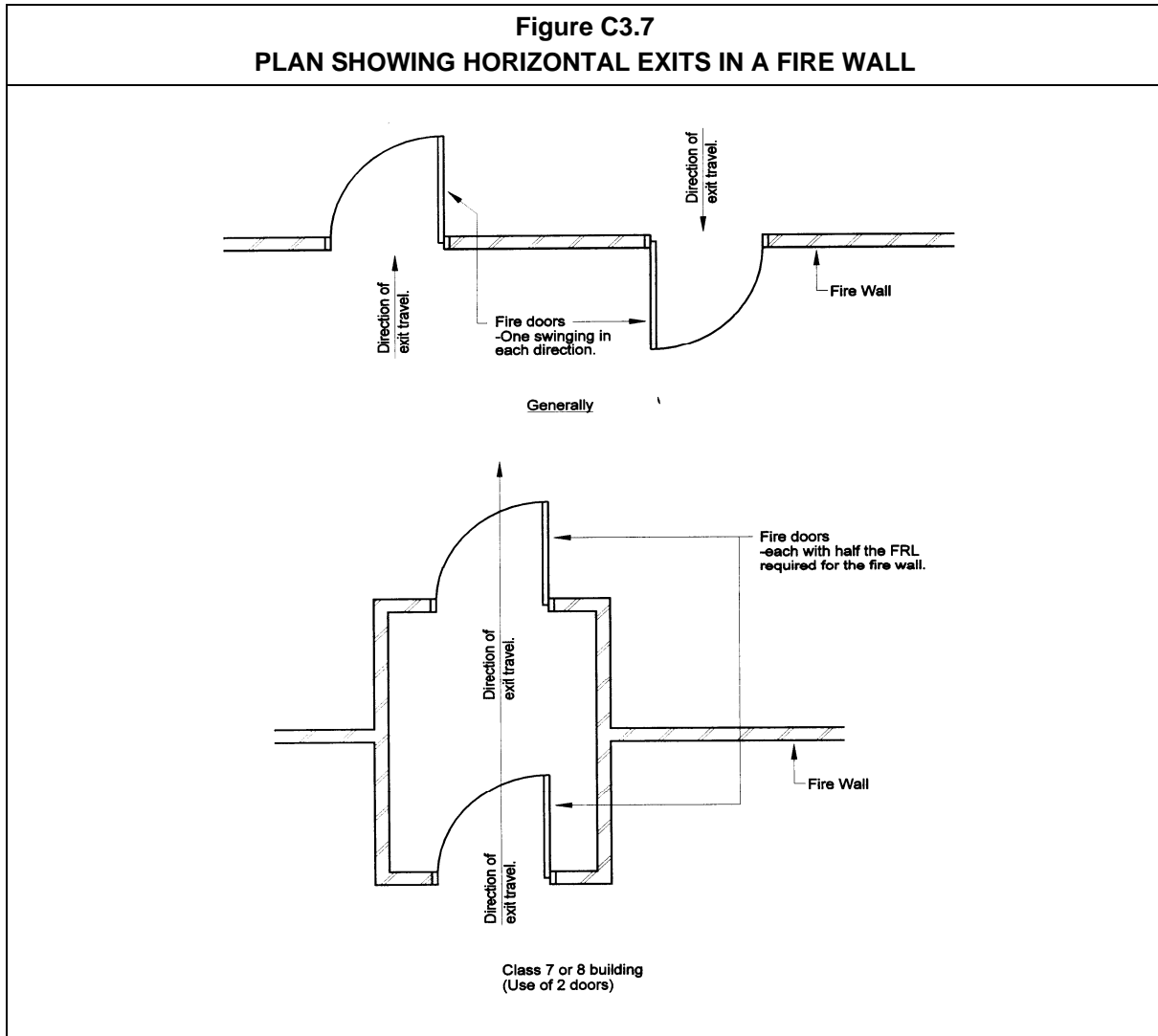

C3.8 Openings in fire-isolated exits

Intent

To maintain the integrity of a fire-isolated exit and to protect people using fire-isolated exits by providing adequately protected door and window openings.

Doorways

Any doorway leading into a fire-isolated exit is a possible source of fire and/or smoke spreading into that exit. The spread of fire or smoke into a fire-isolated exit is dangerous.

It is therefore important that such doorways are protected by fire doors. These fire doors must be self-closing (see **C3.8(a)(i)**) or automatic-closing initiated by smoke detectors or (in specified circumstances) heat detectors (see **C3.8(a)(ii)**).

C3.8(a) has the same requirements for fire doors or shutters as **C3.5**. Refer to the comments made in **C3.5** for application here.

C3.8(a) does not apply to a doorway leading from a fire-isolated exit to a road or open space, because failure of such a doorway is not affected by a fire in the building. However, note that such a doorway may require protection to comply with **C3.2**.

Windows

C3.8(b) only applies to a window which could expose an evacuating person or fire fighter to radiant heat from a fire in the building. Therefore, **C3.8(b)** does not apply to a window exposed to another window within the same fire-isolated exit.

If a sprinkler system is chosen as the means of protection in accordance with **C3.4**, the sprinkler heads must be located on the side of the window outside the exit.

A window subject to the requirements of **C3.8(b)** may also require protection from an external fire to comply with **C3.2**.

C3.9 Service penetrations in fire-isolated exits

Intent

To maintain the integrity of a fire-isolated exit and to protect the people using them by providing protection to service penetrations.

C3.9 minimises the number of service penetrations into a fire-isolated exit by only allowing the services specified. Each of the services listed in **C3.9(a) and (b)** is essential to maintain a safe environment within the fire-isolated enclosure.

Under **C3.9(c)**, the water supply for fire-fighting may be located within a fire-isolated exit. Hydrants located within a fire-isolated enclosure allow the fire brigade to set up their hoses and other equipment in a protected area before attacking the fire.

The location of any service penetrations into the fire-isolated exit permitted by **C3.9** must not reduce the exit width required by **D1.6**.

C3.9 should be read in conjunction with **D2.7**, which deals more generally with installations in exits and paths of travel.

C3.10 Openings in fire-isolated lift shafts

Intent

To maintain the integrity of a fire-isolated lift shaft and to limit the spread of fire from one floor of a building to another floor by way of a lift shaft.

Any doorway leading into a fire-isolated lift shaft could assist the spread of fire. Any spread of fire into the shaft could endanger the lives and safety of the people using the lift, and lead to the spread of fire to another part of the building. Therefore, it is important that such doorways be protected by fire doors.

AS 1530.4 (the Australian Standard for the Standard Fire Test) requires lift landing doors to be tested for integrity. Such doors are usually of metal construction, and are not required to satisfy any insulation criteria.

Lift indicator panels in excess of 35 000 mm² are considered to represent a sufficient risk of spreading fire into a lift shaft. Indicator panels exceeding this size require backing by material having a fire-resistance level (FRL) of -/60/60.

Small panels of 35 000 mm² or less are unlikely to lead to the spread of fire into the shaft. This exemption is similar in principle to those allowed by **C3.1** for minor openings such as control joints, weep holes, sub-floor ventilators and the like.

C3.11 Bounding construction: Class 2, 3 and 4 buildings

Intent

To maintain the performance of a wall bounding any sole-occupancy unit or public corridor in Class 2 or Class 3 buildings; and any sole-occupancy unit in a Class 4 part.

Protection of doorways

To maintain the fire performance of walls surrounding a sole-occupancy unit and corridors used as egress routes in Class 2 and Class 3 buildings, **C3.11(a) and (b)** requires the following doorways to be protected:

- between sole-occupancy units and any public corridor, public hallway or the like (see **C3.11(a)(i)**);
- between sole-occupancy units and any room not within a sole-occupancy unit, such as a common laundry, common sitting room and the like (see **C3.11(a)(ii)**);

- between sole-occupancy units and any landing of an internal, non-fire-isolated stair serving as a required exit (see **C3.11(a)(iii)**);
- between sole-occupancy units (see **C3.11(a)(iv)**);
- between a room not in a sole-occupancy unit (such as a common laundry, common sitting room and the like) and any public corridor, public hallway or the like (see **C3.11(b)(i)**); and
- between a room not in a sole-occupancy unit (such as a common laundry, common sitting room and the like) and any landing of an internal, non-fire-isolated stair serving as a required exit (see **C3.11(b)(ii)**).

To maintain the fire performance of walls surrounding a sole-occupancy unit in a Class 4 part of a building, **C3.11(c)** requires the doorways to the unit to be protected.

Fire protection required for doorways

The degree of fire protection required by **C3.11(d)** for doorways to sole-occupancy units in Class 2 and Class 3 buildings and Class 4 parts is dependant upon the types of construction.

C3.11(d)(i) applies to all Class 2 and Class 3 buildings and Class 4 parts in buildings of Type A construction, except those Class 3 buildings specified in **C3.11(d)(iii)**.

C3.11(d)(ii) applies to all Class 2 and Class 3 buildings and Class 4 parts in buildings of Type B or Type C construction, except those Class 3 buildings specified in **C3.11(d)(iii)**.

C3.11(d)(iii)(A) or (B) only applies to Class 3 residential aged care buildings fitted with a sprinkler system complying with **Specification E1.5**. A Class 3 residential aged care building that does not meet these requirements, must comply with **C3.11(d)(i) or (ii)** as applicable.

C3.11(d)(ii) requires that the door be self-closing to make sure that the door is closed during a fire. The requirement for such doors to be self-closing does not apply to a Class 3 residential aged care building which meets the requirements of **C3.11(d)(iii)(A)**.

Openings other than doorways

Under **C3.11(e)**, openings other than doorways in internal walls which are required to have a fire-resistance level (FRL) for integrity and insulation are permitted only if they do not lower the wall's fire-resisting performance.

Automatically closing doors

Doors required by **C3.11(d)** may be automatic-closing, initiated by smoke detectors or (in specified circumstances) heat detectors (see **C3.11(f)(ii)**). Refer to **C3.5** for door operation requirements as they apply to doors under **C3.11**.

Path of travel to an exit

C3.11(g) applies, in a Class 2 or Class 3 building only, where a path of travel is along an open balcony, landing or the like and it does not provide a person evacuating with a choice of travel in different directions to alternative exits. If this path of travel passes an external wall of another sole-occupancy unit (see **C3.11(g)(i)**) or a room which is not within a sole-occupancy unit (see **C3.11(g)(ii)**), the external wall must be constructed in accordance with **C3.11(g)(iii)**, have any doorways protected in accordance with **C3.11(g)(iv)**, and any window or other openings protected in accordance with **C3.11(g)(v)(A) or (B)**.

The reason for the above construction is to provide building occupants trying to evacuate with protection from radiant heat and flames whilst passing the unit that is on fire.

C3.12 Openings in floors and ceilings for services**Intent**

To limit the spread of fire through service openings in floors and ceilings required to resist the spread of fire.

C3.12 applies to floors and ceilings in buildings of Type A, B and C construction.

The performance of a fire resisting element may be compromised if service penetrations are not adequately protected. The method of protection should ensure the fire resisting capabilities of the element being penetrated is maintained. In buildings of Type A construction, the service may be within a fire resisting shaft or protected in accordance with **C3.15**. In buildings of Type B and C construction the service may be within a shaft that does not reduce the fire resistance of the element it penetrates or it must be protected in accordance with **C3.15**.

C3.13 Openings in shafts**Intent**

To maintain the fire performance of the floor by limiting the spread of fire through openings in shafts.

C3.13 only applies to buildings of Type A construction, because the other types of construction do not require service shaft walls to have a fire-resistance level (FRL).

C3.13 sets out the detail of the protection required in different circumstances to prevent the spread of fire from one floor to another floor by way of a shaft.

C3.14 * * * * *

In BCA 1990, this provision was performance-based. It has been superseded by BCA96 Performance Requirements. This is the reason why **C3.14** has been left blank, in accordance with the decision to retain the numbering of BCA 1990 for BCA96.

C3.15 Openings for service installations**Intent**

To maintain the fire performance of building elements by limiting fire spread by way of service penetrations.

C3.15 sets out a number of requirements for protection of service openings. These include:

- The use of tested prototypes in accordance with [AS 4072.1](#) and [AS 1530.4](#) (see **C3.15(a)**).
- Ventilation and air-conditioning ducts complying with [AS/NZS 1668.1](#) (see **C3.15(c)**).
- The use of **Specification C3.15** for metal pipes systems (excluding pipe seals or the like), sanitary plumbing, wire or cable, or clusters of wires or cables, electrical switches, or outlets or the like.

Tested systems permitted

C3.15(a) quite clearly permits the use of tested systems. The appropriate authority can allow any complying tested service penetration without the need to refer to a test report, provided it is satisfied that ‘an adequate level of performance is maintained’.

Approval of other types of penetrations

Specification C3.15 does not apply to larger diameter electrical cables (ie where the opening is larger than those specified in **Clause 5(a) and (b)** of 2 000 mm² or 500 mm²). This does not mean that larger diameter electrical cables cannot be approved under **C3.15**. Larger diameter electrical cables can be approved under **C3.15(a)** or, if necessary, as an Alternative Solution. Gas pipes can be approved under **C3.15(a)** or, if necessary, as an Alternative Solution.

C3.16 Construction joints**Intent**

To limit the spread of fire between building elements required to be fire-resisting.

To avoid the spread of fire between fire compartments or to another building, construction joints between building elements are normally packed with fire retardant material.

A number of proprietary products are suitable for this purpose, having previously been tested in accordance with [AS 1530.4](#) to demonstrate they have achieved the required fire-resistance level (FRL). The test only needs to record the failure criteria of integrity and insulation. **C3.16** does not require structural adequacy criteria to be achieved, as it is not part of the [AS 1530.4](#) test for these types of materials.

C3.17 Columns protected with lightweight construction to achieve an FRL

Intent

To prohibit columns with lightweight fire protection from lowering the fire-resistance levels (FRLs) of other building elements.

If lightweight fire protection has been inadequately applied to a column, there is an increased risk that the column will transmit heat to another building element (such as a floor or ceiling) through which it passes. The effect is that the column can cause a reduction in the fire-resistance level (FRL) or resistance to the incipient spread of fire of the elements through which it passes. This can result in the spread of fire. To eliminate this potential problem, it is necessary to use a system tested in accordance with [AS 1530.4](#).

SPECIFICATION **C1.1****FIRE-RESISTING
CONSTRUCTION****Deemed-to-Satisfy Provisions****1 Scope****Intent**

To clarify that **Specification C1.1** contains requirements for fire-resisting construction of building elements.

Note that **Specification C1.1** applies only to the **Deemed-to-Satisfy Provisions** of the BCA. If an **Alternative Solution** is used to satisfy a **Performance Requirement**, it is not necessary to comply with **Specification C1.1**.

Parts **C1, C2, C3, D1, D2, G2, G3** and **H1** of the BCA also contain requirements for building elements to be fire-resisting and to have a fire-resistance level (FRL).

2 General Requirements**2.1 Exposure to fire-source features****Intent**

To define how a building element may be exposed to a fire-source feature.

Fire-source feature

Refer to the definition in **A1.1** on the term ‘fire-source feature’.

A fire-source feature is a possible fire-source external to the building from which fire could spread into the building. It may be an allotment boundary or another building on the allotment from which fire could spread to the subject building.

Clause 2.1 does not consider a building element to be exposed to a fire-source feature if it is shielded from the fire-source feature by another part of the building which:

- has an FRL of 30/-/- or more, and is not transparent or translucent;
- is less than 15 metres above another building on the allotment. Parts of a building more than 15 metres above another building are not deemed to be affected by fire; or
- is below the level of the finished ground at every relevant part of a side or rear boundary.

Figure Spec C1.1(1) illustrates some of the exemptions from the exposure to a fire-source feature.

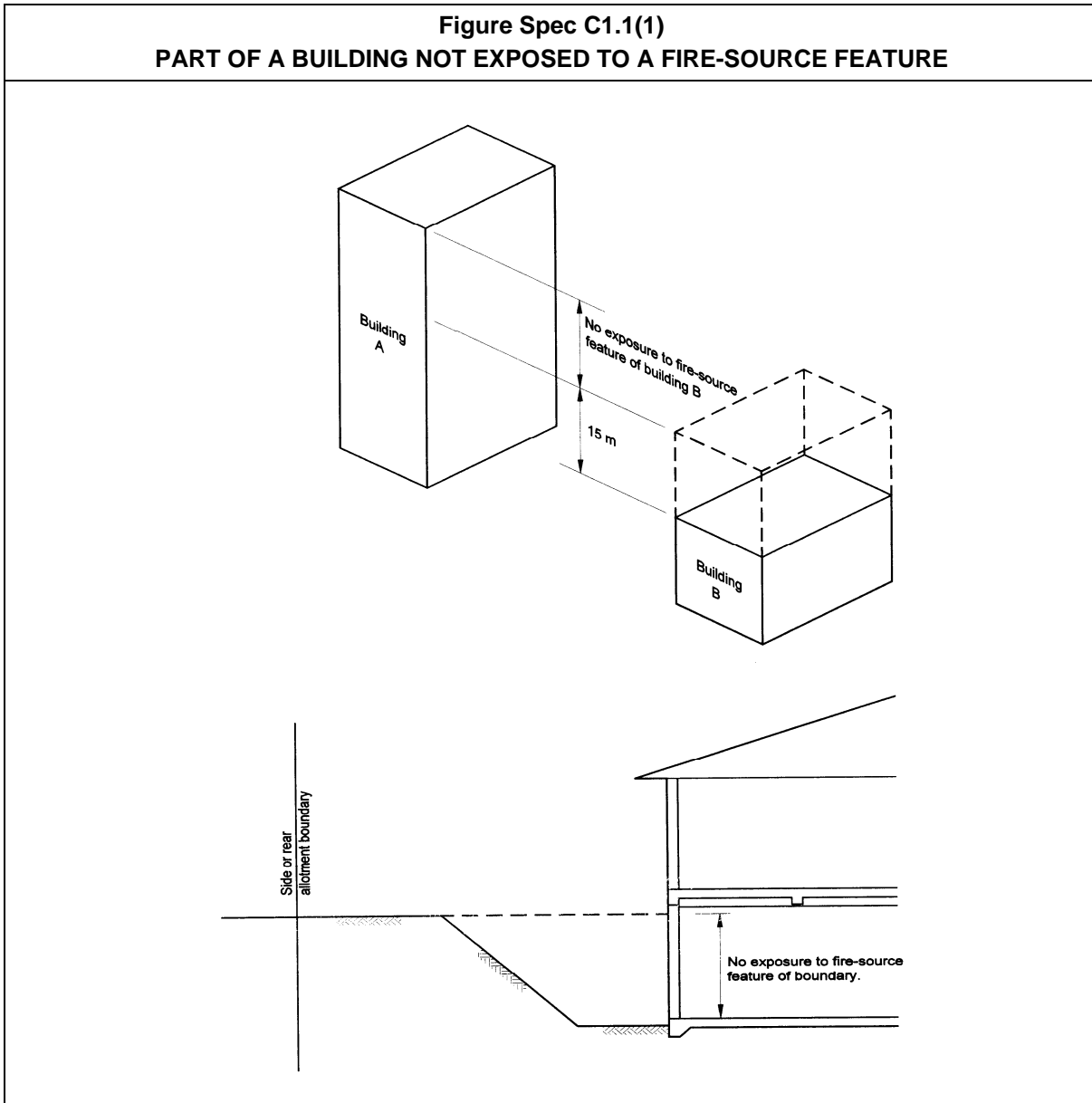

The building element must have an FRL required for the closest part of the element exposed to the fire-source feature (see **Clause 2.1(c)(i)**).

Alternatively, the building element may have a varying FRL according to the individual distance of each section of the building element from the fire-source feature (see **Clause 2.1(c)(ii)**).

Figure Spec C1.1(2) illustrates the alternatives for an external loadbearing wall of a Class 5 building required to be of Type A construction.

2.2 Fire protection for a support of another part

Intent

To minimise the risk that a building element required to have a fire-resistance level (FRL) will fail during a fire due to the failure of another element required to give it vertical or lateral support.

Support of building elements with an FRL

Clause 2.2(a) sets out the requirements for the fire protection of building elements that provide lateral or vertical support to another building element. This is because a building element with an FRL is usually dependent on the support to maintain its FRL.

Accordingly, **Clause 2.2(a)** does not apply to elements that support ceilings required to have a fire-protective covering or a resistance to the incipient spread of fire. Nor to an element required to be non-combustible.

Exceptions of building elements

Clause 2.2(b) lists a number of exemptions to **Clause 2.2(a)(ii)** and **(a)(iii)(B)**.

The lateral support for the types of wall referred to in **Clause 2.2(b)(i)** is considered unnecessary in these cases, because **Clause 5.1(b)** allows the use of brick veneer walls, and **C1.11** enables the prevention of outward collapse of certain external walls by specifying the connection of panels to the building's frame.

The inherent fire resistance of the supports included in **Clauses 3.9, 4.2** and **5.2** is considered adequate in the carparks covered by each clause. It should be noted that compliance with the relevant Table is necessary in order to comply with the relevant clause.

Clause 2.2(b)(iii) exempts roofs providing lateral support to other building elements. This is because of a concession within **Clauses 3.5** for Type A construction. In addition, there is no requirement for Type B and C construction, principally because such buildings are generally low rise.

Clause 2.2(b)(iv) exempts certain columns, as listed in **Clause 2.5**, from having an FRL.

Under **Clause 2.2(b)(v)** a fire wall or fire-resisting wall referred to should not collapse because it is supported by another building element on the other side of the wall.

Figure Spec C1.1(2)
PLAN SHOWING ALTERNATIVE METHODS OF COMPLYING WITH TABLE 3

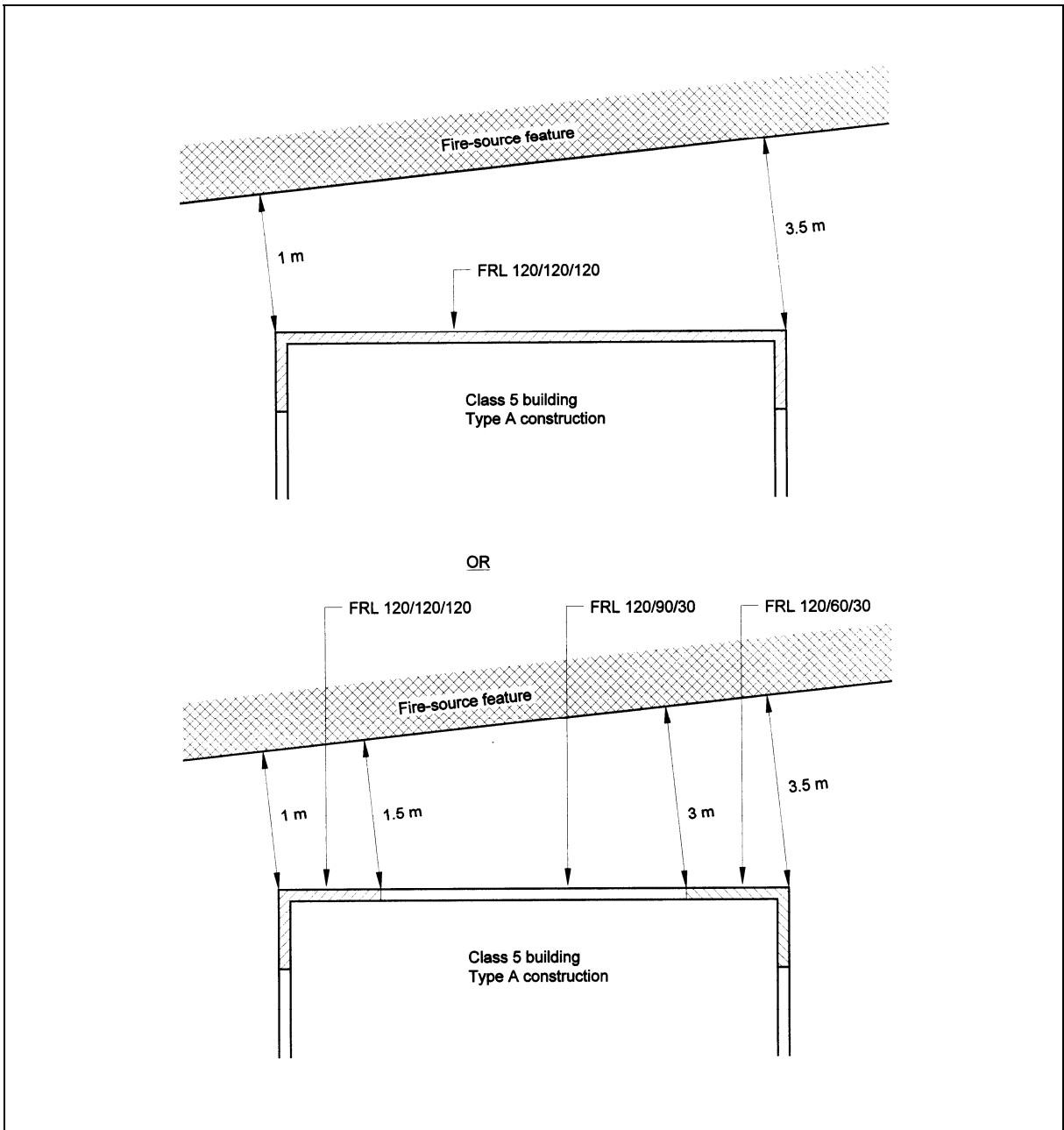

2.3 Lintels

Intent

To minimise the risk that the failure of a lintel over an opening in a wall required to have a fire-resistance level (FRL) will result in the failure of the wall during a fire.

A lintel must have the same FRL as the part of the building containing it. This is unless it does not contribute to the support of a fire door, fire window or fire shutter. Otherwise, the failure of the lintel during a fire could cause the collapse of all, or part, of the wall.

Clause 2.3 only applies to a lintel required by the **Deemed-to-Satisfy Provisions** to have an FRL.

Clauses 2.3(a) and **(b)** contain some concessions for small openings where the failure of the lintel would not result in a major collapse of the wall and lead to the spread of fire to another building.

2.4 Attachments not to impair fire-resistance

Intent

To minimise the risk that a finish, lining or attachment to a wall or roof required to have a fire-resistance level (FRL) will:

- impair the FRL of the wall or roof to which it is attached;
- compromise the safe evacuation of the building; and
- lead to the spread of fire by way of the building facade.

Clause 2.4 does not prohibit the use of combustible materials as a finish, lining or other attachment to a wall, roof or other building element required to have an FRL.

However, the combustible material can only be used if the material:

- is one of the exemptions from fire hazard properties listed in **Clause 7** of **Specification C1.10**, or complies with the fire hazard properties prescribed in **Clause 2** of **Specification C1.10** (see **Clause 2.4(a)(i)**);
- is not located in a position to make a required exit unusable in a fire, therefore it will not compromise the building's safe evacuation (see **Clause 2.4(a)(ii)**);
- will not lead to the spread of fire by way of the building facade (see **Clause 2.4(a)(iii)**); and
- will not impair the FRL of the wall, roof or other building element to which it is attached (see **Clause 2.4(b)**).

Clause 2.4(a) only applies to the use of finishings or linings, and other attachments. **Clause 2.4(b)** prohibits a required FRL of a building part from being reduced by the attachment of facings or finishes or the installation of ducting or any other service.

2.5 General concessions

Intent

To permit the use of certain building practices known to provide acceptable levels of fire safety.

The concessions contained in **Clause 2.5(a)** allow a steel column to not have an FRL in one and, in some cases, two storey buildings.

The basis for this concession is the low rise of such buildings. In many cases, the columns form the legs of a portal frame, with the roof being non-fire rated. In such a case, there would be little benefit in fire rating the column when the roof beams are not rated.

Because of the importance of the structural integrity of a common wall or fire wall in limiting the spread of fire, the concession for steel columns providing lateral support does not apply.

The concessions contained in **Clause 2.5(b)** permit a reduced FRL in timber columns in single storey buildings. One method of determining the FRL of a timber column is to use the charring rate of the type of timber in the column.

The structures on a roof referred to in **Clause 2.5(c)** are not likely to lead to the spread of fire, especially as they are required to be non-combustible. The intent of **Clause 2.5(c)(ii)(E)** is to specify that the concession does not apply to structures that contain units that in turn contain combustible liquids and gases.

The curtain walls referred to in **Clause 2.5(d)** must be non-combustible and protected by an external wall-wetting sprinkler system. When such construction is used, protection is provided from fire spreading to the subject building. For the term 'curtain wall', see **A1.1**. For the purposes of this provision, glass is regarded as non-combustible.

Balconies, verandahs and the like do not generally add a significant fire load to a building. Therefore, they are not required to be in compliance with **Table 3, 4 or 5**. This is provided that occupants are not put at risk during an evacuation because the only means of egress is by way of the balcony, verandah or the like.

Also, if the building is of Type A construction, the balcony, verandah or the like must be situated at a low level of the building, and have non-combustible supports.

2.6 Mezzanine floors: Concession

Intent

To provide concessions for small mezzanines.

The **Clause 2.6** concession does not apply to certain Class 9b buildings, as specified in **Clause 2.6(a)**. The concession only applies to certain small mezzanines, as specified in **Clause 2.6(b)**. If it complies with the conditions specified in **Clause 2.6(b)**, a mezzanine and its support may be constructed from materials that do not have an FRL and/or are combustible.

Table 2.6 requires an increase in each FRL criterion of each wall or column that supports any other part of the building, and is within 6 metres of the mezzanine. There is no case in which a building element, with an increased fire rating, requires an FRL greater than 240 minutes.

Increasing the FRLs surrounding a mezzanine which is combustible, or which does not have an FRL, recognises the increased fire load that exists within both the mezzanine and the storey as a whole. This recognises the fire load limiting effect of the minimum area requirement in **Clause 2.6(b)(i)**.

2.7 Enclosure of shafts

Intent

To minimise compromising the fire-resisting performance of a shaft.

Shaft enclosures required to be fire-resisting must be completely fire-separated from all other portions of the building by building elements that have the appropriate fire-resistance.

Clause 2.7 complements other requirements for the walls of shafts by requiring that shafts be enclosed at the top and bottom by fire rated construction.

Clause 2.7 grants exemptions for the top and bottom of shafts in cases where the likelihood of fire entering the shaft is unlikely. This occurs when the top of the shaft is the top of the building (see **Clause 2.7(a)**), or the bottom of the shaft is laid on the ground (see **Clause 2.7(b)**).

2.8 Carparks in Class 2 and 3 buildings

Intent

To allow the use of residential levels of fire protection to be used for carparks in certain Class 2 and Class 3 buildings.

Part **A3** classifies a storey used for carparking as Class 7. The fire risks of a single storey carpark in a low-rise Class 2 or Class 3 building are not as substantial as they are in other carparks attached to other classifications, so a concession is suitable. This concession is based upon the assumption that the carpark associated with the Class 2 or 3 building will be for the exclusive use of the building occupants and that the carpark would represent a low fire risk.

The sole purpose of this concession is to allow the carpark and/or ancillary use storey to be regarded as a Class 2 or Class 3 building, as applicable, for the purposes of determining the fire resistance requirements of **Specification C1.1**.

This concession applies to buildings which are otherwise wholly Class 2, wholly Class 3 or a mix of Class 2 and 3 and:

- the storey to which the concession is to apply is used only for carparking, or an ancillary purpose such as storage of normal household items (see **Clause 2.8(a)(i)** and **(b)(i)**);
- in the case of Class 2 buildings, contain no more than 4 storeys (see **Clause 2.8(a)(ii)**); and
- in the case of Class 3 buildings or buildings that are a mix of Class 2 and 3, contain no more than 3 storeys (see **Clause 2.8(b)(ii)**).

The reason for the concession applying to an additional storey in Class 2 buildings is that the residents of these buildings are long term and are usually aware of the building layout and exit routes. This concept is consistent with **D1.3**.

The **Clause 2.8** concession does not apply if the building contains any other classification of building.

2.9 Residential aged care building: Concession

Intent

To allow concessions for the fire protection of certain building elements in Residential aged care buildings when a suitable sprinkler system is used to achieve an adequate level of occupant safety.

‘Residential aged care building’ is defined in **A1.1**.

This concession is a response to concerns expressed by aged care organisations and health authorities in regards to the impact of certain regulatory requirements on the design and operation of aged care hostels and nursing homes.

The requirements for fire separation of individual sole-occupancy units (including self-closing doors) in aged care hostels was considered to impose unwarranted development costs.

Fire compartmentation and the installation of door closers was considered to be impractical in the daily use of an aged care facility. Self-closing fire doors are too heavy and difficult to operate by frail, elderly people. In a number of cases this resulted in the doors being wedged open, thus negating the fire separation.

The limitation of the Class 1b concessions to buildings having an area of 300 m² or less and 12 occupants or less (see **A3.2**) meant that those concessions could not be used for many aged care hostels. The concessions in **Clause 2.9** are considered to be reasonable for the larger aged care hostels. In some States or Territories it is not acceptable for a Class 1b building to be used to house elderly people or other people who require special care.

The concession contained in **Clause 2.9(a)** applies to the requirements for floors and loadbearing walls as set out in **Tables 3, 4 and 5** of **Specification C1.1**. The concession, allowing a reduction in FRLs, is limited to where the wall is an internal wall. An external wall is not subject to this concession.

The concession contained in **Clause 2.9(b)** for non-loadbearing internal walls, allows a reduction in FRLs subject to several conditions outlined in **Clause 2.9(b)**. The conditions outlined in **Clause 2.9(b)** must be achieved for the concession to apply. These conditions require walls to be:

- lined with 13 mm standard grade plasterboard, or a non-combustible material equivalent to 13 mm standard grade plasterboard (see **Clause 2.9(b)(i)**); and
- extend to the underside of the floor above, a ceiling lined with standard grade plasterboard not less than 13 mm thick or equivalent fire protective material, or a non-combustible roof covering. The wall height requirement aims to create a smoke proof wall. This aim requires that joints and the like be sealed to prevent the spread of smoke through potential cracks and openings (see **Clause 2.9(b)(ii)**).

Clause 2.9(b)(iii) requires that any insulation in a cavity in a non-loadbearing internal wall must be non-combustible. This is to limit the spread of fire by way of the wall cavity.

The mandatory use of non-combustible materials prohibits the lining of non-loadbearing internal walls with timber panelling. This does not restrict the use of timber mouldings and the like.

In addition to the above concessions for load bearing and non-load bearing walls, doors in a Class 3 building must still comply with the requirements of **C3.11(d)(ii)**, and walls must still comply with the requirements of Part **F5** — Sound Transmission and Insulation.

Other provisions relating to Residential aged care buildings are contained throughout the BCA. These include:

- **C3.11(d)(ii)**, regarding construction bounding sole-occupancy units and public corridors;
- **Clause 6(c)** of **Specification E2.2a**, regarding warning systems; and
- **Specification E1.5**, regarding sprinkler systems.

3 TYPE A FIRE-RESISTING CONSTRUCTION

3.1 Fire-resistance of building elements

Intent

To specify the fire-resistance level (FRL) and other requirements for building elements in Type A construction.

Table 3 of **Specification C1.1** sets out the required FRLs of building elements in a building required to be of Type A construction. The required FRL depends on whether the element is loadbearing or non-loadbearing, if the element comprises or is incorporated in an external wall, and its distance from any fire-source feature.

When using **Table 3** of **Specification C1.1**, it should be noted that **Clause 6** of **Specification A2.3** permits the deletion of the structural adequacy criteria of an FRL for non-loadbearing elements. The reason for this is that if such an element fails during a fire, there will be no flow-on collapse of other elements. See definition of ‘loadbearing’ in **A1.1** to assist in understanding this provision.

The following table lists building elements required to be non-combustible, concrete or masonry in a building of Type A construction.

BUILDING ELEMENT	TYPE A CONSTRUCTION
External wall	Non-combustible
Common wall	Non-combustible
Floor and floor framing of lift pit	Non-combustible
All loadbearing internal walls (including those of shafts)	Concrete or masonry
Loadbearing fire walls	Concrete or masonry
Non-loadbearing walls required to be fire-resisting	Non-combustible
Non-loadbearing lift, ventilation, pipe, garbage and like shafts which do not discharge hot products of combustion	Non-combustible

Clause 3.1(a) requires building elements to achieve at least the FRLs set out in **Table 3**.

Clause 3.1(a) only applies to the building elements listed in **Table 3**, and any beams or columns incorporated in such building elements.

Clause 3.1(b) requires the floor and floor framing of lift pits to be non-combustible because of the fire risks caused by the tendency for combustible material to accumulate in these places.

Clause 3.1(c) requires internal walls to extend to a barrier to stop or limit the spread of fire over the top of the wall. **Clause 3.1(c)** only applies to internal walls required to have an FRL with respect to integrity and insulation. This is consistent with the intent that the walls are only required to extend to the underside of a floor or roof, etc when the wall is required to perform a fire separating function.

Clause 3.1(d) requires loadbearing internal walls and loadbearing fire walls (in both cases, including those which are part of a loadbearing shaft) to be of concrete or masonry.

Under **Clause 3.1(e)(i)**, any non-loadbearing internal wall that is required to be fire-resisting must be of non-combustible material.

Under **Clause 3.1(e)(ii)**, any non-loadbearing shaft that is not used for discharging such combustion products as smoke, coals or embers must be of non-combustible construction.

Internal columns can be exposed to a fire-source feature through a window in an external wall. **Clause 3.1(f)** requires such a column within 1.5 metres of a window to have the same FRL as an external column.

3.2 Concessions for floors

Intent

To allow certain floors to not have a fire-resistance level (FRL).

Clause 3.2 grants floors a number of concessions from the FRL requirement. The reason for each of the concessions is listed below:

- there is no fire load below a floor laid directly on the ground, (see **Clause 3.2(a)**);
- there is a low fire load if the space below a Class 2, 3, 5 or 9 building is not a storey or does not contain the listed elements, (see **Clause 3.2(b)**);
- the space below a stage would generally have a low fire load because it cannot be used as a dressing room, storage area, or the like. A fire in the storey below would not affect the stage because it is over a floor with the required FRL. In addition, the stage would not have a room below which might have a high fire load, (see **Clause 3.2(c)**);
- the floor is within a residential sole-occupancy unit. This is because resistance to the spread of fire between sole-occupancy units only is required. The levels connected are within the one sole-occupancy unit and the spread of fire from one sole-occupancy unit to another would not be affected by the construction of an internal floor without the required FRL, (see **Clause 3.2(d)**); and
- no fire separation is required for an open-access floor as a fire in the storey below could not affect the area because it is over a floor with the required FRL, (see **Clause 3.2(e)**).

3.3 Floor loading of Class 5 and 9b buildings: Concession

Intent

To allow a floor or roof in a Class 5 or Class 9b building to have a reduced fire-resistance level (FRL) if it is above a storey with a lower fire load.

Generally, Class 5 and Class 9b buildings have a comparatively low fire load which can be further reduced if the structural carrying capacity of the floor ('live load') is restricted because there will be a lower likelihood of the building containing a high level of stored combustible materials. AS 1170.1 allows certain areas within office (Class 5) and assembly (Class 9b) buildings to have design floor loads of less than 3 kPa.

In essence, the lower the structural carrying capacity of the storey's floor, the lower the fire load. This lower fire load in turn permits a reduced FRL for the floor or roof above such a storey.

The philosophy of fire protection in this provision is that the fire load of a storey controls the FRL of the floor or roof above it. This is because a fire on one storey will affect the level above to a greater degree than itself.

Clause 3.3(a) sets out the concession for a floor above, and **Clause 3.3(b)** sets out the concession for the roof above.

3.4 Roof superimposed on concrete slab: Concession

Intent

To allow a non-combustible non-fire-rated roof to be superimposed on a concrete slab roof.

Clause 3.4 allows a concession for a roof of non-fire-resisting construction to be superimposed above a concrete slab roof. Such roofs are usually used for weather protection reasons.

Clause 3.4(a) states that the superimposed roof and any supporting members must be non-combustible.

Clause 3.4(b) states that the concrete slab roof must comply with **Table 3** of **Specification C1.1**.

If compliance is achieved with the conditions outlined in **Clause 3.4**, a concession is reasonable because a fire is unlikely to break through the concrete roof slab.

3.5 Roof: Concession

Intent

To allow the roofs of certain buildings not to have a fire-resistance level (FRL).

The roofs of certain types of buildings can be required to have an FRL to limit the spread of fire from the roof to another building, or from another building to the roof. **Clause 3.5** grants a number of concessions by which certain roofs need not have an FRL, provided the roof covering is non-combustible.

In **Clause 3.5(a)**, the BCA assumes that the specified sprinkler system will control any fire prior to it breaking through the roof.

In **Clause 3.5(b)**, the BCA assumes buildings with a rise in storeys of 3 or less will comprise a comparatively low fire risk. Most buildings with a rise in storeys of 3 or less are permitted to be of Type B or Type C construction.

In **Clause 3.5(c)**, the BCA assumes that Class 2 and Class 3 buildings have a relatively low fire load compared to other classifications, and recognises that the potential size of a fire in Class 2 and Class 3 buildings is limited by the bounding construction of the sole-occupancy units. This concession does not apply where another classification forms part of the storey immediately below the roof (eg a restaurant, which is Class 6).

Clause 3.5(d) assumes that the incipient spread of fire resistant ceiling will stop or limit the spread of fire to the roof space or roof of the building for sufficient time for it to be brought under control.

3.6 Rooflights

Intent

To permit rooflights or the like in a roof that is required to either have an FRL or have a non-combustible covering.

The roofs of certain types of building can be required to have an FRL, or to be of non-combustible construction, to limit the spread of fire from the roof to another building. This is particularly the case with a high rise building. **Clause 3.6** specifies the requirements for such rooflights.

The requirements of **Clause 3.6** aim to minimise the risk that fire will spread by way of rooflights:

- from another building on an adjoining allotment;
- to an adjoining sole-occupancy unit; or
- to an adjoining fire compartment or fire-separated part of the building.

Clause 3.6 facilitates this aim by minimising the:

- roof area which can be comprised of rooflights (see **Clause 3.6(a)**);
- distance a rooflight is from an allotment boundary (see **Clause 3.6(b)(i)**);
- distance a rooflight is from unprotected parts of the building which are higher than the roof (see **Clause 3.6(b)(ii)**);
- distance a rooflight is from rooflights or the like in adjoining sole-occupancy units, if the bounding walls are required to have an FRL (see **Clause 3.6(b)(iii)**); and
- distance a rooflight is from any rooflight or the like in adjoining fire-separated parts of the building (see **Clause 3.6(b)(iv)**).

In some cases, the BCA requires incipient spread of fire resistant ceilings to stop or limit the spread of a fire to the roof space.

Clause 3.6(c) provision requires that rooflights be installed in a manner which will maintain the requisite level of protection. This is an example of a ‘performance-type’ provision within the **Deemed-to-Satisfy Provisions**. This is because a ceiling that has resistance to the incipient spread of fire is tested in the horizontal plane.

If rooflights are installed in a building, it may be necessary to install part of the ceiling in the vertical plane to connect the rooflight with the ceiling below. Where this occurs, it may be necessary for a building proponent to provide evidence to an appropriate authority that the method proposed will meet the requirements of **Clause 3.6(c)**.

However, in this case, if the material is installed on a vertical plane yet complies in all other respects with the tested prototype, it is unlikely that the ceiling’s fire performance will be affected.

3.7 Internal columns and walls: Concession

Intent

To allow lower fire-resistance levels (FRLs) for internal columns and walls which only support a non-fire-resisting roof.

In the storey immediately below the roof, under circumstances specified in **Clause 3.7**, it is permissible to reduce or (in some cases) delete the FRL of:

- columns, other than those in that are:
 - within 1.5 metres of a window;
 - face that window; and
 - exposed to a fire-source feature through that window; and
- internal walls, other than fire walls and shaft walls.

Clause 3.7 does not negate the need for internal columns to have the same FRL as an external column (set out in **Clause 3.1(f)**) where that internal column is:

- within 1.5 metres of a window;
- faces that window; and
- exposed to a fire-source feature through that window.

3.8 Open spectator stands and indoor sports stadiums: Concession

Intent

To allow lower fire-resistance levels (FRLs) for building elements in open spectator stands and indoor sports stadiums.

The **Clause 3.8** concession is based on the BCA's overall assumption that there is generally a lower risk to the occupants of open spectator stands and indoor sports stadiums than in other buildings. The reasons for this concession are that:

- an open spectator stand generally has a low fire load, even though it may have a high population, particularly during an event, and is open at the front, facilitating the ventilation of smoke and heat; and
- in most indoor sports stadiums large areas are usually inaccessible to the public (being taken up as part of the sporting events) and the finishes are generally spartan.

See **A1.1** for definition of 'open spectator stand'.

3.9 Carparks

Intent

To allow lower fire-resistance levels (FRLs) for building elements in open-deck or sprinklered carparks.

Clause 3.9 and **Table 3.9** are based on experimental research carried out at the BHP Research Laboratories. The research included full-scale fire tests on open-deck and enclosed carparks, and was supplemented by extensive overseas testing.

The research showed that the **Table 3.9** FRLs will not lead to an unsafe situation or structural failure of a building element in an open-deck carpark, or an enclosed carpark, which is sprinkler protected.

See **A1.1** for definition of 'carpark'. **Clause 3.9(b)** refines this definition when the expression is used in **Clause 3.9** and **Table 3.9**.

Inclusions

Clause 3.9 concessions include:

- a building which solely comprises a carpark (see **Clause 3.9(a)(i)**);
- the carpark section of a building which, in part, has another use, and where the carpark and that use are fire-separated as required in **Clause 3.9(a)(ii)(A)–(D)** (regardless of the classification of that use, or whether that use is next to, above or below the carpark) (see **Clause 3.9(a)(ii)**);
- any administrative area associated with the carpark, such as ticket selling and fee collection areas (see **Clause 3.9(b)(i)(A)**); and
- in a sprinkler protected carpark, small areas ancillary to a Class 2 or Class 3 building, such as part of the carpark used for normal ‘household’ storage (see **Clause 3.9(b)(i)(B)**).

Exclusions

Clause 3.9 concessions exclude:

- any area of another Class (see **Clause 3.9(b)(ii)(A)**);
- another Class 7 use (ie other than carparking), (see **Clause 3.9(b)(ii)(A)**); and
- an area ‘specifically intended’ for the parking of vehicles such as trucks, buses, vans and the like (see **Clause 3.9(b)(ii)(B)**).

Clause 3.9 and **Table 3.9**, while using a refined definition of ‘carpark’, also use the undefined expression ‘carparking’. This word specifically refers to the parking of cars. This is also the intention of refining the definition of ‘carpark’ as expressed by the use of the words ‘specifically intended’ in **Clause 3.9(b)(ii)(B)**.

The purpose of refining this definition, which is to limit the concessions in **Table 3.9** to areas used for the parking of lighter vehicles (that is, vehicles other than commercial trucks, vans, buses and the like), rather than simply limiting them to areas used for the parking of cars only. Accordingly, it would seem contrary to the purpose of this clause to exclude from the refined definition and the word ‘carparking’ such vehicles as motor bikes, van-like family vehicles, non-commercial panel vans, and smaller non-commercial utilities.

Table 3.9 permits building elements to have either a specified FRL or a specified surface area to mass ratio. In relation to columns and beams, **Table 3.9** does not require them to have an FRL if they have the specified surface area to mass ratio. Some authorities refer to this ratio as the ‘heat sink effect’, in that the lower the exposed surface area to mass ratio, the lower will be the member temperature for a given fire.

The concession of **Table 3.9(a)** relating to columns, only applies to columns of any material which support a roof which is not used for carparking, and located 3 metres or more from a fire-source feature to which they are exposed.

The concession of **Table 3.9(b)** only applies to steel columns which support a roof which is used for carparking, and/or located less than 3 metres from a fire-source feature to which they are exposed. This concession is also applicable if the steel columns support any other part of the building which is not used as a carpark.

Columns of any material that do not qualify for **Table 3.9(a)** and **(b)** concessions are subject to **Table 3.9(c)**.

Example

The concession of (b) in the columns section of **Table 3.9** does not apply if the column supports a part of the building specifically intended for the parking of trucks, buses, vans, and the like.

In the section of **Table 3.9** relating to roofs, there is a concession for roofs that are not used for carparking.

A roof used for carparking must comply with any relevant requirements of **Table 3.9** (eg those relating to floor slabs).

3.10 Class 2 buildings: Concession

Intent

To allow low-rise Class 2 buildings which are required to be of Type A construction to be constructed with timber framing and/or non-combustible materials.

Clause 3.10 results from research undertaken by the National Association of Forest Industries, and confirmed by overseas studies.

Clause 3.10 provides a concession to **Clause 3.1(b)**, **(d)** and **(e)** and also to the combustibility requirement of **Clause C2.6** to allow, subject to specified conditions, the use, in certain Class 2 buildings, timber framing instead of an alternative structural support system using non-combustible materials, concrete, or masonry.

Clause 3.10(a)(i) allows the use of timber framing.

Clause 3.10(a)(ii) allows the use of non-combustible materials (such as steel) for firewalls and internal walls required to be fire resisting, instead of concrete or masonry as required by **Clause 3.1(d)**.

Clause 3.10(a)(iii) allows a combination of timber framing and non-combustible materials.

The **Clause 3.10(a)** concession to use timber framing and/or non-combustible materials is conditional on:

- a firewall or internal wall required to be fire-resisting being extended to the underside of the non-combustible roof covering. The wall height requirement, together with the smoke sealing requirement of **Clause 3.10(c)(ii)(D)**, aims to create a smoke proof wall, hence the

requirement for sealing any cracks and openings against the spread of smoke, (see **Clause**

3.10(a)(iv);

- only non-combustible insulation being used in a wall cavity. This aims to limit the spread of fire by way of the cavity; and
- an automatic smoke alarm system being installed in the building to give early warning of a fire.

Clause 3.10(b) allows the top three storeys of a four storey Class 2 building to be constructed with timber framing and/or non-combustible materials if they are located above a single storey used for vehicle parking (note that the limitation in **Clause 3.9** by use of the word ‘carparking’ does not apply here) and ancillary purposes. These ancillary purposes include such items as individual storerooms, laundries, and the like.

To achieve this concession, the lowest carparking storey (including the floor/ceiling between the carpark and the storey above) must be constructed of concrete or masonry, and have the FRLs specified in **Table 3**, or reduced by **Clause 3.10(c)**. The floor between the carpark and the storey above must not contain penetrations or openings that would reduce the fire-resisting performance of the floor. The exception to this is a door which is permitted to be a -/60/30 self-closing fire door.

Under the **Clause 2.8** concession, the vehicle parking storey can be classified as a Class 2 building for the purpose of determining the relevant fire-resisting requirements of **Specification C1.1**.

The basis of the **Clause 3.10(b)** concession is that the concrete or masonry floor of the first storey above the lowest carparking storey will provide adequate fire separation. **Clause 3.10** does not require smoke detectors or sprinklers in the lowest carparking storey because a fire occurring in it should not pose an unacceptable risk to occupants evacuating from the upper three storeys.

Compliance must still be achieved with the other requirements of **Specification C1.1** and other parts of the BCA, including the relevant FRLs listed in **Table 3** of **Specification C1.1**, and any relevant requirements of **Clause E1.5**.

Subject to the conditions listed, including the installation of a sprinkler system, **Clause 3.10(c)** allows:

- a reduction of the FRL of loadbearing walls (see **Clause 3.10(c)(i)**); and
- the deletion of the FRL for non-loadbearing internal walls (see **Clause 3.10(c)(ii)**).

Reference to **Clause 2** of **Specification E1.5** indicates that the required sprinkler system need only comply with **AS 2118.4** — Automatic fire sprinkler systems — Residential. This Standard has been specifically developed to provide a degree of life safety and property protection for occupants of low-rise Class 2 buildings. If the storey used as carpark requires sprinklers by **Clause E1.5**, then the carpark is considered a Class 7 building for the purposes of applying **Specification E1.5** (see **E1.5**).

Clause 3.10(c)(ii) allows non-loadbearing internal walls to have no FRL. The concession is subject to the requirement that the internal walls be lined on each side with 13 mm standard grade plasterboard or non-combustible materials with a similar fire-resisting performance. This means that all doors from sole-occupancy units to corridors, when applying these concessions, must be smoke proof doors. Self-closing solid core doors satisfy this requirement (see **Specification C3.4**).

The **Clause 3.10(c)(ii)(B)** provision regarding the height of a non-loadbearing wall, to which this concession is applied, aims to create a smoke proof wall, hence the requirement for sealing any cracks and openings against the spread of smoke.

The **Clause 3.10(c)(ii)(C)** requirement that only non-combustible insulation can be used in a cavity in a non-loadbearing wall, to which this concession is applied, aims to limit the spread of fire by way of the cavity.

4 TYPE B FIRE-RESISTING CONSTRUCTION

4.1 Fire-resistance of building elements

Intent

To specify the fire-resistance level (FRL) and other requirements of building elements in Type B construction.

Table 4 of **Specification C1.1** sets out the required FRLs of building elements in a building required to be of Type B construction. The required FRL depends on whether the element is loadbearing or non-loadbearing, if the element comprises or is incorporated in an external wall, and its distance from any fire-source feature to which it is exposed.

Although a roof is an external building element that can be exposed to a fire-source feature, it is not required to comply with the FRLs specified under the heading of external wall in **Table 4**. The FRLs required for a roof are contained under the heading of roofs near the bottom of the Table.

When using **Table 4** of **Specification C1.1**, it should be noted that **Clause 6** of **Specification A2.3** permits the deletion of the structural adequacy criterion of an FRL for non-loadbearing elements. The reason for this is that if such an element fails during a fire, there will be no flow-on collapse of other elements. See **A1.1** for the definition of ‘loadbearing’.

Generally speaking, Type B construction differs from Type A construction by allowing lower FRLs for external walls, generally not requiring roofs and floors to have an FRL, and not requiring FRLs for ventilation, garbage, and similar shafts.

These differences are based on the lower rise in storeys allowed by **Table C1.1**; and the smaller size of Type B construction buildings allowed by **Table C2.2**.

The BCA requires the floors of buildings required to be of Type B construction to have an FRL in Class 2 and Class 3 buildings, if the floor supports different sole-occupancy units (see **Clause 4.1(i)**), in Class 9a buildings as part of the fire compartments required by **C2.5(a)(iv)** and in Class 9c buildings as part of the fire compartments required by **C2.5(b)(ii)** (see **Clause 4.1(j)**).

The following table lists building elements required to be non-combustible, concrete or masonry in a building of Type B construction.

BUILDING ELEMENT	TYPE B CONSTRUCTION
External wall	Non-combustible
Common wall	Non-combustible
Floor and floor framing of lift pit	Non-combustible
All loadbearing internal walls (including those of shafts)	Concrete or masonry
Loadbearing fire walls	Concrete or masonry
Non-loadbearing walls required to be fire-resisting	Non-combustible
Non-loadbearing lift, ventilation, pipe, garbage and like shafts which do not discharge hot products of combustion	Non-combustible (subject to conditions outlined in Clause 4.1(h))

Clause 4.1(a) requires building elements to achieve at least the FRLs set out for them in **Table 4**. **Clause 4.1(a)** only applies to the building elements listed in **Table 4**, and any beams or columns incorporated in such building elements.

Clause 4.1(b) requires the floor and floor framing of lift pits to be non-combustible because of the fire risks caused by the tendency for combustible materials or rubbish to accumulate in these places.

Clause 4.1(c) requires stair shafts which support floors or structural parts of floors to either have a specified FRL, or be constructed at the junction of the shaft and floor (or part of floor), so that if the floor falls or collapses (fully or partly) during a fire, the shaft will not be damaged.

Clause 4.1(d) requires internal walls to extend to a barrier to stop or limit the spread of fire over the top of the wall. Such a requirement is not considered necessary when a sole-occupancy unit occupies the whole of the top storey. This concession applies to buildings of Type B construction. **Clause 4.1(d)** only applies to internal walls required to have an FRL with respect to integrity and insulation. This is consistent with the intent that the walls are only required to extend to the underside of a floor or roof, etc when the wall is required to perform a fire separating function.

Clause 4.1(e) requires loadbearing internal walls and loadbearing fire walls (in both cases, including those which are part of a loadbearing shaft) to be of concrete or masonry.

Under **Clause 4.1(f)**, any non-loadbearing internal wall, which is required to be fire-resisting, must be of non-combustible material.

Under **Clause 4.1(g)**, internal columns and internal walls need not comply with **Table 4** if they are:

- in a Class 5–9 building;
- in the storey immediately below the roof; and
- not fire walls or shaft walls.

Under **Clause 4.1(h)**, any non-loadbearing shafts of the type listed which are not used for discharging such combustion products as smoke, coals or embers must be of non-combustible material. In recognition of the comparative likely risk levels, this provision applies to all Class 2, 3 and 9 buildings, and to Class 5–8 buildings where the shaft connects 3 storeys or more. This is because of the increased evacuation, fire-fighting and rescue difficulties that exist in higher buildings.

To protect building occupants of Class 2, 3 and 9 buildings from fire spread between storeys, **Clause 4.1(i)** establishes the minimum fire separation between storeys in such buildings.

This requirement also relates to the fire separation of Class 2, 3 and 9 buildings from a carpark or storage area.

Clause 4.1(i) does not apply if the storeys being separated are within a sole-occupancy unit of a Class 2 or 3 building, because it is likely that the two levels are connected by a non-fire-isolated stairway.

The primary reason for the **Clause 4.1(i)** fire separation requirement is that in a building fire, the highest degree of risk is attached to such people as the very young, people with disabilities, the elderly, and those who are asleep.

Examples

Buildings, which must comply with **Clause 4.1(i)**, include:

- A Class 2 building (which includes flats, apartments, etc).
- A Class 3 building (which includes hotels, motels, etc).
- The residential part of a school.
- Accommodation for the aged, children or people with disabilities.
- A residential aged care building.
- A Class 9a building (which includes hospitals, etc).
- A Class 9b building, such as schools, theatres, and the like.

4.2 Carparks

Intent

To allow lower fire-resistance levels (FRLs) for building elements in open-deck or sprinklered carparks.

Clause 4.2 and **Table 4.2** are based on experimental research carried out at the BHP Research Laboratories. The research included full scale fire tests on both open-deck and enclosed carparks, and was supplemented by extensive overseas testing.

The research carried out on this matter showed that the **Table 4.2** FRLs will not lead to an unsafe situation or structural failure of a building element in an open-deck carpark, or an enclosed carpark which is sprinkler protected.

See **A1.1** for definition of ‘carpark’. **Clause 4.2(b)** refines this definition when the expression is used in **Clause 4.2** and **Table 4.2**.

Inclusions and exclusions

Clause 4.2 concessions include:

- a building which solely comprises a carpark;
- the carpark section of a building which elsewhere has another use;
- any administrative area associated with the carpark, such as ticket selling and fee collection areas; and
- in a sprinkler protected carpark, small areas ancillary to a Class 2 or Class 3 building, such as part of the carpark used for normal ‘household’ storage.

Clause 4.2 concessions exclude:

- any area of another Class;
- another Class 7 use (ie other than carparking); and
- an area ‘specifically intended’ for the parking of vehicles such as trucks, buses, vans and the like.

Clause 4.2 and **Table 4.2**, while using a refined definition of ‘carpark’, also use the undefined expression ‘carparking’. This word specifically refers to the parking of cars. This is also the intention of refining the definition of ‘carpark’ as expressed by the use of the words ‘specifically intended’ in **Clause 4.2(b)(ii)(B)**.

However, in applying these provisions, it is important to consider the purpose of refining this definition, which is to limit the concessions in **Table 4.2** to areas used for the parking of lighter vehicles (that is, vehicles other than commercial trucks, vans, buses and the like) — rather than simply limiting them to areas used for the parking of cars only.

Accordingly, it would seem contrary to the purpose of this clause to exclude from the refined definition and the word ‘carparking’ such vehicles as motor bikes, van-like family vehicles, non-commercial panel vans, and smaller non-commercial utilities.

Regarding certain types of column and beam, **Table 4.2** permits them to have either a specified FRL or a specified surface area to mass ratio. In other words, in relation to these columns and beams, **Table 4.2** does not require them to have an FRL if they have the specified surface area to mass ratio. Some authorities refer to this ratio as the ‘heat sink effect’, in that the lower the exposed surface area to mass ratio, the lower will be the member temperature for a given fire.

The concession for columns in **Table 4.2(a)** applies to columns of any material which support a roof which is not used for carparking, and located 3 metres or more from a fire-source feature to which they are exposed.

The concession in **Table 4.2(b)** only applies to steel columns that support a roof which is used for carparking, and/or located less than 3 metres from a fire-source feature to which they are exposed. This concession is also applicable where steel columns support any other part of the building that is not used as a carpark.

Columns of any material which do not qualify for the **Table 4.2(a)** and **(b)** concessions are subject to **Table 4.2(c)**.

For the purposes of this clause, the usual definition of ‘carpark’ is specifically amended (see **Clause 4.2(b)**).

Example

The concession of (b) in the columns section of **Table 4.2** does not apply if the column supports a part of the building specifically intended for the parking of trucks, buses, vans, and the like.

Table 3.9 provisions restricting the roof concession to those roofs that are not used for carparking does not apply to **Table 4.2**.

The differences between **Table 4.2** and **Table 3.9** are based on the lower rise in storeys allowed for Type B construction buildings by **Table C1.1**.

4.3 Class 2 buildings: Concession

Intent

To allow low-rise Class 2 buildings which are required to be of Type B construction to be constructed with timber framing and/or non-combustible materials.

Clause 4.3 results from research undertaken by the National Association of Forest Industries, and confirmed by overseas studies undertaken.

The effect of **Clause 4.3** is to provide a concession to **Clause 4.1** to allow, subject to specified conditions, the use in certain Class 2 buildings of timber framing instead of an alternative structural support system using non-combustible materials, or concrete, or masonry.

Clause 4.3(a)(i) allows the use of timber framing.

Clause 4.3(a)(ii) allows the use of non-combustible materials (such as steel) for fire walls and internal walls required to be fire-resisting, instead of concrete or masonry as required by **Clause 4.1(e)**.

Clause 4.3(a)(iii) allows a combination of timber framing and non-combustible materials.

Table C1.1 limits Class 2 buildings of Type B construction to a rise in storeys of two. For this reason **Clause 4.3** only applies to two storey Class 2 buildings, and no concession is allowed for a two storey timber framed building above a concrete or masonry lower storey, as is allowed in the case of Type A construction buildings by **Clause 3.10**.

The **Clause 4.3(a)** concession to use timber framing and/or non-combustible materials is conditional on:

- a fire wall or internal wall required to be fire-resisting being extended to the underside of the non-combustible roof covering. The wall height requirement, together with the smoke sealing requirement of **Clause 4.3(b)(ii)(D)**, aims to create a smoke proof wall, hence the requirement for sealing any cracks and openings against the spread of smoke;
- only non-combustible insulation being used in a wall cavity. This aims to limit the spread of fire by way of the cavity; and
- an automatic smoke alarm system being installed in the building to give early warning of a fire.

Under the **Clause 2.8** concession, the carparking storey can be classified as a Class 2 building for the purpose of determining the relevant fire-resisting requirements of **Specification C1.1**.

Subject to the conditions listed, including the installation of a sprinkler system, **Clause 4.3(b)** allows a reduction of the FRL of loadbearing elements, and the deletion of the FRL for non-loadbearing elements.

Reference to **Clause 2** of **Specification E1.5** indicates that the required sprinkler system need only comply with **AS 2118.4** — Automatic fire sprinkler systems — Residential. This Standard has been specifically developed to provide a degree of life safety and property protection for occupants of low-rise Class 2 buildings (see **E1.5**).

Clause 4.3(b) allows non-loadbearing internal walls to not have an FRL. The concession is subject to the requirement that the internal walls be lined on each side with 13 mm standard grade plasterboard or non-combustible materials.

The **Clause 4.3(b)(ii)(B)** provision regarding the height of a non-loadbearing wall to which this concession is applied aims to create a smoke proof wall, hence the **Clause 4.3(b)(ii)(D)** requirement for sealing any cracks and openings against the spread of smoke.

The **Clause 4.3(b)(ii)(C)** requirement that only non-combustible insulation can be used in a cavity in a non-loadbearing wall to which this concession is applied aims to limit the spread of fire by way of the cavity.

There is no specific concession to permit the use of solid core doors in Type B construction buildings, unlike that in **Clause 3.10(c)(ii)(E)**, this is because they are already permitted in Type B construction (see **C3.11**).

The result of **Clause 4.3** is that a designer proposing to use the BCA **Deemed-to-Satisfy Provisions** to design a two storey Class 2 building of Type B construction has three basic options:

- design in accordance with other provisions applicable to buildings of Type B construction which, under **Clause 4.1(b), (e) and (f)**, would exclude the use of timber external walls, common walls, loadbearing internal walls, fire walls and non-loadbearing internal walls required to be fire-resisting;
- use timber and/or non-combustible materials in accordance with **Clause 4.3**; or
- comply with **C1.5** and design for Type C construction, which places no limitations on the use of timber.

5 TYPE C FIRE-RESISTING CONSTRUCTION

5.1 Fire-resistance of building elements

Intent

To specify the fire-resistance level (FRL) and other requirements of building elements in a building required to be of Type C construction.

Table 5 of **Specification C1.1** sets out the required FRLs of building elements in a building required to be of Type C construction. If the element comprises or is incorporated in an external wall, the required FRL depends on distance from any fire-source feature to which it is exposed. Although a roof is an external building element that can be exposed to a fire-source feature, it is not required to comply with the FRLs specified under the heading of external wall in **Table 5**. The FRLs required for a roof are contained under the heading of roofs near the bottom of the table.

When using **Table 5** of **Specification C1.1**, it should be noted that **Clause 6** of **Specification A2.3** permits the deletion of the structural adequacy criteria of an FRL for non-loadbearing elements. The reason for this is that if such an element fails during a fire, there will be no flow-on collapse of other elements. See **A1.1** for definition of ‘loadbearing’.

Generally speaking, Type C construction differs from Type B construction by allowing lower FRLs for external walls which are located more than 1.5 metres from a fire-source feature, and only requiring a maximum FRL of 90 minutes for any criterion. **Table C2.2** bases these differences on the lower rise in storeys allowed by **Table C1.1**, and the smaller size of Type C buildings allowed.

No building element in a building required to be of Type C construction is required to be non-combustible, or of concrete or masonry.

Clause 5.1(a) requires building elements to achieve at least the FRLs set out for them in **Table 5**. **Clause 5.1(a)** only applies to the building elements listed in **Table 5**, and any beams or columns incorporated in such building elements.

Where **Table 5** requires an external wall to have an FRL, **Clause 5.1(b)** requires that the wall only need be tested from outside to meet the FRL criteria. This allows the use of brick veneer construction where the brick has the required FRL.

Where a fire wall and the specified internal walls are of lightweight construction they must comply with **Specification C1.8**.

Clause 5.1(d) requires internal walls to extend to a barrier to stop or limit the spread of fire over the top of the wall.

The concession contained in **Clause 4.1(d)** for Type B construction with respect to the height of the wall when a sole-occupancy unit occupies the whole of the top storey, does not apply to Type C construction.

To protect building occupants of Class 2, 3 and 9 buildings from fire spread between storeys, **Clause 5.1(e)** establishes the minimum fire separation between storeys in such buildings. This requirement takes into account the special risks that can exist in such buildings.

This requirement also relates to the fire separation of Class 2, 3 and 9 buildings from a carpark or storage area.

Clause 5.1(e) does not apply if the storeys being separated are within a sole-occupancy unit of a Class 2 or Class 3 building, because it is likely that the two levels are connected by a non-fire-isolated stairway and would therefore not be required to be fire separated.

The primary reason for the **Clause 5.1(e)** and **(f)** fire separation requirement is that in a building fire, the highest degree of risk is attached to such people as the very young, people with disabilities, the elderly, and those who are asleep.

Examples

Buildings that must comply with **Clause 5.1(e)** include:

- A Class 2 building (which includes flats, apartments, etc).
- A Class 3 building (which includes hotels, motels, etc).
- The residential part of a school.
- Accommodation for the aged, children or people with disabilities.
- A residential aged care building.
- A Class 9a building (which includes hospitals, etc).
- A Class 9b building, such as schools, theatres, and the like.

5.2 Carparks

Intent

To allow lower fire-resistance levels (FRLs) for building elements in open-deck or sprinklered carparks.

Clause 5.2 and **Table 5.2** are based on experimental research carried out at the BHP Research Laboratories. The research included full scale fire tests on both open-deck and enclosed carparks, and was supplemented by extensive overseas testing.

The research carried out on this matter showed that the **Table 5.2** FRLs will not lead to an unsafe situation or structural failure of a building element in an open-deck carpark, or an enclosed carpark which is sprinkler protected.

See **A1.1** for definition of ‘carpark’. **Clause 5.2(b)** refines this definition when the expression is used in **Clause 5.2** and **Table 5.2**.

Inclusions and exclusions

The **Clause 5.2** concessions include:

- a building which solely comprises a carpark;
- the carpark section of a building which elsewhere has another use;
- any administrative area associated with the carpark, such as ticket selling and fee collection areas; and
- in a sprinkler protected carpark, small areas ancillary to a Class 2 or Class 3 building, such as part of the carpark used for normal ‘household’ storage.

The **Clause 5.2** concessions exclude:

- any area of another Class;
- another Class 7 use (ie other than carparking); and
- an area ‘specifically intended’ for the parking of vehicles such as trucks, buses, vans and the like.

Clause 5.2 and **Table 5.2**, while using the refined definition of ‘carpark’, also use the undefined expression ‘carparking’. This word specifically refers to the parking of cars. This is also the intention of refining the definition of ‘carpark’ as expressed by the use of the words ‘specifically intended’ in **Clause 5.2(b)(ii)(B)**.

However, in applying these provisions, it is important to consider the purpose of refining this definition, which is to limit the concessions in **Table 5.2** to areas used for the parking of lighter vehicles (that is, vehicles other than commercial trucks, vans, buses and the like), rather than simply limiting them to areas used for the parking of cars only.

Accordingly, it would seem contrary to the purpose of this clause to exclude, from the refined definition and the word ‘carparking’, such vehicles as motor bikes, van-like family vehicles, non-commercial panel vans, and smaller non-commercial utilities.

Regarding certain types of columns and beams, **Table 5.2** permits them to have either a specified FRL or a specified surface area to mass ratio. In other words, in relation to these columns and beams, **Table 5.2** does not require them to have an FRL if they have the specified surface area to mass ratio. Some authorities refer to this ratio as the ‘heat sink effect’, in that the lower the exposed surface area to mass ratio, the lower will be the member temperature for a given fire.

In the section of **Table 5.2** relating to columns:

- the concession of (a) applies only to steel columns that are located less than 1.5 metres from any fire-source feature; and
- the concession of (b) applies only to columns of any material which are located less than 1.5 metres from any fire-source feature.

Columns of any material that do not qualify for the (a) and (b) concessions are subject to (c).

Roofs that do not qualify for the roof concession in **Table 5.2** must comply with the requirements of **Specification C1.1** for roofs of other buildings.

Table 3.9 provisions restricting the roof concession to those roofs that are not used for carparking does not apply to **Table 5.2**.

The differences between **Table 5.2** and **Table 4.2** are based on the lower rise in storeys allowed for Type C buildings by **Table C1.1**.

SPECIFICATION C1.8**STRUCTURAL TESTS FOR
LIGHTWEIGHT CONSTRUCTION****Deemed-to-Satisfy Provisions****Specification C1.8**

This Guide does not address, in detail, every provision in this Specification.

Lightweight construction is more susceptible to damage than other forms of fire protection. It therefore needs protection to preserve its integrity in a fire.

Specification C1.8 describes a number of tests on walls of lightweight construction which can be used to demonstrate their acceptance as a fire protection system under the Deemed-to-Satisfy Provisions.

SPECIFICATION **C1.10** FIRE HAZARD PROPERTIES

Deemed-to-Satisfy Provisions

2 Class 2 to 9 buildings: General requirements

Intent

To prescribe the fire hazard properties of materials and surfaces used in Class 2-9 buildings.

Flammability, Spread-of-Flame and Smoke-Developed Indices

Methods of fire protection are so diverse that it is not possible to list them all. **Specification C1.10** takes the alternative approach of permitting only materials having specific measures on the Flammability Index, Spread-of-Flame Index, and Smoke-Developed Index. These indices are defined in **A1.1**.

Specification C1.10 does not refer to limits on toxic products of combustion (such as carbon monoxide and carbon cyanide).

Clause 2 sets out the early fire hazard indices for a range of materials in particular buildings. Where the provisions of **Clause 2** are applicable, the subject materials or components must meet the criteria outlined in **Clause 2(a)-(d)**, as appropriate.

The fire hazard index requirements specified in **Clause 2** apply to all materials or components used in Class 2 and Class 3 buildings, and Class 5–9 buildings, except the following, which have special requirements in **Clause 3** and **4**:

- materials or components used in fire-isolated exits;
- materials or components (other than sarking) used in Class 2, Class 3 and Class 9 buildings and which comprise a finish, lining or attachment to walls or ceilings in public corridors leading to required fire-isolated exits, or an external stairway used instead of a required fire-isolated stairway;
- materials or components (other than sarking) used in patient care areas in a Class 9a building, and which comprise a finish, lining or attachment to ceilings, walls or floors;
- materials or components (other than sarking) used in a Class 9b building used as a theatre or public hall which is not protected by a sprinkler system, and which comprise a finish, lining or attachment to ceilings, walls or floors; and
- materials or components (other than sarking) used in a Class 9b building used as a theatre or public hall, and which comprise fixed seating in the audience area.

Clause 2(a) requirement for a sarking-type material to have a Flammability Index of not more than 5 is to minimise the risk of sarking facilitating the spread of fire.

Example

Before the flammability of sarking was regulated, there was a supermarket fire with the following characteristics:

- The building was single storey, and similar to the current Type C construction.
- The fire was caused by faulty electrical wiring, started in a small switch and staff room, and was noticed by an employee in its initial stages.

Under normal circumstances this fire would be easily extinguished, but it penetrated the ceiling through a small hole for electrical wiring and ignited the sarking immediately above. The sarking aided the spread of fire through the roof space.

As a result, there was severe damage to the roof structure, including the metal roof cladding, steel purlins, bracing and trusses, timber battens and plaster ceilings, leading to burning debris falling down onto the floor.

Clause 2(b) outlines the fire hazard indices for materials other than sarking. These include:

- the Spread-of-Flame Index; and
- the Smoke-Developed Index.

If a material or component does not meet the requirements for any other criterion in **Clause 2**, **Clause 2(c)** specifies that it must be covered on all faces by concrete or masonry which is at least 50 mm thick.

Clause 2(d) sets out the compliance criteria for members and assemblies made up of several materials and components.

3 Fire-isolated exits

Intent

To prescribe the early fire hazard indices of materials and surfaces used in fire-isolated exits, to minimise the risks in an evacuation.

Clause 3 applies only to materials or components used in fire-isolated exits.

Because fire-isolated exits are considered a safe place for people seeking egress during a fire, it is acknowledged that they should be as safe as possible. The importance of such exits is recognised in the BCA provisions for ceiling, wall and floor finishes which are more stringent than the levels prescribed for other parts of the building.

The basic aim of **Clause 3** is to minimise the risk of a fire in a fire-isolated exit.

It could be claimed that fire is unlikely to enter fire-isolated exits because of their construction and protection, and that therefore there is no need for control of the finishes within them. However, compromising the integrity of fire-isolated exits is not at all unusual. For example:

- removal, alteration or deterioration of fire doors; and

- wedging open of fire doors in fire-isolated stairways.

The prescribed Flammability Index, Spread-of-Flame Index, and Smoke-Developed Index measures aim to limit finishes to those which are no more hazardous than a conventional paint finish on a non-combustible surface.

4 Class 2, 3 and 9 buildings

Intent

To provide some additional fire safety requirements for Class 2, Class 3 and Class 9 buildings.

Clause 4(a) covers materials or components (other than sarking) used in Class 2, Class 3 and Class 9 buildings and which comprise a finish, lining or attachment to walls or ceilings in public corridors. These are only corridors leading to:

- required fire-isolated exits; or
- an external stairway used instead of a required fire-isolated stairway.

Clause 4(b) covers materials or components (other than sarking) used in patient care areas in a Class 9a building, and which comprise a finish, lining or attachment to ceilings, walls or floors.

Clause 4(c) covers materials or components (other than sarking) used in a Class 9b building used as a theatre or public hall which is not protected by a sprinkler system, and which comprises a finish, lining or attachment to ceilings, walls or floors.

Clause 4(d) covers materials or components (other than sarking) used in a Class 9b building used as a theatre or public hall, and which comprises fixed seating in the audience area.

A high standard of fire-resisting construction for walls and ceilings in public corridors has to be maintained, because of their use.

The BCA takes the approach that fire-isolated exits are primary evacuation routes. On the other hand, public corridors are an initial escape route used at the start of a fire.

Public corridors of Class 2, Class 3 and Class 9 buildings require a Spread-of-Flame Index of 0 and a Smoke-Developed Index of 5, which are prescribed on the basis that they will:

- provide a reasonable level of protection, by preventing or restricting the spread of fire; and
- enable the continued use of a wide range of existing linings and surface finishes, while excluding those representing an undesirable level of risk.

Materials in/on a floor present a lesser hazard from spread of flame and smoke emission than do similar materials on walls or ceilings. Consequently, lesser requirements are specified for

floor finishes and coverings in Class 2, Class 3 and Class 9 buildings.

5 Materials deemed to comply

Intent

To permit the use of certain specified non-hazardous materials

Clause 5 lists materials deemed to comply with **Clauses 2, 3** and **4**. Accordingly, no test results are required to prove that these materials meet the requirements of **Clauses 2, 3** and **4**.

6 Fire-retardant coatings not acceptable**Intent**

To state that paint or fire-retardant coatings cannot be used to make a painted or coated surface comply with the Deemed-to-Satisfy Provisions.

Some paints have been designed to reduce flame spread on combustible materials. These paints, usually referred to as ‘fire-retardant paint’, cannot be used to achieve a required Flammability Index, Spread-of-Flame Index, or Smoke-Developed Index for any surface.

This material is unable to be used because of its susceptibility to damage.

Clause 6 does not prohibit the use of suitable impregnated materials that achieve the relevant indices.

7 Exempted building parts and materials**Intent**

To exempt certain building components and materials from the requirement to comply with **Specification C1.10**.

Clause 7 is a practical recognition that a number of building components and materials are unlikely to significantly contribute to the spread of fire and smoke, because of their size, construction, location and so on. **Clause 7** exempts such components and materials from compliance with **Specification C1.10**.

Clause 7(g) grants an exemption to permit the use of glass fibre reinforced polyester (GRP) rooflights in single storey buildings required to be of Type C construction.

The material is limited to GRP because it does not droop or drip when alight. Furthermore, **Clause 7(g)** limits the disposition and quantity of the GRP for use in the roof. This restriction is to reduce the likelihood of the rapid horizontal spread of fire over large sections of roofing.

Accordingly, for the exemption to be used there must be:

- separation between individual rooflights made of this material;
- a restricted area for each rooflight; and
- only a portion of the total roof sheeting made up of GRP.

GRP does not have the Spread-of-Flame and Smoke-Developed Indices required by the Specification. However, the **Clause 7** concession is provided because if GRP is installed in the prescribed manner, its use in single storey buildings of Type C construction will not materially increase the risk of spread of fire and smoke.

Clause 7(j) refers to elements within buildings such as joinery units, cupboards, shelving and the like which are typically attached to the building structure, however do not form part of the building structure. These elements are exempt as they do not form part of the structure and typically are not included within building works approval. Notwithstanding that these elements are often fixed to the building structure for stability, they are generally of low hazard and may be likened to any building furniture which is not subject to the fire hazard properties provisions.

8 Air-handling ductwork

Intent

To specify requirements for air-handling ductwork.

Air-handling ductwork has the potential to cause the rapid spread of fire throughout a building. It is important that the materials used in its construction be appropriate to avoid this potentially dangerous situation. The particular requirements are covered by [AS 4254](#).

9 Lift cars

Intent

To specify requirements for lift cars.

Lift cars are small-enclosed spaces, with minimal ventilation and no active fire suppression equipment. They also do not have an immediate means of egress. The materials used in their construction must be appropriate to avoid a potentially dangerous situation. The particular requirements are outlined in [AS 1735.2](#). The appropriate Occupational Health and Safety Authorities also enforce these requirements.

SPECIFICATION C1.11 PERFORMANCE OF EXTERNAL WALLS IN FIRE

Deemed-to-Satisfy Provisions

1 Scope

Intent

To clarify that **Specification C1.11** aims to minimise the risk, in a fire, of external walls collapsing outwards as complete panels and panels separating from supporting members.

Specification C1.11 contains detailed **Deemed-to-Satisfy Provisions** that could form part of a **Building Solution** to achieve **CP5**. These provisions include solutions to avoid the potential collapse outwards, as whole panels, of concrete external walls in a building with a rise in storeys of not more than 2, and minimum design loads which panel connections must resist during a fire.

2 Application

Intent

To clarify that **Specification C1.11** applies only to buildings with a rise in storeys of 2 or less, where those buildings have concrete external walls that could collapse as complete panels.

Specification C1.11 applies only to buildings with a rise in storeys of 2 or less, where the external walls are constructed using tilt-up and precast concrete panels.

Figures Spec C1.11(1) and **Spec C1.11(2)** illustrate some of the types of construction covered by **Specification C1.11**.

Figure Spec C1.11(1)
TYPICAL NON-LOADBEARING PANELS REQUIRED TO COMPLY WITH SPECIFICATION C1.11
(PANELS MAY BE FULL BAY, MULTIPLE VERTICALLY OR HORIZONTALLY SPANNING)

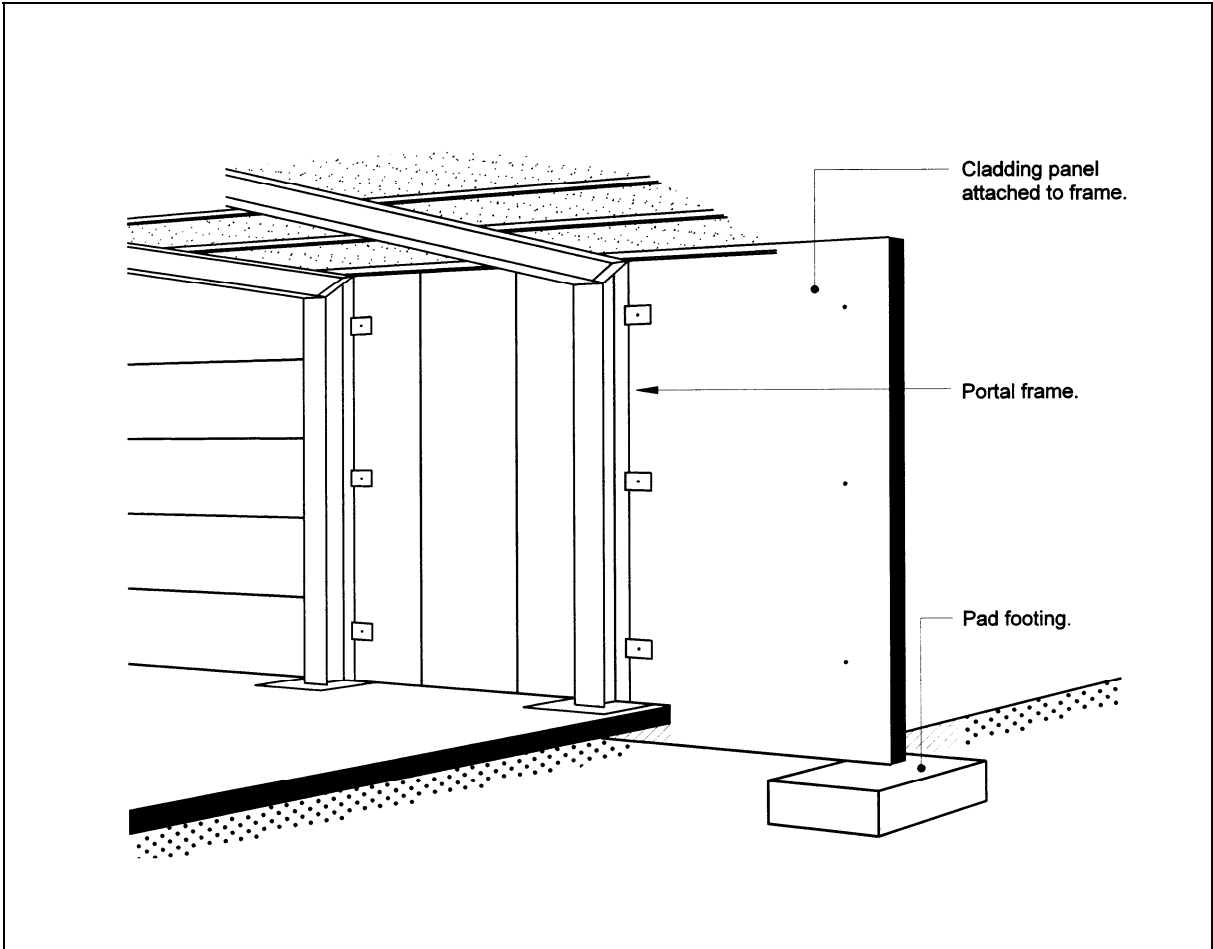

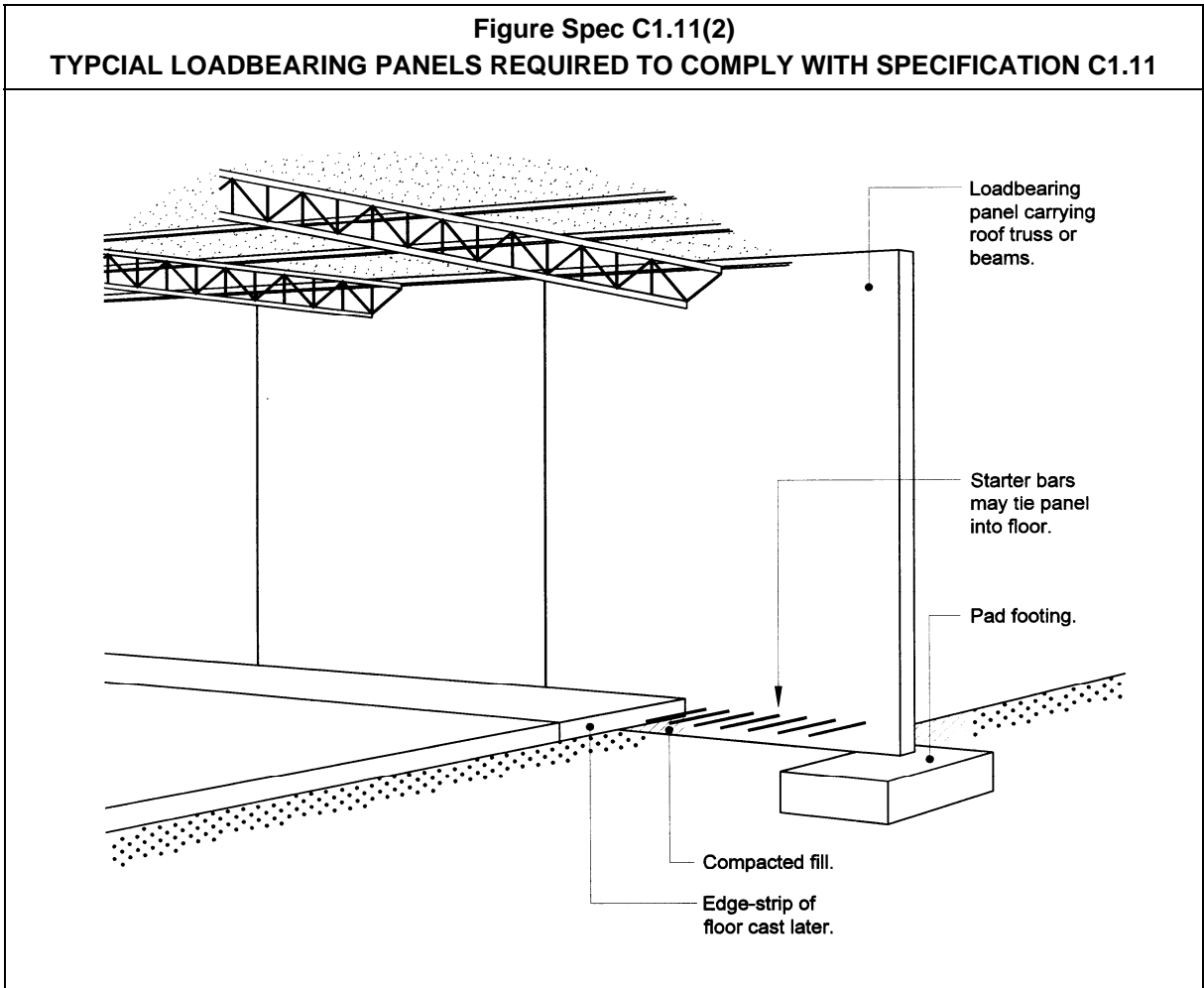

3 General requirements for external wall panels

Intent

To provide general requirements for external wall panels which will minimise the risk of them collapsing in a fire and causing death and/or injury.

The concrete shear cone is the element of a panel that provides the bulk of the interconnection or fixing load capacity of the panel to the main structure. The aim of **Clause 3(a)** is to provide some attachment to the panel after the concrete shear cone has failed during a fire. See **Figure Spec C1.11(3)**.

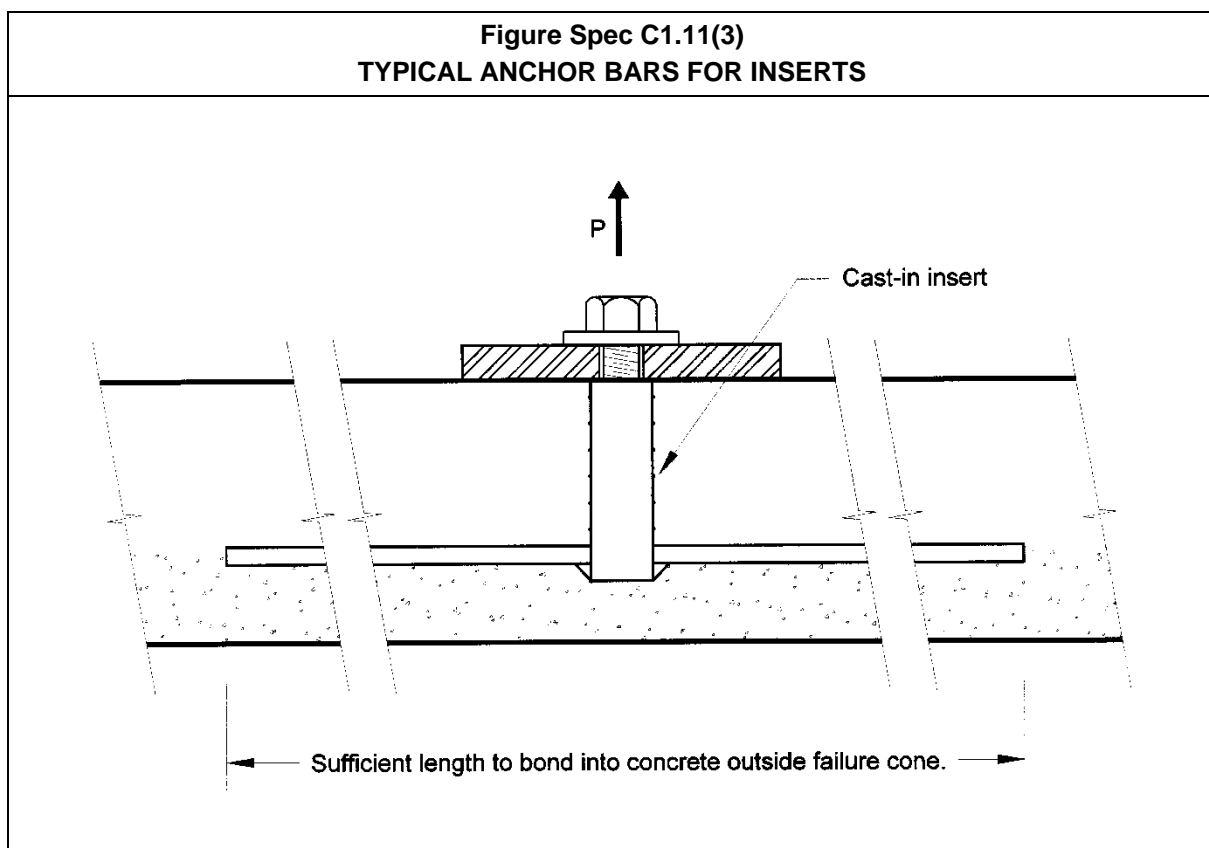

Clause 3(b) sets out the strength capacity required for top inserts or fixings so that the collapsing framework or roof structure will pull the panel inwards. See **Figure Spec C1.11(4)**. The value for outward displacement of one tenth of the panel's height is based on observations of deflections on buildings during a fire.

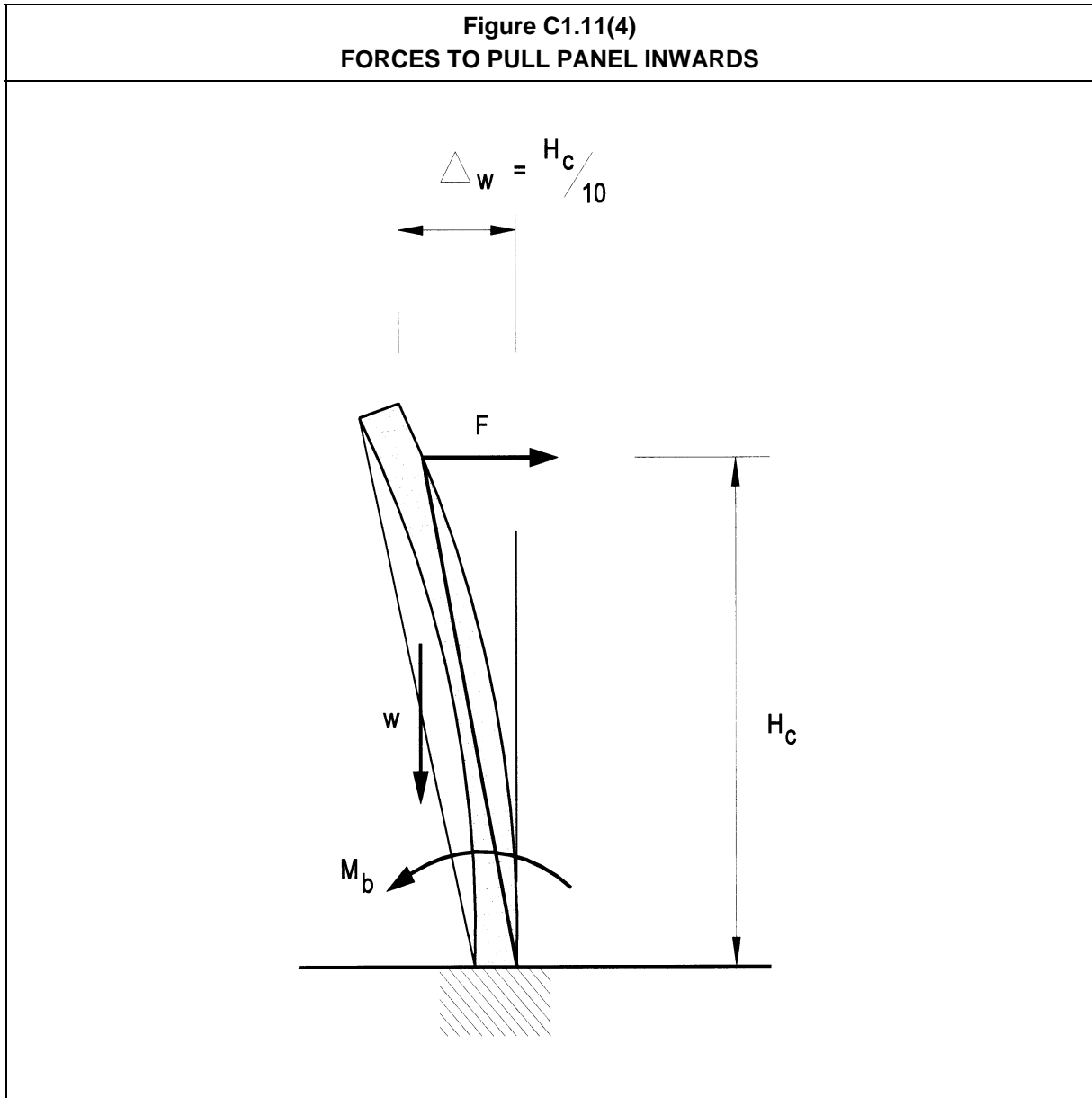

Drilled-in inserts and clips will suffer a greater strength loss from exposure to fire than cast-in inserts. The difference between the factor of two given in **Clause 3(b)** and of six in **Clause 3(c)** is based on engineering principles.

The lateral supporting members referred to in **Clause 3(d)**, for ‘tilt-up type buildings’, may be roof beams or trusses.

Where the wall panels are supported by eaves tie members, **Clause 3(d)** requires that calculation of the forces in the eaves tie take into account the geometry of the deformations of the eaves tie. **Figure Spec C1.11(5)** illustrates this requirement.

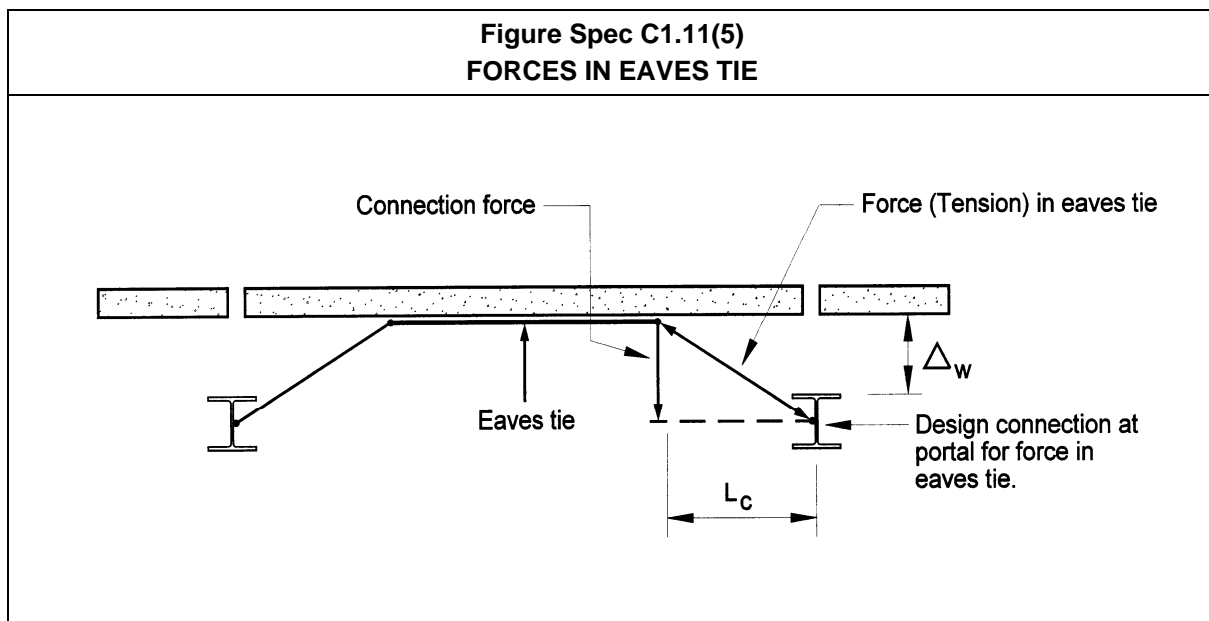

When applying the provisions of **Clause 3(e)**, panels used in a group have to be actually ‘designed to act as one unit’. It is not enough for the designer just to nominate the number of panels that are to act together.

While **Specification C1.11** mostly applies to vertically spanning panels, **Clause 3(f)** addresses specific provisions applicable to horizontally spanning panels.

4 Additional requirements for vertically spanning external wall panels adjacent to columns

Intent

To provide some additional requirements to enhance the safety of vertically spanning external wall panels which are adjacent to columns.

Observation of the effects of fires shows that during a fire:

- concrete panel walls tend to bow away from a fire;

- steel framework softens; and
- steel columns tend to deflect into the building.

These results create large forces on fixings of concrete wall panels to steel columns. Accordingly, **Clause 4(a)** requires that connections minimise the effect of such forces.

The provisions of **Clause 4(b)** provide two means of complying with **Clause 4(a)**. However, they may not be the only means. **Clause 4(a)** is a performance criterion.

Clause 4(b) provides two strategies for the designer to adopt to minimise fire induced forces on the means used to fix vertically spanning concrete wall panels to steel columns.

If the supporting framework is a material other than steel, such as concrete or timber, the differential deflections assumed by **Clause 4** will not occur, and the requirements of **Clause 4(b)(i)** and **(ii)** will be inappropriate.

Clause 4(b)(i) suggests a design of a fixing that will accommodate the expected differential displacement. **Figure Spec C1.11(6)** illustrates possible solutions to provide for the deflections. The magnitude of the differential deflection given in **Clause 4(b)(i)(A)** and **(B)** is based on observations of buildings under fire conditions.

The solution referred to in **Clause 4(b)(ii)** depends on fixing the concrete panel to the eaves tie member, and taking up the differential deflection in the eaves tie member. The distance this connection must be made away from the column is specified.

If this option is taken, the eaves tie member must be designed to comply with **Clause 3(d)**.

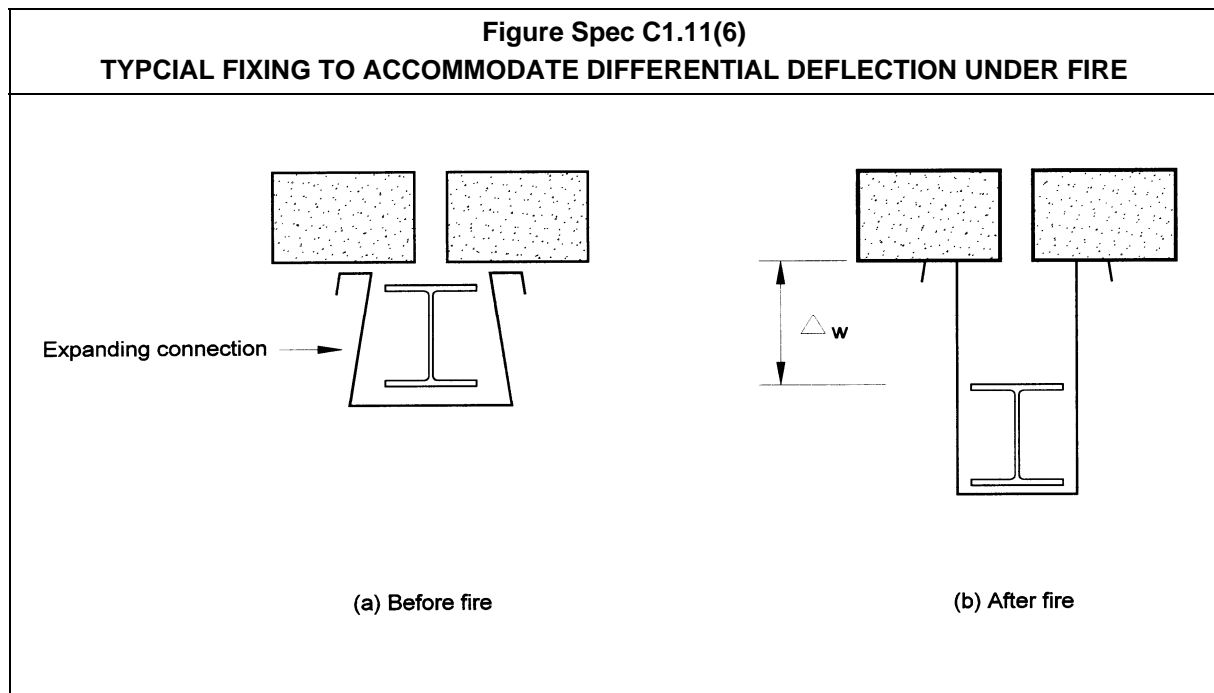

SPECIFICATION **C2.5** SMOKE-PROOF WALLS IN HEALTH-CARE AND AGED CARE BUILDINGS

Deemed-to-Satisfy Provisions

1. Scope

Intent

To prescribe construction requirements for smoke-proof walls required by C2.5 in health-care and aged care buildings.

Specification C2.5 applies to smoke-proof walls in–

- Class 9a health-care buildings; and
- Class 9c aged care buildings.

2. Class 9a health-care buildings

Intent

To prescribe construction requirements for smoke-proof walls required by C2.5 in Class 9a health-care buildings.

Clause 2 applies to smoke-proof walls in Class 9a health-care buildings.

3. Class 9c aged care buildings

Intent

To prescribe construction requirements for smoke-proof walls required by C2.5 in Class 9c aged care buildings

Clause 3 applies to smoke-proof walls in Class 9c aged care buildings.

4. Doorways in smoke-proof walls

Intent

To limit the spread of smoke between smoke-zones by the use of smoke-reservoirs.

SPECIFICATION **C3.4** FIRE DOORS, SMOKE DOORS, FIRE WINDOWS AND SHUTTERS

Deemed-to-Satisfy Provisions

1 Scope

Intent

To prescribe standards for the construction of fire doors, smoke doors, fire windows and fire shutters.

Specification C3.4 contains detailed **Deemed-to-Satisfy Provisions** that could form part of a **Building Solution** for achieving the **Performance Requirements** relevant to:

- fire doors;
- smoke doors;
- fire windows; and
- fire shutters.

2 Fire Doors

Intent

To specify the fire performance of fire doors to achieve compatibility with the fire performance of the walls in which they are located.

Required fire doors must comply with [AS/NZS 1905.1](#), which is the construction Standard for fire doors. This Standard in turn requires that fire doors be tested in accordance with [AS 1530.4](#). If there is any glazing in the door, the door must not fail by radiation through that glazing within the period specified in the door's FRL criterion of integrity.

In most cases, the BCA requires a fire door to have an FRL of -/60/30. Where a fire door is located in a firewall, a higher FRL is required.

The first criterion of zero minutes is a reference to the structural adequacy of the door. [AS 1905.1](#) does not require a fire door to be tested for structural adequacy.

The final criterion of 30 minutes is a reference to the insulation the door must provide. It is difficult for a fire door to achieve a higher insulation criterion when tested in accordance with AS 1530.4.

Any glass panel in a fire door must not fail through heat radiation during a fire, as measured by the AS 1530.4 test, before the door fails the integrity criterion. If the glass panel fails by radiation, spread of fire could occur due to radiant heat igniting combustible materials.

3 Smoke Doors

Intent

To specify the smoke performance of smoke doors to achieve compatibility with the smoke performance of the walls in which they are located, by minimising the flow of smoke from one side of the door to the other.

Clause 3.1 is a performance criterion for smoke doors. It sets the general requirement that smoke doors must prohibit the passage of smoke from one side to the other; and if glass panels are installed, minimise the risk of injury of people accidentally walking into them. For example, it would generally be acceptable for the panel to be opaque.

To comply with **Clause 3.1**, a building proponent may choose to comply with **Clause 3.2**.

Construction deemed-to-satisfy

Intent

To specify the general requirements under the Deemed-to-Satisfy Provisions for the construction of smoke doors.

Under **Clause 3.2(a)**, the leaves of a smoke door which is intended to achieve the requirements of **Clause 3.1** must swing in both directions, or in the direction of travel. This means that they cannot be sliding doors or roller shutters.

To make sure that a door is adequately smoke sealed during a fire:

- the doors must achieve a resistance to smoke at 200°C for 30 minutes. To achieve this, the door leaves can be at least 35 mm thick solid core timber, or of some other construction if the building proponent can satisfy the appropriate authority that it will achieve the requirements of **Clause 3.2(b)(i)**;
- the leaves must be fitted with smoke seals;
- the door must normally be closed, or automatic-closing;
- where the door is automatic-closing, it must be activated by smoke detectors which comply with the relevant provisions of AS 1670.1 and are located as specified in **Clause**

3.2(d)(ii)(A). Under **Clause 3.2(d)(ii)(B)**, the doors release and close in a power failure; and

- where the doors are opened manually, they must return to the closed position each time they are opened.

Clause 3.2 requires glazing in smoke doors to comply with [AS 1288](#). The glazing must achieve the requirements of **Clause 3.2(g)(i)** if it is capable of being mistaken for an unobstructed opening as part of an exit. This is achieved by complying with the requirements of **Clause 3.2(g)(ii)**. The intent of **Clause 3.2(g)** is not to permit the glazing in smoke doors to be entirely of clear construction.

Other means of achieving it can be used if the building proponent can satisfy the appropriate authority that they will achieve the requirements of **Clause 3.2(g)(i)**.

There is currently some discussion regarding whether or not seals around smoke resistant doors are required to achieve the same resistance to smoke at 200°C in the same manner as the smoke door leaves under **Clause 3.2(b)(i)**. Any queries on this matter should be referred to the State or Territory body responsible for building regulatory matters.

4 Fire Shutters

Intent

To enable the fire performance of fire shutters to be compatible with the fire performance of the walls in which they are located.

Under **Clause 4(a)(i)**, required fire shutters must have the required FRL determined in accordance with **Specification A2.3**.

Specification A2.3 requires that a prototype of the element being tested must be subjected to the Standard Fire Test. See [AS 1530.4](#).

In order for a fire shutter to comply with **Specification C3.4**, it must be identical to a prototype tested in accordance with [AS 1530.4](#).

When testing the FRL of fire shutters in accordance with [AS 1530.4](#), the structural adequacy criteria is not included. Hence, these criteria are not included in the required FRL of a fire shutter.

Under **Clause 4(a)**, non-metallic fire shutters:

- must be identical to a prototype tested in accordance with [AS 1530.4](#);
- must not be larger than the tested prototype; and
- during the [AS 1530.4](#) testing, the temperature on the non-furnace side of the shutter must not exceed 140 K during the first 30 minutes of the test.

The reason for the last condition is to reduce the amount of radiant heat on the non-fire side of the shutter, which could ignite combustible materials.

Under **Clause 4(b)**, metallic fire shutters can only be used if not prohibited by **C3.5**. Metallic fire shutters are not permitted in certain situations because of the risk that fire could spread by way of radiated heat facilitated by the metal construction of the shutter. Such radiated heat could ignite combustible materials on the non-fire side of the shutter.

If permitted, metallic fire shutters must either comply with **AS 1905.2** or be in accordance with **Clause 4(a)**, in that they:

- must be identical to a prototype tested in accordance with **AS 1530.4**;
- must not be larger than the tested prototype; and
- during the **AS 1530.4** testing, the rise in temperature on the non-furnace side of the shutter must not exceed 140 K during the first 30 minutes of the test.

5 Fire Windows

Intent

To specify the fire performance of fire windows to achieve compatibility with the fire performance of the walls in which they are located.

Required fire windows must have the required FRL determined in accordance with **Specification A2.3**.

Specification A2.3 requires that a prototype of the element being tested must be subjected to the Standard Fire Test. See **AS 1530.4**.

Therefore, in order for a fire window to comply with **Specification C3.4**, it must be identical to a prototype tested in accordance with **AS 1530.4**.

When testing the FRL of fire windows in accordance with **AS 1530.4**, the structural adequacy and insulation criteria are not included. Hence these criteria are not included in the required FRL of a fire window.

**SPECIFICATION C3.15 PENETRATION OF WALLS,
FLOORS AND CEILINGS BY
SERVICES**

Deemed-to-Satisfy Provisions

Specification C3.15 sets out details of permissible service penetrations through walls, floors and ceilings, and was developed using building practices that are in general use. The Specification permits the use of metal pipe systems and conduits (but not flue pipes) which do not satisfy the insulation criteria of [AS 1530.4](#), provided certain criteria are met.

Specification C3.15 does not apply to larger diameter electrical cables (ie where the opening is larger than those specified in **Clause 5(a) and (b)** of 2000 mm² or 500 mm²). This does not mean that larger diameter electrical cables cannot be approved under **C3.15**. Larger diameter electrical cables can be approved under **C3.15(a)** or, if necessary, as an **Alternative Solution**.

SECTION **D**

ACCESS AND EGRESS

- D1 Provision for Escape**
- D2 Construction of Exits**
- D3 Access for People with Disabilities**

SECTION D CONTENTS

	Page
Section D Access and Egress	10,021
Objective DO1	
Functional Statements DF1 - DF2	
Performance Requirements DP1 - DP9	
Part D1 Provision for Escape	10,151
D1.0 Deemed-to-Satisfy Provisions	
D1.1 Application of Part	
D1.2 Number of exits required	
D1.3 When fire-isolated exits are required	
D1.4 Exit travel distances	
D1.5 Distance between alternative exits	
D1.6 Dimensions of exits and paths of travel to exits	
D1.7 Travel via fire-isolated exits	
D1.8 External stairways or ramps in lieu of fire isolated exits	
D1.9 Travel by non-fire-isolated stairways or ramps	
D1.10 Discharge from exits	
D1.11 Horizontal exits	
D1.12 Non-required stairways, ramps or escalators	
D1.13 Number of persons accommodated	
D1.14 Measurement of distances	
D1.15 Method of measurement	
D1.16 Plant rooms and lift motor rooms: Concession	
Part D2 Construction of Exits	10,701
D2.0 Deemed-to-Satisfy Provisions	
D2.1 Application of Part	
D2.2 Fire-isolated stairways and ramps	
D2.3 Non-fire-isolated stairways and ramps	
D2.4 Separation of rising and descending stair flights	
D2.5 Open access ramps and balconies	
D2.6 Smoke lobbies	

	Page	
D2.7	Installations in exits and paths of travel	
D2.8	Enclosure of space under stairs and ramps	
D2.9	Width of stairways	
D2.10	Pedestrian ramps	
D2.11	Fire-isolated passageways	
D2.12	Roof as open space	
D2.13	Goings and risers	
D2.14	Landings	
D2.15	Thresholds	
D2.16	Balustrades or other barriers	
D2.17	Handrails	
D2.18	Fixed platforms, walkways, stairways and ladders	
D2.19	Doorways and doors	
D2.20	Swinging doors	
D2.21	Operation of latch	
D2.22	Re-entry from fire-isolated exits	
D2.23	Signs on doors	
Part D3	Access for People with Disabilities	11,101
D3.0	Deemed-to-Satisfy Provisions	
D3.1	Application of Part	
D3.2	General building access requirements	
D3.3	Parts of buildings to be accessible	
D3.4	Concessions	
D3.5	Carparking	
D3.6	Identification of accessible facilities, services and features	
D3.7	Hearing augmentation	
D3.8	Tactile indicators	
Specifications		11,201
D1.12	Non-Required Stairways, Ramps and Escalators	
D3.6	Braille and Tactile Signs	

SECTION D ACCESS AND EGRESS

Issues — Part D3 and the relevant performance provisions

Compliance with Disability Discrimination Act 1992 (DDA)

Compliance with the Federal *Disability Discrimination Act 1992 (DDA)* is required, even if such compliance appears to be inconsistent with the relevant State or Territory building legislation.

Legislation

Where the Commonwealth and any relevant State or Territory legislation operates concurrently, and there are inconsistencies, the Commonwealth Act takes precedence.

Disability Discrimination Act and the BCA

The DDA overrides any BCA provisions which are inconsistent with it, otherwise it operates concurrently with the BCA.

Disability Discrimination Act — complaint based

The DDA does not provide any form of prescriptive guidance to compliance. It is complaint based. That is, non-compliance is asserted and tested by a complaint to the relevant body. This is different to the approach adopted in the BCA, which states detailed performance provisions, and provides extensive guidance to compliance in the form of the Deemed-to-Satisfy Provisions.

Enquiries

Enquiries regarding discrimination matters should be referred to the relevant bodies. This includes the Commonwealth's Human Rights and Equal Opportunity Commission and the various State and Territory anti-discrimination bodies. The State and Territory building regulatory authorities may also be able to provide advice.

Objective**DO1****Safe, equitable and dignified access — DO1(a)**

DO1(a) requires the provision of safe, equitable and dignified access to a building and its services, as far as is reasonable. Several of these terms are explained below.

As far as is reasonable

There may be occasions when the application of a rule is ‘unreasonable’. Use of the phrase ‘as far as is reasonable’ indicates that the BCA provisions are not absolute. This is consistent with the intent of the DDA.

Equitable

One of the primary intentions of the DDA is to provide people with disabilities with the same rights as the rest of the community.

The word ‘equitable’ combines concepts of fairness and equality. It does not mean that all people must be able to do precisely the same thing in the same way. However, if some people can use a building for a particular purpose, then most people should be able to use the building for that purpose.

Examples

If most members of the community enter a building at a particular point, normally the front entrance, people with disabilities should be able to enter the same building at that point.

However, this may not mean entry through the same door. For example, a revolving door may not be suitable for guide dogs or wheelchairs. However, people who use guide dogs or wheelchairs should be able to enter the building at an adjacent door.

The concept of ‘equitable’ does not necessarily mean that everybody should be able to access all parts of a building.

Dignified

A person with a disability should be able to gain access to and within a building, and to the services and facilities of buildings, in a manner which is not devaluing or demeaning.

Safeguarding people evacuating — DO1(b)

DO1(b) refers to safeguarding occupants while evacuating in an emergency. This includes people with disabilities who cannot independently use exits and may require special egress arrangements.

Example

A person who is able to walk without assistance is able to reach a public space on an upper level of a building with dignity, perhaps by walking up a flight of stairs. A person with a mobility disability should also be able to access that space with similar dignity. It is unlikely that having to be carried up the stairs would achieve this requirement.

PERFORMANCE PROVISIONS

Functional Statements**DF1**

DF1(b) refines the intention of **DO1(a)**.

It also limits the application of **DF1(b)** to the following:

- a Class 3, 5, 6, 8 or 9 building: or
- a Class 7 building other than a carpark associated with a Class 2 building (the reason is because **DF1(b)** does not apply to a Class 2 building); or
- a Class 10a building other than one associated with a Class 1 or 2 building or a Class 4 part of a building.

Access to these buildings must also be equitable and dignified. See **DO1**.

DF2

DF2 refines the intention of **DO1(b)**. A building must provide the capacity for occupants to evacuate in a safe and timely manner, without being overcome by the effects of the emergency (for example, smoke, heat or flame in the case of a fire).

DF2 does not apply to the internal parts of any sole-occupancy unit located within a Class 2 or Class 3 building or a Class 4 part. The design of the internal parts of sole-occupancy units is not regulated in regards to egress, as occupants will generally be familiar with egressing the units and the distances to travel to doors leading out of the units will generally not be excessive.

Performance Requirements**DP1****Standard of access to and within a building**

DP1 refines the intention of **DO1(a)**. A building must, as far as is reasonable, provide safe access for people to all the services and facilities in it.

It also limits the application of **DP1(b)** to the following:

- a Class 3, 5, 6, 8 or 9 building; or
- a Class 7 building other than a carpark associated with a Class 2 building (the reason is because **DF1(b)** does not apply to a Class 2 building); or
- a Class 10a building other than one associated with a Class 1 or 2 building or a Class 4 part of a building.

Access to these buildings must also be equitable and dignified.

Emphasis on access for people

The required access is for people, including people with disabilities.

To the degree necessary

DP1 uses the term ‘to the degree necessary’. See **A1.7**.

DP2

Safe movement required within a building

DP2 generally sets the performance required for safe movement within a building for most people, including those with disabilities.

Safe gradient — DP2(a)

The **DP2(a)** requirement for a safe gradient is to facilitate access and safety for all people, and refers to the crossfall as well as the longitudinal grade.

Doors — DP2(b)

DP2(b) aims to make sure people are not put at risk by doors impeding egress or causing them to be trapped.

Stairways and ramps — DP2(c)

Slip-resistant walking surfaces — **DP2(c)(i)**

People moving on stairways and ramps should not slip and fall. This is a particular issue during an emergency.

Handrails — **DP2(c)(ii)**

Handrails may be necessary to assist people using stairways and ramps, particularly in helping them maintain their stability.

Landings for ramps — **DP2(c)(iii) and (iv)**

Under **DP2(c)(iii)** and **(iv)**, it is necessary to provide landings for ramps as well as stairways. As with stairways, the landings on a ramp are used as a place to rest when necessary. Landings at doorways provide a level plane from which doors may be safely opened.

Safe passage on stairways — **DP2(c)(v)**

DP2(c)(v) requires that a stairway must be suitable for the safe passage of people, and appropriate to the nature, volume and frequency of use. This is a reference to the riser and going of the treads, and the width of the stairway. Hence the rise, going and width may differ between buildings as long as a safe passage is provided.

DP3

Barriers

DP3 principally relates to barriers which are meant to prevent people accidentally falling through an opening, etc.

Barriers and children

Children are at particular risk of falling off, over or through ineffectively designed or constructed barriers. Accordingly, **DP3** makes specific reference to the need for such barriers to restrict the passage of children.

Use of windows as barriers

Provided it achieves the requirements of **DP3** (such as having the required strength and not opening far enough to permit the passage of children), a window can act as a barrier. In other words, it will stop people, including children, from accidentally falling.

DP3 limitations

Areas where barriers may interfere with use

DP3 does not apply where the use of a balustrade or the like would be inconsistent with the use of the area.

Examples

Loading docks, where a barrier would inhibit the unloading of trucks or other vehicles.

The stage of a theatre, where a barrier would interfere with the viewing of the performance.

Railway platforms, where a barrier would result in people not being able to get on or off a train.

Fire-isolated stairways or ramps

Fire-isolated stairways or ramps and the like are exempted from **DP3(d)** because unsupervised children are unlikely to have access to such areas.

Class 7 and Class 8 buildings

Class 7 (other than carparks) and Class 8 buildings are exempted from **DP3(d)**. This is for two primary reasons:

- unsupervised children are unlikely to have access to such buildings; and
- large numbers of people, particularly members of the general public unfamiliar with the building or its environs, are unlikely to have access to such buildings.

Carparks are not included in this exemption from compliance with **DP3(d)** as they are often public in nature.

DP4

Number, dimensions and distribution of exits

DP4 is the Performance Requirement for the number, dimensions and distribution of exits.

DP4(a) — the travel distance will affect the time taken to evacuate the building. Greater distances will require greater evacuation times.

DP4(b) — the number of occupants can affect the evacuation time. A greater number of people will require a greater evacuation time through a single exit. This time can be reduced by such means as:

- increasing the number and/or width of the exits, or
- reducing the travel distance to the exits by utilising other options for their location.

DP4(b) — the mobility and other characteristics of occupants will have a direct affect on the evacuation time. Matters to be considered include whether the occupants are likely to have limited mobility or capacity to find their way unassisted, and the type and the extent of that limitation. For example, people may be in beds or have some kind of ambulatory-related disability, or may be asleep or anaesthetised, or may be under the influence of drugs or otherwise confused.

DP4(c) — the function or use of the building will have an effect on the building's fire load.

DP4(d) — the height of the building will affect the distance a person escaping from the building would have to travel. The height therefore has an impact on the evacuation time.

DP4(e) — to ensure the safety of occupants, an exit from a level below ground level needs to satisfy different criteria to that of an exit from levels above ground. For example, an exit from a basement must take account of criteria such as:

- the difficulty in naturally venting smoke from a fire because of the lack of windows; and
- the need for occupants to evacuate in the direction of smoke travel (which will be upwards). This is the opposite to upper storeys, where people would be evacuating downwards and the smoke would be travelling upwards.

DP5

Fire-isolated exits

DP5 is the Performance Requirement for determining when fire-isolated exits are necessary to provide protection for evacuating occupants.

Use of fire-isolated exits

Fire-isolated exits are used in multi-storey buildings to:

- enable people to evacuate safely past a storey on fire;
- facilitate fire brigade access to carry out operations such as search and rescue and fire-fighting; and
- minimise the distance people need to travel in a fire affected area before they are able to access a 'safe place', such as a fire-isolated stairway.

Criteria for fire-isolated exits

Fire-isolated exits must be installed when necessary, and must be appropriate to a number of factors.

DP5(a) — the number of storeys connected by the exit will affect the distance a person has to travel while escaping from the building, and, therefore, will also affect the evacuation time.

DP5(b) — fire safety systems are expected to reduce the rate of fire spread (eg if a sprinkler system is installed, it will either extinguish the fire or reduce its growth rate), therefore allowing greater evacuation times.

DP5(c) — the function or use of the building will have an effect on the building's fire load.

DP5(d) — the number of storeys passed through by the exits will affect the distance a person escaping from the building would have to travel, and therefore has an impact on the evacuation time.

DP5(e) — 'fire brigade intervention' is the terminology used in the BCA to determine the time taken by the brigade to arrive at the building (presuming that the building is in an area served

by a fire brigade) and any likely action of its officers (eg whether they will undertake a search and rescue operation, and the likely time for that operation).

DP6

Paths of travel to an exit

DP6 is the Performance Requirement for paths of travel to an exit. It is separate from **DP4** because the needs for paths of travel are often different from the needs for exits.

Class 2 or Class 3 buildings or Class 4 parts

The limitation attached to **DP6** indicates that it does not apply within a sole-occupancy unit of a Class 2 or Class 3 building or Class 4 part. The design of the internal parts of sole-occupancy units is not regulated in regards to egress, as occupants will generally be familiar with egressing the units and the distances to travel to doors leading out of the units will generally not be excessive.

The exception to the general rule concerning the path of travel to the door leading out of a sole-occupancy unit of a Class 2 or Class 3 building or Class 4 part is when smoke hazard management matters are being considered. For more information on the reason for this exception, refer to Part **E2**.

Class 2 buildings and associated Class 7 carparks

The second limitation attached to **DP6** concerning Class 2 buildings and associated Class 7 carparks is applicable as **DP1** does not require access to such buildings therefore provisions for egress are also not required.

Criteria for paths of travel to exits

As set out in **DP6**, paths of travel to exits must have dimensions appropriate to a number of factors, including:

- **DP6(a)** — the number of occupants can affect the evacuation time — the greater the number of people the greater the evacuation time required (this time can be reduced by increasing the number and/or width of (exits) and paths of travel to exits);
- **DP6(a)** — the mobility and other characteristics of occupants will have a direct impact on the evacuation time — matters to be considered include whether the occupants are likely to have limited mobility or capacity to find their way unassisted, and the type and the extent of that limitation (for example, people may be in beds or have some kind of ambulatory-related disability, or may be asleep or anaesthetised, or may be under the influence of drugs or otherwise confused); and
- **DP6(b)** — the function or use of the building takes account of any special provisions such

as movement of beds in hospitals.

DP7

Standard of access for people with disabilities

DP7 refines the intention of **DO1(a)**. A building must, as far as is reasonable, provide safe access for people to all the services and facilities in it.

It also limits the application of **DP7** to the following:

PERFORMANCE PROVISIONS

- a Class 3, 5, 6, 8 or 9 building: or
- a Class 7 building other than a carpark associated with a Class 2 building (the reason is because **DF1(b)** does not apply to a Class 2 building); or
- a Class 10a building other than one associated with a Class 1 or 2 building or a Class 4 part of a building.

Access to these buildings must also be equitable and dignified.

Accessway

The term ‘accessway’ is a defined expression and is used to describe the path of travel to and within a building which is suitable for people with disabilities. It is an abbreviation of ‘continuous accessible path of travel (accessway)’ as used in [AS 1428.1](#), Design for Access and Mobility, General requirements for access - New building work.

Access for people with disabilities begins where the general public approach the building or park cars before entering the building.

Access must be provided to all places in the building accessed by the general public and employee work spaces, as well as facilities such as toilets and the like specifically designed for use by people with disabilities.

Accessway features

The features required in accessways in **DP7(a)**, **(b)** and **(c)** include those which may be necessary to provide safe, equitable and dignified access for people with a disability.

Although the requirement in **DP7(c)** relates only to the manoeuvrability of a wheelchair, the remainder of **DP7** is applicable to access for people with other types of disability.

DP8**Carparking spaces for people with disabilities**

DP8 is the Performance Requirement for carparking spaces for people with disabilities.

If carparking is provided in or around a building, suitable carparking spaces must be provided for people with disabilities. These spaces are required to be larger than a conventional space. This facilitates a person transferring from a vehicle to a wheelchair or other mobility aid positioned between vehicles.

Carparking spaces — ‘to the degree necessary’

DP8 uses the term ‘to the degree necessary’ with regard to the number of carparking spaces. This expression is designed to provide flexibility in the way this provision is implemented.

In essence, use of the term ‘to the degree necessary’ means that the BCA recognises that different circumstances require different approaches, and allows the appropriate authority to determine the degree of compliance necessary in each particular case, having considered the relevant criteria applicable to the building.

Any decision made in this context can extend to not requiring an item to be installed or particular level of performance to be achieved if that is the appropriate action to be taken.

An assessment of ‘necessary’ may comprise analysis of the number of people with a certain disability as a proportion of the general population. This means that the number of carparking spaces may not be ‘necessary’ for all occasions, as they would be for occasions such as an aged persons’ concert, or a conference of people with ambulatory disabilities.

The principle outlined above also determines the proportion of such things as:

- sanitary facilities;
- sole-occupancy units; and
- auditorium wheelchair spaces.

DP9**Hearing augmentation**

DP9 is the Performance Requirement for hearing augmentation and refines the intention of **DO1(a)**. A building must, as far as is reasonable, provide safe access for people to all the services, facilities and features. **DP9** relates to the inclusion of hearing augmentation systems where an inbuilt audible communication system is used for entry, information, entertainment, or provision of a service. This requirement is not intended to apply to equipment such as televisions, music systems etc that are provided for the purposes of improving an occupant’s general comforts and ambience but which are not associated with the specific functioning of the building or specific services or entertainment provided.

It does not apply to:

- a Class 2 or Class 4 part of a building; or
- a Class 7 carpark associated with a Class 2 building,

that are not required to be accessible and therefore not required to be provided with hearing augmentation.

It is also important to note that it does not apply to an inbuilt communication system used only for emergency warning purposes.

PART **D1** PROVISION FOR ESCAPE

Objective

Functional Statements

Performance Requirements

The Objective, Functional Statements and Performance Requirements precede Part **D1**.

Deemed-to-Satisfy Provisions

D1.0 Deemed-to-Satisfy Provisions

Intent

To clarify that the requirements of **DP1 to DP9** will be satisfied if compliance is achieved with Parts **D1**, **D2** and **D3** in the case of all buildings, and Part **G3** in the case of buildings with an atrium, and Part **H1** in the case of theatres, stages and public halls.

Most buildings

D1 clarifies that for most buildings compliance with Parts **D1**, **D2** and **D3** will achieve compliance with **DP1 to DP9**. The exceptions to this general rule are set out below.

Buildings with an atrium

If the building contains an atrium, it must comply with Part **G3** in addition to Parts **D1**, **D2** and **D3**.

Theatres, stages and public halls

A building which comprises a theatre, stage or public hall must comply with Part **H1** in addition to Parts **D1**, **D2** and **D3**.

Atrium and theatre, stage or public hall

If the building contains an atrium and one or more of a theatre, stage or public hall, it must comply with Parts **D1**, **D2**, **D3**, **G3** and **H1**.

Buildings in alpine areas

A building located in an Alpine Area must comply with Part **G4** in addition to Parts **D1**, **D2** and **D3**.

D1.1 Application of Part

Intent

To exempt internal parts of sole-occupancy units in Class 2 and Class 3 buildings and Class 4 parts from the Part **D1** Deemed-to-Satisfy Provisions.

Sole-occupancy units — Class 2 and Class 3

The Part **D1 Deemed-to-Satisfy Provisions** do not apply within a sole-occupancy unit of a Class 2 or Class 3 building and Class 4 parts.

This is because most occupants are familiar with the layout of their unit. The units are small in area compared to sole-occupancy units in other classes of building. They will also have a low level of occupancy and a lower fire load than most commercial and industrial buildings.

Additionally, such units will be separated from the rest of the building by fire-rated construction, or sprinklers will be installed. Except when considering smoke-hazard management matters, the path to the door leading out of sole-occupancy units is not regarded as part of the path of travel to an exit. See Part **E2**.

D1.2 Number of exits required

Intent

To require the provision of sufficient exits to enable safe egress in case of an emergency.

All buildings — D1.2(a)

Under **D1.2(a)**, all buildings must have at least one exit from each storey. The remainder of **D1.2** sets out the circumstances in which more than one exit may be required.

Why do some buildings require multiple exits?

The purpose of regulatory control over the number of exits in a building is to maximise the opportunities for people to have egress from the building in an emergency.

Egress from some buildings can be very difficult (for example, particularly tall or large buildings, or even small buildings which have a complex passageway design). It may be necessary to provide several alternative exits.

Horizontal exits

D1.1

While a number of the **D1.2** provisions refer to ‘horizontal exit’, they do not require the installation of a horizontal exit. Rather, where a horizontal exit exists or is proposed, at least two additional exits must be provided. Where there is no horizontal exit, there must still be at least two exits.

Class 2 to Class 8 buildings — D1.2(b)

The **D1.2(b)(i)** provision regarding an effective height of 25 metres recognises the effective operating height for fire brigade ladders and other fire-fighting and rescue equipment. Above this height, fire-fighting, rescue and egress problems increase considerably.

D1.2(b)(ii) — Class 2 and Class 3 buildings complying with C1.5

C1.5 provides a concession for Class 2 and Class 3 buildings (having a rise in storeys of two), in that if they comply with certain conditions they may be of Type C construction. In order to qualify for that concession such buildings must have at least 2 exits.

This provision recognises that Class 2 and Class 3 buildings constructed in accordance with **C1.5** include additional evacuation provisions.

Basements — D1.2(c)

‘Basement’ is not defined in the BCA. A basement is regarded as a below-ground-level storey not counted in the rise in storeys.

Any basement in excess of the minimum floor area specified in **D1.2(c)(i)** or which has a travel distance to an exit in excess of that specified in **D1.2(c)(ii)**, must have at least two exits. The reason for this is that basements present difficulties in terms of egress and fire-fighting. These include:

- the difficulty in naturally venting smoke from a fire because of the lack of windows; and
- the need for occupants to evacuate in the direction of smoke travel. This is the opposite to upper storeys, where people would be evacuating downwards and the smoke travelling upwards.

Class 9 buildings — D1.2(d)

All Class 9 buildings

D1.2(d)(i) covers Class 9 buildings with a rise in storeys of more than six (additional to the provisions which apply to Class 2 to Class 8 buildings) and Class 9 buildings with an effective height of more than 25 metres (which is the same as for Class 2 to Class 8 buildings, and

recognises the effective operating height for fire brigade ladders and other fire-fighting and rescue equipment).

D1.2(d)(i) recognises the emergency egress requirements for Class 9 buildings. Such buildings could contain large numbers of people who may be unfamiliar with the building’s egress provisions. They might also be confused and in various stages of immobility.

D1.2(d)(i) does not refer to ‘whichever is the lesser’, nor, for that matter, ‘whichever is the greater’ - meaning that both are applicable.

Additional requirements for some Class 9 buildings

In **D1.2(d)(ii)-(vi)**, and **D1.2(e)** and **(f)**, the BCA recognises that some Class 9 buildings (patient care areas, aged care buildings, early childhood centres, schools, spectator stands, storeys or mezzanines containing more than 50 people as calculated under **D1.13**) present difficult evacuation conditions (requiring two exits additional to any horizontal exits) because of such factors as:

- the age and nature of the occupants;
- the density of occupation (for example, occupants per m²); and
- the unfamiliarity of occupants with the emergency evacuation requirements.

Exits must be accessible — **D1.2(g)**

There is little point requiring exits if they are not accessible at all times. **D1.2(g)** requires that occupants must be able to access an exit. Where two or more exits are required, at least two exits (allowing for the fact that one of the exits may be made inaccessible by an emergency, such as a fire) should be accessible.

Such access must not be through another sole-occupancy unit because access to the unit may be locked or barred.

D1.3 When fire-isolated exits are required

Intent

To indicate when fire-isolated stairways and ramps are required to enable safe egress in case of a fire.

D1.3 and **DP5**

D1.3 comprises the **Deemed-to-Satisfy Provisions** for **DP5**.

Purpose of fire-isolated exits

Fire-isolated exits are required in multi-storey buildings to enable people to evacuate past a storey on fire. They also help the fire brigade carry out search and rescue and fire-fighting.

Such exits minimise the distance people need to travel in a fire-affected area before accessing a 'safe place', such as a fire-isolated stairway.

Fire-isolated exits may be:

- fire-isolated stairways;
- fire-isolated ramps; and
- fire-isolated passageways connected to fire-isolated stairways or ramps.

Exceptions

External stairways

Under certain specified conditions, **D1.8** permits the use of external stairways in place of fire-isolated stairways.

PART D1 – PROVISION FOR ESCAPE

Class 2 buildings — D1.3(a)(i)

D1.3(a)(i) permits Class 2 buildings to have non-fire-isolated exits provided they do not connect, pass through or pass by more than three consecutive storeys, plus an extra storey under specified conditions. The terms ‘connect’, ‘pass through’ and ‘pass by’ include the following situations:

- Where the exit provides access to the storey.
- Where the exit passes through the storey but does not necessarily provide access to or egress for the storey.
- Where the exit is external to the building, i.e. passes by the storey but does not necessarily provide access to or egress for the storey.

With regard to the allowance for 3 storeys, the BCA assumes that residents of Class 2 buildings tend to be long-term occupants, and aware of their surroundings. This makes them likely to be able to exit quickly without the need for fire-isolated exits.

An extra storey may be included under certain circumstances where the fire risk associated with the extra storey is low. The circumstances are-

- where the extra storey is used for a carpark or other ancillary purposes. In Class 2 buildings a carpark usually represents a low fire risk, and is unlikely to have many occupants for any length of time. The inclusion of the extra storey applies when the building only consists of a Class 2 building and a carpark. The building may also include a Class 3 part, however in such a case, the Class 3 portion of the building would control the number of storeys connected by a non-fire-isolated exit (see comments on **D1.3(a)(ii)**). If the building contains any other classification, the extra storey cannot be included; and
- where the building contains a sprinkler system. This concession recognises the ability of sprinkler systems to extinguish or contain a fire; and

- where the exit is separated from the extra storey by walls having an FRL consistent with those required for a public corridor in a Class 2 or 3 building. By having separating walls with an FRL and by preventing any connection to the extra storey for the purpose of providing access to or egress for that storey, the non-fire-isolated exit is protected from the fire risk associated with the extra storey.

Class 3 buildings — **D1.3(a)(ii)**

D1.3(a)(ii) permits Class 3 buildings to have non-fire-isolated exits provided they do not connect, pass through or pass by more than two consecutive storeys, plus an extra storey under specified conditions. The terms ‘connect’, ‘pass through’ and ‘pass by’ include the following situations:

- Where the exit provides access to the storey.
- Where the exit passes through the storey but does not necessarily provide access to or egress for the storey.
- Where the exit is external to the building, i.e. passes by the storey but does not necessarily provide access to or egress for the storey.

The allowance for two storeys is based on residents of a number of Class 3 buildings being less familiar with the building layout and paths of travel to an exit than residents of a Class 2 building. The differential between Class 2 and Class 3 buildings recognises a higher potential level of risk in Class 3 buildings.

An extra storey may be included under certain circumstances where the fire risk associated with the extra storey is low. The circumstances are-

- where the extra storey is used for a carpark or other ancillary purposes. In Class 3 buildings a carpark usually represents a low fire risk, and is unlikely to have many occupants for any length of time. The inclusion of the extra storey applies when the building only consists of a Class 3 building and a carpark. The building may also include a Class 2 part, however in such a case, the Class 3 portion of the building would control the number of storeys connected by a non-fire-isolated exit. If the building contains any other classification, the extra storey cannot be included; and
- where the building contains a sprinkler system. This concession recognises the ability of sprinkler systems to extinguish or contain a fire; and
- where the exit is separated from the extra storey by walls having an FRL consistent with those required for a public corridor in a Class 2 or 3 building. By having separating walls with an FRL and by preventing any connection to the extra storey for the purpose of providing access to or egress for that storey, the non-fire-isolated exit is protected from the fire risk associated with the extra storey.

Class 9a health-care buildings — D1.3(b)(i)

Under **D1.3(b)(i)**, required exits in Class 9a health-care buildings need to be fire-isolated if they connect, pass through or pass by more than two consecutive storeys, or the areas they connect, pass through or pass by include one or more patient care areas. The terms ‘connect’, ‘pass through’ and ‘pass by’ include the following situations:

- Where the exit provides access to the storey.
- Where the exit passes through the storey but does not necessarily provide access to or egress for the storey.
- Where the exit is external to the building, i.e. passes by the storey but does not necessarily provide access to or egress for the storey.

Open spectator stands — D1.3(b)(ii)

D1.3(b)(ii) allows an exemption for open spectator stands because of their open nature, which means that the build up of smoke is unlikely.

Class 5-9 buildings containing sprinklers — D1.3(b)(iii)

D1.3(b)(iii) does not apply to—

- a Class 9a building.
- a Class 9c aged care building.
- an open spectator stand.

D1.3(b)(iii) permits other Class 5-9 buildings to have non-fire-isolated exits provided they do not connect, pass through or pass by more than two consecutive storeys, plus an extra storey under specified conditions. The terms ‘connect’, ‘pass through’ and ‘pass by’ include the following situations:

- Where the exit provides access to the storey.
- Where the exit passes through the storey but does not necessarily provide access to or egress for the storey.
- Where the exit is external to the building, i.e. passes by the storey but does not necessarily provide access to or egress for the storey.

An extra storey may be included under certain circumstances where the fire risk associated with the extra storey is low. The circumstances are—

- where the building contains a sprinkler system. This concession recognises the ability of sprinkler systems to extinguish or contain a fire; and
- where the exit is separated from the extra storey by walls having an FRL consistent with those required for a public corridor in a Class 2 or 3 building. By having separating walls with an FRL and by preventing any connection to the extra storey for the purpose of providing access to or egress for that storey, the non-fire-isolated exit is protected from the fire risk associated with the extra storey.

D1.4 Exit travel distances**Intent**

To maximise the safety of occupants by enabling them to be close enough to an exit to safely evacuate.

Travel distances

The **D1.4** travel distances are based on an assumption of what is considered ‘reasonable’ distances to be travelled by occupants in reaching an exit.

Method of measurement

The travel distances specified in **D1.4** are measured in accordance with **D1.15**.

Class 2 and Class 3 buildings and Class 4 parts — D1.4(a) and (b)

D1.4(a)(i)(A) and **(B)** require a shorter travel distance, to a single exit, for Class 2 and Class 3 buildings and Class 4 parts than is required for Class 5 to Class 9 buildings.

The distance occupants of sole-occupancy units in Class 2 and Class 3 buildings and Class 4 parts must travel to leave their unit is not part of the distance specified in **D1.4**. Accordingly, the permitted distance of travel from the point at which the occupant leaves the unit must take account of the time needed for the occupant to reach that point from within the unit.

Distance of travel must factor in the time occupants need to wake up, become alert to their predicament, and exit in a state of confusion.

This process of becoming alert will inevitably require more time to exit. Therefore the distance of travel to an exit should be shorter.

Figure D1.4(1) illustrates various methods of complying with **D1.4** for Class 2 and Class 3 buildings.

Class 5 to Class 9 buildings — D1.4(c)(i)

D1.4(c)(i) sets out the maximum travel distance in Class 5-9 buildings. This includes Class 9c aged care buildings, but excludes Class 9a buildings, which must comply with **D1.4(d)**. (See comments on **D1.4(d)** for the reason Class 9a buildings are treated differently). The additional travel distance allowed in Class 9c buildings recognises the effectiveness of sprinkler systems that must be installed in these buildings.

The distances specified allow people to evacuate in a reasonable time, assuming that they are not asleep.

In case a fire blocks a path of travel, **D1.4(c)(i)** requires that alternative routes must be available within 20 metres of the starting point, unless it is possible to reach a single exit within 20 m.

The conditional reference in **D1.4(c)** to sub-clauses **(d)**, **(e)** and **(f)** refers to special provisions for particular types of building.

Figure D1.4(2) illustrates various methods of complying with **D1.4** for Class 5 and Class 6 buildings.

Class 5 and Class 6 buildings — D1.4(c)(ii)

D1.4(c)(ii) provides a concession for Class 5 and Class 6 buildings with a single exit opening onto a road or open space.

The conditional reference in **D1.4(c)** to sub-clauses **(d)**, **(e)** and **(f)** refers to special provisions for particular types of building.

Patient care areas — D1.4(d)

Patient care areas in Class 9a buildings can present particular problems in case of emergency egress. Such areas are likely to be occupied by people who are either fully or partly non-ambulatory, and in many cases confused or incapacitated by drugs and medical and post-operative conditions.

Accordingly, the allowable distance of travel to an exit in the patient care areas of a Class 9a building is less than for Class 5-8 buildings, non-patient care areas of Class 9a buildings, and Class 9b buildings.

D1.4(d) should be read in conjunction with **C2.5**.

Figure D1.4(1)
DISTANCES TO EXITS IN CLASS 2 AND CLASS 3 BUILDINGS

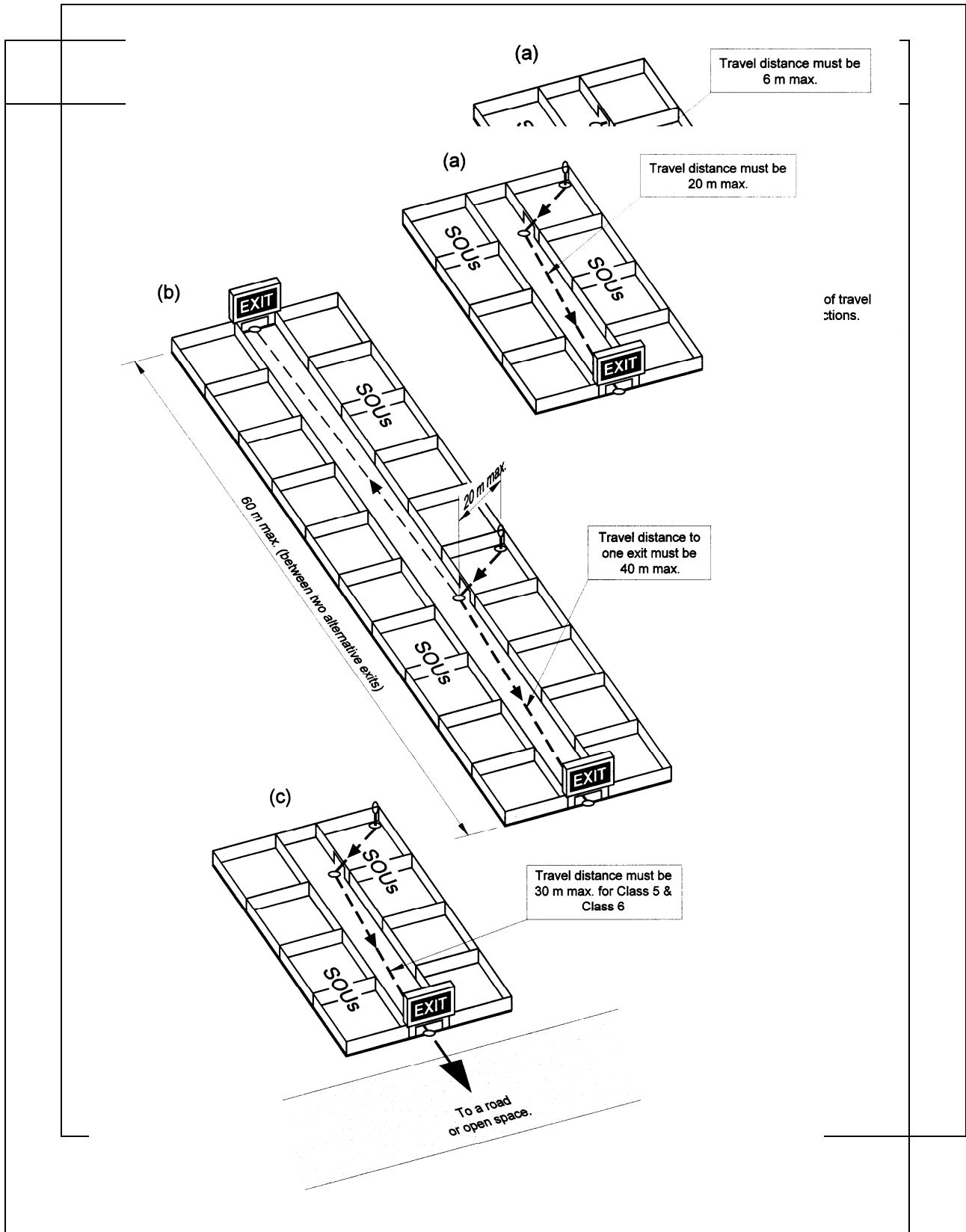

Open spectator stands — D1.4(e)

The construction of an open spectator stand is such that the build up of smoke is unlikely. Greater distances of travel to an exit are therefore permitted.

Assembly buildings — D1.4(f)

The concession available for assembly buildings is based on a specific level of fire and smoke separation being provided between the area being evacuated and the circulation space passed through to reach an exit.

To obtain the concession, **D1.4(f)(iii)** limits the distance of travel through the room being evacuated and across the circulation space outside that room to the exit.

D1.5 Distance between alternative exits**Intent**

To require that if an exit is inaccessible, access to any required alternative exit must be available within a reasonable distance.

Why is this matter regulated?

Where a building requires multiple exits, the exits maximise the choices of a person evacuating, in case one exit becomes blocked.

Uniform distribution of exits — D1.5(a)

D1.5(a) requires that where multiple exits exist, they must be distributed as uniformly as practicable to improve the level of safety when evacuating.

Minimum and maximum distances are set

D1.5 specifies the minimum and maximum permitted distances between alternative exits (for example, two exits may be located next to one another, so long as they are not each other's alternative in an emergency). Where scissor stairs are used, the shafts will be adjacent and separated by fire-resisting construction. However, the access doors to the alternative scissor stairs must comply with the minimum separation distance.

Minimum distance — D1.5(b)

The minimum distance minimises the risk of fire spreading to block the alternative exit.

Maximum distance — D1.5(c)

The maximum distance between alternative exits minimises the need to travel too far to reach an exit.

Convergence distance — D1.5(d)

If alternative paths of travel converge too closely, both paths can be blocked by the same fire. The minimum distance between the paths of travel aims to negate this.

The minimum convergence distance only comes into operation when the paths of travel have already diverged to that distance. The paths can commence more closely together than the distance specified.

Method of measurement

The travel distances specified in **D1.5** are measured in accordance with **D1.5**.

Figure D1.5(1) illustrates the method of measuring the maximum and minimum distances between exits.

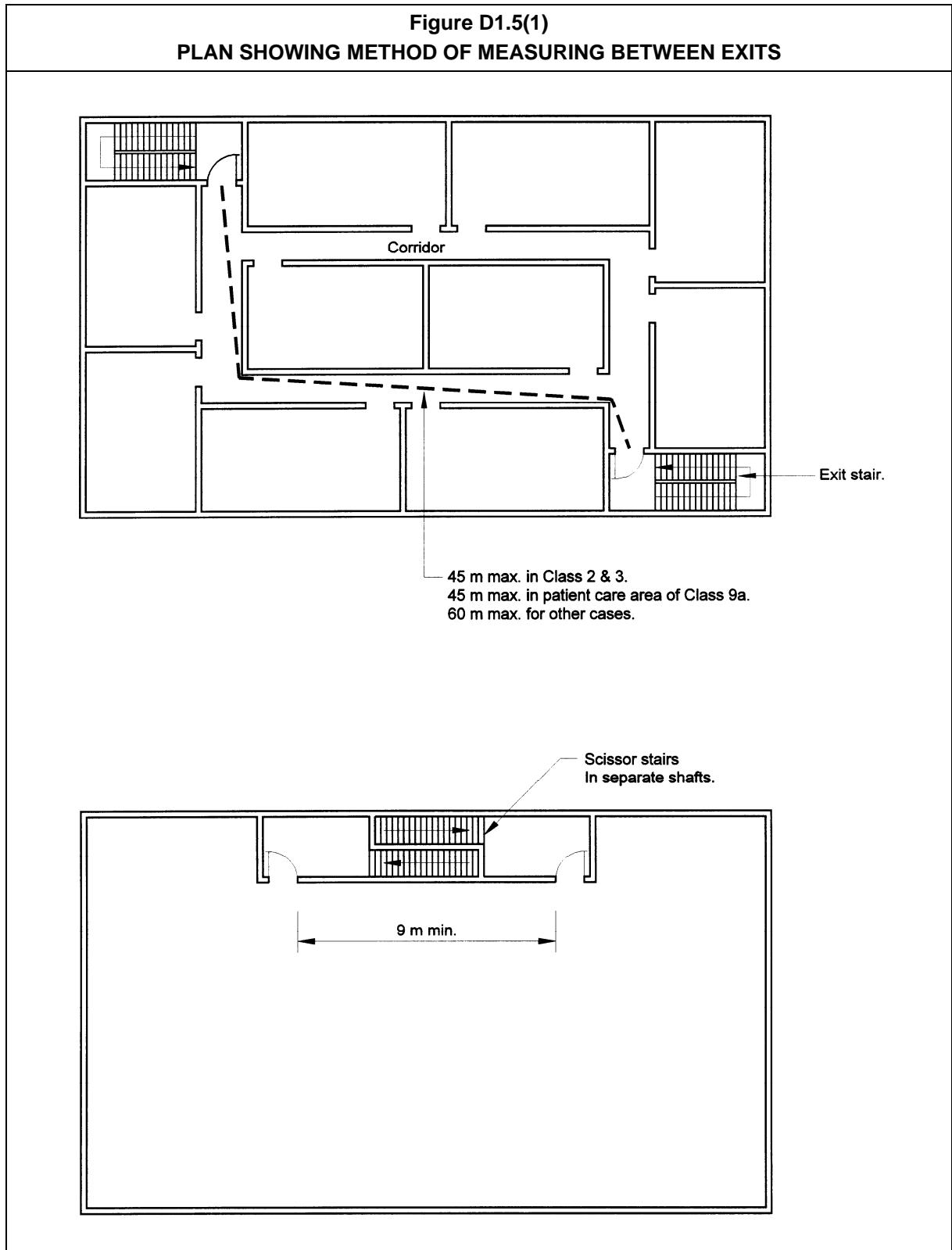
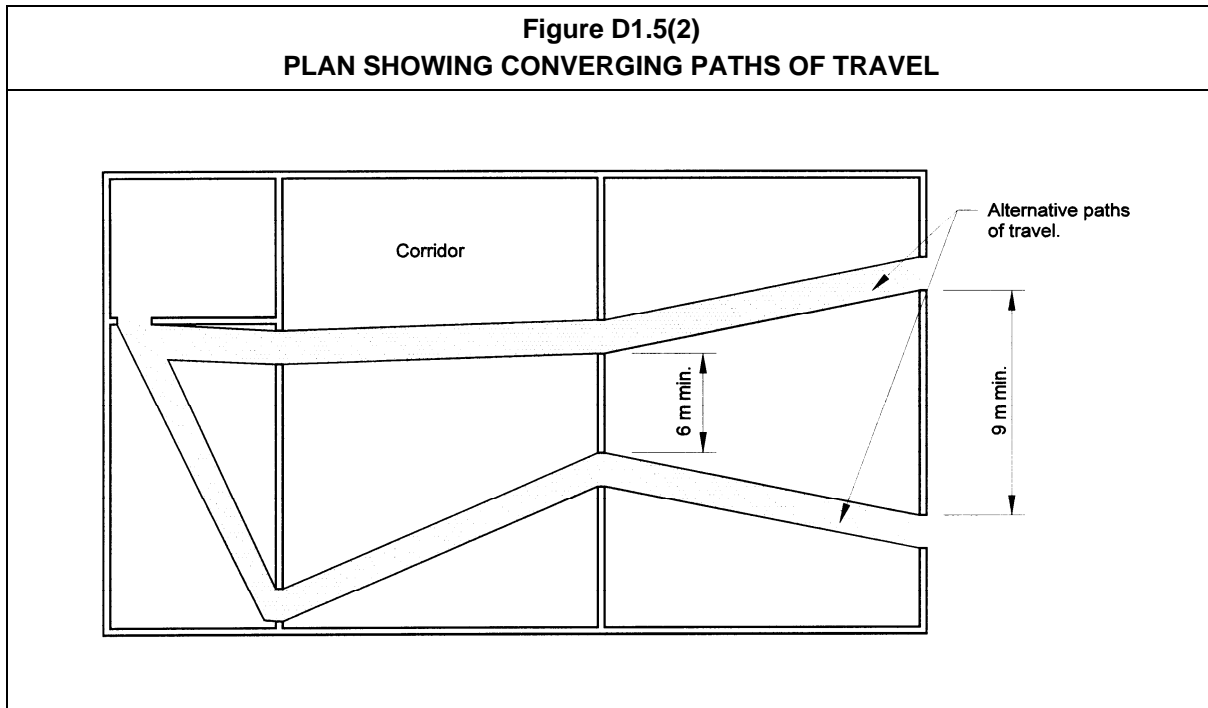

Figure D1.5(2) illustrates the convergence prohibition on alternative paths of travel.



D1.6 Dimensions of exits and paths of travel to exits

Intent

To require exits and paths of travel to an exit to have dimensions to allow all occupants to evacuate within a reasonable time.

Height of exits and paths of travel — D1.6(a)

The D1.6(a) requirement for a minimum height of two metres is considered to be a reasonable minimum for most people to safely walk through to gain egress.

The reduction to a minimum of 1980 mm for doorways is to allow for a standard door frame.

Exit and path of travel widths

Width required to allow safe exit

The required exit and path of travel widths have been determined on the basis of an estimate of the width required to allow the safe exit of a given number of people expected in particular buildings.

Minimum unobstructed width**Exit and path of travel width — D1.6(b)**

D1.6(b) clarifies that the unobstructed width of any exit or path of travel to an exit is to not be less than the dimensions prescribed. These may then be added to achieve the aggregate width that is required.

D1.6(b)(iii) applies to Class 9c aged care buildings. The additional width at doorways is to allow for greater manoeuvrability of beds, mobile baths, wheelchairs, walking frames and other equipment throughout the resident use areas.

Figure D1.6(1) illustrates two examples of how compliance with the corridor width provisions in a Class 9c aged care building may be achieved.

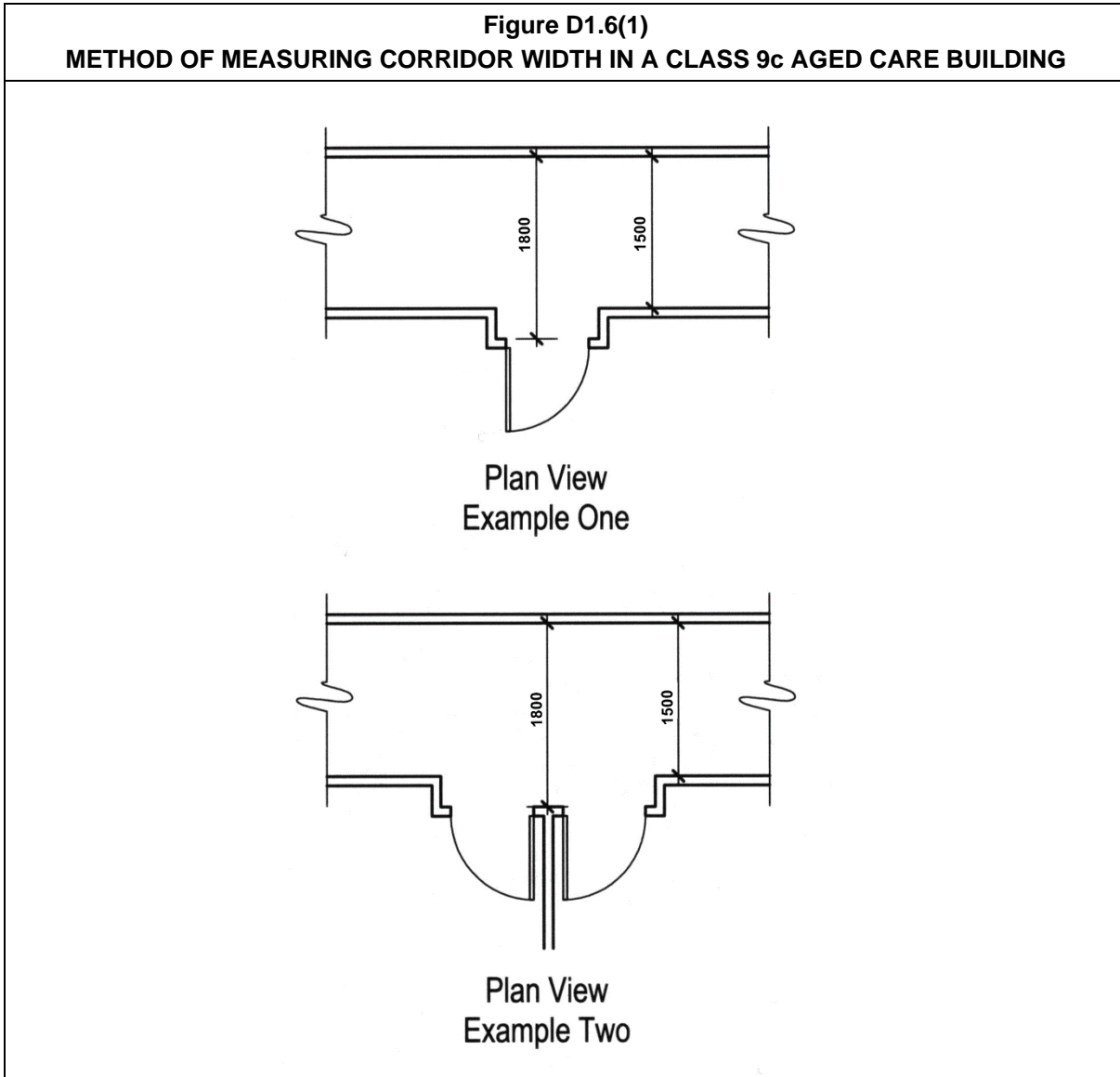

Storeys accommodating up to 200 people — **D1.6(c)**

Buildings, other than ward and treatment areas of a Class 9a building, accommodating up to 200 people (see **D1.6(b)** and **(c)**) require minimum widths of:

- 1 metre for 0 to 100 people;
- 1.25 metres for 101 to 125 people;
- 1.5 metres for 126 to 150 people;
- 1.75 metres for 151 to 175 people; and
- 2 metres for 176 to 200 people.

Storeys accommodating more than 200 people — **D1.6(d)**

PART D1 – PROVISION FOR ESCAPE

Above 200 people (see **D1.6(d)**), there is a division between those buildings which have a change of floor level by way of stairways or ramps with a gradient greater than 1 in 12, and those which do not have such a change in floor level. The reason for this differentiation is that the change in floor level has the potential to create problems at exits, which could cause injuries and delays. The difference can be outlined as follows, and is illustrated in Figure **D1.6(2)**:

- Change in floor level by stairway or ramp greater than 1:12 — **D1.6(d)(i)**
 - 2.5 metres for 201 to 260 people;
 - 3 metres for 261 to 320 people;
 - 3.5 metres for 321 to 380 people;
 - and so on.
- Every other case — **D1.6(d)(ii)**
 - 2.5 metres for 201 to 275 people;
 - 3 metres for 276 to 350 people;
 - 3.5 metres for 351 to 425 people;
 - and so on.

Aggregate width of exit or path of travel — **D1.6(c), (d) and (e)**

D1.6(c), (d) and (e) refer to the required width of an exit or path of travel to an exit in terms of an ‘aggregate unobstructed width’. The exit or path may be less than the total required width (although each must achieve the minimum required width), but when the width of each exit or path is added together, the specified aggregate unobstructed width must be achieved.

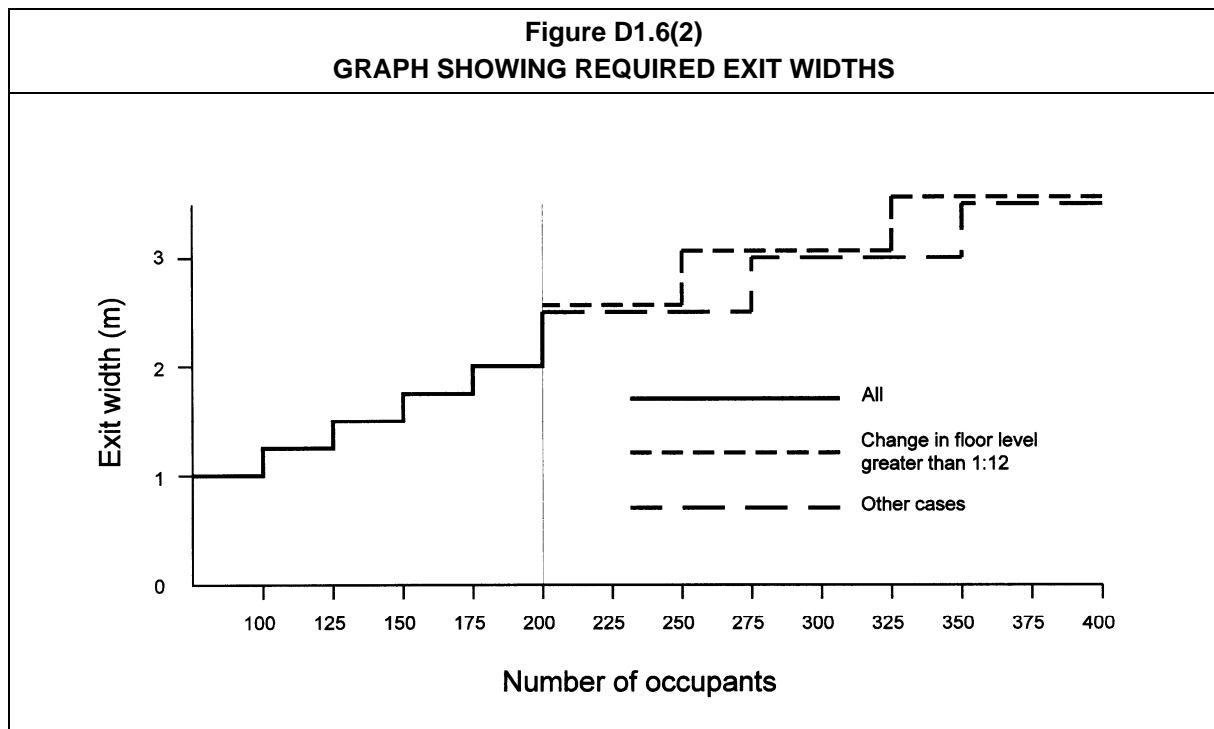

Doorway widths — **D1.6(f)**

The width of a doorway must be clear of all obstructions. This includes door handles or other attachments or any part of the door leaf and any part of the door frame, including the door stop.

Patient care areas — D1.6(f)(i) and (ii)

D1.6(f)(i) and (ii) provide additional width for doorways in patient care areas to allow for the turning circle of beds, and other egress difficulties, such as those experienced by patients who require ambulatory assistance.

Width of a doorway — D1.6(f)(iii)

The width of a doorway comprising part of the exit or path of travel is permitted to be 250 mm less than the width of each exit. This allows for the installation of a standard door frame.

In the case of an exit comprising multiple doorways, this concession may be applied to each individual doorway.

Figure D1.6(3) shows alternative examples of the exit door width for a building requiring a total exit width of three metres.

Aged care buildings — D1.6(f)(iv)

D1.6(f)(iv) applies to Class 9c aged care buildings. The additional width of doorways is to allow for greater manoeuvrability of beds, mobile baths, wheelchairs, walking frames and other equipment throughout resident use areas.

Minimum permitted width of a doorway — D1.6(f)(v)

No doorway should be less than 750 mm in width, except doorways which open into toilets and bathrooms. However, minimum width requirements do apply to doorways which provide access to facilities required for people with disabilities (see **D3.2** and **F2.4**).

Exceptions to the exit and path of travel width

Treatment areas, ward areas — D1.6(b)(ii) and (c)(ii)

D1.6(b)(ii) and (c)(ii) specify additional width requirements for the exit and path of travel to allow for the turning circle of beds.

Open spectator stand — D1.6(e)

D1.6(e) provides an exception for large open spectator stands to the exit and path of travel width required for other buildings.

Figure D1.6(3)
PLAN SHOWING EXAMPLES OF
EXIT WIDTHS FOR A BUILDING REQUIRING AN EXIT WIDTH OF 3m

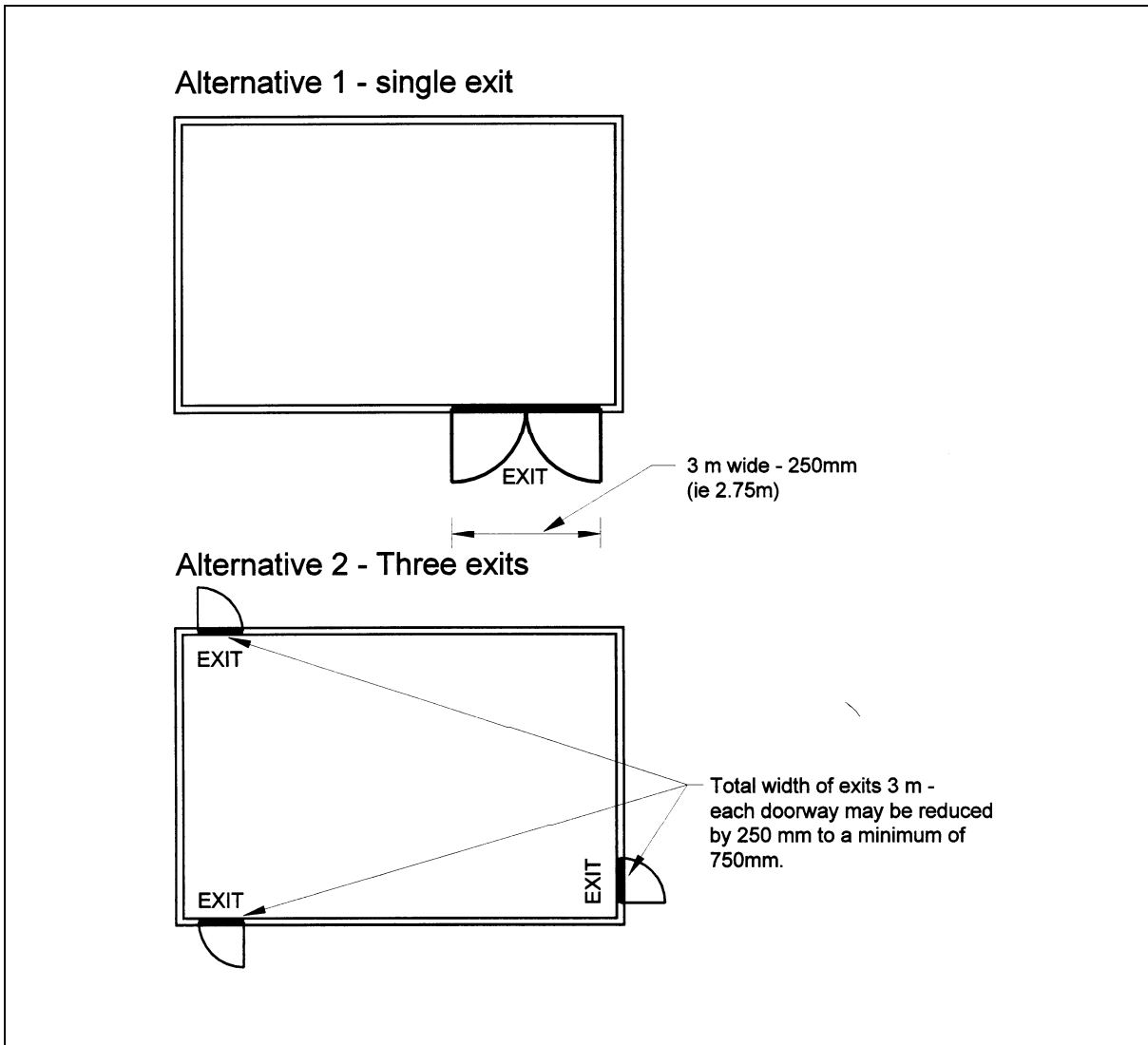

Exit or path of travel width must not be reduced — D1.6(g)

Under **D1.6(g)**, the required unobstructed width of exit or path of travel must not be reduced in the direction of egress. This provision aims to avoid congestion in an exit or a path of travel to an exit.

Example

A restaurant is located on the fifth floor of a building.

The restaurant may seat 250 people. This would require an aggregate exit width of 2.5 metres. One stairway, 2.5 metres in width, is provided to achieve the exit requirement.

The fourth floor of the same building may be used as an office, with 100 staff, requiring an aggregate exit width of only 1 metre.

The 2.5 metre wide stairway from the fifth floor cannot be reduced to 1 metre when it reaches the fourth floor. The stairway must retain its 2.5 metre width throughout its length.

The exit width is not required to increase to 3.5 metres below the 4th floor. The BCA makes the assumption that the occupants of both floors are unlikely to all be exiting through the same part of the stairway at the same time.

If the restaurant was below the office, the stairway could begin at 1 metre in width at the office, but would have to increase to 2.5 metres after it passed the restaurant.

D1.7 Travel via fire-isolated exits**Intent**

To enable occupants to safely enter a fire-isolated exit which discharges to a safe location.

Access to fire-isolated exits — D1.7(a)

D1.7(a) requires that a doorway must not open into a fire-isolated exit unless it opens from a public area, a sole-occupancy unit which occupies a whole floor, or a toilet. This is to limit the number of entry points into a fire-isolated exit to retain its fire-resisting performance.

Note that **D1.7(a)(i)** refers to a 'public corridor, public lobby, or the like'. A smoke lobby which serves at least two sole-occupancy units is a 'public lobby', and can open directly into a fire-isolated exit. **Figure D1.7(1)** illustrates permitted and prohibited entry into a fire-isolated passageway from sole-occupancy units in a shopping centre.

Discharge to areas not roads and open spaces — D1.7(b)

D1.7(b)(i) requires fire-isolated exits to discharge to roads or open spaces. However, there are some exemptions:

- **D1.7(b)(ii)** sets out the requirements for a fire-isolated exit to discharge into an area within a building (including the requirement that it be open for at least two thirds of its perimeter, to aid smoke ventilation); and
- **D1.7(b)(iii)** sets out the requirements for a fire-isolated exit to discharge into a covered area outside the building (including the requirement that it be open for at least one third of its perimeter, to aid smoke ventilation).

Figure D1.7(1)
PLANS SHOWING ENTRY INTO A FIRE-ISOLATED PASSAGEWAY IN A SHOPPING CENTRE

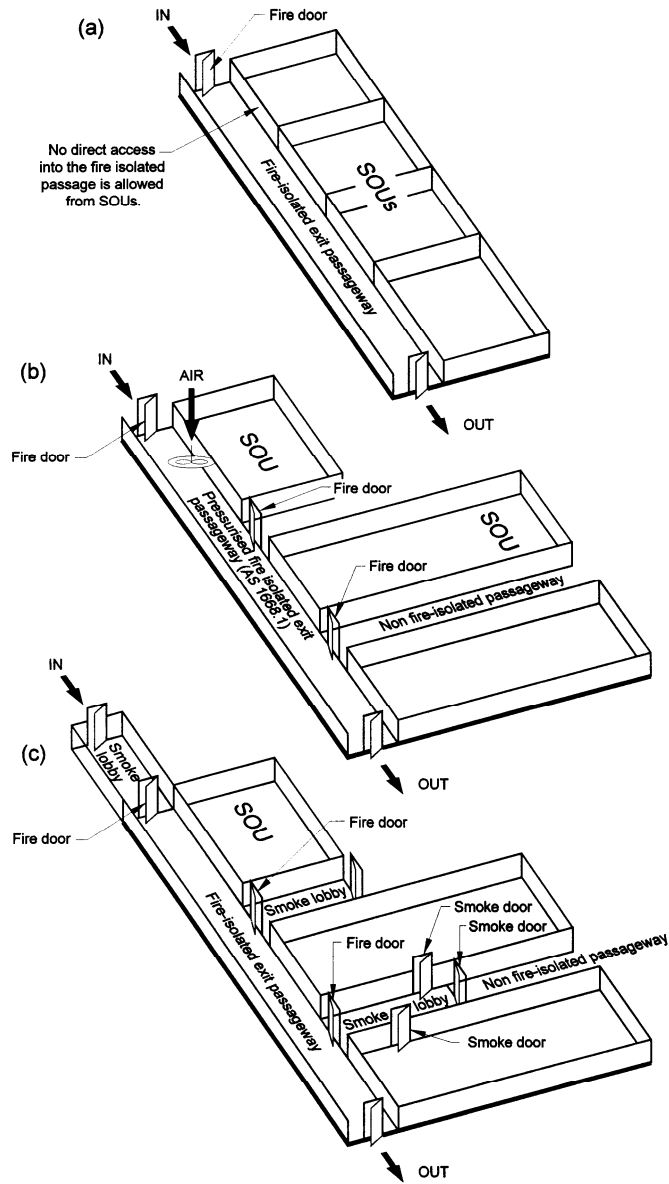

Figures D1.7(2) and (3) illustrate some of the options available by the use of D1.7.

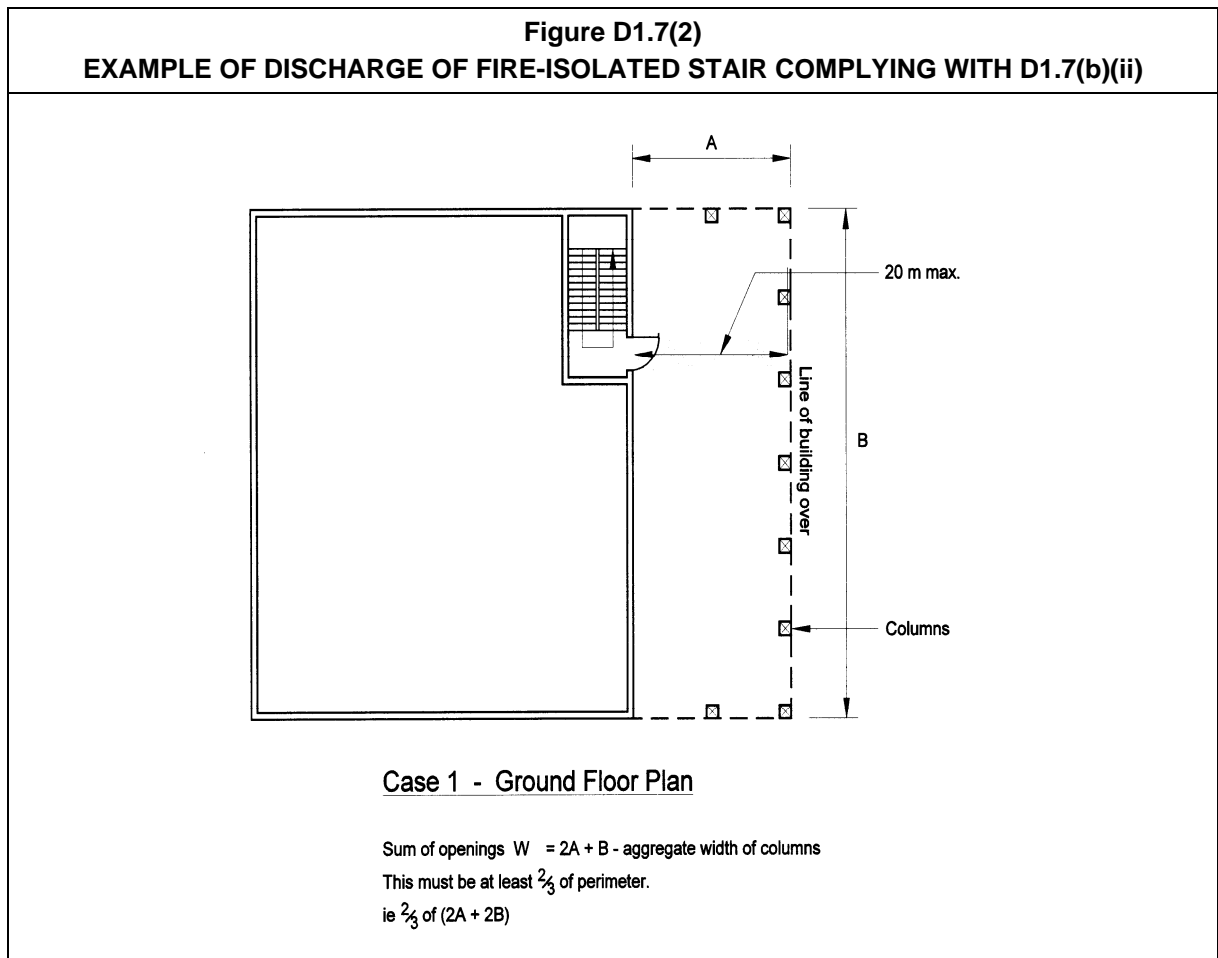

Travel within 6 metres of an external wall — D1.7(c)

D1.7(c) sets out the FRL and opening protection requirements where the path of travel to a road or open space from the point of discharge from the building passes within six metres of any part of the external wall of the building being evacuated.

Figure D1.7(4) illustrates when walls and window openings require protection in accordance with D1.7(c).

Smoke lobby or pressurised system — D1.7(d)

D1.7(d) requires the use of a smoke lobby or a pressurisation system to stop the entry of smoke into the fire-isolated exit, if more than two access doorways described in D1.7(a)(i) or (ii) are provided in the same storey. This provision must be read in conjunction with D1.7(a), it does not over-ride it.

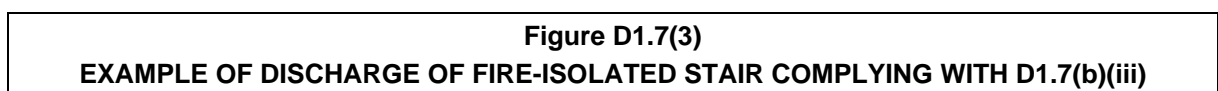

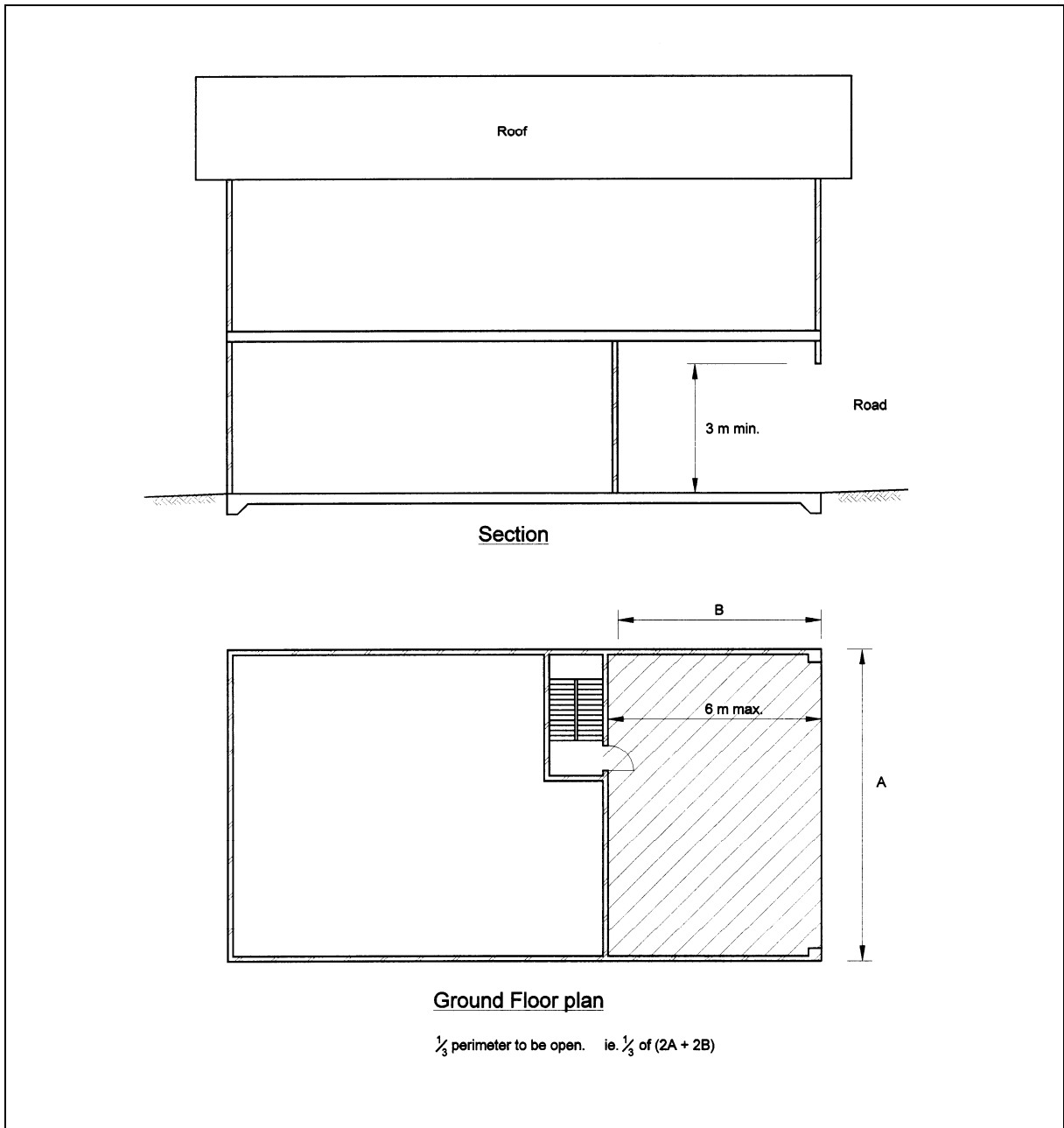

Ramps in Class 9 buildings — D1.7(e)

D1.7(e) requires a ramp where there is any change in level in a fire-isolated passageway in a Class 9 building and that change is less than 600 mm.

Figure D1.7(4)
PLAN SHOWING WHEN WALLS AND WINDOWS REQUIRE PROTECTION IN ACCORDANCE WITH D1.7(c)

Case 3 - Protection of wall and openings.

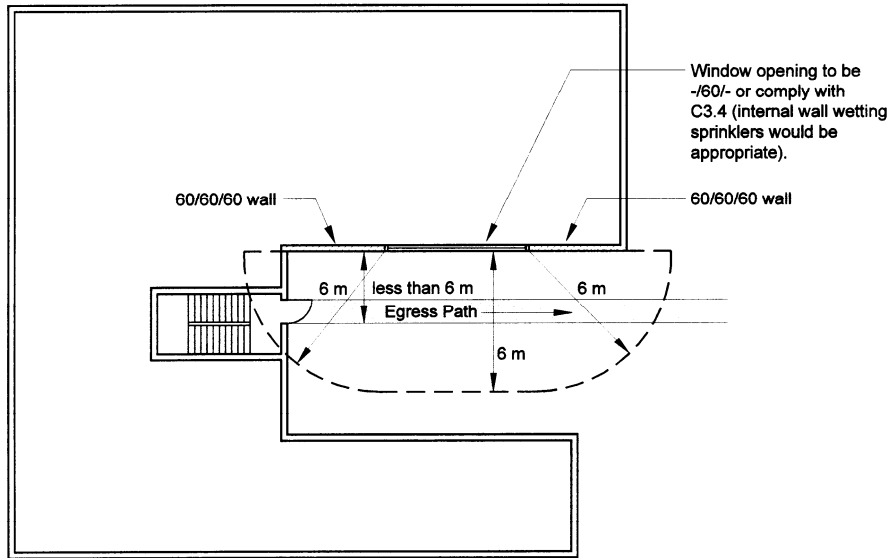

D1.8 External stairways or ramps in lieu of fire-isolated exits

Intent

To detail the circumstances in which an external stairway or ramp can be provided instead of a fire-isolated stairway or fire-isolated ramp.

Alternative to required fire-isolated stairways or ramps

Compliance with **D1.8** for external stairway or ramp is only required where the external stairway or ramp is proposed as an alternative to a required fire-isolated stairway or ramp. In other words, if a fire-isolated stairway or ramp is not required by the BCA, compliance is not required with **D1.8**.

External stairways and ramps permitted to 25 metres

The use of an external stairway or ramp is permitted instead of a fire-isolated stairway or ramp up to a height of 25 metres. The reason external stairways or ramps are not permitted above this height is because of:

- the risk that people would suffer vertigo above this level;
- the risk that weather conditions, particularly wind, may become more severe above this height; and
- the need to enable any person who gets into difficulties on the stairway to be rescued by way of fire brigade ladders or other rescue equipment, which generally do not reach above this height.

Fire protection required

Fire protection from the external wall of the building near the external exit and any openings in that wall, is required under **D1.8(a)** and **(b)** to ensure that an average person using the exit is afforded adequate protection from flames and radiant heat from a fire within the building.

D1.8(c) provides two separate methods of protecting the external exit from a fire from within the building:

- protect the external wall of the building and any openings in the wall, within the prescribed distances to the exit (see **Figure D1.8(1)**); or
- protect the exit by shielding construction where the exit is within the prescribed distances to the building (see **Figure D1.8(2)**).

Figure D1.8(1)

PROTECTION OF THE EXTERNAL EXIT USING THE EXTERNAL WALL OF THE BUILDING IN ACCORDANCE WITH D1.8(c)(i)

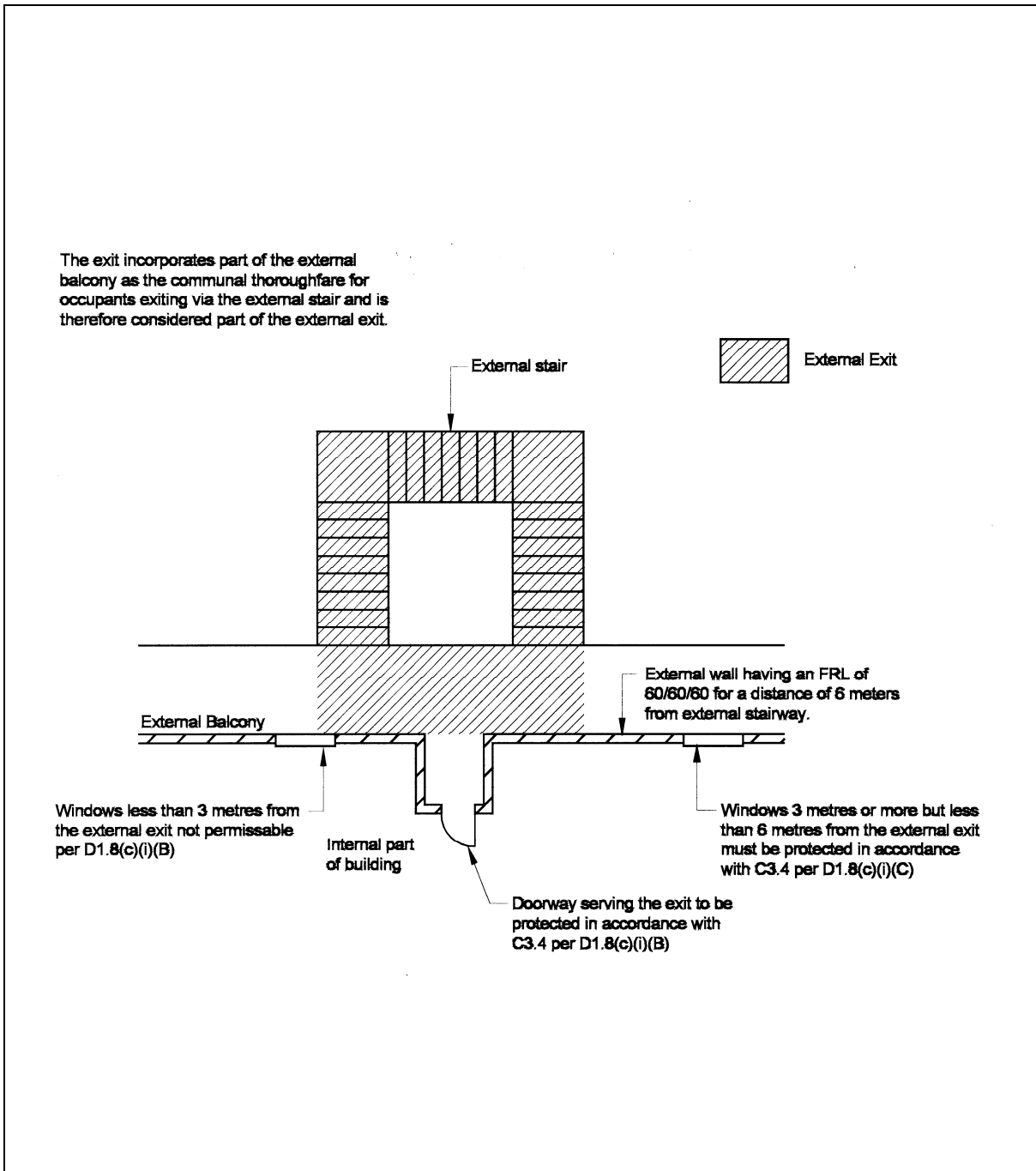

D1.8(d) provides requirements for the shielding construction and protection of any openings in that construction.

Figure D1.8(2)
PROTECTION OF THE EXTERNAL EXIT USING SHIELDING CONSTRUCTION IN ACCORDANCE WITH D1.8(c)(ii)

The external exit is considered to be any part of the stair that would be used by any occupant travelling down the stair.
The perpendicular extension from the main balcony would be only used by the occupants of that level and is no different to the requirements of main external balcony.

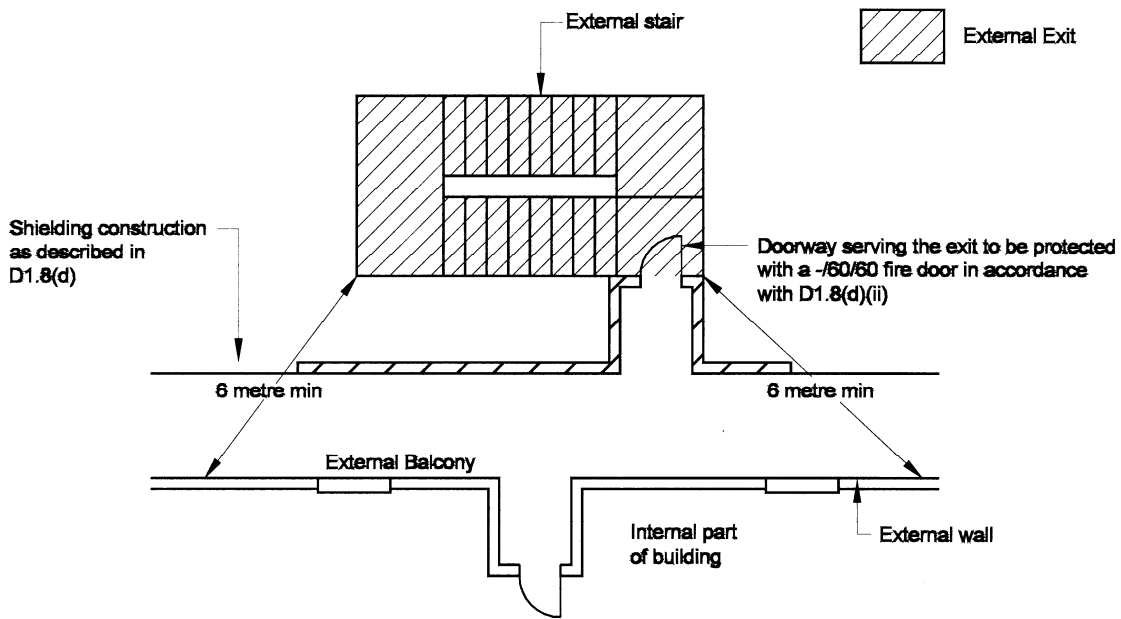

D1.9 Travel by non-fire-isolated stairways or ramps

D1.8

Intent

To require that a person using a non-fire-isolated stairway or ramp be provided with a safe evacuation path.

Continuous means of travel — D1.9(a)

D1.9(a) requires that occupants in a required non-fire-isolated stairway or ramp are able to continue all the way down to the level from which egress to a road or open space is available.

D1.9(a) refers to a continuous means of travel comprising flights of stairs and landings. It would generally not be acceptable for an entire or substantial proportion of a storey to be called a 'landing'.

The first diagram in **Figure D1.9(1)** illustrates non-compliance with **D1.9(a)** because the stair does not provide a continuous path of travel to the level providing egress to a road or open space. The second diagram in **Figure D1.9(1)** illustrates a method of compliance with **D1.9(a)**.

Required stairways and ramps

The distances specified in **D1.9** apply only to a required non-fire-isolated stairway or ramp.

Figure D1.9(2) illustrates the method of measuring a travel distance down a stairway.

Distances for non-fire-isolated stairways — D1.9(b) and (c)

D1.9(b) and **(c)** provide requirements for the overall travel distances permitted on non-fire-isolated stairways. **Figure D1.9(3)** illustrates compliance with **D1.9(b)** and **(c)**.

Distance from stairway to discharge point — D1.9(d) and (e)

D1.9(d) and **(e)** provide requirements for the travel distance permitted from the base of the non-fire-isolated stairway to the discharge point (note that this distance is part of the distances required under **D1.9(b)** and **(c)**). **Figure D1.9(4)** illustrates compliance with **D1.9(d)** and **(e)**.

Class 2 or Class 3 requiring 2 or more exits — D1.9(f)

D1.9(f) provides the additional requirements for Class 2 and Class 3 buildings which are required to have 2 or more exits.

Figure D1.9(5)

Figure D1.9(5) illustrates one method of an exit system in a Class 5-9 building complying with **Section D**.

Figure D1.9(1)
SECTION SHOWING COMPLIANCE WITH D1.9(a)

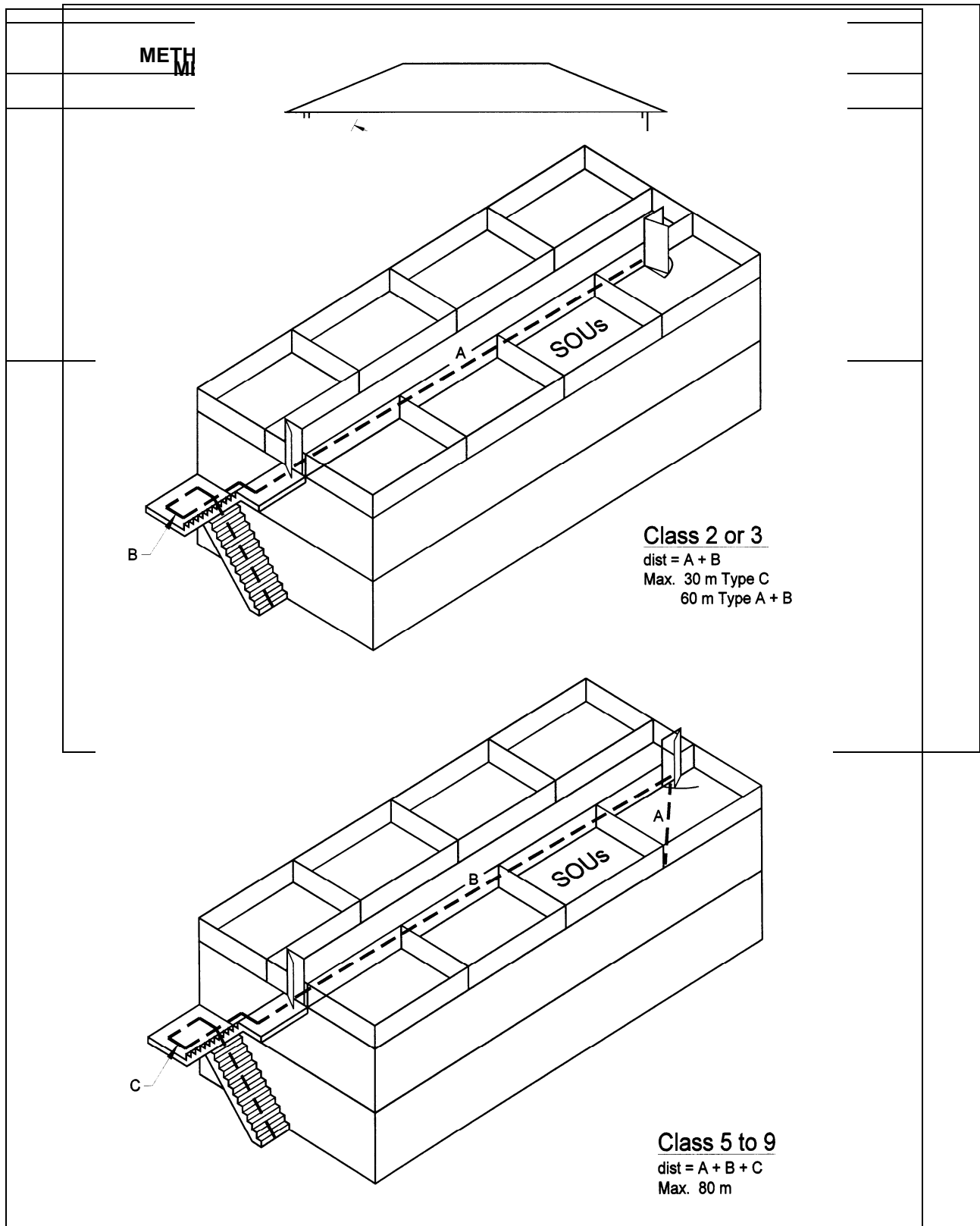

Figure D1.9(4)
PLANS SHOWING COMPLIANCE WITH D1.9(d) AND (e)
FOR THE DISCHARGE OF NON-FIRE-ISOLATED STAIRWAYS

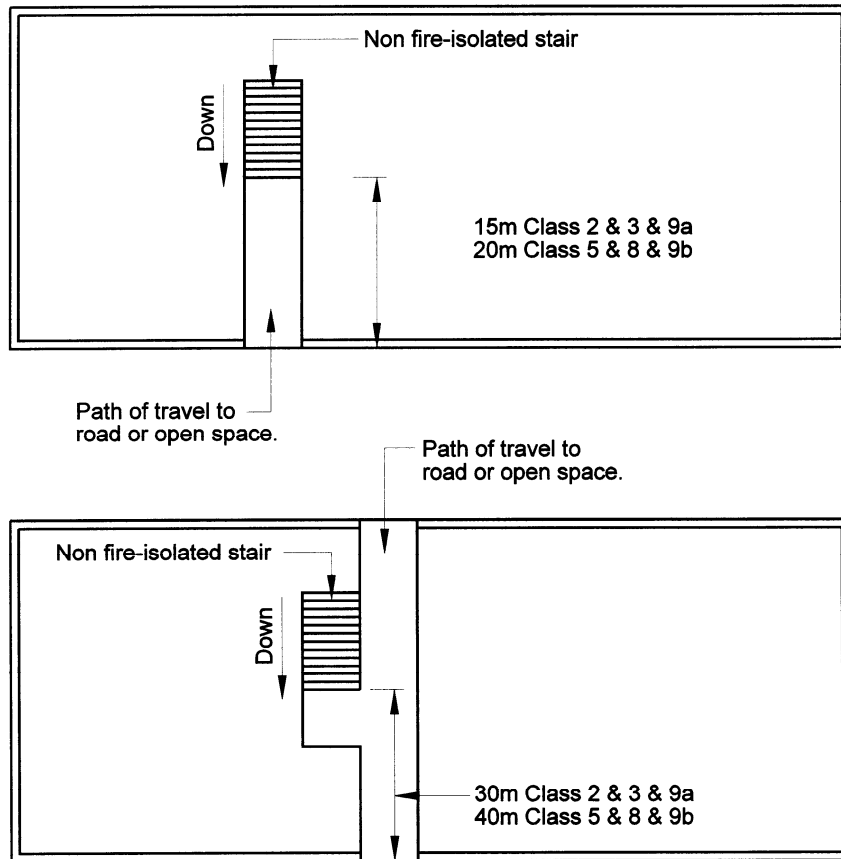
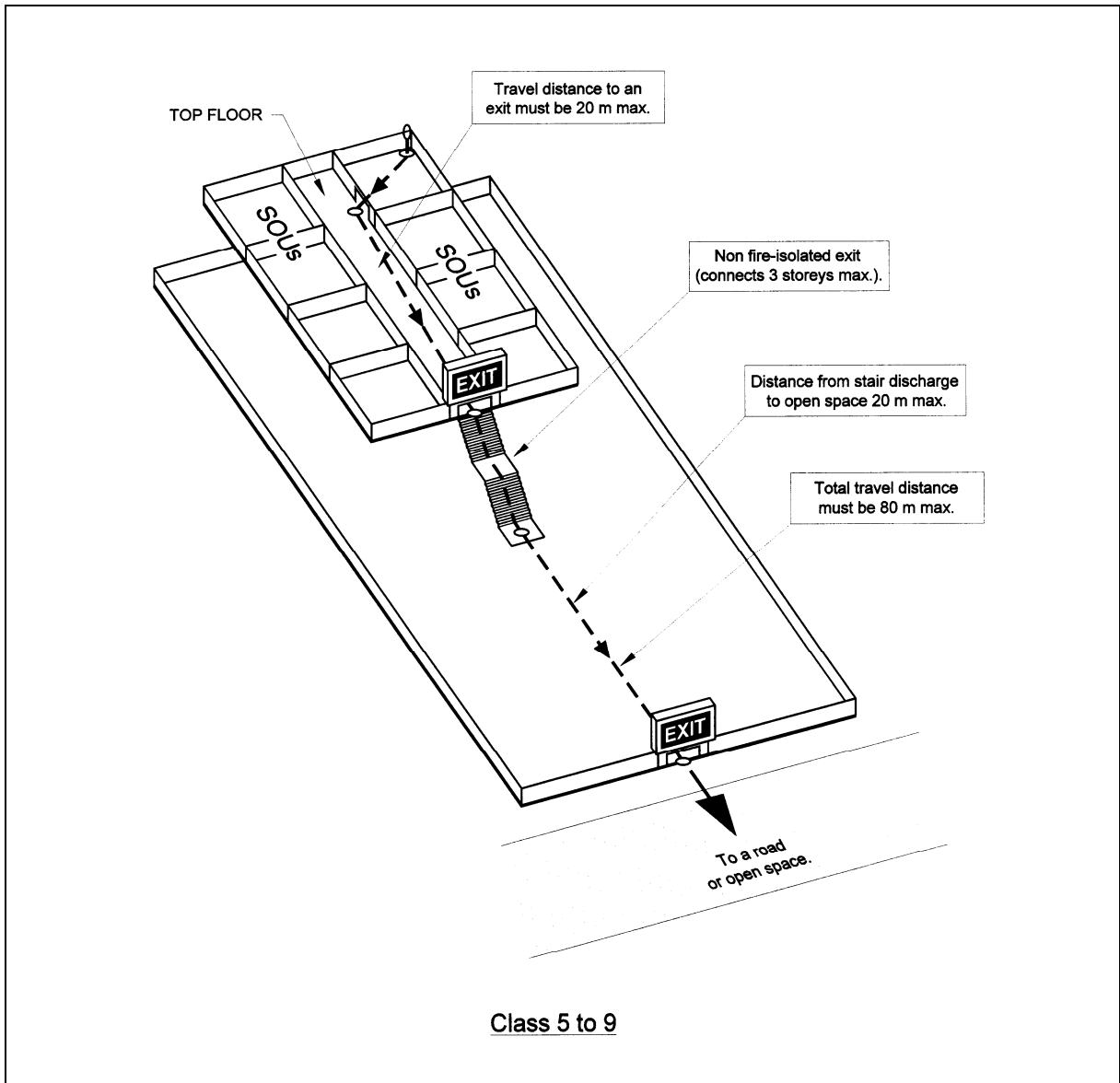

Figure D1.9(5)
ONE METHOD OF COMPLIANCE WITH SECTION D



D1.10 Discharge from exits

Intent

To require the safe discharge from an exit to a road or open space.

Egress not to be blocked — D1.10(a)

D1.10(a) requires that an exit must not be blocked at the point of discharge.

Barriers (such as bollards) must be installed, if they are necessary to prevent vehicles blocking access to, or discharge from, an exit.

Link between open space and a road — D1.10(b) and (c)

If an exit discharges to an open space, **D1.10(b)** and **(c)** require that a safe means of travel be provided from the open space to a road. This means that the following criteria must be satisfied:

- **D1.10(b)** — to maximise the safety of people moving towards a road during an evacuation, the width of the path of travel from the open space to the road must be at least that required for the exit (and in no case less than one metre).
- **D1.10(c)** — to minimise the risk from falling or tripping, any stairways or ramps must comply with the rest of the BCA (eg. construction of treads, landings etc.). This may include the provision of ramps suitable for people with disabilities.

The link between the road and open space must be open to the sky for its length.

Discharge points to be well separated — D1.10(d)

D1.10(d) requires that the discharge points of alternative exits be as far apart as possible, so that if the discharge from one of them is blocked, the other will still operate satisfactorily.

Open spectator stand — D1.10(e)

D1.10(e) requires that exits from an open spectator stand not discharge to the ground in front of the stand. There may be a large number of people viewing the event from the front of the stand, and they may obstruct the path of those evacuating.

There is also a risk that the front of the stand could be subject to severe heat radiation. Also the only egress to the road from the ground in front of the stand may be through the stand.

Auditorium — D1.10(f)

Under **D1.10(f)**, only two thirds of the required width of exits from an auditorium, such as a theatre or hall, are to discharge into an entrance foyer where the auditorium can accommodate more than 500 people. This restriction applies because there may be a large number of people

in the foyer, possibly waiting for the next show, or to gain access to another auditorium. These people would obstruct the path of the people evacuating.

D1.11 Horizontal exits

Intent

To detail how the installation of horizontal exits in a building is permitted as an alternative to a conventional exit.

Difficult evacuations

Originally, provision was made for horizontal exits between fire compartments because some occupants can have difficulty evacuating, particularly those confined to bed or have a disability. Subsequently, it was accepted that horizontal exits would be of value in other buildings, where they could overcome problems associated with large fire compartments, eg. excessive distances to travel to exits.

Purpose of horizontal exits

The use of horizontal exits can overcome some of the difficulties outlined above, although they need to be used in conjunction with some other form of exit.

In an emergency, the **Deemed-to-Satisfy Provisions** require that occupants travel for limited distances before they reach a place of safety. A ‘place of safety’, in the case of horizontal exits, means the connecting fire compartment to which people will flee.

For a horizontal exit to comply with the **Deemed-to-Satisfy Provisions** of **Section D**, it must meet the following criteria:

- The distance of travel to the exit must not exceed that specified elsewhere in the BCA.
- The protection for a place of safety from its adjoining fire compartment is provided by a fire wall. The fire wall has a fire rating to match the classification of the fire compartments it divides and is expected to withstand a burnout of the respective areas. This provides an appropriate level of safety to people using the horizontal exit as they may have to remain in the place of safety for an extended period before evacuating via other exits.
- There must be another exit (other than a horizontal exit) from each place of safety entered by way of a horizontal exit. After escaping to the place of safety it should not be necessary to return to the area being evacuated to continue to evacuate from the building. **D1.11(c)** specifies a limit for the number of horizontal exits in a storey for buildings of other than Class 9a and 9c buildings.
- The place of safety must be large enough to temporarily accommodate the people from

the area the horizontal exit is being provided for. It is important to note that if there is only one other exit in the fire compartment then the place of safety is to be large enough to accommodate all the occupants of the fire compartment. This is necessary because if the other exit is blocked then all the occupants will be required to exit through the horizontal exit. This is necessary until vertical evacuation is available. Since this accommodation is only for a short period, the areas specified generally only allow for people to stand. However, the larger areas specified for Class 9a health-care buildings

and Class 9c aged care buildings allows for patients or residents on beds to be wheeled through the horizontal exit to be accommodated in the place of safety.

- The path to the place of safety is to have dimensions equal to those of the horizontal exit to assist with the smooth evacuation of occupants.
- The swing of the horizontal exit door must be the same as other exit doors. This means that if the area is more than 200 m² (as specified in **D2.20(b)**), the door is to swing in the direction of egress. If the FRL of the fire wall is three or four hours, two fire doors may be provided to achieve this FRL. In such cases, for both doors to swing in the one direction, a vestibule must be formed, as shown in **Figure D1.11**.
- To make sure that evacuation is always possible, it is not permitted to have a horizontal exit to a separate sole-occupancy unit. This is because the owner or occupier of the other unit may lock the door for security reasons, barring entry (or exit) in an emergency.
- Where egress is required in either direction, two doors swinging in opposite directions or a 180° swinging door (complying with all BCA requirements including fire and smoke sealing capacities) may be used.

Other uses of horizontal exits

Horizontal exits may be useful as a means of evacuation from many health-care buildings. They can also be an advantage in large floor area buildings which need to be sub-divided by fire walls to reduce the size of the fire compartments. These fire walls can then be penetrated to create horizontal exits.

Figure D1.11
PLAN SHOWING DOORS FORMING A HORIZONTAL EXIT IN A FIRE WALL IN ACCORDANCE
WITH D1.11

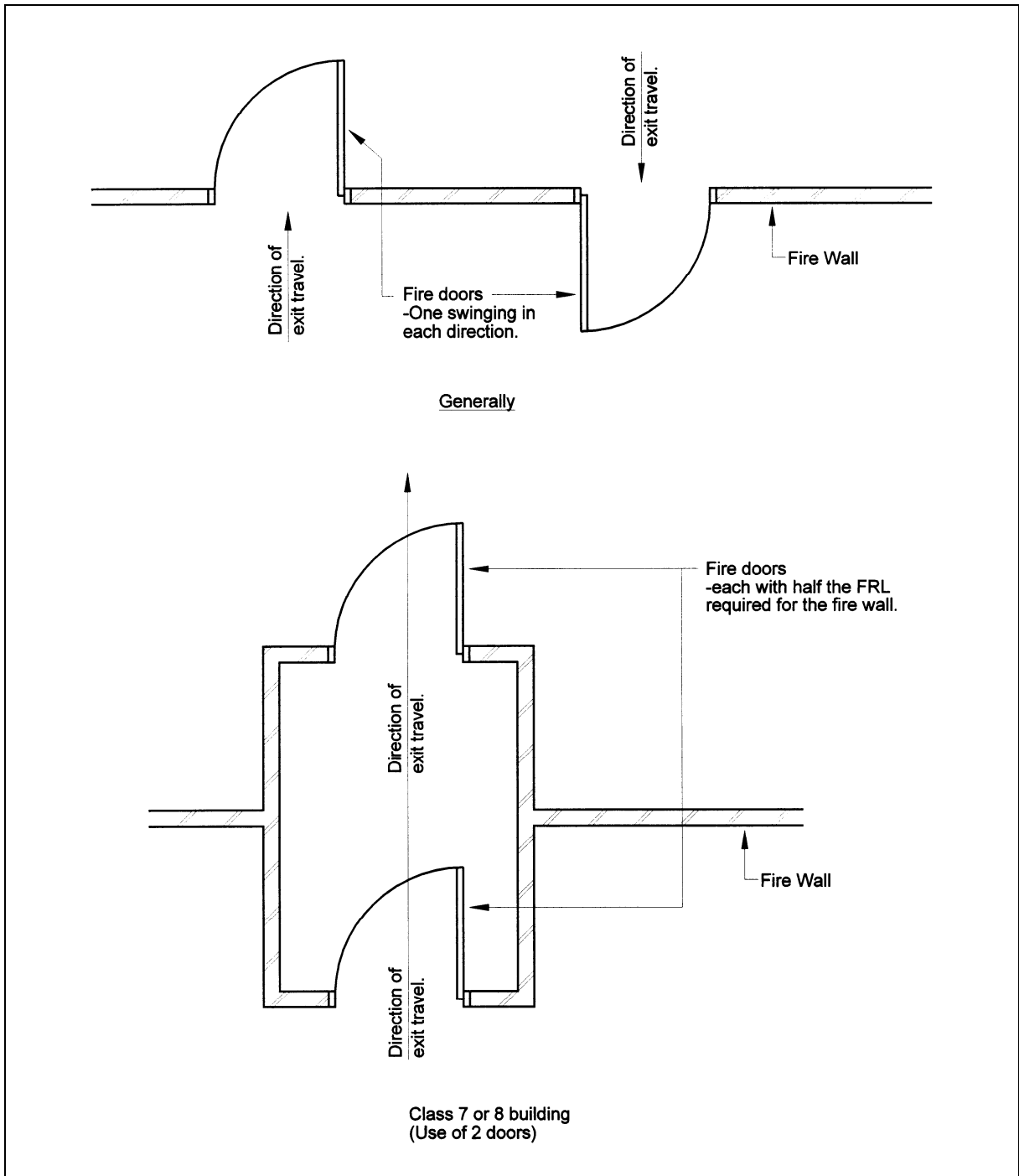

D1.12 Non-required stairways, ramps or escalators

Intent

To limit the spread of fire and smoke through unprotected openings for stairways, ramps, escalators and moving walkways.

Application

D1.12 only applies to:

- escalators;
- moving walkways and travelators;
- non-required non-fire-isolated stairways; and
- non-required non-fire-isolated ramps.

What is a non-required non-fire-isolated stairway or ramp?

Builders etc. may choose to interconnect two or three storeys of a building with a non-required stairway, ramp or the like in accordance with **D1.12**.

Example

A two storey shop or suite of offices may be within a multi-storey building where all storeys are connected by a stairway which is both required and fire-isolated. This stairway may be external to the sole-occupancy unit which comprises the shop or office suite. For easy access within the sole-occupancy unit, another stairway may be located within the shop or office suite interconnecting the two storeys. That stairway is additional to the required stairway, and is not required to be fire-isolated.

Patient care and resident use areas — **D1.12(a)**

D1.12(a) prohibits the use of a non-required non-fire-isolated stairway or ramp in a patient care area of a Class 9a building and a resident use area of a Class 9c aged care building. The prohibition is because of the difficulties in evacuating bed-ridden, or otherwise mobility-impaired occupants. This prohibition applies to **D1.12(d)**, despite that provision's general reference to Class 9 buildings.

D1.12(b) allows any number of storeys to be connected in certain buildings as follows:

- The open nature of the construction of an open spectator stand, sports stadium, carpark, atrium, and a stairway or ramp located outside a building is such that the build-up of smoke is unlikely. **D1.12(b)(i)**, **(ii)** and **(iii)** permit any number of interconnected floors in such cases.

- In a Class 5 or Class 6 building containing a sprinkler system, **D1.12(b)(iv)** allows connection of any number of storeys if the interconnecting stairway, ramp, or escalator and the like complies with **Specification D1.12**.

Atriums and Part G3 — D1.12(b)(ii)

- While **D1.12(b)(ii)** refers to atriums, there are additional requirements for atriums in Part G3.

Number of interconnected storeys is restricted — D1.12(c) and (d)

D1.12 restricts the number of storeys which can be interconnected by a non-required non-fire-isolated stairway, ramp or the like. This recognises that an unprotected opening for a stairway, ramp, escalator or the like can lead to the spread of fire or smoke from one floor to another.

The restriction applies if:

- **D1.12(c)(i)** — a Class 2-9b building (excluding Class 9a) contains a sprinkler system, no more than three consecutive storeys can be linked, one of which storeys must directly egress to a road or open space. This recognises the effectiveness of a sprinkler system in controlling the spread of fire; or
- **D1.12(c)(ii)** — the building is an unsprinklered Class 2 or Class 3 building, two consecutive storeys can be linked, one of which must directly egress to a road or open space. Part **D1** does not generally apply to sole-occupancy units in Class 2 or Class 3 buildings, or Class 4 parts, and there is no restriction on an internal non-required non-fire-isolated stairway, ramp or the like linking two storeys in, for example, a two storey penthouse suite; or
- **D1.12(d)** — in a Class 5 or Class 6 building which does not qualify under **D1.12(b)(iv)**, and in Class 7-9b buildings (excluding a patient care area in a Class 9a, see **D1.12(a)**), two consecutive storeys can be linked.

Neither storey is required to provide direct egress to a road or open space and there is no requirement for a sprinkler system as part of this provision. As the stairway or ramp is not required by the BCA for emergency evacuation purposes, this provision is in accord with the remainder of the BCA.

D1.13 Number of persons accommodated**Intent**

To establish a methodology for calculating Deemed-to-Satisfy building populations which are permissible in the design and checking of applications when more accurate figures are not available.

D1.13 not to be used for non-BCA purposes

D1.13 and **Table D1.13** are used to calculate the anticipated number of people in particular types of building. From these calculations, minimum exit widths and the required number of sanitary and other facilities can be determined.

D1.13 and **Table D1.13** are not intended to restrict the number of occupants using a building, or to enforce any building use or licensing requirements.

Use of Table D1.13

If more accurate information is available on the expected population of a building, it should be used in preference to **Table D1.13**. This information may include:

- **D1.13(b)** — if the building is an assembly building or room, its seating capacity can be used; or
- **D1.13(c)** — where there is limited public access, a statement from the building owner as to the number of occupants who will use the building; or
- **D1.13(c)** — a study of the number of people using similar buildings. Such a study must include the number of people at various times. As an example, if the building is to be used as a shop, the figures must include the maximum numbers of people expected at peak times (such as before Christmas).

Example

It would be appropriate to use an alternative means of assessing the number of occupants when:

- under **D1.13**, a restaurant is deemed to accommodate one person for every square metre of floor area;
- if a specific restaurant has fixed tables, booths, dining alcoves and architectural features which occupy significant floor space, the actual number of patrons able to be accommodated may be much less than the number calculated using **D1.13**; and
- in such a case, it may be appropriate to use another method for calculating the number of people accommodated (such as counting the number of seats available for use by patrons), and hence calculating the total width of exits to be provided; however
- if such an approach is adopted, due allowance must be made for the employees, as well as the potential for alternative seating layouts which could increase the number of people in the restaurant.

D1.14 Measurement of distances**Intent**

To identify the nearest part of an exit for the purposes of measuring travel distance.

Why is this important?

D1.14 describes the point at which an exit has commenced with respect to both fire-isolated and non-fire-isolated exits.

Figures D1.15(1) and **D1.15(2)** illustrate methods of measuring the distance of travel specified in the BCA.

D1.15 Method of measurement**Intent**

To specify the method of measuring the distance of travel to an exit in various situations.

Path a person would walk

The distance of travel to an exit is measured by determining the path a person would walk from the most remote area of the building to the nearest exit.

Measure around any built obstructions

It is necessary to measure around any walls, or other built obstructions (including a wall, a demountable wall, and permanent fixed seating). See **D1.15(f)** and **(g)**.

Furnishings do not need to be taken into account

Generally, furniture, cars in a carpark and some non-built or non-fixed obstructions are not taken into account in the calculation of travel distance. However, there may be occasions when such matters must be taken into account.

Figures D1.15(1) and D1.15(2)

Figure D1.15(1) illustrates, by example, the method of measuring the distance of travel for Class 2 and Class 3 buildings and Class 4 parts.

Figure D1.15(1)
PLAN SHOWING ONE METHOD OF COMPLIANCE WITH SECTION D FOR CLASS 2 AND CLASS 3 BUILDINGS AND CLASS 4 PARTS

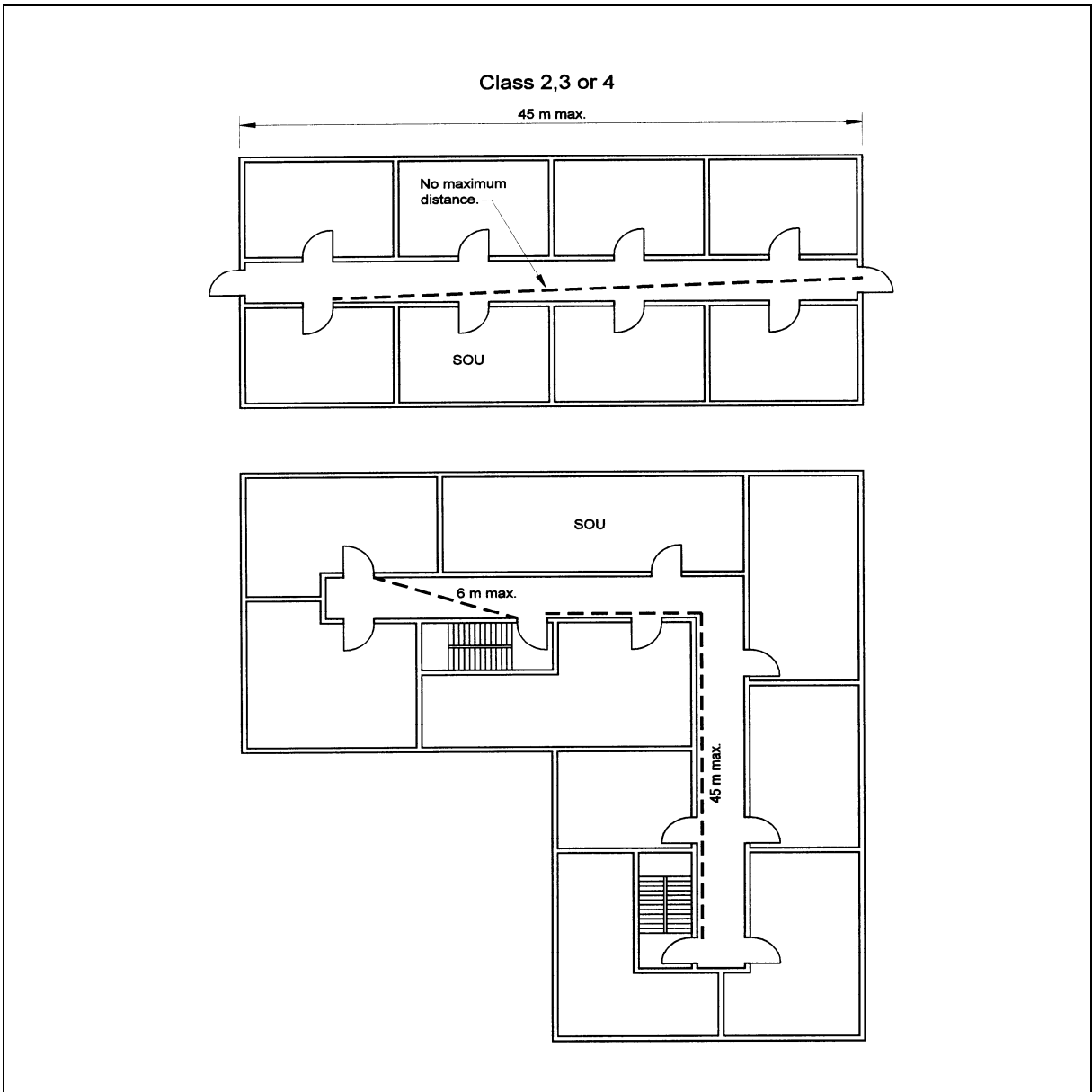
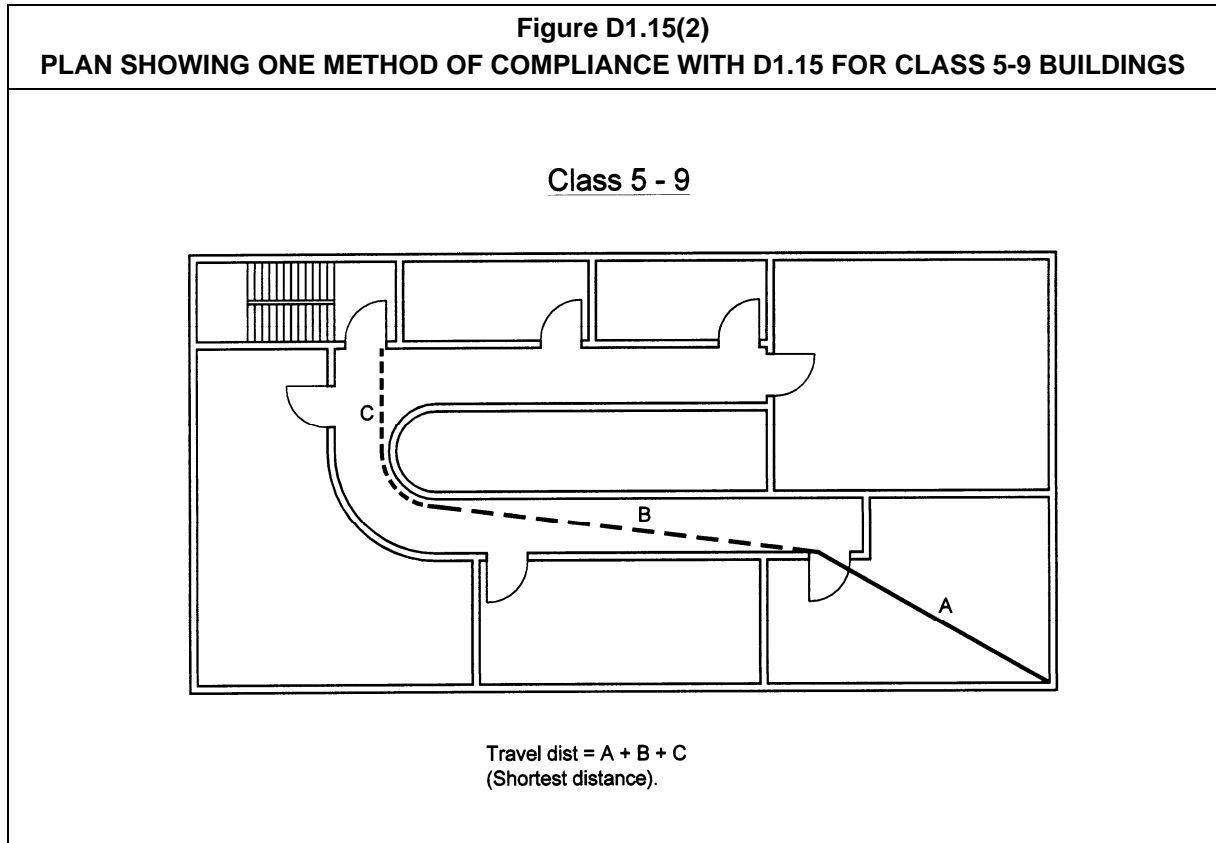

Figure D1.15(2) illustrates, by example, the method of measuring the distance of travel for Class 5-9 buildings.



D1.16 Plant rooms and lift motor rooms: Concession

Intent

To provide concessions for small plant and lift motor rooms.

Why are concessions made?

Concessions (such as the use of a ladder in lieu of a stairway) are granted for small plant or lift motor rooms for the following reasons:

- the usual occupants of a small plant or lift motor room are trained personnel who should be familiar with its layout;
- it is reasonable to assume that if the plant or lift motor room is small, so also will be the number of people who will ever occupy it;
- the small size of the room means that there is not a significant distance to travel to gain egress; and

- in the larger rooms which qualify for this concession, and multiple exits are provided, only one needs to be a stair.

Figure D1.16 illustrates some possible methods of using the concessions contained in D1.16.

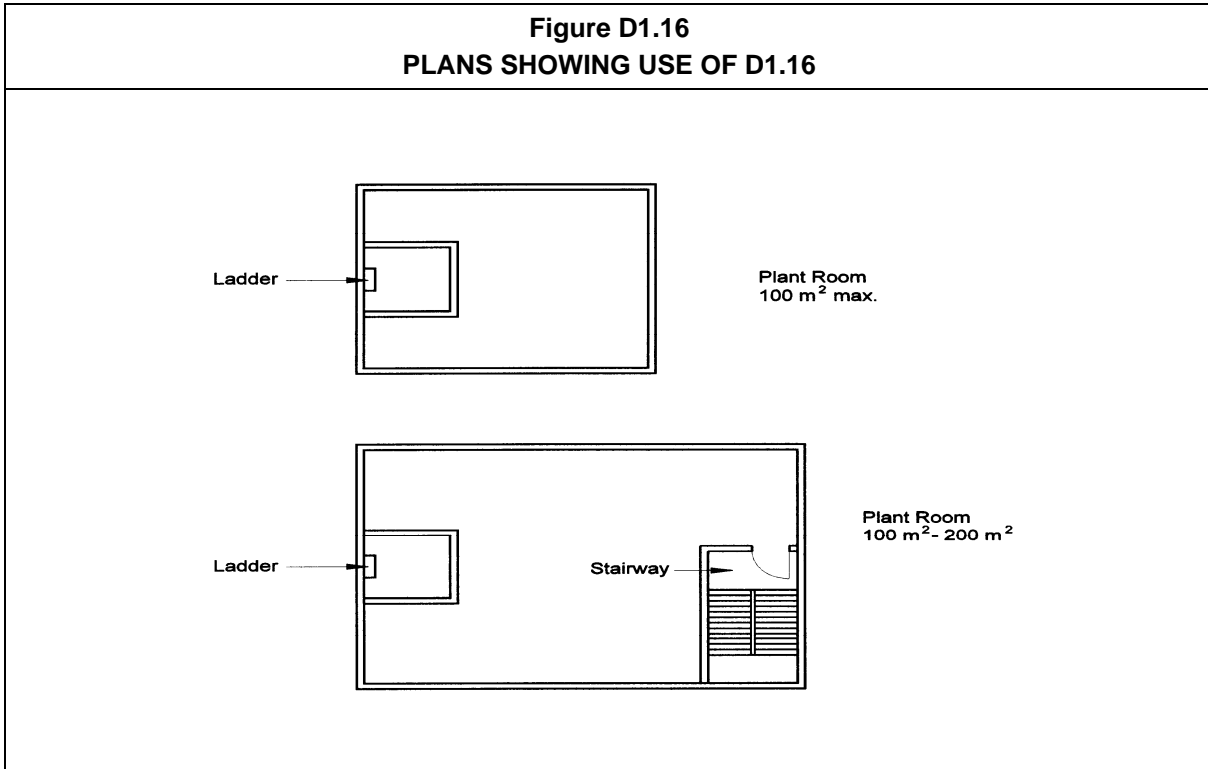

PART D2 CONSTRUCTION OF EXITS

Objective

Functional Statements

Performance Requirements

The Objective, Functional Statements and Performance Requirements for the whole of **Section D** are all located in the same position, preceding Part **D1**. The Comments on these provisions are located in the corresponding section of this Guide.

Deemed-to-Satisfy Provisions

D2.0 Deemed-to-Satisfy Provisions

Intent

To clarify that the requirements of **DP1 to DP9** will be satisfied if compliance is achieved with Parts **D1**, **D2** and **D3** in the case of all buildings, and Part **G3** in the case of buildings with an atrium, and Part **H1** in the case of theatres, stages and public halls.

See **Deemed-to-Satisfy Provisions of D1.0**.

D2.1 Application of Part

Intent

To clarify that Part **D2** does not apply within a sole-occupancy unit in a Class 3 building (except for **D2.13**, **D2.14(a)** and **D2.16**) nor within a sole-occupancy unit in a Class 2 building or Class 4 part (except for **D2.13**, **D2.14(a)**, **D2.16** and **D2.18**).

Where a path to the door is not a path of travel to an exit

Except as outlined below, Part **D2** does not apply within sole-occupancy units in Class 2 or Class 3 buildings or Class 4 parts. The path from within the units to the door opening from them is not regarded as a path of travel to an exit. For these buildings, the path of travel to an

exit commences at the outside of the door to the sole-occupancy unit. The path inside the unit, leading to the door, is part of the ‘evacuation route’ (see the definition of this term in **A1.1**).

Exceptions

D2.13 deals with the construction of stair treads and risers. For the safety of people moving within a sole-occupancy unit, it is important that stair treads and risers are safe to use.

D2.14(a) requires the installation of landings in stairways. For the safety of people moving within a sole-occupancy unit, it is important that landings be provided. This also links with **D2.13(a)** to limit the maximum number of risers in a flight of stairs to 18.

D2.16 deals with balustrades. Appropriate balustrades are required to minimise the risk of people falling from a landing, balcony, roof with public access, flight of stairs and the like.

D2.18 allows steeper stairs to infrequently used areas of a building. This concession applies to infrequently used areas such as machinery rooms, boiler rooms, etc and attics and storerooms in sole-occupancy units in Class 2 buildings and Class 4 parts. Under **D2.18**, the designer has the choice of designing the stair, landing, balustrade and other barrier and handrail to comply with the appropriate provisions of the BCA or with [AS 1657](#).

D2.2 Fire-isolated stairways and ramps

Intent

To maintain a sufficient level of fire safety to enable the use of fire-isolated stairways and ramps during an emergency.

Materials and construction methods

D2.2 sets the criteria for the materials and methods of construction used in stairways and ramps within a fire-resisting shaft.

Integrity of fire protection to be maintained — **D2.2(a)** and **(b)**

D2.2(a) and **(b)** set out the requirements for maintaining the integrity of the fire protection to the shaft of a fire-isolated stairway and ramp. These provisions reflect the fact that:

- occupants who use the stairway or ramp during a fire will expect to remain reasonably safe while evacuating, relying on the protection provided by the fire-isolated stairways and ramps to safely evacuate the building; and
- the stairway or ramp provides protection to the fire brigade to undertake search and rescue, and fire-fighting operations.

D2.3 Non-fire-isolated stairways and ramps

Intent

To maintain a sufficient level of safety for the use of stairways and ramps during an emergency.

Safe egress required

Where the installation of non-fire-isolated stairways and ramps is required by the BCA, they must provide a safe means of egress.

Such stairways and ramps will not be within a fire-resisting shaft, but they are nonetheless expected to be structurally sound, and constructed of materials which will not readily support combustion.

D2.3 requires that required non-fire-isolated stairways and ramps must be either constructed in accordance with **D2.2** or the alternative options set out in **D2.3(a)–(c)**.

Glued timber members — **D2.3(c)(iii)**

D2.3(c)(iii) permits the use of glued timber members under certain conditions. The aim of these conditions is to minimise the risk represented by certain types of glue which delaminate during a fire.

D2.4 Separation of rising and descending stair flights

Intent

To minimise the risk that an occupant mistakenly passes the lowest storey providing escape when evacuating.

Risk of missing the lowest egress floor — **D2.4(a)**

A danger exists that, in an emergency, a person may mistakenly pass the lowest floor providing direct egress to a road or open space. **D2.4(a)** minimises the risk of this by requiring that there is no direct connection between the rising and descending flight of a stairway at the level from which egress is obtained.

Separation required — **D2.4(b)**

If, in order to achieve **D2.4(a)**, rising and descending flights of stairs are separated by construction (which may in places be common to the two flights), that construction must comply with the smoke separation requirements contained in **C2.5(d)**.

Figure D2.4 illustrates one method of compliance with D2.4.

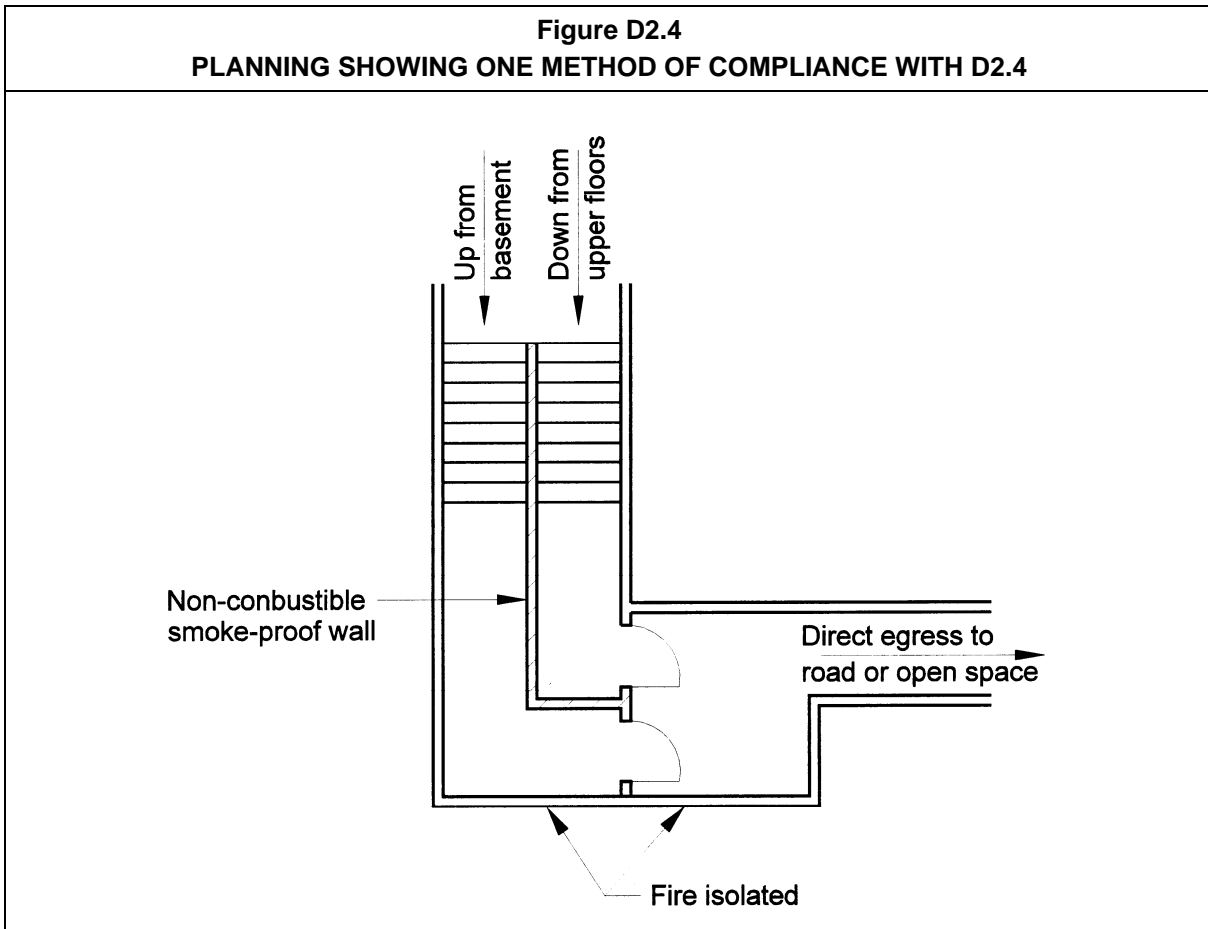

D2.5 Open access ramps and balconies

Intent

To specify the requirements for natural ventilation of smoke from an open access ramp or balcony which forms part of a required exit system.

Background

Table E2.2a allows the use of an open access ramp or balcony instead of stairwell pressurisation. If this option is chosen then **D2.5** aims to prevent the entry of smoke into a fire-isolated exit by allowing smoke to vent naturally through an open access ramp or balcony, before it reaches the fire-isolated exit.

Ventilation openings — **D2.5(a)**

D2.5(a) sets out the requirements for ventilation openings where an open access ramp or balcony forms part of a required exit. This helps the evacuation of occupants using the exit by enabling the natural ventilation of smoke.

Enclosure permitted up to 1 metre — **D2.5(b)**

The reason for permitting an enclosure up to a height of one metre under **D2.5(b)** is to allow for a solid balustrade or balcony.

No more than 25 percent enclosed above 1 metre — **D2.5(b)**

Note that the opening above one metre cannot be enclosed for more than 25 percent of the area of its sides. This allows for adequate smoke ventilation, while permitting some limited enclosure.

Figure D2.5 illustrates three methods of compliance with D2.5, and one method that does not comply.

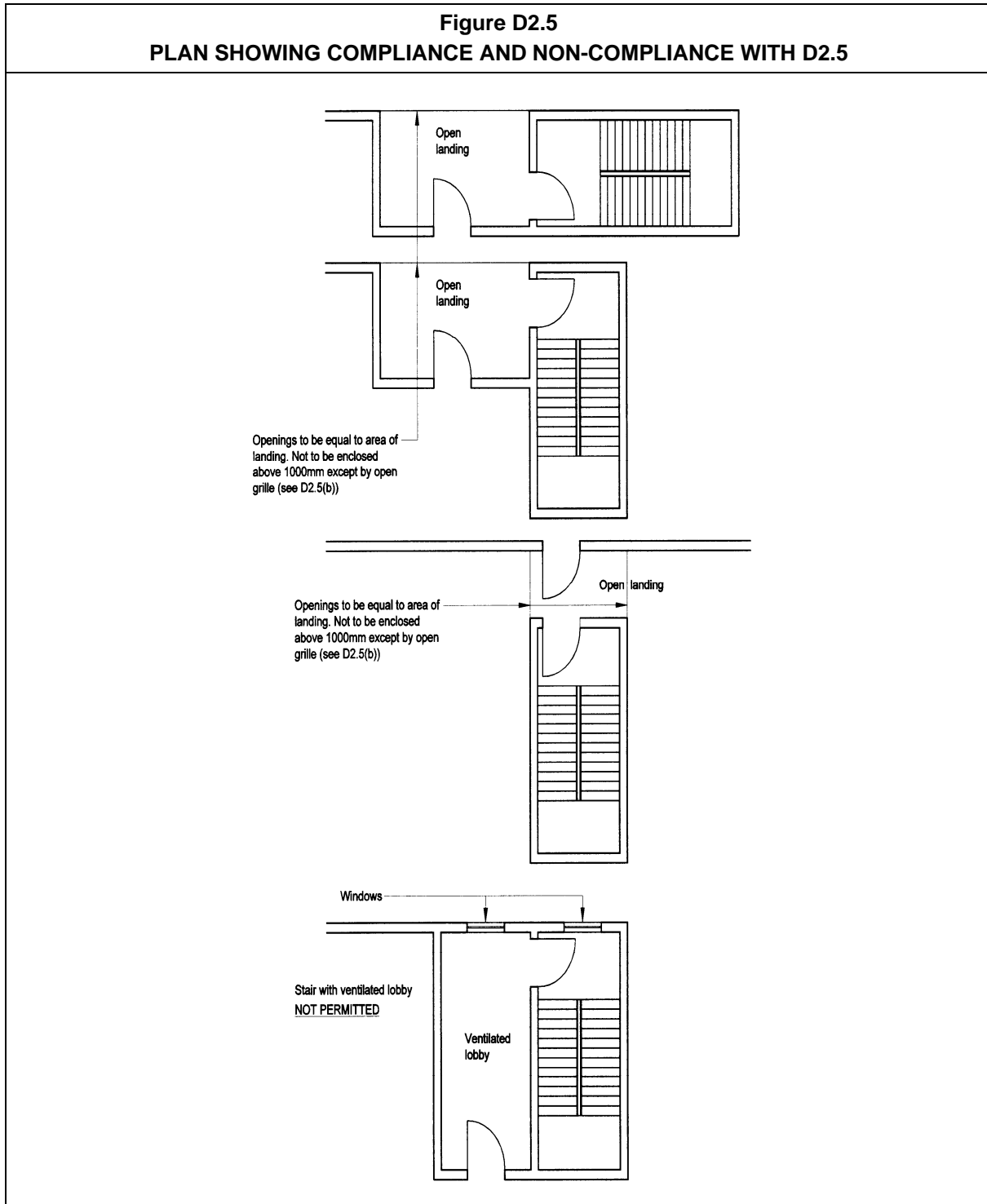

D2.6 Smoke lobbies

Intent

To prevent smoke entering a fire-isolated exit.

Smoke lobbies required by D1.7

D2.6 only applies to a smoke lobby required by D1.7.

A smoke lobby required by D1.7 must be constructed in accordance with each of the requirements in D2.6(a)–(d).

Intumescent putty — D2.6(b)(iii)

The intumescent putty referred to in D2.6(b)(iii) is intended to expand when exposed to fire, thus sealing any opening at the top of the lobby against smoke. If another material is proposed, it must be no less effective than the putty.

D2.7 Installations in exits and paths of travel

Intent

To maximise the safety of occupants evacuating to or within exits by limiting the types of services which may be located in exits and paths of travel.

Services in exits and paths of travel

Paths of travel within a building must continue to provide safe evacuation during an emergency. To achieve this, D2.7 restricts the installation of certain services in fire-isolated exits, non-fire-isolated exits, and certain paths of travel to exits.

Access to services — D2.7(a)

D2.7(a) prohibits access to services (apart from fire-fighting and detection equipment) from within a fire-isolated exit because they are a potential source of smoke or fire. Doors to service enclosures, if left open, could also hamper evacuation. The prohibition also means that maintenance equipment will not be placed within the enclosure.

Chutes and ducts — D2.7(b)

D2.7(b) prohibits any chute or duct carrying products of combustion from a boiler, incinerator fireplace or the like from being installed in:

- any required exit (ie both fire-isolated exits and non-fire-isolated exits); and

- any corridor, hallway, lobby or the like leading to a required exit (ie it does not apply to other paths of travel to an exit).

An opening from a chute or duct that forms part of a smoke hazard management system is permitted.

Gas and fuel services — D2.7(c)

D2.7(c) prohibits the installation of any gas or other fuel service in a required exit (ie both fire-isolated exits and non-fire-isolated exits). This prohibition does not apply to a path of travel to an exit.

Other services — D2.7(d)

Under specified conditions, **D2.7(d)** allows certain electrical and communication services to be located in:

- D2.7(d)(iv)** — any required non-fire-isolated exit (installation in required fire-isolated exits is effectively prohibited by the reference to **D2.7(a)**); and
- D2.7(d)(v)** — any corridor, hallway, lobby or the like leading to a required exit (ie it does not apply to other paths of travel to an exit).

Electrical wiring — D2.7(e)

D2.7(e) allows electrical wiring to be installed within a fire-isolated exit if the wiring is associated with specified equipment and systems serving the exit or systems used for alarms and monitoring of fire safety systems.

D2.8 Enclosure of space under stairs and ramps

Intent

To minimise the risk of a fire starting under a stairway and endangering the safe evacuation of the building occupants.

Fire risk from spaces under stairways or ramps

Spaces under stairways are often used for a range of purposes. It is common practice to have a cleaner's store located in such spaces. These stores often contain flammable cleaning agents.

Required fire-isolated stairways or ramps — D2.8(a)

Space is part of the fire-isolated shaft

If the stairway or ramp is fire-isolated, and the space below is part of the fire-isolated shaft, that space must not be used as a cupboard or the like.

Space is not part of the fire-isolated shaft

If the stairway or ramp is fire-isolated, and the space below is not part of the fire-isolated shaft, that space may be used as a cupboard etc. This could be created by placing a fire rated slab under the flight of stairs. This is shown in **Figure D2.8**.

Required non-fire-isolated stairways or ramps — D2.8(b)

If the stairway or ramp is non-fire-isolated, any cupboard underneath must be fire separated from the stairway. The construction must have an FRL of 60/60/60, with a self-closing -/60/30 fire door.

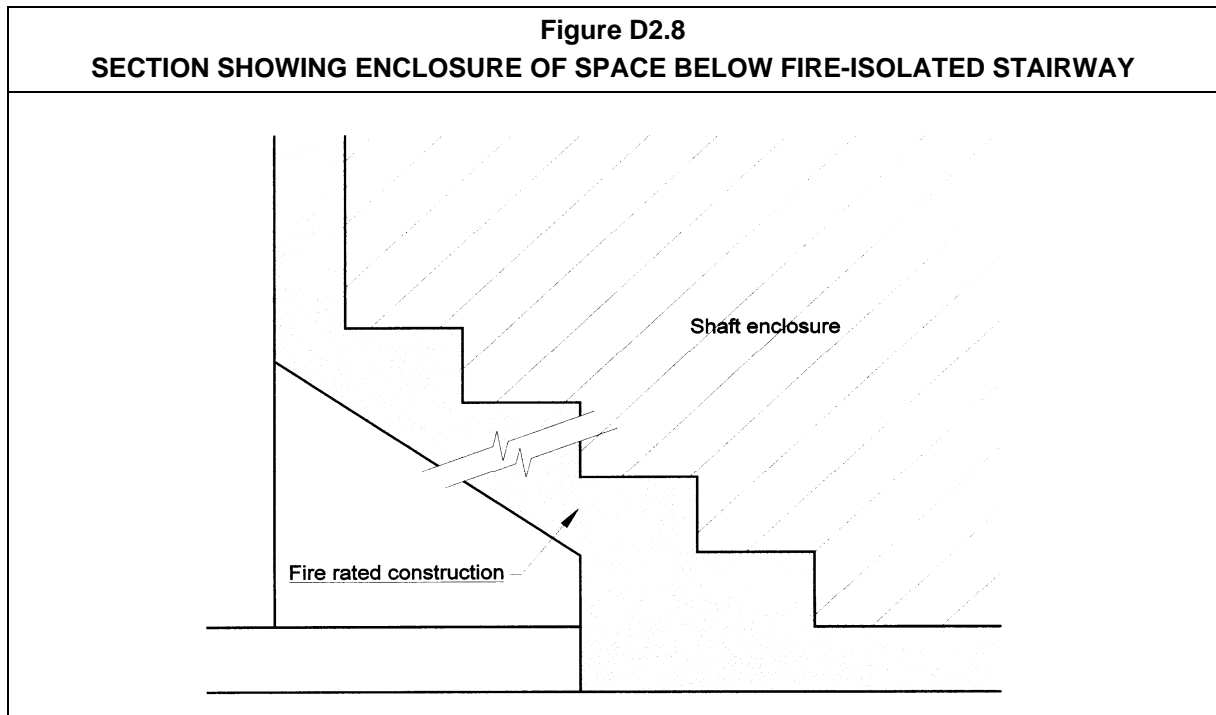

D2.9 Width of stairways

Intent

To establish an acceptable method of measuring the width of a stairway.

Measurement must be clear of obstructions — D2.9(a)(i)

Under **D2.9(a)(i)**, the required stairway width must be measured clear of obstructions, including handrails and projecting balustrades.

Example

A stairway has handrails along both sides and they are located within the width of the stairway (as opposed to along the top of a banister along the edge of the stairway).

In this case, the required stairway width must be measured between the handrails (presuming that there are no other obstructions intruding into the stairway).

Height of two metres — D2.9(a)(ii)

Under **D2.9(a)(ii)**, the required width of a stairway must continue to a height of 2 metres above the stair. This measurement is consistent with other similar BCA requirements.

Width of two metres — D2.9(b)

Most people using stairways tend to move in easy reach of a handrail or balustrade. This tendency is particularly pronounced during an emergency evacuation. The **D2.9(b)** maximum of two metres (effectively permitting a reach of one metre to either side) is considered reasonable.

Wider stairways are permitted, with more than two metres between the handrails. However, for the purposes of calculating required widths, such stairways are deemed to add no more than two metres to the aggregate required width.

Example

If a building is required to have a path of travel to an exit with a width of four metres, a stairway with four metres of width between its handrails will not comply, as it will be deemed to only provide two metres of width. Therefore, an intermediate handrail should be provided or a further two metres must be provided by other means.

Figure D2.9 illustrates compliance with D2.9.

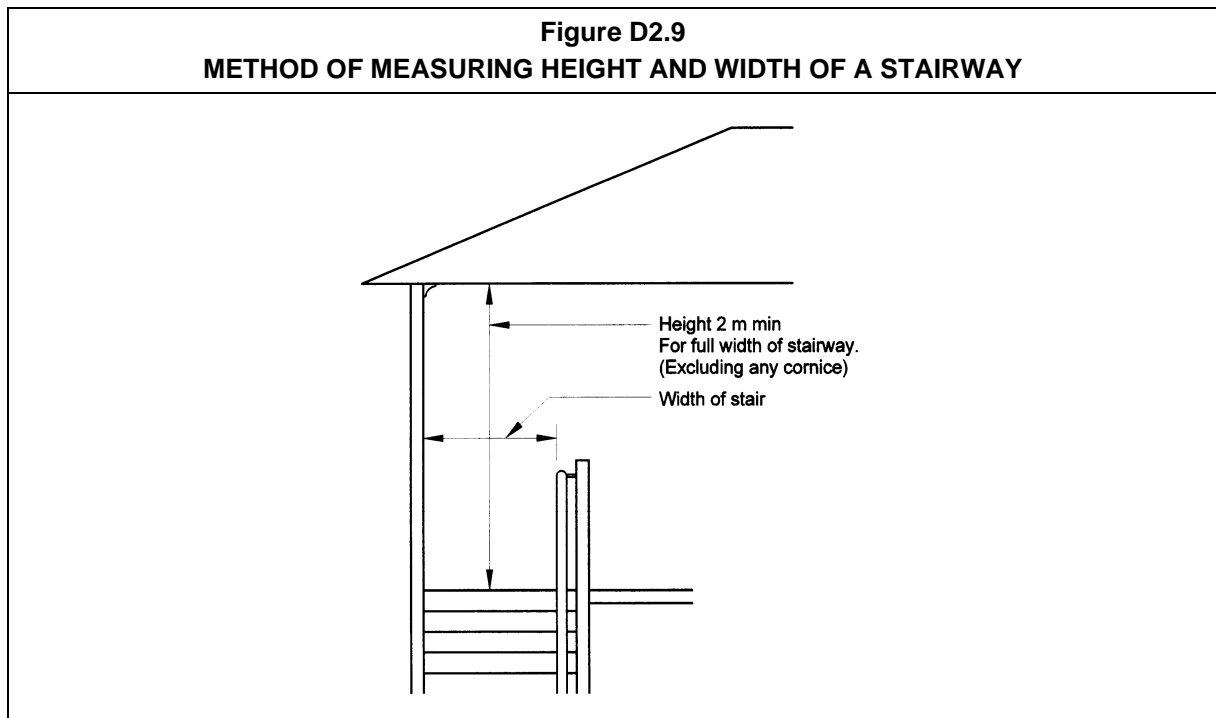

D2.10 Pedestrian ramps

Intent

To allow the use of a ramp as a required exit, instead of a stairway.

Ramps instead of stairways — D2.10(a)

Under D2.10(a), a fire-isolated ramp may be used instead of a fire-isolated stairway if:

- the construction enclosing the ramp complies with the requirements of the BCA for fire-isolated stairways; and
- the width and ceiling height of the ramp complies with the requirements of the BCA for fire-isolated stairways.

Specified ramp gradients — D2.10(b)

D2.10(b) specifies safe gradients for a ramp used as a required exit. They are determined having regard to likely users.

Ramps for people with disabilities, as specified by Part D3, require a gradient of not less than 1:14, and in other cases, not less than 1:8.

D2.10(b) relates to a ramp being used as a fire-isolated exit. If the ramp is also used for access it must comply with the requirements for such ramps in Part **D3**.

D2.11 Fire-isolated passageways

Intent

To make a fire-isolated passageway safe from a fire outside.

Protection of fire-isolated passageways — D2.11(a)

Under **D2.11(a)**, the required FRL of a fire-isolated passageway must (except as set out in **D2.11(b)**):

- **D2.11(a)(i)** — not fall below the required FRL of any fire-isolated stairway or ramp which discharges into the passageway; and
- **D2.11(a)(ii)** — in every other case, not fall below 60/60/60.

The FRL test is for a fire outside the passageway, in another part of the building. It is extremely unlikely that a fire will occur inside a fire-isolated passageway.

Top of a fire-isolated passageway — D2.11(b)

Despite the requirements of **D2.11(a)**, **D2.11(b)** allows the top of a fire-isolated passageway to be constructed without an FRL on the condition that its walls are built up to either of the following:

Non-combustible roof covering — D2.11(b)(i)

The top construction of a fire-isolated passageway need not have an FRL if the walls continue to the underside of a non-combustible roof covering.

Incipient spread of fire resistant ceiling — D2.11(b)(ii)

Under **D2.11(b)(ii)**, a fire-isolated passageway need not have a top construction with an FRL, and need not have its walls extend to the underside of a non-combustible roof covering if the

walls extend to the underside of a ceiling which is resistant to the incipient spread of fire for at least 60 minutes.

PART D2 – CONSTRUCTION OF EXITS

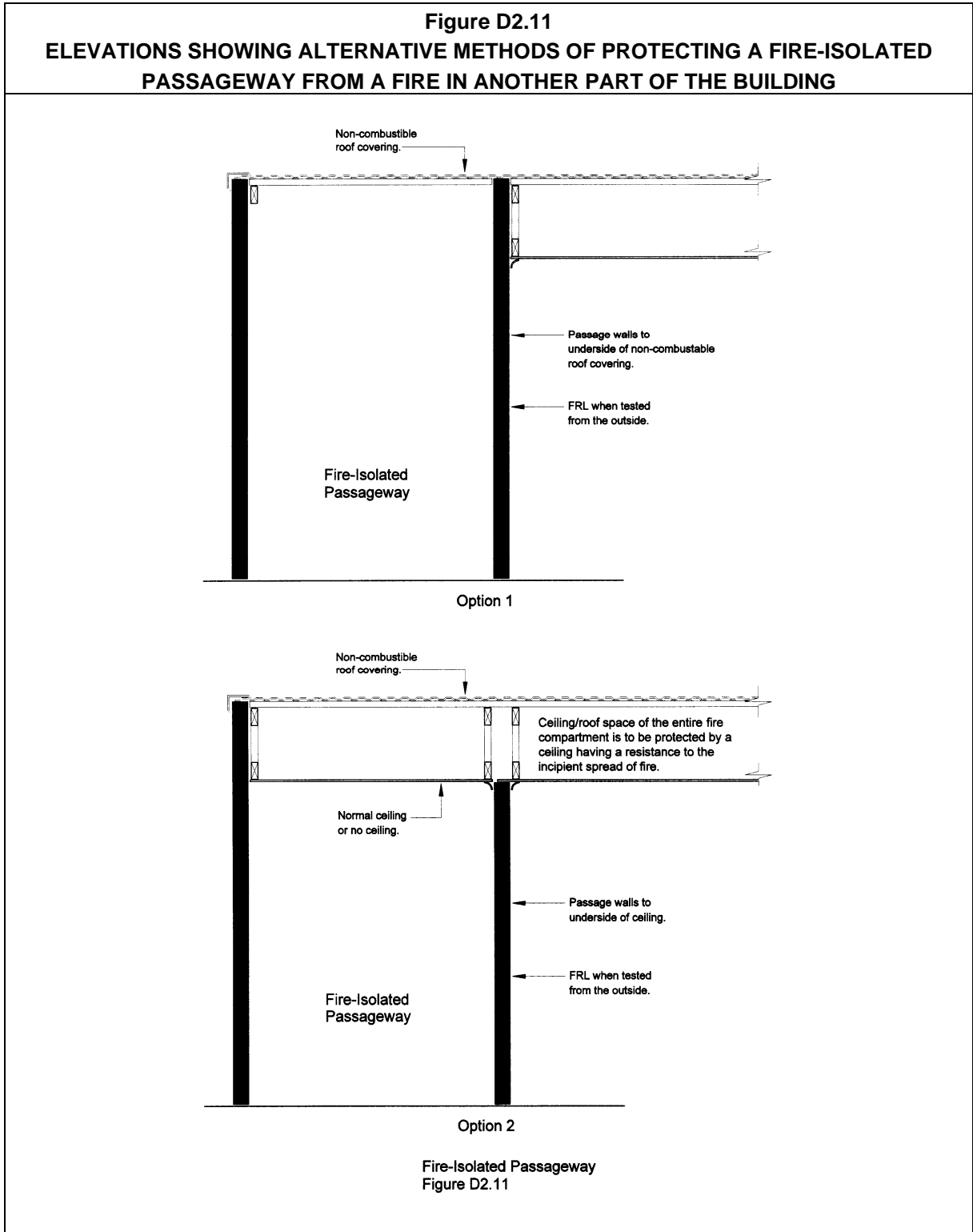

Such a ceiling will prevent the ignition of combustible materials in the roof or ceiling space from a fire below. For the ceiling to be effective, the whole fire compartment surrounding the

passageway must also be covered. This will minimise the risk of a fire spreading into the fire compartment's roof or ceiling space, and entering the passageway from above. An incipient spread of fire resistant ceiling is not required over the passageway, because it is extremely unlikely that a fire will start there.

It is important that the junction between the top of the wall and the incipient spread of fire resistant ceiling is adequately sealed to maintain the integrity of the barrier.

Figure D2.11 illustrates this Comment.

D2.12 Roof as open space

Intent

To allow a roof of a building to be used as a point of discharge from an exit.

Roof must be protected

Exits must provide egress to a road or an open space. **D2.12** applies where the open space is provided by a roof. To maximise the safety of people who must use a roof as the point of discharge from an exit, such a roof is required:

- **D2.12(a)** — to have an FRL sufficient to protect people on the roof from fire below during evacuation from the building; and
- **D2.12(b)** — not to have any openings within three metres of the path of travel to the portion of the roof being used as open space, and from that portion to a road. This protects a person passing such openings from being affected by a fire on the other side of such openings.

Safe path of travel to road

Once on the roof, a safe path of travel must be provided to a road. See **D1.10**.

D2.13 Goings and risers

Intent

To enable the safe movement of people using stairways.

Background to D2.13 — goings and risers

The going and riser requirements in **D2.13** date from a substantial reform carried out in 1987, based on international research.

Safe stairway requirements**No more than 18 nor less than 2 risers — D2.13(a)**

D2.13(a) states that a stairway must have no more than 18 nor less than 2 risers in each flight. Where there are less than 2 risers in a flight, they do not comprise a stairway for the purposes of the BCA.

Eighteen risers is considered to be the maximum reasonable number that an average person can negotiate before requiring a rest.

Winders are counted as part of the maximum number of 18 risers. More than one riser is considered necessary for a person to observe and adjust to a change in level. A single riser may not be an obvious signal of a change in level, and may cause a person to stumble or trip.

Going and riser heights — D2.13(a) and (c)

The purpose of **D2.13(b)** and **(c)** is to achieve constant going and riser heights deemed safe for people to walk up and down. This minimises the risk of people tripping on uneven stairs. **Table D2.13** expresses ratios between stairways which are considered safe for use.

Openings in stair risers — D2.13(d)

D2.13(d) allows the use of open stair risers. However, it limits the opening to 125 mm to minimise the risk to children.

Treads — D2.13(e)

Under **D2.13(e)**, treads must be slip resistant, or have a non-skid strip to avoid people slipping over and injuring themselves. The non-skid strip need only be on the tread's nosing. This provision is written as a performance statement, specific provisions have not been developed.

Solid treads — D2.13(f)

Under **D2.13(f)**, where a stairway is of a specified height, solid treads must be used so that people cannot see through them. This minimises the risk to people affected by vertigo.

Change in direction — D2.13(g)

Under **D2.13(g)**, stairways in Class 9b buildings require a change in direction of at least 30° at specified points. This limits the distance a person can trip or fall down the stairways. This sort of occurrence is more likely to take place in buildings with large numbers of people who are unfamiliar with the building or its stairways.

Winders in lieu of landings — D2.13(h) and (i)

Under **D2.13(h)**, winders in lieu of landings are not permitted in a required stairway under **D2.13(i)**. Winders in lieu of landings are permitted in non-required stairways provided that not more than 3 winders in lieu of a quarter landing or not more than 6 winders in lieu of a half landing are used.

Table D2.13Purpose

Table D2.13 addresses both public and private stairways, and provides information on acceptable maximum and minimum risers and goings. It also illustrates the method of measuring the rise and going of stairway treads and the maximum gap between treads referred to in **D2.13(d)**.

Stairway that is curved or circular in plan view

Note (b) of **Table D2.13** allows the use of a stairway which is curved, or circular in plan view.

D2.14 Landings**Intent**

To enable the safe movement of people using stairways.

Purpose of a landing in a stairway

The purpose of a landing is to limit the number of risers to provide a rest area for the people using the stairway, and to allow the stairway to change direction if needed.

Maximum grade of 1:50 — D2.14(a)

The maximum grade of 1 in 50 required under **D2.14(a)** makes sure that the landing is as level as possible, but still allows a slight slope for drainage if necessary.

Minimum landing length — D2.14(a)(i)

The minimum length of a landing allows people using the stairway to rest, and reduces the risk of a person falling more than one flight of stairs.

Non-slip finish or non-skid strip — D2.14(a)(ii)

The non-slip finish or non-skid strip is to prevent a person slipping on the landing.

Class 9a buildings — D2.14(b)

D2.14(b) provides two options for landings in Class 9a buildings. The aim is to aid the use of a stretcher.

Figure D2.14 illustrates the method of measuring the length of landings as required by D2.14.

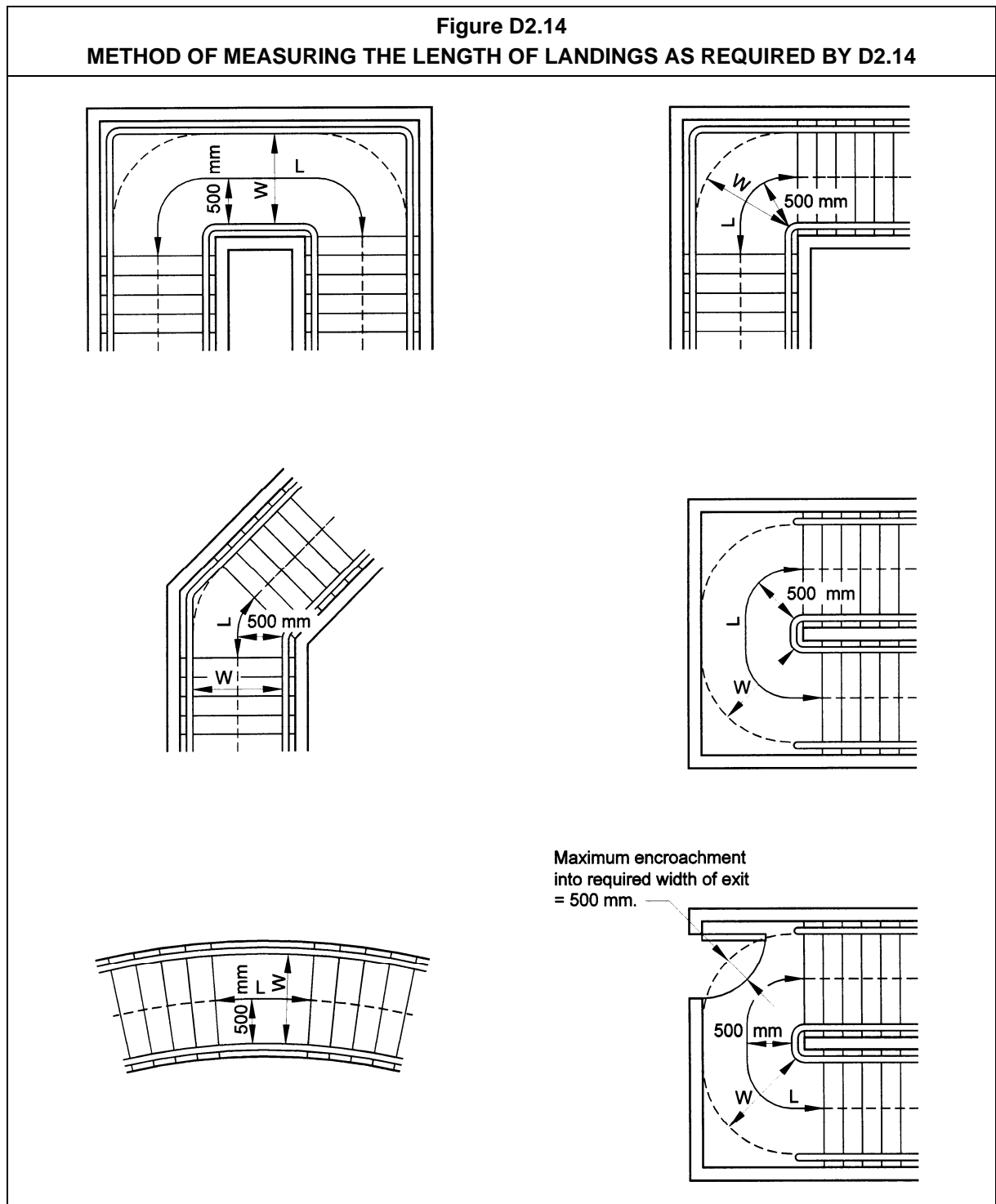

D2.15 **Thresholds**

Intent

To reduce the risk of a person tripping on an unseen step in a doorway.

Step prohibited too close to a door

It is difficult to see a step or ramp which is too close to a door. People can trip, particularly if the ramp or step is on the opposite side of a door. **Figure D2.15(1)** illustrates the area where a step is not allowed in a doorway.

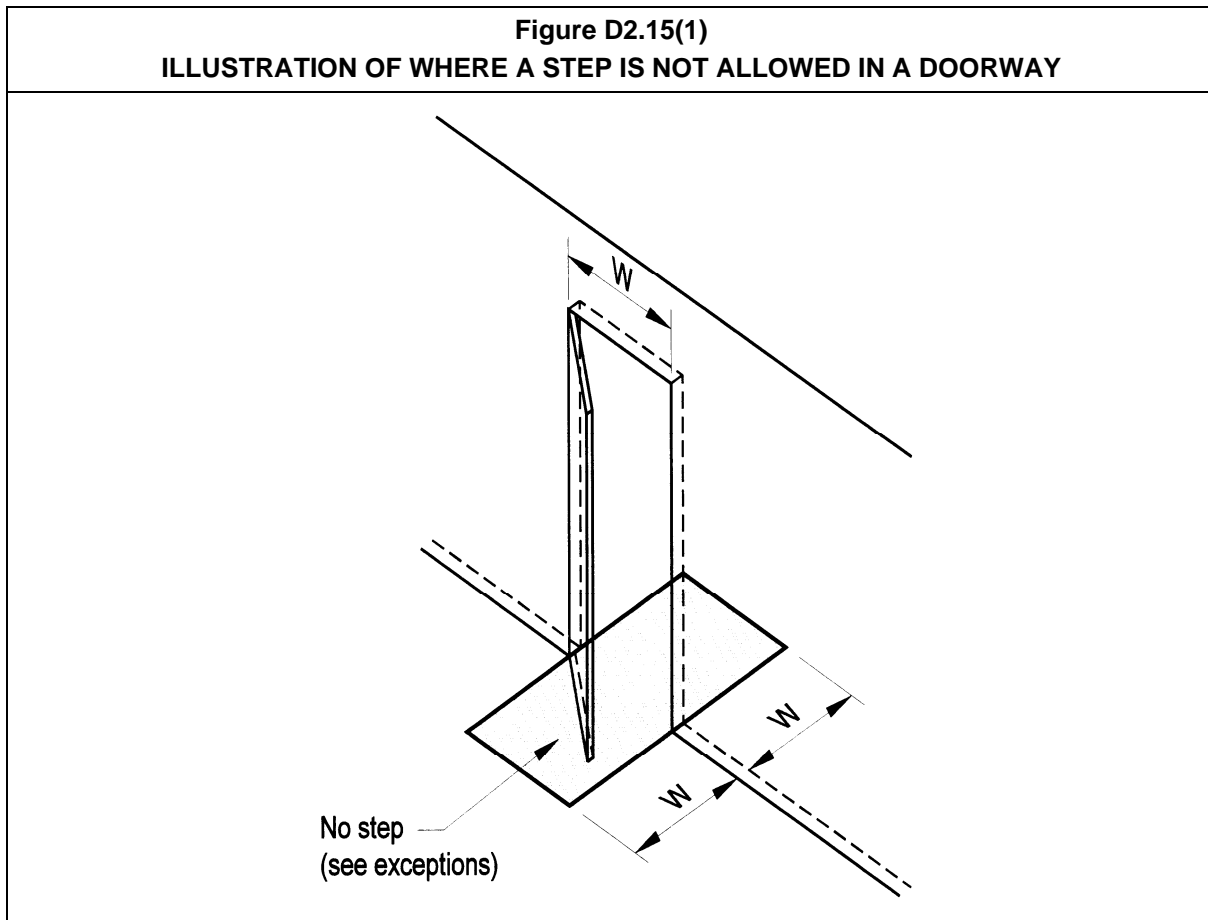
**Concessions — D2.15(a), (b) and (c)**

Concessions are granted in specified circumstances. These include:

- **D2.15(a)** — in the patient care areas of a hospital; and
- **D2.15(b)** — in Class 9c aged care buildings; and
- **D2.15(c)** — in other buildings, to allow for weatherproofing under an external door.

Class 9c aged care buildings — D2.15(b)

The threshold of a doorway in a Class 9c aged care building, which is subject to a change in level, may incorporate a ramp and cannot be provided with a step. This is a safety requirement due to the varying mobility of the residents. The ramp may have a maximum slope of 1 in 8 and a maximum height of 25 mm. **Figure D2.15(2)** illustrates an example of a ramp at a doorway threshold in an aged care building.

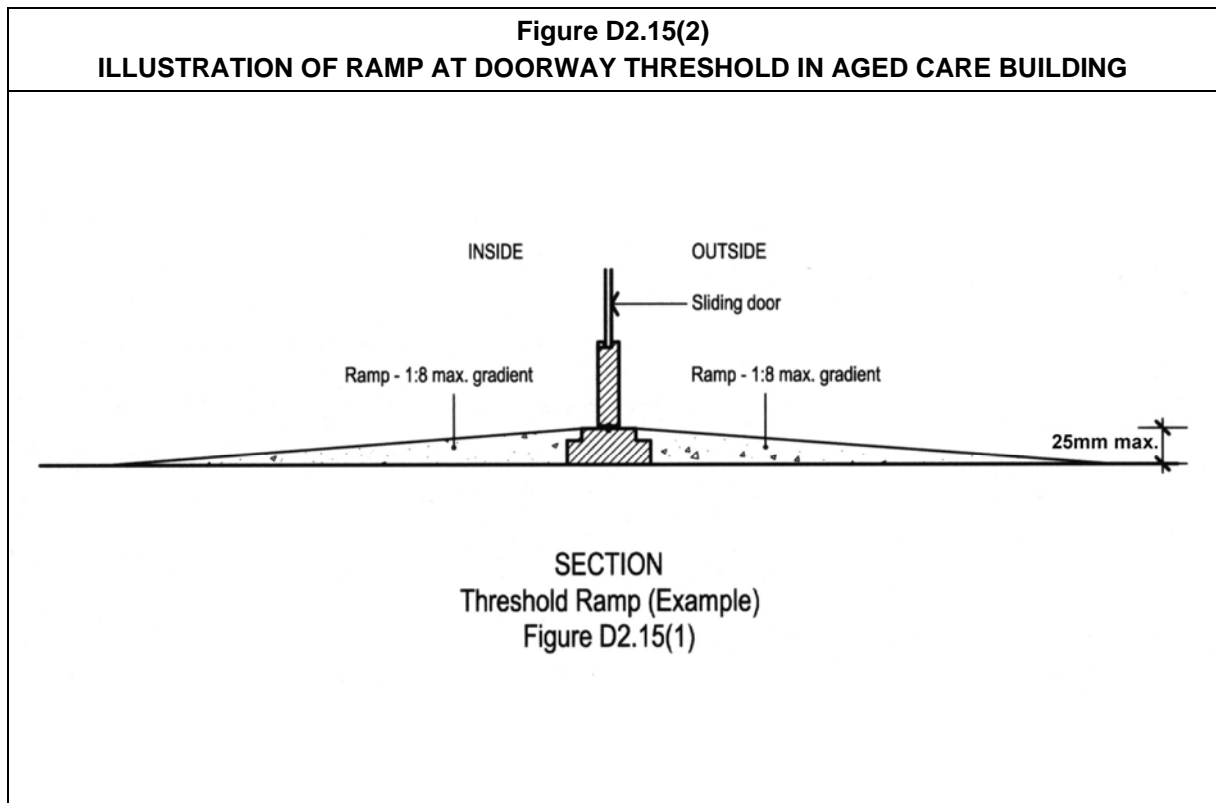
**D2.16 Balustrades or other barriers****Intent**

To minimise the risk of a person falling from a roof, stairway, raised floor level or the like.

D2.16 and DP3

This is the **Deemed-to-Satisfy Provision** for **DP3**.

Where balustrades are required

D2.16(a) sets out when balustrades are required. The following specific provisions apply:

- **D2.16(b)(i)** — for fire-isolated exits, where unaccompanied children are unlikely to be present.
- **D2.16(b)(ii)** — for Class 7 buildings (other than car parks) and Class 8 buildings, which

are assumed to have a low occupancy rate and where unaccompanied children are unlikely to be present.

- **D2.16(c)** — for non-fire-isolated stairways and ramps.
- **D2.16(d)** — for horizontal surfaces.
- **D2.16(e)** — for certain Class 9b buildings, where lesser heights are permitted to allow uninterrupted viewing of a performance. These lower heights are not expected to be a problem, because unaccompanied children are unlikely to be present.
- **D2.16(f)** and **(g)** — provide the required construction details regarding height and the gap between balusters. To lessen the risk of children climbing and falling from high balconies, the design must not incorporate horizontal rails or other similar features.
- **D2.16(f)** — the slope of 1:20 is included to distinguish between the floor of a ramp and the floor of a landing that has a slight slope for drainage purposes. The result is that if the floor has a slope of less than 1:20, it is considered as a landing and must have a balustrade with a height of not less than 1 m above the floor. In all other cases, the floor is considered to be a ramp, where the balustrade must have a height of not less than 865 mm above the floor.

Figures D2.16(1) and **D2.16(2)** illustrate the various requirements for balustrades.

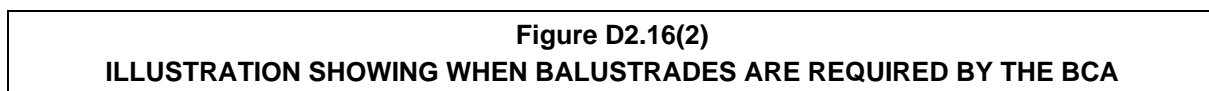
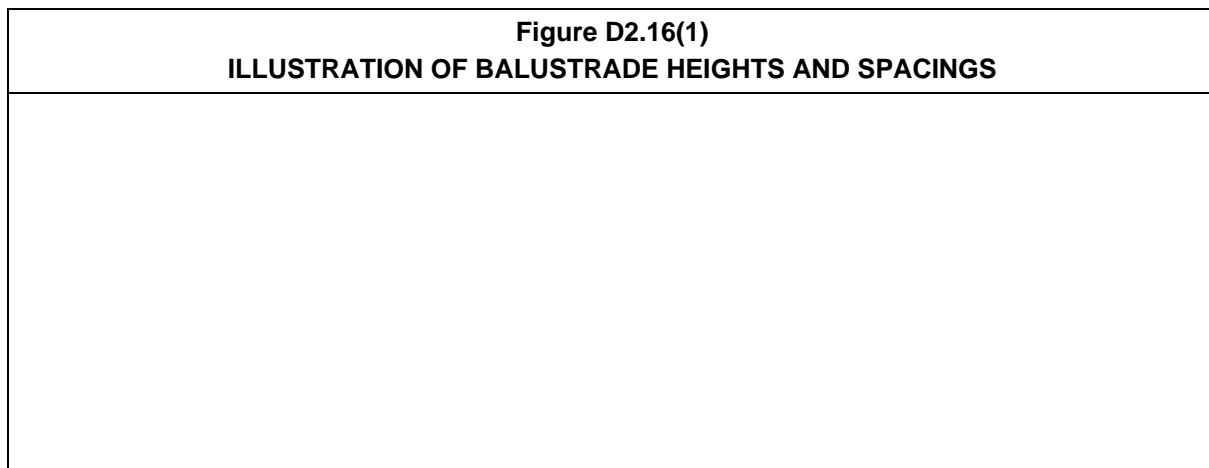

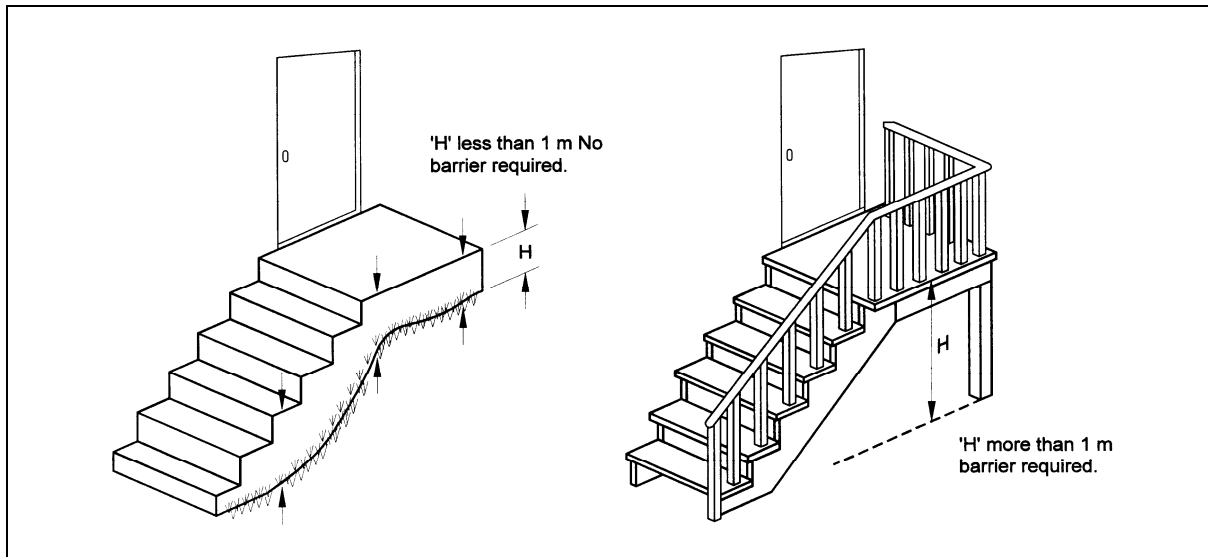

D2.17 Handrails

Intent

To provide handrails to a stairway or ramp, in corridors in Class 9a and 9c buildings and in corridors required to be accessible by people with disabilities.

D2.17 addresses requirements regarding the location, spacing and extent of handrails. Where both balustrade and handrail matters require consideration, **D2.17**'s provisions must be read in conjunction with those of **D2.16**.

Handrail location and separation — **D2.17(a)(i)–(iii)**

D2.17(a)(i), **(ii)** and **(iii)** set out the location and separation requirements for handrails. **D2.17(a)(iii)** only applies where intermediate handrails are provided. The BCA does not require that they be provided. See also **D2.9(b)**.

Handrail heights

Primary schools — **D2.17(a)(iv)**

D2.17(a)(iv) requires a second handrail located at a practical height between 665 mm and 750 mm in a primary school, to aid children who are generally shorter than adults.

865 mm height requirement — **D2.17(a)(v)**

Under **D2.17(a)(v)**, the height of handrails is a minimum of 865 mm, so that they are comfortable to use for most people.

Continuous handrails

D2.17(a)(vi) requires a continuous handrail between stair flight landings. It does not apply around a landing between flights, as such a requirement would often be impractical.

Obstructions placed on handrails to prevent people deliberately sliding down them must be considered on a case by case basis to determine whether a hand hold is broken. Ball type stanchions at the top of supports to handrails may be permissible. See **Figure D2.17(1)**.

Handrails in Class 9a corridors — **D2.17(b)(i)**

The **D2.17(b)(i)** provisions requiring handrails on at least one side of corridors in a Class 9a building are intended to assist patients.

Handrails in Class 9c corridors — **D2.17(b)(ii)**

The **D2.17(b)(ii)** provisions requiring handrails in corridors in a Class 9c building are intended to assist residents. The handrails are required on both sides of the corridor to assist residents accessing the common areas such as dining rooms and recreation rooms in their day to day living.

People with disabilities — **D2.17(c)**

Under **D2.17(c)**, where any building is required to provide access for people with disabilities to the entrance floor, but not to other floors, and a lift is not provided to the upper floors, handrails complying with Clause 5 or 9 of **AS 1428.1** must be provided to the main stairway. See **D3.3(a)(ii)**.

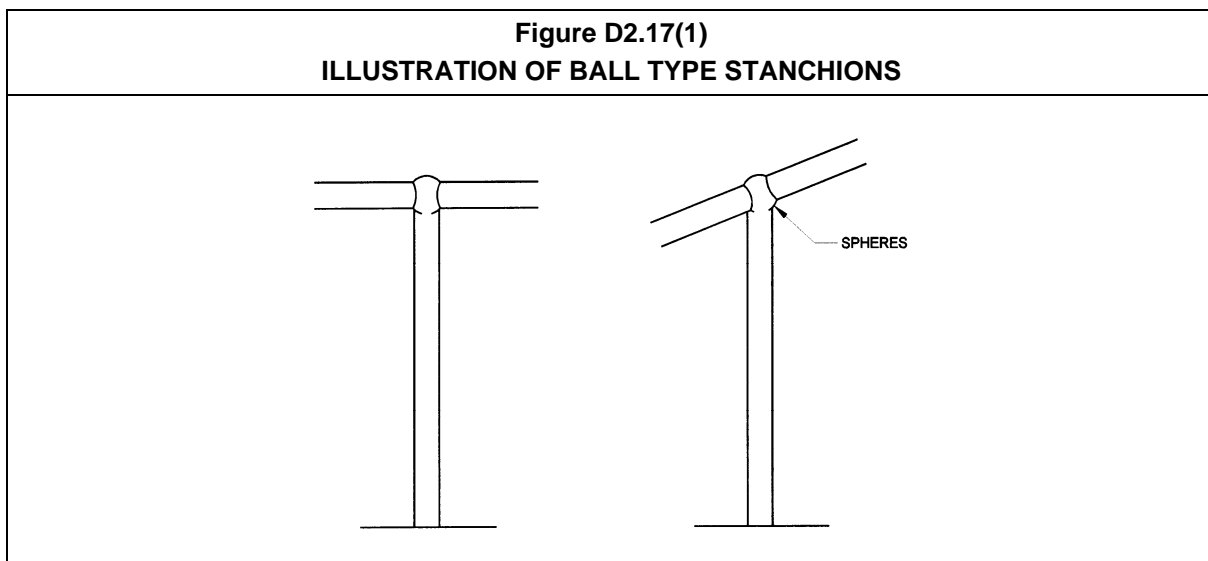
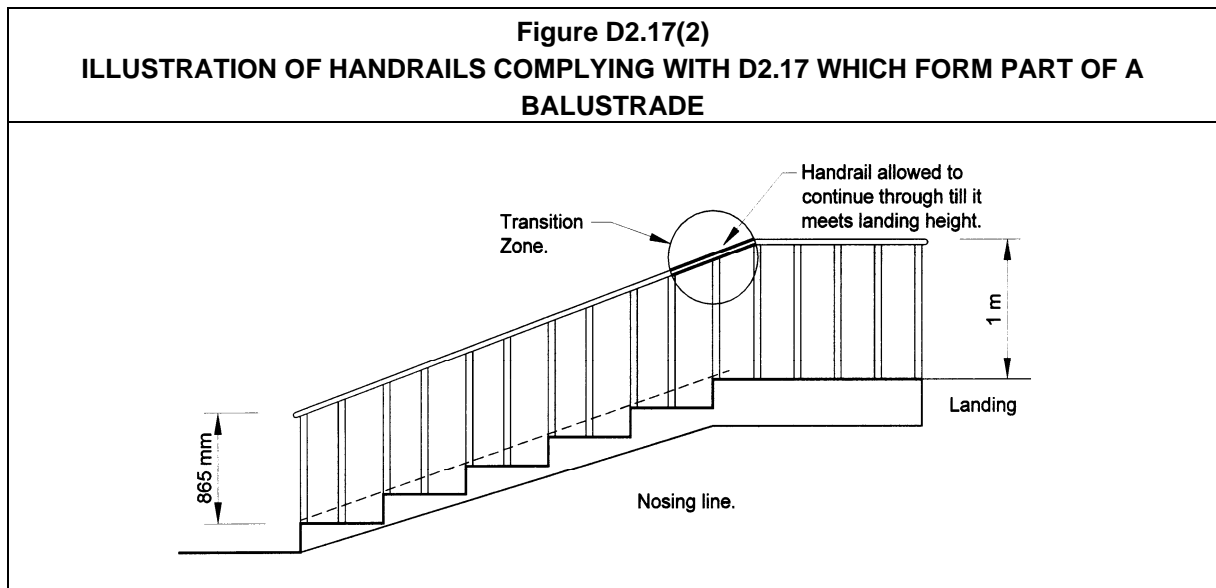

Figure D2.17(2) illustrates the use of handrails complying with D2.17.



D2.18 Fixed platforms, walkways, stairways and ladders

Intent

To provide appropriate access and egress from infrequently used areas.

Reasons for different requirements

Some areas are only accessed by maintenance or specialist workers. In such areas, access and egress requirements for members of the public no longer apply, and the requirements are permitted to fall outside the various measurements applying elsewhere.

In Class 2 buildings or Class 4 parts, this includes non-habitable rooms such as attics, storerooms and the like that are not used on a frequent or daily basis. In such cases, the designer has the choice of designing the stair, landing, balustrade or other barrier and handrail to comply with the appropriate provisions of the BCA or with AS 1657.

D2.19 Doorways and doors

Intent

To minimise the risk that a door may obstruct a person evacuating.

D2.19 and D2.20 have the same intent

D2.19 should be read in conjunction with D2.20 because its intent is the same.

Aged care buildings — D2.19(a)

D2.19(a) applies to all doorways in resident use areas of Class 9c aged care buildings, including doorways in paths of travel to an exit, doorways serving as required exits and doorways forming part of required exits.

Doorways within resident use areas of an aged care building must not be provided with revolving doors, roller shutter doors, tilt up doors or sliding fire or smoke doors. These types of door can impede the movement of residents and also hinder egress from the building.

Required exits and patient care areas

D2.19(b) applies only to doorways serving as a required exit, or forming part of one, and to doorways in a patient care area of a Class 9a building.

D2.19(b) does not apply to any other doorways (eg a doorway within a path of travel to an exit).

Revolving, sliding or tilt-up doors and roller shutters — D2.19(b)(i), (ii) and (iii)

Under **D2.19(b)(i), (ii)** and **(iii)**, revolving, sliding or tilt-up doors and roller shutters are either prohibited or limited because of their potential to obstruct people evacuating. They can also pose problems if they fail in an emergency.

If people are impeded at a doorway, this can lead to congestion. In an extreme case, it can lead to the crushing of people as they wait for a door to open.

Concession for small Class 6–8 buildings — D2.19(b)(ii)(A)

The reason for the concession (subject to specified criteria) for roller shutters or tilt-up doors in small Class 6, Class 7 and Class 8 buildings is that the number of people in the area will be low. Note that this concession does not apply to revolving or sliding doors.

Power-operated doors — D2.19(b)(iv)

D2.19(b)(iv) sets out the requirements for power-operated doors in required exits and patient care areas.

Sliding door opening force

The reference in **D2.19(b)(iii)(B)** and **(iv)(A)** to a force of 110 newtons is to a relatively small force which most people, including the elderly and the young, could reasonably be expected to use to open a door.

D2.20 Swinging doors**Intent**

To minimise the risk that a door may obstruct a person evacuating.

D2.20 and D2.19 have the same intent

D2.20 should be read in conjunction with **D2.19** because its intent is the same.

Required exits

D2.20 applies only to swinging doors in doorways serving as a required exit or forming part of a required exit (eg a doorway leading to, or within a fire-isolated exit). It does not apply to other doorways (eg a doorway within a path of travel to an exit).

Egress and the swing of a door — D2.20(a)

Under **D2.20(a)**, egress from a required exit must not be impeded by the swing of a door.

The measurement of the clear width for the safe passage of people evacuating must include any door furniture, such as a door handle.

Doors into a fire-isolated exit are permitted to encroach more than 500 mm as long as they do not impede the path of travel of people already in the exit.

Figure D2.20 illustrates a method of compliance with **D2.20(a)**.

Door must swing in the direction of egress — D2.20(b)

Under **D2.20(b)**, doors are required to swing in the direction of egress to aid evacuation. If a door swings against the direction of egress, the first person to it may not be able to open it because of the pressure of the other people behind them. This could delay evacuation.

Concession for small buildings or parts of buildings

D2.20(b) provides a concession (under specified criteria) for small buildings or parts of buildings. The reason for allowing a door to swing against the direction of travel in such

SUPERSEDED

SECTION D – ACCESS AND EGRESS

Australian Building Codes Board

SUPERSEDED

buildings is because the number of people likely to use the door will probably be low. This in turn minimises the risk caused by delays induced by opening a door towards the person attempting to gain egress.

Hindrance — D2.20(c)

Under D2.20(c), swinging doors must not hamper occupants evacuating.

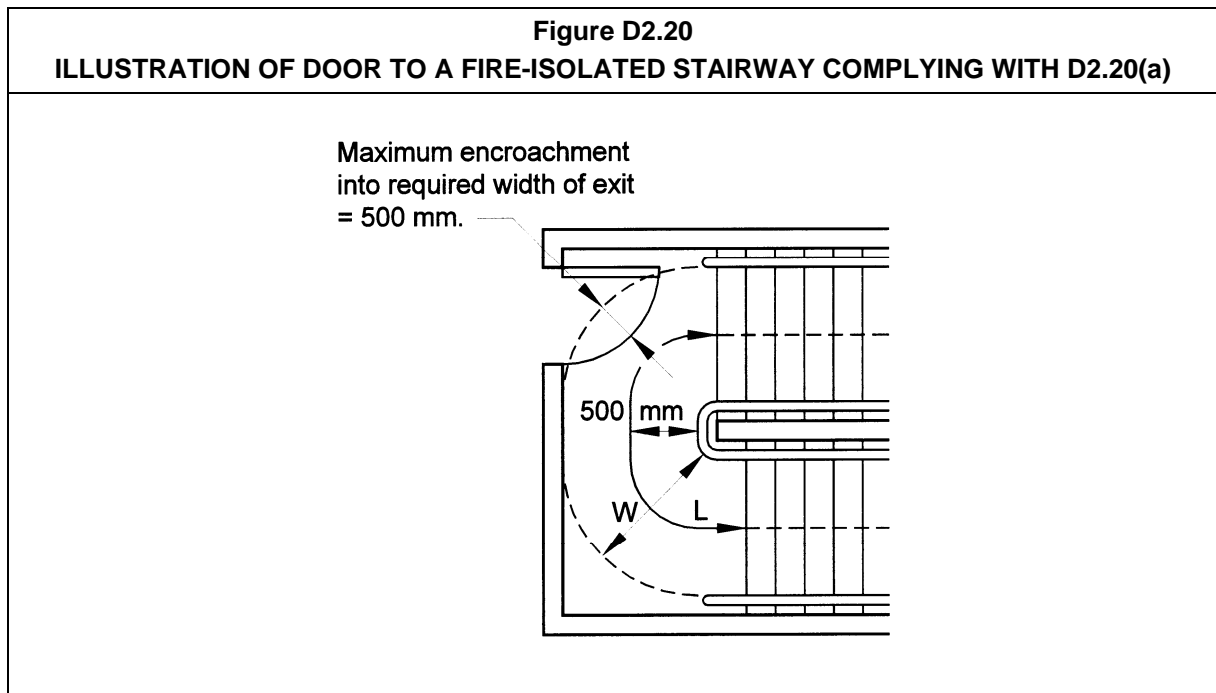

D2.21 Operation of latch

Intent

To minimise the risk that evacuation will be delayed by the operation of a door latch.

Application

D2.21 applies to all doors:

- in a required exit (eg an external doorway leading from the building);
- forming part of a required exit (eg a door leading to or within a fire-isolated exit); and
- in a path of travel to a required exit.

‘Single hand downward action’

If the opening action of a door latch cannot be a pushing action, it must be a single downward action, capable of being activated with a single hand.

D2.21 prohibits the use of devices such as deadlocks and knobs (where the knobs must be operated in a twisting or similar motion).

This provision takes account of the need for an emergency opening mechanism to be operable by people with a hand or arm related disability, burns to their hands, or with perspiring or wet hands.

Ease of egress versus security

The building regulatory system principally exists to protect the safety, health and amenity of people in buildings. The safety of property, while important, is generally considered to be a secondary matter. **D2.21** is designed to maximise the safety of people and prevent them being trapped within a building during a fire.

The risks to people using the building are too great to allow for the use of property security devices, such as deadlocks. Even ‘after hours’ locks, which require human intervention (such as unlocking first thing in the morning and locking last thing at night) to allow egress during times when the public are accessing the building, are not considered to be adequately safe.

D2.21 exceptions

There are several exceptions to **D2.21**. These include:

- **D2.21(a)** — strongrooms and vaults, both for security purposes, and the fact that the general public would ordinarily be very unlikely to access such places;
- **D2.21(b)(i)** — sole-occupancy units within flats, motels or hotels, because the people in the units will generally be in possession of keys to unlock the door;
- **D2.21(b)(ii)** — small sole-occupancy units in Class 5-8 buildings, where it would be difficult to overlook the presence of anyone at closing time; and
- **D2.21(b)(iii)** — restricted access spaces and rooms otherwise inaccessible to people at all times, such as cleaners’ rooms and the like.

Special security arrangements — D2.21(c)

D2.21(c) provides for special arrangements to be made where particular security issues arise. If this option is taken, the appropriate authority will need to be satisfied that:

- special arrangements for security are required; and
- the unlocking arrangements are satisfactory and, in the event of an emergency, access to exits will be enabled immediately, with effectively no time delay.

Where the option for human control is exercised under **D2.21(c)(ii)**, the person controlling the unlocking system **MUST** be available at ALL times. It is not acceptable for the system to be

left uncontrolled. Nor is it acceptable for that person to be absent from the control post while carrying out any other work duties. A beeper or some other type of personally carried device warning of an emergency is not adequate to effect immediate opening of the locked doors. If

the controlling person is absent for any reason, there must be a process enabling their relief by an equally trained person.

Examples

Some examples of when the **D2.21(c)** option may be chosen include establishments where egress must be controlled, such as:

- the secure parts of a bank;
- a prison;
- a psychiatric institution; and
- a special accommodation house, or an institution which may have residents who may be inclined to ‘wander’. However, it is noted in this latter example, that it may also be decided to follow the fail-safe device option in **D2.21(d)**.

Fail-safe devices — **D2.21(d)**

D2.21(d) provides an exemption for buildings fitted with automatic ‘fail-safe devices’, where the devices are activated by another active system.

In this case, the appropriate authority must be satisfied that:

- the device is genuinely ‘fail-safe’ (while not specifically referenced in **D2.21(d)**, this would include during power failures); and
- in the event of an emergency, access to exits will be enabled immediately, with effectively no time delay.

Examples

After hours shop security may be of considerable importance, and a ‘fail-safe’ option may be preferable to the alternative.

A special accommodation house or an institution may have residents who may be inclined to ‘wander’, and a ‘fail-safe’ option may be preferable to the alternative.

D2.21 and Class 9b buildings — **D2.21(e)**

Egress from Class 9b buildings is a complex issue. They are often accessed by the general public, and include buildings which have people unfamiliar with their surroundings. This environment is not conducive to orderly or easy evacuation especially in places such as cinemas, theatres, sporting complexes and nightclubs.

D2.21(e) makes special provision for those which accommodate more than 100 people.

D2.21(e) differs from the usual **D2.21** provisions in that:

- it prohibits the use of a door handle type opening device (other than a bar) or other device (including levers or knobs) requiring more than a pushing action; and
- it applies to only one door leaf of a two-leaf door set. However, the other door must also swing open if it is needed to satisfy the required width of egress.

The provisions of **D2.21(e)** do not apply to schools, early childhood centres, or buildings such as churches, mosques and temples used for religious purposes.

Schools and early childhood centres are excepted because:

- the occupants are under almost constant adult supervision;
- most schools have a communication system with which occupants are familiar;
- most occupants are adequately controlled enabling easier evacuation; and
- they are used during daylight hours, and door handles and their function are more easily identified and familiar to occupants.

Height of opening devices

The height from the floor specified in **D2.21** is for the location of opening devices originated in AS 1428 'Design Rules for Access by the Disabled'. This is a comfortable height for most people to use.

Testing of fire door furniture

Required fire doors must be tested as a complete unit, including the frame and furniture. The test on a fire door installed in an exit, or forming part of an exit, includes the opening devices to be used to comply with **D2.21**.

D2.22 Re-entry from fire-isolated exits

Intent

To minimise the risk that a person becomes trapped in a fire-isolated exit.

Facilitate entry to another exit route

It is not unknown for a fire-isolated exit to become unusable during an emergency. In high-rise buildings, hospitals and Class 9c aged care buildings people must be able to leave the exit and proceed to an alternative exit to evacuate. It is unlikely that the second exit will also be unusable. One option is for a person in a fire-isolated stairway to enter a storey and gain access to the alternative exit through that storey.

Mistaken entry

Under normal conditions of use, it is also possible that a person may mistakenly enter a fire-isolated exit. That person should not be required to travel all the way down the stairway to be able to leave it, especially in a high-rise or Class 9c aged care building.

Every fourth storey re-entry

The ability to enter at each floor of a building could be unnecessary and lead to a breach of a building's security. Accordingly, entry at every fourth floor (under **D2.22(b)(i)**) will achieve the intent of this provision, without significantly interfering with the building's security. Where this option is taken, all doors must be openable by a fail-safe device activated by a fire alarm.

Intercommunication systems

An alternative method of minimising the risk of a person being trapped in a fire-isolated stairway is to provide an intercommunication system under **D2.22(b)(ii)**. Where this option is taken, all doors must be openable by a fail-safe device activated by a fire alarm.

D2.23 Signs on doors

Intent

To require the use of signs warning against impairing certain doors.

Blocked doors

The doors referred to in **D2.23(a)** are all required for evacuation in an emergency. Their obstruction could result in the death of people attempting to evacuate.

Open doors

Fire and smoke doors are designed to minimise the risk to people inside a fire compartment and a fire-isolated exit. A door kept open in a storey experiencing a fire could result in the emergency exit becoming unusable, or could aid the spread of fire and/or smoke to other parts of the building. If all exits are affected, people will have no way of evacuating the building.

PART **D3** ACCESS FOR PEOPLE WITH DISABILITIES

BCA access provisions

Part **D3** comments relate solely to BCA compliance matters. They do not relate to any other legislation, including the Federal *Disability Discrimination Act 1992 (DDA)*.

Objective

Functional Statements

Performance Requirements

The Objective, Functional Statements and Performance Requirements for **Section D** precede Part **D1**.

Deemed-to-Satisfy Provisions

D3.0 Deemed-to-Satisfy Provisions

Intent

To clarify that the requirements of **DP1 to DP9** will be satisfied if compliance is achieved with Parts **D1**, **D2** and **D3** in the case of all buildings, Part **G3** in the case of buildings with an atrium, and Part **H1** in the case of theatres, stages and public halls.

See comments under **D1.0**. They apply here.

D3.1 Application of Part

Intent

To clarify that Part D3 applies only to Class 3, Class 5–9 and some Class 10a buildings.

Part D3 applies only to Class 3, Class 5–9 and some Class 10a buildings. This is one of the few times Volume One of the BCA applies to Class 10 buildings.

D3.2 General building access requirements

Intent

To specify when access for people with disabilities must be provided.

Where access begins

As set out in D3.2(c), access for people with disabilities is required where people approach the building or the associated accessible carpark. Such a carpark may be external to, or within, the building.

Extent of access within buildings

D3.2(c)(iv) requires that access must be provided through the principal public entrance.

Access must be provided to all places in a building normally used by the occupants. This includes facilities such as toilets and the like specifically designed for use by people with disabilities, common areas and some sole-occupancy units of Class 3 buildings and all floors where vertical access means are provided. This would cover most areas in Class 5 to Class 9 buildings.

Example

A school has two science laboratories, one on the ground floor and the other on the first floor:

- The BCA requires that the laboratory on the ground floor be accessible.
- The laboratory on the first floor only needs to be accessible if vertical access or a passenger lift is provided to the first floor.

In addition to the BCA requirements, all required access must comply with AS 1428.1.

The BCA does not have provisions regarding access to Class 2 buildings for people with disabilities.

Class 3 buildings

In a Class 3 building, **Table D3.2** requires access specifically to and within:

- common areas, which are defined in the note to the table;
- a percentage of sole-occupancy units depending on the total number of sole-occupancy units in the building; and
- areas used for accommodation other than in sole-occupancy units.

Access need not be provided if less than 10 people are accommodated other than in sole-occupancy units. The maximum number of accessible beds required is six. In these cases, any bed, including a queensize or kingsize bed, is counted as one bed.

Example

A boarding house contains 50 sole-occupancy units. The number of accessible sole-occupancy units for people with disabilities in accordance with **Table D3.2**, would be as follows:

- Two accessible sole-occupancy units are required for the first 45 sole-occupancy units.
- One accessible sole-occupancy unit is required for each additional 30 units or part thereof that are additional to the first 45 sole-occupancy units. Therefore, one additional accessible sole-occupancy unit is required for the remaining 5 units.

The total number of accessible sole-occupancy units required is 3.

Class 4 part of a building

The BCA does not have provisions regarding access to Class 4 parts of buildings for people with disabilities.

Class 9a health-care buildings

Table D3.2 requires access to be provided to and within all areas of a Class 9a building normally used by the occupants, including patients.

Class 9b assembly buildings

In an assembly building, other than a school or early childhood centre, **Table D3.2** requires access to every auditorium, through the main entrance of the auditorium (but not to every tier of seating) and to all areas normally used by the occupants. If the auditorium contains a number of levels then access need not be provided to all levels but spaces provided must be distributed as equitably as practical. Access is also required to the stage for performances, presentations etc.

Class 9b school buildings

In a school, **Table D3.2** requires access to be provided to and within:

- all areas normally used by the occupants including staff and visitors if no other similar facility is accessible; and
- all floors provided with a ramp suitable for people with disabilities or a passenger lift.

In an early childhood centre, **Table D3.2** requires access to be provided to and within all areas normally used by occupants including staff and visitors.

Class 9c aged care buildings

Table D3.2 includes specific access requirements for Class 9c aged care buildings. The requirements are consistent with those required for Class 3 buildings.

Class 10a buildings

Where the BCA requires sanitary and other facilities to be provided, they do not necessarily have to be in the subject building. It is possible to provide them in an adjacent Class 10a building.

When the BCA requires such facilities to be suitable for people with disabilities, **Table D3.2** specifies that access to the facilities must be suitable for those people.

Example

In the case of a school:

- **F2.4**, particularly **Table F2.4**, requires sanitary facilities for people with disabilities to be provided.
- These facilities need not be located in the main school building. They can be provided in a separate toilet block, which the BCA classifies as a Class 10a building.
- In such a case, **Table D3.2** requires that the access to the facilities be suitable for people with disabilities.

Access is also required to Class 10a buildings containing a unique feature. This is not intended to include normally unoccupied buildings such as those used for storage, but is intended to cover buildings like sun and rain shelters, rotundas and the like.

D3.3 Parts of buildings to be accessible

Intent

To specify which parts of a building must be accessible.

D3.3 only applies to buildings required to be accessible under **Table D3.2**.

Sanitary compartments

D3.3(a)(i)(A) requires sanitary compartments provided for people with disabilities to be accessible.

Areas to be accessible

D3.3(a)(i)(B) requires areas used by occupants in their normal activities to be made accessible for people with disabilities. However some exemptions are permitted, due to the nature of the work undertaken in them.

Ramps and stairways

Under **D3.3(a)(ii)**, where any building is required to provide access for people with disabilities to the entrance floor (but not to the other floors), and a passenger lift is not provided to the upper floors:

- if a ramp is provided, the handrails must comply with Clause 5.3(e) of [AS 1428.1](#).
- if a stairway is provided, it must comply with Clause 9 of [AS 1428.1](#).

Clause 9 of [AS 1428.1](#) requires the stairway to be provided with a 50 - 75 mm wide colour contrasting strips on the tread nosing and the risers to be of opaque construction. The former is to assist vision impaired people to distinguish the edge of each step because the stairway may appear as a ramp or flat surface to them. The latter is to help people who have difficulty seeing the stairs because they see through open risers rather than focus on the risers and treads themselves.

Lift requirements

The requirements for lifts in **D3.3(a)(iii)** only cover some essential features related to the lift car.

Impediments to a wheelchair

A path of travel which is required to be accessible must not be impeded by any barrier or the like to wheelchair access.

Compliance with [AS 1428.1](#)

D3.3(c) lists a wide range of elements and building parts which must comply with [AS 1428.1](#).

D3.4 Concessions

Intent

To provide concessions to the Deemed-to-Satisfy Provisions for access by people with disabilities.

D3.4 outlines several concessions (under specified circumstances) to the **Deemed-to-Satisfy Provisions** regarding access for people with disabilities.

The inappropriate areas concession

The concession for inappropriate areas in **D3.4(d)** is intended to cover those areas to which access is not required as part of either a person's work duties, or a right of entry similar to that in **D3.3(a)(i)(B)**. These areas could include lift and air conditioning shafts, roof tops and possibly some industrial situations. Assessment of these areas is on a case by case basis.

D3.5 Carparking

Intent

To clarify the minimum Deemed-to-Satisfy Provisions for carparking for people with disabilities.

D3.5 specifies the number and design (by reference to [AS 2890 Part 1](#)) of carparking spaces for the use by people with disabilities.

The carparking requirements for people with disabilities are based on equity. If the building provides certain facilities for occupants of the building, the same facilities should be provided for people with disabilities if the building is required to be accessible. Carparking is no different with the exception specified under **D3.5(b)**, where a parking (valet) service is exclusively provided.

This clause and **Table D3.5** only require carparking spaces for people with disabilities, if carparking is provided for the building. That is, if carparking is not provided for the building then there is no requirement to provide carparking spaces for people with disabilities regardless of whether access for people with disabilities is required to be provided to the building per **D3.2**.

Table D3.5 specifies the ratio of carparking spaces for people with disabilities in relation to the total number of carparking spaces provided. Note that the table specifies a Class of building to which the carpark or carparking area is associated. If a Class 7 carpark is associated with a building of another Class (eg. Class 5 office) and the carpark is intended to provide exclusive parking for the occupants of that other Class, it is that Class (eg. Class 5 office) in **Table D3.5** that is used to determine the number of carparking spaces for people with disabilities.

The criteria for determining the number of carparking spaces for people with disabilities in accordance with **Table D3.5**, ie. 1 in 100 or 1 in 50, relates to whether there is a level of certainty to which occupant numbers can be determined. For example, the number of occupants for a Class 5, 7 or 8 building can be determined with a high level of certainty and therefore 1 space for every 100 carparking spaces or part thereof is required.

In the case where the occupant numbers can be determined with a lesser level of certainty, a higher carparking ratio is required. This is usually in the case of buildings visited by the public such as Class 6 shopping centres or Class 9b assembly buildings where there is a higher use and wider range of people with varying degrees of disabilities.

Table D3.5 distinguishes two areas of a hospital, namely outpatient and non-outpatient areas. A hospital outpatient area and a clinic or day surgery not forming part of a hospital are buildings, or parts of a building, where the patients are treated but do not stay overnight. A hospital non-outpatient area is where people go to have medical treatment which involves overnight accommodation.

Example

A major shopping centre building is a mixture of Class 6 shops, Class 5 offices and a Class 7 basement carpark. **Table D3.2** requires access for people with disabilities to be provided. The basement carpark contains a total of 1450 carparking spaces.

Of the 1450 total carparking spaces provided, 180 are for the exclusive use of office workers, with the remaining 1270 available for use by the shopping centre.

The number of carparking spaces required for people with disabilities would be as follows:

- The total number of carparking spaces for the Class 5 office is 180. **Table D3.5** requires 1 carparking space for people with disabilities for every 100 spaces or part thereof. Therefore, the number of carparking spaces for people with disabilities for the office part of the building is 2.
- The total number of carparking spaces for the Class 6 part of the shopping centre is 1270. **Table D3.5** requires:
 - 1 carparking space for people with disabilities for every 50 spaces or part thereof for the first 1000 spaces. The number of carparking spaces required for people with disabilities for the first 1000 is 20.
 - 1 carparking space for people with disabilities for every 100 spaces or part thereof in excess of 1000 spaces. The number of carparking spaces required for people with disabilities for the remaining 270 spaces is 3

The total number of carparking spaces required for people with disabilities for the Class 6 part of the shopping centre is 23.

The total number of carparking spaces required for people with disabilities for the whole building is 23 (Class 6) + 2 (Class 5) = 25.

Example

A motel has a total of 85 sole-occupancy units. **Table D3.2** requires access for people with disabilities to be provided to 4 of the sole-occupancy units. On the allotment, an open carparking area containing a total of 30 carparking spaces is provided for the exclusive use of the residents of the motel. There is no valet service provided. **D3.5(a)(ii)** specifies that carparking spaces for people with disabilities must be provided in accordance with **Table D3.5**.

The number of carparking spaces required for people with disabilities would be as follows:

- The total number of sole-occupancy units is 85.
- The total number of accessible sole-occupancy units is 4.
- The percentage of accessible sole-occupancy units to the total number of sole-occupancy units is $4/85 \times 100 = 4.7\%$.
- The total number of carparking spaces is 30.
- The number of carparking spaces for people with disabilities is $30 \times 4.7\% = 1.41$.

Therefore the number of carparking spaces for people with disabilities is 2.

Note: If the motel did not provide any carparking for its residents then there is no requirement to provide carparking spaces for people with disabilities.

D3.6 Identification of accessible facilities, services and features

Intent

To assist people with disabilities to identify the facilities, services and features provided in a building.

There is little point in providing or requiring access to facilities, services and features if it is not possible to easily find them. Accordingly, **D3.6** requires that such facilities, services and features and necessary paths of travel to the main means of movement for the building, including entrances and lifts, be adequately identified by the use of the Braille and tactile signage and symbols.

D3.6 refers to **Specification D3.6** for details on the design and installation of Braille and tactile signage, and to [AS 1428.1](#) for appropriate symbols.

Tactually readable information and signage is comprised of protruding letters or symbols that can be recognised by touch and, in the case of Braille, is comprised of raised dots that enable a person to interpret the protrusions by passing fingers over them. Braille is a particular form of tactile information.

Generally, the location and number of Braille and tactile signs required by **D3.6** should be the same as for signs provided for occupants without vision impairment.

D3.7 Hearing augmentation

Intent

To assist people with a hearing impairment to be made aware of communications associated with a building's use.

D3.7 generally applies when the area already has, or is proposed to have, an inbuilt amplification system or a means of making venue announcements, such as a scoreboard. An example of a hearing augmentation system is what is called a 'hearing loop'.

The hearing augmentation system can be by portable equipment. However, if the amplification system is built-in, the augmentation system should also be built-in.

Where augmentation is built into an auditorium, it should cover a reasonable range of seating positions. It is not desirable to cover the entire auditorium, as it is claimed that some hearing augmentation systems can adversely affect some people.

It is also important to note that it does not apply to an inbuilt communication system used only for emergency warning purposes. This would include emergency warning and intercommunication systems installed for emergency purposes.

D3.8 Tactile indicators

Intent

To assist blind or vision impaired people to avoid hazardous situations.

D3.8 requires tactile ground surface indicators in hazardous locations. It also permits raised dome buttons on handrails as an alternative in some aged care buildings. The reason for the alternative in aged care buildings is that ground surface indicators may hinder people using walking frames or the like. It also excludes tactile indicators for kerb and step ramps because of the danger of slipping on tactile surfaces on a slope.

**SPECIFICATION D1.12 NON-REQUIRED STAIRWAYS,
RAMPS AND ESCALATORS**

Deemed-to-Satisfy Provisions**Specification D1.12**

This Guide does not address every provision in this Specification. However, there are more comments which should be made:

Purpose of Specification D1.12

Specification D1.12 establishes requirements for the construction and installation of stairways, ramps and escalators not required by the BCA, and which are not fire-isolated. These requirements aim to prevent the spread of fire through an unrestricted number of floors through unprotected openings for stairways, ramps and escalators.

Consistency with atrium requirements

Specification D1.12 is consistent with the provisions of Part **G3**, which, without imposing additional requirements, allows an atrium to connect two non-sprinkler protected storeys or three sprinkler protected storeys.

Need for fire shaft

There does not yet appear to be a practical method of applying this Specification without the construction of a fire shaft. Such a shaft provides the necessary fire separation between the floors. Its construction is similar to that of a fire-isolated stairway shaft.

SPECIFICATION **D3.6** BRAILLE AND TACTILE SIGNS

Deemed-to-Satisfy Provisions

1 Scope

Intent

To clarify that **Specification D3.6** provides the design and installation details for Braille and tactile signs.

2 Braille and Tactile signage

2.1 Location of Braille and tactile signs

Intent

To set out the appropriate locations for Braille and tactile signs depending on the layout of the sign and its purpose

It is important to note that signage is only required to be visible from the entrance of the building where the feature or facility is not apparent to the occupants. If more than one principle entrance is provided, such as in a large shopping centre, the Braille and tactile signage should be provided from all entrances.

The minimum and maximum heights specified for signs and/or lines of characters are to ensure that they are installed at a height that is convenient for people in either a seated position, such as when in a wheelchair, or standing position. The positioning also assists people with low vision to read the information on the sign.

To ensure that signs can be read, it is important that there are no obstructions near them such as furniture, plants, display stands, etc.

In respect of signs identifying rooms containing features or facilities, **Clause 2.1(c)** provides 3 options depending on the configuration of the room's doorway and surrounds. Where sufficient space exists, the sign should be positioned on the wall, in the preferred location, on the latch side of the door. This location is the most convenient and safest option because, if the door swings towards the sign, it is less likely to strike a person reading the Braille or tactile text.

However, it is recognised that it may not always be possible to locate the sign in the optimum position. The second preference is to locate the sign on the wall on the non-latch side of the door. The third preference is to locate the sign on the door itself if insufficient space exists on either the latch or non-latch side of the door. The latter could occur where a doorway is at the end of a corridor with no return walls on either side of the doorway.

In respect of signs identifying paths of travel, locations are specified in **Clause 2.1(c)** that allow directional decisions to be taken before a change in direction occurs. **Figure D3.6** illustrates acceptable locations of signs identifying paths of travel.

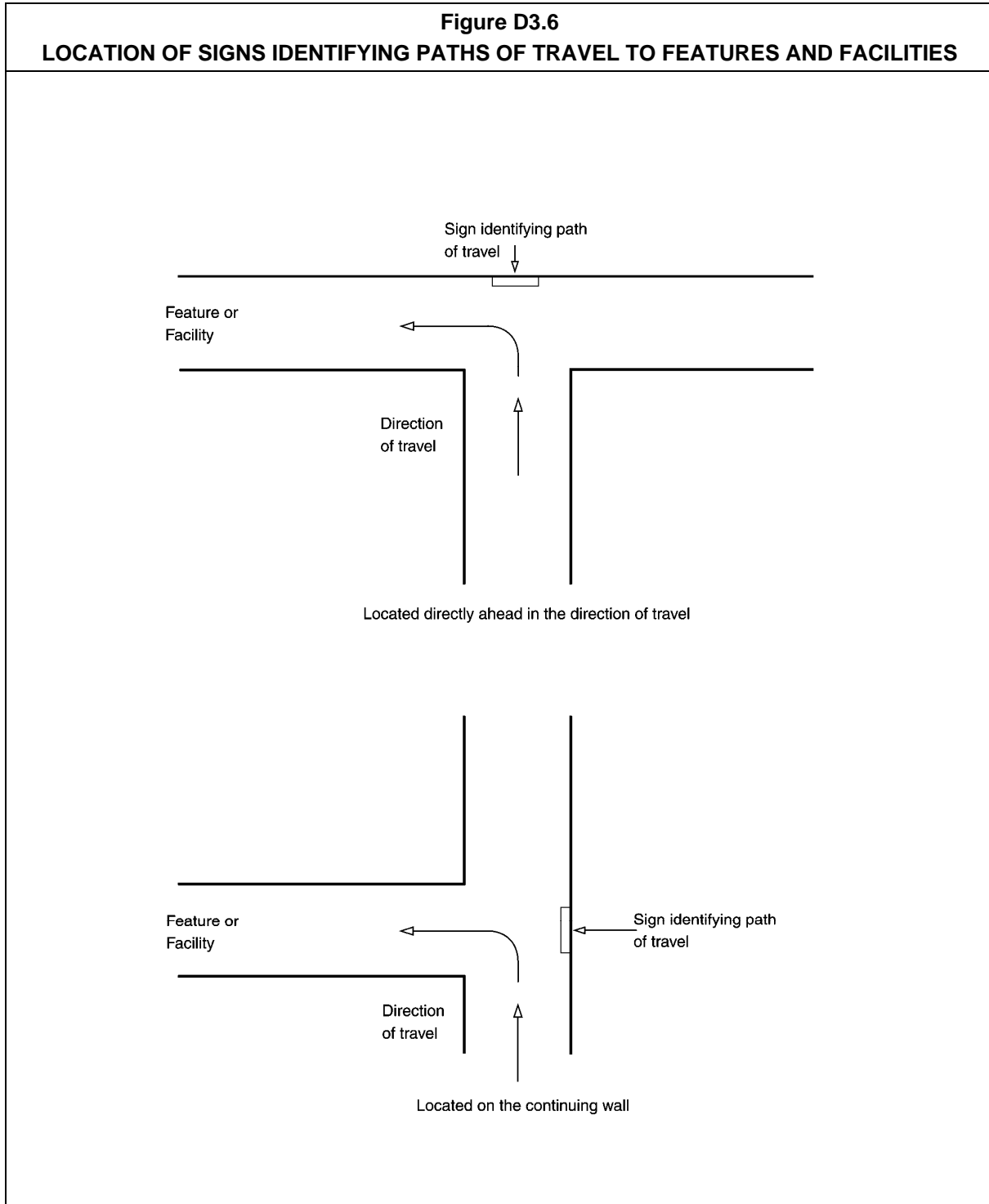

2.2 Braille and tactile sign specification

Intent

To set appropriate specifications for Braille and tactile signs for the purpose of standardising signs to facilitate ease of use, safety and hygiene in use.

To assist people when reading the sign, minimum size, etc. of lettering and Braille are specified. This also assists in ensuring consistency between signs.

Safety and hygiene are important because of the tactile nature of the sign. All edges of a sign are required to be rounded to prevent injury and the surface of the sign is to be continuous to allow cleaning for hygiene purposes.

2.3 Luminance-contrast

Intent

To set out the luminance-contrast required for Braille and tactile signs.

Clause 2.3 sets out the luminance-contrast required by [AS 1428.1](#) for Braille and tactile signs. The luminance-contrast must be achieved during the differing conditions when the sign needs to be read.

2.4 Lighting

Intent

To require sufficient illumination of a sign to be available during the times that the sign needs to be read.

Braille and tactile signs are not required to be individually illuminated if sufficient general illumination is available to achieve the required luminance-contrast. Sufficient illumination is required to assist people with low vision to read the sign.

2.5 Braille

Intent

To set out requirements for Braille to be used on signs.

More than one type of Braille exists. **Clause 2.5** standardises the type of Braille to be used in signs and specifies protocols for its use to achieve consistency and ease of use.

SECTION **E**

SERVICES AND EQUIPMENT

- E1** **Fire Fighting Equipment**
- E2** **Smoke Hazard Management**
- E3** **Lift Installations**
- E4** **Emergency Lighting, Exit Signs and Warning Systems**

SECTION E CONTENTS

	Page
Part E1 Fire Fighting Equipment	13,021
Objective EO1	
Functional Statement EF1.1	
Performance Requirements EP1.1 — EP1.6	
E1.0 Deemed-to-Satisfy Provisions	
E1.1 *****	
E1.2 *****	
E1.3 Fire hydrants	
E1.4 Fire hose reels	
E1.5 Sprinklers	
E1.6 Portable fire extinguishers	
E1.7 *****	
E1.8 Fire control centres	
E1.9 Fire precautions during construction	
E1.10 Provision for special hazards	
Specification E1.5 Fire Sprinkler Systems	
Specification E1.8 Fire Control Centres	
Part E2 Smoke Hazard Management	13,451
Objective EO2	
Functional Statement EF2.1	
Performance Requirements EP2.1 — EP2.2	
E2.0 Deemed-to-Satisfy Provisions	
E2.1 Application of Part	
E2.2 General requirements	
E2.3 Provision for special hazards	
Specification E2.2a Smoke Detection and Alarm Systems	
Specification E2.2b Smoke Exhaust Systems	
Specification E2.2c Smoke-and-Heat Vents	

	Page
Part E3 Lift Installations	13,901
Objective EO3	
Functional Statements EF3.1 — EF3.3	
Performance Requirements EP3.1 — EP3.4	
E3.0 Deemed-to-Satisfy Provisions	
E3.1 * * * * *	
E3.2 Stretcher facility in lifts	
E3.3 Warning against use of lifts in fire	
E3.4 Emergency lifts	
E3.5 Landings	
E3.6 Facilities for people with disabilities	
E3.7 Fire service controls	
E3.8 Aged care buildings	
Part E4 Emergency Lighting, Exit Signs and Warning Systems	14,001
Objective EO4	
Functional Statement EF4.1	
Performance Requirements EP4.1 — EP4.3	
E4.0 Deemed-to-Satisfy Provisions	
E4.1 * * * * *	
E4.2 Emergency lighting requirements	
E4.3 Measurement of distance	
E4.4 Design and operation of emergency lighting	
E4.5 Exit signs	
E4.6 Direction signs	
E4.7 Class 2 and 3 buildings and Class 4 parts: Exemptions	
E4.8 Design and operation of exit signs	
E4.9 Emergency warning and intercommunication systems	

PART E1 FIRE FIGHTING EQUIPMENT**Objective****EO1****Fire in buildings**

If a fire occurs in a building it must not endanger evacuating occupants or spread to another building.

Facilities to fight a fire in its early stages

Simple and lightweight equipment allows occupants to attack a fire during its early stages. Provision of this equipment often helps occupants to either extinguish or limit the development of a fire before the fire brigade arrives.

Facilities to assist the fire brigade

To assist in stopping or limiting the spread of fire, facilities must be provided to assist the fire brigade.

Functional Statement**EF1.1****Suitable facilities to be installed**

Suitable facilities may need to be installed in a building to minimise the risk of fire spread to:

- enable occupants to evacuate;
- enable occupants and the fire brigade to fight the fire and for the fire brigade to undertake rescue operations;
- minimise the damage which could result from fire spreading to other parts of the building or other buildings.

Facilities may be manually or automatically operated, and include: fire hydrants; fire hose reels; sprinkler systems; portable fire extinguishers.

Buildings may incorporate a fire-control centre.

Performance Requirements**EP1.1****Fire hose reels**

Fire hose reels in buildings allow occupants to fight a fire. The fire may be in its infancy, and early control or extinguishment may reduce the hazard, allow more time for evacuation and prevent structural damage.

'To the degree necessary'

See the explanation of this term in **A1.7**.

Criteria for fire hose reels

As set out in **EP1.1**, fire hose reels must be installed when necessary, and be appropriate to a number of factors, including:

- the size of the fire compartment which is a measure of the size of any potential fire;
- the function of the building will affect the fire load in the building;
- the fire-safety systems which can affect the rate of fire spread (eg if a sprinkler system is installed in a building, it should extinguish the fire or reduce its growth rate); and
- the fire hazard which means the danger in terms of potential harm and degree of exposure arising from the start and spread of fire, and the smoke and gases generated by a fire.

Deemed-to-Satisfy Provisions

E1.4 provides a number of examples where fire hose reels must be installed if the proposal being considered involves a Building Solution which uses the Deemed-to-Satisfy Provisions.

Alternative Solutions

If an Alternative Solution is used, it may be appropriate to assess it using **E1.4** for guidance purposes. However, it is stressed that compliance with **E1.4** is not compulsory if alternative means can be found to satisfy the appropriate authority that the Performance Requirements will be achieved.

EP1.2**Fire extinguishers**

Fire extinguishers in buildings allow occupants to fight fires. Extinguishment may complete all the functions listed in **EP1.1** above.

Fire extinguishers should be located in plain view, along normal paths of travel and near exits where possible. They should not be located in hazardous places.

‘To the degree necessary’

This expression’s use in **EP1.2** indicates that the BCA recognises that not all buildings need fire extinguishers; and fire extinguishers are used for specific purposes, as set out in **AS 2444**. Any decision made in this context can extend to not requiring an item to be installed or a particular level of performance to be achieved, if that is the appropriate action to be taken.

Criteria for fire extinguishers

As set out in **EP1.2**, fire extinguishers must be installed when necessary, and be appropriate to a number of factors, including:

- the function or use of the building will affect the fire load in the building;
- the fire-safety systems in the building which can affect the rate of fire spread (eg if a sprinkler system is installed in a building, it should extinguish the fire or reduce its growth rate); and
- the fire hazard which means the danger in terms of potential harm and degree of exposure arising from the start and spread of fire, and the smoke and gases generated by a fire.

Deemed-to-Satisfy Provisions

Table E1.6 provides a number of examples where fire extinguishers must be installed if the proposal being considered involves a Building Solution which uses the Deemed-to-Satisfy Provisions.

Alternative Solutions

If an Alternative Solution is being used, it may be appropriate to assess it using **Table E1.6** for guidance purposes. However, it is stressed that compliance with **Table E1.6** is not compulsory if alternative means can be found to satisfy the appropriate authority that the Performance Requirements will be achieved.

EP1.3

Fire hydrants

The intent of installing a fire hydrant system is to provide adequate water, under sufficient pressure and flow, to allow the fire brigade to fight fires.

Under its Application provision, **EP1.3** only applies to buildings located in an area serviced by a fire brigade. This is primarily because the pressures and flows from a fire hydrant are such that hydrants should only be used by the fire brigade.

It is expected that designers will meet any special fire brigade requirements, which may cover such matters as the types of couplings and special flows and pressures to suit a particular nozzle.

‘To the degree necessary’

The use of the expression ‘to the degree necessary’ in **EP1.3** indicates that the BCA recognises that not all buildings need fire hydrants.

Any decision made in this context can extend to not requiring an item to be installed or a particular level of performance to be achieved, if that is the appropriate action to be taken.

Criteria for fire hydrant systems

As set out in **EP1.3**, a fire hydrant system must be installed when necessary, and be appropriate to a number of factors, including:

- the need to meet the requirements of the local fire brigade (because of the pressures and flows), fire hydrants should only be used by the fire brigade;
- the floor area of the building which is a measure of the size of any potential fire; and
- the fire hazard which means the danger in terms of potential harm and degree of exposure arising from the start and spread of fire, and the smoke and gases generated by a fire.

Deemed-to-Satisfy Provisions

E1.3 provides a number of examples where fire hydrants must be installed if the proposal being considered involves a Building Solution which uses the Deemed-to-Satisfy Provisions.

Alternative Solutions

If an Alternative Solution is used, it may be appropriate to assess it using **E1.3** for guidance purposes. However it is stressed that compliance with **E1.3** is not compulsory if alternative means can be found to satisfy the appropriate authority that the Performance Requirements will be achieved.

EP1.4

EP1.4 is not limited to sprinkler systems

A sprinkler system is only one type of automatic fire suppression system. **E1.4** is not limited to sprinkler systems. If it can be demonstrated that another automatic fire system can control the development and spread of a fire, it may comply with **EP1.4**. Its activation must be ‘automatic’ and must not depend on human intervention.

Life safety and fire suppression

Automatic fire suppression systems, such as sprinkler systems, are normally used in a building to contain and extinguish fire. When an automatic fire suppression system operates, it not only

controls or limits the fire development, but statistics show that, in most cases, the fire is extinguished before the fire brigade arrives at the building.

An automatic fire suppression system is regarded as part of a building’s life safety package because:

- if the system extinguishes the fire before it fully develops, the fire will not endanger the

EP1.4

occupants; and

- if the system limits or controls the spread of a fire, it allows occupants more time to evacuate to a safe place.

‘To the degree necessary’

The use of the expression ‘to the degree necessary’ in **EP1.4** indicates that the BCA recognises that not all buildings need an automatic fire suppression system.

Any decision made in this context can extend to not requiring an item to be installed or particular level of performance to be achieved, if that is the appropriate action to be taken.

Criteria for automatic fire suppression systems

As set out in **EP1.4**, an automatic fire suppression system, such as a sprinkler system, must be installed when necessary, and be appropriate to a number of factors.

When implementing, the likely size and intensity of a fire should be taken into consideration. This can be as measured by:

- the size of the fire compartment which is a measure of the size of any potential fire;
- the function or use of the building will affect the fire load in the building;
- the fire hazard which means the danger in terms of potential harm and degree of exposure arising from the start and spread of fire, and the smoke and gases generated by a fire; and
- the height of the building, because once a building gets above a certain height it becomes extremely difficult (and eventually impossible) for the fire brigade to undertake external rescue or fire-fighting from ladders and the like. The height also affects evacuation time.

Deemed-to-Satisfy Provisions

E1.5 provides a number of examples where a sprinkler system must be installed if the proposal being considered involves a Building Solution which uses the Deemed-to-Satisfy Provisions.

Alternative Solutions

If an Alternative Solution to the Deemed-to-Satisfy Provisions in Part **E1** is being used, it may be appropriate to assess it using **E1.5** for guidance purposes. However, it is stressed that

compliance with **E1.5** is not compulsory if alternative means can be found to satisfy the appropriate authority that the Performance Requirements will be achieved.

EP1.5

Fire-fighting services in buildings under construction

A fire in a building under construction represents a significant public safety, health and amenity risk. Accordingly, there is a need for fire-fighting in such buildings.

This Performance Requirement recognises the fact that a significant number of fires occur in buildings during their construction or major refurbishment. Statistics indicate that a number of fires have been started by sparks. The fire has then spread because services were turned off for construction purposes.

‘To the degree necessary’

The use of the expression ‘to the degree necessary’ in **EP1.5** indicates that the BCA recognises that not all buildings need fire-fighting services during construction.

Any decision made in this context can extend to not requiring an item to be installed or a particular level of performance to be achieved, if that is the appropriate action to be taken.

Criteria for fire-fighting services in buildings under construction

As set out in **EP1.5**, fire-fighting services must be installed in buildings under construction when necessary, and must be appropriate to a number of factors, including:

- the fire hazard which means the danger in terms of potential harm and degree of exposure arising from the start and spread of fire, and the smoke and gases generated by a fire; and
- the height the building has reached during its construction which is a measure of the extent to which the fire brigade can fight any fire from the outside of the building.

Deemed-to-Satisfy Provisions

E1.9 provides a number of examples where fire-fighting services must be installed if the proposal being considered involves a Building Solution which uses the Deemed-to-Satisfy Provisions.

Alternative Solutions

If an Alternative Solution to the Deemed-to-Satisfy Provisions in Part **E1** is being used, it may be appropriate to assess it using **E1.9** for guidance purposes. However, it is stressed that

compliance with **E1.9** is not compulsory if alternative means can be found to satisfy the appropriate authority that the Performance Requirements will be achieved.

EP1.6**Fire control centres**

EP1.6 requires that a part of a building be set aside for the fire brigade to co-ordinate its search and rescue, and fire-fighting operations during a fire. These areas are referred to as ‘fire control centres’.

‘To the degree necessary’

The use of the expression ‘to the degree necessary’ in **EP1.6** indicates that the BCA recognises that not all buildings need a fire control centre.

Any decision made in this context can extend to not requiring an item to be installed or a particular level of performance to be achieved, if that is the appropriate action to be taken.

Criteria for co-ordination facilities

PART E1 – FIRE FIGHTING EQUIPMENT

As set out in **EP1.6**, co-ordination facilities must be installed when necessary, and be appropriate to a number of factors, including:

- the function or use of the building will affect the fire load in the building;
- the floor area of the building which is a measure of the size of any potential fire; and
- the height of the building which is a measure of the extent to which the fire brigade can fight any fire or carry out rescue operations from the outside of the building and the evacuation time.

Deemed-to-Satisfy Provisions

E1.8 provides a number of examples where a fire control centre must be installed if the proposal being considered involves a Building Solution which uses the Deemed-to-Satisfy Provisions.

Alternative Solutions

If an Alternative Solution to the Deemed-to-Satisfy Provisions in Part **E1** is being used, it may be appropriate to assess it using **E1.8** for guidance purposes. However, it is stressed that compliance with **E1.8** is not compulsory if alternative means can be found to satisfy the appropriate authority that the Performance Requirements will be achieved.

PART **E1** FIRE FIGHTING EQUIPMENT

Deemed-to-Satisfy Provisions

E1.0 Deemed-to-Satisfy Provisions

Intent

To clarify that the requirements of **EP1.1 to EP1.6** will be satisfied if compliance is achieved with **E1.1 to E1.10**.

E1.1 * * * * *

BCA 1990 excluded Class 1 and Class 10 buildings from Part **E1**. As Class 1 and Class 10 buildings are no longer covered in Volume One of the BCA this provision is no longer necessary. This is the reason why **E1.1** of BCA96 has been left blank.

E1.2 * * * * *

In BCA 1990, **E1.2** originally covered requirements for fire mains and water-supply services. With the introduction of Amendment 7 to BCA 1990 and the adoption of [AS 2419.1](#), these provisions were no longer necessary. Accordingly, **E1.2** was amended to be blank. This is the reason why **E1.2** of BCA96 has been left blank.

E1.3 Fire hydrants

Intent

To require the installation of suitable fire hydrant systems to facilitate the fire brigade's fire-fighting operations.

When required — **E1.3(a)**

Fire hydrants are needed to prevent the spread of fire between buildings and fire compartments. They are basically needed for fire brigade use and are not intended for use by occupants. Properly trained people and special equipment are needed for effective fire-fighting using a fire hydrant system.

The floor area of 500 m² referred to in **E1.3(a)(i)** represents the level of hazard which justifies the installation of a fire hydrant system.

If the building is in a remote area not serviced by a fire brigade, **E1.3(a)(ii)** allows it to be constructed without a fire hydrant system. The reason for this is that the fire hydrants are intended for use only by a fire brigade.

AS 2419.1 — E1.3(b)(i)

Under **E1.3(b)(i)**, the installation of a fire hydrant system, including the associated water supply, pipe work, pumps, and so on, must be in accordance with **AS 2419.1**. If any conflict exists between **AS 2419.1** and the BCA, then the BCA takes precedence. Additional information can be obtained by reference to the Standard, including an informative Appendix titled 'Guide to the Use of this Standard'.

AS 2419.1 provides the details for determining the number of fire hydrants required and where they should be located.

Location — E1.3(b)(ii)

Generally, **E1.3(b)(ii)** requires the installation of internal fire hydrants on the storey they are to service. The reason for this is to eliminate running a fire hydrant hose up or down a stairway. Also, if the sole-occupancy units are in different ownership or leasehold, access between them may be difficult.

E1.3(b)(ii) grants a concession when a sole-occupancy unit occupies more than one storey. The concession is conditional on the fire hydrant being located at the level of egress from the sole-occupancy unit.

In the case of a Class 2 or Class 3 building or a Class 4 part, there is no limitation on the size or number of storeys within the sole-occupancy unit which can be served by the fire hydrant.

For Class 5 to Class 9 buildings the concession is limited to sole-occupancy units with only two storeys, where the fire hydrant at the entrance level provides total hose coverage.

AS 2419.1 provides details of the required coverage.

Pumpsets — E1.3(b)(iii)

E1.3(b)(iii) sets out the criteria for on-site pumpsets. The need for a pumpset is based on compliance with the performance criteria within **AS 2419.1**.

Except as allowed by **E1.3(b)(iii)(C)**, the BCA requires two pumps. The basis for the concession for one pump, under **E1.3(b)(iii)(C)**, for buildings with an effective height of 25 metres or less is that the fire brigade is able to provide a workable backup to that height if the on-site pump should fail.

Options for the types of pump drivers are given with an emphasis on their reliability under fire conditions.

‘Direct egress to a road or open space’ — E1.3(b)(iv)(A)

E1.3(b)(iv)(A) requires that pumpsets inside a building must be in a room having ‘direct egress to a road or open space’. This enables fire brigade personnel to have quick access to the pumpsets and, if the need arises, to enable them to exit quickly.

When interpreting the expression ‘direct egress to a road or open space’, **D1.10(c)** requires that if an exit discharges to open space, which is at a different level from the public road to which it is connected, the path of travel to the road must be by a ramp or stairway complying with the BCA.

In the case of **E1.3(b)(iv)(A)**, the aim is to provide quick access and egress by fire fighters, if the need arises. For this purpose it would be reasonable to limit the stairway to one flight. If this approach is adopted, the landing and stairway must not expose a user to fire or smoke generated by a fire in the building. Care must be taken to make sure windows and other openings are correctly located, and that the external walls of the building have an appropriate FRL.

Unsprinkled building — E1.3(b)(iv)(B)

E1.3(b)(iv)(B) requires that if a building is not sprinkler protected, a fixed, on-site pumpset located within a building must be fire separated from the remainder of the building.

Pumpsets outside a building — E1.3(b)(v)

E1.3(b)(v) addresses the location and protection requirements for fixed on-site pumpsets located outside a building. These provisions are intended to allow for such matters as maintenance, weather protection, and protection from fire (particularly heat radiation).

Water source, pressures and flows — E1.3(b)(vi) and (vii)

E1.3(b)(vi) and **(vii)** identify the need for designers to implement any special fire brigade requirements. This may include:

- the types of couplings;
- special flows and pressures to suit a particular nozzle; and
- access for fire brigade vehicles.

E1.3(b)(vi) provisions for static water sources may refer to any adequate and reliable water source, including a dam, lake, tank, river or swimming pool. It is of good practice (and in some jurisdictions, compulsory) to consult with the fire brigade before selecting a static water source.

E1.4 Fire hose reels

Intent

To require the installation of suitable fire hose reel systems to enable, where appropriate, a building's occupants to undertake initial attack on a fire.

When required — E1.4(a)

Refer to **EP1.1** for the reasons why the BCA requires the installation of fire hose reels in buildings.

E1.4(a)(i) does not require the installation of fire hose reels in a Class 9c aged care building. It is recognised that occupants close to the point of ignition often provide the most effective means of extinguishing a small fire before it grows. In this case staff and visitors, if not some residents, can be effective in performing this function. To do so, they require appropriate means of extinguishment.

It is considered that the provision of portable extinguishers in an aged care building provides adequate means for staff and visitors to attack the fire. The additional level of fire safety associated with the provision of fire hose reels is not considered necessary.

It is not expected that the number of staff available in an aged care building will be adequate to both fight a growing fire with fire hose reels and evacuate residents. This is particularly the case when it is noted that the BCA provisions for aged care buildings are based on minimum staffing levels. When a fire becomes too large to be attacked with portable extinguishers, staff will be fully involved in closing doors and evacuating residents rather than fighting the fire.

E1.4(a)(ii) does not require the installation of fire hose reels in classrooms and associated corridors of primary and secondary schools. However, it should be noted that where fire hose reels are not installed in these buildings, portable fire extinguishers must be installed in accordance with **E1.6**.

The concession not requiring the installation of fire hose reels in classrooms, etc. is based on normal school use when teachers or school staff could be expected to be in control of students for the purpose of evacuation. Fire hose reels are required in other areas of the school such as halls, gymnasiums, etc. where activities take place outside normal school hours and with outside organisations that are not under the control of teachers or school staff.

E1.4(b)(i) requires the installation of fire hose reels where internal fire hydrants are provided. This requirement applies irrespective of whether the fire hydrants are required under **E1.4(b)(ii)** as a result of the floor area of a fire compartment exceeding 500 m².

E1.4(b)(ii) also states that, for the purposes of **E1.4**, a sole-occupancy unit in a Class 2 or Class 3 building or a Class 4 part is considered to be a fire compartment.

The 500 m² floor area referred to in **E1.4(b)(ii)** represents the level of hazard which justifies the installation of fire hose reels to allow occupants the opportunity to attempt an initial attack on a fire.

System design — E1.4(c)

E1.4(c)(ii) generally requires the installation of fire hose reels on the storey they are to service. This eliminates the need to run a fire hose up or down a stairway. Also, if the sole-occupancy units are in different ownership or leasehold, access between them may be difficult. It means that anyone using the fire hose will be able to get away quickly if the fire gets out of control.

E1.4(c)(ii) grants a concession when a sole-occupancy unit occupies more than one storey. The fire hose reel must be located at the level of egress from the sole-occupancy unit.

In the case of a Class 2 or Class 3 building or a Class 4 part, there is no limitation on the size or number of storeys within the sole-occupancy unit served by the hose.

For Class 5-9 buildings, the concession is limited to sole-occupancy units with only two storeys, where the fire hose reel at the entrance level provides total hose coverage.

See **Figure E1.4**.

E1.4(c)(iii) and **(iv)** relate to the positioning of fire hose reels to help occupants attack a fire in its early stages. **E1.4(c)(iv)** emphasises the importance of the location of fire hose reels to ensure safety.

Fire hose reels are not permitted to be installed within a fire-isolated exit, thereby avoiding having the hose pass through the door to access the fire. Such an arrangement would require the exit to be open, and therefore cause a significant risk of smoke entering.

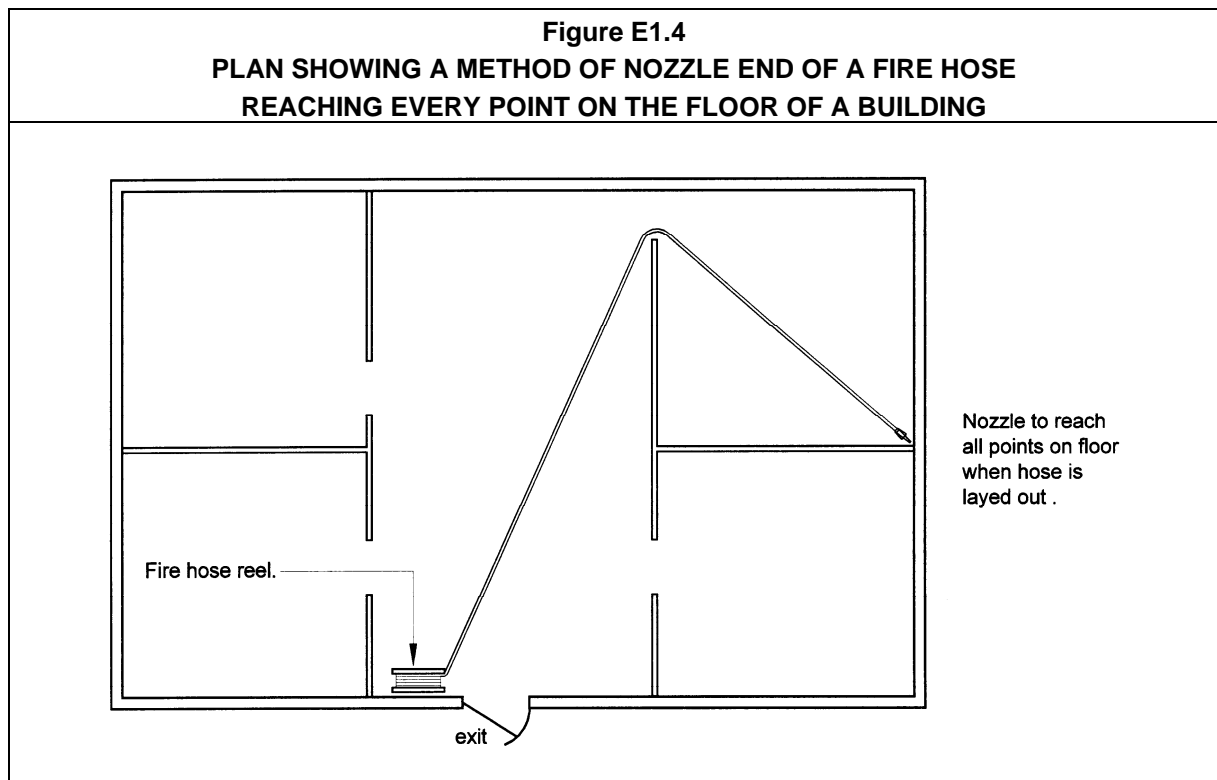

The same concerns do not apply to the other **Deemed-to-Satisfy Provisions** listed at the end of **E1.4(c)(iv)**. In the cases listed below, the door may remain open for the hose to pass through.

- **C2.13** deals with doors to electricity substations, and the like.
- **C3.11** deals with doors to sole-occupancy units of Class 2 or Class 3 buildings. To require

the placement of a fire hose reel in each sole-occupancy unit could be impractical, therefore fire hose reels are allowed to be placed in a common area and then pass through the entrance door to the unit.

- **C3.13** deals with openings in shafts. **C2.12** deals with the fire isolation of specified hazards and equipment.

Under **E1.4(c)(v)**, where a fire hose reel system is connected to a metered water supply, **Figure E1.4** of the BCA allows domestic branches to be connected to the supply main, provided the required flow rate is maintained (see **E1.4(c)(v)(A)**). Attention should be paid to the location and marking of isolation valves on domestic branches. This minimises the risk of the main valve to the combined system being isolated when working on a domestic branch. Isolation of the combined system valve when a fire occurs would result in the fire hose reels failing to operate.

E1.4(c)(vi) specifies the valve requirements for fire hose reels. Reels must be supplied by a main with a nominal bore of more than 25 mm. They must be connected to a fire hydrant main. They must also ‘wherever practicable’ be located in specified locations.

E1.5 Sprinklers

Intent

To require the installation of suitable fire sprinkler systems where necessary to address specific hazards.

When required

Refer to the comment on **EP1.4** for the reasons why the BCA requires the installation of sprinkler systems in buildings.

Table E1.5 sets out when sprinklers are required in a building, while **Specification E1.5** sets out the type of sprinkler required and other technical details.

Specification E1.5 allows the use of a residential sprinkler system in certain Class 2, Class 3 and Class 9c aged care buildings.

Table E1.5

Table E1.5 requires all buildings with an effective height of more than 25 metres (except those which only contain an open-deck carpark) to be sprinkler protected. The provision regarding an effective height of 25 metres recognises the effective operating height for fire brigade ladders and other fire-fighting and rescue equipment.

Notes 1, 2 and 3 to **Table E1.5** contain useful references to other BCA provisions that may require the installation of a sprinkler system.

E1.6 Portable fire extinguishers

Intent

To require the installation of suitable portable fire extinguishers, where necessary, to address specific hazards.

When required

Refer to the comment on **EP1.2** for the reasons why the BCA requires the installation of portable fire extinguishers in buildings.

Table E1.6 sets out when portable fire extinguishers are required in a building and the class of extinguisher to be used.

The installation of portable fire extinguishers must be in accordance with Sections 1, 2, 3 and 4 of **AS 2444**. The other sections of **AS 2444** deal with “Selection and distribution of portable fire extinguishers in vehicles and small craft” and “Selection and location of fire blankets”, neither of which are applicable to the BCA. If any conflict exists between **AS 2444** and the BCA, then the BCA takes precedence. Additional information can be obtained by reference to the Standard.

E1.7 * * * * *

The provisions of **E1.7** which existed in BCA 1990, are now dealt with in Part **E2**. This is the reason why **E1.7** of BCA96 has been left blank.

E1.8 Fire control centres

Intent

To require the provision of suitable fire control centres to facilitate fire brigade operations.

When required

Refer to the comment on **EP1.6** for the reasons why the BCA requires the installation of fire control centres in buildings.

E1.8(a) requires all buildings with an effective height of more than 25 metres to be provided with a fire control centre. Because of their height these buildings require special co-ordination of fire brigade operations. The **E1.8(a)** reference to an effective height of 25 metres recognises the operating height for fire brigade ladders and other fire-fighting and rescue equipment.

E1.8(b) requires a fire control centre for Class 6–9 buildings with a total floor area of more than 18 000 m².

The measurement concerned is of the total building floor area, not the area of an individual sole-occupancy unit or fire compartment.

Class 6 and Class 9 buildings have been included because of their high potential fire load, and the likelihood of large populations unfamiliar with their layout or evacuation procedures.

Class 7 and Class 8 buildings have been included because of the potential size and severity of fires in such buildings.

Specification E1.8 sets out the construction details of such a centre and the facilities it must contain.

E1.9 Fire precautions during construction

Intent

To require adequate fire-fighting equipment within a building during its construction.

When required

Refer to the comment on **EP1.5** for the reasons why the BCA requires the installation of fire-fighting equipment in buildings during their construction.

E1.9(a) requires the installation of suitable fire extinguishers in all buildings under construction. They are to be placed adjacent to exits on each storey so that they can be easily found by workers if a fire occurs.

Once a building reaches a height of about 12 metres, fire-fighting in a building under construction becomes increasingly difficult. The installation of fire hydrants, fire hose reels and booster connections (required under **E1.9(b)**) assist in overcoming such difficulties.

The fire hydrants and fire hose reels are not required on the two upper floors because services such as water supply may not be installed. Also, if a fire occurred on these floors, it could be fought from the floors below.

E1.10 Provision for special hazards

Intent

To require the installation of additional fire safety measures where special hazards exist.

When required

The other **Deemed-to-Satisfy Provisions** of Part **E1** set out the required fire-fighting equipment and co-ordination facilities required in a building to deal with ‘expected’ or ‘usual’ hazards. However, it is not possible to take account of every possible hazard. **E1.10** may even require additional provision for special hazards where Part **E1** does not otherwise apply.

Additional provision for special hazards must be made to allow for effective fire-fighting operations taking into consideration:

- the nature of the materials stored, displayed or used in the building or on the allotment; or
- inadequate water supply for fire-fighting.

Examples

Special fire hazards may exist for hazards under **E1.10(a)** in a warehouse used to store highly volatile or combustible materials, and also, at a site where highly combustible chemicals are manufactured.

Hazards under **E1.10(b)** may include sites where little or no water is available for fire-fighting.

The BCA **Deemed-to-Satisfy Provisions** do not specify what the special provisions must be. Each case must be assessed on its own merits.

SPECIFICATION **E1.5** FIRE SPRINKLER SYSTEMS

Deemed-to-Satisfy Provisions

1 Scope

Intent

To state that **Specification E1.5** gives the design and installation details for sprinkler systems required by the Deemed-to-Satisfy Provisions.

Design and installation — sprinkler systems

Clause 1 deals with the intent.

Examples

A number of the **Deemed-to-Satisfy Provisions** require the installation of sprinklers in accordance with **Specification E1.5**. These include:

- **E1.5** — Sprinklers;
- Part **E2** — Smoke Hazard Management;
- **C2.3(b)** — Large isolated buildings;
- **Specification G3.8** — Fire and smoke control in buildings containing atriums;
- **Clauses 3.9, 4.2 and 5.2** of **Specification C1.1** when granting a concession for enclosed carparks;
- **Clause 2.9** of **Specification C1.1** for residential aged care buildings; and
- **Clauses 3.10 and 4.3** of **Specification C1.1** for multi-storey, timber framed, Class 2 buildings.

2 Adoption of AS 2118

Intent

To adopt the appropriate Australian Standard for the design and installation of sprinkler systems.

Adoption of three Parts of AS 2118

Specification E1.5 adopts three Parts of AS 2118:

- [AS 2118.1](#) — *Automatic fire sprinkler systems Part 1: Standard*;
- [AS 2118.4](#) — *Automatic fire sprinkler systems Part 4: Residential*; and
- [AS 2118.6](#) — *Automatic fire sprinkler systems Part 6: Combined sprinkler and hydrant*.

AS 2118.1 applies to all classes of buildings — Clause 2(a)

Part 1 of AS 2118 applies to all Classes of building.

AS 2118.4 — Clause 2(b) and (d)

Part 4 of AS 2118 applies to low-rise Class 2, Class 3 and Class 9c buildings. The scope of [AS 2118.4](#) states that it only applies to those buildings containing no more than four storeys. If the building exceeds this height, it must comply with [AS 2118.1](#).

The sprinkler system specified under [AS 2118.4](#) has been designed for use in low-rise residential buildings. [AS 2118.4](#) also takes into consideration the economic aspects of a sprinkler system.

[AS 2118.4](#) provides the requirements for sprinklers in residential buildings.

A sprinkler system installed in accordance with [AS 2118.4](#) is designed to prevent the fire reaching the stage at which ‘flashover’ occurs (ie total involvement of a room’s contents in a fire), thus reducing the risks to occupants.

Smoke detection matters are dealt with in Part **E2**.

Combined sprinkler and hydrant systems — Clause 2(c)

Clause 2(c) allows the installation of a combined sprinkler and hydrant system provided it complies with [AS 2118.6](#).

3 Separation of sprinklered and non-sprinklered areas

Intent

To require the fire separation of sprinklered parts of a building from non-sprinklered parts of the building.

Size and intensity of an assumed fire

The design of a sprinkler system is based on the size and intensity of an assumed fire in the building. The BCA assumes that fire size is controlled by the sprinkler system.

A fire in a non-sprinklered part of a building

If a fire starts in a non-sprinklered part of the building, its development will be uncontrolled. It can even reach a size which could over-ride the sprinkler system if it spreads to the sprinklered part of the building (ie it could be beyond the design capacity of the system).

Separation between sprinklered and non-sprinklered parts

Clause 3(a) applies wherever there is a specific Deemed-to-Satisfy Provision.

The fire separation required by [AS 2118.1](#) may differ from that required by the BCA. **Clause 3(b)** clarifies that if a difference exists between [AS 2118.1](#) and the BCA, the BCA takes precedence.

[AS 2118.1](#) generally requires a 120/120/120 FRL separation between the sprinklered and non-sprinklered parts of a building to minimise the risk of fire spread from non-sprinklered parts (where a fire's development is substantially uncontrolled) to a sprinklered part (where the sprinkler system is designed on the basis of a likely fire in that part of the building).

4 Protection of openings

Intent

To require the fire separation of sprinklered parts of a building from non-sprinklered parts of the building.

The aim of **Clause 4** is similar to **Clause 3**, but it particularly deals with the protection of openings, in the construction, between sprinklered and non-sprinklered parts of a building.

5 Fast response sprinklers

Intent

To allow the use of fast response sprinkler heads.

Where 'fast response' sprinkler heads register a specific external temperature, their reaction time is much shorter than for a 'normal' sprinkler head. They also have different discharge characteristics. Where 'fast response' sprinkler heads are used, the sprinkler system must be designed specifically for their use.

6 Sprinkler valve enclosures

Intent

To require the location of sprinkler valves in a secure, easily accessible area.

Sprinkler control valves — location

Sprinkler control valves must be located in a secure area to prevent unauthorised tampering or vandalism.

'Direct egress to a road or open space'

Clause 6(a) requires that sprinkler alarm valves be in a room having 'direct egress to a road or open space'. The intent is to help fire brigade personnel gain quick access to valves, and, if the need arises, to exit quickly.

When interpreting the expression 'direct egress to a road or open space', it should be noted that **D1.10(c)** requires that if an exit discharges to open space which is at a different level from the public road to which it is connected, the path of travel to the road must be by a ramp or stairway complying with the BCA.

The aim is to provide quick egress, if the need arises. For this purpose it would be reasonable to limit the stairway to one flight. The landing and stairway must not expose a user to fire or smoke generated by a fire in the building. Care must therefore be taken to make sure windows and other openings are correctly located, and that the external walls of the building have an appropriate FRL.

7 Water supply

Intent

To require an adequate water supply when a sprinkler system as been installed.

Grades of water supply

A Grade 1 water supply is required for buildings greater than 25 metres in effective height (see **Clause 7(a)**), and a Grade 3 supply for buildings less than this height. See **Clause 7(b)**.

[AS 2118.1](#) defines a Grade 1 water supply as being a supply connected to two separate sources, each capable of providing water at the relevant hazard class. **Clause 7(a)** provides concessions for the secondary water supply in certain circumstances.

A Grade 3 water supply is a supply provided from a single source which does not satisfy the requirements of a Grade 2 water source (a Grade 2 water supply being one which provides a higher reliability of supply than Grade 3).

8 Building occupant warning system

Intent

To maximise the effectiveness of a sprinkler system by alerting the occupants throughout the building of a potential emergency.

AS 1670.1

Clause 8 requires a sprinkler system to be connected to activate a warning system complying with **Specification E2.2a, Clause 6**. This is an **AS 1670.1** warning system which is to operate throughout the occupied parts of the building.

Different types of warning devices permitted

AS 1670.1 allows the warning system to be:

- a warning system complying with AS 2220;
- electronic sounders generating evacuation tones in accordance with AS 2220; or
- another warning device approved by the appropriate authority.

See AS 2220.

9 Connection to other systems

Intent

To allow the interconnection of a sprinkler system with other fire safety systems.

Activation of smoke hazard management system

Modern fire safety designs allow for the interaction of the various safety systems during a fire.

Clause 9 requires that where a smoke hazard management system is activated by a smoke detector, 'wherever practicable' it must also be activated by the sprinkler system.

Note this provision only applies 'wherever practicable'. In other words, if a building proposal includes a smoke hazard management system which is activated by smoke detectors, but it is proposed that the smoke hazard management system will not be activated by the sprinkler system, the building proponent must satisfy the appropriate authority that it is not practicable to do so.

10 Anti-tamper devices

Intent

To provide for the continued operational effectiveness of sprinkler heads located above a theatre or public hall stage.

Stages used for live performances — high fire load

Stages used for live performances can contain high fire loads due to the scenery and other props used in these productions, and particularly hazardous stage activities, such as pyrotechnics.

Clause 10 requires that sprinkler valves be fitted with anti-tamper devices connected to a monitoring panel.

11 Sprinkler systems in carparks

Intent

To provide for sprinkler systems in certain carparks to operate independently or be isolated from the system in other parts of the building.

Carparks

Table 3.9 of **Specification C1.1** grants concessions for the FRL of structural members within carparks in buildings required to be of Type A construction. Therefore, **Clause 11** of **Specification E1.5** only applies to such buildings.

Clause 11 does not apply to **Tables 4.2** and **5.2** of **Specification C1.1** for carparks in buildings required to be of Type B or Type C construction.

If a building required to be of Type A construction contains an enclosed carpark, in order to take advantage of the concession allowed by **Table 3.9**, it must contain a sprinkler system which is independent or can be separately isolated.

The reason for this requirement is so that the carpark's protection is available at all times, and is not affected by such factors as maintenance or shutdown in other parts of the building.

12 Class 9c aged care buildings

Intent

To ensure greater reliability of sprinkler systems in Class 9c buildings.

Clause 2(d) of **Specification E1.5** allows a sprinkler system in a Class 9c building to comply with AS 2118.4 instead of AS 2118.1. **Clause 12(a)** requires the addition of a monitored main valve and control valve assembly in accordance with AS 2118.1. The reason for the additional requirement is to ensure greater reliability of the sprinkler system.

Clause 12(b) specifies system monitoring requirements to enable a timely and appropriate response by the local fire brigade to emergencies.

Clause 2.10.1.3 of AS 2118.4 sets out the requirements for the installation of sprinklers in roof spaces, etc. Spaces such as roof spaces, crawl spaces, spaces below floor and above ceilings, and other concealed spaces that are not intended, nor used, for living purposes, storage or the installation of equipment such as flexible ductwork, heating and refrigeration equipment, are not required to be protected by sprinklers.

Roof and ceiling spaces that contain only items such as electrical wiring for light fittings and exhaust fans, etc are not required by this provision to be provided with sprinklers.

SPECIFICATION **E1.8** FIRE CONTROL CENTRES

Deemed-to-Satisfy Provisions

1 Scope

Intent

To clarify that **Specification E1.8** provides the construction and content details for fire control centres or rooms.

Fire control centres or rooms

Specification E1.8 sets out the construction and content details for fire control centres or rooms required by the BCA.

Clause 4 requires that where a fire control centre is in a building of more than 50 metres in effective height, the centre must be in a separate room. The remainder of **Specification E1.8** then refers to such rooms as ‘fire control rooms’. In other words, where **Specification E1.8** uses the term:

- ‘fire control room’, it is referring to a fire control centre in a room in a building with an effective height of more than 50 metres; and
- ‘fire control centre’, it is referring to all other cases.

Clauses 6, 7, 8, 9 and **10** refer to a ‘fire control room’, and should therefore be interpreted as only applying to a fire control centre in a building with an effective height of more than 50 metres.

2 Purpose and content

Intent

To clarify the facilities a fire control centre must contain.

Fire control centre or room required by **E1.8**

E1.8 sets out when a fire control centre or room is required in a building.

Exclusive purpose of centre or room

Clause 2 sets out that a fire control centre or room must be for the exclusive purpose of:

- directing fire-fighting operations and other functions of the fire brigade, such as search

and rescue operations (this requirement reflects the importance placed on fire brigade

operations); and

- other measures directly relating to occupant safety or security.

In this context, the centre or room cannot be used for any other purpose.

3 Location of fire control centre or room

Intent

To require that a fire control centre or room be conveniently placed to allow egress.

Egress

Egress from the fire control centre or room must not involve a change in level exceeding 300 mm. This is to help fire brigade officers carrying their equipment and make entry easy.

4 Construction

Intent

To set out the construction details of fire control rooms.

Buildings over 50 metres in effective height

E1.8 requires certain buildings to contain a fire control centre. **Clause 4** only applies to those buildings with an effective height greater than 50 metres. In these buildings, a fire control centre must be within a dedicated room known as a fire control room. Since the fire control room will be occupied by fire brigade personnel during a fire in the building, it must be fire separated from the remainder of the building.

5 Protection of openings

Intent

To require that the fire-resisting performance of a fire control room is maintained.

Openings must be fire protected

The aim of Clause 5 is similar to Clause 4, except that Clause 5 deals with openings in the construction separating the fire control room from the remainder of the building.

6 Exit doors

Intent

To require adequate access to a fire control room.

Application

Refer to comment on **Clause 1**.

Access

The main provisions deal with access to the fire control room. Since it will be necessary for the fire brigade to gain access to the fire control room while the building is being evacuated, access to it must not be obstructed by people evacuating.

Providing access by way of two paths of travel is to help fire brigade access. One of those paths must be from the front entrance of the building, and the other must be from a public place or a fire-isolated passage which leads from a public place.

7 Size and contents

Intent

To set out the contents required in a fire control room.

Application

Refer to comment on **Clause 1**.

Clause 7(a) sets out the minimum size and contents required in a fire control room.

Clause 7(b) lists additional items which may be contained in a fire control room. This list is not exhaustive, other items may be added provided the floor area of the room is increased, as required by **Clause 7(c)**.

Clause 7(c) sets out the area requirements for fire control rooms.

8 Ventilation and power supply

Intent

To reduce the likelihood of smoke accumulating in a fire control room.

Application

Refer to comment on **Clause 1**.

Since the fire control room will be occupied by fire brigade personnel, possibly for a period long after the other occupants have evacuated, it must have adequate means of preventing the

accumulation of smoke. The room can have either natural ventilation complying with **Clause 8(a)** or a pressurisation system complying with **Clause 8(b)**.

If natural ventilation is used, then the window or door must not open to another part of the building.

If a pressurisation system is used, it must comply with [AS/NZS 1668.1](#) and the other provisions of **Clause 8(b)**. This is achieved by treating the room similarly to a fire-isolated stairway, which includes:

- activation of the system;
- air change rates;
- protection of fans, motors and duct work;
- protection of the electrical supply to the system; and
- relief air devices.

9 Sign

Intent

To require that a fire control room is appropriately identified.

Application

Refer to comment on **Clause 1**.

Clause 9 achieves the intent by requiring the placement of a sign on the door to the room. Such a sign is required on all doors to a fire control room.

10 Lighting

Intent

To provide sufficient illumination to the fire control room during an emergency.

Application

Refer to comment on **Clause 1**.

Since the fire control room will be occupied by fire brigade personnel during a fire in the building, possibly for a period long after the other occupants have evacuated, it must have appropriate levels of lighting. As the lighting must be maintained while the room is in use, it must be emergency lighting in case of failure of the building's normal lighting system.

Normally, emergency lighting is only used for evacuation purposes. A fire control room is used to direct fire brigade operations, which will include such actions as reference to building plans, and the reading of other information. The amount of emergency lighting in the room must therefore be increased to 400 lux.

SPEC E1.8 – FIRE CONTROL CENTRES

11 **Equipment not permitted within a fire control centre or room****Intent**

To limit the type of equipment allowed in a fire control centre or room.

Fire control centres and rooms

Clause 11 refers to both a fire control centre and a fire control room and therefore should be interpreted as applying to all buildings required by **E1.8** to have a fire control centre.

Extraneous equipment not allowed

Since the fire control centre or room will be occupied by fire brigade personnel during a fire, possibly for a period long after the other occupants have evacuated, it must be suitable for directing fire brigade operations. Equipment which does not assist in this function, or could endanger the fire brigade personnel, is not allowed in the centre or room.

12 **Ambient sound level****Intent**

To minimise the risk of the sound levels in a fire control centre or room interfering with the room's function.

Noise must not interfere with communications

The fire control centre or room is used to direct fire brigade operations during a fire in the building, possibly for a period long after the other occupants have evacuated. This involves communication with other fire brigade officers outside the room. It is therefore important that ambient sound levels in the room do not interfere with that communication.

PART E2 SMOKE HAZARD MANAGEMENT

Objective

EO2

Safeguard occupants from illness and injury

Part **E2** aims to safeguard building occupants from illness or injury from the products of combustion (including smoke and toxic gases). **EO2(a)** deals with warning of a fire and **EO2(b)** deals with requirements for evacuating.

Smoke and toxic gases kill

Smoke and toxic gases are the main causes of death in building fires. Such deaths have occurred in locations remote from the fire to where smoke and gases have spread. Smoke and toxic gases cause disorientation, incapacitation and ultimately death, depending on the concentration and length of exposure.

Management of the smoke and toxic gas hazard is crucial for occupant safety. This is best achieved through a combination of active and passive measures, such as:

- building materials and finishes;
- compartmentation;
- egress;
- smoke and toxic gas detection;
- fire suppression; and
- smoke and toxic gas control by mechanical means.

Part **E2** addresses some of the active measures which, together with the relevant provisions in other Parts of the BCA, provide appropriate strategies for the protection of occupants.

Functional Statement

EF2.1

Buildings — adequate safeguards

EF2.1 requires that a building have safeguards to warn occupants of a fire so they may safely evacuate before the conditions in any evacuation route become untenable, due to the effects of fire.

Performance Requirements

EP2.1

Sleeping accommodation — smoke alarms

A Class 2, 3, 9a and 9c building and a Class 4 part must contain automatic warning on the detection of smoke for occupants in sleeping areas, so they may be alerted to a fire.

EP2.2

Evacuation routes must remain tenable

Occupants must be given time to evacuate before the onset of untenable conditions. **EP2.2(a)** specifies these conditions as dangerous temperatures, low visibility and dangerous levels of toxicity.

Hence, evacuation time must take account of a range of factors including the following:

- **EP2.2(b)(i)** — the difficulty of evacuation and/or rescue. An example is where there is a large number of occupants, or they are not mobile, such as patients in a hospital or residents of an elderly people's home. Here the evacuation time could be high.
- **EP2.2(b)(ii)** — the likelihood or risk of a fire occurring in the building, which can have an influence on risk levels during evacuation and along the evacuation route.
- **EP2.2(b)(iii)** — the time necessary to travel to an exit, and the difficulty of evacuation and/or rescue.
- **EP2.2(b)(iv), (v) and (vi)** — the size, load or intensity of any fire in the building, which has a clear influence on the speed of fire development and spread, and heat and toxic gas characteristics.
- **EP2.2(b)(vii)** — the fire safety systems in the building can influence the rate of fire spread and intensity and toxic gas development (eg if a sprinkler system is installed, it should extinguish the fire or reduce its growth rate).
- **EP2.2(b)(viii)** — the fire-fighting operations of the fire brigade and the resources available to it, which influences the extent to which a fire can develop before the fire brigade is likely to bring it under control.

Under its Limitation provision, **EP2.2** does not apply to open-deck carpark or open spectator stands where the smoke and hot gases can vent naturally, thereby allowing occupants to safely evacuate.

PART E2 SMOKE HAZARD MANAGEMENT

Deemed-to-Satisfy Provisions

E2.0 Deemed-to-Satisfy Provisions

Intent

To clarify that the requirements of EP2.1 and EP2.2 will be satisfied if compliance is achieved with E2.1 to E2.3 and, in buildings containing atriums, Part G3.

E2.1 to E2.3 and EP2.1 and EP2.2

Except in buildings containing atriums, compliance with E2.1 to E2.3 achieves compliance with EP2.1 and EP2.2.

Buildings with atriums

In addition to achieving compliance with E2.1 to E2.3, to achieve compliance with EP2.1 and EP2.2 buildings with atriums must also comply with Part G3.

E2.1 Application of Part

Intent

To specify when E2.2 and E2.3 do not apply.

Open-deck carpark and open spectator stands — E2.1(a)

E2.1(a), E2.2 and E2.3 do not apply to open-deck carpark or open spectator stands. EP2.2 does not apply to such buildings because the smoke and hot gases can vent naturally.

Smoke exhaust systems and smoke-and-heat vents — E2.1(b)

Under E2.1(b), the E2.2 and E2.3 provisions regarding smoke exhaust systems and smoke-and-heat vents do not apply to small areas used for short periods.

A small area will be easily evacuated before smoke build-up and if the area is only used for short periods, the risk of occupants being trapped in it during a fire is low.

E2.2 General requirements

Intent

To specify the requirements for minimising the smoke risks.

Class 2-9 buildings — E2.2(a)

Class 2-9 buildings must comply with **E2.2(b)**, **(c)** and **(d)**, which cover the fire mode operation of air-handling systems so that they do not contribute to the spread of smoke during a fire. This assists to maintain the basic smoke integrity of the fire compartments.

In addition to **E2.2(b)**, **(c)** and **(d)**, Class 2–9 buildings must comply with the requirements of **Table E2.2a**, which provides some general and specific strategies for smoke hazard management.

In addition to **E2.2(b)**, **(c)** and **(d)** and **Table E2.2a**, Class 6 and Class 9b buildings must comply with the requirements of **Table E2.2b**, where applicable, which provides some general and specific strategies for smoke hazard management.

Air-handling system which is not part of a smoke hazard management system — E2.2(b)

Smoke must not cross smoke barriers

E2.2(b) requires that an air-handling system that is not part of a smoke hazard management system be designed and installed with suitable strategies to ensure that, during a fire, it does not:

- recycle air (and therefore smoke) from one fire compartment to another; or
- otherwise contribute to the spread of smoke between fire compartments.

Comply with AS/NZS 1668.1 — E2.2(b)(i)

The effect of **E2.2(b)(i)** is that in a fire, an air-handling system must either operate as a smoke control system in accordance with **AS/NZS 1668.1** (as specified in **E2.2(b)(i)**) or shut down (as specified in **E2.2(b)(ii)**).

A smoke purging system, in accordance with **AS/NZS 1668.1**, is allowable in buildings not covered by the general provisions in **Table E2.2a**, and, in some instances, in conjunction with other measures in accordance with **Table E2.2a**.

Non-smoke control system — E2.2(b)

An air-handling system not designed as a smoke control system must comply with the requirements set out in **E2.2(b)** as follows:

- Automatic smoke dampers — **E2.2(b)(ii)(A)**
Where the air-handling system is shut down in fire mode, it must incorporate automatic smoke dampers where the ducts penetrate any fire barriers.
This requirement may apply to an air-handling system which supplies outside air to a group of residential sole-occupancy units.
- System shut down — **E2.2(b)(ii)(B)**
The air handling system must shut down, and smoke detectors must automatically activate smoke dampers.
- Class 2 and Class 3 buildings

Sole-occupancy units in Class 2 and Class 3 buildings are, under **E2.2(b)**, regarded as separate fire compartments.

Sections 5 and 11 of AS/NZS 1668.1 — E2.2(c)

Air-handling systems, other than one in a carpark, serving more than one fire compartment covered by Sections 5 and 11 of **AS/NZS 1668.1** must be designed and installed in compliance with those sections of the Australian Standard. This will restrict the spread of smoke between fire compartments.

Provisions on the operation of carpark ventilation systems during a fire in the carpark are included under the general provisions in **Table E2.2a**.

Smoke detection systems to operate AS/NZS 1668.1 smoke control systems — E2.2(d)

An **AS/NZS 1668.1** system for zoned smoke control and automatic air pressurisation for fire-isolated exits must be controlled by a smoke detection and alarm system installed in compliance with **Specification E2.2a**. Activation of these systems also requires the activation of a building occupant warning system.

E2.3 Provision for special hazards**Intent**

To state that some special hazards may require additional smoke hazard management measures.

Additional smoke hazard measures

E2.3 states that certain factors may need additional smoke hazard management measures.

E2.3 reinforces the need for careful consideration and sound professional judgement in the application of the smoke hazard management provisions of the BCA.

Examples

E2.3 may be applicable in situations where:

- A child care centre is located above ground floor level or within a commercial building. Safety of children is paramount. They will need assistance to evacuate. As egress arrangements depart from providing exits direct to a road or open space, (usually provided at ground floor level) so does the potential for things to go wrong. The BCA does not specifically address child care centres at other than the ground floor.
- Occupants are held under detention in a correctional or health-care facility. The BCA does not specifically address the special circumstances surrounding these facilities. To ensure an acceptable level of safety is provided to occupants, special provisions may need to be provided.
- A high hazard process is carried out in an industrial building. Due to the variance in such processes, it would be difficult to develop specific generic provisions. Such processes may also be subject to other legislation. Hence each process should be considered on its merits and additional safeguards provided as necessary.

Deemed-to-Satisfy Provisions — **Tables E2.2a and E2.2b**

Table E2.2a — General Provisions

Table E2.2a and EP2.1 and EP2.2

EP2.1 requires automatic warning on the detection of smoke in buildings having sleeping accommodation, so that occupants may be alerted to the fire hazard. **EP2.2**, in terms of maintaining safe conditions in any evacuation route, deals with the period of time it would take occupants to evacuate that part of the building.

Table E2.2a provides whole-building strategies

Table E2.2a provides smoke hazard management strategies structured to help application to buildings of mixed classification. In the case of a multi-classified building, each classifiable part must comply with the relevant provisions for its classification. Certain Class 6 and Class 9b parts of buildings must also comply with the specific provisions in **Table E2.2b**.

Fire-isolated exits

Fire-isolated exits enable the safe evacuation of occupants, and also aid fire brigade access. Smoke must not unduly affect the conditions in such exits during an evacuation.

To minimise smoke intrusion, the exits may need to be pressurised with outside air for the entire exit route. See the following examples. Alternatively, the exits may be provided with open access ramps or balconies from which smoke can vent naturally.

Examples

Pressurised fire-isolated exits are required where:

- tenable conditions must be maintained for an extended period due to a long distance of travel, such as exits which serve storeys above 25 metres in effective height or which are more than 60 metres in length to a road or open space;
- tenable conditions must be maintained for an extended period of time to enable the safe evacuation of non-ambulatory occupants, such as in health-care buildings with a rise in storeys of more than 2;
- the exits are the only possible means of escape, such as those serving basements more than two storeys below ground; or
- the risk of smoke intrusion into the exits is high on account of a particular building characteristic, such as is generally the case in a building containing an atrium.

Buildings over 25 metres in effective height

In buildings more than 25 metres in effective height, tenable conditions need to be maintained in the fire-isolated exits and, where practicable, in other parts of the building to enable the staged evacuation of occupants.

Occupants of such buildings may continue to occupy compartments remote from the fire for an extended time before evacuation. Accordingly, suitable measures must be adopted to minimise the spread of smoke from the fire-affected compartment to non-affected compartments by way of a number of potential leakage paths.

These paths include lift shafts, air-handling ducts, services risers, building penetrations, spandrels, and the like, through which smoke can be driven by buoyancy, expansion, stack and wind effects, and air-handling systems.

In order to minimise the spread of smoke, a zone smoke control system is considered necessary in buildings more than 25 metres in effective height. This does not apply to the residential parts of a building in view of:

- the alternative protection provided by the fire compartmentation of sole-occupancy units;
- separation of public corridors by bounding construction; and
- division of such corridors by smoke-proof walls into lengths of not more than 40 metres (see **C2.14**).

Notwithstanding the above, a smoke detection and alarm system must be provided in residential and health-care buildings to provide early warning to occupants who may be asleep, confused, or non-ambulatory and dependent on assistance.

Table E2.2a provisions are additional to other safety provisions for buildings with an effective height of more than 25 metres.

Buildings less than 25 metres in effective height

In buildings less than 25 metres in effective height, the necessary levels of protection may be achieved by measures other than zone smoke control, depending on the Class and rise in storeys of the building.

In buildings other than health-care buildings, zone smoke control may be substituted by either stairway pressurisation, smoke detection, or sprinkler protection. The rise in storeys before which the provisions become applicable depends on the building's classification and use.

The above measures do not apply to the residential parts of a building because of the passive protection provided to such parts. However, where one or more fire-isolated exits join residential and non-residential parts, other than open-deck carparks, the fire-isolated exits must either be pressurised, or the non-residential parts provided with smoke detection or sprinkler protection. This is necessary to compensate for the potential additional hazard associated with the particular mix of Classes.

In health-care buildings, zone smoke control may be substituted by a sprinkler system, providing residential sprinkler heads are used in patient care areas. The fast response of residential sprinkler heads promotes life safety by limiting fire growth and smoke development. Where zone control is not adopted, the air-handling systems must generally be shut down not only to maintain the integrity of the smoke and fire compartmentation, but also to minimise the spread of smoke within the fire-affected compartment.

Notwithstanding the above, a smoke detection and alarm system must be provided in residential and health-care buildings.

Class 7a buildings

A carpark ventilation system is consistent with the treatment of miscellaneous air-handling systems in [AS/NZS 1668.1](#). Accordingly, the electric power and control cabling for a carpark ventilation system need not be fire rated.

PART E2 – SMOKE HAZARD MANAGEMENT

To make sure that the manual override provision of Clause 5.5.3 of [AS/NZS 1668.1](#) is not subject to the control of any general installation main switches, the power supply arrangement must comply with Clause 2.19.4 of AS 3000.

Basements (other than Class 7a buildings)

The provisions for basements are more stringent due to the special problems they pose for evacuation, search and rescue, and fire-fighting operations.

As the total floor area of the basement increases to above 2 000 m², certain minimum measures have been stipulated. In basements with three or more below ground storeys, a sprinkler system is considered necessary.

Atriums

The provisions of this Part, as well as Part G3, apply to atrium buildings.

Table E2.2b — Specific Provisions**Table E2.2b and Class 6 and Class 9b buildings**

The provisions of **Table E2.2b** are additional strategies which only apply to certain Class 6 and Class 9b buildings where there is a high risk that occupants may not be able to safely evacuate the fire-affected compartment. This risk may be due to factors such as:

- building design;
- function;
- usage;
- fire load; or
- nature of occupancy.

Occupants of such buildings are also not necessarily familiar with the building or the procedures for evacuation.

Maintenance of safe conditions in evacuation routes

Table E2.2b addresses requirements under **EP2.2** in terms of maintaining safe conditions in any evacuation route within the fire-affected compartment of Class 6 and Class 9b buildings, for the period of time it would take occupants to evacuate that part of the building.

Class 6 buildings

The specific provisions for smoke exhaust or smoke-and-heat vents apply to fire compartments having a floor area of more than 2 000 m², although certain concessions apply to Class 6 buildings with compartments not more than 3 500 m² in area or with a rise in storeys of two or less. See Example 1 and Example 2.

Example 1

Example 1 looks at a single storey shopping complex which does not contain a mall, as shown in [Figure E2.2b\(1\)](#).

Shop	Area	Entry	Smoke exhaust OR smoke-and-heat vents OR smoke detection and alarm OR sprinkler system
A	900 m ²	From open space	None required
B	2 500 m ²	From open space	Required
C	1 900 m ²	From open space	None required

Figure E2.2b(1)
PLAN OF SHOPPING CENTRE FOR EXAMPLE 1

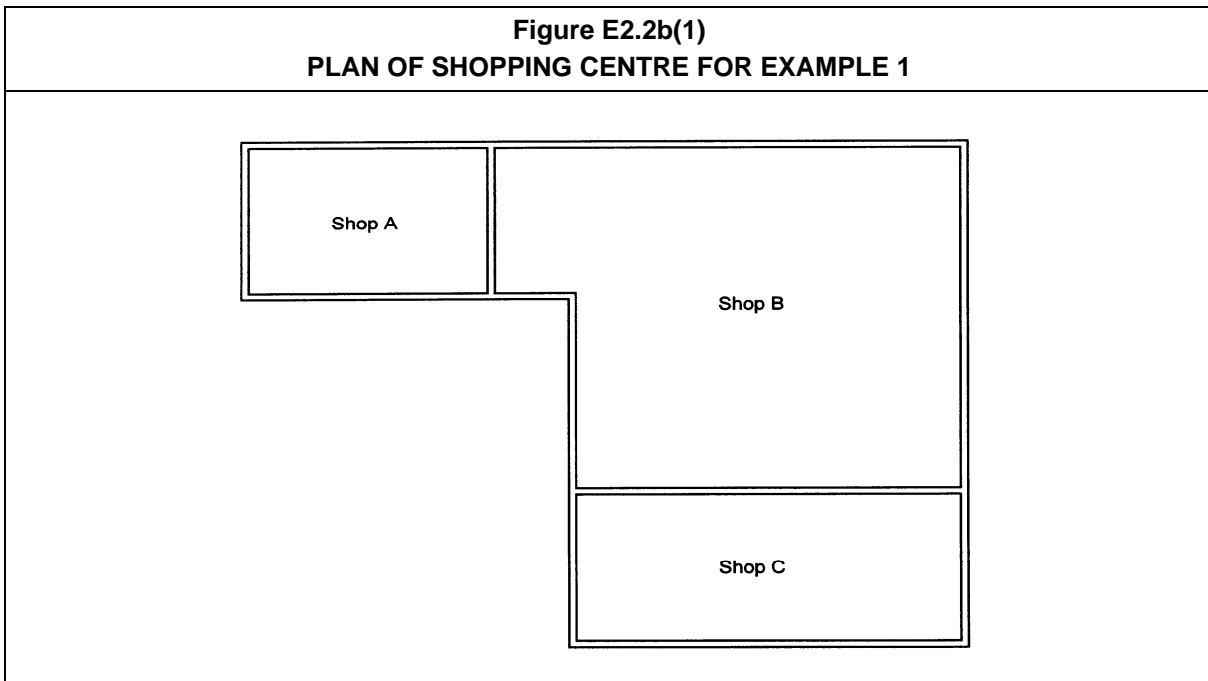

Example 2

Example 2 looks at a single storey shopping complex containing a mall, as shown in [Figure E2.2b\(2\)](#).

Shop	Area	Entry	Smoke exhaust OR smoke-and-heat vents
A	900 m ²	From open space	None required
B	900 m ²	From mall	None required
C	900 m ²	From mall and open space	None required
D	1 900 m ²	From open space	None required
E	1 900 m ²	From mall	Required
F	1 900 m ²	From mall and open space	Required
G	2 500 m ²	From open space	Required
H	2 500 m ²	From mall	Required
I	2 500 m ²	From mall and open space	Required
Mall	—	—	Required

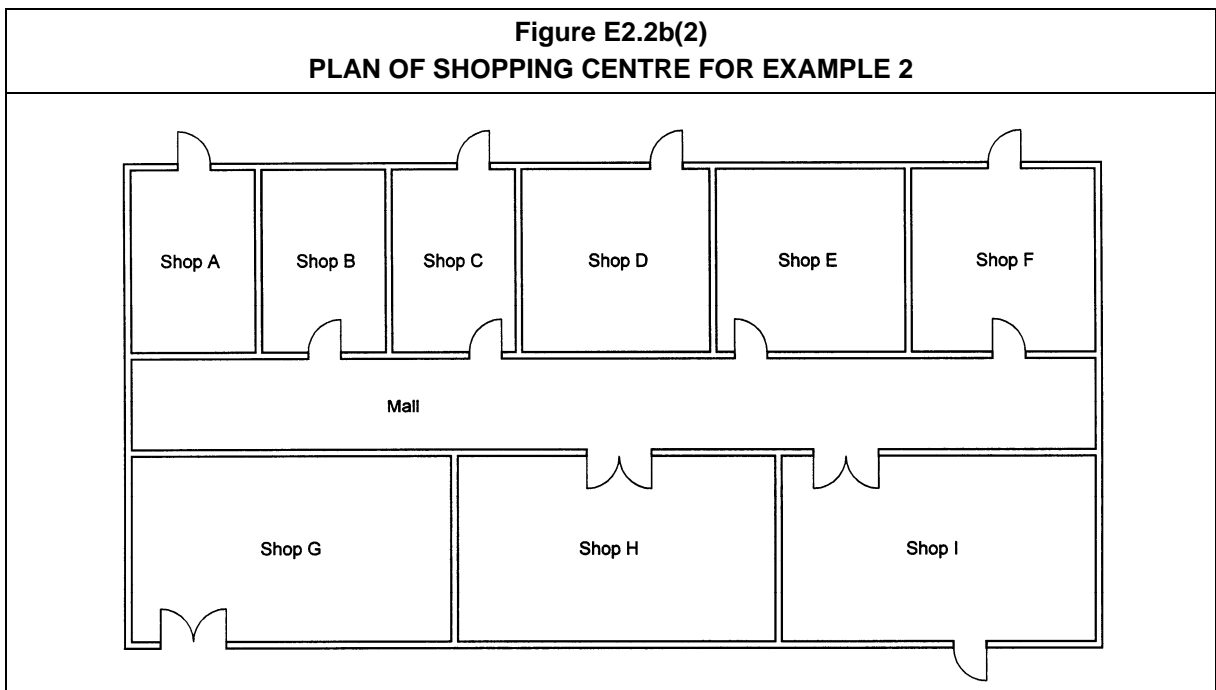

Class 9 assembly buildings

Table E2.2b — greater uniformity and consistency

Assembly buildings cover a wide range of uses with varying degrees of hazards. **Table E2.2b** addresses some of the uses to enable greater uniformity in the treatment of the buildings or parts of buildings. It provides for assembly buildings generally, except for certain low hazard occupancies which have been exempted from compliance.

Exempted assembly buildings

Certain **Table E2.2b** provisions for assembly buildings do not apply to schools, apart from the automatic shutdown of air-handling systems in lecture theatres. This is because such buildings may have alarm systems with which the occupants are familiar, and the occupants are usually under a sufficient level of control to enable quick and orderly evacuation.

Concessions are granted for sporting complexes, excluding indoor stadiums with total spectator seating of more than 1000, principally because the risk levels are not high, particularly with regard to open-air complexes. Buildings used solely for religious worship are also exempt.

Assembly buildings with floor area over 2 000 m²

The **Table E2.2b** provisions for smoke exhaust or smoke-and-heat vents are applicable to fire compartments having a floor area of more than 2 000 m², except that certain concessions apply to low rise buildings.

If the floor area of the fire compartment is not more than 5 000 m², smoke extraction need not be provided if the building has a rise in storeys of two or less, and a smoke detection and alarm system, or a sprinkler system is installed.

Nightclubs, discotheques and the like

The **Table E2.2b** provisions apply to all nightclubs, discotheques and the like, regardless of the floor area, in recognition of the high hazards generated by such factors as:

- occupant density;
- access control;
- indoor environment;
- quantity and location of soft furnishings;
- whether or not smoking is permitted; and
- occupant behaviour.

Exhibition halls

The **Table E2.2b** provisions for exhibition halls which are used for trade displays and the like are based on them having hazards similar to those for shopping centres and indoor markets.

Theatres and public halls

The **Table E2.2b** provisions only apply to those theatres and public halls which are considered a high hazard occupancy due to the potential fire load associated with the stage and backstage areas and/or rigging lofts. Under Part **H1**, such theatres and public halls are also required to be sprinkler protected or have the stage and backstage areas separated from the audience by a proscenium wall.

The **Table E2.2b** provisions for these occupancies are similar to those for assembly buildings. The provision for automatic shutdown of air-handling systems (which do not form part of a smoke management system) is applicable in all such buildings, including those serving school lecture theatres not more than 2 000 m² in area.

Other assembly buildings

Table E2.2b includes provisions for general assembly buildings not covered elsewhere. Museums and art galleries with fire compartments in excess of 2000 m² are covered by these provisions.

SPECIFICATION **E2.2a** SMOKE DETECTION AND ALARM SYSTEMS

Deemed-to-Satisfy Provisions

1 Scope

Intent

To state that **Specification E2.2a** relates to the installation and operation of automatic alarm systems.

Automatic smoke detection and alarm systems

Specification E2.2a covers the technical requirements for smoke detection and alarm systems, including such detection as is necessary to activate smoke control systems.

2 Type of system

Intent

To specify compliance requirements for required automatic smoke detection and alarm systems.

Types of smoke detection and alarm systems

Clause 2 covers smoke detection and alarm systems directly referenced in **Tables E2.2a** and **E2.2b**. The application of smoke detection to smoke control systems is addressed in **Clause 5**.

Clause 2 indicates the types of system, in terms of smoke alarm and/or smoke detection, applicable to various Classes of buildings. A smoke detection system is considered necessary in certain Class 3 and Class 9a buildings to facilitate system monitoring as required by **Clause 7**.

Smoke alarm systems

Smoke alarm systems are required in:

- Class 2 buildings;
- smaller Class 3 buildings (see **Clause 2(a)(ii)** regarding larger Class 3 buildings);
- Class 4 parts; and

- smaller Class 9a buildings (see **Clause 2(c)(ii)** regarding larger Class 9a buildings).

Smoke detection systems

Smoke detection systems are required (and in some cases are the sole requirement to satisfy smoke hazard management provisions) in:

- Class 2 buildings;
- smaller Class 3 buildings;
- larger Class 3 buildings;
- Class 4 parts;
- Class 5–8 and Class 9b buildings (note that a smoke detection system complying with **Clause 4** and not a smoke alarm system complying with **Clause 3** is required in these buildings);
- smaller Class 9a building (see **Clause 2(c)(ii)** regarding larger Class 9a buildings); and
- larger Class 9a buildings (note that a smoke detection system complying with **Clause 4** and not a smoke alarm system complying with **Clause 3** is required in these buildings).
- Class 9c buildings.

Combined systems

Combined smoke alarm and smoke detection systems are permitted (as specified) in:

- Class 2 buildings;
- smaller Class 3 buildings (see **Clause 2(a)(ii)** regarding larger Class 3 buildings); and
- Class 4 parts.

A smoke alarm system and a smoke detection system are only required to be installed when required by **Table E2.2a** or **Table E2.2b**.

3 Smoke alarm system

Intent

To specify requirements for required automatic smoke alarm systems.

Smoke alarm systems — **Clause 3(a)**

Smoke alarm systems must include smoke alarms which comply with **AS 3786**, (see **Clause 3(b)**).

Power to smoke alarm systems must come from the electrical power supply to that part of the building served by the smoke alarm system.

Heat alarms — Clause 3(b)

A smoke alarm can give false alarms if the atmosphere contains particles, such as steam or other vapours, which obscure vision. For example, in a kitchen. A heat alarm may be used if a smoke alarm is likely to give a false alarm due to the atmospheric conditions, or if the subject area is unsprinklered.

Smoke alarms and residential buildings — Clause 3(c)

Clause 3(c) details the installation requirements for automatic smoke alarms in residential buildings (excluding Class 9 buildings).

Smoke alarms located within each sole-occupancy unit need not be interconnected to provide a common alarm.

Smoke alarms located outside the sole-occupancy units, in public corridors and other common areas within the building, must be interconnected to provide a common building alarm in order to alert all building occupants to the potential hazard in the common evacuation routes.

Smoke alarms and health-care buildings — Clause 3(d)

The application of **Clause 3(d)** is limited by the provisions of **Clause 2(c)** to small health-care buildings, where not more than six patients are accommodated in beds.

Interconnection of smoke alarms is required due to the level of compartmentation and the need to alert staff to help occupants who may be confused, non-ambulatory or otherwise dependent on assistance. Manual call points are also necessary in view of the nature of the occupancy.

4 Smoke detection system**Intent**

To specify requirements for required automatic smoke detection systems.

Smoke detection systems — Clause 4(a)

Clause 4(a)(i) specifies the circumstances in which [AS 1670.1](#) applies.

Clause 4(a)(ii) specifies that the smoke detection system must activate a suitable building occupant warning system.

Heat detectors — Clause 4(b)

A smoke detector can give false alarms if the atmosphere contains particles, such as steam or other vapours. For example, in a kitchen. A heat detector may be used if a smoke detector is likely to give a false alarm due to the atmospheric conditions or the subject area is unsprinklered.

Residential buildings — Clause 4(c)

Clause 4(c) details the installation requirements for automatic smoke detection systems in residential buildings (excluding Class 9 buildings).

Health-care buildings — Clause 4(d)

Clause 4(d) applies to all Class 9a buildings which have a smoke detection system.

The use of alternate photo-electric and ionisation detectors, in paths of travel to exits from patient-care areas, is to achieve an improved response to the range of smoke particles produced by smouldering as well as clean burning fires. Manual call points are also necessary in view of the nature of the occupancy.

Aged care buildings — Clause 4(e)

In an aged care building, an automatic smoke detection system must be installed in accordance with AS 1670.1. Subject to **Clause 4(a)** of Specification E2.2a, Clause 4.3 of AS 1670.1 lists areas where detectors are required. Manual call points are also necessary in larger buildings in view of the nature of the occupancy.

5 Smoke detection for smoke control systems**Intent**

To specify the smoke detection requirements applicable to smoke control systems.

AS/NZS 1668.1 systems — Clause 5(a)

Clause 5(a) covers smoke detection associated with AS/NZS 1668.1 stair pressurisation systems referenced in **Table E2.2a**. It requires the installation of additional detectors adjacent to each bank of lift landing doors. Lift shafts form one of the principal paths for smoke spreading between floors in a multi-compartmented building.

Location and sensitivity — Clause 5(b)

Clause 5(b) covers the location and sensitivity of smoke detectors associated with smoke control systems referenced in:

- **Table E2.2b**, regarding automatic shutdown of air-handling systems;
- **Specification E2.2b**, regarding the smoke exhaust system.

Activation — Clause 5(c)

Under **Clause 5(c)**, smoke detectors which activate a smoke control system must:

- form part of the building's AS 1670.1 smoke detection system or be a separate dedicated system; and
- activate a building occupant warning system complying with **Clause 6**, unless they initiate shutdown of an automatic air-handling system only, in which case they need not activate a building occupant warning system.

6 Building occupant warning system

Intent

To specify the application of building occupant warning systems.

Spec E2.2a - 6Residential buildings — Clauses 6(a) and (b)

Because of the protection provided by the fire compartmentation of sole-occupancy units in residential buildings, it is not mandatory for a building occupant warning system to have sounders or speakers installed within each sole-occupancy unit. Accordingly, **Clauses 6(a) and (b)** provide for the sound pressure levels to be measured at the entry to each sole-occupancy unit.

Residential aged care and health-care buildings — Clauses 6(c) and (d)

Clauses 6(c) and (d) provide for the warning signals to be modified in certain areas within residential aged care and health-care buildings to minimise trauma to occupants who may be confused or immobile. However, in such instances, adequate warning must always be available to staff, carers, employees and the like.

Class 9c aged care buildings — Clause 6(e)

Clause 6(e) requires warning signals to be modified in certain areas within Class 9c aged care buildings to minimise trauma to residents who may be confused or immobile. However, in such instances, adequate warning must always be available to staff, carers, employees and the like. Aged care facilities may contain more than one building. Nevertheless, staff are required to be notified irrespective of their location.

Additional provisions in E4.9

The separate provisions under **E4.9** are for emergency warning and intercommunication systems in certain buildings.

7 System monitoring

Intent

To specify the system monitoring requirements in high risk occupancies.

High risk occupancies

Clause 7 specifies the system monitoring requirements in high risk occupancies, to enable a timely and appropriate response by the local fire brigade to emergencies in such buildings as:

- certain residential, health-care and aged care buildings;
- shops and assembly buildings provided with mechanical or natural smoke extraction systems; and
- large uncompartmented factories and warehouses.

SPECIFICATION E2.2b SMOKE EXHAUST SYSTEMS**Deemed-to-Satisfy Provisions****1 Scope****Intent**

To state that **Specification E2.2b** outlines the requirements for mechanical smoke exhaust systems.

Mechanical smoke exhaust systems

Specification E2.2b contains the requirements for mechanical smoke exhaust systems.

2 Smoke exhaust capacity**Intent**

To specify the capacity and exhaust rates required of mechanical smoke exhaust systems.

Height below the smoke layer — Clause 2(a)

Clause 2(a) defines the height to be maintained to the underside of the smoke layer. This height is used to determine the smoke exhaust capacity for various design fires under steady state conditions.

Exhaust rates — Clause 2(b)

Clause 2(b) requires exhaust rates be determined using **Figure 2.1** of **Specification E2.2b**. It specifies the exhaust rate required relative to the height to the underside of the smoke layer for various fire sizes.

How to use Figure 2.1 of Specification E2.2b

The following needs to be known to use **Figure 2.1** of **Specification E2.2b**:

- The Class of the subject building or part (in the case of Class 9 buildings the use of the building will also need to be considered).
- Whether or not that building or part is to be sprinklered.
- The fire heat release rate measured in megawatts (MW).

- The MW amount is represented in **Figure 2.1** by a specific line which can be identified in the legend inserted in the Figure.

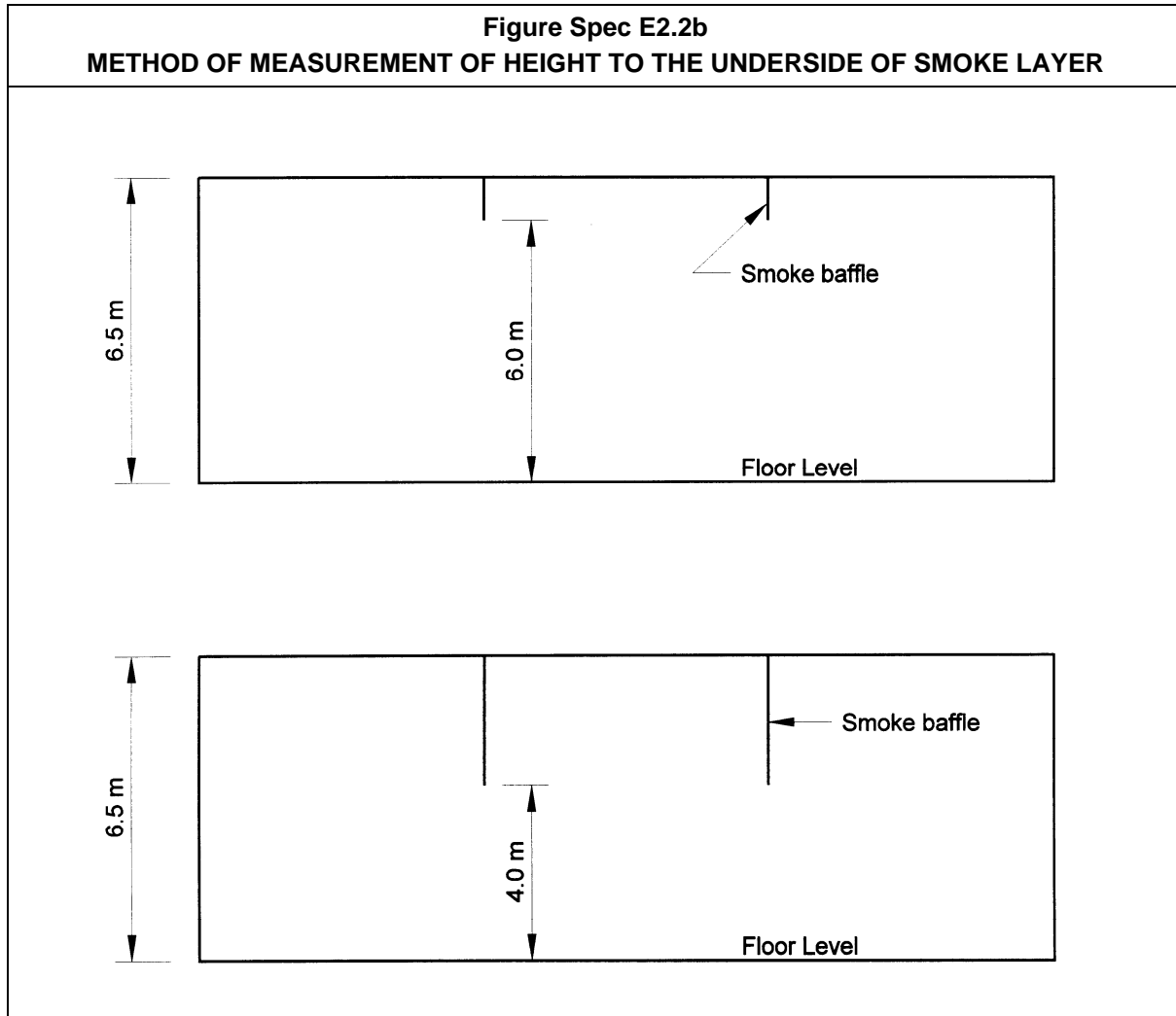

Smoke exhaust rates

The smoke exhaust rate in **Figure 2.1** of **Specification E2.2b** is based on the rate at which air is drawn (ie 'entrained') into a plume of smoke which is generally symmetrical around a vertical axis where that plume is rising into the hot layer formed by the smoke reservoir.

The height to the underside of the smoke layer is measured from the highest floor level to the underside of the smoke reservoir. The smoke reservoir's depth is determined by the depth of the smoke baffles/curtains required by **Clause 4**. See **Figure Spec E2.2b**.

3 Smoke exhaust fans

Intent

To specify the operational requirements for smoke exhaust fans.

Operational requirements for smoke exhaust fans

Clause 3 describes the operational requirements for smoke exhaust fans to ensure their design performance is maintained for an appropriate time, when operating in high temperature conditions. Fans must also be rated for ambient temperature operation to facilitate routine maintenance. These provisions also apply to dual purpose fans, that is those used for normal air-handling operations as well as for smoke exhaust.

4 Smoke reservoirs

Intent

To specify the requirements for smoke reservoirs, to enable the containment of smoke in the upper levels of compartments.

Smoke reservoirs — **Clause 4(a)**

Clause 4(a) requires the division of fire compartments into smoke reservoirs.

Smoke reservoirs are necessary to contain the hot layer in the upper levels of compartments, thus preventing the lateral spread of smoke resulting in excessive cooling and downward mixing of the smoke with the relatively clear layer below which:

- enables occupants to make their way through the comparatively clear air below the hot smoke layer; and
- maintains the smoke above any openings between compartments, thus minimising the risk that smoke will migrate to other areas.

Smoke reservoir dimensions — **Clauses 4(b) and (c)**

Horizontal area to be less than 2000 m² — **Clause 4(b)**

To maximise the effectiveness of smoke reservoirs, the horizontal area formed by a reservoir is limited by **Clause 4(b)** to 2 000 m².

Maximum length in a shopping mall — **Clause 4(b)**

The maximum length of a smoke reservoir in a shopping mall is limited by **Clause 4(b)** to 60 metres, due to the distance people would be expected to travel below a smoke layer while

evacuating to a safe place, having regard to the potential for smoke, from a fire in a mall or adjacent specialty shop, to flow into more than one reservoir.

Depth — **Clause 4(c)**

Clause 4(c) specifies that the smoke reservoir must be of ‘sufficient’ depth to contain the smoke layer.

Bulkhead or smoke baffle — Clause 4(d)

Clause 4(d) deals with the location and depth of a bulkhead or smoke baffle/curtain. Any bulkhead and smoke baffle/curtain must be non-combustible. **Clause 4(d)** applies only to multi-storey fire compartments.

Smoke needs to be contained within the floor reservoir, and so the integrity of the containment must be maintained at the edges of voids in buildings, such as atriums, by the provision of non-combustible bulkheads or baffles.

5 Smoke exhaust fan and vent location

Intent

To make sure that exhaust fans and vents do not draw clean air up through the smoke layer

Prevention of ‘plug-holing’

For a given depth of smoke layer, there is a maximum rate at which smoke can be extracted from a single inlet before air is drawn from below the smoke layer. This is sometimes referred to as ‘plug-holing’.

Where the smoke layer is relatively shallow, more than one extraction point may be needed to minimise ‘plug-holing’. It may also be necessary to distribute the extraction points to prevent the formation of stagnant regions leading to excessive cooling and downward mixing of smoke with the relatively clear air below.

Specific criteria are not given as the design is dependent on actual building layout.

6 Make-up air

Intent

To provide air to replace that being exhausted by the smoke exhaust system.

Maintainence of the smoke layer — Clause 6(a)

It is necessary to introduce ‘make-up air’ to replace the air being exhausted by the smoke exhaust system, to:

- maintain the smoke layer at a level which keeps a reasonable amount of clear air underneath; and
- minimise the risk that smoke will flow below the lower levels of the smoke reservoir and migrate to other areas.

Low velocity — Clause 6(b)

Make-up air introduced below the smoke layer must be at relatively low velocities, to minimise any disturbance to the smoke layer. Make-up air introduced at higher velocities may cause:

- smoke to be drawn down from the hot layer, called the ‘venturi effect’, leading to a loss of visibility in the space below; and
- difficulties for people attempting to exit against the in-rush of air through doorways.

Multi-storey fire compartments — Clause 6(c)

Clause 6(c) deals with the provision of make-up air across any vertical opening from the building void to the fire-affected storey. This aims to minimise the risk of smoke spreading from the fire-affected storey to other storeys.

Non-prescriptive provisions

Specific criteria are not given in Clause 6 as the design is dependent on actual building layout.

7 Smoke exhaust system control

Intent

To specify the control requirements for smoke exhaust systems and automatic make-up air arrangements.

Sequential activation — Clause 7(a)

To make sure that the smoke exhaust fan (or fans) operate in the designed manner, Clause 7(a) requires that the fans are activated sequentially by smoke detectors, and arranged in zones to match the smoke reservoir served by the fan (or fans).

Automatic shutdown — Clause 7(b)

Clause 7(b) requires air handling systems (which generally supply air to upper storeys in high rise buildings) to shut down on the activation of the smoke exhaust system where the air handling system:

- does not form part of the smoke hazard management system;
- is not an individual room unit operating at a rate of less than 1000 l/s; or

- is not a miscellaneous exhaust air system installed in accordance with Sections 5 and 11 of [AS/NZS 1668.1](#).

This requirement minimises any disturbance to the hot smoke layer and limits smoke being distributed to other non-fire-affected areas of the building by way of the system.

Clause 7(b) is subject to **Clauses 7(c)** and **(d)**.

Concessions — Clauses 7(c) and (d)

A number of additional concessions to **Clause 7(b)** are allowed, including:

- **Clause 7(c)** — systems supplying a single storey fire compartment may supply 100 per cent outside air to the non-fire-affected areas as a means of supplying make-up air for the extraction system serving fire-affected areas; and
- **Clause 7(d)** — systems supplying a multi-storey fire compartment must supply 100 per cent outside air to the non-fire-affected areas as a means of supplying make-up air for the extraction system serving fire-affected areas.

Override control — Clauses 7(e) and (f)

To allow manual control of the smoke exhaust system by the fire brigade, **Clause 7(e)** requires an override control to be located adjacent to the fire indicator panel.

In a theatre, an additional manual control must be provided in accordance with **Clause 7(f)** to allow the stage manager to control the smoke exhaust system during a performance. This is considered necessary because of any special effects which may cause a false alarm.

Electric cabling — Clause 7(g)

To reduce the risk of the smoke exhaust system failing during a fire, **Clause 7(g)** requires the electric cabling to the system's essential components to be protected from fire in accordance with [AS/NZS 1668.1](#).

8 Smoke detection

Intent

To clarify the location of the requirements for the installation of a smoke detection system.

The smoke detection requirements for smoke exhaust systems are addressed in **Clause 5** of **Specification E2.2a**. Such smoke detection systems designed to operate smoke-and-heat vents must also activate an occupant warning system.

SPECIFICATION E2.2c SMOKE-AND-HEAT VENTS**Deemed-to-Satisfy Provisions****1 Adoption of AS 2665****Intent**

To nominate [AS 2665](#) as the basis for the installation of automatic smoke-and-heat vents, and specify its limitations.

AS 2665

[AS 2665](#) is adopted as the requirement for the installation of a system of automatic smoke-and-heat vents.

Smoke-and-heat vents

Smoke-and-heat vents are dependent on the temperature of the hot smoke layer or the presence of smoke for effective operation. The area of the smoke reservoirs is, therefore, limited by [AS 2665](#) to 1500 m², which is smaller in size than that for mechanical smoke exhaust systems.

It is important to note that the maximum length of a smoke reservoir in a shopping mall is limited to 60 metres due to the distance people travel below a smoke layer while evacuating, having regard to the potential for smoke from a fire in a mall or adjacent specialty shop to flow into more than one reservoir.

[AS 2665](#) requires all smoke-and-heat vents within the same reservoir to operate simultaneously to prevent the formation of stagnant regions leading to excessive cooling and downward mixing of smoke with the clear air below.

In the event of loss of power to operating mechanisms (such as actuators or solenoids), [AS 2665](#) requires smoke-and-heat vents to fail-safe open.

Permanently open vents may be used to replace all or part of the total number of smoke-and-heat vents provided they comply with the relevant parts of [AS 2665](#).

2 Controls

Intent

To specify the controls for automatic smoke-and-heat vents.

Smoke-and-heat vents

Smoke-and-heat vents installed for smoke hazard management purposes in accordance with **Table E2.2b** must primarily be initiated on the detection of smoke to enable early operation of the vents.

Where smoke-and-heat vents are installed in Class 7 and Class 8 buildings in accordance with **C2.3(a)**, the operation of the vents by means of fusible links is considered adequate.

The smoke detection requirements for smoke exhaust systems are addressed in **Clauses 5** and **7** of **Specification E2.2a**. Such smoke detection systems designed to operate smoke-and-heat vents must also activate an occupant warning system.

Override control

It is important to note that to allow manual control of the smoke exhaust system by the fire brigade, **AS 2665** requires an override control to be located adjacent to the fire indicator panel.

PART E3 LIFT INSTALLATIONS

Objective**EO3**

All people using a building, including those with disabilities, must be able to travel safely in a lift. Lifts must help emergency services personnel to evacuate sick or injured people. Lifts should also help the fire brigade to transport fire fighters and their equipment.

Functional Statements**EF3.1**

EF3.1 only applies where a passenger lift is provided.

Under **EF3.1(a)**, the lift must be suitable for people with a disability.

Under **EF3.1(b)** and the Application provision for **EF3.1**, where a passenger lift is provided in a building with an effective height of more than 12 metres it must be suitable for the evacuation of an occupant on a stretcher.

EF3.2

In high-rise buildings and those Class 9a buildings that have patient care areas above road or open space level, a lift must be able to assist emergency services personnel such as:

- ambulance officers carrying equipment to assist a sick or injured person; and
- the fire brigade with equipment.

Lifts in these buildings must also assist with the evacuation of any person unable to use a stairway unassisted.

EF3.3

People must be warned not to use a lift during a fire or other emergencies.

EF3.3 applies to all passenger lifts, even if the building has an effective height of less than 12 metres.

Performance Requirements**EP3.1**

Under **EP3.1(a)**, where emergency lifts are required under **EP3.2**, at least one of those required lifts must have stretcher facilities. Where there is a single emergency lift it must be the stretcher lift.

Under **EP3.1(b)** and the Application provision for **EP3.1**, where passenger lifts are provided in a building which has an effective height of more than 12 metres (and **EP3.1(a)** does not apply because an emergency lift is not required under **EP3.2**), at least one of those passenger lifts must have stretcher facilities.

When a person becomes injured in a building, a stretcher may be needed to evacuate them.

EP3.1 does not contain any specification of what is acceptable as ‘stretcher facilities’. However, as a guide, **EP3.2** contains suitable dimensions for a lift car required to accommodate a stretcher.

EP3.2

In high-rise buildings (ie with an effective height of more than 25 metres), and those Class 9a buildings which have patient care areas above road or open space level, a lift must be available to aid the fire brigade and any other emergency services personnel.

EP3.2 expects that any lift described above is adequately protected in case of fire.

Emergency lifts must service the same floors as any other lift. Therefore, if a level such as a plant-room level does not have any lifts serving it, there is no necessity to provide an emergency lift service to that plant-room level.

EP3.3

A suitable notice must be provided, or other measure taken, so that people do not use a lift during a fire or other emergency. This applies to all passenger lifts, even if the building has an effective height of less than 12 metres.

EP3.4

EP3.4 should be read in conjunction with Part **D3**. Where access to upper floors is provided by lifts to satisfy Part **D3**, or where lifts are installed in a building that is required to be accessible under Part **D3**, those lifts must be suitable for use by people with disabilities.

If a lift is provided for people with a disability, then it must be designed with them in mind. As a guide, **E3.6** contains suitable provisions for such a lift. These can be adopted for the Deemed-to-Satisfy Provisions.

PART **E3** LIFT INSTALLATIONS

Deemed-to-Satisfy Provisions

E3.0 Deemed-to-Satisfy Provisions

Intent

To clarify that **EP3.1 to EP3.4** will be satisfied if compliance is achieved with **E3.1 to E3.8**.

E3.1 to E3.7 and **EP3.1 to EP3.4**

Compliance with **E3.1 to E3.8** achieves compliance with **EP3.1 to EP3.4**.

E3.1 * * * * *

E3.1 in BCA 1990 excluded Class 1 and Class 10 buildings from Part **E3**. As Class 1 and Class 10 buildings are no longer covered in Volume One of the BCA this provision is no longer necessary. This is why **E3.1** of BCA96 has been left blank.

E3.2 Stretcher facility in lifts

Intent

To require lifts to be able to accommodate a stretcher.

Under **E3.2(a)**, stretcher facilities are required in one of the emergency lifts required by **E3.4**. Where no emergency lift is required and passenger lifts are provided, then stretcher facilities are to be provided to one lift in a building with an effective height of more than 12 metres.

Where there is just a single emergency or passenger lift that lift must have stretcher facilities.

E3.2(b) sets out the minimum dimensions of a lift car to accommodate a stretcher. It is allowable to have a protuberance or an openable recess in the lift car to accommodate a stretcher with the dimensions stated.

E3.3 Warning against use of lifts in fire

Intent

To alert people to the dangers of using lifts during a fire.

E3.3 applies to all passenger lifts, even if the building has an effective height of less than 12 metres.

A suitable warning sign must be provided near a lift or lift call button, so that people do not use a lift at an inappropriate time (note that **E3.3(b)** specifies that such a sign must warn occupants against lift use during a fire).

E3.3 does not apply to small lifts, such as ‘dumb-waiters’, not intended to accommodate a person.

E3.3(b) and **Figure E3.3** specify the nature, content, and minimum dimensions for the warning sign. The size and colour of the lettering on the sign are important, so that the sign can be easily read and stand out against the background colour.

E3.4 Emergency lifts

Intent

To require that suitable lifts be available for emergency services personnel.

E3.4 only applies to buildings with an effective height above 25 metres, and in certain Class 9a buildings.

E3.4(b) clarifies that a passenger lift may be used as an emergency lift, provided it satisfies the other provisions of **E3.4**.

An emergency lift must serve all the floors in a building served by passenger lifts but is not required to serve other floors such as those containing only plant and equipment.

One emergency lift is not required to serve all floors in a building. Just as one bank of passenger lifts may serve certain floors, so may emergency lifts.

E3.4(c)(i) requires that where more than one passenger lift serves a floor, at least two emergency lifts must serve that floor.

E3.4(c)(ii) requires that if the passenger lifts are in separate shafts, the emergency lifts must also be in separate shafts. This maximises the probability of the emergency lifts operating in an emergency, by minimising the risk that a fire in one shaft will endanger both lifts. It also excludes from its requirements a lift that is within an atrium and not wholly contained within a shaft.

To protect people using an emergency lift during a fire, **E3.4(d)** requires it to be within a fire-resisting shaft in accordance with the requirements of **C2.10**.

AS 1735.2 contains specific provisions for emergency lifts. These provisions allow emergency services personnel to override the operation of the lift, including the re-call of the lift to a nominated floor. Note **E3.5** with regard to the non-applicability of Clause 12.2 of **AS 1735.2**.

The **E3.4(e)(ii)(A)** dimensions for an emergency lift in a Class 9a building serving a patient care area are to accommodate a stretcher or bed for non-ambulatory patients.

The **E3.4(e)(ii)(B)** requirement for an emergency lift in a Class 9a building serving a patient care area to be connected to a standby power supply (if the building has such a system) is in recognition of the risk likely in the event of a power failure.

Under **E3.4(e)(iii)**, all emergency lifts serving buildings with an effective height of more than 75 metres must be capable of carrying a weight of at least 600 kg. This recognises the increased difficulties emergency services personnel (particularly fire brigade officers) face in carrying heavy equipment to such heights.

E3.5 Landings

Intent

To require that safe movement be available to and from lift landings.

Under **E3.5(a)**, Clause 12.2 of **AS 1735.2** does not apply because it only requires a width of path of travel from a lift landing to an exit to be 600 mm. This is considered to be inadequate. Access to and egress from lift landings must therefore comply with **Section D**.

E3.5(b) references the fact that **Section D** includes provision for access for people with disabilities.

E3.6 Facilities for people with disabilities

Intent

To require that lifts necessary for use by people with disabilities are suitable.

E3.6 only applies when a passenger lift is required by **D3.3(a)** for vertical movement of people with disabilities. Reference to certain specific provisions of **AS 1735.12**, requires that passenger lifts have the following features:

- suitable handrails (not all people with a disability are confined to a wheelchair);
- internal floor dimensions and door widths to allow wheelchair access and egress;

- door sensors to detect a wheelchair or body parts in the open doorway and stop the door closing; and
- control buttons at a suitable height for operation by a person in a wheelchair (this may be a second set of controls) and of a suitable format for tactual and visual discernment.

Not all of [AS 1735.12](#) has been referenced by the BCA. **E3.6** is quite specific as to which elements of the Standard are referenced.

E3.7 Fire-service controls

Intent

To require fire-service controls in all passenger lifts.

By having all lift cars fitted with fire-service controls there is no confusion as to which lift car can be used by emergency services personnel, and it also increases the reliability of having an operational lift in the event of an emergency. This does not require all passenger lifts to be increased in size to take a stretcher.

E3.8 Aged care buildings

Intent

To require the installation of a lift where residents of a Class 9c aged care building are on levels not having access to a road or open space.

E3.8 applies to Class 9c aged care buildings. It requires all levels of aged care buildings to have direct access to a road or open space via a ramp or lift capable of carrying a stretcher. This is to overcome the difficulty experienced by some residents negotiating stairways and enable the use of stretcher facilities on all levels of an aged care building. It also assists with the daily functioning of the building, especially with the use of mobile baths and other equipment.

PART E4 EMERGENCY LIGHTING, EXIT SIGNS AND WARNING SYSTEMS

Objective

EO4

Provision of light, signage and warning

This Objective covers three of the basic elements required to help occupants evacuate a building in an emergency:

- light to see the evacuation route;
- signage to indicate the evacuation route; and
- warning of the emergency, so they know they need to evacuate.

Functional Statement

EF4.1

Emergency lighting — EF4.1(a)

Artificial lighting is often one of the first things to fail during a building emergency. This can significantly impair the ability of the occupants to evacuate the building. Accordingly, a building must provide adequate lighting on the failure of artificial lighting in an emergency.

Warning of occupants — EF4.1(b)(i)

Many of the emergency protection systems built into the BCA are time related, particularly those designed to protect occupants from a fire. The effectiveness of this protection may be negated if occupants are not made aware of the need to evacuate. It is essential that adequate early warning systems advise of the need to evacuate the building as soon as possible.

Evacuation management systems — EF4.1(b)(ii)

Emergency evacuation requires all evacuations to maximise the opportunity for occupants to reach a place of safety. Since the BCA generally relates to the construction of a building, rather than its on-going use, it can only require the installation of a system to assist in the management of the evacuation process. It cannot demand, for example:

- training, so that the evacuation process is undertaken automatically;

- allocation of staff to assist with evacuation, particularly if the building is likely to contain occupants who have been unable to benefit from prior training; or
- a detailed evacuation plan.

Identification of exits and paths of travel — EF4.1(b)(iii)

Occupants need to be able to identify their route to safety without hesitation. The emergency route must be signed in a way which is clear and unambiguous.

Performance Requirements**EP4.1****Emergency lighting**

The intent of **EP4.1** is to provide occupants with satisfactory emergency lighting. Such lighting must provide sufficient visual conditions in a building to aid safe evacuation during an emergency. Accordingly, it must supply sufficient light to:

- minimise the risk of panic;
- illuminate the safe route to an emergency exit; and
- otherwise assist in the orderly and safe evacuation of the building.

EP4.1 Limitations

EP4.1 does not apply within sole-occupancy units of Class 2, 3 or 9c buildings or within the Class 4 part of a building.

Operation when artificial lighting fails

An emergency lighting system in a building only needs to operate on the failure of the normal artificial lighting system (see **EF4.1(a)**).

‘To the degree necessary’

EP4.1 uses the expression ‘to the degree necessary’. The BCA recognises that not all buildings need emergency lighting.

Any decision made in this context can extend to not requiring an item to be installed or a particular level of performance to be achieved, if that is the appropriate action to be taken.

Criteria for emergency lighting

As set out in **EP4.1**, emergency lighting must be installed when necessary, and be appropriate to a number of factors, including:

- the use of the building will affect the fire load in the building;
- the size of the building's floor area which is a measure of the size of any potential fire, and the area through which occupants must travel to reach safety; and
- the distance of travel to an exit which is a measure of the distance occupants must travel to reach safety (and therefore the time necessary to reach safety).

'Appropriate to'

The lighting must be 'appropriate to' the matters listed in **EP4.1**, which relate to the amount of light in a particular building, and which is necessary to enable evacuation in an emergency.

Examples

The following are two examples of what may or may not be 'appropriate' in this case. They should not be regarded as absolute.

Commercial poultry building

A commercial poultry building:

- has a high level of natural light;
- is occupied by only a few workers, likely to know the shed well;
- is rarely occupied by humans at night;
- is without a substantial floor space accessible by humans; and
- has short and direct routes to the exit doors.

In such a case, it may be reasonable for no emergency lighting to be provided.

Cinema

A cinema, however:

- has no natural light; and
- is occupied regularly by large numbers of people who do not know the building or its evacuation plan well.

In such a case, even having no regard to the floor area or the distance of travel to an exit, it is probable that the building will require emergency illumination.

Deemed-to-Satisfy Provisions

E4.2 provides a number of examples where emergency lighting systems must be installed if the proposal being considered involves a Building Solution which utilises the Deemed-to-Satisfy Provisions.

Alternative Solutions

If an Alternative Solution is being used, it may be appropriate to assess it using **E4.2** for guidance purposes.

Standby lighting and safety lighting

The emergency lighting system should not be confused with the following:

Standby lighting

This is a term used to describe a lighting system providing a relatively high lighting level to allow normal activities to continue in case of a failure of the normal lighting system.

Example

A generator may be used to provide a 'working' level of light in case of a power failure. Such a level of light may be much more than is required to achieve a safe evacuation.

Safety lighting

This is a term used to describe a lighting system provided for the safety of occupants working near hazardous equipment or processes.

Example

The safe operation of specific equipment may require a level of lighting beyond that normally required for work conditions, and significantly beyond that required for safe evacuation.

EP4.2

Identification of exits

The intent of **EP4.2** is to provide occupants with clear and concise information on what route to take to evacuate a building in an emergency. This may require the installation of emergency signage or other suitable means to identify egress routes and exits and assist in orderly evacuation.

This information must be easily obtainable, despite the reduced lighting conditions, even though emergency lighting systems have been provided.

EP4.2 Limitations

EP4.2 does not apply within sole-occupancy units of Class 2 or 3 buildings or within the Class 4 part of a building.

'To the degree necessary'

EP4.2 uses the expression 'to the degree necessary'. The BCA recognises that not all buildings need signs or markers to facilitate evacuation.

Any decision made in this context can extend to not requiring an item to be installed or a particular level of performance to be achieved, if that is the appropriate action to be taken.

Criteria for identification of exits

A building proposal must make sure that the means used to identify egress routes and exits are sufficient to enable occupants:

- to locate the exits;
- to find their way to the exits;
- to clearly see any signs or other markers; and
- to be able to continue to see any signs or markers during their evacuation, in case of a failure of the normal lighting system.

Examples

The following are two examples of what may or may not be suitable exit identification. They should not be regarded as absolute.

Commercial poultry building

A commercial poultry building:

- has a high level of natural light;
- is occupied by only a few workers, who are likely to know the shed well;
- is rarely, if ever, occupied by people at night; and
- has direct routes to the exit doors.

In such a case, occupants will be able to easily find the way to the exits. Accordingly, exit signs would not be necessary.

Cinema

A cinema, however:

- has no natural light; and
- is occupied regularly by large numbers of people who do not know the building or its evacuation routes.

In such a case, clear and illuminated signage would be required, located in common view points to encourage evacuees to continue travelling in a specific direction.

Deemed-to-Satisfy Provisions

If a builder is undertaking a Building Solution using the Deemed-to-Satisfy Provisions, there are a number of relevant provisions regarding:

- the installation of exit signs; and
- the size, colour and wording of signs.

Alternative Solutions

If an Alternative Solution is being used, it may be appropriate to assess it using the Part E Deemed-to-Satisfy Provisions for guidance purposes.

EP4.3**Early warning and intercommunication**

The intent of **EP4.3** is to maximise the opportunities for occupants to evacuate. This may include giving them as early a warning as possible and providing means of communicating both the need for evacuation and the process of evacuation.

Evacuation management systems

Emergency evacuation requires that the evacuation maximises the opportunity for occupants to reach a place of safety. Since the BCA relates to the construction of a building it can only require the installation of a system. It cannot require:

- training, so that the evacuation process is undertaken automatically;
- allocation of staff to assist with evacuation, particularly if the building is likely to contain occupants who have been unable to benefit from prior training; or
- a detailed evacuation plan.

‘To the degree necessary’

EP4.3 uses the expression ‘to the degree necessary’. The BCA recognises that different buildings require differing types and degrees of warning and intercommunication systems for occupants in an emergency.

Any decision made in this context can extend to not requiring an item to be installed or a particular level of performance to be achieved, if that is the appropriate action to be taken.

Criteria for emergency warning and intercommunication systems

As set out in **EP4.3**, to warn occupants and assist with an evacuation, an emergency warning and intercommunication system must be appropriate to a number of factors, including:

- the floor area of the building which is a measure of the size of any potential fire, the area to be covered by a warning sound or signal, and the difficulty of intercommunication;
- the function of the building will affect the fire load in the building, and the difficulty such a load may cause in evacuating occupants; and
- the height of the building which is a measure of the difficulty of evacuation, search and rescue, and intercommunication.

‘Appropriate to’

The emergency warning and intercommunication system must be ‘appropriate to’ the matters listed in **EP4.3**, which principally relate to the type of warning and intercommunication system which is necessary to enable evacuation in an emergency.

The BCA recognises that different emergency warning and intercommunication needs may exist, depending on the size of the building, its function, use and height.

Examples

The following reveal what may or may not be ‘appropriate’. They should not be regarded as absolute.

Commercial poultry building

A commercial poultry building:

- has a comparatively small floor area accessible by occupants;
- is occupied by only a few workers, who are likely to know the shed well; and
- has good sight lines around the building.

In such a case, the ability of occupants to notice an emergency starting, particularly a fire, and their capacity to easily notify other occupants and exit quickly may mean that there is little or no need for emergency warning and communication devices.

Cinema

In a cinema, however, there is a large number of people who do not know the building or its evacuation routes.

In such a case, the building’s occupants may be:

- unlikely to notice the commencement of an emergency, which could involve electrical or equipment failure in parts of the building beyond the auditorium; and
- unlikely to automatically know when or how to exit the building.

Accordingly, there may be a need for specialised warning and communication devices.

Deemed-to-Satisfy Provisions

If the proposal being considered involves a Building Solution which utilises the Deemed-to-Satisfy Provisions, the Deemed-to-Satisfy Provisions provide a number of situations where emergency warning and intercommunication systems must be installed.

Alternative Solutions

If an Alternative Solution is being used, it may be appropriate to assess it using the Part E4 Deemed-to-Satisfy Provisions for guidance purposes.

SUPERSEDED

SUPERSEDED

PART **E4** EMERGENCY LIGHTING, EXIT SIGNS AND WARNING SYSTEMS

Deemed-to-Satisfy Provisions

E4.0 Deemed-to-Satisfy Provisions

Intent

To clarify that compliance with **EP4.1 to EP4.3** will be achieved by compliance with **E4.1 to E4.9**.

E4.0 clarifies that if compliance can be demonstrated with **E4.1 to E4.9**, then compliance has been achieved with **EP4.1 to EP4.3**.

E4.1 * * * * *

In accordance with the decision not to change the numbering of the BCA from that of the previous edition, the space previously occupied by this provision has been left blank. The previous **E4.1** provisions are now located in the BCA Performance Requirements.

E4.2 Emergency lighting requirements

Intent

To minimise the risk of death or injury to occupants during an emergency because of an inability to see their way along an exit path of travel.

Reasons for emergency lighting

See the comment on **EP4**.

Locations for emergency lighting

E4.2 sets out the locations in buildings, and in some cases the classes of building, in which emergency lighting must be installed.

Each sub-provision of **E4.2** must be considered separately. It is possible that more than one may apply to any single building. Where any sub-provision requires emergency lighting, such

lighting must be provided, even though another sub-provision may appear to provide an exemption.

Example

Consider a single storey building comprised of three open plan Class 6 sole-occupancy units of 150 m² each, where each sole-occupancy unit has one exit direct to open space:

- **E4.2(e)** specifies that emergency lighting is not required in each sole-occupancy unit (note that the 300 m² minimum in **E4.2(e)(i)** applies to an individual sole-occupancy unit); but
- **E4.2(f)** specifies that every room or space to which there is public access (in this case, each entire sole-occupancy unit — note that the 300 m² minimum in **E4.2(f)(i)** applies to the entire storey) must have emergency lighting.

In this case, as **E4.2(f)** requires emergency lighting, such lighting must be provided despite the fact that the sole-occupancy units do not require such lighting under **E4.2(e)**.

Extent of emergency lighting**All fire-isolated exits — E4.2(a)**

Emergency lighting is required to be installed in all fire-isolated exits, because it is unusual for them to be provided with sufficient amounts of natural lighting for safe evacuation.

Storeys over 300 m² in Class 5–9 buildings — E4.2(b)

Emergency lighting is required in every storey with a floor area over 300 m² in a Class 5-9 building, as follows:

- Every passageway, corridor, hallway, or the like forming part of a path of travel to an exit, because these areas are unlikely to be provided with sufficient amounts of natural lighting for safe evacuation.
- Any room larger than 100 m² which does not open to a corridor or other space containing emergency lighting, or a road or open space.
- Any room larger than 300 m². Note that this size of room is relatively large, and **E4.2(b)(iii)** applies irrespective of whether or not the room opens to a corridor or other space containing emergency lighting or a road or open space.

Class 2, Class 3 and Class 4 — E4.2(c)

Emergency lighting is required in any passageway, corridor, hallway, or the like in Class 2 and Class 3 buildings and Class 4 parts, if the distance of travel from the door leading from a sole-occupancy unit is greater than six metres to:

- a fire-isolated exit;
- an external stairway used in lieu of a fire-isolated stairway;

- an external balcony leading to a fire-isolated exit; or
- a road or open space.

This provision reflects the likelihood that such buildings will be occupied at night, when the occupants are likely to be asleep.

Non-fire-isolated stairways — E4.2(d)

Emergency lighting is required to be installed in all required non-fire-isolated stairways (note that E4.2(d) applies even if the other provisions of E4.2 do not require the installation of emergency lighting).

Sole-occupancy unit in Class 5, Class 6 or Class 9 — E4.2(e)

Emergency lighting is required to be installed in a sole-occupancy unit of a Class 5, Class 6 or Class 9 building if:

- the area of the unit is larger than 300 m²; and
- the exit from the unit does not open to the specified areas or spaces which are likely to have adequate natural lighting.

Publicly accessible room in Class 6 or Class 9b — E4.2(f)

Emergency lighting is required to be installed in every publicly accessible room or space in a Class 6 or Class 9b building if:

- the area of the storey is relatively large (ie greater than 300 m²);
- any point on the floor is more than 20 metres from the specified doorways (which is a distance compatible with Section D requirements);
- egress requires a vertical rise of 1.5 metres;
- egress requires any vertical rise, if insufficient light is not admitted from outside the building; or
- the storey provides a path of travel from another storey included in E4.2(f)(i)–(iii). In this case, once a person enters an area with emergency lighting, then that lighting must be maintained throughout the remainder of the egress path.

This provision reflects the likelihood that such buildings are used by large numbers of the public who do not have any knowledge of the building or its exits.

Class 9a — E4.2(g)

Emergency lighting is required to be installed in the specified areas in Class 9a buildings, because such buildings are used by patients who may require assistance to evacuate.

Class 9c — E4.2(h)

Emergency lighting is required to be installed throughout Class 9c aged care buildings excluding within the sole-occupancy units. The requirement is generally aligned with the principles for emergency lighting in Class 9a buildings as described above.

Required fire control centres — E4.2(i)

Emergency lighting is required to be installed in required fire control centres, because they are designed for use by the fire brigade during an emergency, such as a fire.

E4.3 Measurement of distance**Intent**

To clarify how distance must be measured for the purposes of emergency lighting required under E4.2.

Reasons for emergency lighting

See the comment on EP4.1.

To which distances does E4.3 refer?

While not specifically stated, the intention is that the distances referred to in E4.3 to be those calculated in accordance with E4.2(c) and (f)(ii).

Most direct route

The E4.2(c) and (f)(ii) distances are required to be measured the same way as those specified in Section D. See D1.15.

E4.4 Design and operation of emergency lighting**Intent**

To specify how an emergency lighting system must operate, to minimise the risk of death or injury to occupants during an emergency because of an inability to see their way along an exit path of travel.

Reasons for emergency lighting

See the comment on EP4.1.

Emergency lighting system and safe evacuation

An emergency lighting system must provide the visual conditions necessary for safe evacuation. It must be installed in accordance with AS/NZS 2293.1.

E4.5 Exit signs

Intent

To minimise the risk of death or injury to occupants during an emergency because of an inability to find an exit.

Reasons for exit signs

See the comment on **EP4.1**.

Locations of exit signs

E4.5 sets out the locations in a building requiring the installation of exit signs. Signs must be clearly visible to occupants approaching the exit. They need to be located on, above or adjacent to the specified exits and doors.

Some exemptions to E4.5

E4.7 provides some exemptions to **E4.5**. See **E4.7**.

E4.6 Direction signs

Intent

To minimise the risk of death or injury to occupants during an emergency because of an inability to find their way along an exit path of travel.

Reasons for direction signs

Exits may not be visible from all locations within a building. In such cases, exit signs with directional indicators (such as arrows) are required to clearly indicate the direction of travel to required exits.

E4.7 Class 2 and 3 buildings and Class 4 parts: Exemptions

Intent

To specify some circumstances where risk levels do not warrant compliance with **E4.5**.

Class 2 buildings — E4.7(a)

The BCA considers that the risks to occupants of units within a Class 2 building are less than those to occupants of Class 3 buildings and Class 4 parts. This is because occupants of Class 2 buildings are assumed to be more familiar with:

- the layout of their unit;
- the layout of the building within which the unit is located; and
- Class 4 parts attached to parts of a building with different (and usually greater) fire loads.

Consequently, **E4.7(a)** grants an exemption for Class 2 buildings from the need to comply with **E4.5**, on the condition that the buildings comply with certain specific provisions.

With regard to **E4.7(a)(i)**, while the size and wording of the exit sign are specified, the structure, method of attachment, or colour and the like are not specified. However, the colour of the word must contrast with that of the background. The building proponent can make this decision as long as the appropriate authority is satisfied.

With regard to **E4.7(a)(ii)**, if a suitable alternative means of notification can be found to the requirements of **E4.7(a)(i)**, it may be used. The decision is made by the building proponent, who must satisfy the appropriate authority.

Entrances to Class 2, Class 3 or Class 4 — **E4.7(b)**

The BCA assumes that the occupants of units in Class 2 or Class 3 buildings, or in Class 4 parts of a building are familiar with the layouts of their units to allow **E4.7(b)** to grant an exemption so that exit signs are not required above what is described as the ‘entrance door’, being either:

- the main door from the unit into the remainder of the building; or
- the door leading directly outside from the unit.

E4.8 Design and operation of exit signs

Intent

To specify how exit signs must be designed and operate, to minimise the risk of death or injury to occupants during an emergency because of an inability to find an exit.

Criteria for exit signs

E4.8 sets out the provisions for required exit signs, which must meet the following criteria:

- they must be visible at all times when the building is occupied by a person who has a legal right of entry. Exit signs have a function during normal periods to make occupants aware of the location of exits; and
- the system must be installed in accordance with [AS/NZS 2293.1](#).

E4.9 Emergency warning and intercommunication systems

Intent

To minimise the risk of death or injury to occupants through lack of knowledge that an emergency exists or an evacuation is required.

Reasons for emergency warning systems

See the comment on **EP4.3**.

Types of buildings requiring such a system

E4.9 sets out the types of buildings requiring the installation of an emergency warning and communication system.

AS 2220 Parts 1 and 2

Building proposals using the **Deemed-to-Satisfy Provisions** to achieve the **Performance Requirements** must comply with **AS 2220 Parts 1 and 2**, wherever they are applicable.

Building with an effective height of more than 25 metres — **E4.9(a)**

In a building with an effective height of more than 25 metres, if a fire starts on one floor, there is a considerable risk that occupants of the other floors might not be aware it has started. Co-ordination of the evacuation process is important. This reduces confusion and congestion in the stairways and accordingly the time taken for the evacuation.

The people most at risk

In a building fire, the highest degree of risk is attached to such people as the very young, people with certain types of disability (such as a mobility disability), the elderly, and those asleep.

The BCA cannot address all possible permutations of people who are likely to be in any particular building. Nonetheless, it does attempt to address the risks that are most likely to be attached to the people most likely to be in particular types of building.

Installation for larger buildings

In most cases, the need to install an emergency warning and communication system only applies to larger buildings. The reason for this requirement is the heightened risk that occupants may not be aware of a fire in another part of the building.

[End of tab division]

Residential aged care and Class 9a buildings

In Class 3 residential aged care buildings and in Class 9a buildings, many of the occupants or patients are unable to evacuate without assistance. There is also an enhanced risk in many of these buildings that residents or patients will be traumatised by loud or insistent alarms. To minimise this risk, the warning and intercommunication system:

- must be arranged to warn occupants, including staff, residents and patients; and
- may be adjusted to take account of any special issues regarding residents or patients.

It should be noted that **E4.9** does not apply to aged care buildings. The reference to aged persons in **E4.9(b)(ii)** is not a reference to an aged care building as defined in the BCA. The reference is intended to apply to a Class 3 building used to accommodate the listed people, but not an aged care building. During an evacuation staff would be assisting the occupants to evacuate and would not be expected to perform the function of fire wardens.

SECTION **F**

HEALTH AND AMENITY

- F1** **Damp and Weatherproofing**
- F2** **Sanitary and Other Facilities**
- F3** **Room Sizes**
- F4** **Light and Ventilation**
- F5** **Sound Transmission and Insulation**

SECTION F CONTENTS

	Page
Part F1 Damp and Weatherproofing	16,021
Objective FO1	
Functional Statements FF1.1 — FF1.3	
Performance Requirements FP1.1 — FP1.7	
F1.0 Deemed-to-Satisfy Provisions	
F1.1 Stormwater drainage	
F1.2 *****	
F1.3 *****	
F1.4 *****	
F1.5 Roof coverings	
F1.6 Sarking	
F1.7 Water proofing of wet areas in buildings	
F1.8 *****	
F1.9 Damp-proofing	
F1.10 Damp-proofing of floors on the ground	
F1.11 Provision of floor wastes	
F1.12 Sub-floor ventilation	
F1.13 Glazed assemblies	
Part F2 Sanitary and Other Facilities	16,251
Objective FO2	
Functional Statements FF2.1 — FF2.3	
Performance Requirements FP2.1 — FP2.6	
F2.0 Deemed-to-Satisfy Provisions	
F2.1 Facilities in residential buildings	
F2.2 Calculation of number of occupants and fixtures	
F2.3 Facilities in Class 3 to 9 buildings	
F2.4 Facilities for people with disabilities	
F2.5 Construction of sanitary compartments	
F2.6 Interpretation: Urinals and washbasins	
F2.7 Microbial (legionella) control	
F2.8 Waste management	

	Page
Part F3 Room Sizes	16,451
Objective FO3	
Functional Statement FF3.1	
Performance Requirement FP3.1	
F3.0 Deemed-to-Satisfy Provisions	
F3.1 Height of rooms and other spaces	
Part F4 Light and Ventilation	16,551
Objective FO4	
Functional Statements FF4.1 — FF4.3	
Performance Requirements FP4.1 — FP4.5	
F4.0 Deemed-to-Satisfy Provisions	
F4.1 Provision of natural light	
F4.2 Methods and extent of natural lighting	
F4.3 Natural light borrowed from adjoining room	
F4.4 Artificial lighting	
F4.5 Ventilation of rooms	
F4.6 Natural ventilation	
F4.7 Ventilation borrowed from adjoining room	
F4.8 Restriction on position of water closets and urinals	
F4.9 Airlocks	
F4.10 * * * * *	
F4.11 Carparks	
F4.12 Kitchen local exhaust ventilation	
Part F5 Sound Transmission and Insulation	16,751
Objective FO5	
Functional Statement FF5.1	
Performance Requirements FP5.1 — FP5.4	
F5.0 Deemed-to-Satisfy Provisions	
F5.1 Application of Part	
F5.2 Weighted sound reduction index: Interpretation	
F5.3 Sound insulation of floors between units	

	Page	
F5.4	Sound insulation of walls between units	
F5.5	Walls between a bathroom, sanitary compartment, laundry or kitchen and a habitable room in adjoining unit	
F5.6	Soil and waste pipes to be separated	
F5.7	Isolation of pumps	
F5.8	Walls between a bedroom and kitchen or laundry in a Class 9c building	
Specification F5.2	Sound Insulation for Building Elements	
Specification F5.5	Impact Sound - Test of Equivalence	

PART F1 DAMP AND WEATHERPROOFING

Objective**FO1****Safeguard occupants and protect the building — FO1(a)**

FO1(a) aims to minimise the risk of water leaking into or accumulating within a building and causing musty, damp and unhealthy conditions or damaging building elements by corrosion.

Examples

- Damp conditions in houses can cause serious diseases. What appear to be less serious illnesses, such as colds, can have serious consequences, particularly for children and the elderly.
- Rotten floorboards can collapse, causing injury.
- Electrical connections can corrode, causing failure of safety devices, or increasing the risk of electrocution.
- Penetration of moisture into building elements can cause degradation to a building long before the damage is detected.

Protect other property from damage — FO1(b)

FO1(b) aims to minimise the risk of other property being damaged by surface water redirected from a building or any associated sitework.

Example

Construction on an allotment must not cause re-directed water damage to ‘other property’, including:

- any building on the same allotment;
- any building on an adjoining allotment;
- any adjoining allotment (whether there is a building on it or not); and
- any road.

Functional Statements**FF1.1****Protection from re-directed surface water**

People and other property are to be protected from any problems caused by surface water re-directed by a building and any sitework involved in its construction. Remedial works must be undertaken to dispose of any surface water which, because of any variation or addition to its flow caused by any building or sitework, causes harm to people or other property.

FF1.2**Resistance to rain, surface water and ground water**

A building must resist:

- rain water, coming through the roof or walls, due to poor waterproofing or flashing;
- surface water, coming through openings which are too low; and
- ground water, which could rise up through porous floors or walls.

Ground water could enter a building if there are inadequate damp-proof courses or vapour barriers installed, or if other ways of resisting the rising damp have not been provided.

FF1.3**Overflow from bathrooms and laundries**

The development of unhealthy conditions or damage caused by dampness or overflow from bathrooms, laundries and the like, must be prevented. Such problems may arise from showers and bathrooms being incorrectly sealed, allowing water to leak into other parts of the building.

Performance Requirements**FP1.1****Surface water from a 1 in 20 year storm**

Surface water from a 1 in 20 year storm collected or concentrated by a building or sitework must be disposed of without damage to other property.

Construction should not cause stormwater problems on other properties, worse than those which existed previously.

Example

As a general rule, undeveloped land tends to absorb rainwater, usually resulting in comparatively slow run-off.

However, a building's hard surfaces, such as roofs and pavements, cause comparatively quick run-off. Consequently, the design of the surface-water disposal system must make provision for run-off stormwater from hard surfaces collected or concentrated by a building or sitework.

Why 1 in 20 year storms?

The storm intensity has been limited to a 1 in 20 year storm. This is considered an appropriate limit, fair on the person responsible for the building and siteworks and the person responsible for properties affected by re-directed surface water.

FP1.2**Surface water from a 1 in 100 year storm**

Building and siteworks must be arranged so that surface water from a 1 in 100 year storm does not enter a building.

Why 1 in 100 year storms?

A 1 in 20 year storm has a less intense flow of water than a 1 in 100 year storm, which is what the subject building must be protected from.

It is considered more important to prevent water entering a building than it is to prevent water entering a neighbouring allotment or property.

Limitations

The limitations contain several exemptions to **FP1.2**. These are based on the belief that the use and safety levels of the exempted buildings will not be significantly diminished by surface water entering them.

Limitation (a) regarding Class 7 and Class 8 buildings refers only to such buildings which, in a particular case, do not exhibit any need for compliance with **FP1.2**. Such buildings must be considered on a case-by-case basis. However, it is the responsibility of a building proponent to satisfy the appropriate authority that the exemption should apply.

FP1.3**Outfall, water entrance and water damage**

Under **FP1.3(a)**:

- a drainage system for surface-water disposal must have an appropriate outfall and avoid damage to the building;
- outfall includes a kerb and channel, a soakage system, and a natural watercourse; and
- the decision as to what is acceptable is made by the appropriate authority.

Under **FP1.3(b)**, a drainage system for the disposal of surface water must avoid water entering a building. This provision is intended to prevent water causing internal damage to a building, or causing injury or illness to occupants.

The **FP1.3(b)** prohibition on water entering the building:

- does not prohibit a drainage system that passes drainage water through a building (probably by way of pipes) without causing damage; and
- clearly does not prohibit water entering a building when it is required for various purposes.

Under **FP1.3(c)**, a drainage system for the disposal of surface water must avoid water damaging a building. Such damage could be caused by a building's subsidence.

FP1.4**Roofs and walls to prevent water penetration**

Roofs and walls (including openings around windows and doors) must prevent water penetration which could cause dangerous conditions, loss of amenity or dampness and deterioration of building elements.

Limitations

The limitations contain several exemptions to **FP1.4**. These are based on the belief that the use and safety levels of the exempted buildings will not be significantly diminished by water entering them.

Limitation (a), regarding Class 7 and Class 8 buildings, refers only to such buildings which, in a particular case, do not exhibit any need for compliance with **FP1.4**. Such buildings must be considered on a case-by-case basis. However, it is the responsibility of a building proponent to satisfy the appropriate authority that the exemption should apply.

FP1.5

Moisture from the ground

Building elements must be protected from deterioration and occupants must be protected from unhealthy or dangerous conditions or a loss of amenity caused by moisture from the ground (causing such problems as rot, rising damp, rust, and so on). In essence, this requires that the materials and components which make up building elements must either be fit for this purpose or made fit by protection.

Examples

The following may be acceptable to achieve compliance with **FP1.5**. They should not be regarded as absolute.

- damp-proof course in masonry walls above finished ground level;
- vapour barrier under a concrete slab;
- adequate sub-floor ventilation;
- painted or other similar protective coatings on steel and timber on or near ground level;
- appropriate concrete cover on steel reinforcing;
- galvanised coatings on steel; and
- specific concrete mixes to achieve required protection levels.

FP1.6

Water overflows from bathrooms and laundries

Water overflows from bathrooms, laundries and the like must be prevented from penetrating downwards — ie to a storey below — to either another sole-occupancy unit used for sleeping accommodation or a public space. Such overflows are potentially unhealthy and structurally damaging, and can be disruptive for neighbours.

FP1.7

Water — fittings, linings and concealed spaces

The structure of a building and the amenity of its occupants must be protected by preventing water from penetrating behind fittings and linings and into concealed spaces of toilets, bathrooms, laundries and the like.

SUPERSEDED

SUPERSEDED

PART **F1** DAMP AND WEATHERPROOFING

Deemed-to-Satisfy Provisions

F1.0 Deemed-to-Satisfy Provisions

Intent

To clarify that the requirements of **FP1.1 to FP1.7** will be satisfied if compliance is achieved with **F1.1 to F1.13**.

FP1.4 No Deemed-to-Satisfy for external walls

The BCA does not contain any **Deemed-to-Satisfy Provisions** which can be followed as a means of complying with **FP1.4** for water penetration through external walls. However, it is still compulsory to comply with this **Performance Requirement**.

This approach has not changed from the previous edition of the BCA.

F1.1 Stormwater Drainage

BCA 96 now requires compliance with [AS/NZS 3500.3.2](#) to achieve compliance with the **Performance Requirements**.

F1.2 * * * * *

FP1.1–FP1.3 and FP1.5

The BCA96 Performance Requirements **FP1.1–FP1.3** and **FP1.5** contain the Performance Requirements of F1.1–F1.4 and F1.8 of BCA 1990. This is the reason why **F1.2** of the BCA96 has been left blank, in accordance with the decision to retain the numbering of BCA 1990 for BCA96.

F1.3 * * * * ***FP1.1–FP1.3 and FP1.5**See **F1.2**.**F1.4** * * * * ***FP1.1–FP1.3 and FP1.5**See **F1.2**.**F1.5** **Roof coverings****Intent**

To prevent water penetration of roofs which could cause:

- (1) unhealthy and dangerous conditions or loss of amenity for occupants; or
- (2) dampness and deterioration of building elements.

Roofing materials and fixing methods

F1.5 contains reference to Australian Standards and other reference documents for a range of roofing materials and fixing methods suitable for the prevention of water penetration.

Concrete and terracotta tiles — cyclonic areas

F1.5(a) and **(b)**, with regard to the use of concrete and terracotta roofing tiles, are not applicable to cyclonic areas, because the [AS 2050](#) fixing details are inadequate for use in such areas. Accordingly, fixing in cyclonic areas must be approved by the appropriate authority.

F1.6 **Sarking****Intent**

To prevent water penetration of roofs and walls which could cause:

- (1) unhealthy and dangerous conditions or loss of amenity for occupants; or
- (2) dampness and deterioration of building elements.

Sarking to comply with AS/NZS 4200 Parts 1 and 2

F1.6 references the Standard for sarking materials where sarking is required for weatherproofing roofs and walls (eg under roof tiles or on walls before weatherboards are fixed).

F1.7 Water proofing of wet areas in buildings

Intent

To prevent water penetration from wet areas in buildings which could cause:

- (1) unhealthy and dangerous conditions or loss of amenity for occupants; or
- (2) dampness and deterioration of building elements.

Wet areas to be impervious to water

F1.7 requires that certain areas designated as ‘wet areas’ be made impervious to water. This includes showers, floors and walls adjacent to baths, tubs or laundry troughs, basins or sinks. The aim is to protect adjacent areas from damage by water splashed from these fixtures.

Parts required to be impervious — **F1.7(a)**

Floor of a shower — **F1.7(a)(i)**

The floor surface or substrate of a shower is required by **F1.7(a)(i)** to be impervious to water. The impervious floor must cover:

- the entire area within any shower enclosure; or
- if there is no enclosure, 1.5 metres horizontally from a point immediately below the shower fitting.

Floor surface in Classes 3 and 5–9 — **F1.7(a)(ii)**

The floor surface or substrate of the rooms listed in **F1.7(a)(ii)**, which can be used in common by most occupants in a Class 3 building, and Class 5-9 buildings, must be impervious to water. This requirement is both for hygiene purposes, and for protection of the building fabric.

Floor wastes in Classes 2, 3 and 4 — **F1.7(a)(iii)**

To eliminate the overflow from bathrooms and laundries in a Class 2 or Class 3 building or Class 4 part from damaging a unit below, **F1.11** requires the floor of the room to have a floor waste. **F1.4(a)(iii)** then requires the floors of those rooms to be impervious to water.

Wall of a shower — **F1.7(a)(iv)(A)**

The wall surface or substrate of a shower enclosure is required by **F1.7(a)(iv)(A)** to be impervious to water. The extent of the impervious wall required, where there is not a shower enclosure, is similar to that required for the shower floor in **F1.7(a)(i)**. For an example of the extent of the impervious wall see above.

Baths, troughs, basins, sinks, etc — **F1.7(a)(iv)(B)**

To eliminate possible water or moisture damage to walls around baths, troughs, basins, sinks, and so on as listed in **F1.7(a)(iv)(B)**, ie when within 75 mm of the wall, the wall surface or substrate adjacent to them must be impervious to water. The extent of the impervious wall is illustrated in **Figure F1.7(1)**.

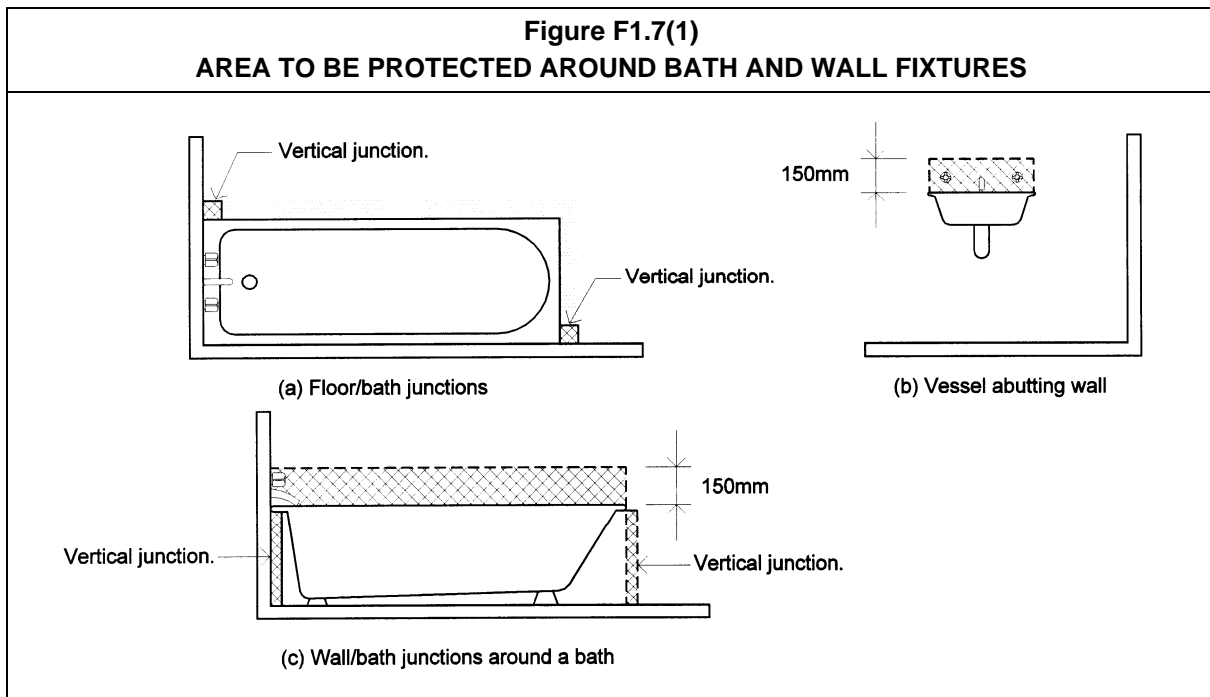

Shower above a bath — **F1.7(a)(i) and (iv)**

When a shower is situated above a bath, it is necessary to comply with **F1.7(a)(i)** and **(a)(iv)**. See **Figure F1.7(2)**.

Junction of a wall and floor — **F1.7(a)(v)**

To stop moisture penetration at a junction of a wall and floor which are both required to be impervious, **F1.7(a)(v)** requires the junction also to be impervious.

Figure F1.7(2)
AREA TO BE PROTECTED AROUND SHOWERS ABOVE BATHS

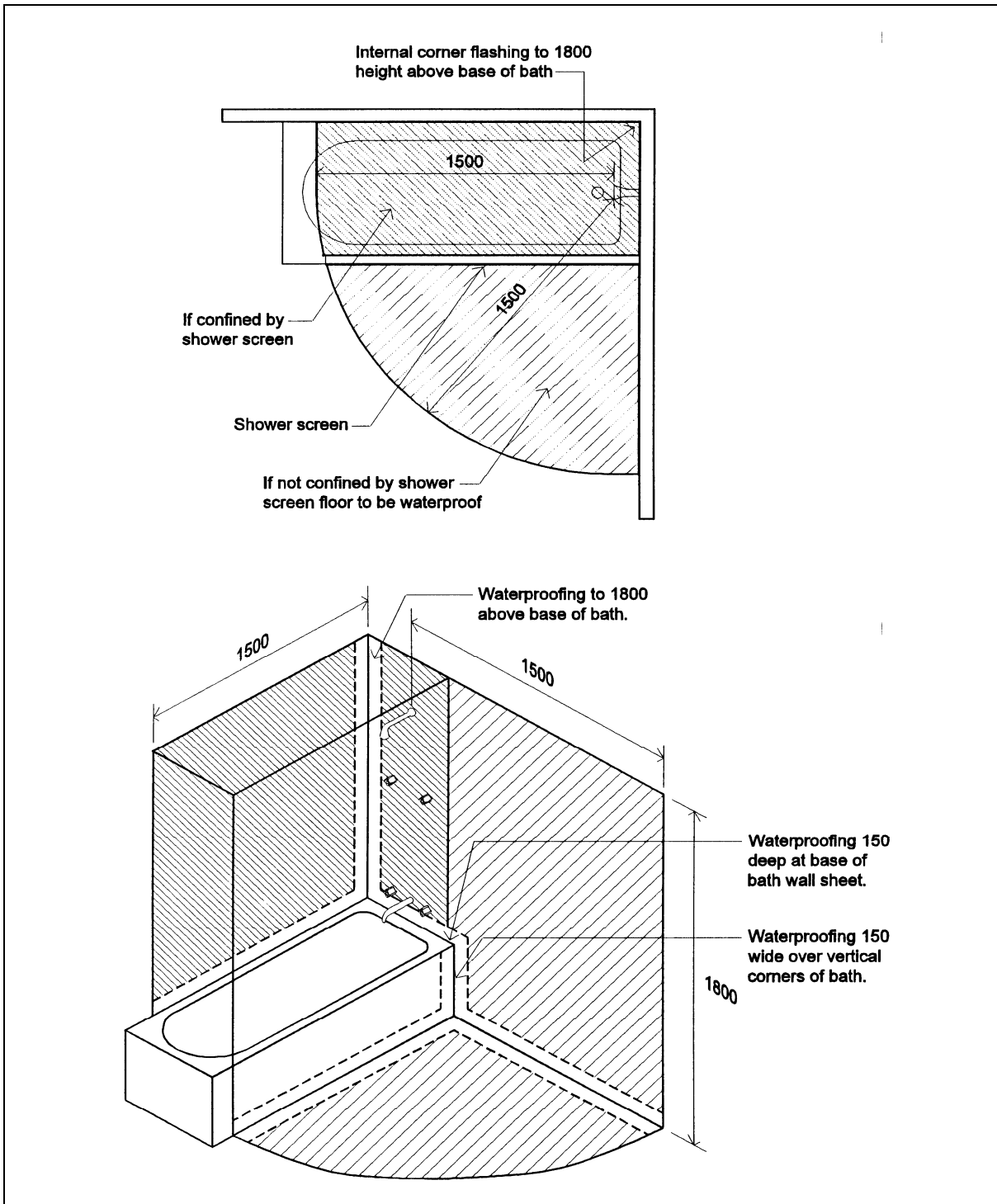

Junction of a wall and a fixture — F1.7(a)(vi)

To stop moisture penetration at a junction of a wall required to be impervious, and a fixture, **F1.7(a)(vi)** requires the junction also to be impervious. The intent is that this provision apply only to those fixtures listed elsewhere in **F1.7(a)**.

Surface or substrate

Various parts of **F1.7(a)** require either a floor surface or substrate, or a wall surface or substrate, to be impervious to water. In each case the designer has the choice of which is made impervious (ie either the surface or the substrate).

Adoption of AS 3740 — F1.7(b)

F1.7(b) requires that the water proofing required by **F1.7(a)** be in accordance with the relevant parts of AS 3740.

F1.8 * * * * *

The BCA96 Performance Requirements **FP1.1–FP1.3** and **FP1.5** are identical to F1.1–F1.4 and F1.8 of BCA 1990. This is the reason why **F1.8** of the BCA96 has been left blank, in accordance with the decision to retain the numbering of BCA 1990 for BCA96.

F1.9 Damp-proofing**Intent**

To prevent moisture from the ground penetrating a building where it could cause:
 (1) unhealthy and dangerous conditions or loss of amenity for occupants; or
 (2) dampness and deterioration of building elements.

Damp must not rise from the ground — F1.9(a)

Damp must be prevented from reaching:

- a building's lowest floor timbers;
- suspended concrete floors or other suspended floors;
- supporting beams or girders; and
- walls above damp-proof courses.

Damp-proof course — AS/NZS 2904 or AS 3660.1 — F1.9(b)

AS/NZS 2904 and AS 3660.1 are referenced as alternative options for damp-proof course materials and installation details.

Exemptions — F1.9(c)

F1.9(c) contains exemptions to **F1.9(a)** because the safety level of buildings will not be significantly diminished by moisture from the ground.

F1.9(c)(i) regarding Class 7 and Class 8 buildings refers only to such buildings which, in a particular case, do not exhibit any need for compliance with **F1.9**. Such buildings must be considered on a case-by-case basis. However, it is the responsibility of a builder to satisfy the appropriate authority that the exemption should apply.

F1.10 Damp-proofing of floors on the ground**Intent**

To prevent moisture from the ground penetrating a building where it could cause:

- (1) unhealthy and dangerous conditions or loss of amenity for occupants; or
- (2) dampness and deterioration of building elements.

Damp must not rise from the ground

F1.10 covers floors resting on the ground. The aim is to prevent ground dampness causing:

- unhealthy and dangerous conditions or loss of amenity for occupants; or
- dampness and deterioration of building elements (which, in this case, includes surfaces and linings inside the building, such as floor tiles, wall paint and the like).

Vapour barriers — AS 2870

AS 2870 is referenced for acceptable materials and installation details for vapour barriers to stop ground moisture reaching the upper surface of floors and walls.

Exemptions — F1.10(a) and (b)

Exemptions apply to **F1.10** where:

- weatherproofing is not required for Class 7 or Class 8 buildings where there is no necessity for compliance, sheds forming part of a building used for other purposes, and so on (see the Limitations to **F1.4** for a listing of exempted buildings); and
- the base of a stairway or lift or similar shaft is suitably drained.

Figure F1.10 illustrates a method of installing damp-proofing in sub-floor structures.

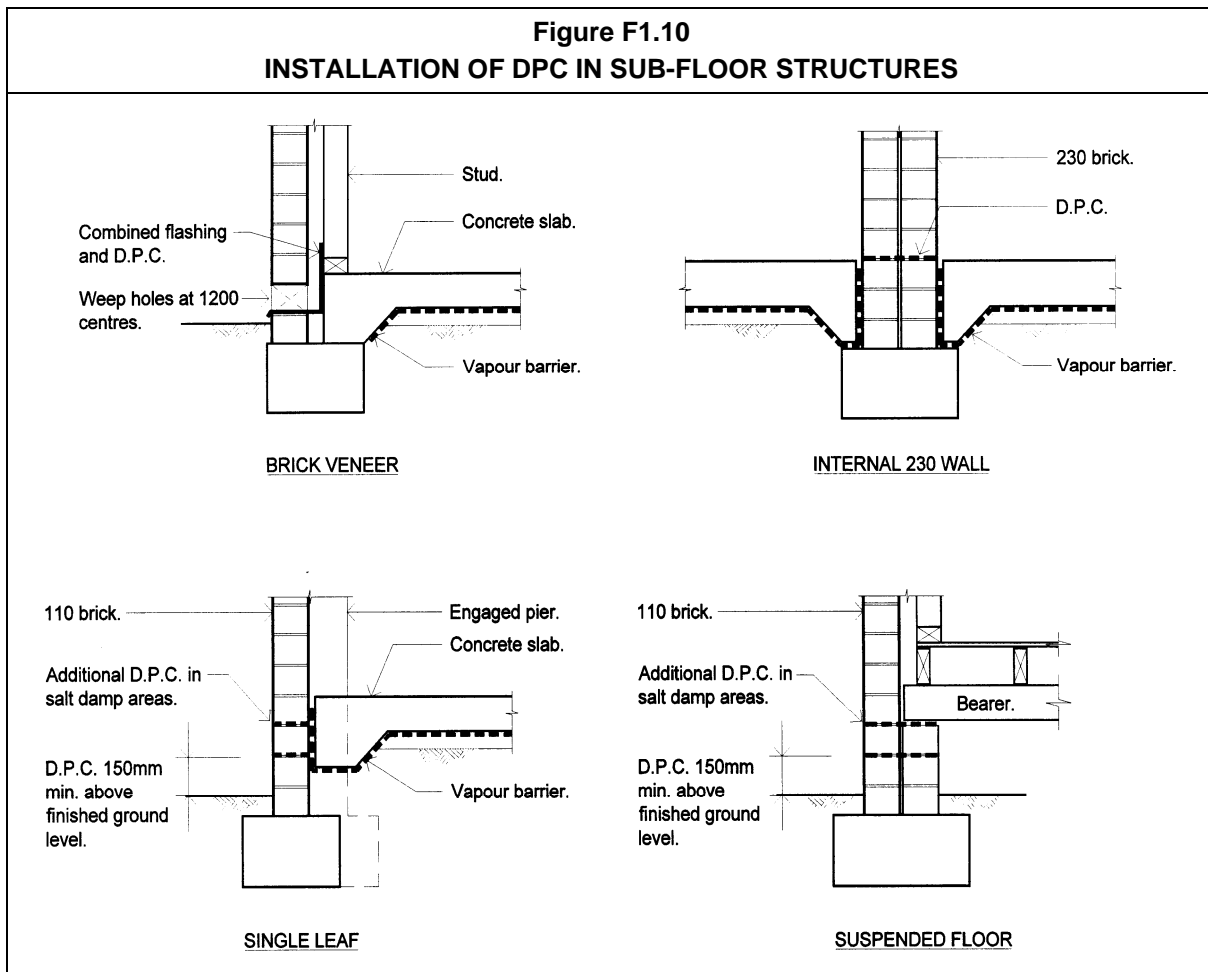

F1.11 Provision of floor wastes

Intent

To prevent water from any bathroom or laundry in Class 2 and Class 3 buildings or Class 4 parts from penetrating any sole-occupancy unit or public space, which is in a level below, which could cause:

- (1) unhealthy and dangerous conditions or loss of amenity for occupants; or
- (2) dampness and deterioration of building elements.

Floor wastes are to be installed in bathrooms and laundries in Class 2 and Class 3 buildings and Class 4 parts, where those bathrooms and laundries are above another sole-occupancy unit or public space.

The aims of this requirement are to minimise water overflows from fixtures in the specified rooms:

- causing costly and possibly dangerous water damage to other sole-occupancy units;
- creating unhealthy conditions in public spaces in buildings; and
- disrupting and intruding on neighbours in the unit below.

F1.12 Sub-floor ventilation

Intent

To prevent rising dampness which could cause:

- (1) unhealthy and dangerous conditions or loss of amenity for occupants; or
- (2) dampness and deterioration of building elements.

Sub-floor ventilation is cross ventilation of the sub-floor space between the underside of the floor and ground surface under the lowest suspended floor of a building.

Ground moisture rising into or entering the sub-floor space can create a damp environment which encourages timber rot and fungus growth. Sub-floor ventilation increases air flow, reducing any damaging water vapour in the sub-floor space.

Factors that can affect achieving satisfactory levels of sub-floor ventilation include height above ground, prevailing breezes (air transfer), differential temperature and humidity between the sub-floor and the external environment and good building practice.

The amount of sub-floor ventilation required for a building is related to the relative humidity likely to be encountered in that location. For the purposes of the **Deemed-to-Satisfy Provisions**, Australia has been divided into three broad climatic zones based on the prevailing relative humidity.

The climatic zones were determined by analysis of the average relative humidity at 9 am and 3 pm in January and July. The season with the highest relative humidity is used. Generally this is July for southern Australia and January for northern Australia. The climatic zone limits are described in **Figure F1.12**.

Table F1.12 specifies the minimum amount of sub-floor ventilation openings and height of sub-floor framing members above ground level for the three climatic zones illustrated in **Figure F1.12**. The table allows sub-floor ventilation rates to be halved if the ground within the sub-floor space is sealed by an impervious membrane because humidity levels in the space will not be affected by moisture from the soil.

F1.12(g) specifies additional requirements for preventing deterioration of sub-floor members where the ground or sub-floor space is excessively damp, as would occur in areas with high water tables, poor drainage or in areas frequently affected by flooding or water inundation.

F1.13 Glazed assemblies**Intent**

To prevent water penetration of windows which could cause:

- (1) unhealthy and dangerous conditions or loss of amenity for occupants; or
- (2) dampness and deterioration of building elements.

F1.13 requires windows, etc to comply with the [AS 2047](#) requirements for resistance to water penetration. The provision does not apply to:

- some Class 7 and 8 buildings;
- garages, tool sheds, sanitary compartments and the like forming part of a building used for other purposes; and
- open spectator stands and open-deck car parks.

The exemptions are consistent with limitations in [FP1.4](#) (see [FP1.4](#)).

PART F2 SANITARY AND OTHER FACILITIES

Objective

FO2

FO2 is based on the concept that occupants must be:

- protected from illness caused by infection and a lack of adequate personal-hygiene facilities;
- protected from loss of amenity due to a lack of adequate hygiene facilities;
- be provided with appropriate laundering and cooking facilities; and
- able to be removed from sanitary compartments in an emergency.

Examples

- The BCA requires sanitary facilities to be installed at a rate based on the number of people in a building. If insufficient, unacceptable queuing may result.
- Loss of amenity can occur if users are not provided with sufficient privacy.

Adequate laundry and cooking facilities should be available to health-care buildings and early-childhood centres, as well as residents of Class 2 buildings and Class 4 parts.

Functional Statements

FF2.1

To achieve **FO2**, a building must be provided with:

- sanitary and personal-hygiene facilities suitable to the building's functions; and
- adequate means for the prevention of contaminants to hot water, warm water and cooling water systems.

FF2.2

Health-care buildings, early-childhood centres, Class 2 buildings and 9c buildings and Class 4 parts must be provided with laundry facilities. Under the **FF2.2** Application provision, **FF2.2** does not apply to any other buildings.

Class 2 buildings and 9c buildings and Class 4 parts are required to have laundry facilities because occupation is generally of a permanent nature. Laundry facilities are not required in other buildings. For example, a hotel, motel or boarding school may have its own laundry facilities, or have an arrangement with a commercial laundry. Sole-occupancy units in Class 3 buildings are not occupied by the same people for extended periods of time, so they are not required to be provided with laundry facilities.

FF2.3

Health-care buildings, early-childhood centres, Class 2 buildings and 9c buildings and Class 4 parts must be provided with cooking facilities. Under the **FF2.3** Application provision, **FF2.3** does not apply to any other buildings.

As for laundry facilities, Class 2 buildings and 9c buildings and Class 4 parts are required to have cooking facilities because their occupation is generally of a permanent nature. Cooking facilities are also required in health-care buildings and early-childhood centres because the occupants of these places may require specific types of food not easily available from outside (eg special dietary needs).

Cooking facilities are not required in other buildings. For example, a hotel, motel or boarding school may have its own cooking facilities, have an arrangement with a commercial caterer, or choose to have no cooking facilities at all. It is assumed that the same people do not occupy sole-occupancy units in Class 3 buildings for extended periods of time, so they are not required to be provided with cooking facilities.

FF2.4

Sanitary compartments are to be constructed so that unconscious occupants are able to be removed.

Performance Requirements**FP2.1**

FP2.1 recognises that the number, type and location of sanitary facilities are dependent on:

- what the building is used for; and
- the number, gender and particular needs of the occupants.

FP2.2

Health-care buildings, early-childhood centres, Class 2 and 9c buildings and Class 4 parts must be provided with either:

- laundry facilities; or
- space for laundry facilities.

A building's function or use will determine the appropriate number and location of the laundry facilities or space.

FP2.3

Health-care buildings, early-childhood centres, Class 2 and 9c buildings and Class 4 parts must be provided with adequate cooking facilities. This means:

- washing facilities for both food and utensils used for the preparation and consumption of food, in conjunction with adequate waste-water disposal;
- a means of cooking food, which may be either fixed in place (such as a wall-mounted oven) or a removable appliance (such as a microwave unit) ; and
- space to allow food to be prepared.

FP2.4

Class 9a and 9c buildings with wards or bedrooms must have facilities for emptying bedpans and the like, such as a slop hopper.

FP2.5

Sanitary compartments are to be large enough or have another suitable means that enables the removal of an unconscious occupant.

FP2.6

Buildings must have hot water, warm water and cooling water installations that minimise the risk of major disease outbreak caused by the harmful levels of micro-organisms.

This Performance Requirement does not apply to a system serving only a single sole-occupancy unit in a Class 2 or 3 building or Class 4 part.

PART F2 SANITARY AND OTHER FACILITIES

Deemed-to-Satisfy Provisions

F2.0 Deemed-to-Satisfy Provisions

Intent

To clarify that complying with Part F2 will satisfy the requirements of FP2.1–FP2.6.

F2.1 Facilities in residential buildings

Intent

To specify the minimum acceptable sanitary, bathing, laundry and cooking facilities required in Class 2 buildings, Class 3 buildings (for residents only), Class 9c buildings (for residents only) and Class 4 parts.

F2.1 and **Table F2.1** lists the type and number of facilities required in Class 2 buildings, Class 3 buildings (for residents only), Class 9c buildings (for residents only) and Class 4 parts. The reason that aged care buildings are included is that they are regarded as residential buildings because they are the residents' home. All the listed facilities are to be provided separately.

For laundry facilities — Class 2 buildings and Class 4 parts must be provided with a means to wash clothes. In Class 2 buildings, laundry facilities must be provided as follows:

- within each sole-occupancy unit:
 - at least one washtub; and
 - at least one space for a washing machine; or
- as a separate group for each four (or less) sole-occupancy units:
 - a washtub; and
 - at least one washing machine.

Example

In a Class 2 or Class 3 building or Class 4 part, a washbasin and a washtub are required. Although the placing of laundry facilities in a bathroom is permitted, a separate washbasin and washtub are still required.

Class 4 parts must be provided with at least one washtub and at least one space for a washing machine.

For drying clothes — Class 2 buildings and Class 4 parts must be provided with some means to dry clothes. In Class 2 buildings, clothes-drying facilities must be provided as follows:

- within each sole-occupancy unit:
 - at least 7.5 metres of drying line; or
 - at least one space for a drying cabinet or appliance; or
- as a separate group for each four (or less) sole-occupancy units:
 - at least 7.5 metres of drying line; or
 - at least one drying cabinet or appliance.

Class 4 parts must be provided with at least one clothesline or hoist; or at least one space for a drying cabinet or appliance.

For food — in Class 2 buildings (in each sole-occupancy unit) and Class 4 parts, the following must be provided:

- at least one kitchen sink; and
- facilities for the preparation and cooking of food (see **FP2.3**).

For bathing and toiletry in residences — at least either one bath or shower, and at least one closet pan and one washbasin must be provided:

- in each sole-occupancy unit in Class 2 buildings;
- for each 10 residents (or less) in a Class 3 building or group of buildings for whom private facilities are not provided (note the concession where urinal facilities are provided); and
- in each Class 4 part.

For staff toilets — eleven or more Class 2 sole-occupancy units in either one building, or several buildings, on an allotment must have a toilet and handbasin for use by maintenance or ground staff who, when working on the allotment, may not have access to a toilet within a specific unit.

The limit of 11 or more units recognises that, in smaller complexes, the size of any common area is also likely to be small and if someone is employed to tend such an area they will only be on-site for a limited time.

For Class 3 building facilities — the patrons' facilities may be grouped together and do not need to be in the building where sleeping accommodation is provided.

Example

An example of grouped facilities could be sanitary facilities located in a freestanding ablution block that services several accommodation units.

The facilities for a Class 3 building contained in **Table F2.1** are those for the residential portion of the building only. Facilities for employees in Class 3 buildings are contained in **Table F2.3**.

For aged care buildings — the facilities contained in **Table F2.1** apply to the residential portion of Class 9c aged care buildings only. Sanitary facilities for employees in aged care buildings are contained in the general part of **Table F2.3**. They can be utilised by the occupants when required.

F2.2 Calculation of number of occupants and fixtures

F2.1

Intent

To provide a method for calculating the number of occupants and fixtures for the purposes of Part F2.

If the number of people who will occupy a building is known, it should be used. However, in the absence of more accurate information, **D1.13** and **Table D1.13** must be used. **D1.13** and **Table D1.13** are used in several Parts of the BCA, such as in calculating minimum exit widths, as well as the number of sanitary and other facilities. **D1.13** and **Table D1.13** do not restrict the number of occupants using a building, or enforce any building use or licensing requirements. Refer also to comments on **D1.13**.

As specified in **D1.13(b)**, if the building is an assembly building or room, its fixed seating provisions give an indication of capacity.

Any other suitable means, as specified in **D1.13(c)**, may include a statement from the building owner as to the number of occupants where there is limited public access.

Example

An alternative means of assessing the number of occupants may be appropriate in the following case.

A specific restaurant may have fixed tables, booths, dining alcoves and architectural features which occupy a significant proportion of the floor space, so the actual number of patrons able to be accommodated may be much less than the number calculated using the one person for every square metre of floor area in **D1.13**.

In such a case, it may be appropriate to count the number of seats available for use by patrons or some other method. However, due allowance would need to be made for the employees, as well as the potential for alternative seating layouts which could then increase the number of people in the restaurant.

For consideration of gender — the number of sanitary facilities should be calculated on the basis that the population of males and females in a building will usually be about equal. Where a building will be occupied predominantly by one sex, the proportion of toilets can be adjusted accordingly.

Examples

It may be appropriate to vary the proportion of female and male toilets in:

- a gymnasium which has appropriate permission to cater for a single sex;
- a single-sex sports facility, such as either an all-male football club or an all-female netball club;
- all-male or all-female prisons; and
- medical or hospital facilities that cater for a specific sex, such as prostate-cancer specialists, gynaecological clinics and maternity hospitals.

For unisex facilities — under **F2.2(c)**, a unisex facility for people with disabilities can be counted as a facility for both a male and a female. **F2.2(d)** defines the meaning of ‘unisex

facility' for the purposes of Part **F2**. These provisions aim to encourage the installation of toilets for people with disabilities.

Examples

If there is a requirement for a toilet block to contain 10 toilets for males and 10 toilets for females (a total of 20 toilets), they may be provided as a total of 19 toilets, ie:

- 9 male;
- 9 female; and
- 1 unisex toilet for people with disabilities.

In another case where there is a requirement for 1 toilet for males and 1 toilet for females, providing a single unisex facility may satisfy this requirement. However, if a urinal is also required it cannot be in the unisex facility.

F2.3 Facilities in Class 3 to 9 buildings**Intent**

To specify the minimum acceptable sanitary, bathing, laundry and cooking facilities required in Class 3 buildings (for employees only) and in Class 5–9 buildings.

F2.3 and **Table F2.3** contain the requirements for the type and number of facilities required. They are based on the preface that a higher ratio of sanitary facilities is required in buildings where occupants spend a long time.

Example

A higher ratio of toilets is required in a Class 7 or Class 8 workplace (where employees could spend all day) than in a Class 6 department store (where customers could be expected to spend less time).

For a department store, the number of facilities for employees is calculated at a different rate to that for customers. For employees it is consistent with other buildings containing employees, while for customers it is considerably less. Therefore, when calculating the number of toilets in a department store, the number required for staff must be added to the number required for customers. The BCA does not require facilities for staff to be in an area separate from customers (except as required by Note 5 at the end of **Table F2.3**), but a separation may be needed under some other regulations, such as workplace or health regulations, so should be checked.

Experience has shown that there can be excessive delays and queueing at female toilets at certain theatres or cinemas. **Table F2.3** therefore requires additional facilities for females in single auditorium theatres and cinemas. For the purposes of **Table F2.3**, a single auditorium theatre or cinema is considered to be one that contains only one auditorium and the performance results in peak use of toilets before a performance and at intermission. When a theatre or cinema contains two or more auditoriums and the start and intermissions are at different times, less delays and queueing occur.

Notes to **Table F2.3** are provided and the Table should be read in conjunction with the notes.

Note 1 — Any reference to employees in **Table F2.3** should be read in the wider context of all who work in the building. This includes those who may not technically be employed, such as owners and, if there is any doubt regarding their status, managers.

Note 2 — If the number of male employees is less than 10, a concession is provided so that a urinal need not be provided.

Note 3 — Establishments employing a total of less than 10 people may have a facility for use by both sexes, rather than a separate facility for each sex.

Note 4 — Where most employees are of one sex, two or less of the other sex can share their toilet facilities, subject to certain conditions. This concession allows one less toilet to be installed.

Note 5 — Except in schools and early-childhood centres, separation of facilities for employees and the public is not required. Separation is required in schools to maintain the teacher/student relationship, while in early-childhood centres it is required because of the:

- provision of junior toilets;
- use of the toilets as training facilities; and
- need to keep the children under observation.

Note 6 — A concession is provided to permit the provision of fewer facilities for the public where the people accommodated are under certain numbers. Facilities must still be provided for employees, and, if necessary, members of the public can share these facilities.

Note 7 — Toilet facilities for females must be provided with a means of disposal of sanitary napkins etc. This might include an incinerator, or a bin and disposal service. This provision also applies to unisex or male/female shared toilets (refer to Notes 3 and 4 of **Table F2.3**).

The BCA currently covers the separation of male and female toilets by way of Notes 3 and 4 to **Table F2.3**, which provide for specific exemptions permitting unisex and combined facilities. These provisions underline the intention that the BCA requires separate facilities under all other circumstances in the buildings covered by **Table F2.3**.

For health-care buildings — in addition to **Table F2.3, F2.3(b)** requires facilities for meals and laundering because the patients live in the building.

F2.3(b)(i) therefore requires:

- a kitchen or other facilities for the preparation and cooking or reheating of food;
- a kitchen sink for the washing of plates, cutlery, cooking utensils, and the like; and
- a washbasin for kitchen staff to wash their hands.

Because of the amount of linen and clothes requiring laundering in these buildings, **F2.3(b)(ii)** requires laundry facilities; or places for the holding and dispatching soiled linen, clothing, and the like; and the receipt and storage of clean linen.

For early childhood centres — **F2.3(c)(i)** requires a kitchen because young children may require food, possibly in the form of special diets. The kitchen must comprise:

- facilities for the preparation and cooking of food for infants;
- a kitchen sink; and
- space for a refrigerator.

If the building accommodates children younger than three-years old, there may also be a need to carry out washing of nappies and other clothing. **F2.3(c)(ii)** therefore requires the installation of laundry facilities (but not drying facilities) in these buildings comprising:

- a washtub; and
- space in the same room for a washing machine.

F2.4 Facilities for people with disabilities

Intent

To specify the minimum acceptable sanitary and bathing facilities required for people with disabilities in Class 3, Class 5–9 and Class 10a buildings.

Section D requires equitable and dignified access to buildings and the services they provide. **Section D** and Part **F2** are also intended to apply inclusively to people with disabilities (see **FP2.1**). Not only must people with disabilities be able to access a building's toilet and bathing facilities, those facilities must be usable by them.

F2.4(a) requires that sanitary facilities be provided in accordance with **Table F2.4**.

F2.4(a)(i) allows the facilities provided for people with disabilities under **Table F2.4** to be counted as part of the number of facilities required by **Table F2.3**. It is therefore intended that people without disabilities may also use facilities designed for people with disabilities.

The provisions in **F2.4(a)(ii)** and **Table F2.4** contain **Deemed-to-Satisfy Provisions** with regard to Class 10a buildings. All other **Deemed-to-Satisfy Provisions** for Class 10a buildings are contained in Volume Two.

The inclusion of Class 10a buildings in **F2.4** is intended to provide coverage in Volume One of facilities in schools, etc and for public toilet facilities provided in a Class 10a building, such as a public facility in a park or at a sports ground.

F2.4(b) requires that facilities be constructed in accordance with **AS 1428.1**. It is important to note that **AS 1428.1** contains provisions for both wheelchair accessible facilities and those for ambulant people with a disability. These provisions include:

- grabrails;
- circulation space;
- access door width and swing;
- height of fixtures;
- lever handles for taps; and
- space under the front of basins.

AS 1428.1 includes some spatial requirements. These are the minimum needed; they should be measured between finished wall surfaces (not, for example, stud to stud); and unless additional space is provided, should not include other facilities for use by people both with and without disabilities, such as showers, baby-changing facilities, disposal bins, and the like.

F2.4(d) requires mirror image (i.e. left and right handed) facilities for people with disabilities, when two or more facilities are required, recognising that people may have a preference or be restricted in use of either right or left hand facilities.

Under **Table F2.4**, where only one wheelchair accessible toilet facility is required, it must be a unisex facility.

Table F2.4 requires a shelf to be provided in most facilities for use by people with disabilities in accordance with **AS 1428.1**.

A toilet within a Class 10a building that is suitable for an ambulant person with a disability is not intended for use by a person using a wheelchair. An accessible path of travel need not be provided to such a toilet.

F2.5 Construction of sanitary compartments

Intent

To specify the construction expected to provide an acceptable level of privacy in toilets while facilitating assistance in an emergency.

Privacy in toilets is considered to be an amenity issue. There is a high level of privacy expected in unisex toilets while there are lower levels expected in early-childhood centres and

facilities used by primary school children. There is also an intermediate level expected between compartments in single-sex toilets.

F2.5 permits early-childhood centres to be constructed without doors and partitions between toilets because it is necessary for staff to keep the children under regular observation. Under **F2.5(a)(ii)**, a concession is also provided on the height of partitions for facilities used by primary school children. These concessions in **F2.5** should not be applied to staff facilities.

F2.5(b) requires means of removing an unconscious occupant from a fully enclosed sanitary compartment. If the enclosure has gaps that are large enough to allow access for a person into the sanitary compartment, the compartment is not intended to be considered enclosed for the purposes of this clause.

F2.6 Interpretation: Urinals and washbasins

Intent

To clarify what is meant by the expressions ‘urinal’ and ‘washbasin’.

Urinals and hand-washing facilities are often not constructed as single units, but as a length of trough. **F2.6(a)** and **(b)** clarify that the words ‘urinal’ and ‘washbasin’ apply to individual facilities, or to a length of trough, in the case of a urinal; and a specific part of a hand-washing trough.

F2.6(a)(iii) allows a closet pan (also called a ‘toilet pan’ or ‘closet fixture’) to be used in place of a urinal. Such a closet pan must be additional to the required number of closet pans, and so must not be counted once as a urinal and once as a pan when calculating the total number of facilities.

F2.7 Microbial (legionella) control

Intent

To make sure that hot water, warm water and cooling water systems in certain facilities minimises the risk of a major disease outbreak.

Legionella and other dangerous bacteria may multiply in hot water, warm water and cooling water systems to numbers that can cause serious outbreaks. [AS/NZS 3666.1](#), referenced by **F2.7**, contains measures for designing, installing and commissioning hot water, warm water and cooling water systems, aimed at minimising the risk of a major disease outbreak.

Legionella and other dangerous bacteria may multiply in hot water, warm water and cooling water systems to numbers that can cause serious outbreaks.

This provision applies to all buildings except systems that only serve a single sole-occupancy unit in Class 2 or 3 building or Class 4 part. This limitation is consistent with the intent of [AS/NZS 3666.1](#) and the limitation of **FP2.6**.

F2.8 Waste management

Intent

To require adequate devices in Class 9a and 9c buildings containing ward areas or bedrooms for the emptying of containers of sewage and dirty water.

Class 9a buildings, such as hospitals and nursing homes, are likely to be occupied by people who can only carry out their toilet and bathing functions in commode chairs or into containers. To minimise disease, **F2.8(a)** requires slop-hoppers. These are special fixtures with a grate, flushing apparatus and tap which are used for emptying bedpans and the like.

Aged care buildings are likely to be occupied by people with similar difficulties to those occupying Class 9a buildings. To minimise disease, **F2.8(b)** requires the installation of slop-hoppers and appliances for disinfecting pans in Class 9c aged care buildings. If one device can undertake all tasks required by **F2.8(b)**, then it may be utilised.

PART F3 ROOM SIZES

Objective**FO3****Basis of Objective**

FO3 is based on the belief that people should not be subject to risk of injury or loss of amenity caused by the inadequate height of a room or space.

Risk of injury

The height of certain rooms and spaces must be controlled to prevent injury to occupants.

Loss of amenity

The height of certain rooms and spaces must be controlled to prevent a loss of amenity to occupants.

Functional Statement**FF3.1****Height suitable for use of a room or space**

Buildings must provide a height suitable for the intended use of rooms and spaces. 'Intended use' recognises that the height required in rooms and spaces is directly related to the room's function.

Performance Requirement**FP3.1****Sufficient height**

FP3.1 adds the term 'sufficient' when describing the required level of performance. The required height must be considered in light of intended function.

The Deemed-to-Satisfy Provisions specify different heights for different room or building types.

Measurement of height

To achieve the requisite level of performance, it is necessary, when measuring the height of a ceiling, to make the measurement:

- from the floor to the underside of the ceiling lining; or
- if there is no ceiling lining, to the underside of the floor or roof above.

Exposed beams are permitted to encroach below the minimum ceiling height, but care should be taken to make sure that adequate height is still available.

PART **F3** ROOM SIZES

Deemed-to-Satisfy Provisions

F3.0 Deemed-to-Satisfy Provisions

Intent

To clarify that **FP3.1** will be achieved by compliance with **F3.1**.

F3.1 Height of rooms and other spaces

Intent

To establish a range of reasonable ceiling heights suitable for particular rooms and spaces.

2.4 metres

Generally, the minimum ceiling height has been set at 2.4 metres:

- **F3.1(a)(iii)** deals with habitable rooms (apart from kitchens) in Class 2 and Class 3 buildings and Class 4 parts;
- **F3.1(b)(i)** apart from some specified exceptions, in Class 5-8 buildings;
- **F3.1(c)(i)** and **(iii)** deals with Class 9a patient-care areas, treatment rooms, clinics, waiting rooms, passageways and corridors;
- **F3.1(d)(i)** is for school classrooms and smaller assembly buildings; and
- **F3.1(e)(ii)** and **(iii)** deal with corridors, etc and habitable rooms (apart from kitchens) in Class 9c aged care buildings.
- **F3.1(f)(ii)** deals with commercial kitchens.

2.1 metres

A reduced height of 2.1 metres is permitted in areas unlikely to be occupied for long periods, where the reduction from 2.4 metres will not adversely affect occupant safety, health or amenity. Such areas include:

- kitchens or laundries or the like in Class 2 and Class 3 buildings and Class 4 parts;
- corridors and passageways or the like in Class 2 and Class 3 buildings and Class 4 parts;
- corridors and passageways or the like in Class 5-8 buildings; and
- various bathing facilities, small storage areas, airlocks, garages, carparking facilities, tearooms and the like, which are located in any building.

Ceiling heights above 2.4 metres

Some specific use areas require a ceiling height greater than 2.4 metres in recognition of the activities or equipment likely to be used in those areas, such as:

- operating theatres or delivery rooms which require a ceiling height of three metres to accommodate special lighting fixtures, air monitoring equipment, and medical apparatus; and
- larger assembly buildings.

PART F4 LIGHT AND VENTILATION

Objective**FO4**

FO4(a) aims to minimise the risk of injury, illness or loss of amenity to occupants from shortages of natural or artificial light.

FO4(b) aims to minimise the same as above, from a shortage of fresh air.

Functional Statements**FF4.1**

FF4.1 requires that a building space must have openings providing enough natural light for a room to fulfil its purpose.

FF4.2

FF4.2 requires that a building space used by occupants must have artificial light, which will, when there is insufficient natural light, provide enough light to allow safe movement and use of the room.

FF4.3

FF4.3 requires that a building space used by occupants must have ventilation that provides adequate air, so the room can fulfil its purpose. 'Adequate air' includes both quantity and quality.

The building and its location may impose constraints on the quality of the ventilation air.

Example

A building's location may impose constraints on the quality of the ventilation air such as when the building is in a central business district. Here, even locating intakes at the highest point on the building could still draw in significant quantities of vehicle exhaust fumes. The air may not be totally 'fresh'. Nonetheless, efforts must be made to make sure the air is of adequate quality.

Ventilation standards are influenced by many factors, including:

- the number of people being provided with air;
- activities in the building which might lead to a build-up of toxic gases;
- climatic conditions; and
- the distribution of ventilation openings.

Some of the primary problems, which a ventilation system must attempt to overcome, include:

- excessive heat;
- excessive humidity; and
- offensive odours.

Performance Requirements

FP4.1

FP4.1 includes the concept of even distribution, and relates required lighting levels to the function of the building.

The level of natural light must be appropriate to the function of each part of the building (this differs from the **FP4.2** requirement for artificial light).

FP4.2

FP4.2 relates required lighting levels to the use of each part of the building. Unlike **FP4.1** with regard to natural light, **FP4.2** does not include the concept of even distribution.

The level of artificial light must be appropriate to the use of the building to enable safe use and movement by occupants (this differs from the **FP4.1** requirement for natural light).

FP4.3

FP4.3 requires a building's ventilation system to include for the supply of outdoor air.

FP4.4

Where a mechanical air-handling system is installed, **FP4.4** requires it to achieve control with regard to the following:

- smells considered objectionable (including food, cooking and toilet odours); and
- the accumulation of germs, harmful microbes, other disease-causing agents, and poisons.

FP4.5

FP4.5 requires that any contaminated air be disposed of so that it does not cause any nuisance or hazard to:

- occupants (of either the subject building, or any other building);
- people on neighbouring allotments; or
- people on a road.

PART **F4** LIGHT AND VENTILATION

Deemed-to-Satisfy Provisions

F4.0 Deemed-to-Satisfy Provisions

F4.0 clarifies that compliance with **F4.1–F4.12** will achieve compliance with **FP4.1–FP4.5**.

F4.1 Provision of natural light

Intent

To specify the rooms in Classes of buildings where natural light is required.

See **FF4.1** and **FP4.1** for information on the reasons for the BCA natural light provisions.

The provision of natural light is substantially a health and amenity issue. It is considered of particular importance in all ‘living’ and ‘sleeping’ areas in residential buildings occupied by people for an extended period of time. The BCA consistently assumes that this is the case with Class 2 buildings and Class 4 parts, but not with Class 3 buildings.

Occupants of Class 3 and Class 9a buildings do not reside in the same building for an extended period of time. **F4.1** extends this assumption to the ‘living’ areas (shared and unshared) of such buildings. For this reason, the BCA only requires the provision of natural light to sleeping areas in Class 3 and Class 9a buildings.

F4.1(b) assumes that in Class 3 buildings the occupants spend more time in their ‘sleeping’ accommodation than they do in ‘living’ areas. This is usually the case in Class 2 buildings and Class 4 parts.

F4.1(c), with regard to Class 9a and 9c buildings, takes account of the fact that occupants will generally be in their beds throughout the day and natural light will be important to them.

It is considered desirable that school and pre-school children are able to view the outside environment, and work or play using natural light. Accordingly, buildings such as kindergartens and schools must provide natural light to playrooms and classrooms.

F4.2 Methods and extent of natural lighting

Intent

To specify the requirements for the size and location of windows to provide required natural lighting.

A window includes rooflights, glassed louvres and glazed doors (see definition in **A1.1**).

F4.2(a) sets the requirement that natural light must be provided by windows; and the size and location of such windows.

All windows, both required and non-required, must comply with the various requirements of the BCA's fire-safety provisions, such as **C3.2** for openings in external walls, and **Clause 3.6** of **Specification C1.1** for rooflights.

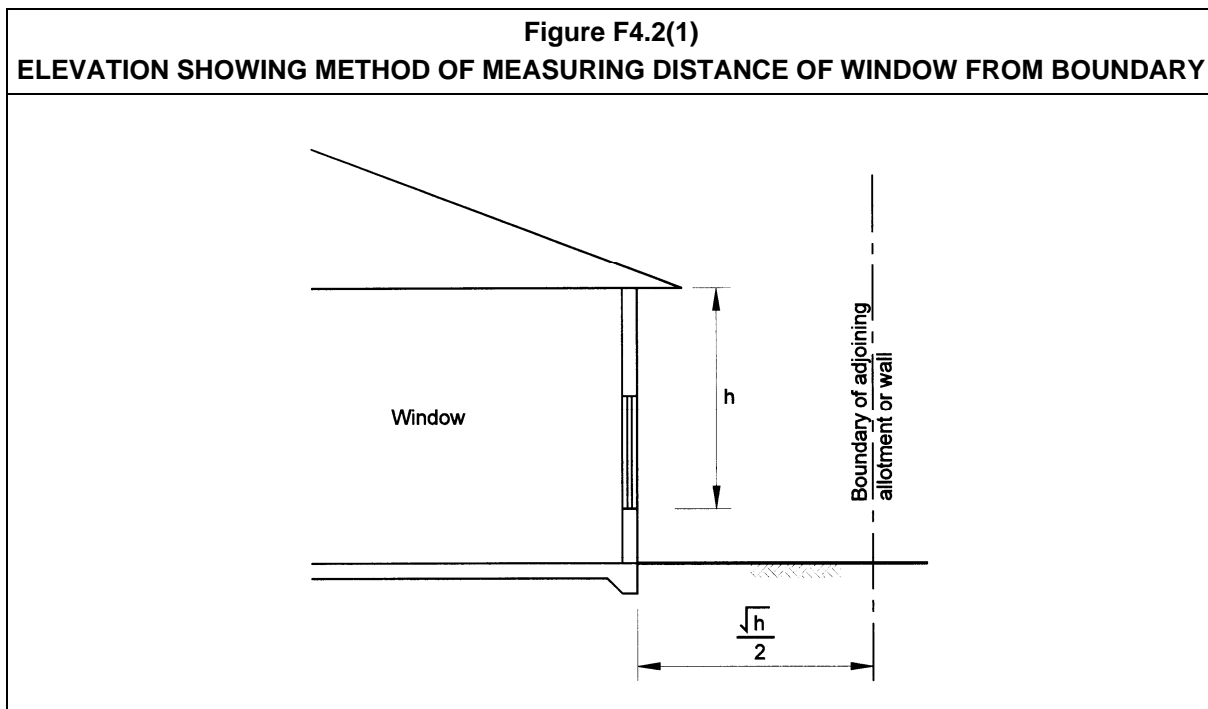

F4.2(b) does not prohibit windows closer to the boundary than one metre (or three metres in the case of a patient-care area in a Class 9a building). However, if a window is located within these distances, **F4.2(b)** does not allow it to be considered as providing required natural light to the subject room.

It should be noted that **F4.2(b)** does not apply to Class 9c buildings. **F4.2(c)** contains specific provisions for these buildings.

Figure F4.2 illustrates the method of measuring the distance of the window from:

- an adjoining allotment boundary;

- a wall of the same building; and
- a wall of another building on the same allotment.

F4.2(c) contains requirements for Class 9c aged care buildings. The requirement for the window sill to be not more than 1 m above floor level and at least 3 m from an adjoining allotment, another building or wall is to maintain amenity for residents who spend a significant amount of time sitting on chairs or lying in bed. **Figure F4.2(2)** illustrates the method of measuring these distances.

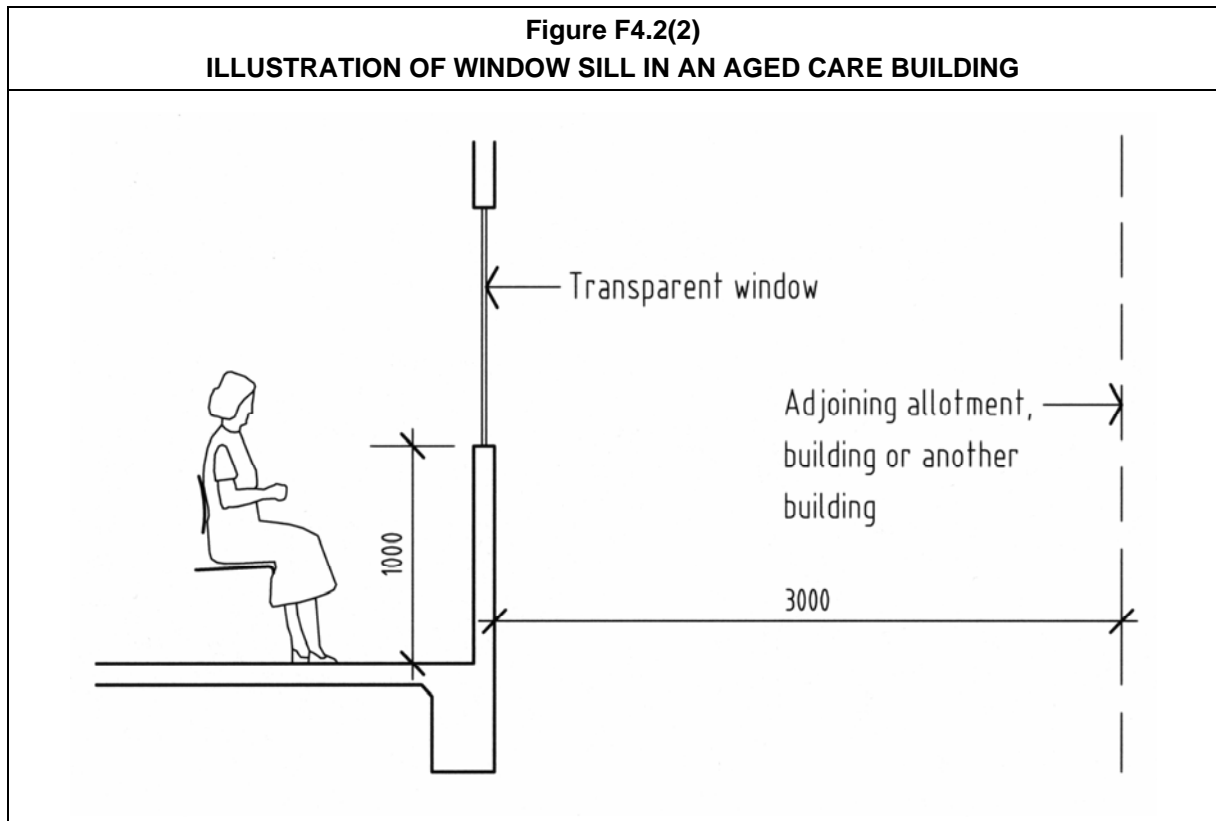

F4.3 Natural light borrowed from adjoining room

Intent

To allow natural light to be 'borrowed' from an adjoining room.

F4.3 applies only to a room in:

- a Class 2 building;
- a Class 4 part; or
- a sole-occupancy unit in a Class 3 building.

For these Classes, it is sometimes acceptable for a room's required natural light to be 'borrowed' from an adjoining room (ie an adjoining room's light can be used to help make up the total amount of natural light required in the subject room).

The use of borrowed light is acceptable if the provisions of **F4.3** are applied to the subject room and to the total area of each relevant room.

Any borrowed natural light must be from an adjoining room over which occupants of the subject room have some control. **F4.3(a)** therefore requires that the adjoining room be within the same sole-occupancy unit or be an enclosed verandah on common property. As a consequence, the required natural light cannot be from another sole-occupancy unit.

To borrow natural light from another room, **F4.3(b)** allows light to pass through a glass panel or opening from an adjoining room which, under **F4.3(c)**, must have windows of a minimum size in proportion to the combined floor areas of both rooms. The minimum size of the glass panel or opening, and the minimum size of the window to the adjoining room, are illustrated in **Figure F4.3**.

The area of openings needed to transmit natural light from an adjoining room may be reduced proportionally to the size of any openings in the subject room which transmit natural light directly from the outside.

<p>Figure F4.3 METHOD FOR DETERMINING AREAS OF OPENINGS FOR BORROWED LIGHT</p>
--

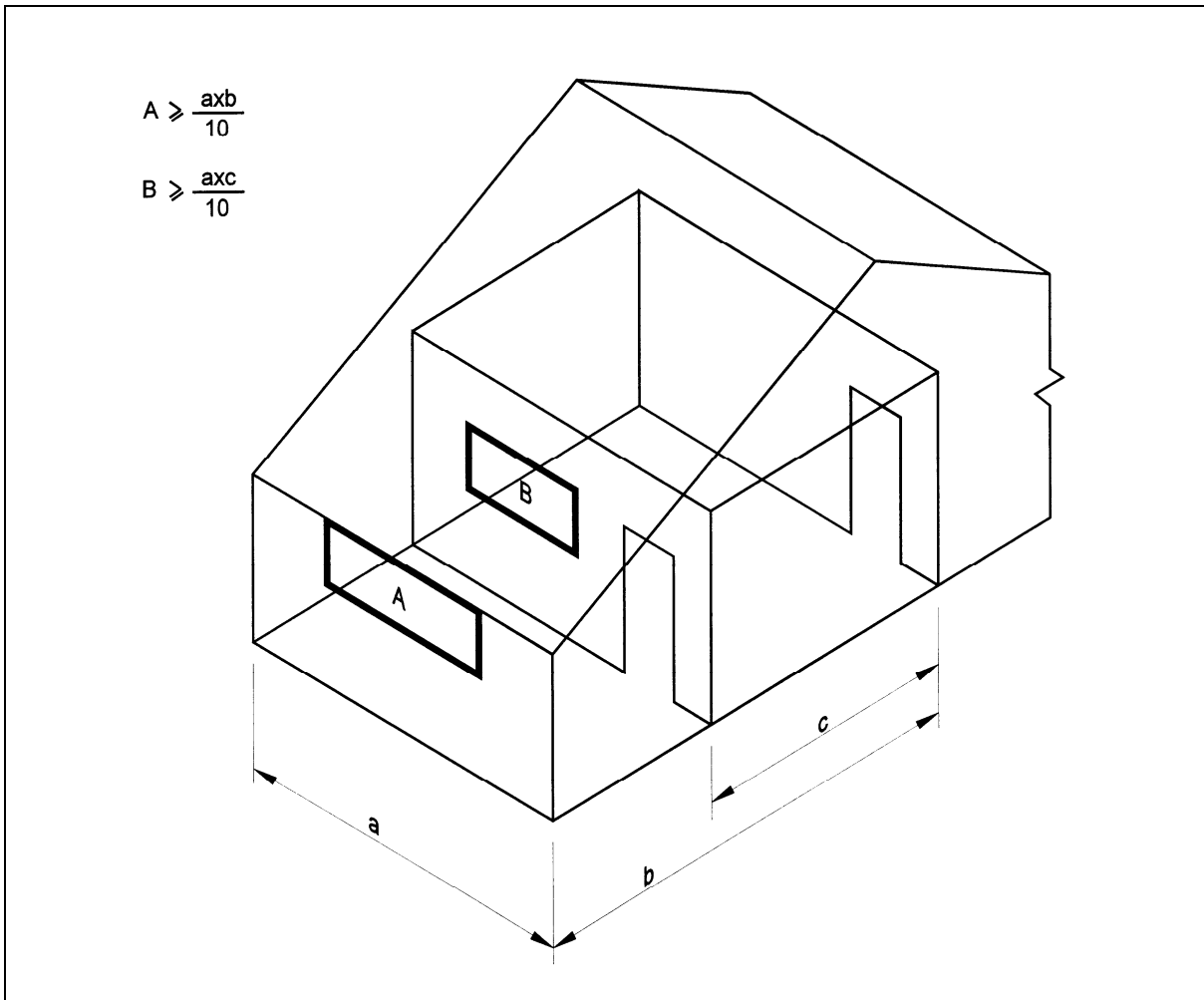

F4.4 Artificial lighting

Intent

To specify the location and other requirements for required artificial lighting.

Artificial lighting is required where it is necessary to minimise any hazard to occupants during an emergency evacuation.

F4.4(a)(i) sets out those places where artificial lighting is always required.

F4.4(a)(ii) sets out those places where artificial lighting is required if an **F4.2** required standard of natural lighting required by **F4.2** is unavailable, and the periods of occupation of the areas, or the use of the space, will create an undue hazard during an evacuation.

Determination of whether or not the periods of occupation of the specified areas will create an undue hazard during an evacuation is a judgement, which requires a ‘performance-type’ assessment.

Class 4 parts of buildings are subject to **F4.4(a)(ii)** only with regard to wet areas and airlocks. (Any required stairways and the like in the rest of the building, which contains the Class 4 part, are required to be artificially lit under **F4.4(a)(i)**).

Class 2 buildings are subject to **F4.4(a)(ii)** with regard to wet areas, airlocks and any common areas such as stairways, etc used in common by occupants.

Class 3 and Class 5–9 buildings are subject to **F4.4(a)(ii)** with regard to all rooms frequently occupied, and all corridors, stairways and similar circulation routes and paths of egress. Unless they are ‘frequently occupied’, wet areas (including those in Class 3 buildings) are not subject to **F4.4(a)(ii)**.

Apart from the ‘performance-type’ judgement regarding the location of artificial lighting in those areas specified in **F4.4(a)(ii)**, the remainder of the requirements are contained in the [AS/NZS 1680.0](#) specified in **F4.4(c)**.

F4.4(b) gives a concession for compliance with **F4.4(a)** in specific buildings which have lower levels of lighting as part of their normal operation. For example, the lighting levels specified in [AS/NZS 1680.0](#) would be inappropriate during the screening of a movie in a cinema or may lead to damage of artworks in a gallery.

F4.5 Ventilation of rooms

Intent

To state the natural and mechanical ventilation requirements for rooms and buildings.

The specified rooms and buildings, and any other room occupied by a person for any purpose, must be provided with either:

- natural ventilation complying with **F4.6**; or
- mechanical ventilation or an air-conditioning system that complies with both of the Standards referenced in **F4.5(b)**.

F4.6 Natural ventilation

Intent

To specify the requirements for the size and location of windows providing required natural ventilation.

F4.6 requires that permanent openings, windows, doors or other openable means provide natural ventilation. It also deals with the size of such openings, and the locations to which such openings must open.

F4.6(b)(i) requires a judgement regarding what is ‘suitably sized’; and **F4.6(b)(ii)** requires a judgement regarding what is ‘open’.

F4.6 does not require any of the required natural ventilation to be ‘fixed ventilation’ or ‘permanent openings’ as against ‘devices which can be opened’. The building proponent can make the decision.

If the natural ventilation openings are used only for ventilation purposes, roller shutters and doors can cover the openings if they achieve the performance standard in **F4.6(a)** and **(b)**. However, if the openings are also used for egress purposes, they must comply with the requirements of provisions such as **D2.19** and **D2.21**.

F4.7 Ventilation borrowed from adjoining room

Intent

To allow natural ventilation to be ‘borrowed’ from adjoining rooms.

F4.7(a) applies only to:

- Class 2 buildings;
- Class 4 parts; and
- sole-occupancy units in Class 3 buildings.

F4.7(b) applies only to Class 5–9 buildings.

It is sometimes acceptable for a room’s required natural ventilation to be ‘borrowed’ from an adjoining room (ie an adjoining room’s ventilation can be used to help make up the total amount of ventilation required).

The use of borrowed ventilation is acceptable if the provisions of **F4.7** are applied to the subject room and to the total area of each relevant room.

Any borrowed natural ventilation to a room must be from a room over which the occupants have some control. **F4.7(a)** therefore requires that the adjoining room be:

- within the same sole-occupancy unit; or
- an enclosed verandah on common property.

In a Class 2 or Class 3 building or Class 4 part, this requirement means that the natural ventilation cannot be from another sole-occupancy unit.

F4.7(a) and **(b)** allows a window, an opening, a ventilating door, or the like, to be used to ‘borrow’ ventilation air from an adjoining room. The minimum area required for ventilation in residential buildings is illustrated in **Figure F4.7**.

In Class 5–9 buildings, the area of ventilation opening required under **F4.7(b)** is similar to that required for residential buildings, except that:

- the area of ventilation opening must be increased from 5% to 10%; and
- any part of the ventilation opening between the rooms more than 3.6 metres above the floor must not be included as part of the required ventilation area.

Under **F4.7(c)**, the area of openings needed to transfer natural ventilation borrowed from an adjoining room may be reduced proportionally to the size of any window or other opening in the room which receives natural ventilation directly from the outside.

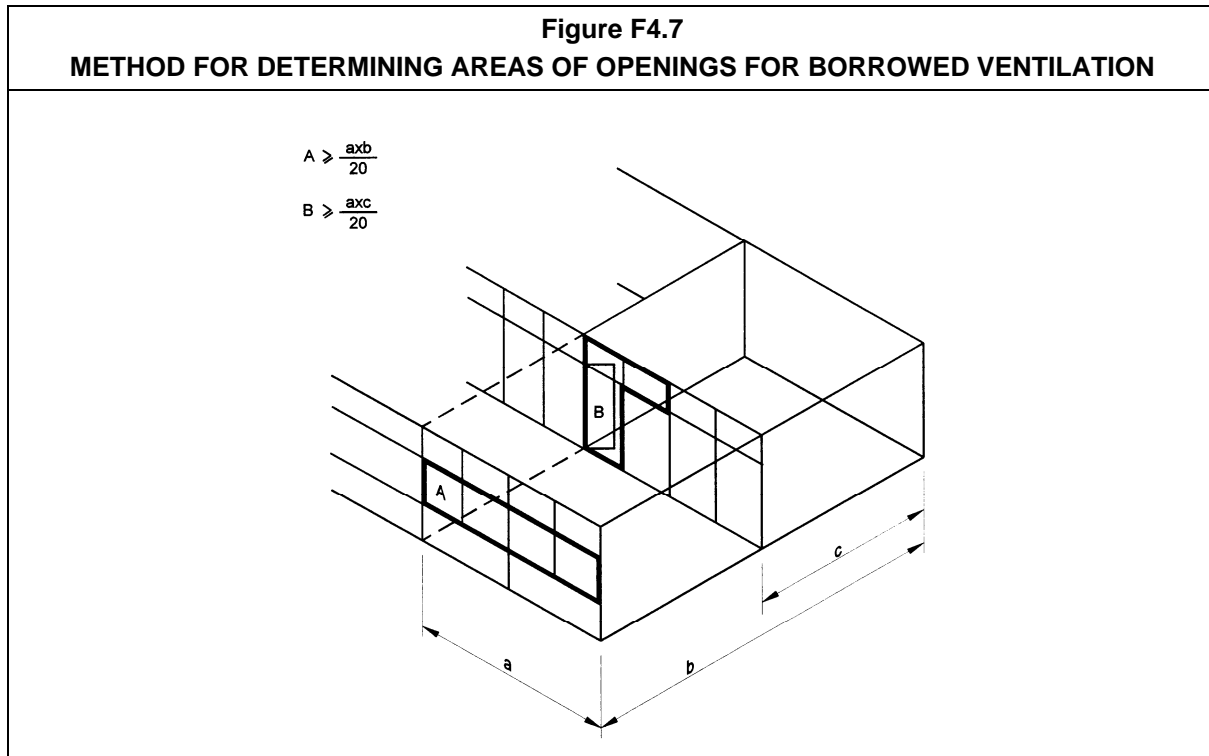

F4.8 Restriction on position of water closets and urinals

Intent

To minimise the impact of unpleasant smells.

While **F4.8** prohibits toilets opening directly into specified areas, **F4.9** sets out how toilets can serve those areas by using:

- airlocks or airlock equivalents; or
- mechanical exhaust ventilation and, in some cases, screening.

The odours from toilets can be unpleasant and so it is desirable to minimise their impact on adjacent areas such as:

- a kitchen or pantry;
- public-eating areas, but not domestic-eating areas (other than kitchens);
- Class 3 building dormitories (but no other sleeping areas);

- some assembly buildings (but not kindergartens, primary schools or open spectator stands); and
- most workplaces.

The exclusions include sleeping areas other than Class 3 dormitories. In houses, flats, motels and hotels the odours are usually generated by the resident/s, whereas, in a dormitory there is a high likelihood that:

- the odours are generated by unrelated people;
- the toilet-use ratio is higher; and
- there could also be a privacy issue.

Some other exclusions are kindergartens excluded because staff need to keep children under continuous observation and open spectator stands because these are generally open to the air and therefore inherently well ventilated.

F4.9 Airlocks

Intent

To specify requirements for airlocks or mechanical ventilation where toilets open directly into other rooms.

While **F4.8** prohibits toilets opening directly into specified areas, **F4.9** sets out how toilets can serve those areas by using:

- airlocks or airlock equivalents; or
- mechanical exhaust ventilation and, in some cases, screening.

It is desirable to minimise toilet odours in particular areas. See **F4.8** and **F4.9** for airlock and mechanical exhaust ventilation where a builder wishes to locate a toilet close to, or open directly into, the areas specified in **F4.8**.

F4.10 * * * * *

The content of **F4.10**, which existed in BCA 1990, has been relocated to **F1.12**. The Clause number **F4.10** has been retained without text so as not to change the numbering of BCA96 from that of BCA 1990.

F4.11 Carparks

Intent

To specify ventilation requirements for carparks, to ensure car fumes are adequately removed.

F4.11 does not apply to an open-deck carpark because such carparks are provided with adequate, permanent, natural ventilation.

[AS 1668.2](#) contains mechanical ventilation requirements for the **Deemed-to-Satisfy Provisions**.

F4.11(b) contains a ‘performance-type’ requirement for natural ventilation of carparks. Any proposal for such a ventilation system would need to satisfy the appropriate authority that it will be:

- ‘adequate’ for the purpose intended; and
- ‘permanent’, meaning that consideration should be given to the possibility of openings being blocked or obstructed over time.

[AS 1668.2](#) permits the mechanical ventilation system to be omitted under specified conditions if the building is naturally ventilated.

F4.12 Kitchen local exhaust ventilation

Intent

To minimise the spread of cooking odours and fire from commercial kitchens.

The aim of **F4.12** is to:

- reduce the prevalence of airborne fats, etc building up, and causing health and fire problems;
- reduce steam and smoke from cooking processes; and
- maintain the flow of air to reduce potentially obnoxious odours.

The figures in **F4.12(a)** relate to the size of any electrical or gas cooking apparatus, which may cause these problems.

The figures in **F4.12(b)** relate to the ratio of electrical or gas cooking apparatuses to room size, which may cause these problems.

The **Deemed-to-Satisfy Provisions** require exhaust hoods to comply with both [AS/NZS 1668.1](#) and [AS 1668.2](#).

PART F5 SOUND TRANSMISSION AND INSULATION**Objective****FO5**

Part **F5** addresses sound and its impact on health and amenity, but only within a Class 2, Class 3 and Class 9c building. Reasons why it does not cover sound emanating from outside the building include:

- builders, etc have little control over external sound, which are usually intermittent during daylight hours when the background ambience sound within the building are greater; and
- sound generated within a building is more likely to pass through walls and fittings, and cannot be controlled by simply closing a window. Such sounds can be more intrusive and disruptive to occupants.

Functional Statement**FF5.1**

To achieve **FO5** in a Class 2, Class 3 and Class 9c building, sound transmission must be minimised through a building element that either separates:

- sole-occupancy units; or
- a sole-occupancy unit and a common space.

Because of its emphasis on building elements which separate sole-occupancy units and/or common spaces, **FF5.1** does not cover building elements which separate sole-occupancy units from the outside of a building, and therefore does not cover:

- sound generated outside a building; or
- sound escaping from a building and re-entering via an external element.

Performance Requirements**FP5.1**

FP5.1 relates to the floor between sole-occupancy units in Class 2, Class 3 and Class 9c buildings. It covers airborne and impact-generated sounds between units located above one another. It does not cover transmission through floors from common spaces, such as a common corridor, laundry or entertainment area.

FP5.2

FP5.2 relates to the walls between sole-occupancy units, and between a sole-occupancy unit and specified spaces, in a Class 2 and Class 3 building. It covers both airborne and impact-generated sound travelling to an adjoining unit.

Unlike **FP5.1**, **FP5.2(b)** covers sound transmission through walls from a number of specified spaces. A list is included with the additional words ‘or the like’.

The list does not include common areas such as for eating, cooking, bathing and toiletry (in Class 3 buildings), or common areas such as laundries, recreation facilities, swimming pools, spas and the like (both Class 2 and Class 3 buildings). These are not considered ‘like’ the spaces listed in **FP5.2**.

FP5.3

FP5.3 supports the requirements of **FP5.1** and **FP5.2** in that the performance of building elements in Class 2, Class 3 and Class 9c buildings are not to be compromised because of services that penetrate the elements.

Examples

Sounds prohibited under **FP5.3** include those from a service pipe in the form of:

- pump vibration;
- water hammer; or
- sewage waste flowing down the pipe.

FP5.4

FP5.4 only applies to Class 9c aged care buildings.

For airborne sound, **FP5.4** relates to the insulation of walls:

- between sole-occupancy units; and
- between sole-occupancy units and a kitchen, bathroom, sanitary compartment (not being an ensuite), laundry, plant room or utility room.

For impact generated sound, **FP5.4** relates to the insulation of walls between sole-occupancy units and a kitchen or laundry.

FP5.4 does not include any requirement for sound insulation of floors in aged care buildings. This matter is included in **FP5.1**.

PART **F5** SOUND TRANSMISSION AND INSULATION

Deemed-to-Satisfy Provisions

F5.0 Deemed-to-Satisfy Provisions

Intent

To clarify that the requirements of **FP5.1–FP5.4** will be satisfied if compliance is achieved with **F5.1–F5.8**.

F5.1 Application of Part

Intent

To clarify that Part **F5** only applies to Class 2, Class 3 and Class 9c buildings.

F5.2 Weighted sound reduction index: Interpretation

Intent

To clarify the means of determining the weighted sound reduction index (R_w).

Throughout the Part **F5 Deemed-to-Satisfy Provisions**, some forms of construction are required to have an R_w . This R_w must be:

- determined under [AS/NZS 1276.1](#); or
- determined under ISO 701.1; or
- in compliance with **Specification F5.2**.

This Part previously referenced Sound Transmission Class (STC) ratings as a measure of sound insulation. The STC rating has been replaced by the weighted sound reduction index (R_w). A note contained in **Specification A1.3** under [AS/NZS 1276.1](#) states that materials tested in accordance with the previous Australian Standard AS 1276 - 1979 for STC ratings remain still valid. The STC values in these tests carried out under AS 1276 - 1979 shall be considered to be equivalent to R_w values. These tests are only valid if they were issued prior to [AS/NZS 1276.1 - 1999](#) being referenced in the BCA.

F5.3 Sound insulation of floors between units

Intent

To minimise the transmission of sound through floors separating sole-occupancy units.

F5.3 applies only to floors separating sole-occupancy units. It does not apply to floors between sole-occupancy units and common spaces, such as a common corridor, laundry or entertainment area.

F5.4 Sound insulation of walls between units

Intent

To minimise the transmission of sound through walls separating sole-occupancy units, and walls separating sole-occupancy units and certain types of common space.

F5.4 and **F5.5** both apply to walls between sole-occupancy units with **F5.5** having higher requirements for some walls. In addition, **F5.4** also applies to walls between sole-occupancy units and specified spaces.

Unlike **F5.3**, **F5.4(b)** covers sound transmission through walls from specified spaces. A list is included with the additional words ‘or the like’.

The list does not include common areas such as for eating, cooking, bathing and toiletry (in Class 3 buildings), or common areas such as laundries, recreation facilities, swimming pools, spas and the like (both Class 2 and Class 3 buildings). These are not considered ‘like’ the spaces listed in **F5.4**.

F5.4(b) does not apply to Class 9c aged care buildings. Aged care buildings must comply with **F5.4(c)**. **F5.4(c)** covers sound transmission through walls of sole-occupancy units from certain adjoining rooms and spaces. The list of adjoining rooms and spaces does not include the words ‘or the like’ because it is intended to be specific to only those areas.

The list of other spaces in **F5.4(c)** does not include stairways, public corridors, hallways, etc. The reason is that aged care buildings are to be provided with a level of sound insulation around the resident bedrooms/sleeping areas to ensure a level of privacy, but still allow the residents to be reassured they are not alone. If the R_w of a wall is too high it may create a feeling of isolation for the residents and this can be detrimental to their well being. Being able to hear sounds that are outside their bedroom provides reassurance that assistance is available. The walls of sole-occupancy units prescribed in **F5.4(c)** must be at least 45 R_w . Additional requirements are prescribed in **F5.8** where a bedroom is located next to a kitchen or laundry.

F5.5 Walls between a bathroom, sanitary compartment, laundry or kitchen and a habitable room in adjoining unit

Intent

To minimise sound through walls separating specific rooms — likely to generate extensive noise — and habitable rooms (other than kitchens) in an adjoining sole-occupancy unit.

F5.5 does not apply to Class 9c aged care buildings. Similar provisions are contained in **F5.8**. **F5.5** sets out insulation needed to protect against airborne sound through walls of rooms which may generate extensive noise and habitable rooms (other than kitchens) in an adjoining sole-occupancy unit (**F5.5(b)** and **Table F5.5** contain some solutions to this provision).

F5.5(a)(iii) deals with sound transmitted by way of a duct in such a wall (the **Deemed-to-Satisfy Provisions** do not include a solution to **F5.5(a)(iii)**).

F5.5(b), in conjunction with **Table F5.5**, provides three solutions to **F5.5(a)(i)**, but they may not be the only solutions. An alternative approach may be taken as part of a solution to **F5.5(a)(i)**.

F5.5(a)(ii) takes the form of a performance criterion, in that the level of insulation against impact sound must be ‘satisfactory’. This is one of several where performance criterion occurs in the **Deemed-to-Satisfy Provisions**.

F5.5(b), in conjunction with **Table F5.5**, provides three solutions to **F5.5(a)(ii)**. They are not the only solutions. An alternative approach may be taken as part of a solution to **F5.5(a)(ii)**.

F5.6 Soil and waste pipes to be separated

Intent

To minimise the transmission of sound that may arise from soil and waste pipes imbedded in, or passing through, a floor.

F5.6 details the various requirements, including R_w values, for the sound separation of soil or waste pipes from sole-occupancy units.

F5.6 applies only to those soil and waste pipes which pass through a floor required to have sound insulation, and those that pass through more than one sole-occupancy unit.

F5.6 does not apply if the pipes serve only a single unit; or any part of a Class 2, Class 3 or Class 9c building which is not part of a sole-occupancy unit.

The R_w values do not take account of the inherent acoustic properties of the pipe material.

F5.7 Isolation of pumps**Intent**

To minimise sound transmission from a pump

F5.7 requires flexible couplings at connection points to or from a pump to minimise vibration and any consequent sound transmission along the piping.

F5.8 Walls between a bedroom and kitchen or laundry in a Class 9c building**Intent**

To minimise sound transmission in aged care buildings between sleeping areas kitchen and laundries.

Class 9c aged care buildings must comply with **F5.4** and **F5.8**.

F5.8 deals with reducing the level of impact sound through the walls of sole-occupancy units from adjoining kitchens or laundries. To comply with **F5.8**, it is necessary for the wall to have an R_w of at least 45 (as required by **F5.4**) and:

- for other than masonry, consist of at least two separate leaves that do not have any rigid mechanical connection except at their periphery. (The reason for not allowing rigid connection is to reduce the transmission of impact sound to the sleeping area); or
- be identical with a prototype having at least the same resistance to impact sound as a wall complying with Table 2 of **Specification F5.2**

SPECIFICATION F5.2**SOUND INSULATION FOR
BUILDING ELEMENTS****Deemed-to-Satisfy Provisions****Specification F5.2**

Specification F5.2 (in conjunction with **Table 2** of **Specification F5.2**) gives information on the weighted sound reduction index (R_w) for building construction methods. Further information can be obtained through literature produced by building product manufacturers.

SPECIFICATION **F5.5****IMPACT SOUND - TEST OF
EQUIVALENCE****Deemed-to-Satisfy Provisions****Specification F5.5**

Specification F5.5 contains details of the test procedure to determine how a proposed wall system resists the transmission of impact sound, in comparison to a system in **Table F5.5**.

Clause 2 outlines the construction to be tested, and only requires that the **Table F5.5** system being used as a test comparison is tested once, so long as certain specified conditions are followed.

Clause 3 outlines the precise method to determine how a proposed wall system resists the transmission of impact sound, in comparison to a system included in **Table F5.5**. Several referenced documents are used as the basis of the testing procedure.

SECTION **G**

ANCILLARY PROVISIONS

- G1** **Minor Structures and Components**
- G2** **Heating Appliances, Fireplaces, Chimneys
and Flues**
- G3** **Atrium Construction**
- G4** **Construction in Alpine Areas**
- G5** **Construction in Bushfire Prone Areas**

SECTION G CONTENTS

	Page
Part G1	
Minor Structures and Components	19,021
Objective GO1	
Functional Statements GF1.1 — GF1.3	
Performance Requirements GP1.1 — GP1.4	
G1.0 Deemed-to-Satisfy Provisions	
G1.1 Swimming pools	
G1.2 Refrigerated chambers, strong-rooms and vaults	
Part G2	
Heating Appliances, Fireplaces, Chimneys and Flues	19,101
Objective GO2	
Functional Statements GF2.1 — GF2.2	
Performance Requirements GP2.1 — GP2.2	
G2.0 Deemed-to-Satisfy Provisions	
G2.1 * * * * *	
G2.2 Installation of appliances	
G2.3 Open fireplaces	
G2.4 Incinerator rooms	
Part G3	
Atrium Construction	19,201
G3.1 Atriums affected by this Part	
G3.2 Dimensions of atrium well	
G3.3 Separation of atrium by bounding walls	
G3.4 Construction of bounding walls	
G3.5 Construction at balconies	
G3.6 Separation at roof	
G3.7 Means of egress	
G3.8 Fire and smoke control systems	
Specification G3.8 Fire and Smoke Control Systems in Buildings Containing Atriums	

	Page
Part G4 Construction in Alpine Areas	19,501
Objective GO4	
Functional Statement GF4.1	
Performance Requirements GP4.1 — GP4.4	
G4.0 Deemed-to-Satisfy Provisions	
G4.1 Application of Part	
G4.2 * * * * *	
G4.3 External doorways	
G4.4 Emergency lighting	
G4.5 External ramps	
G4.6 Discharge of exits	
G4.7 External trafficable structures	
G4.8 Fire-fighting services and equipment	
G4.9 Fire orders	
Part G5 Construction in Bushfire Prone Areas	19,701
Objective GO5	
Functional Statement GF5.1	
Performance Requirement GP5.1	
G5.0 Deemed-to-Satisfy Provisions	
G5.1 Application of Part	
G5.2 Protection	

PART **G1** MINOR STRUCTURES AND COMPONENTS

Objective

GO1

Coverage

GO1 relates to two distinct matters:

- **GO1(a)–(c)** — swimming pools; and
- **GO1(d)** — the risk of people being locked in confined spaces.

Swimming pools — **GO1(a)-(c)**

GO1(a) aims to minimise health risks to people from discharged waste water from a swimming pool. Such waste can spread disease.

GO1(b) relates to drainage from a swimming pool to protect other property from damage.

GO1(c) relates to preventing access of young children to swimming pools.

GO1 is limited in its application around Australia as a number of States and Territories have separate legislation controlling swimming pools and swimming pool fencing.

Accidental locking in small spaces — **GO1(d)**

GO1(d) aims to prevent illness or injury to people from being locked in small spaces which are only intended to be entered for short periods (eg coolrooms).

Functional Statements

GF1.1

Swimming pool drainage

GF1.1 controls the drainage and disposal of water from swimming. **GF1.1** does not apply in the Northern Territory.

GF1.2

Swimming pools — access for young children

GF1.2 controls access by young children to swimming pools. This is to provide protection

from illness, injury and death resulting from unsupervised access to swimming pools. Accordingly, systems designed as alternatives to the **Deemed-to-Satisfy Provisions** must be designed, approved and installed to provide equivalent restrictions to a young child.

Application

GF1.2 is limited in its application around Australia.

GF1.3

Accidental locking in small spaces

GF1.3 aims to make sure that people in confined spaces, such as cooling chambers, strong-rooms and vaults, are able to:

- leave the space if the door accidentally closes; and
- alert people outside the confined space if there is an emergency.

Performance Requirements

GP1.1

Swimming pool drainage

GP1.1 relates to swimming pool drainage in two basic ways:

Prevention of illness — **GP1.1(a)**

To comply with **GP1.1(a)**, it will generally be necessary that water must drain away from the pool surrounds and not flow on to the same or adjoining property. Such pooling could cause illness through:

- excessive moisture conditions degrading any building; and
- the creation of disease breeding grounds.

GP1.1(a) also aims to ensure that water is not left in puddles where people could slip. Water should not be left under decking, creating conditions for mosquito breeding and unhealthy pools of stagnant water.

Protection of other property from damage — **GP1.1(b)**

GP1.1(b) requires that pool water not affect other property. Measures must be taken to ensure that water drained from a pool does not affect other buildings.

No Deemed-to-Satisfy Provisions for GP1.1

There are no **Deemed-to-Satisfy Provisions** for **GP1.1**. This is because the solution to compliance with **GP1.1** will vary considerably from allotment to allotment. This does not alter the fact that compliance must be achieved with **GP1.1**.

GP1.2

Swimming pools — access for young children

GP1.2 relates to swimming pool barriers. Swimming pool safety fencing should be constructed so as to be impenetrable by young children, having regard to:

- the height and rigidity of the fence;
- any horizontal climbable members;
- openings and footholds in the fence; and
- the operation of self-closing and latching gates.

GP1.2(a) requires barriers be continuous. However, the barrier does not have to be a single form or type of construction (eg: it may consist of allotment fences in combination with building walls).

A barrier must have sufficient structural strength to withstand people leaning or falling against it. Guidance on suitable structural loading criteria can be obtained from AS 1926.

GP1.2(c) requires that young children be prevented from entering the immediate pool surrounds.

GP1.2(d) requires any access gates or doors to be self-closing and latching.

The limitation of the application of **GP1.2** is the same for **GF1.2**.

GP1.3

Accidental locking in small spaces

GP1.3 relates to areas such as refrigeration and cooling chambers. It aims to maximise the safety of people working in them, by preventing them accidentally being trapped inside.

These provisions only relate to chambers of sufficient size for a person to enter.

GP1.3(a) requires a communication system to allow people within the chamber to alert others that they are trapped, etc. The communication system should be able to be seen or heard above any work going on in the building.

GP1.3(b) specifies that the egress route door must:

- be of sufficient size for an adult to move through; and
- be openable from the inside without a key at all times. (This provision overrides any corresponding requirements or concessions in **Section D**).

GP1.4

GP1.4 aims to maximise the safety of people working in strong-rooms and vaults of sufficient size to allow people to enter.

Within the vault there must be:

- means of communication with people in the building; and
- an internal light controlled only from within the room (ie: there must be no override switch outside the vault).

Under **GP1.4(c)**, there must be an indicator outside the vault which clearly shows if it is occupied. The indicator should be clearly marked as relating to the actual vault.

PART **G1** MINOR STRUCTURES AND COMPONENTS

Deemed-to-Satisfy Provisions

G1.0 Deemed-to-Satisfy Provisions

Intent

To clarify that:

- there are no Deemed-to-Satisfy Provisions for compliance with **GP1.1**; and
- compliance with **GP1.2–GP1.4** will be achieved if compliance is achieved with **G1.1** and **G1.2**.

No Deemed-to-Satisfy Provisions for **GP1.1**

There are no **Deemed-to-Satisfy Provisions** for **GP1.1**. This is because the solution to compliance with **GP1.1** will vary considerably from allotment to allotment. This does not alter the fact that compliance must be achieved with **GP1.1**.

Some options for compliance may be found in Volume Two of the BCA: Part 3.1.2.

Information on drainage requirements may be obtained from the appropriate authority. The legal discharge point from an allotment is generally determined by the relevant local government authority.

G1.1 Swimming pools

Intent

To minimise the risk of young children sustaining injury as a result of gaining unsupervised access to a swimming pool.

Swimming pools — access for young children

G1.1(a) indicates that the **Deemed-to-Satisfy Provisions** for swimming pools do not apply in certain States and Territories which have separate legislation for swimming pool safety fencing.

G1.1(a) lists the relevant applicable legislation.

G1.1(b) indicates that a barrier installed in accordance with [AS 1926 Parts 1 and 2](#) — *Swimming Pool Safety*, will form a suitable barrier to swimming pools associated with a Class 2 or Class 3 building.

AS 1926 Part 2 provides a number of options for the location of swimming pool safety fencing.

Examples

Options for the location of safety fencing include:

- enclose the pool with isolation-safety fencing, separating the pool area from any other part of the allotment and any buildings;
- separate the pool area from other parts of the allotment, any buildings and neighbouring allotments, with barriers complying with the relevant Australian Standards provisions for safety fencing; and
- if access is provided from the building to the pool area, protect the access door and window openings to the pool area with child-resistant doorsets and child-resistant openable portions of window.

See [Figure G1.1](#).

The operation of self-closing and latching devices on gates should allow it to close and latch from any position — from resting on the latching mechanism to fully open - in accordance with the conditions in AS 2820 (referenced in AS 1926).

G1.2 Refrigerated chambers, strong-rooms and vaults

Intent

To maximise the ability of people working in a strong-room, refrigerated chamber, or the like, to escape the room in an emergency.

Accidental locking in small spaces

G1.2(a) specifies the acceptable safety requirements for a cooling chamber, strongroom or vault which people can enter and work within. The door must be operable from the inside without a key (this requirement overrides any corresponding requirements or concessions in [Section D](#)). Also, there must be dedicated controls within the chamber, room or vault for internal lighting and an external indicator lamp to indicate the space is in use. Activation of the external indicator lamp can only be by operation of the internal light from within the chamber, room or vault.

G1.2(a)(iii) requires a dedicated alarm to alert people outside that a person is trapped inside. The alarm must achieve the specified sound pressure level, and should be located where it will be noticed. The activation of the alarm must be controlled from within the chamber, room or vault, and must not be connected to an external device which can override the internal alarm controls.

G1.2(b) sets out the minimum door opening with specified dimensions for refrigerated or cooling chamber (the clear width criterion means that the measurements must be taken at the narrowest point of the opening, including any protruding door or door hardware).

PART G1 – MINOR STRUCTURES AND COMPONENTS

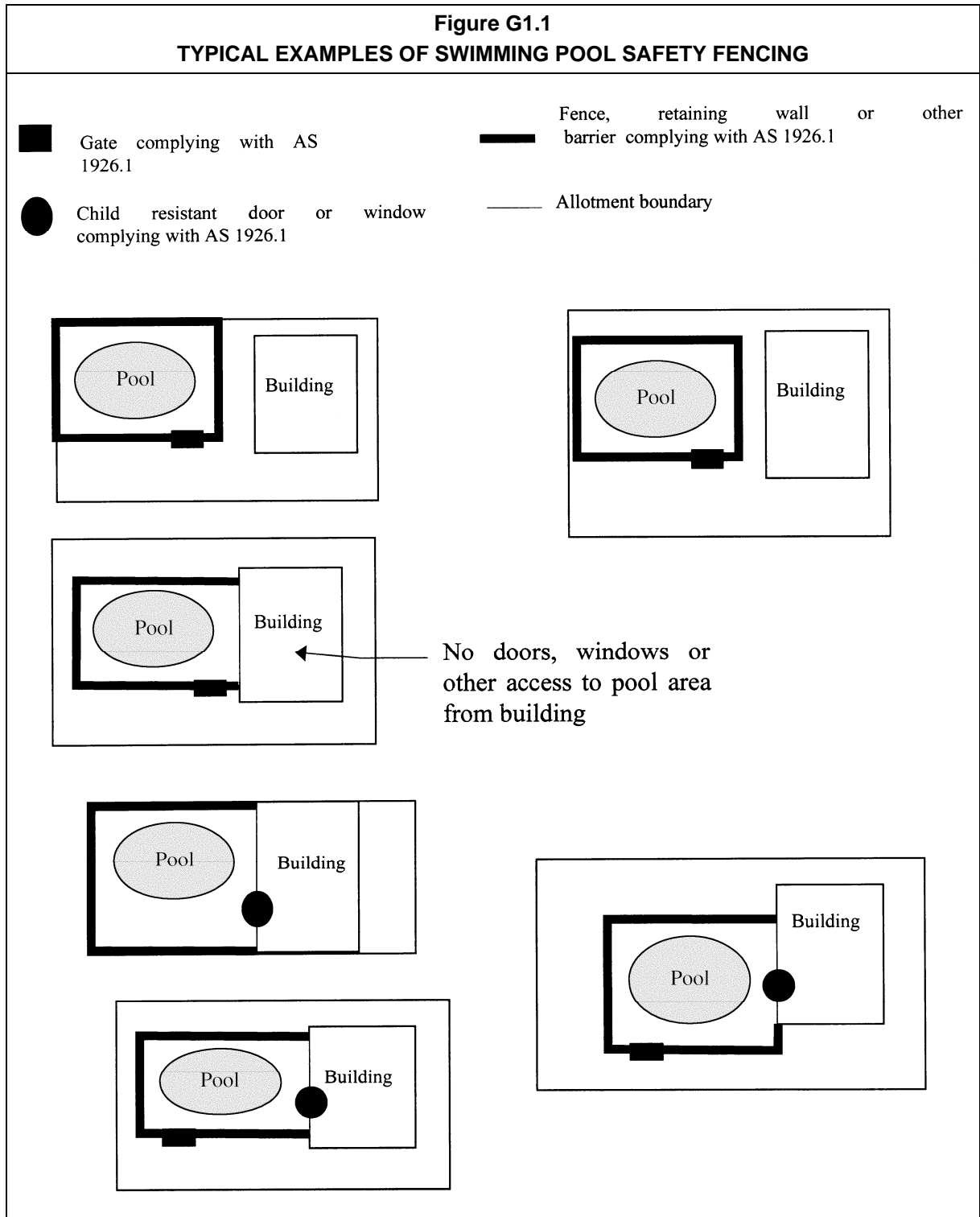

PART **G2** HEATING APPLIANCES, FIREPLACES, CHIMNEYS AND FLUES

Objective

GO2

Combustion appliance — GO2(a)(i)

GO2(a)(i) specifies that people must be protected from injury by fire from a combustion appliance. **GO2(a)(i)** applies only to combustion appliances installed within a building.

Pressure vessel — GO2(a)(ii)

GO2(a)(ii) specifies that people must be protected from injury caused by a malfunction of a pressure vessel. **GO2(a)(ii)** applies only to pressure vessels installed within a building.

The malfunction of a pressure vessel could create steam and/or an explosion.

Protection of building — GO2(b)

GO2(b) requires that a building intended to contain a pressure vessel be designed so that any fault to the pressure vessel will not damage the building. The aim is to make sure that the structural stability of the building is not affected.

Functional Statements

GF2.1

Combustion appliances

GF2.1 requires that a heating system be installed to prevent fire spreading to adjoining building elements.

A key expression in **GF2.1** is 'controlled combustion'. This expression means that only heating units which burn solid materials or oil must comply with these provisions. The expression applies to open fireplaces, oil heaters, solid-fuel burning stoves, coal heaters, pot-belly stoves, and other such cooking and heating devices.

The expression does not include electric heaters. Nor is it intended to include gas heaters, covered by other State and Territory legislation.

GF2.2

Pressure vessels

Additional measures must be taken when a pressure vessel is installed in a building, due to the potential damage and injury which may be caused by a malfunction.

Performance Requirements

GP2.1

Combustion appliances

When installed in a building, a combustion appliance (including all associated components) must be:

- designed to be robust enough to operate under all applicable heating conditions. It is particularly important that flue systems comply with this requirement, so they are compatible with the primary heating unit;
- installed so that, when in operation, the radiated heat will not affect adjoining building elements (ie burn timber, warp steel lintels, char plasterboard and so on). This not only applies to the actual heating unit, but also to the attached flues, especially where they pass through other areas of the building (such as roofs, ceiling spaces, walls and the like); and
- designed and installed so that the hot products of combustion are properly discharged in a manner which will not cause damage. To do this, builders must make sure flues are adequately joined to create a continuous discharge route. The discharge point must be such that discharged products will not re-enter the building. They should not ignite adjoining combustible materials where the appliance is installed.

GP2.2

Pressure vessels

Because of the dangers of pressure vessels, care has to be taken during installation. (Pressure vessels located outside a building are not covered by the BCA, but may be controlled by other State and Territory legislation).

Issues such as leakage of pressurised liquids and the consequences of the vessel being damaged must be considered. Damage must be avoided to the vessel. Such damage could occur if the vessel is located in an area subject to traffic.

PART **G2** HEATING APPLIANCES, FIREPLACES, CHIMNEYS AND FLUES

Deemed-to-Satisfy Provisions

G2.0 Deemed-to-Satisfy Provisions

Intent

To clarify that requirements of **GP2.1** and **GP2.2** will be satisfied if compliance is achieved with **G2.1–G2.4**.

G2.0 clarifies that compliance with **G2.1–G2.4** achieves compliance with **GP2.1** and **GP2.2**.

G2.1 * * * * *

The content of **G2.1** which existed in BCA 1990, is now covered by **GP2.1** and **GP2.2**. The number **G2.1** has been retained in accordance with the decision not to change the numbering of BCA96 from that of BCA 1990.

G2.2 Installation of appliances

Intent

To specify the Australian Standards which are suitable to achieve compliance with **GP2.1** and **GP2.2** as regards the installation of oil-fired appliances, domestic solid-fuel burning appliances, pressure equipment and the like.

Oil-fired and solid-fuel burning appliances and pressure equipment

G2.2 lists several Standards as Deemed-to-Satisfy Provisions for the installation of oil-fired appliances (see **G2.2(a)**), domestic solid-fuel burning appliances (see **G2.2(b)**), and pressure equipment (see **G2.2(c)**).

G2.3 Open fireplaces

Intent

To provide for the safe design and installation of open fireplaces.

The design and installation of open fireplaces

G2.3 relates to open fireplaces where timber or other solid material is burned and there is generally no in-built enclosing structure or apparatus across the front to contain sparks, etc.

The construction of a fireplace must comply with the structural requirements in **Section B** of the BCA. The **G2.3** requirements relate to additional measures for fire safety.

G2.3(a) states that the fireplace must have a hearth made of stone, concrete or other similar non-combustible material. The non-combustible material must be similar in nature to stone and concrete. The concessions for non-combustible material in **Section C** of the BCA, particularly **C1.12** (such as plasterboard and similar lightweight materials), must not be construed as complying with these specific provisions.

With the increased danger due to the open-fire area, **G2.3(a)** contains requirements to ensure the area in front of the opening is protected. The hearth is intended not only to protect adjoining building elements from sparks, but also to reduce the danger of logs rolling out. See **Figure G2.3**.

G2.3(b) deals with the construction of a fireplace (additional to the requirements of **Section B**). These relate to the fire box, and the need to ensure that the walls adjacent to the fire can withstand the heat. Concrete blockwork is not allowed to form the fire box, because it performs poorly under repeated heating and cooling cycles.

G2.3(c) contains the requirements for chimneys.

G2.3(c)(i) aims to make sure the masonry of a chimney is capable of withstanding heat. The construction requirements are less than those for the firebox, because the most intense area of the fire is below the actual level of the chimney.

G2.3(c)(ii) contains a requirement to line the chimney with a rendering mix to make sure it draws properly. A smoother surface:

- allows a freer air-flow up the chimney, and therefore removes smoke more effectively; and
- helps to minimise soot build-up, therefore minimising the risk of chimney fires.

G2.3(d) contains a requirement to ensure that damp-proof courses and flashings are installed. Section 3.3 of Volume Two of the BCA contains some options for compliance.

G2.4 Incinerator rooms

Intent

To provide requirements for the safe installation of an incinerator room in a building.

Incinerators, hoppers and incinerator rooms

G2.4(a) contains requirements for incinerators and their hoppers. ‘Hopper’ refers to the area used to feed the incinerator. The requirements for hoppers aim to make sure they do not increase the risk of fire to the adjoining building area.

G2.4(a)(v) states that a hopper must not be located in a required exit. This is to prevent any potential problem where a failure in the hopper could affect the egress route.

G2.4(b) requires an incinerator to be fire separated from the remainder of the building.

Figure G2.3
FIRE PLACE CLEARANCE FROM COMBUSTIBLE MATERIALS

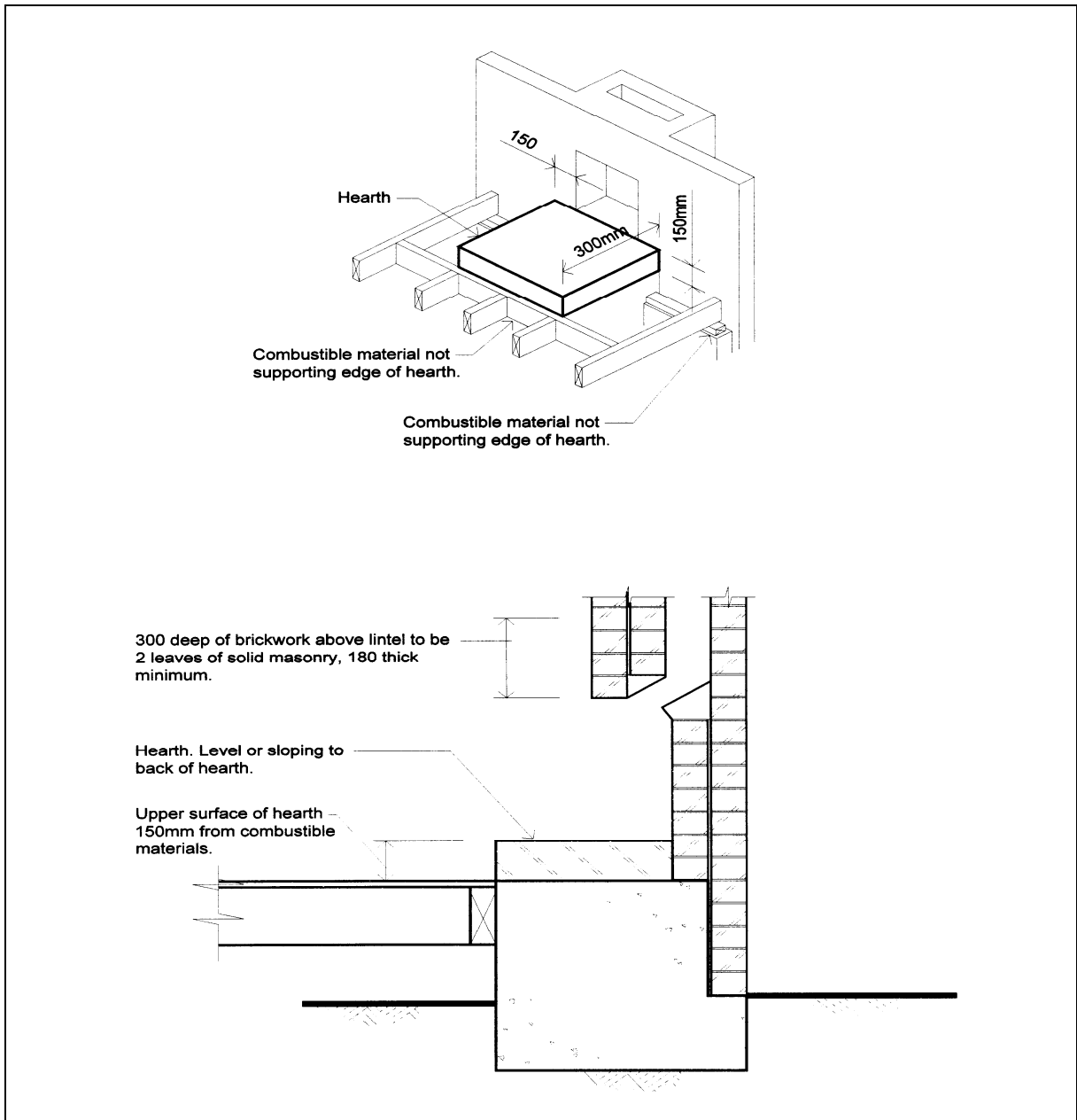

PART G3 ATRIUM CONSTRUCTION

Objective**Functional Statements****Performance Requirements**

The Objective, Functional Statements and Performance Requirements for Part **G3** are contained in **Sections C, D and E**. Part **G3** contains additional deemed-to-satisfy provisions for buildings that contain an atrium.

PART **G3** ATRIUM CONSTRUCTION

Deemed-to-Satisfy Provisions

The Objective, Functional Statements and Performance Requirements for Part **G3** are contained in **Sections C, D** and **E**. Part **G3** contains additional Deemed-to-Satisfy Provisions for buildings that contain an atrium.

G3.1 Atriums affected by this Part

Intent

To clarify which atriums must comply with Part **G3**.

The BCA defines the term ‘atrium’. It is important to understand this BCA definition before considering Part **G3**. See definition in **A1.1**.

Part **G3** does not apply to an atrium if it connects two storeys in a non-sprinkler protected building, or up to three storeys if each of the connected storeys is sprinkler protected and one of those storeys is at a level giving egress to a road or open space.

This provision is consistent with **D1.12**, which deals with the number of floors that can be connected by a non-required non-fire-isolated stairway, ramp or escalator.

G3.2 Dimensions of atrium well

Intent

To minimise the risk that radiant heat from a fire will affect people or materials on the other side of an atrium well.

The BCA defines the terms ‘atrium’ and ‘atrium well’. It is important to understand these BCA definitions, before considering Part **G3**. See definitions in **A1.1**.

An atrium well is not limited to having a maximum size, nor is there a limitation on its shape, except that it must contain a space throughout which could contain a cylinder with a diameter of 6 metres. This 6 metres is equal to the minimum distance between unprotected openings in external walls of adjoining buildings required by **C3.2**. This diameter void is intended to reduce the effects of radiant heat from a fire:

- affecting occupants evacuating on the other side of the atrium well; and
- igniting materials on the other side of the atrium well.

Figure G3.2 illustrates the method of measuring the atrium well to comply with G3.2 and the location of an atrium's bounding walls.

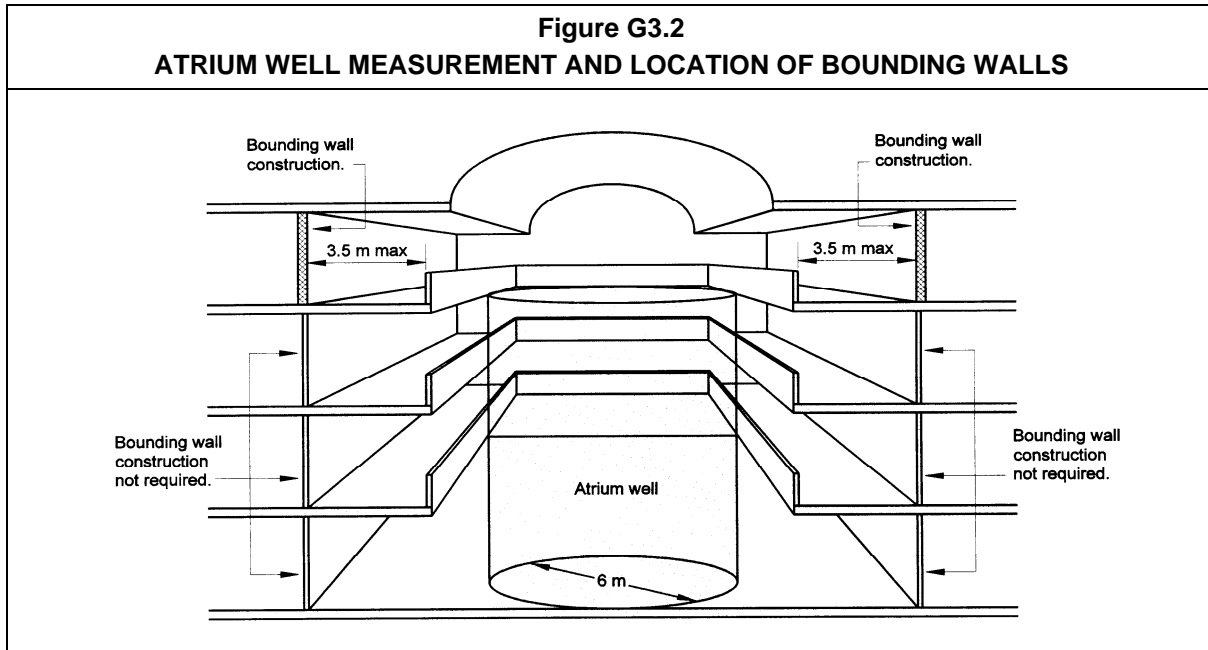

G3.3 Separation of atrium by bounding walls

Intent

To minimise the risk of spread of fire and smoke from or to the atrium or other parts of the building.

G3.3 requires the use of bounding walls, which limit the risk of fire and smoke spreading from the atrium to other parts of the building and other parts of the building to the atrium.

The detailed requirements for bounding walls are explained in the Comments on Clause 2.4 of Specification G3.8.

The bounding wall and 3.5 metre setback requirements do not apply where there are three or less consecutive storeys and:

- one of these storeys is located at the level from which direct egress is provided to a road or open space; and
- the total floor area of these storeys is limited to that specified in Table C2.2 (the floor area referred to in G3.3(b) is that of the three storeys, and not the total floor of the atrium).

Figure G3.3 illustrates the floors included in the area permitted by Table C2.2.

Figure G3.2 illustrates the location of an atrium's bounding walls.

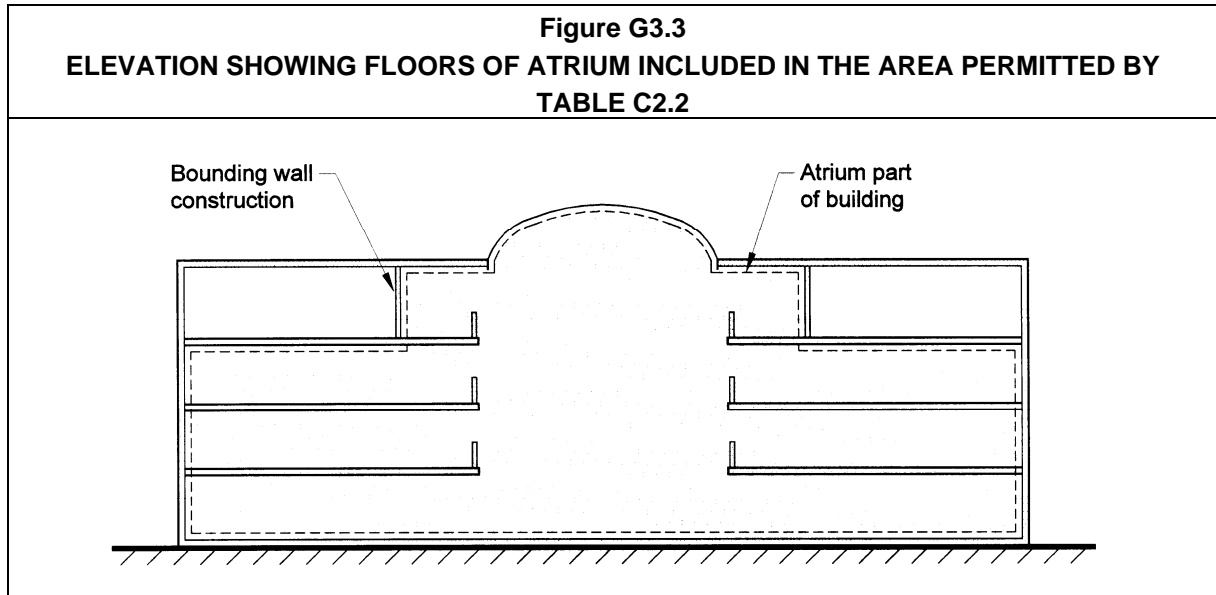

G3.4 Construction of bounding walls

Intent

To limit the spread of fire between different parts of a building by way of an atrium.

G3.4 establishes the required FRL and acceptable construction requirements for the bounding walls required by G3.3. See Figure G3.4.

The walls bounding an atrium are not fire walls as defined in the BCA. Therefore, these walls do not create separate fire compartments within a storey of the building. The bounding walls define the extent of the part of the building regarded by the BCA to be an 'atrium'. See Figure G3.2.

G3.4 prescribes two options for construction of bounding walls:

- applies where the bounding walls are constructed of materials with a FRL of 60/60/60; or
- applies where the bounding walls are constructed of fixed toughened or wired safety glass in non-combustible frames.

Figure G3.4
EXAMPLES OF BOUNDING WALLS COMPLYING WITH G3.4

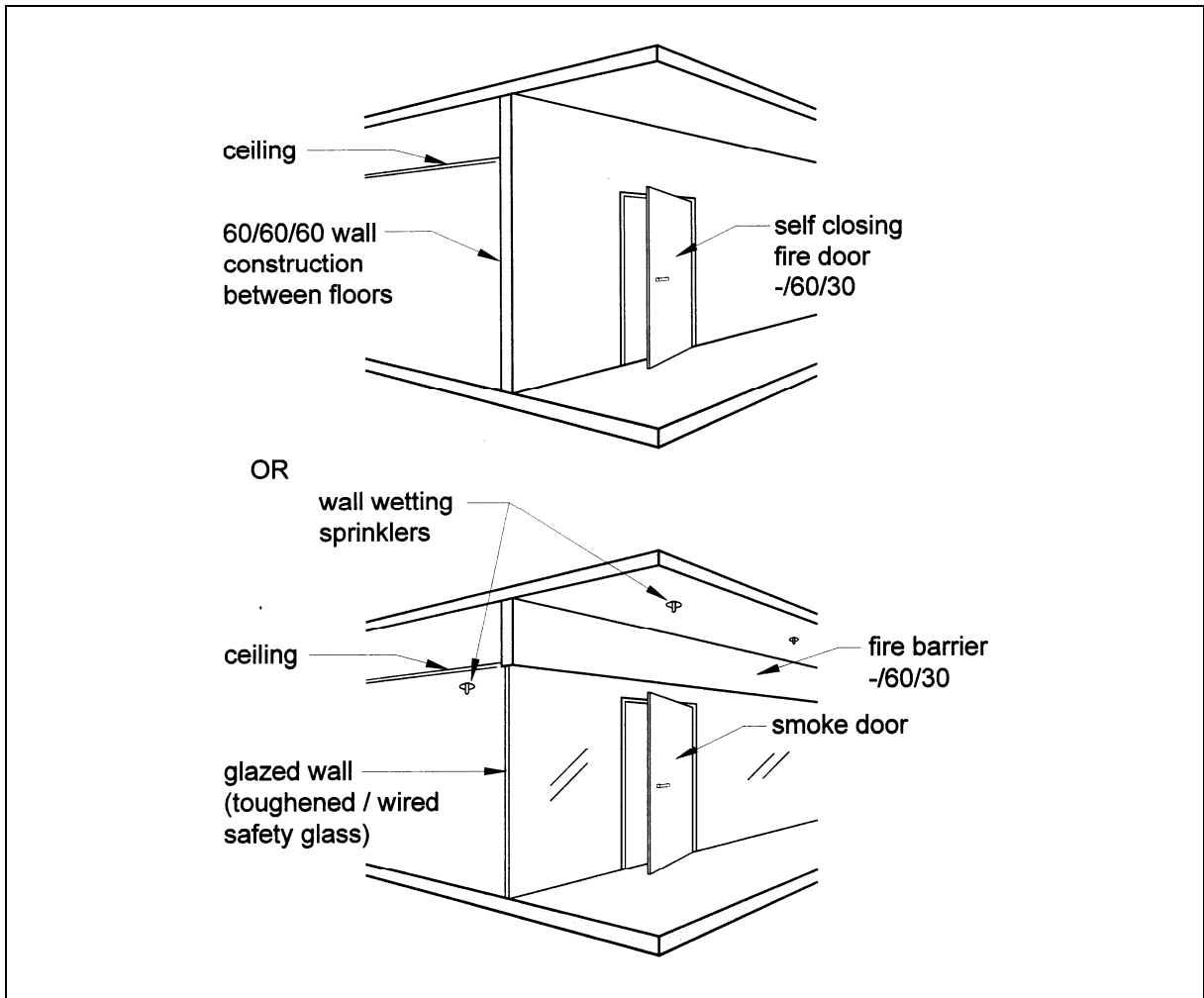

G3.5 Construction at balconies**Intent**

To maximise the safety of people who have access around an atrium.

To maximise public safety, a balustrade or barrier is required at the edge of a balcony to an atrium. The balustrade or barrier must:

- have no openings and be non-combustible, to act as a shield from heat during a fire; and
- have a height of 1 metre — which is consistent with **D2.16**.

G3.5 takes precedence over the provisions of **D2.16** for balustrades and other barriers around an atrium.

G3.6 Separation at roof**Intent**

To minimise the risk that the roof of an atrium will not remain in place during a fire

Clause 3 of **Specification G3.8** requires smoke extraction through the roof, or near the top of an atrium — this smoke extraction is required to be by mechanical exhaust or by smoke and heat vents.

It is therefore important that the roof remains in place during a fire and not allow the re-circulation of smoke. To achieve this, **G3.6** requires:

- the roof to have the FRL required by **Table 3** of **Specification C1.1**; or
- the roof structure and membrane to be protected by a sprinkler system.

The materials used in the roof must comply with:

- the fire hazard properties specified in **Specification C1.10**; and
- when the roof is required to have an FRL, **G3.6(a)** does not allow the use of the concessions contained in **Clauses 3.4, 3.5 or 3.6** of **Specification C1.1** for the roof of the atrium.

G3.7 Means of egress**Intent**

To require that safe egress is available from an atrium.

Although the building may have an effective height of less than 25 metres, two exits are required from any area within an atrium. This is due to the additional fire hazard associated with atriums.

There may be other parts of the BCA which permit buildings to have only a single exit. **G3.7** overrides any such provisions insofar as they relate to atriums.

All other aspects of the means of access and egress from an atrium must comply with **Section D**.

G3.8 Fire and smoke control systems

Intent

To specify the additional fire and smoke control systems required for an atrium.

Because of the additional fire hazard associated with an atrium, special fire and smoke control measures are required to reduce the likelihood of conditions being reached which could endanger the safety of occupants before they have time to evacuate. These measures are set out in **Specification G3.8**.

SPECIFICATION G3.8**FIRE AND SMOKE CONTROL
SYSTEMS IN BUILDINGS
CONTAINING ATRIUMS****Deemed-to-Satisfy Provisions**

Specification G3.8 only applies to the Deemed-to-Satisfy Provisions.

1 Scope**Intent**

To clarify that **Specification G3.8** includes the requirements for fire and smoke control systems in buildings with an atrium.

Specification G3.8 includes the requirements for fire and smoke control systems in buildings containing an atrium.

Where a sprinkler system is required, it must be installed in the whole building, not just that part in which the atrium is located.

2 Automatic fire sprinkler system**General requirement****Intent**

To set out the general requirements for the installation of a suitable sprinkler system in a building containing an atrium.

Generally, a sprinkler system must comply with **Specification E1.5**. The remainder of **Clause 2** of **Specification G3.8** sets out additional requirements for sprinklers in a building containing an atrium.

If any conflict exists between **Specification E1.5** and **Clause 2**, then **Clause 2** takes precedence.

Roof protection

Intent

To set out the roof protection requirements for a building containing an atrium.

Clause 3 requires smoke extraction through the roof, or near the top of the atrium. It is therefore important that the roof remains in place during a fire and does not allow the re-circulation of smoke. To achieve this, **G3.6** requires the roof:

- to have the FRL required by **Table 3** of **Specification C1.1**; or
- structure and membrane to be protected by a sprinkler system.

Figure Spec G3.8 illustrates the alternative protection of an atrium roof.

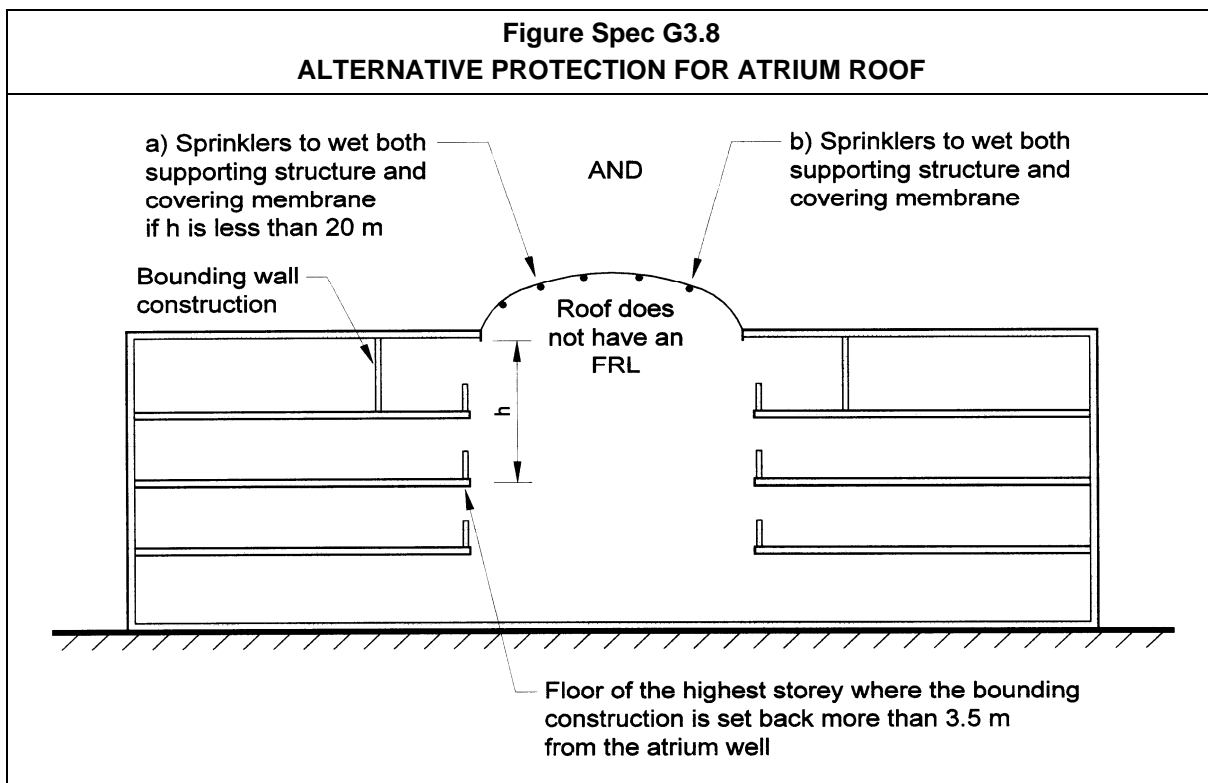

When the roof is required to have an FRL, **G3.6(a)** does not allow the use of the concessions contained in **Clauses 3.4, 3.5** or **3.6** of **Specification C1.1** for the roof of the atrium.

The sprinkler protection requirement only applies to a roof located in an area where a fire could affect its integrity. The distances stated in **Clauses 2.2(a)** and **(b)** differ because of the different fire loads assumed in the different Classes of building. The heights of the atrium roof have been selected as those beyond which a smoke plume produced by a typical fire would no

longer be hot enough to damage an unprotected roof.

The sprinkler heads need only be arranged to give a wetting effect to both the underside of the roof membrane and any part of the supporting structure.

The higher temperature rating of the sprinkler heads is to make sure they do not falsely discharge due to the potentially higher normal temperatures under an atrium roof, especially if a glass or translucent roof is used (as is common practice).

Clause 3 requires smoke extraction through the roof, or near the top of an atrium. The smoke extraction is required to be by mechanical exhaust or by smoke and heat vents.

Atrium floor protection

Intent

To set out fire protection requirements for atrium floors (ie at the lowest level of the atrium).

Because of the height of the roof in an atrium, the sprinklers protecting it are unlikely to be effective at the lowest level of the atrium. Additional sprinklers are therefore normally required to protect that level, as this area is normally a large open space, and is potentially the primary source of a major fire. Adequate protection of the floor often requires the use of sidewall sprinkler heads, as required by **Clause 2.3(a)**. **Clause 2.3(a)** requires a ‘performance-type’ decision as to the types of sprinklers (sidewall and overhead) and their combination.

Because of the additional fire hazard associated with atriums, **Clause 2.3(b)** requires the use of fast response sprinkler heads. So that the heat does not pass the head without setting it off, larger than normal heat collector plates are required.

Although a ‘fast response’ sprinkler head can activate at the same temperature as a ‘normal’ sprinkler head, its reaction time is much shorter and it has different discharge characteristics. Therefore, **Clause 5** of **Specification E1.5** requires that the sprinkler system be designed specifically for the use of these heads.

Sprinkler systems to glazed walls

Intent

To set out fire protection requirements for glazed walls to an atrium.

Clause 2.4.1 sets out the requirements for sprinkler protection of glazed bounding walls. These requirements are illustrated in **Figure G3.4**.

Under **Clause 2.4.2**, the location of the sprinkler heads must allow full wetting of the glazing without wetting an adjacent head. Consequently, water should run down the window, cooling

the glass and therefore creating a resistance to the spread of fire or smoke through the glazed wall by reducing its potential to failure during a fire. It is also important that the adjacent sprinkler head not be wetted, because the cooling effect of the water may delay its activation.

Because of the additional fire hazard associated with atriums, **Clause 2.4.3** requires the use of ‘fast response’ sprinkler heads. So that the heat does not pass the head without setting it off,

Clause 2.4.1 requires the installation of heat collector plates (which increase the sensitivity of the system).

Although a ‘fast response’ sprinkler head can activate at the same temperature as a ‘normal’ sprinkler head, its reaction time is much shorter and it has different discharge characteristics.

Clause 2.4.4 sets out the minimum requirements for water discharge rates. **Clause 5** of **Specification E1.5** therefore requires that the sprinkler system be designed specifically for the use of these heads.

Clause 2.4.4 sets out the required water discharge rates on any glazing in a bounding wall. Because the atrium can have a high fire load and large volume, the higher flow rate of 0.25 L/s.m² is required on the atrium side of the glazing when the wall is not set back from the atrium well.

The importance of the wall sprinklers to glazed walls in a fire is such that **Clause 2.4.5** sets out the minimum potential coverage to be provided by such sprinklers, which in turn determines the characteristics of the water supply in terms of pressure and quantity.

The water supply for the wall wetting system referred to in **Clause 2.4.5** is additional to the water supply for the other sprinklers in the building.

It is assumed that the size of a fire will be controlled by the sprinkler system installed in the building. The greater height required to be covered by a wall wetting sprinkler system in a Class 6, Class 7 or Class 8 part of a building (see **Clause 2.4.5(a)(ii)**) reflects the greater fire load contained in such buildings.

Stop valves

Intent

To set out requirements for sprinkler and wall wetting system stop valves.

When referring to sprinkler and wall wetting stop valves, **Clause 2.5** requires that:

- they be monitored to detect and warn of any unauthorised closure; and
- the sprinkler and wall wetting systems have independent valves.

3 Smoke control system

General requirements

Intent

To set out the general requirements for the installation of a suitable smoke control system in a building containing an atrium.

As generally required by the BCA, mechanical air-handling systems must comply with [AS/NZS 1668.1](#). However, if any conflict exists between [AS/NZS 1668.1](#) and **Specification G3.8**, the Specification takes precedence.

Operation of atrium mechanical air-handling systems

Intent

To set out mechanical air-handling system requirements for an atrium.

The basic operation of the mechanical air-handling system during a fire is to limit the spread of smoke. To achieve this it must:

- maintain a tenable atmosphere along balconies to allow the occupants to evacuate; and
- avoid smoke being drawn into the atrium when a fire occurs in another part of the building, which requires that—
 - the atrium smoke exhaust fans activate only when smoke enters the atrium;
 - the atrium cannot be used as a return air path; and
 - the normal relief or exhaust fans in the atrium must stop normal operation. If necessary, these fans may be designed for exhausting smoke from the atrium.

The intent of the details contained in **Clause 3.2(d)** and **(f)** is to create a negative air pressure on the fire floor or in the fire affected compartment, so that air and any entrained smoke is drawn to it. This creates positive pressure on non-fire floors, so as to prevent the migration of smoke to non-fire floors while exhausting smoke from a fire affected floor.

Activation of smoke control system

Intent

To set out how a smoke control system serving an atrium is to be activated.

The smoke control system may be activated by any of the methods listed in **Clause 3.3(a)**. The location of the controls for the system may be any of those listed in **Clause 3.3(b)**. Note that the locations are in areas normally accessed and used by the fire brigade during a fire.

Smoke exhaust system

Intent

To set out the design characteristics of a smoke exhaust system serving an atrium.

Clause 3.4 specifies the characteristics on which a smoke exhaust system design must be based, which are:

- the size to which the sprinkler system will limit a fire, in terms of its heat output and perimeter;
- the extent of any smoke plume; and
- the system's discharge rate, as calculated under **Figure 3.4** of the BCA.

Figure 3.4 of the BCA must be used to determine the minimum smoke extraction rate from the atrium. The required rate depends on the fire load specified in **Clause 3.4(a)** and the height of the smoke plume above the floor of the atrium well specified in **Clause 3.4(b)**.

The exhaust rates are based on the need to maintain the smoke plume safely above any egress path.

Upward air velocity**Intent**

To enable the movement of smoke to the roof, for venting externally.

If the smoke is allowed to travel up the atrium due to its own buoyancy, in higher atriums it will reach a stage where it will not travel any higher. The reasons for this include:

- the smoke will not have enough buoyancy to reach the top of the atrium; and
- the smoke will entrain air, and cool as it rises.

Accordingly, to make sure the smoke continues to travel up the atrium well, minimum (see **Clause 3.5(a)**) and maximum (see **Clause 3.5(b)**) air velocities are specified. The maximum velocity specified in **Clause 3.5(b)** only applies to an atrium well with a constant plan cross section.

Exhaust fans**Intent**

To set out the operational requirements for exhaust fans.

To make sure that exhaust fans operate effectively during a fire, they must be designed to operate for at least 1 hour at a temperature of 200°C (see **Clause 3.6(a)**).

Under **Clause 3.6(b) and (c)**, to make sure that at least one fan continues to operate during a fire:

- at least three fans are required in atriums adjoined by Class 2, Class 3 or Class 9 parts, because of the heightened risk levels in such areas. This is due to such factors as the

possibility that people will be sleeping and, in Class 9a buildings, the presence of non-ambulatory occupants; and

- at least 2 exhaust fans are required in all other atriums.

Smoke and heat vents

Intent

To set out requirements for smoke and heat vents, which are permitted in low-rise atriums.

Smoke and heat vents are permitted in low-rise atriums (ie atriums less than 12 metres high), instead of a mechanical smoke extraction system.

The reason for the **Clause 3.7(a)** limit is that 12 metres is considered to be a height to which smoke will travel due to its own buoyancy and still be effectively vented.

Clause 3.7 does not apply where a Class 6 part of a building adjoins the atrium.

Clause 3.7(b) requires that vents be fitted with a manual override switch, for use as necessary by emergency services personnel.

Make-up air supply

Intent

To set out requirements for air flow into an atrium from which smoke-laden air is being extracted.

Clause 3.1 to 3.7 require that smoke-laden air be exhausted from an atrium. **Clause 3.8** sets out how this exhausted air is to be made-up (ie replaced) in the atrium.

Clause 3.8(a) is a performance criterion that requires make-up air to be provided from outside the atrium at a level at or near the lowest storey of the atrium and non-fire storeys.

To make sure that the area where the bounding walls are set back from the atrium well is kept smoke free, an air velocity of 0.1 m/s is required by **Clause 3.8(b)**. This velocity is consistent with that required through an open door by a fire-isolated stairway pressurisation system which accords with [AS/NZS 1668.1](#).

Clause 3.8(c) provides a means of achieving **Clause 3.8(a)**. It is important that the make-up air assists (and does not disturb) the exhausting of the smoke layer. To achieve this, the make-

up air should enter the atrium at as low a level as possible, preferably at the base of the atrium. The make-up air must be provided from:

- openings designed to open to outside air on detection of a fire in the atrium; or
- a system of ducts to supply outside air to the atrium; or
- a combination of the above.

If a system of ducts is used to supply the make-up air, to make sure the system operates when needed during a fire, the ducts must have an FRL of 60/60/60 if they pass through a different fire compartment to the atrium.

4 Fire detection and alarm system

Intent

To set out the general requirements for the installation of a suitable fire detection and alarm system in a building containing an atrium.

General

A building's fire detection and alarm system must, in general, comply with [AS 1670.1](#). However, if any conflict exists between [AS 1670.1](#) and **Specification G3.8**, the Specification takes precedence.

Smoke detection system

Intent

To set out requirements for smoke detectors in an atrium.

Clause 4.2 sets out, in detail, the requirements for smoke detectors within an atrium. The aim of these requirements is to make sure that the smoke detection system operates effectively and false alarms are minimised.

Smoke detection in spaces separated from the atrium by bounding walls

Intent

To set out requirements for smoke detectors at return and relief air openings.

Clause 4.3 sets out the requirements for smoke detectors at return and relief air openings.

Alarm systems

Intent

To set out requirements for alarm systems in a building containing an atrium.

Alarm systems required in a building containing an atrium, must include a break glass alarm at each door to a fire-isolated exit. The aim of this provision is that a person is able to break the glass setting off the alarm as they evacuate the building.

Where a sampling type smoke detection system is provided, a staged alarm must be given. The stages are set out in **Clause 4.4(b)(i) to (iii)**. The reason for the staged alarms is to minimise the occurrence of false alarms.

Under **Clause 4.4(c)**, beam and point type smoke detectors (as with a sampling type smoke detection system) must also operate as set out in **Clause 4.4(b)(i) to (iii)**, but at the levels set in [AS/NZS 1668.1](#). This provision only applies to beam and point type smoke detectors required by the BCA.

5 Evacuation warning and intercommunication system

Intent

To require that a suitable emergency warning and intercommunication system is installed in a building containing an atrium.

Clause 5 requires the installation of an emergency warning and intercommunication system (EWIS) in any building containing an atrium. The EWIS must comply with:

- [AS 2220.1](#) and [AS 2220.2](#); and
- the additional requirements set out in **Clause 5(b)**.

An EWIS is a combination of an emergency warning system and an emergency intercommunication system. The main function of an integrated system is:

- to generate an alert and evacuation signal;
- to facilitate communication with evacuation zones; and
- to provide communication between the building management or emergency services personnel and strategic points within the building.

The operation of the EWIS may be by a number of measures referred to in **Specification G3.8**, including the break glass alarm required by **Clause 4.4(a)**.

6 Standby power system

Intent

To require the installation of a suitable standby power system in a building containing an atrium.

Clause 6 only applies where a required path of travel to an exit passes through an atrium (see **Clause 6(a)**).

Under **Clause 6(a)**, because of the need to continue the operation of emergency services, a standby power supply is required. This is particularly important because of the increased fire hazard associated with atriums, and the dangers for occupants if they have to evacuate through atriums.

To make sure it operates when needed during a fire, the standby power supply must:

- automatically come into operation when the normal power supply fails;
- if located within the building, be protected by fire-resisting construction;
- be connected to the safety systems by means of cabling suitable to resist fire; and
- come from two supply sources.

Clause 6 is consistent with the protection required for electricity supply systems in **C2.13**.

Clause 6(c) sets out means of achieving **Clause 6(a)**. To make sure that the necessary power to operate the emergency equipment is available during a fire, it requires the standby power to be from one of the listed alternatives.

7 System for excluding smoke from fire-isolated exits

Intent

To minimise the risk of smoke entering a fire-isolated exist in a building containing an atrium.

Reference to **E2.2**, and in particular **Table E2.2(a)**, means that all fire-isolated exits serving an atrium must be provided with a pressurisation system in accordance with [AS/NZS 1668.1](#). The reason for this is the additional fire hazard associated with atriums and for occupants evacuating them.

PART **G4** CONSTRUCTION IN ALPINE AREAS

Introduction

Special provisions for alpine area construction — reasons

Sub-zero temperatures

Due to the extreme cold, the use of open-fire places and other heating devices is common. This increases the potential for accidents and the possibility of fire.

Accident potential from combustion heaters

Buildings constructed in alpine areas need special consideration because of sub-zero temperatures. The temperatures can create elements which restrict free movement to and from the building. They can also complicate the role of fire brigades and other emergency services.

Alpine areas

Part **G4** only applies in 'alpine areas'. In NSW, ACT, or Victoria, this means areas more than 1200 metres above Australian Height Datum (AHD). In Tasmania, it is more than 900 metres above the AHD. See [Figure G4.1](#).

Objective

GO4

Protection while evacuating

GO4 specifies that occupants of buildings in alpine areas must be protected while evacuating in an emergency. The protection measures are only required to assist while the building is being evacuated. The additional measures included in Part **G4** are necessary because of the conditions which can exist in alpine areas.

Precedence over other BCA provisions

GO4's Application provision clarifies that if there is any contradiction between the requirements in this Part and the rest of the BCA, then the provisions of Part **G4** will take precedence.

Functional Statement**GF4.1****Additional safety measures necessary**

GF4.1 adds an additional dimension to **G04** by indicating that additional measures are necessary because of the difficulties faced by fire brigades in gaining quick access to buildings during an emergency, and maintaining building access and egress during snow conditions.

Precedence over other BCA provisions

The application provision included as part of **GF4.1** clarifies that if there is any uncertainty between the requirements in this Part and the rest of the BCA, then the provisions of Part **G4** will take precedence.

Performance Requirements**GP4.1****External doors must continue to operate**

GP4.1 requires external doors to continue to operate effectively in snow conditions so people can leave in an emergency by the normal egress route, (ie: the doorway).

Such a doorway must not be made inoperable by deposits of snow and ice. Care needs to be taken to avoid locating doorways where:

- snow falling from adjoining roof areas could affect egress paths; and
- re-entrant corners of a building increase the potential for snow to be trapped.

Precedence over other BCA provisions

GP4.1's Application provision clarifies that if there is any uncertainty between the requirements of **GP4.1** and the rest of the BCA, then **GP4.1** will take precedence.

GP4.2**External trafficable structures must be usable**

Any external structures used as part of an egress route must remain accessible in snow conditions. An external balcony not designed for egress from the building would not need to comply.

To comply with this provision it is necessary to make sure that snow build up is avoided and that the surfaces reduce the potential for people slipping.

Precedence over other BCA provisions

GP4.2's Application provision clarifies that if there is any uncertainty between the requirements of **GP4.2** and the rest of the BCA, then **GP4.2** will take precedence.

GP4.3

Adjacent areas — snow or falling ice

Areas adjacent to the building should not be subjected to heavy deposits of built-up snow or falling ice which could harm:

- people evacuating (ie: roofs must be designed to avoid depositing snow on egress routes from the building); and
- people using the area adjacent to the building (ie: snow from the roof area should not cascade on to public thoroughfares and roads or on to adjoining property in a dangerous manner).

Precedence over other BCA provisions

GP4.3's Application provision clarifies that if there is any uncertainty between the requirements of **GP4.3** and the rest of the BCA, then **GP4.3** will take precedence.

GP4.4

Installation of fire safety equipment

GP4.4(a) requires that a building have equipment to facilitate fire-fighting operations. With the increased risk of fire development and access problems for fire brigades in alpine areas, it is important that suppression equipment be available to combat a fire in its early stages of development, to possibly prevent the fire reaching an uncontrollable stage.

It is not intended that occupants fight a fire if there is any danger to them. It is essential that occupants be able to evacuate safely before untenable conditions are reached.

Care will need to be taken in design and construction to ensure that water in fire-suppression equipment will not freeze, making the equipment useless.

GP4.4(b) requires the installation of a system to alert occupants of an emergency. Where an external alarm is installed, care must be taken that the sub-zero temperatures do not freeze its mechanism.

Precedence over other BCA provisions

GP4.4's Application provision clarifies that if there is any uncertainty between the requirements of **GP4.4** and the rest of the BCA, then **GP4.4** will take precedence.

PART **G4** CONSTRUCTION IN ALPINE AREAS

Deemed-to-Satisfy Provisions

G4.0 Deemed-to-Satisfy Provisions

Intent

The requirements of **GP4.1–GP4.4** will be satisfied if compliance is achieved with **G4.1–G4.9**.

G4.1 Application of Part

Intent

To clarify that Part G4 applies only to buildings in alpine areas, and its provisions override any others in the BCA which are in conflict.

Buildings in alpine areas only — G4.1(a)

G4.1(a) indicates that the requirements of Part **G4** only apply to buildings constructed in an alpine area. See [Figure G4.1](#).

Precedence over other provisions — G4.1(b)

G4.1(b) indicates that the provisions of Part **G4** take precedence over any other provisions in the BCA, but only if they are in conflict.

G4.2 * * * * *

This provision was blank in BCA 1990. In accordance with the decision not to change the numbering of BCA96 from that of BCA 1990, this provision has been left blank.

Figure G4.1
MAP SHOWING ALPINE AREAS IN AUSTRALIA

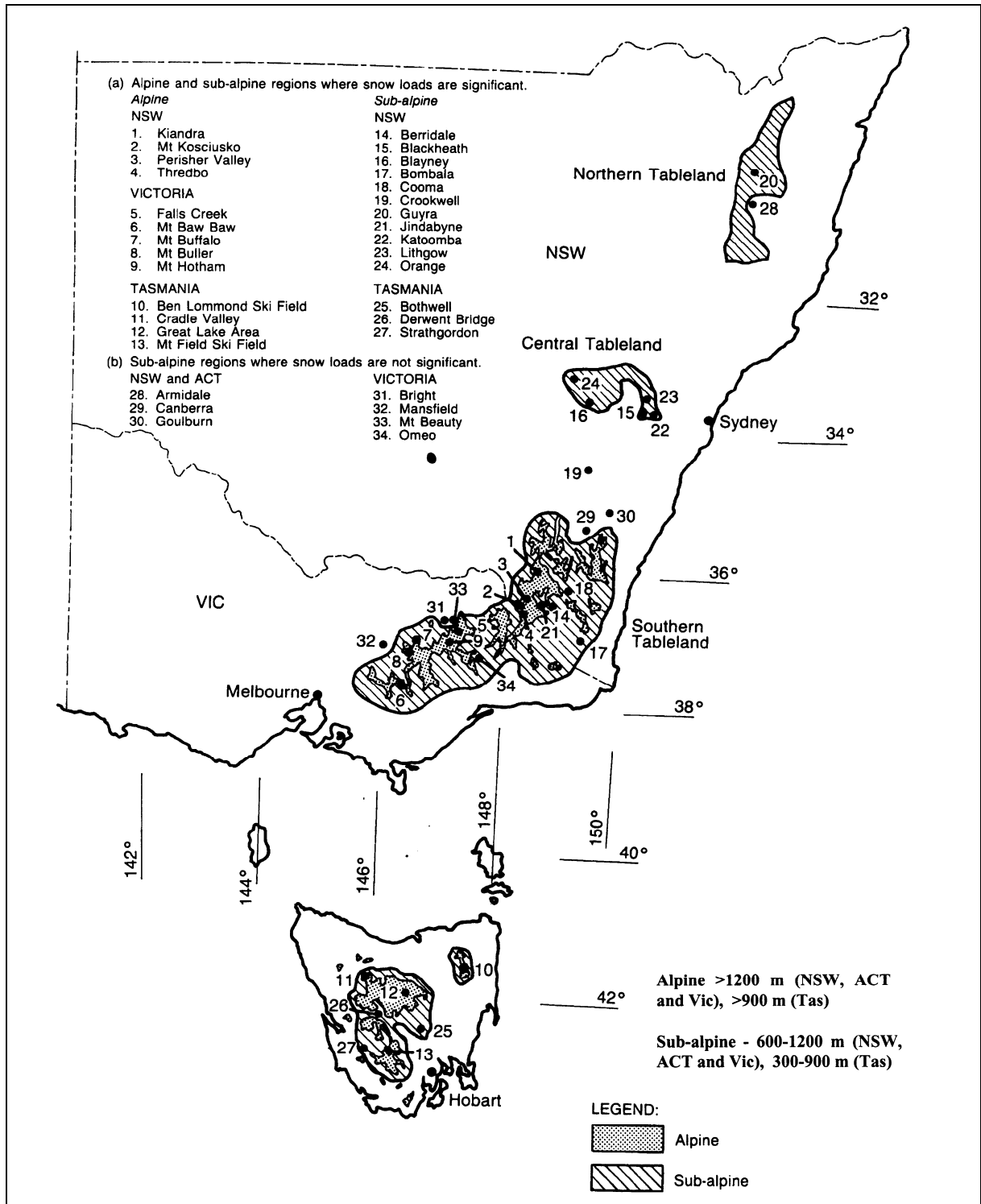

G4.3 External doorways

G4.2

Intent

To enable people to evacuate a building in an alpine area in an emergency without being impeded by snow and ice.

Inwards opening external doorwaysDoors in non-alpine areas

In most buildings, exit doors must open outwards to assist with evacuation. The outward opening door swings in the direction of people leaving the building. A door opening towards people leaving is considered to be potentially more dangerous because a ‘crush’ may occur, where people pushing against the door prevents it from being opened.

Doors in alpine areas — **G4.3(a)(i) and (ii)**

In alpine conditions, the swing of outward opening doors may be impeded by snow and ice outside. Therefore, the door is allowed to open inwards provided adequate precautions are taken to enable the door to open towards the flow of people.

As external doors in most buildings open outwards, most people will not necessarily be expecting a door to open inwards. Accordingly, a readily-visible and understood sign must alert people to this feature.

Doorways protected by alcoves or similar

Doorways protected from snow build-up by alcoves, etc are effectively exempt from **G4.3**, so long as they are clearly not subject to the build up of snow.

Alcoves — **G4.3(a)(iii)**

Where a doorway serves a corridor or stairway, an alcove or recess must be provided to protect against snow build-up. If a design indicates that such an alcove or recess will prevent snow build up, a builder, etc may be able to adopt the approach referenced above, and avoid the necessity for the door to open inwards. See **Figure G4.3**.

G4.3(a)(iii) does not apply where an external doorway opens directly from a room to the outside of the building.

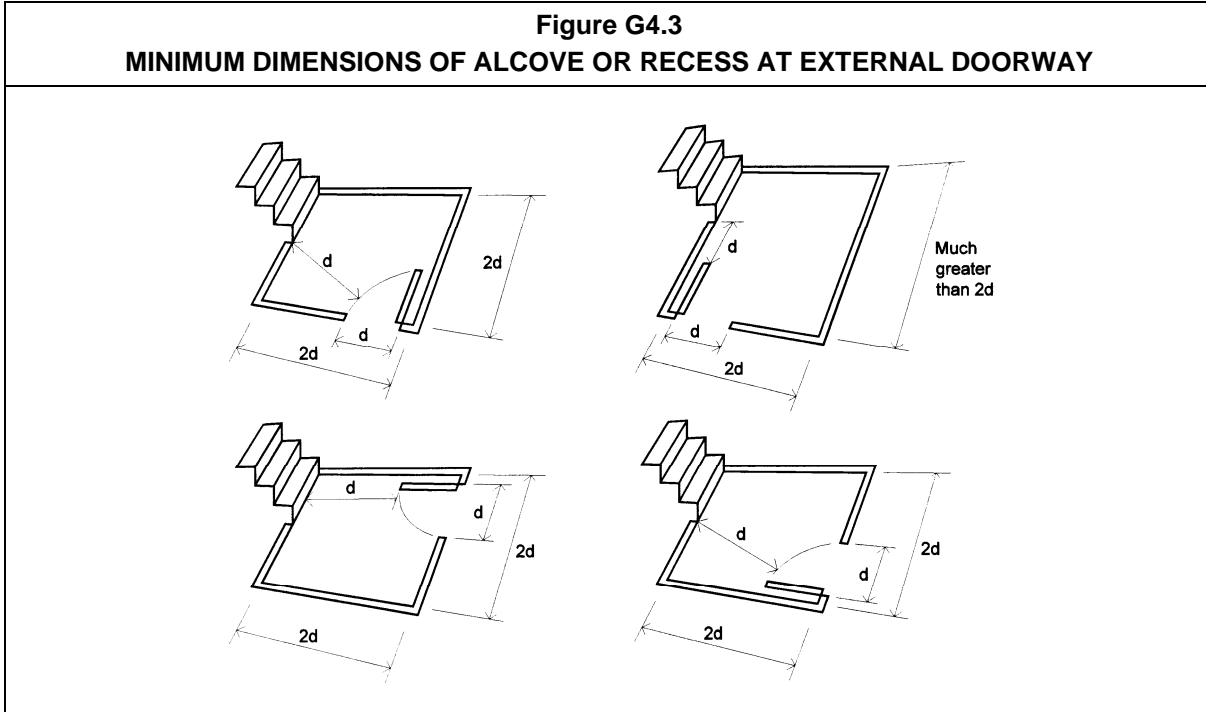

Thresholds to required exit doorways — G4.3(b)

Every threshold to a required exit doorway must be located so that snow, etc will not prevent the door from opening. Accordingly, the threshold may need to be:

- elevated to a point where it is above anticipated snow levels in that area of the building; or
- protected by an awning or similar enclosure which prevents snow from obstructing the doorway.

Attention should be given to the geometry of the building where the threshold is located. The doorway should not be in a place where the roof will deposit large amounts of snow, or at re-entrant corners where snow drifts may form.

This provision only relates to thresholds serving required exits.

G4.4 Emergency lighting

Intent

To enable people to evacuate a building in an alpine area in an emergency without being impeded by lack of light.

Emergency lighting in buildings in alpine areas

G4.4 requires emergency lighting in all Class 2–9 buildings in alpine areas. Expected delays in emergency personnel arriving on the scene, means emergency lighting is necessary to assist people evacuating.

Emergency lighting provides illumination for exit paths, etc during a power failure (which is a likely scenario in a fire). The lighting must be effective and installed to cover exit paths as nominated.

G4.4 and Part E4

The technical aspects of the installation of emergency lighting must be in accordance with Part **E4**. However, the location of emergency lights must comply with **G4.4**, irrespective of any location parameters specified in Part **E4**.

Lighting in stairways — **G4.4(a)**

G4.4(a) requires lighting to be provided to every stairway within a building, except within a sole-occupancy unit of a Class 2 or 3 building and the Class 4 part of a building. This is to make sure that common exit routes are still negotiable in an emergency.

Lighting in exit paths — **G4.4(b)**

G4.4(b) requires lighting in main exit paths. The key description is public corridors, public hallways or the like, inferring that any pathway used as a general or common exit route by occupants must be provided with emergency lighting.

Emergency lighting — **G4.4(c)**

G4.4(c) requires emergency lighting externally above every doorway opening to a road or open space. This enables occupants to negotiate any obstacles when evacuating in darkness.

G4.4(c) applies only to doorways leading directly or via the allotment land to a public road. Doorways opening on to enclosed courtyards or similar enclosed areas are not required to comply.

Emergency lighting and darkness — G4.4(d)

G4.4(d) is a performance criterion, and will require assessment of the building layout to determine the need for emergency lighting in areas other than those specified in **G4.4(a)**, **(b)** and **(c)**. The aim of **G4.4** is to assist people by providing illumination in paths of travel while evacuating the building.

Where the designer or appropriate authority believes there are problems which may be created due to darkness, then emergency lighting must be installed.

Exit signs — Part E4

Note that while it is not referenced in Part **G4**, emergency exit signs need to be installed in accordance with Part **E4**.

G4.5 External ramps**Intent**

To enable people to evacuate a building in an alpine area in an emergency without being impeded by steep ramps.

External ramps must not be too steep

G4.5 aims to ensure that egress is not impeded by steep ramps. The maximum slope of 1:12 is less than the 1:8 allowed in Part **D2** because of the difficulty associated with negotiating ramps in snow and ice conditions. **G4.5(a)** acknowledges that if exit ramps are required for access by people with disabilities they must comply with [AS 1428.1](#).

G4.6 Discharge of exits**Intent**

To enable people to evacuate and emergency services to access a building in an alpine area in an emergency without being impeded by snow build-up around the building.

Snow build-up between and around buildings

The design and construction of a building in an alpine area must not aid dangerous levels of snow build-up between and around buildings. This control:

- assists with egress in an emergency;
- helps vehicle access around the buildings, both for snow clearing and emergency situations; and
- minimises the risk of snow or ice falling from the roof on to adjoining lots or egress routes.

G4.6(a) addresses the set-back distance for external walls from the boundary of adjoining allotments. The aim is to make sure that a reasonable distance is created between buildings to

reduce the amount of snow build-up between properties. **G4.6(a)** applies only to the area adjacent to that part of the wall which is more than 3.6 metres in height.

G4.6(b) describes distances between wings of a building where the exit doorway discharges into this area. The external walls of a building should not create an alcove which traps snow, making evacuation difficult.

G4.6(c) deals with the problem of features adjacent to an exit doorway which could trap snow and complicate egress.

The term ‘barrier’ is used to describe the feature which could entrap snow. Because the aim of **G4.6(c)** is to avoid the problems created by snow drifts, it would be reasonable to interpret ‘barrier’ as including any feature which could hold the snow, including fences, cuttings to roadways, walls of adjacent buildings and the like. See **Figure G4.6**.

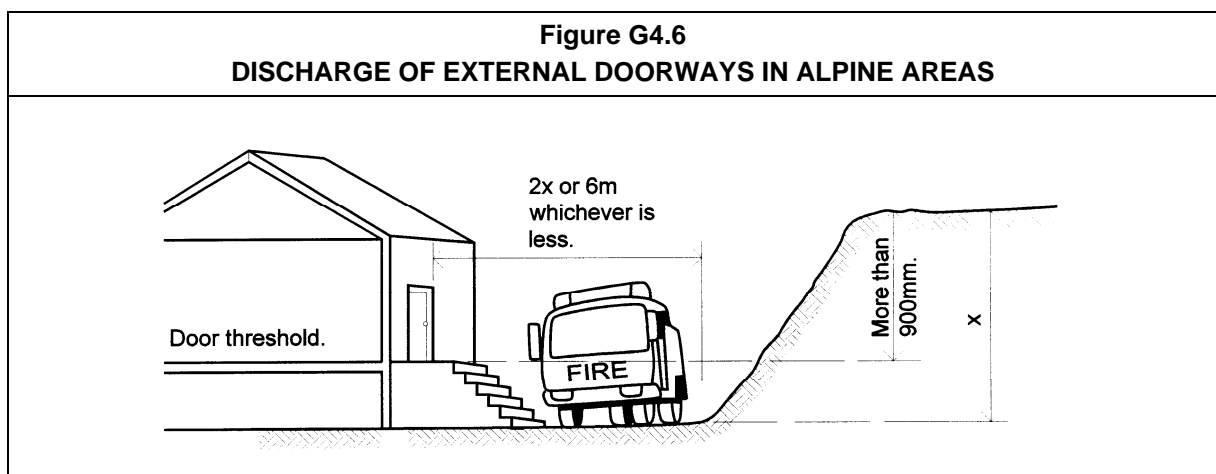

G4.7 External trafficable structures**Intent**

To enable people to evacuate and emergency services to access a building in an alpine area in an emergency without being impeded by inadequate structures comprising part of the exit path of travel to a safe place.

Slipperiness and safe barriers

G4.7 aims to make sure that external structures comprising part of the exit path of travel from a building to a safe place:

- have a floor surface preventing people from slipping; and
- have any required balustrade or barrier (ie: required by Part **D2**) designed so that it is more than 75 per cent open to minimise snow build-up.

This provision only applies to structures, and not to such paths of travel as steps and ramps created by landscaping.

G4.8 Fire-fighting services and equipment**Intent**

To provide for the installation of adequate fire safety equipment suitable to the conditions experienced in alpine areas.

Fire alarm system — G4.8(a)

G4.8(a) requires a manually-operated, fire-alarm system. This system must be supplemented by call-points to notify the local fire authority. The activation mechanism of the manual call-point may also activate the alarm system. This will provide an additional audible warning to the automatic systems required by **E2.2**.

Where an external alarm is installed, sub-zero temperatures must not freeze its mechanism.

Hose reels and hydrants — G4.8(b)

G4.8(b) requires that hose reels and hydrants be installed in all the nominated buildings in accordance with Part **E1**. These systems must be operable in sub-zero conditions, and any water in the mains should not freeze.

Class 4 parts of buildings

G4.8 has not been applied to Class 4 parts of a building. It is extremely unlikely that any of the services and equipment required by **G4.8** will be located within a sole-occupancy unit in any

residential building. In, for example, Class 2 and Class 3 buildings it is most likely that such services and equipment will be located in common areas.

PART G4 – CONSTRUCTION IN ALPINE AREAS

The requirement for the installation of fire-fighting services and equipment in the non-Class 4 parts of the building within which the Class 4 part is located, will provide for the safety of the occupants of the Class 4 part.

G4.9 Fire orders**Intent**

To enable occupants to evacuate a building in an alpine area in an emergency without being impeded by lack of knowledge of the fire safety system, egress routes or evacuation procedures.

Notices

In Class 2, Class 3 and Class 9 buildings, **G4.9** requires that a notice containing fire orders be displayed. They are necessary because there is a high probability that, in alpine areas, the occupants may be residing overnight or for short periods only, and will be unfamiliar with their surroundings.

Fire escape information needs to be displayed prominently near the main entrance and on each storey so that people new to the building can identify escape features, etc. A suitable location would be near the primary stairway. Additional advice on locating these items can be obtained from the appropriate authority or local fire authority.

Information must be conveyed in a clear and simple manner, because of the varying degree of technical understanding of people reading this information.

Class 4 parts of buildings

Class 4 parts of buildings have not been included in the coverage of **G4.9** because buildings will not typically be used for short term rental accommodation in alpine areas. Therefore, residents are likely to be aware of safety requirements.

PART **G5** CONSTRUCTION IN BUSHFIRE PRONE AREAS

Objective

GO5

Australia contains some of the most dangerous bushfire areas in the world and concern over loss of life and property led to the development of Part **G5**.

Within Volume One of the BCA the provisions only apply to Class 2 and Class 3 buildings, as residential buildings are considered to present the greatest risk to life. The provisions also only apply in areas that have been designated as 'bushfire prone areas'.

GO5, specifically **GO5(b)**, is one of the few Objectives of the BCA which requires the protection of a building as well as its occupants.

The provisions of Part **G5** apply in addition to those applicable throughout the rest of the BCA.

Functional Statement

GF5.1

As for the **GO5**, **GF5.1** only applies Part **GF** to Class 2 and Class 3 buildings in designated bushfire prone areas and these provisions are additional to those in the rest of the BCA. However **GF5.1** only requires Class 2 and Class 3 buildings to provide resistance to a bushfire, not total protection.

Performance Requirements

GP5.1

In **G5.1**, Part **G5** applies only to Class 2 and Class 3 buildings in designated bushfire prone areas and its provisions apply in addition to those applicable throughout the rest of the BCA.

The basis of **GP5.1** is that:

- bushfires provide a major risk of ignition while the fire front is passing over a building;
- the building occupier or the fire brigade may be able to provide a reasonable amount of protection from the spread of fire to the building (ie from trees and the like which may still be burning) after a fire front passes.

PART **G5** CONSTRUCTION IN BUSHFIRE PRONE AREAS

Deemed-to-Satisfy Provisions

G5.0 Deemed-to-Satisfy Provisions

Intent

To clarify that complying with **G5.1** and **G5.2** will satisfy the requirements of **GP5.1**.

G5.1 Application of Part

Intent

To clarify that Part **G5** applies only to Class 2 and Class 3 buildings in designated bushfire prone areas.

The provisions of Part **G5** apply in addition to those applicable throughout the rest of the BCA.

G5.2 Protection

Intent

To clarify that compliance with **AS 3959** will achieve compliance with Part **G5**.

G5.2 adopts **AS 3959** — *Construction of buildings in bushfire-prone areas*. Compliance with this Australian Standard will achieve compliance with Part **G5**.

The purpose of **AS 3959** is to improve the fire resistance performance of buildings that may be subjected to burning debris, radiant heat and flame contact during the passing of a fire front. Construction requirements are dependent on the bushfire hazard level of the site. It should be noted that even though a site may be located in a designated bushfire prone area, if the category of bushfire attack for the particular site is low, there are no special construction requirements specified in **AS 3959**.

Maintenance plays an important role in the overall strategy of improving the performance of buildings against bushfires. This includes maintenance (or better still, improvement) of the site conditions and maintenance of the building itself.

SECTION **H**

SPECIAL USE BUILDINGS

H1 **Theatres, Stages and Public Halls**

SECTION H CONTENTS

	Page
Part H1 Theatres, Stages and Public Halls	21,021
H1.1 Application of Part	
H1.2 Separation	
H1.3 Proscenium wall construction	
H1.4 Seating area	
H1.5 Exits from theatre stages	
H1.6 Access to platforms and lofts	
H1.7 Aisle lights in theatres	
Specification	21,151
H1.3 Construction of Theatres with Proscenium Walls	

PART H1 THEATRES, STAGES AND PUBLIC HALLS

Objective**Functional Statements****Performance Requirements**

The Objective, Functional Statements and Performance Requirements for Part **H1** are contained in **Sections C, D** and **E**. Part **H1** contains additional Deemed-to-Satisfy Provisions for buildings which contain theatres, stages and public halls.

PART H1 THEATRES, STAGES AND PUBLIC HALLS

Deemed-to-Satisfy Provisions

H1.1 Application of Part

Intent

To clarify which Class 9b buildings are subject to Part H1, and to what extent they are subject.

Class 9 buildings and high fire loads - H1.1(a)

Stages used for live performances can contain high fire loads due to the props, scenery, lighting, and the like used in such productions. Such props and scenery are often also stored in backstage areas, which adds to the fire load.

General application of Part H1

In general, Part H1 applies to specified enclosed Class 9b buildings which:

- in the case of school assembly, church or community halls, contain both a stage and backstage area which exceeds 300 m²;
- are not covered by H1.1(a)(i), and have a stage or backstage area which exceeds 200 m²; or
- have a stage with a rigging loft.

Part H1 does not simply apply to stage and backstage areas, but also to seating areas and aisle lighting.

H1.4 and all Class 9b buildings - H1.1(b)(i)

H1.4 applies to all Class 9b buildings, whether or not they are enclosed, and regardless of size.

H1.7 and all enclosed Class 9b buildings - H1.1(b)(ii)

H1.7 applies to all Class 9b buildings which are enclosed, regardless of their size.

H1.2 Separation**Intent**

To protect the audience in a theatre or public hall from a fire on the stage.

Fire safety

H1.2 does not apply to all theatres and public halls. See **H1.1** to determine which buildings need to comply with **H1.2**. A stage and backstage area of a theatre or public hall has a high fire load due to the storage of props and scenery/etc.

The audience must be protected from this fire source by either:

- the installation of a sprinkler system; or
- the construction of a proscenium wall between the stage and the audience area.

H1.3 Proscenium wall construction**Intent**

To set out the detailed construction requirements for a proscenium wall.

Proscenium wall - Specification H1.3

The construction details for a proscenium wall are contained in **Specification H1.3**.

H1.4 Seating area**Intent**

To enable the evacuation of an audience from the seating area.

H1.4 applies to all Class 9 buildings

Under **H1.1(b)(i)**, **H1.4** applies to all Class 9b buildings, both enclosed and open. This means that it applies to theatres, open-deck spectator stands, sporting stadiums, and the like, wherever the public is seated to view an event.

Maximum slope of the floor — H1.4(a)

H1.4(a) deals with the height difference between the floors supporting seats in a theatre and the like. The maximum slope of the floor of 1-in-8 is consistent with **D2.10(b)(iii)**.

This slope cannot be used in aisles required to be accessible by people with disabilities. In such a case, the maximum slope of the aisle is 1-in-14, as required by AS 1428.

Height of openings in steps

The maximum gap of 125 mm stipulated in **H1.4(a)(iii)** is consistent with **D2.13(d)**.

Figures H1.4(1) and (2)

Figures H1.4(1) and **(2)** illustrate methods of complying with **H1.4(a)** and **(b)**.

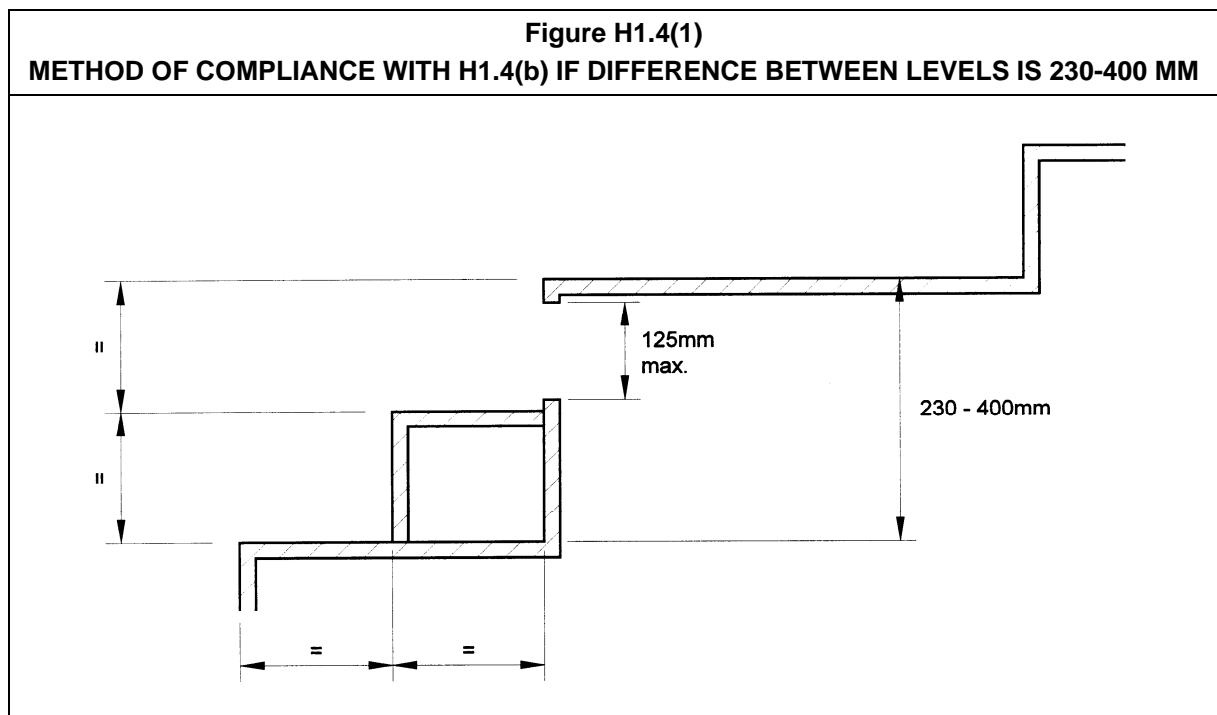
**Width of path of travel to an exit — H1.4(c)**

It is often impractical to require the standard minimum width of a path of travel to an exit of one metre between rows of fixed seating. **H1.4(c)** allows a reduced width in such cases. This width is based on studies of movement between rows.

Distance between the seats should ordinarily be measured:

- with the seat in the up position if folding seats are used; or
- directly between the seats, as shown in **Figure H1.4(3)**.

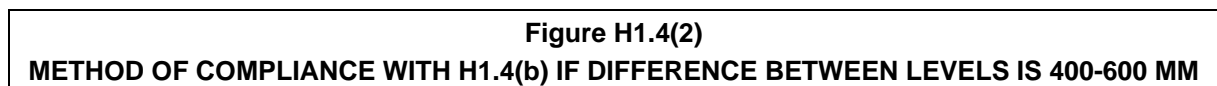

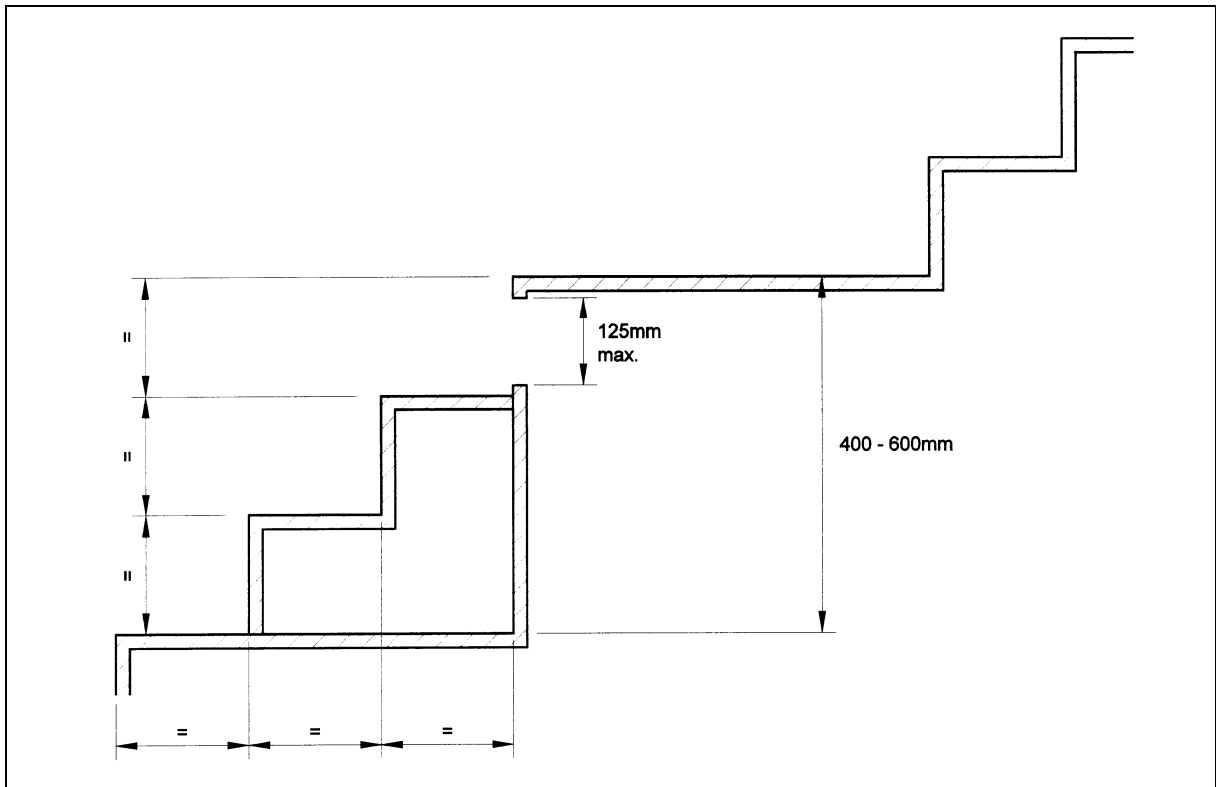

H1.4(c) applies only where the public is seated on fixed seating to view an event.

H1.5 Exits from theatre stages

Intent

To enable safe egress from the stage and backstage areas of a theatre.

Evacuation routes from stage and backstage areas

A stage and backstage area of a theatre or public hall has a high fire load. It is also a potential fire source due to stored props, scenery, lighting, special effects, and the like.

Because of the recognised fire hazard, proscenium walls and curtains are required to separate the stage and backstage areas from the audience.

To maintain this fire separation:

- an evacuation route from the stage side of a proscenium must not pass through the proscenium; and

- required exits from backstage must be independent of the audience evacuation routes.

H1.6 Access to platforms and lofts

Intent

To set out the requirements for stairways to service platforms, rigging lofts, and the like.

Stairways to service platforms and rigging lofts

Stairways to service platforms, rigging lofts, and the like must comply with [AS 1657](#).

H1.7 Aisle lights in theatres

Intent

To make safe evacuation available from theatres.

Aisle lights

H1.7 applies to enclosed Class 9b buildings where:

- lighting is dimmed or extinguished during public occupation; and
- the floor is stepped or inclined at a slope steeper than 1-in-12.

In case of an evacuation, and when the lights are dimmed or extinguished during a performance, **H1.7** requires the installation of aisle lights to avoid people tripping on steps, or falling on a ramp.

Figure H1.4(3)
METHOD OF MEASUREMENT OF CLEARANCE BETWEEN ROWS OF FIXED SEATING

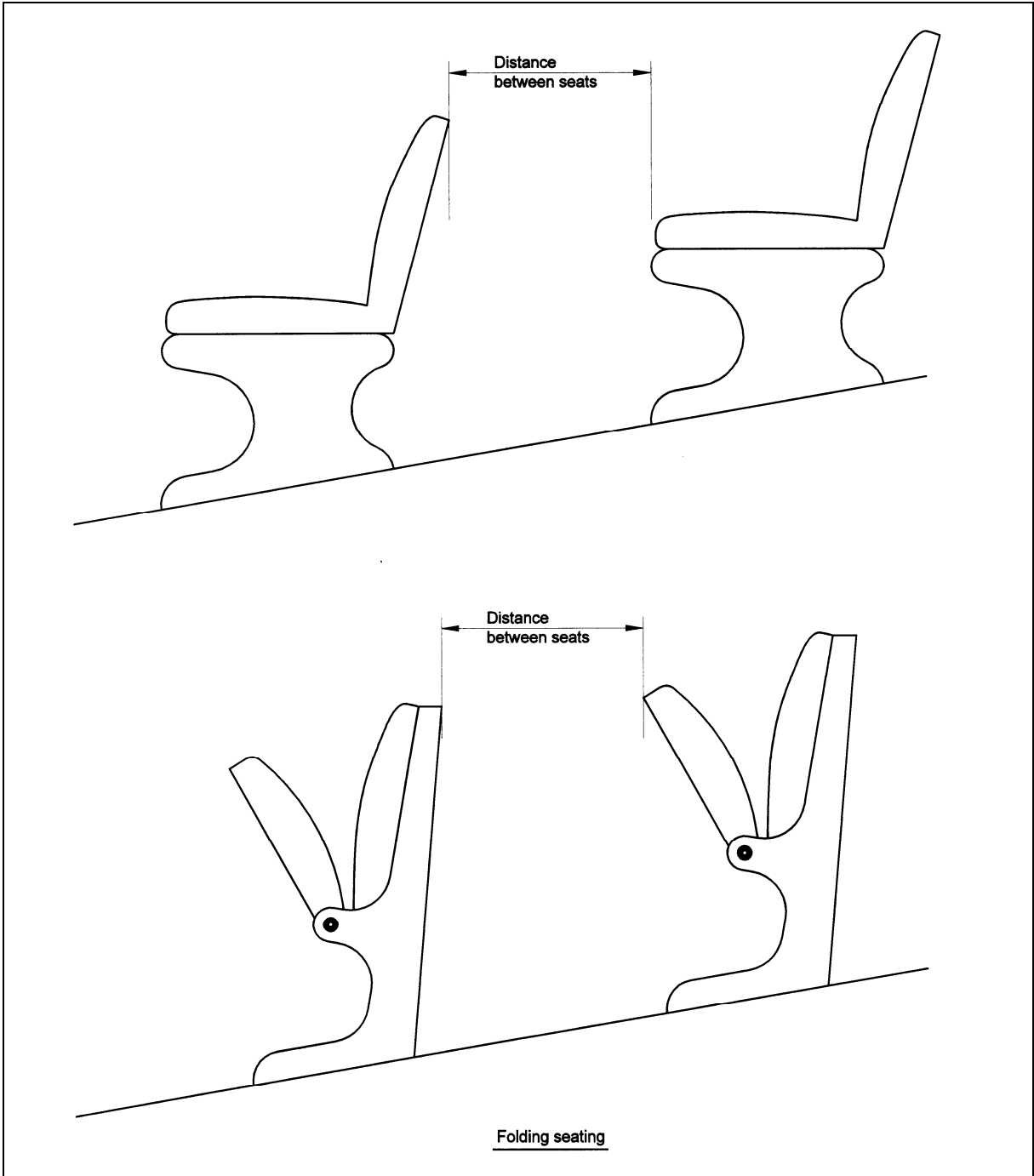

SPECIFICATION H1.3**CONSTRUCTION OF THEATRES
WITH PROSCENIUM WALLS****Deemed-to-Satisfy Provisions****Specification H1.3 — Comments**

This Guide does not address, in detail, every provision in this Specification. However, there are some comments which should be made:

Specification H1.3 - purpose

A stage and backstage area of a theatre or public hall has a high fire load. It is also a potential fire source due to stored props and scenery, etc.

Specification H1.3 deals with how to provide fire separation by a proscenium wall between the stage and backstage areas, and other parts of the building, including those occupied by an audience.

Height and extent of a proscenium wall - fire wall

The height and extent of a proscenium wall are similar to those of a fire wall. Any openings in it must be suitably protected to prevent the spread of a fire to the audience side.

Proscenium curtains

An important part of avoiding the spread of fire from the stage is the protection of the opening to the stage. Protection must be provided while still permitting the audience to view a performance.

Since the opening is too large to protect with an automatically-closing fire door, the aim of providing protection while maintaining functionality is achieved by the use of a proscenium curtain. **Clause 6** of the specification gives two alternative options for such a curtain.

SECTION



MAINTENANCE

I1 Equipment and Safety Installations

SECTION I CONTENTS

	Page
Part I1	23,021
Equipment and safety installations	
Objective IO1	
Functional Statement IF1.1	
Performance Requirement IP1.1	
I1.0	Deemed-to-Satisfy Provisions
I1.1	Safety installations
I1.2	Mechanical ventilation and hot water, warm water and cooling water systems

PART 11 EQUIPMENT AND SAFETY INSTALLATIONS**Objective****IO1 Safety, health and amenity levels**

IO1 reflects the philosophy that throughout the life of a building, safety, health and amenity levels should accord with the Performance Requirements of the BCA.

Part **11** is limited to the maintenance of some fittings and equipment related to physical and health safety matters.

Functional Statement**IF1.1 Life safety matters**

IF1.1 reflects the practical issues involved with applying the Objective **IO1** to buildings, and accordingly limits its application to illness and injury (or life safety) matters.

Performance Requirements**IP1.1 All building items relating to people safety**

All building items relating to people safety must be maintained to enable them to perform as intended.

PART 11 EQUIPMENT AND SAFETY INSTALLATIONS

Deemed-to-Satisfy Provisions

11.0 Deemed-to-Satisfy Provisions

Intent

To clarify that the requirements of **IP1.1** will be achieved by compliance with **I1.1** and **I1.2**.

IP1.1, I1.1 and I1.2

I1.0 clarifies that compliance with **I1.1** and **I1.2** will achieve **IP1.1**.

11.1 Safety installations

Intent

To require the maintenance of safety installations in buildings.

Safety installations in buildings must be maintained

See the Comments on **IP1.1** above.

11.2 Mechanical ventilation and hot water, warm water and cooling water systems

Intent

To set out the maintenance requirements for mechanical ventilation and hot, warm and cooling water systems.

AS/NZS 3666.2

The aim of the reference to [AS/NZS 3666.2](#) is to improve the health and hygiene aspects of air-handling and hot water, warm water and cooling water systems in buildings. [AS/NZS 3666.2](#) covers the most common known sources of the diseases associated with air-handling and water systems in buildings, including Legionnaires' disease, Pontiac fever, and so on.

[AS/NZS 3666.2](#) is not intended to cover 'discomfort' symptoms which may affect building occupants.

This provision applies to all buildings except systems that only serve a single sole-occupancy unit in Class 2 or 3 building or Class 4 part. This limitation is consistent with the intent of [AS/NZS 3666.2](#), the limitation of **FP2.6** and **F2.7**.