



National Construction Code Series

Building Code of Australia 2011

Class 2 to Class 9 Buildings

GUIDE



ABCB

CONTENTS AND FEATURES

General Table of Contents

Introduction

© 2011 Australian Government and States and Territories of Australia

The *NCC 2011 (Volume One, Volume Two & Volume Three)* and the *Guide to the BCA* is the copyright of the Australian Government and States and Territories of Australia and, apart from any use as permitted under the Copyright Act 1998, no part may be reproduced without prior permission. Requests and enquiries concerning reproduction and rights should be directed in the first instance to the General Manager, Australian Building Codes Board, GPO Box 9839 Canberra ACT 2601.

Australian Building Codes Board

GPO Box 9839 Canberra ACT 2601

Telephone: Canberra 1300 134 631 Facsimile: (02) 6213 7287

Web Site: <http://www.abcb.gov.au>

Email: bca@abcb.gov.au

The Australian Building Codes Board (ABCB) is established by agreement between the Commonwealth Government and each State and Territory Government. It is a co-operative arrangement between the signatories, local government and the building industry.

ABCB Important Disclaimer

While the ABCB has made every effort to ensure the material in this document is accurate and up to date, such material does in no way constitute the provision of professional advice.

The ABCB gives no warranty or guarantee and accepts no legal liability whatsoever arising from or connected to, the accuracy, reliability, currency or completeness of any material contained in this document.

Users should seek appropriate independent professional advice prior to relying on, or entering into any commitment based on material in this document in relation to building or related activities. Its interpretation in no way overrides the approvals processes in any jurisdiction.

NCC Customer Support

Telephone (Australia Only): 1300 134 631

International: +61 2 6213 7842

Facsimile: +61 2 6290 8831

Email: ncc@abcb.gov.au

ISBN 1-921453-79-3

GENERAL TABLE OF CONTENTS

INTRODUCTION

Introduction	7
--------------------	---

SECTION A GENERAL PROVISIONS

PART A0 Application	12
PART A1 Interpretation	17
PART A2 Acceptance of Design and Construction	44
PART A3 Classifications of Buildings and Structures	48
PART A4 United Buildings	58

SECTION B STRUCTURE

PART B1 Structural Provisions	68
-------------------------------------	----

SECTION C FIRE RESISTANCE

Section C Fire Resistance	79
Part C1 Fire Resistance and Stability	90
Part C2 Compartmentation and Separation	105
Part C3 Protection of Openings	129

SECTION D ACCESS AND EGRESS

Section D Access and Egress	190
Part D1 Provision for Escape	198
Part D2 Construction of Exits	239
Part D3 Access for People with Disabilities	270

SECTION E SERVICES AND EQUIPMENT

PART E1 Fire Fighting Equipment	286
PART E2 Smoke Hazard Management	309
Part E3 Lift Installations	335

SUPERSEDED
CONTENTS AND FEATURES

Part E4	Emergency Lighting, Exit Signs and Warning Systems	341
SECTION F HEALTH AND AMENITY		
Part F1	Damp and Weatherproofing	357
Part F2	Sanitary and Other Facilities	367
Part F3	Room Heights	377
Part F4	Light and Ventilation	381
Part F5	Sound Transmission and Insulation	394
SECTION G ANCILLARY PROVISIONS		
Part G1	Minor Structures and Components	408
Part G2	Heating Appliances, Fireplaces, Chimneys and Flues	415
Part G3	Atrium Construction	420
Part G4	Construction in Alpine Areas	435
Part G5	Construction in Bushfire Prone Areas	446
SECTION H SPECIAL USE BUILDINGS		
Part H1	Theatres, Stages and Public Halls	450
Part H2	Public Transport Buildings	457
SECTION I MAINTENANCE		
PART I1	Equipment and Safety Installations	466
PART I2	Energy Efficiency Installations	469
SECTION J ENERGY EFFICIENCY		
Section J	Energy Efficiency	474
Part J0	Energy Efficiency	481
Part J1	Building Fabric	485
Part J2	Glazing	492
Part J3	Building Sealing	498
Part J4	* * * * *	501
Part J5	Air Conditioning and Ventilation Systems	502

SUPERSEDED
CONTENTS AND FEATURES

Part J6	Artificial Lighting and Power	507
Part J7	Hot Water Supply and Swimming Pool and Spa Pool Plant	513
Part J8	Access for Maintenance and Facilities for Monitoring	515

INTRODUCTION

THE NATIONAL CONSTRUCTION CODE SERIES

The National Construction Code Series (NCC) is an initiative of the Council of Australian Governments developed to incorporate all on-site construction requirements into a single code. The Building Code of Australia (BCA) is Volume One and Volume Two of the NCC.

The Guide

The Guide is a companion manual to Volume One. It is intended as a reference book for people seeking clarification, illustrations, or examples, of what are sometimes complex BCA provisions.

The two books should be read together. However, the comments in this Guide should not be taken to override the BCA. Unlike the BCA, which is adopted by legislation, this Guide is not called up into legislation. As its title suggests, it is for guidance only. Readers should note that States and Territories may have variations to BCA provisions. This Guide does not cover those variations. For advice on these matters contact your State or Territory building control administration.

This Guide covers only Volume One of the BCA and primarily deals with Class 2 to Class 9 buildings. Volume Two of the BCA contains guidance notes throughout and diagrams and hence is not included in the Guide.

To assist readers, most of the information in this Guide — including section headings, abbreviations and symbols — is formatted as closely as possible to that in BCA.

Example

Imagine a developer or engineer etc — referred to in the Guide as the building proponent — with a query about the standards needed for the installation of electricity-supply systems. The first step is to record the details of the relevant BCA provision on electricity-supply systems and turn to the corresponding section in the Guide. To illustrate this: in the BCA, comments on electricity-supply systems are partly dealt with under **Section C** — Fire Resistance (**C2.13**). In the Guide, readers should turn to **Section C** for information. The Guide does not note all related provision numbers but only provides explanation to the provisions that may need elaboration.

Readers will also note that the BCA Deemed-to-Satisfy Provisions list only the minimum requirements that are acceptable as meeting the Performance Requirements.

The Guide generally explains the intent behind the provisions, and why building proponents, need to meet such standards. For example, the Guide clarifies why certain fire-resistance levels (FRLs) are required. It also assists readers by referring them to other related topics or sections in the Guide.

Not all the provisions in the BCA are covered in the Guide. Those not dealt with have been found to be self-explanatory. The Guide contains a number of examples — some written, others in diagram form — which help illustrate provisions. These examples are not absolute, as they cannot take into account every possible permutation of a building proposal. Again, they are intended as a guide only. Other provisions of the BCA must be complied with.

The information in this Guide is provided by the Australian Building Codes Board (ABCB) and is intended as an information service primarily for building professionals.

SUPERSEDED CONTENTS AND FEATURES

Because the Guide does not have regulatory force, the ABCB does not accept any responsibility for its contents when applied to specific buildings or any liability which may result from its use.

Feedback

The Guide, as with the BCA, is under continual review and is amended as necessary. Readers are invited to provide feedback to the ABCB Office on difficulties in understanding the Guide or where more information should be provided. The address is:

The General Manager

Australian Building Codes Board

GPO Box 9839

Canberra ACT 2601

GENERAL PROVISIONS

- A0** **Application**
- A1** **Interpretation**
- A2** **Acceptance of Design and Construction**
- A3** **Classification of Buildings and Structures**
- A4** **United Buildings**

SECTION A CONTENTS

SECTION A GENERAL PROVISIONS

PART A0 Application

- A0.1 Adoption
- A0.2 BCA Volumes
- A0.3 BCA Structure
- A0.4 Compliance with the BCA
- A0.5 Meeting the Performance Requirements
- A0.6 Objectives and Functional Statements
- A0.7 Deemed-to-Satisfy Provisions
- A0.8 Alternative Solutions
- A0.9 Assessment Methods
- A0.10 Relevant Performance Requirements

PART A1 Interpretation

- A1.1 Definitions
- A1.2 Adoption of Standards and other references
- A1.3 Referenced Standards, etc
- A1.4 Differences between referenced documents and the BCA
- A1.5 Compliance with all Sections of BCA
- A1.6 Application of the BCA to a particular State or Territory
- A1.7 Language

PART A2 Acceptance of Design and Construction

- A2.1 Suitability of materials
- A2.2 Evidence of suitability
- A2.3 Fire-resistance of building elements
- A2.4 Fire hazard properties
- A2.5 Resistance to the incipient spread of fire

PART A3 Classifications of Buildings and Structures

- A3.1 Principles of classification
- A3.2 Classifications
- A3.3 Multiple classification
- A3.4 Parts with more than one classification

PART A4 United Buildings

- A4.1 When buildings are united
- A4.2 Alterations in a united building

Specifications

SUPERSEDED
GENERAL PROVISIONS

Specification A1.3 Documents Adopted by Reference
Specification A2.3 Fire-Resistance of Building Elements
Specification A2.4 Fire Hazard Properties

PART A0 APPLICATION

A0.1 Adoption

Intent

To specify, as far as possible, the adoption date of Volume One of the BCA.

There are two ways States and Territories adopt the BCA. The majority of the State and Territory administrations adopt the BCA as it is amended from time-to-time and published by the ABCB. This includes the yearly editions, eg BCA 2004. The remaining Administrations need to amend their legislation each time an amendment is made to the BCA or a yearly edition is printed.

Most jurisdictions adopt the latest version of the BCA on a nationally agreed date. However, legislative timetables in some jurisdictions means a later adoption date is necessary. Refer to the History of BCA Adoption in the BCA for the relevant adoption dates. Any queries on this matter should be referred to the relevant State/Territory body responsible for building regulatory legislation.

A0.2 BCA Volumes

Intent

To clarify the coverage of each Volume of the BCA.

BCA matters regarding Class 2–9 buildings are in Volume One of the BCA. Matters regarding Class 1 and generally Class 10 buildings are in Volume Two.

However, readers will occasionally come across subjects mentioned in both Volumes.

For instance, the BCA has no requirements regarding access or facilities for people with a disability in Class 1a buildings. However, it requires access and facilities for people with a disability in certain Class 1b and Class 10a buildings, eg public toilets in parks, and Class 10b swimming pools. These are included in Volume One.

Ordinarily, Class 10b swimming pools and their fencing are mainly attached to Class 1 buildings. However, they can be appurtenant to other buildings. Accordingly, the provisions regarding their construction are included in both Volumes One and Two (See Part G1 of Volume One). Apart from access for people with a disability and swimming pools requirements, all other requirements for Class 10 buildings are found in Volume Two.

A0.3 BCA Structure

Intent

To clarify the structure of the BCA.

References to parts of the BCA hierarchy are often referred to in the BCA and the Guide. To make things easier, and to cut down on repetition, the hierarchy is explained here in some detail.

There are four main parts to this hierarchy. They are BCA:

- Objectives;
- Functional Statements;
- Performance Requirements; and
- Building Solutions comprising;
 - Deemed-to-Satisfy Provisions; and
 - Alternative Solutions.

A0.4 Compliance with the BCA

Intent

To state how a Building Solution will comply with the BCA.

A Building Solution must achieve the Performance Requirements if it is to comply with the BCA.

A Building Solution may be partly a Deemed-to-Satisfy Provision and partly an Alternative Solution. However, no matter what method is chosen, building proponents need to always meet the Performance Requirements of the BCA.

A0.5 Meeting the Performance Requirements

Intent

To state how a Building Solution will achieve compliance with the Performance Requirements.

Performance Requirements outline the levels of accomplishment different buildings must attain. These requirements have been developed to meet both the BCA Objectives and Functional Statements. The Performance Requirements are the only BCA hierarchy levels where compliance is compulsory under building control legislation.

The means by which a building proponent complies with the BCA Performance Requirements is known as a Building Solution.

There are two main parts of a Building Solution: Deemed-to-Satisfy Provisions and Alternative Solutions.

A0.6 Objectives and Functional Statements

Intent

To state that the Objectives and Functional Statements are informative.

These levels of the hierarchy are informative only, and are included in the BCA to provide an aid to interpreting the content and intent of the Performance Requirements and the Deemed-to-Satisfy Provisions.

Objectives set out what the community expects of a building.

Functional Statements describe how it is proposed that the building will be designed and constructed to meet those community expectations.

A0.7 Deemed-to-Satisfy Provisions

Intent

To state that compliance with the Deemed-to-Satisfy Provisions is deemed to achieve compliance with the Performance Requirements.

Deemed-to-Satisfy Provisions make up the bulk of the BCA. If any designer, builder or the like, does not want to develop a new means of achieving Performance Requirements, they can choose to adopt one of the solutions known as Deemed-to-Satisfy Provisions.

A0.8 Alternative Solutions

Intent

To state the process for proving that an Alternative Solution complies with the BCA.

A building proponent may decide to meet the Performance Requirements via a route which is not included in a Deemed-to-Satisfy Provision. This is referred to as an Alternative Solution.

Options are available for people wishing to use Alternative Solutions to meet a Performance Requirement.

For example: building proponents who wish to know what has to be done to satisfy the fire-safety Performance Requirements of a particular building can either follow the Deemed-to-Satisfy Provisions or adhere to one of the proven Alternative Solutions. For Alternative Solutions they might, for example, refer to:

- the International Fire Engineering Guidelines (Edition 2005) published by the Australian Building Codes Board; or
- the Fire Brigade Intervention Model (FBIM) as developed by the Australasian Fire Authorities Council (AFAC) to assist with determining fire brigade response times.

Such alternative guidelines may be endorsed by the Board as appropriate and safe yardsticks.

They are examples of Alternative Solutions at work and demonstrate the flexibility of the BCA.

When using an Alternative Solution, it is important to ensure that it complies with all parts of the BCA as required by [A0.10](#).

A0.9 Assessment Methods

Intent

To state the Assessment Methods to be used to prove whether or not a Building Solution achieves the Performance Requirements.

Assessment Methods are the means by which a building proponent proves that an application for a building permit meets all requirements.

BCA Assessment Methods include:

- a method which accords with the requirements of [A2.2](#);
- a Verification Method listed in the BCA (refer to [CV1](#) and [CV2](#) in the BCA); or
- a Verification Method which is not listed in the BCA.

The third form of a Verification Method might include:

- calculations, using analytical methods or mathematical models;
- tests, using a technical procedure, either on site or in a laboratory, to directly measure the extent Performance Requirements are achieved; or
- any other method, including an inspection (and inspection report).

All Verification Methods must be acceptable to the appropriate authority.

Sometimes, **appropriate authorities**—such as the local council etc—also use Assessment Methods to determine whether an application has met all requirements. For instance, when processing a building permit, authorities might check to see that a qualified expert has offered an opinion, and, most importantly, found the application to comply with the BCA. This is just one of many options available to such authorities.

If a conflict arises between an applicant and an authority over an application, then the relevant State or Territory body should be contacted.

You will notice that the BCA refers to **Applications and Limitations**. These terms are merely used to show when an Objective, Functional Statement and Performance Requirement applies or does not apply.

The term “**to the degree necessary**” also appears frequently. This phrase is used to show that provisions can differ according to various elements which appropriate authorities may take into consideration when assessing building applications.

For instance, it could be argued that if the fire compartment of a building is quite small then perhaps it is not necessary to install a fire-hose reel system. This is borne out by the Deemed-to-Satisfy Provision of [E1.4](#) which states that such a system is only compulsory in a building having a floor area greater than 500 m².

So, there are different ways of satisfying BCA requirements. Sometimes, however, the route to understanding compliance can be daunting and a little confusing. This Guide is intended to provide you with a better understanding of the BCA.

A0.10 Relevant Performance Requirements

Intent

To set out the method of determining the appropriate Performance Requirements to be used when an Alternative Solution is used to prove that a Building Solution complies with the BCA.

No BCA provision can be considered in isolation. Any departure from the Deemed-to-Satisfy Provisions for an Alternative Solution needs to be assessed against the relevant Performance Requirements within the relevant BCA Section or Part. Additionally, the proposed Alternative Solution may also impact on other Performance Requirements in other BCA Sections or Parts. Thus, these additional Performance Requirements need to be considered in relation to the subject Alternative Solution. A0.10 set out the method of determining which Performance Requirements are relevant.

It is important that an holistic approach is used when determining the appropriate Performance Requirements.

Example

Consider the case of a simple stand alone Class 7a carpark building containing more than 40 vehicles where it is proposed to not install a sprinkler system in the building as required by Deemed-to-Satisfy Provision [E1.5](#), as part of an Alternative Solution.

In accordance with **A0.10(a)**, it is necessary to identify all the relevant Deemed-to-Satisfy Provisions of each Section or Part that is to be subject to the Alternative Solution. In this case there is only one Deemed-to-Satisfy Provision, **E1.5**.

Next, in accordance with **A0.10(b)**, it is necessary to identify the Performance Requirements from the same Section or Part that is relevant to the identified Deemed-to-Satisfy Provisions. In this case, it would be necessary to identify which Performance Requirements in **Part E1** would be relevant. Since a sprinkler system is by definition one type of fire safety system, particular attention needs to be paid to the Performance Requirements that make any reference to such systems. It is worth noting that, depending on the particular design, although a Performance Requirement may be identified by this procedure, the consequences may be minimal or have no effect.

Finally, in accordance with **A0.10(c)**, it is necessary to undertake the same procedure for all the other Sections and Parts of the BCA. In other words identify Performance Requirements from other Sections or Parts that are relevant to any aspects of the Alternative Solution proposed or that are affected by the application of the Deemed-to-Satisfy Provisions subject to the Alternative Solution.

In this case, it is likely that Performance Requirements in other parts of **Sections E** and **Sections C** and **D** may need to be considered.

PART A1 INTERPRETATION

A1.1 Definitions

Intent

To define the precise meaning of key words and expressions for the purposes of Volume One of the BCA.

Where a definition in the BCA has been considered to be self-explanatory, it has not been included in this guide.

Accessible

Used in provisions regarding access for people with a disability. See Part [D3](#), [E3.6](#), [F2.4](#) and [H2](#).

Accessway

A path of travel suitable for use by people with a disability. It is an abbreviation from AS 1428.1 which defines the term continuous accessible path of travel (accessway) as an uninterrupted path of travel providing access to all accessible facilities.

Aged care building

The definition describes a residential building for the accommodation of the aged. These buildings are the homes of the residents. To be an aged care building the residents must be provided with personal care services and 24 hour assistance to evacuate. The definition applies to Class 9c aged care buildings. If a building does not satisfy the definition, then for BCA purposes it is not an aged care building and cannot be constructed as one. Such a building would potentially be an ordinary Class 3 or 9a building and would need to comply with the relevant provisions.

The BCA contains a number of specific provisions for Class 9c aged care buildings.

Air-conditioning

This definition, as with any BCA definition, relates to the context in which it is used and does not necessarily cover special cases such as when air is only humidified or dehumidified, filtered or otherwise treated. It covers a system that provides a controlled environment inside the building. However, it does not cover a system that directly serves equipment such as that used for cold rooms or hot rooms where the temperature is above or below normal comfort levels. Examples would include such rooms in a butcher's shop, laboratories, fruit storage rooms, or the like.

The term is used in the Deemed-to-Satisfy Provisions to require energy efficiency features including envelope treatment. There may be situations, such as a computer centre located in a cold climate where envelope treatment may not save energy. Such cases could benefit from an Alternative Solution.

Although the definition is termed air-conditioning, the conditioning may be achieved without treating the air forced into and through the space. The air in the space may be conditioned by hot or cool surfaces. This includes residential heating systems, such as gas and combustion appliances, that are not always considered to be air-conditioning in the traditional sense. The conditioning may also be achieved by evaporative coolers.

Alpine area

Areas generally subject to snow, or places where snow can add a significant load to buildings, or cause difficulties with egress. See [Figure G4.1](#).

Alternative Solution

See Part [A0](#).

Annual energy consumption

This is the amount of energy calculated to be consumed under certain specific conditions in consideration of operating profiles, internal loads and plant efficiencies. It is used in [Verification Method JV3](#) that compares the calculated energy consumption with that of a complying reference building. It should not be considered a prediction of the actual energy consumption of an actual building as there could be major differences in the conditions such as the internal loads of the building and the hours of operation. It differs from annual energy load because it is affected by the type of heating or cooling appliance used, for example, heating by a reverse cycle air-conditioner uses less than half the energy that a gas fired heater would use to meet the same annual energy load.

Assembly building

Describes buildings classifiable as Class 9b buildings.

Assessment Method

See Part [A0](#).

Atrium and atrium well

An atrium can pose unique fire and smoke hazards. As such, the BCA lists Deemed-to-Satisfy Provisions for their construction.

An atrium is created by the connection of 2 or more storeys by an opening in the floor. It also includes the space not fire-separated from the rest of the building. The atrium well is that part extending through the openings in the floors. See [Figure A1.1\(AT\)](#).

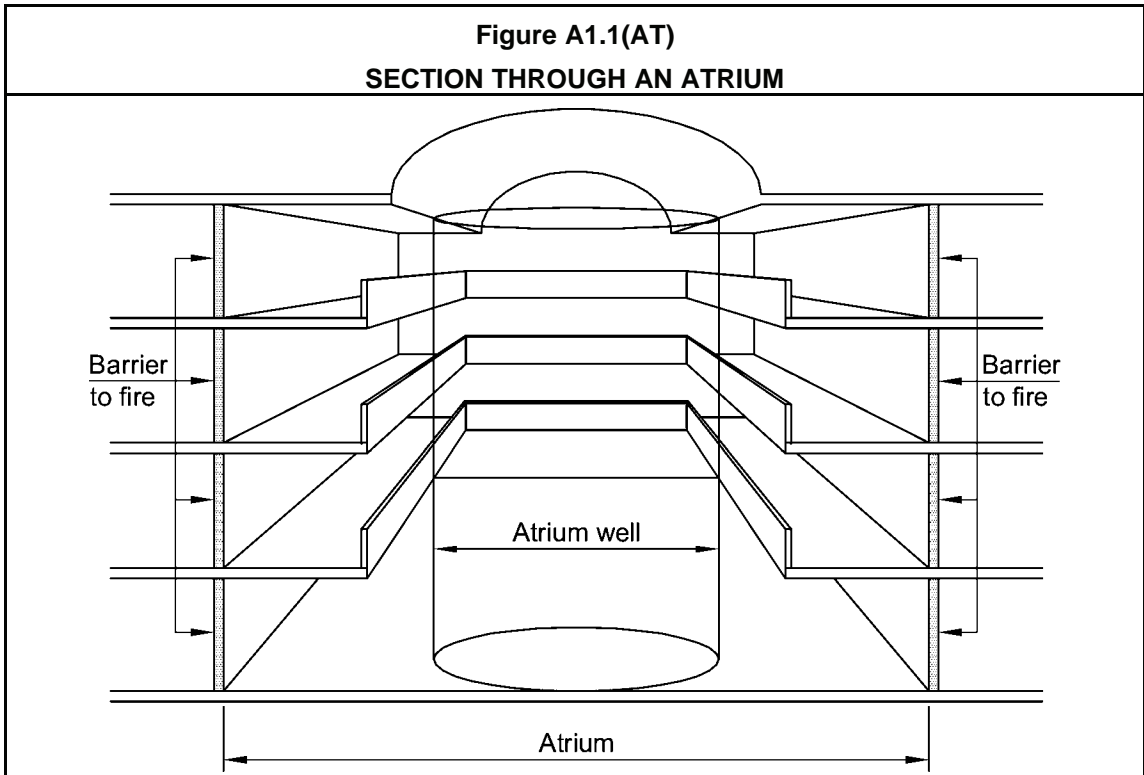

Average recurrence interval

Refers to a set number of years when a rainstorm of a particular intensity can statistically be expected to occur. If a 10-year period is set, the expected rainstorm would be less intense than if a 50-year period is set. Statistically, a heavier storm is more likely to occur every 50 years than every 10 years.

This term is used in the design of stormwater drainage systems. See [FP1.1](#) and [FP1.2](#). Also refer to AS/NZS 3500, or *Australian Rainfall and Run-off*, published by the Institution of Engineers (Australia).

Average specific extinction area

A test in accordance with AS/NZS 3837 determines the average specific extinction area of a material. A lower value indicates better performance.

Backstage

There are special provisions for backstage areas because of the high fire load posed by scenery and props.

Building Solution

See Part [A0](#).

Carpark

A carpark can be a whole, or part, of a building. It is any building not associated with a Class 1 building and accommodates more than three vehicles on one storey. It is not a “private garage”.

Example

A building could be a carpark if:

- it is either a stand-alone Class 7a building, or it is appurtenant to any other building (excluding a Class 1 building); or
- it is intended to park four-or-more trucks or other vehicles and it is not used for ancillary purposes other than a carpark.

Certificate of Accreditation

A Certificate of Accreditation is issued by a State or Territory accreditation authority and is evidence that a building material, method of construction or design (subject to any specified conditions or limitations) is accepted within that State or Territory as complying with the BCA. Certificates of Accreditation are no longer issued by the ABCB. Certificates issued by the ABCB under the previous scheme are no longer valid.

Certificate of Conformity

A Certificate of Conformity issued under the ABCB scheme is evidence that a building material, method of construction or design (subject to any specified conditions or limitations) is accepted within all States and Territories as complying with the BCA.

Climate zone

Energy efficiency measures vary from location to location depending upon the local climate. For simplicity, locations with approximately similar climates have been combined into eight climate zones and they are shown in both map format and tabular format for major cities. Where greater clarity is needed, an enlargeable version of the map on the ABCB web page shows how the climate zone boundary aligns, in most cases, with a local government boundary.

These climate zones were based on a list of six zones that were developed by the Bureau of Meteorology (BOM), with the addition of a third temperate zone and the inclusion of the existing BCA Alpine areas. The basis of each climate zone is shown in the following table:

Climate zones	Description	Average 3 pm January water vapour pressure	Average January maximum temperature	Average July mean temperature	Average annual heating degree days
1	High humidity summer, warm winter	≥ 2.1kPa	≥ 30°C	-	-
2	Warm humid summer, mild winter	≥ 2.1kPa	≥ 30°C	-	-
3	Hot dry summer, warm winter	< 2.1kPa	< 30°C	≥ 14 °C	-
4	Hot dry summer, cool winter	< 2.1kPa	≥ 30°C	< 14 °C	-
5	Warm temperate	< 2.1kPa	< 30°C	-	≤ 1,000
6	Mild temperate	< 2.1kPa	< 30°C	-	1,000 to 1,999
7	Cool temperate	< 2.1kPa	< 30°C	-	≥ 2,000 other than Alpine areas
8	BCA Alpine areas, determined as per BCA Volume One definitions				

Where appropriate, the map was then adjusted for ease of administration, by aligning the climate zone boundaries with local government areas where local knowledge identified the impact of topographical features such as an escarpment or significant micro-climate variation, and where the type of construction required in another zone was felt to be more appropriate for a particular location. There were some further minor adjustments made to the zones following thermal modelling tests of a typical building around the country.

The zones are considered sufficiently accurate for Deemed-to-Satisfy Provisions. More extensive climate data is available when using energy analysis software.

Combustible

A test done in accordance with AS 1530.1 will determine if a material is combustible. If materials used in an assembly contain combustible components, then the assembly is combustible. See also [C1.12](#).

Common wall

A common wall can be on one allotment or straddle a boundary. However, it must be common to adjoining buildings. Some jurisdictions consider a “party wall” a common wall. See your building regulatory body. Where the expressions “internal wall” and “external wall” are used, they are specifically defined to exclude a “common wall”.

Conditioned space

The definition of a conditioned space is included to limit the application of the provisions where a commercial or industrial building has only a small amount of air-conditioning or where a non-habitable room has only a small local heater, such as in a bathroom.

It also clarifies that a conditioned space is one likely to be air-conditioned rather than one that is air-conditioned. For example, one would expect offices and shops to be fully air-conditioned at some time during their life for reasons of productivity, customer comfort or for the protection of products, even though they may not be air-conditioned initially. In some cases, chilled and hot water may be reticulated through duct risers as part of the building design to enable conditioning to be provided as part of a later fit-out.

A conditioned space may include a ceiling or under-floor space that is open to the conditioned space such as a space separated by only a perforated or grille ceiling or floor where the space is a supply air or return air plenum.

While, for the sake of the Deemed-to-Satisfy Provisions, it may be assumed that all Class 3 and Class 5 buildings and most Class 6 buildings will be fully air-conditioned at some time during their life, this may not be the case with all Class 6 buildings and some Class 7, 8 and 9b buildings that do not have a conditioned space or are only partially conditioned. Buildings that typically are not conditioned could be a carpark, market, large purpose-built hardware store, garden centre or foundry. Those buildings, or parts of buildings, that may be partially conditioned could include a check-out counter in a purpose-built hardware store and workstations in a factory or aircraft hanger or even a church.

A capacity of 15 W/m² (4.3 MJ/hour) for either heating or cooling has been set as the minimum threshold for the definition of air-conditioning. The criterion of 15 W/m² is between 10% and 20% of the capacity of a typical heating or cooling system providing comfort temperatures to the full area of a building. Typically, the cooling needed for a building in climate zone 7 would be of the order of 100 W/m² to 120 W/m² and in climate zone 5, the heating would be of the order of 50 W/m². With a heat pump air-conditioner, the input power rates for climate zone 7 for cooling would be 30 W/m² and for climate zone 5 for heating, 20 W/m². Warmer climate zones have higher cooling needs and colder climate zones have higher heating needs. Typically, evaporative coolers would be under the 15 W/m² threshold.

Note that the definition of a conditioned space refers to the temperature in the space being controlled by air-conditioning. The definition of air-conditioning excludes services that cool or heat cold rooms and hot rooms. Therefore the BCA energy efficiency provisions do not apply to these process related rooms.

A room that is not conditioned in its own right, such as one providing a return air path or exhaust air path for conditioned air from an adjoining space, should be considered as a conditioned space. This means that the walls, floor and ceiling between it and an adjoining conditioned room are not part of the envelope and so do not require insulating. Likewise, in certain circumstances some internal spaces could be indirectly conditioned by air pressurisation occurring in adjoining areas. Expert advice may be needed to determine which spaces are indirectly conditioned.

Construction activity actions

This definition is used in [Part B](#) and only refers to construction activities that may have an effect on the final building design such as stacking of materials or floor to floor propping.

Critical radiant flux

A test in accordance with AS ISO 9239.1 determines the critical radiant flux of a material. A higher value indicates better performance.

Curtain wall

A curtain wall is a facade fixed to the exterior of the building and may not be supported within frames at each storey. See [Panel Wall](#).

Deemed-to-Satisfy Provisions

See [Part A0](#).

Designated bushfire prone area

Bushfire prone areas may be designated by a power under legislation. See your building regulatory body.

Early childhood centre

Are also known as creches and child care centres.

Effective height

Measures the height of a building for safety purposes. Effective height is measured from the floor of the lowest storey providing direct egress to a road or open space (this will usually be the level at which the fire brigade would enter)—to the floor of the top storey. Plant rooms and spaces at the top of the building used for maintenance purposes are not included in effective height. See [Figure A1.1\(EH\)](#).

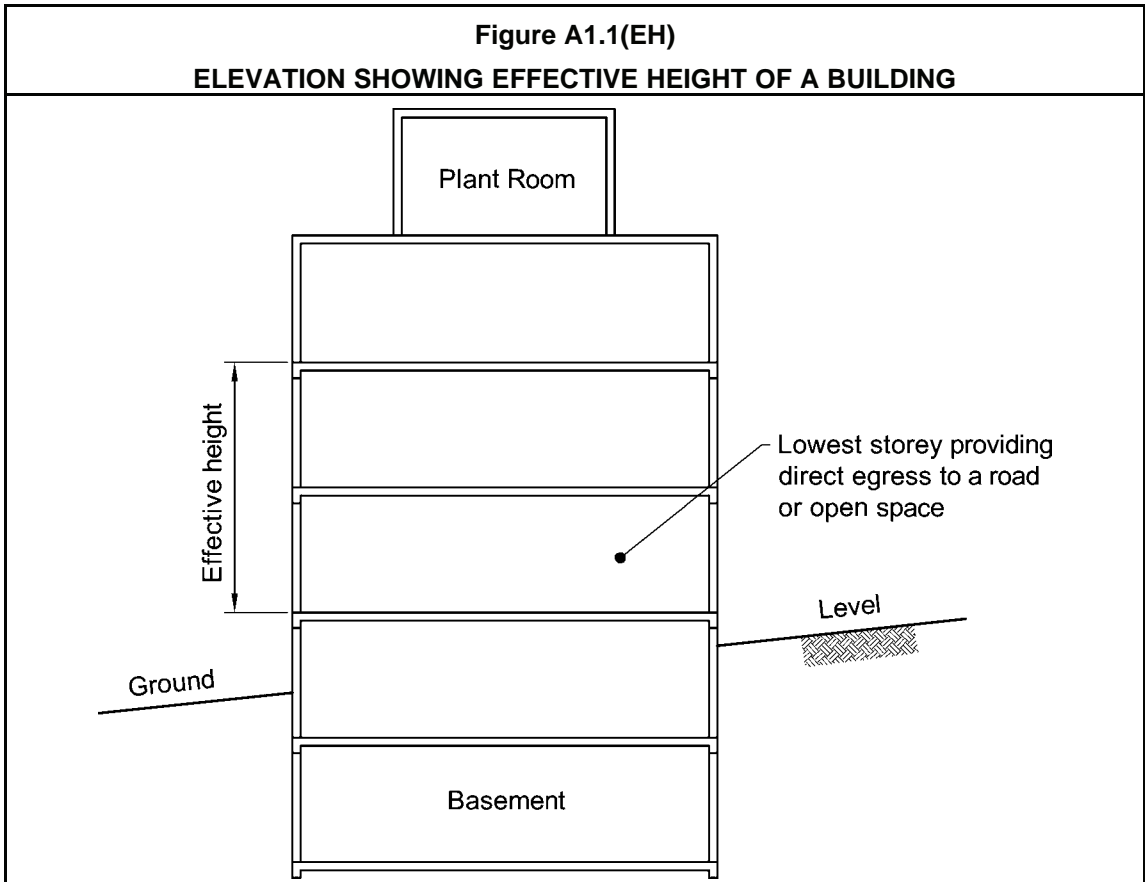

Envelope

In the BCA, this term is not limited to the building's outer shell, but also includes those continuous elements that separate a conditioned space from a non-conditioned space. For example, the floor between a plant room and an office space or the wall between a carpark and a shopping centre may be part of the envelope, rather than the outer shell. A non-conditioned space may be included within the envelope under certain circumstances.

Equivalent

An Alternative Solution may achieve compliance with the Performance Requirements by achieving *equivalence* with the Deemed-to-Satisfy Provisions.

Evacuation route

The path a person uses to evacuate a building. It starts at the most remote part of a building and finishes at a "safe place". This can be in the building, or a road or open space. It is not always the point of exit from a building.

An evacuation route includes the evacuation path within a sole-occupancy unit of a Class 2 or Class 3 building or Class 4 part of a building, as well as an exit from such a unit. This term is different from a path of travel to an exit, which begins at the door to such sole-occupancy units.

Evacuation time

Is the calculated time from when an emergency begins until the last occupant reaches a “safe place”.

It includes the time taken for any alarm to detect a fire and give warning. Added to this is the time taken for occupants to start to evacuate the building.

This “time” will depend on a number of factors, some of which may be influenced by an “emergency management system”, including:

- the type of alarm or warning given;
- whether the occupant initially recognises the alarm or warning;
- whether the occupant decides to investigate or ignore the alarm;
- whether the occupant decides to warn other people in the building;
- the time taken for all occupants to move through the building until reaching a “safe place”.

Exit

An exit can be any of the building elements listed. It must lead to a road or open space or a horizontal exit leading to another fire compartment.

An exit starts at the beginning of the first relevant building element listed in the definition.

Examples

The start of an exit includes:

- the top of the first riser in a required open stairway;
- the doorway leading into a required fire-isolated stairway, fire-isolated ramp or fire-isolated passageway; and
- a required doorway which leads directly to a road or open space.

The exit finishes when a person reaches, as the specific circumstances require:

- a road or open space;
- in the case of a horizontal exit, another fire compartment, which in turn leads to a road or open space; or
- in the case of a non-fire-isolated stairway or ramp, the level providing direct egress to a road or open space.

Expert Judgement

Expert judgement may be used to assess a Building Solution against the relevant Performance Requirements, or against the Deemed-to-Satisfy Provisions if use is being made of an equivalence Assessment Method.

External wall

An external wall is on the outside of a building and usually requires weatherproofing ([Part F1](#)).

It is possible for a wall to be partially an external wall and partially an internal wall. (See [Figure A1.1\(EW\)](#)). Where the expressions “internal wall” and “external wall” are used, they exclude a “common wall”.

Figure A1.1(EW)
EXTERNAL WALLS

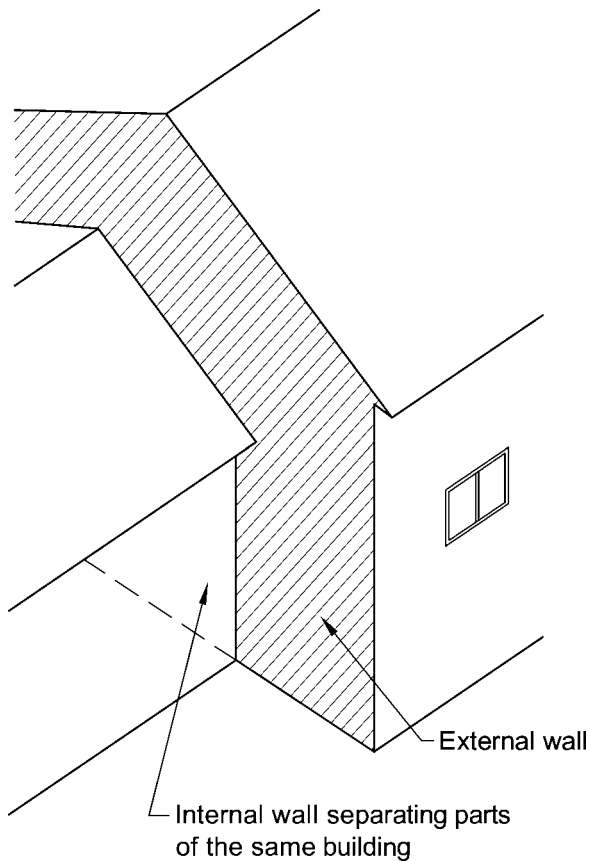

Fabric

This includes all of the non-service elements of a building such as the roof, walls, glazing and floor, that impact upon the building's thermal performance. The fabric may impact upon a building's thermal performance through its insulating ability, or through its thermal inertia or thermal capacitance, which is the ability to slow energy flow and so delay or reduce the transfer of heat.

Fan power

The fan power is the amount of power that a fan needs and includes the inefficiency of the fan and the power consumed by any drive train. This means that it is the power a fan motor needs to provide either directly or by any output shaft.

Fire brigade

This term only refers to statutory authorities established under an Act of Parliament having as one of its functions the protection of life and property from fire and other emergencies. It may be a professional brigade with full-time fire-fighters, or a volunteer brigade. Many companies employ their own private fire services. The standard of these private fire services varies greatly. They are excluded from the definition of a fire brigade.

Fire compartment

A fire compartment contains walls, floors and the like creating a compartment (or “box”) of any shape used to limit the spread of fire to another compartment or part of a building.

Example

If any floor has an opening for an open stairway or escalator, a fire could spread through the opening—that floor would not form the boundary of a fire compartment.

If there are no distinct fire barriers erected, then the whole building forms a fire compartment.

If an Alternative Solution is used, the building elements used to form a fire compartment must have appropriate fire separation from the remainder of the building as determined by fire engineering principles. Note that FRLs are only used in the Deemed-to-Satisfy Provisions.

If the Deemed-to-Satisfy Provisions of Part **C3** are used, the building element used to form a fire compartment must have the fire-resistance level (FRL) of a fire wall required by **Specification C1.1**.

Sole-occupancy units are not generally regarded as fire compartments except for **E1.4** for fire hose reels.

Fire hazard properties

A material's fire hazard properties is an indication of its susceptibility to the effects of flame or heat, particularly during the early stages of a fire.

Fire-isolated passageway

A fire-isolated passageway protects people within a passageway from fire while evacuating. The whole passageway must be fire-protected from a fire outside the passage, including the floor, walls, ceiling, roof, any doors or other openings. The Deemed-to-Satisfy Provisions for fire-isolated passageways are in **D2.11**. The provisions relating to the protection of openings are in **C3.8**.

Fire-isolated ramp

See fire-isolated passageway.

Fire-isolated stairway

See fire-isolated passageway.

Fire-protective covering

While not fire rated, these elements have been found to provide nominal protection from the spread of fire of at least 20–30 minutes.

The BCA lists materials deemed to be fire-protective coverings. The fixing in each case must accord with normal trade practice. There must be no gaps at the joints in the sheets, and the joints must be sealed in the usual manner. Standard grade 10 mm or 13 mm plasterboard is not acceptable as a fire-protective covering.

Fire-resistance level (FRL)

Used only in the Deemed-to-Satisfy Provisions, the FRL of a building element is determined by conducting the Standard Fire Test on a prototype in accordance with AS 1530.4.

Example

If the BCA requires a building element to have an FRL of 120/60/30, this means that the element must maintain, when tested in accordance with AS 1530.4:

- structural adequacy for a period of 120 minutes;
- integrity for a period of 60 minutes; and
- insulation for a period of 30 minutes.

Fire-resisting

Applies to fire-resisting building elements, including structural members and non-loadbearing components, such as cladding, doors, windows and the like.

Fire safety system

These systems may be active systems, passive systems, or any combination of the two.

Examples

Some examples of fire safety systems:

Active systems

- sound systems and intercom systems for emergency purposes;
- emergency lighting;
- exit signs;
- sprinkler systems;
- fire hydrant systems;
- fire hose reel systems;
- smoke and heat vents;
- mechanical smoke-exhaust systems; and
- portable fire extinguishers.

Passive systems

- fire-isolated stairways, ramps and passageways;
- fire walls; and
- other fire-resisting building elements.

Fire-source feature

Used in Deemed-to-Satisfy Provisions to describe a possible fire source external to the building from which a fire could spread to the building. See [Figure A1.1\(FSF\)](#).

A fire-source feature includes the far side of the road, and the side or rear boundary of an allotment. It also includes the far side of lakes, rivers and the like where the construction of buildings is unlikely. These represent the worst-case scenario for the spread of fire from another building. Even if a building on an adjacent allotment is set back from a boundary, the BCA assumes it could be demolished and another building constructed on the boundary.

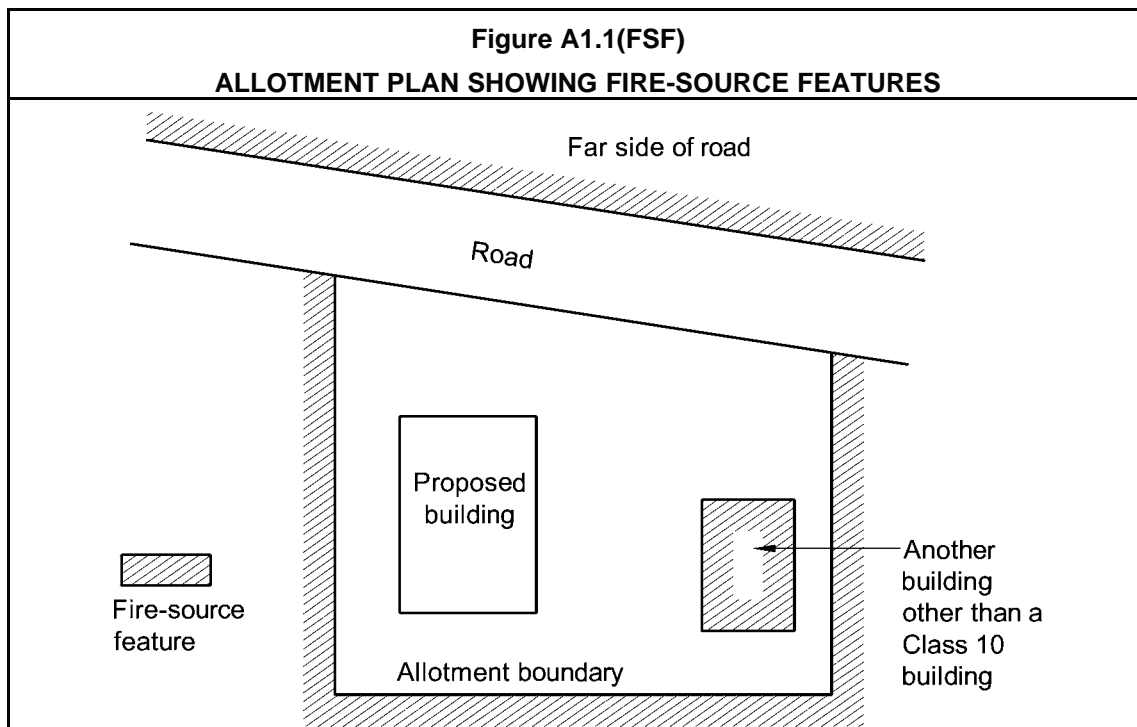

Note that the term “fire-source feature” does not necessarily apply to a building—it relates to a potential source of fire. That potential may be realised in the future construction of a building. For this reason, the fire-source feature is not simply a line on the ground, nor a point at the top of a building; it is a continuous plane rising above that line or point.

In this sense:

- a line drawn out horizontally from a building to a fire-source feature will hit that feature; and
- form a 90° angle with a line drawn down from the point at which it hits the fire-source feature to the ground, or the top of the adjoining building.

However, some Deemed-to-Satisfy Provisions of the BCA limit the height above a building at which the fire-source feature remains active (see [Clause 2.1 of Specification C1.1](#)).

The reason for the exclusion of Class 10 buildings on the same allotment is that they are generally small and have a low fire load.

Fire wall

Fire walls separate fire compartments. To avoid the spread of fire to another part of the building, a fire wall must extend from the fire-rated floor of a storey to the underside of the fire-rated floor above, or to a non-combustible roof covering.

A “fire-resisting” wall is not necessarily a “fire wall”. A fire wall can sometimes be an external wall. See [C2.7](#) and [Figure C2.7\(3\)](#) of this Guide.

Flammability Index

A test performed in accordance with AS 1530.2 will determine the flammability index of a material.

Flashover

Flashover The term “flashover” is used in Clause 3(b) of Specification C1.10a dealing with tests for the fire hazard properties of building materials and components. The definition defines the term by specifying the heat release rate in the test. See [Specification C1.10a](#).

Flight

A flight is the part of a stairway that has a continuous slope created by the nosing line of the stair treads. Quarter landings are not considered part of a flight. However, winders are considered part of a flight. See [Figure A1.1\(FLI\)](#).

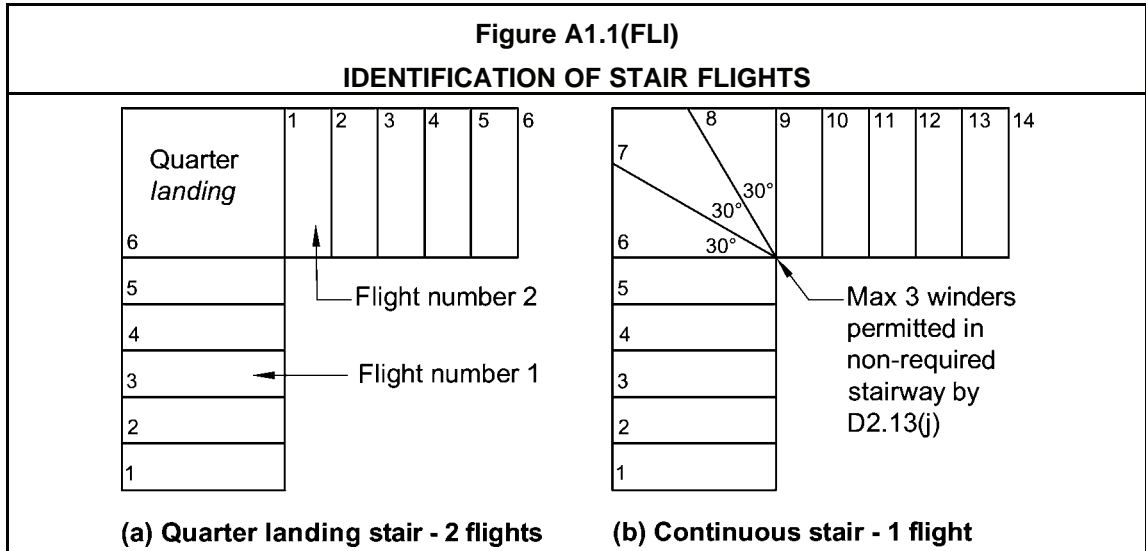

Floor area

When applied to a building or storey, the floor area includes all the space capable of being used. It includes any roofed area, canopy, verandah or covered walkway, etc.

Floor area is used in a number of different contexts in the BCA. It is therefore necessary to define each of these contexts:

- In relation to a building—the sum of the areas of all storeys.
- In relation to a storey—the floor area of the storey includes any enclosing walls. Where there is no enclosing wall in a part of a storey, those areas which may be used for storage, or other purposes, by occupants must be included as appropriate. It therefore includes any roofed area, including a canopy, verandah or covered way if it contributes to the functioning of the building. Internal walls, columns, shafts or the like are not deducted. See [Figure A1.1\(FA\)\(1\)](#).
- In relation to a room—the bounding walls determine the limits of the floor area. Internal walls, columns or the like are not deducted. See [Figure A1.1\(FA\)\(2\)](#).
- In relation to a fire compartment—the fire compartment may not be bounded by walls in all places. If this is the case and a roofed area contributes to the fire load, it should be considered as part of the floor area. See [Figure A1.1\(FA\)\(3\)](#).
- In relation to an atrium—see [Figure A1.1\(FA\)\(4\)](#).

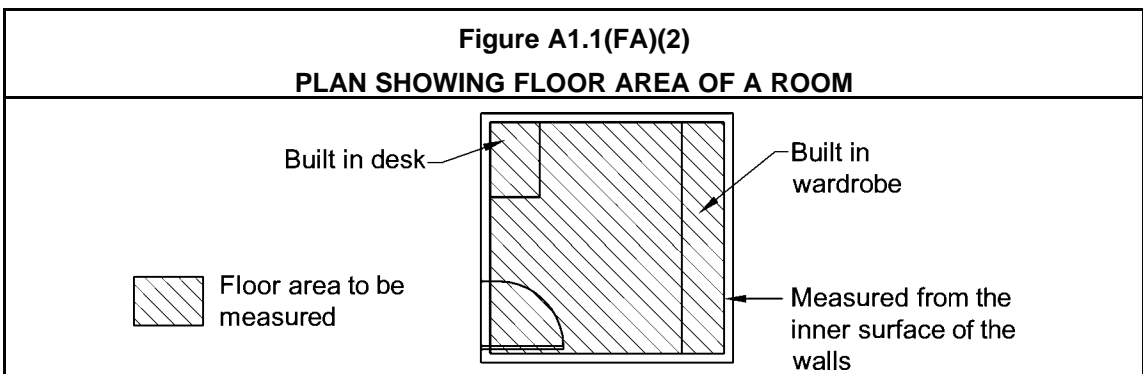
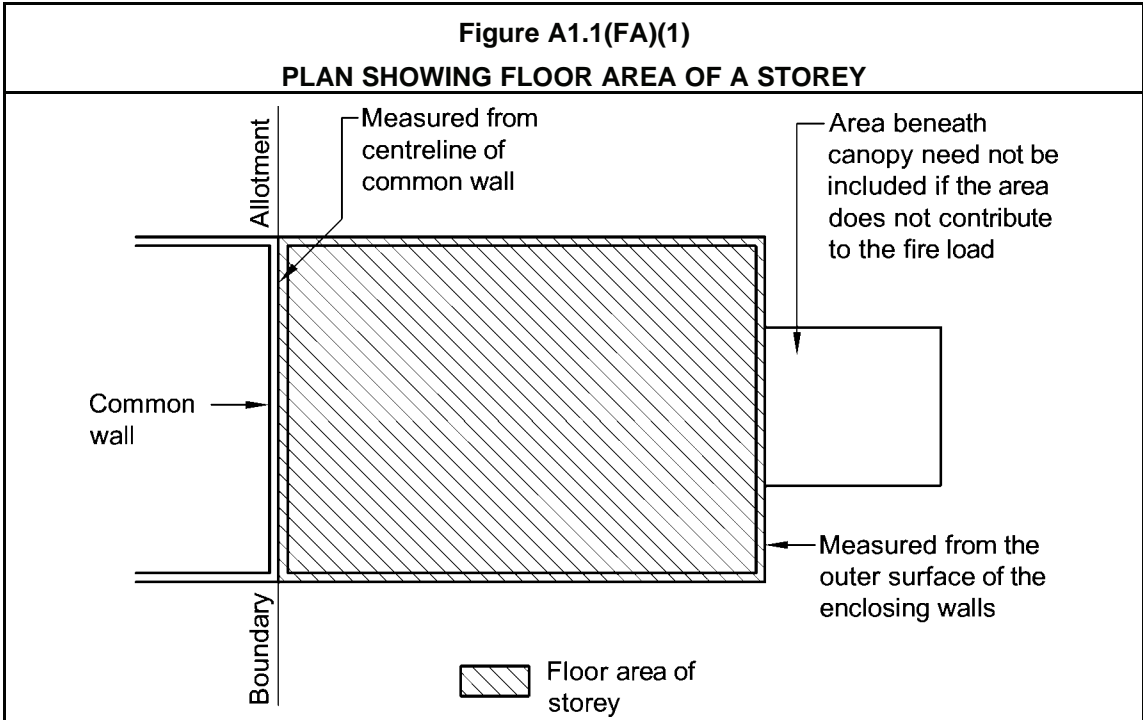

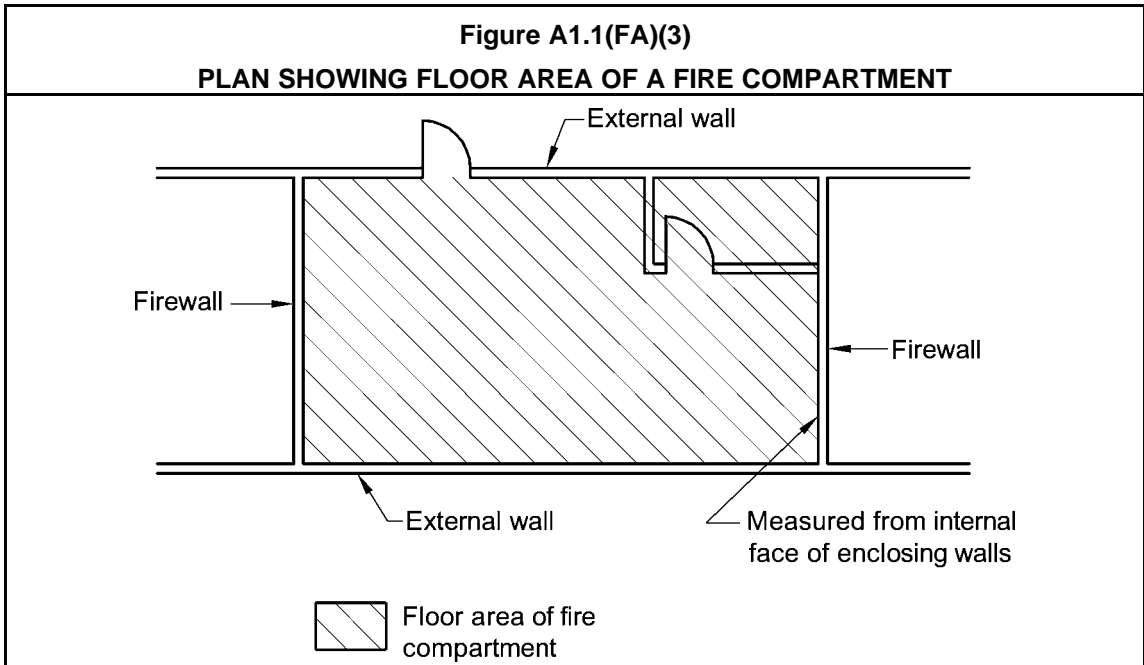

Functional Statement

See Part [A0](#).

Glazing

The glazing definition needs to be read in conjunction with the definition of a window and roof light. It can include a glazed door. For the purposes of [Section J](#), the glazing provides an aperture by which light and energy can flow into or from the conditioned space. Glazing includes the glass and any frame system.

Group number

[Specification C1.10](#) sets out the requirements for Group 1, Group 2, Group 3 and Group 4 materials. A test in accordance with either AS ISO 9239.1 or AS/NZS 3837 determines the group a material belongs to. The BCA permits the installation of Group 1, Group 2 and Group 3 materials. Group 1 materials are the best performing materials. Group 4 materials are the worst performing materials.

Habitable room

Only applies to Class 2 and Class 3 buildings and Class 4 parts of buildings.

Health-care building

Used in the classification of a Class 9a building. It refers to buildings needing special evacuation requirements, because some occupants may need to be assisted during an emergency evacuation.

Health-care buildings include day-care surgeries or procedure units. They are distinguished from a doctor's or dentist's surgery, because if an evacuation became necessary in these places, patients would probably not need assistance in evacuating.

In a health-care building, patients may be incapable of movement, and require the assistance of another person to evacuate. They might also require medical supervision for a while after treatment.

Health-care buildings are not to be interpreted to include aged care buildings. It should be noted that the BCA contains differing requirements for Class 9a health-care buildings and Class 9c aged care buildings.

Illuminance

Used only in the Performance Requirements of **Part F4** to describe the amount of natural and artificial light required for a building.

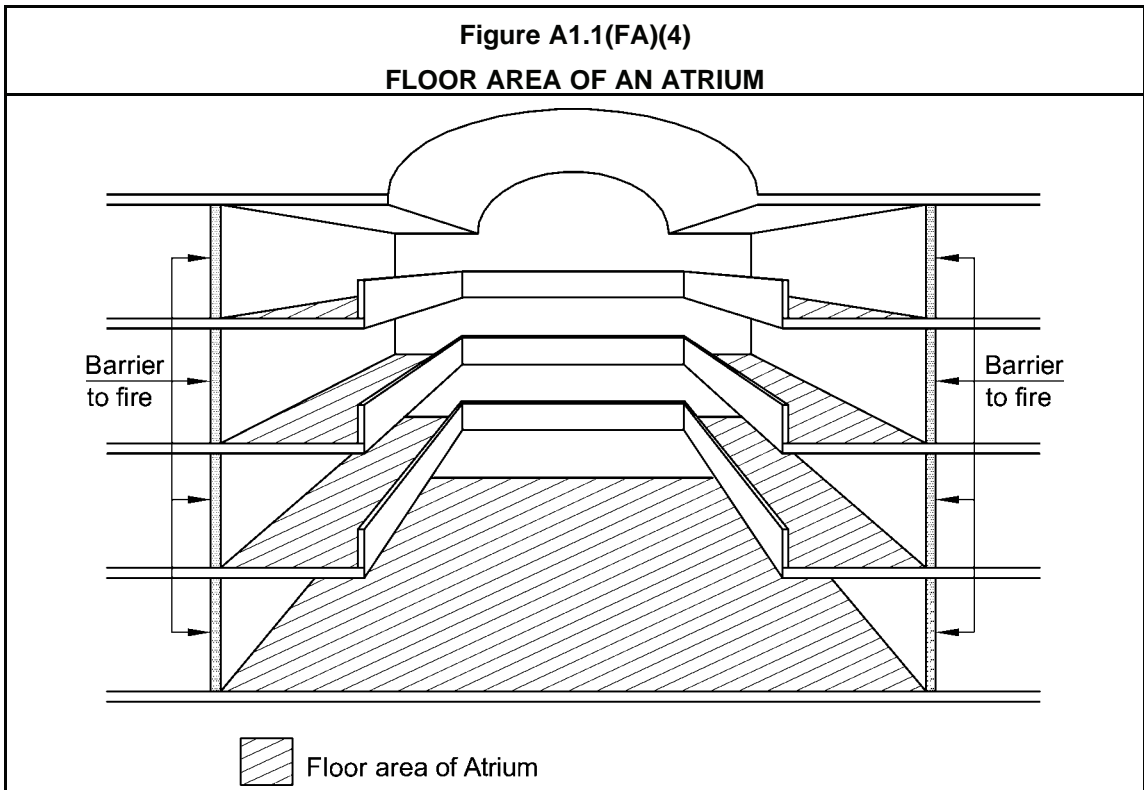

Illumination power density

This term is more wide-reaching than the simpler "lamp power density" term also used for the sole-occupancy units of Class 2 buildings and Class 4 parts. It needs to be calculated taking account of the losses from ballast, current regulators and integral control devices associated with the lighting system including track and flexible lighting systems, and fixed lighting that is part of modular furniture and workstation lights. However, socket outlets for intermittent use such as for floor standing lamps, desk lamps, etc. are not included as it is not possible to control them through the building control process. The calculation of illumination power density does not include losses elsewhere in the system, such as in the distribution cabling throughout the building.

Insulation

Insulation is the third criterion used when specifying an FRL.

Example

If the BCA requires a building element to have an FRL of 120/60/30, this means that the element must maintain, when tested in accordance with AS 1530.4:

- structural adequacy for a period of 120 minutes;
- integrity for a period of 60 minutes; and
- insulation for a period of 30 minutes.

A building element fails the insulation criterion if the average temperature of the unexposed face of the test specimen rises by more than 140 K (ie 140 degrees Kelvin) above the initial temperature. It also fails if the temperature of the unexposed face of the test specimen rises by more than 180 K above the initial temperature.

Integrity

Integrity is the second criterion used when specifying an FRL. See example under “insulation” definition.

The test under AS 1530.4 considers that a building element has failed the integrity criterion when either the element collapses, or the element develops cracks, fissures or other openings through which flames or hot gases can pass.

Internal wall

All walls that are not external walls are internal walls.

Lamp power density

This term was developed in order to simplify the statement of requirements and to simplify checking for sole-occupancy units of Class 2 buildings and Class 4 parts. It relates only to the lamp and does not include the power lost by any ballast, current regulator or control device. However, socket outlets for intermittent use such as for floor standing lamps, desk lamps, etc. are not included as it is not possible to control them through the building control process. The maximum power of a lamp is usually marked on the fitting as the maximum allowable Wattage.

Latent heat gain

This term refers to the heat used to vaporize a liquid without causing a change in temperature, such as heat used to generate steam from hot water at 100°C. Also included, in the BCA context, is the energy in the moisture from the human body.

Light source efficacy

This term is used to describe the effectiveness of a lighting device, and is expressed as the lighting output level in Lux for each unit of electric power consumed, including the power consumed by the lamp. It does not include the power lost by any ballast, current regulator or control gear.

Lightweight construction

The BCA lists building materials of “lightweight construction”. These materials need protection to preserve their integrity from fire and other damage. This is because they are more susceptible to damage than other forms of fire protection. For example, masonry thicker than 70 mm and materials like concrete, which typically do not contain soft materials, are not deemed to be lightweight construction. See [C1.8](#) and [Specification C1.8](#).

Luminance contrast

This term is used in provisions for access for people with a disability. Luminance contrast is the measurement of the amount of light reflected from one surface or component, compared to the amount of light reflected from the background or surrounding surfaces. The majority of people who are blind or vision impaired have some vision. The provision of sufficient luminance contrast between components or surfaces and their backgrounds assists in their identification and use.

Mezzanine

A “mezzanine” must be part of a room. If an intermediate floor is enclosed by a wall it is no longer within another room, and is therefore no longer a mezzanine. Such rooms are sometimes called “mezzanines” by the layperson. This does not mean they are classified as such by the BCA. See [Figure A1.1\(ME\)](#).

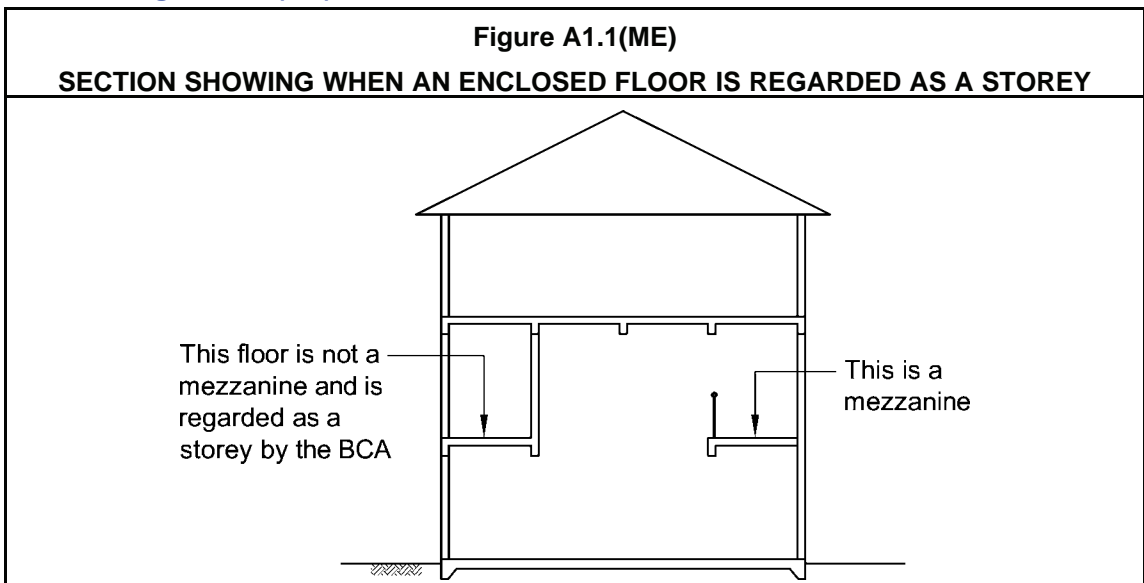

Objective

See Part [A0](#).

Open-deck carpark

The Deemed-to-Satisfy Provisions contain a number of concessions for open-deck car parks. The concessions are based on the amount of natural ventilation available. Ventilation is needed for the dissipation of car fumes and also for heat and smoke during a fire. An open-deck car park may be a whole, or part, of a building.

Open space

Egress from a building must be to a road or open space. An open space must be open to the sky and connect directly to a public road. See [D2.12](#).

Open spectator stand

Traditionally called a “grandstand”. The Deemed-to-Satisfy Provisions contain a number of concessions for open spectator stands. Concessions are based on the amount of natural

ventilation, at the front of these stands, during a fire. They may be a whole, or part, of a building.

Other property

Used to describe nearby buildings and land requiring protection for structural, fire or drainage reasons. The purpose of including a road as part of “other property” is that in certain parts of the BCA, a road, or the people using it, may need protection.

Example

The BCA takes into consideration protection from collapse of a building or any part of it on to the road, and in some States and Territories protection from collapse of a road into a building/construction excavation.

Outside air economy cycle

This term describes a mode of operation of an air-conditioning system in which the quantity of outside air is increased beyond that needed by the mechanical ventilation requirements of [Part F4](#) in order to provide free cooling. Free cooling can be initiated when cooling is required by the air-conditioning system and the outside air temperature is below the set-point temperature of the conditioned space.

Panel wall

The difference between a panel wall and a curtain wall is that a panel wall is supported at each storey, and a curtain wall is not.

Patient-care area

Includes “ward areas” and “treatment areas”.

Performance Requirement

See [Part A0](#).

Personal care service

Personal care services include any combination of the listed services. The definition is used in defining an aged care building. (See comments on the definition of aged care building).

Piping

This term may have a different meaning in other parts of the BCA or in BCA referenced documents, for example, in relation to sprinklers. This definition of piping is only applicable to [Section J](#) where it is used mainly for thermal insulation provisions.

Primary building element

Those materials and constructions subject to attack by termites causing structural problems. This includes stairs and ramps. Excluded are building elements which provide bracing to a wall, but this is not designed as part of their function. An example would be plasterboard not required for bracing or an external cladding.

Private bushfire shelter

The term is used to describe a Class 10c building. The provisions for Class 10c private bushfire shelters are contained in the Housing Provisions (Volume Two) of the BCA.

Private garage

To be classified as a private garage (and therefore a Class 10a building or part), a structure can only accommodate a maximum of three vehicles, unless the garage is associated with a Class 1 building.

A building designed to accommodate three-or-less vehicles carries a comparatively low fire load, even if used commercially. Thus, there is not much difference between the fire risk from a domestic private garage and one used commercially.

If a garage is not associated with a Class 1 building, and accommodates more than three vehicles, it is a carpark and therefore a Class 7 building or part.

Professional engineer

Includes a professional engineer eligible for registration with the Institution of Engineers (Australia) under classification NPER3. Some States and Territories define “professional engineer” differently. Such definitions override the BCA definition.

Public corridor

Not all corridors and hallways are public corridors. A public corridor must be enclosed and provide egress from more than one sole-occupancy unit. Examples include passages leading from hotel suites, lift lobbies and foyers in high-rise buildings. Public corridors can be required to provide egress to a required exit.

Pump power

The pump power is the amount of power that a pump needs and includes the inefficiency of the pump and the power consumed by any drive train. This means that it is the power a pump motor needs to provide either directly or by an output shaft.

R-Value

The R-Value of a component relates to the component material itself, and does not include any surface coatings, air gaps or surface resistances. R-Values are rarely used independently, but can be used to express a component’s contribution to an insulating system, in which case, the thermal resistance expression for the system would become Total R-Value.

Reference building

A reference building is used to determine the maximum annual energy consumption allowed. This is done by applying the Deemed-to-Satisfy Provisions, along with certain stated criteria, to a proposed design. The annual energy consumption calculated is then used to assess the energy efficiency of the Alternative Solution.

Reflective insulation

This term is used in AS/NZS 4859.1 and covers a range of insulating products that have one or more reflective surfaces. Reflective insulation is one example of sarking-type material.

Registered Testing Authority

A Registered Testing Authority is an organisation authorised to give an opinion on the use of a material, construction or design.

Testing Authorities are registered by the National Association of Testing Authorities (NATA). NATA publishes a directory explaining which authorities are registered to carry out what tests.

International organisations are also recognised by NATA; a directory also details these organisations.

Under paragraph (c), valid test reports from organisations which were recognised as being Registered Testing Authorities under legislation at the time the test was undertaken may still be accepted.

Renewable energy

The definition of renewable energy clarifies what are the sources of operational energy that do not result in significant greenhouse gas emissions. Examples given include solar, wind, hydro-electric, wave action and geothermal. For the purpose of the defined term, an on-site renewable energy source does not include Greenpower.

Renewable energy certificate

A renewable energy certificate is a document issued by the Department of the Environment, Water, Heritage and the Arts as evidence of the thermal performance of an item of plant.

Required

When used in the Performance Requirements, the term means required to meet the Performance Requirement. When used in the Deemed-to-Satisfy Provisions, it means required to meet those provisions.

Residential aged-care building

Applies only to buildings housing residents with mental or physical impairments caused by the ageing process. Such impairments require that patients need assistance in their daily lives.

People are employed to assist and care for these residents. Hence, the building requirements aim to provide a more amenable environment for the residents.

The definition applies to Class 3 and Class 9a buildings. The BCA contains a number of concessions for Class 3 residential aged-care buildings. See [C3.11](#) and [Specification C1.1](#).

Resident use area

Only applies to Class 9c buildings.

Resistance to the incipient spread of fire

Refers to the ability of a ceiling to prevent the spread of fire and thermally insulate the space between the ceiling and the roof, or floor above. "Resistance to the incipient spread of fire" is superior to "fire-resistance" because it requires a higher standard of heat insulation. Refer to AS 1530.4.

Rise in storeys

[C1.2](#) describes how to calculate the rise in storeys.

Roof light

The definition provides a distinction between a window and a roof light based on its angle to the horizontal.

Safe place

A safe place provides a final refuge from a fire, such as a road or open space at the end of an exit. It can also be a temporary "haven" or "refuge" to protect people while they are evacuating

during a fire. The term is only used in the Performance Requirements. Safe places can be inside or outside a building, and must provide a person with protection from a fire and then allow them to safely escape to a road or open space.

Example

- fire-isolated stairways;
- fire-isolated ramps;
- fire-isolated passageways; and
- an adjacent fire compartment.

Sarking-type material

A sarking-type material is a flexible membrane that may be used for waterproofing, vapour proofing or thermal reflectance and includes reflective insulation. Commonly used terms include sarking, reflective foil, building wrap and breathable membrane.

Self-closing

Applies to doors which are smoke or fire doors and the like. In each case it is important that the doors be fitted with a device that immediately closes them after manual opening, and keeps them closed to stop the spread of fire and/or smoke during a fire situation.

Sensible heat gain

This term refers to the heat added to air to cause its temperature to rise. This can be heat from people, other than latent heat, and the heat from lights or appliances, other than the latent heat from steam generating devices.

Service

There are many services in a building, but for BCA purposes, only certain building services are regulated, and this excludes process services. Those services regulated are stated in the definition and specified in the Deemed-to-Satisfy Provisions.

Service station

An outlet which sells petrol and has an area for servicing motor vehicles. The whole service station can be classified as a Class 6 building. The definition also applies to a car dealership which contains an area for the servicing of vehicles.

Shaft

The definition includes the top and bottom as well as the walls.

Smoke-and-heat vent

Can be automatically opened as necessary, or permanently fixed open. See Parts [C2](#) and [E2](#).

Smoke-Developed Index

A test in accordance with AS/NZS 1530.3 determines the Smoke-Developed Index of a material. The index is based on a logarithmic scale of 0 to 10. A lower index number indicates better performance.

Smoke development rate

A test in accordance with AS ISO 9239.1 determines the smoke development rate of a material. A lower value indicates better performance.

Smoke growth rate index

A test in accordance with AS ISO 9705 determines the smoke growth rate index (SMOGR_{RC}) of a material. A lower value indicates better performance.

Solar Heat Gain Coefficient (SHGC)

The definition of Solar Heat Gain Coefficient (SHGC) has been developed to reflect the specific context in which this term is used in the BCA, and is calculated using the Technical Protocol and Procedures Manual for the Energy Rating of the Fenestration Products by the Australian Fenestration Rating Council (AFRC).

Sole-occupancy unit

A sole-occupancy unit is an area within a building for the exclusive use of the occupier. It is irrelevant if the area is occupied by an individual, or by two or more people, or by a company.

Example

Examples of sole-occupancy units include individual flats in a block of flats; a suite or unit in a hotel or motel; bedrooms in an aged care building; a shop in a shopping centre; and an office occupied by an individual owner or tenant in an office building.

Areas that do not comprise a sole-occupancy unit are those intended and available for the use of more than one tenant (what is often called a “common space”). Examples include a laundry; TV room; entertainment room; and kitchen in a block of flats or a boarding house.

Spread-of-Flame Index

A test in accordance with AS/NZS 1530.3 determines the Spread-of-Flame Index of a material. The index is based on a logarithmic scale of 0 to 10. A lower index number indicates better performance.

Standard Fire Test

AS 1530.4 contains details of the Standard Fire Test. The test is used to determine the FRL of a building element. The results are recorded in order as: structural adequacy, integrity and insulation.

Storey

Figure A1.1(ST) illustrates that a storey extends from the floor level of the subject area to the floor level above, or, if the storey is at the top of the building, to the ceiling or roof. It is not unusual for people to simply regard the ceiling or the bottom of the storey above as the top of a storey.

The listed exceptions for a storey are normally small areas with a low fire load and low occupation.

Structural adequacy

Structural adequacy is the first criterion used when specifying an FRL. It is used only in relation to the FRL of a building element. See the example under ‘insulation’ definition.

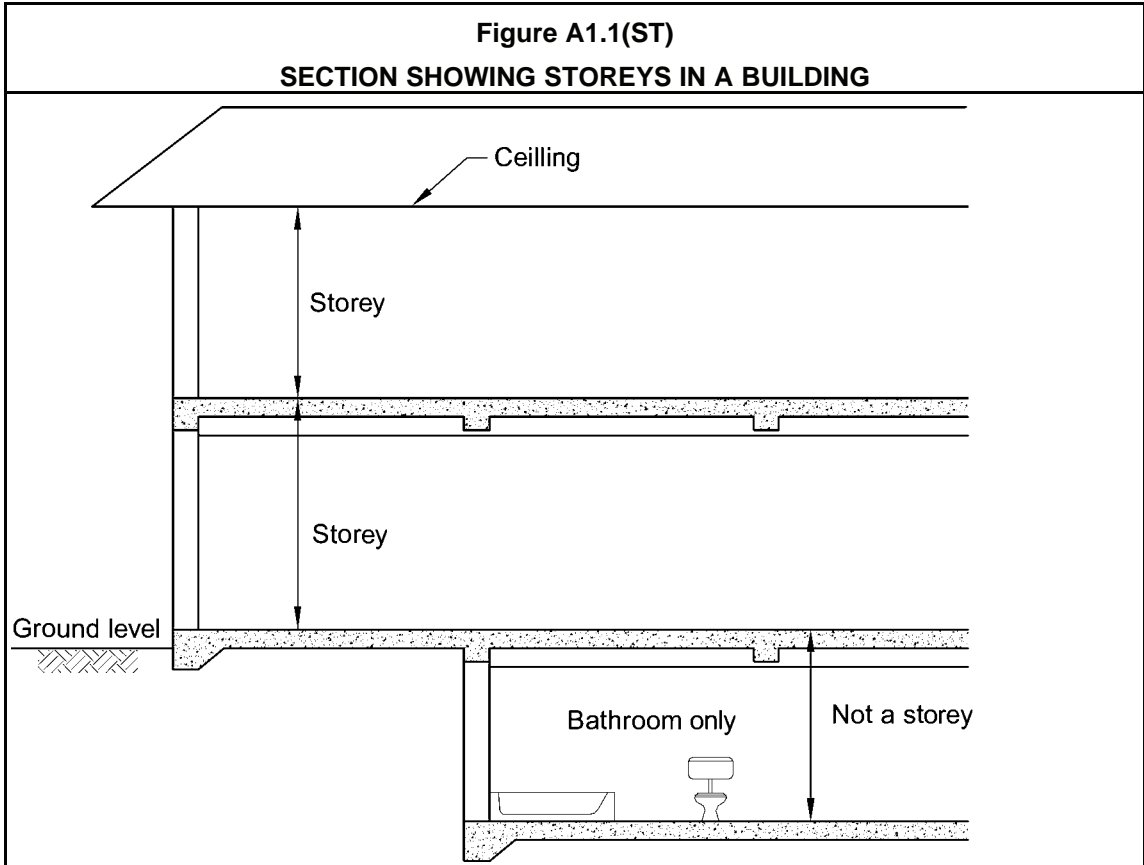

Swimming pool

Applies to swimming and wading pools, and spas (excluding units such as spa baths emptied after each use). For provisions see Part **G1**. These provisions do not apply to all swimming pools.

Total R-Value

The definition of the Total R-Value of a thermal insulating system covers the various materials themselves and any surface coatings, air gaps or surface film resistances. As a minimum, a system must consist of a material plus two surface films, usually an outer film exposed to a wind velocity and an inner film exposed to a lower velocity. A brick veneer wall, for example, has at least five components, i.e. the outer air film, the brickwork, an air gap across the cavity, plaster lining and an inner air film. Bulk insulation in the frame cavity may be another component, while reflective insulation provides a reflective surface as well as one more air gap.

Total U-Value

U-Value is a measure of the rate of heat transfer through a material and is the reciprocal of R-Value. Total U-Value is the reciprocal of the sum of the R-Values of individual elements. Although it applies to all materials, U-Values are generally stated for transparent and translucent materials while R-Values are generally stated for opaque materials. Transmittance is referred to for transparent and translucent materials while overall heat transfer coefficient is the general term. Total U-Value is used in the BCA for roof lights and glazing and is calculated using the

Technical Protocol and Procedures Manual for the Energy Rating of the Fenestration Products by the Australian Fenestration Rating Council (AFRC).

Treatment area

Part of a “patient-care area”. In a treatment area, a patient undergoes treatment (eg an operation), which may result in the patient being unable to evacuate without assistance in an emergency such as a fire.

Unenclosed shower area

This definition is only used in the requirements for waterproofing of wet areas in buildings.

Verification Method

See Part **A0**.

Ward area

Part of a “patient-care area”. It includes a hospital or nursing-home ward and the nursing stations associated with such wards. Also, any associated living areas, such as bath and shower rooms, toilets, TV rooms, activity rooms and the like.

Window

A window must be capable of allowing light into a building, even when closed. Any transparent or translucent glass pane, brick or block, or a roof light or the like, is a window.

A1.2 Adoption of Standards and other references

Intent

To indicate the elements of any referenced documents which are not included as part of the adoption process.

A1.2 only applies to the Deemed-to-Satisfy Provisions of the BCA.

A1.2 means that contractual matters or clauses defining responsibilities of various parties, and matters in Australian Standards or other codes not appropriate for adoption in the BCA are not included when a standard is called up in a Deemed-to-Satisfy Provision.

A1.3 Referenced Standards, etc

Intent

To specify that the editions or issues of referenced documents adopted by the BCA are those listed in **Specification A1.3**, to the extent stated in the Specification.

Specification A1.3 is only mandatory to Deemed-to-Satisfy Provisions. However, referenced documents are only applicable to the BCA provision that references the document.

A building proponent undertaking an Alternative Solution can use any element or edition of any document, if they help satisfy the Performance Requirements. They do not need to use the documents listed in **Specification A1.3**.

Specification A1.3 lists the specific edition of the Standard or other document adopted, including any amendments considered appropriate for the Deemed-to-Satisfy Provisions. Other

editions of (or amendments to) the referenced document are not adopted, and have no standing under the BCA.

When a document listed in **Specification A1.3** refers to a second document, that reference is that reference is to the second document as it existed at the time of publication of the document listed in **Specification A1.3**.

A1.2 sets out the general rules that any referenced document must adhere to. **A1.3** identifies the applicable edition of the BCA referenced document as well as the relationship of any secondary references.

A1.4 Differences between referenced documents and the BCA

Intent

To state that the provisions of the BCA take precedence over any referenced document, such as an Australian Standard.

The following is the precedence, or pecking order, for documents used in the building regulatory system. Any State or Territory Act or regulation which adopts the BCA takes precedence over any BCA provision. The BCA, in turn, takes precedence over any referenced document.

A1.5 Compliance with all Sections of BCA

Intent

To specify that all Class 2–9 buildings must comply with all the relevant provisions of the BCA, as specified in the BCA.

All the provisions that apply to a particular building must be satisfied. Relevant exemptions and limitations are noted within the BCA provisions. See **A1.6**.

A1.6 Application of the BCA to a particular State or Territory

Intent

To detail what the BCA is comprised of in each State and Territory.

State and Territory variations and additions are part of the BCA and are included as an Appendix to the BCA.

A1.7 Language

Intent

To state the meaning of certain specified expressions.

When the BCA refers to a building, that reference can be to the whole, or any part, of the building. Whether this provision applies depends on the circumstances of that case.

Example

A hotel (Class 3) built in conjunction with offices (Class 5), as can often be the case with large hotel developments in central city areas. In this case a decision must be made as to

whether the whole building is Class 3. This would usually be the case if the office component is less than 10% of the floor area of the particular storey the remainder of which is a Class 3. Once the classification is determined, the BCA provisions for that classification are applied.

A number of the Performance Requirements of the BCA use the expression “**to the degree necessary**”. This expression provides flexibility by allowing appropriate authorities to determine the degree of compliance necessary in a particular case.

For example, an appropriate authority might judge that an item need not be installed, or a particular level of performance be achieved. The expression is often supported by examples in this Guide.

PART **A2** ACCEPTANCE OF DESIGN AND CONSTRUCTION

A2.1 Suitability of materials

Intent

To explain the quality of work and materials needed to construct a building to meet BCA requirements.

A building must meet BCA requirements. This means that:

- all people involved with construction must work skilfully in accordance with good trade practice; and
- all materials must be of a quality to fulfil their function/s within the building.

A2.1 only applies to matters normally covered by the BCA.

Example

Permit authorities would ordinarily not apply **A2.1** to such matters as:

- plastering—other than for fire rating, water proofing of wet areas, and noise insulation; or
- painting—other than that required for weatherproofing an external wall.

While **A2.1** outlines quality of work and material demands, sometimes additional conditions may be required by:

- other Commonwealth, State or Territory legislation; and
- contracts that include either specific quality requirements, or requirements for specific materials and the like.

A2.2 Evidence of suitability

Intent

To detail evidence which may support a claim that a material, construction or design achieves a Performance Requirement or Deemed-to-Satisfy Provision, or that a calculation method complies with an ABCB protocol.

A2.2 is subject to compliance with **A2.3** and **A2.4**.

Fire-resistance level—**A2.3**

If a proposal uses a Deemed-to-Satisfy Provision which requires a building element to have an FRL, then **A2.2** may be used to provide evidence to support the proposal. However this alone is not enough. The FRL must be determined in accordance with **Specification A2.3**.

Early Fire Hazard Index—**A2.4**

If a proposal uses a Deemed-to-Satisfy Provision which requires a building element to have an Early Fire Hazard Index, then **A2.2** may be used to provide evidence to support the proposal.

Again, this alone is not enough. In this case, the Early Fire Hazard Index must be determined in accordance with **Specification A2.4**.

A2.2 represents the minimum level of documentary evidence needed to show that a material, construction or design meets BCA requirements. There will be times when this evidence will need to be produced and sighted. The evidence can be required by:

- an appropriate authority;
- a party to a construction contract; or
- a person certifying compliance with the BCA.

There is an onus, on any party submitting such evidence, to clearly indicate what is required from that evidence. If a building proponent does not produce exactly what is required, the evidence may be rejected.

Sources of supporting evidence

There are several specifically named sources of evidence available for use. However, other sources of evidence may be used if the appropriate authority is satisfied that they are suitable.

Registered Testing Authority—A2.2(a)(i)

This source of evidence relates to materials or construction.

A report from this source must:

- show that the material or construction has been submitted to specifically listed tests;
- set out the test results; and
- include any other information which demonstrates that the subject of the report is suitable for use.

Certificates of Conformity or Accreditation—A2.2(a)(ii)

This source of evidence applies to materials, construction and designs.

Certificates issued by the ABCB scheme for products and systems certification are called Certificates of Conformity. They are issued for building products and systems that comply with the BCA. Certificates must be current and are not acceptable if expired.

Certification and accreditation authorities issue Certificates of Conformity or Accreditation. They are the basis of detailed technical evidence that the material, construction or design complies with BCA provisions.

Certificates may be for known building products, constructions, designs or new and innovative systems.

Professional engineer—A2.2(a)(iii)

Evidence gained from this source applies to materials, construction and designs.

Approval can be gained by:

- a professional engineer, as defined in the BCA, who is required to have 'appropriate experience and competence'; or
- any other person who is 'appropriately' qualified.

In both cases, the term 'appropriately' means a person whose qualifications satisfy an appropriate authority.

(Where evidence is requested by another party under a contract, 'appropriate' means in the opinion of that party).

The engineer or technical person should have suitable experience in the area/s being tested. For example, it would not be acceptable for a structural engineer to report on a mechanical ventilation matter. A recently graduated engineer would not report on a complex structural matter concerning a high-rise city building.

The Joint Accreditation System of Australia and New Zealand—A2.2(a)(iv)

This source of evidence applies to materials, construction and designs. JAS-ANZ, as it is known, is the peak organisation for the accreditation of third-party certification bodies.

A certificate of conformity issued by any group (including Standards Australia) that bears accreditation from JAS-ANZ is an acceptable form of evidence.

A2.2(a)(vi) allows for the use of alternative forms of documentary evidence to those included in **A2.2**, as long as they comply with certain specified conditions.

An example of this arises when an authority carries out an inspection of a building site. The inspection alone would not be acceptable as evidence. However, if the authority compiled a written report of the inspection then it may comply with the requirements of **A2.2(a)(vi)**.

Although the BCA does not reference any particular surveillance testing of fire detection and fire alarm equipment, a number of suitable schemes are available in Australia that certify such equipment. If such a scheme is to be used, it is important that the scheme includes suitable measures to ensure the reliability and consistency of the equipment.

Calculation Methods— A2.2(b)

There is significant reliance by industry on the use of calculation methods, including software programs, for demonstrating compliance with the BCA. While there is no formal recognition of specific methods, **A2.2(b)** allows suitable evidence to be submitted to demonstrate that a calculation method (including a software program) complies with a relevant ABCB protocol that establishes the characteristics of a suitable calculation method.

All copies of documents provided as evidence must be unabridged copies of the originals. No part can be left incomplete. (See **A2.2(c)**).

A2.3 Fire-resistance of building elements

Intent

To state that, for the purposes of the Deemed-to-Satisfy Provisions, **Specification A2.3** must be used to provide a basis for determining the fire-resistance level (FRL) of a building element.

See section titled Suitability of materials **A2.2**. Refer to comments on fire-resistance of building elements.

In the case of a test report from a Registered Testing Authority, the report may be either—

- the test report referred to in clause 2.15.2 of AS 1530.4 (also referred to as a full test report); or
- the regulatory information report referred to in clause 2.15.3 of AS 1530.4 (also referred to as a short-form report).

In both cases the report must be an unabridged copy of the original report. A test certificate referred to in clause 2.15.4 of AS 1530.4 is not suitable for showing compliance with the BCA.

A2.4 Fire hazard properties

Intent

To state that, for the purposes of the Deemed-to-Satisfy Provisions, **Specification A2.4** must be used to provide a basis for determining fire hazard properties.

See section titled Suitability of materials **A2.2**. Refer to comments on fire hazard properties which includes:

- Flammability Index.
- Spread-of-Flame Index.
- Smoke-Developed Index.
- A material's group number.
- Smoke growth rate index.

A2.4 also sets out which fire hazard properties must be determined in accordance with **Specification A2.4** and which must be determined as defined in **Part A1**.

A2.5 Resistance to the incipient spread of fire

Intent

To establish, for the purposes of the Deemed-to-Satisfy Provisions, the method of determining the resistance to the incipient spread of fire.

The Deemed-to-Satisfy Provisions of the BCA contain a number of provisions requiring a ceiling to have a resistance to the incipient spread of fire to the space above itself. This provision sets out the method of determining the incipient spread of fire. The method is based on the method of determining the FRL of a building element and use of the Standard Fire Test.

PART A3

CLASSIFICATIONS OF BUILDINGS AND STRUCTURES

A3.1 Principles of classification

Intent

To state the basis of any decision regarding the classification of a building or part of a building.

The use of a building determines its classification. Use is determined on the basis of its design, construction or adaptation.

A3.2 Classifications

Intent

To categorise buildings of similar risk levels based on use, hazard and occupancy.

Classification is a process for understanding risks in a building or part, according to its use. It must be correctly undertaken to achieve BCA aims as appropriate to each building in each circumstance.

It is possible for a single building to have parts with different classifications. Part of a building can also have more than one classification. Where there is any conflict between what requirements the part should comply with, the more stringent requirement applies.

Where it is unclear which classification should apply, appropriate authorities have the discretion to decide. They base their decision on an assessment of the building proposal.

They will look at what classification the building most closely resembles. They will also take into account the likely fire load. Plus, the likely consequences of any risks to the safety, health and amenity of people using the building.

Appropriate authorities will also look at any relevant court decisions or determinations of the State or Territory body responsible for considering appeals on building classification matters.

It should be noted that appeals body determinations and, in some States and Territories, certain court decisions are usually not precedent creating. Such decisions are determined on a case-by-case basis.

It should also be noted that State and Territory authorities responsible for building regulatory matters may have issued advice, interpretations or guidelines to assist practitioners in applying the correct classification to a building or part. Advice on such matters should be sought from the relevant authority.

Class 1

Class 1 buildings are covered in Volume Two of the BCA. While this Guide does not address Volume Two, for purposes of clarity, Class 1 and Class 10 buildings are briefly explained here.

Class 1 buildings are not located above or below another dwelling, or another class of building other than a private garage.

A sole-occupancy unit used for residential purposes located over another sole-occupancy unit used for residential purposes will always be a Class 2 or Class 3 building (depending on the circumstances). It cannot be a Class 1 building.

A single Class 1 dwelling can be made up of more than one building. For example, it may include what is ordinarily called a house, plus one or more habitable 'outbuildings' such as sleepouts. (Note that a habitable building such as a sleepout cannot be classified as a Class 10 building).

The height or number of storeys of a Class 1 building makes no difference to its classification.

The separating wall between adjoining Class 1 dwellings must start from the ground level.

Class 1b

A Class 1b building is a small guest house, boarding house or the like and in some circumstances, multiple dwellings on one allotment used for short term holiday accommodation. Guest, boarding, or lodging houses which do not meet the criteria for a Class 1b building are classified as Class 3 buildings.

Class 1b buildings used for short-term holiday accommodation include cabins in caravan parks, tourist parks, farm stay, holiday resorts and similar tourist accommodation. This accommodation itself is typically rented out on a commercial basis for short periods and generally does not require the signing of a lease agreement. Short-term accommodation can also be provided in a boarding house, guest house, hostel, bed and breakfast accommodation or the like.

Unlike a Class 1b building described in [A3.2\(b\)\(i\)](#), a Class 1b building described in [A3.2\(b\)\(ii\)](#) does not have any floor area limitation. Therefore, if 4 or more single dwellings are located on the one allotment and used for short-term holiday accommodation, each single dwelling would be classified as a Class 1b building regardless of the floor area of each dwelling or the combined floor area of all of the dwellings.

See also [Table D3.1](#) which contains an explanation of what is considered to be "one allotment".

The Class 1b classification can attract concessions applicable to Class 3 buildings. These concessions allow people to rent out rooms in a house, or run a bed and breakfast, without having to comply with the more stringent Class 3 requirements.

The reasoning is that the smaller size of the building and its lower number of occupants represents reduced fire risks.

Apart from their use, the primary difference between Class 1a and Class 1b buildings is that the latter is required to have a greater number of smoke alarms and in some circumstances, access and features for people with a disability.

Class 2

A Class 2 building is one which includes more than one dwelling, each of which is generally solely occupied by one or more people to the exclusion of others.

Such buildings must not be otherwise classified as a Class 1 or Class 3 building or Class 4 part. See [Figure A3.2\(1\)](#) for some configurations of Class 1 and Class 2 buildings.

Where a sole-occupancy residential unit is located above another sole-occupancy residential unit, the building containing the units can be either a Class 2 or a Class 3 building, depending on the other circumstances of the building proposal.

Class 2 buildings can be single storey attached dwellings. Where there is any common space below such dwellings, they are Class 2 (and cannot be Class 1) irrespective of whether the space below is a storey or not (see [Figure A3.2\(2\)](#)).

Class 2 buildings can be attached to buildings of another Class. The attached Class 2 buildings need not be attached to one another, and need not be more than a single storey.

When two or more dwellings are attached to another Class, they cannot be Class 4 parts, as any building can only contain one Class 4 dwelling.

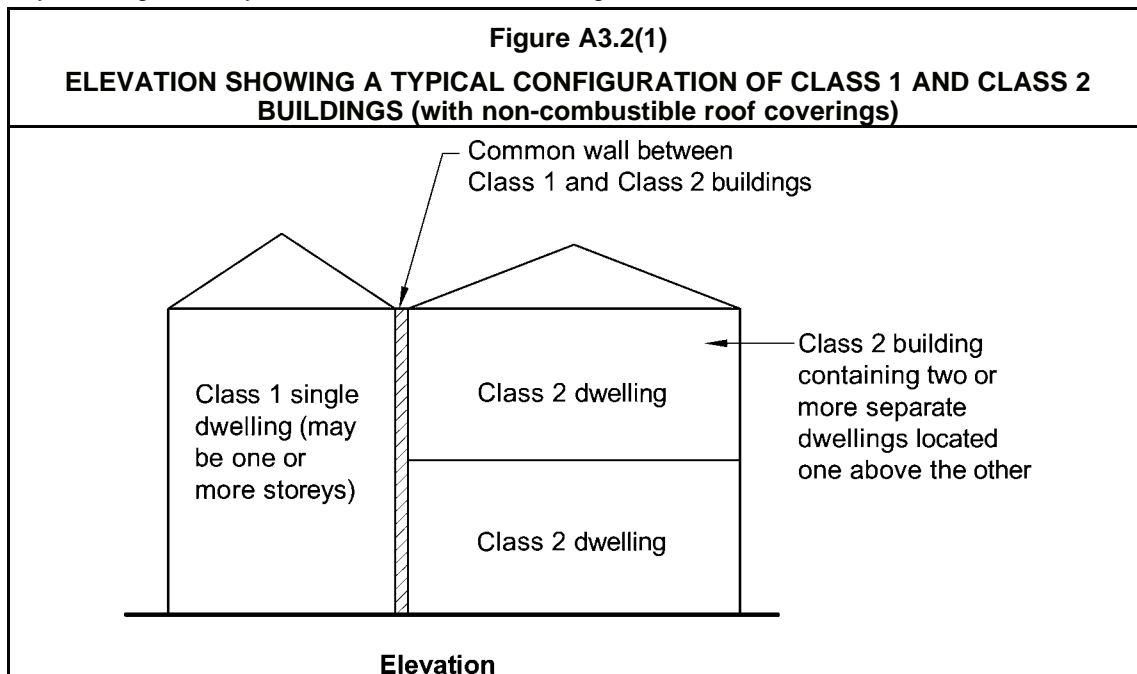

Class 3

Class 3 buildings provide accommodation for unrelated people. The length of stay is unimportant.

Some exceptions to this classification include: certain bed and breakfast accommodation, boarding houses, guest houses, hostels, or lodging houses and the like which fall within the concession provided for Class 1b buildings.

Also, any sized building can be classified as Class 1 or Class 2 if it is used to house any number of unrelated people who jointly own or rent it, or share it on a non-rental basis with an owner or tenant.

It is not unusual for a manager's, owner's or caretaker's dwelling attached to a Class 3 building to be thought of as a Class 4 part of the Class 3 building. However, a Class 4 part of a building can only be part of a Class 5-9 building.

Accordingly, such dwellings are either classified as Class 1, Class 2 or Class 3, depending on the circumstances of the building proposal. See also comments on matters that may influence classifications at [A3.2 of this Guide](#).

Figure A3.2(2)
ELEVATION SHOWING A SINGLE STOREY OF CLASS 2 WITH A COMMON AREA BELOW

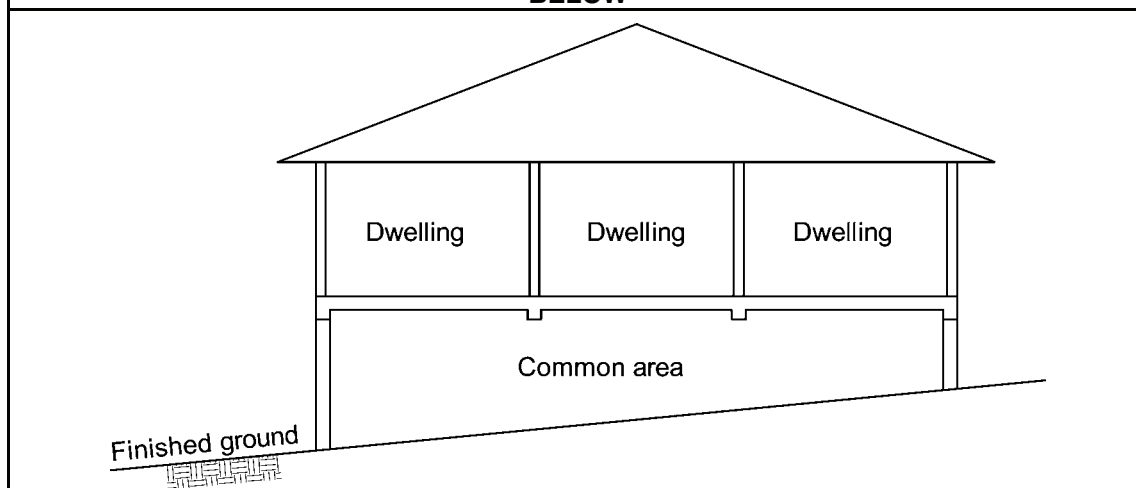

Examples

Class 3 buildings include:

- the residential parts of hotels and motels;
- hotel or motel caretakers', managers' or owners' flats, noting that under certain circumstances such dwellings could be Class 1, Class 2 or Class 3 buildings;
- dormitory accommodation, in schools or elsewhere, noting that a dormitory is generally (but not always) considered to be a sole-occupancy unit;
- bed and breakfast accommodation, a boarding house, guest house, hostel, or lodging house;
- backpackers' accommodation;
- a building which houses elderly people or other people who require special care. (In some States or Territories it is not acceptable for a Class 1b building to be used to house elderly people or other people who require special care - it is recommended the local building regulatory body be consulted. See comments on matters that may influence classifications at [A3.2 of this Guide](#).); and
- workers' quarters, including shearers' or fruit pickers' accommodation, or hotel workers' accommodation.

Class 4

Class 4 classification applies to some types of accommodation located within a Class 5-9 building.

Examples

The most common include a caretaker's flat within a building; and accommodation over or otherwise connected to a shop

A Class 4 part cannot be located within a Class 1, Class 2 or Class 3 building.

There can only be one Class 4 dwelling in a building. If there are two or more dwellings, they are Class 1, Class 2, or possibly Class 3. These Class 1, Class 2 or Class 3 parts need not be attached to one another, nor be more than a single storey.

Where a Class 4 part of a building is rented out for accommodation purposes, it retains its Class 4 classification. However, if any other part of the principal building is used for accommodation, for example, the attached shop is converted into an additional flat, both flats become classifiable as Class 2 or, depending on their use, possibly Class 3.

Class 5

Class 5 buildings include: professional chambers or suites, lawyers' offices, government offices, advertising agencies and accountants' offices.

Class 6

A Class 6 building is a building where goods or services are directly sold or supplied to the public.

Service stations are Class 6 buildings. These are outlets used for the servicing of cars and the selling of fuel or other goods.

The expression 'service station' is not intended to cover buildings where panel beating, auto electrical, muffler replacement, tyre replacement and the like are solely carried out. Such buildings should be classified as Class 6, Class 7 or Class 8 buildings as the appropriate authority sees fit.

Class 7

There are three basic types of Class 7 building. The first is a carpark as defined in the BCA. The second is a building used for storage, often referred to as a 'warehouse'. The third is a building used for the display of goods or produce for sale by wholesale. 'Wholesale' means sale to people in the trades or in the business of 'on-selling' goods and services to another party (including the public).

Class 8

The most common way to describe a Class 8 building is as a 'factory'. However, this can give a simplistic impression of the types of building which can fall within this classification.

For example:

- some laboratories, despite their often small size, have been included as Class 8 buildings principally because of their high fire hazard;
- buildings used for altering or repairing (except service stations, which are specifically included in [A3.2](#) as Class 6 buildings);
- potteries;
- food manufacturers (but not restaurants, which are specifically included in [A3.2](#) as Class 6 buildings); and
- buildings used for the packing of produce.

Class 9a

Class 9a buildings are health-care buildings, including day-care surgeries or procedure units and the like. See definition of health-care building.

Laboratories which are part of a Class 9a building are Class 9a, despite the general classification of laboratories as Class 8 buildings.

Class 9b

Class 9b buildings are assembly buildings. These buildings can include:

- theatres, cinemas and halls, churches, schools, early childhood centres, kindergartens, preschools and child-minding centres;
- indoor cricket, tennis, basketball centres and sport stadiums;
- nightclubs, discotheques, bar areas providing live entertainment and/or containing a dance floor, public halls, dance halls and other places of entertainment;
- snooker halls;
- bus and railway stations.

Class 9c

Class 9c buildings are aged care buildings which may contain residents who have various care level needs.

The Class 9c classification recognises that many residents progress through a continuum of care needs from low to high. Many older people enter residential care with low care needs, but, as they age, require higher levels of care. In the past, such progression often necessitated the transfer of a hostel resident to a nursing home. This frequently had negative consequences for the health and well-being of the resident, for whom the hostel accommodation was home. It also led, at times, to the separation of couples with differing care needs.

Building designers should note that Class 3 buildings include hostels for the accommodation of the aged, and Class 9a buildings include nursing homes. It is important to be aware, however, that construction of Class 3 or 9a buildings may restrict the options available to the operators of a facility in relation to the profile of the residents they wish to accommodate. Where the potential exists for residents of varying care needs to be accommodated, consideration of the Class 9c provisions may be appropriate. The Class 9c classification allows for any mix of low and high care residents and is intended to allow the mix to change, as the residents' care needs change over time, without the need to obtain any further consent or approval from the appropriate authority.

Multi-care level facilities are for residents who may require the full range of care services outlined by the Aged Care Act. Hence, it is not intended to restrict the resident type and provides maximum flexibility for service providers, residents and the community.

The BCA provisions for Class 9c aged care buildings are based on minimal on-site staff being available at any time. However, it is recognised that the staff numbers vary throughout the course of any one day, due to the care needs of the residents and the functioning of the facility. It is also recognised that the specific care needs of the residents may result in a greater minimum number of staff.

Class 10a

Class 10a buildings are non-habitable buildings. See [Figure A3.2\(3\)](#) for an indication of some Class 10 building configurations.

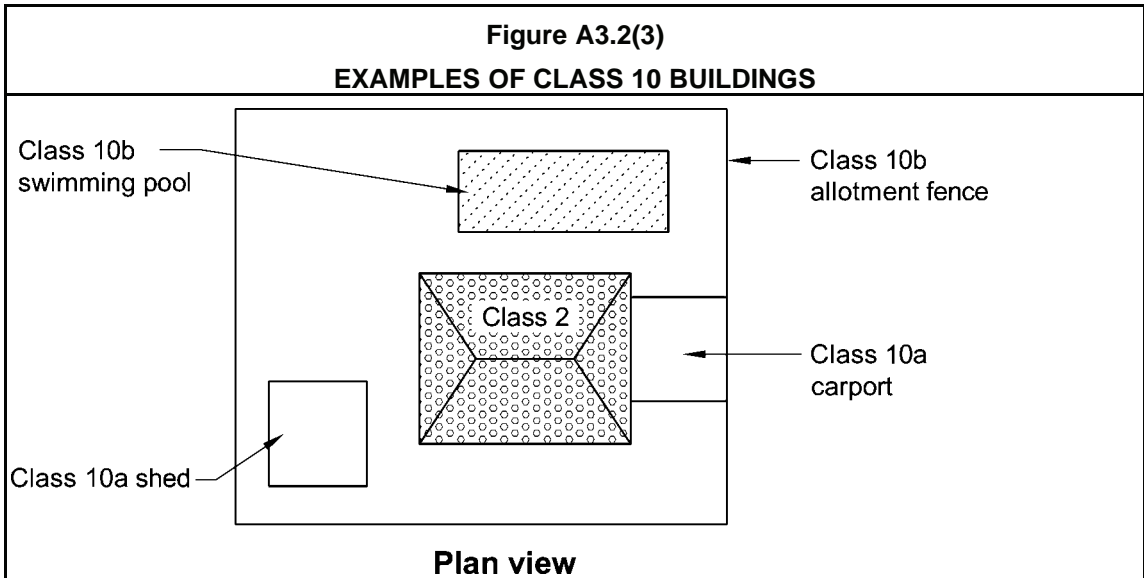

Class 10b

Class 10b structures are non-habitable structures.

There is no requirement for Class 10 buildings to be appurtenant to a building of any other class. For example, a small shed standing on its own on an allotment and a toilet block in a park.

A habitable 'outbuilding' which is appurtenant to another building is generally part of that building. Again, habitable 'outbuildings' cannot be classified as Class 10 buildings.

Examples

- A sleepout on the same allotment as a Class 2 building is part of the Class 2 building.
- A detached entertainment room on the same allotment as a Class 2 building, perhaps associated with a swimming pool, is part of the Class 2 building.
- A small toolshed, used for trade-related hobbies for non-commercial purposes or home repairs, on the same allotment as a Class 2 building, would be classified as a Class 10 building.

Class 10c

Provisions relating to Class 10c structures are only intended to address private bushfire shelters associated with a single Class 1a dwelling. These provisions are contained in Volume Two of the BCA.

Some States or Territories may exempt some Class 10 buildings or structures (often on the basis of height or size) from the need to have a building permit. Queries on this matter should be referred to the State or Territory body responsible for regulatory matters.

Difficult classifications

Class 2 or Class 3?

There is a fine line between a Class 2 building and a Class 3 building with a bathroom and cooking equipment in its units. For example, when does a motel unit (probably Class 3) become a holiday flat (probably Class 2) and vice versa? See comments on matters that may influence classifications at [A3.2 of this Guide](#).

In general, an assessment will be based on the most likely use of the building by appropriate authorities.

Class 3 buildings represent a higher risk level, and therefore require higher safety levels. In a case where the classification is unclear, perceived risks inherent in the use of the building will be scrutinised.

Class 6 or Class 7?

Class 7 buildings include those used to sell goods on the wholesale market, whereas Class 6 buildings are used to sell goods to the public.

Some establishments claim to sell goods to both the wholesale and retail markets. As a rule, however, if the general public has access to the building, it is considered a 'shop', and therefore a Class 6 building.

Hotel bars – Class 6 or 9b

As can be seen from the definition of a Class 6 building, it includes a hotel bar which is not an assembly building. The bar includes the bar area and associated standing and seating areas. This clarifies that the bar extends beyond the serving area to include standing and sitting areas where patrons may drink alcohol or other beverages and consume food. The exclusion of an assembly building means that a bar providing live entertainment or containing a dance floor is not considered to be Class 6, it must be considered as Class 9b. However, when that use is minor compared with the remainder of the bar, such as a piano bar or the like where patrons only listen to music and there is no dance floor, the appropriate authority should exercise judgement on the predominant use and therefore the appropriate classification of the bar.

A Class 9b building is an assembly building which is defined to include a building where people may assemble for entertainment, recreational or sporting purposes.

A building may have more than one classification (see [A3.3](#) and [A3.4](#)).

Farm buildings

In some States or Territories, appropriate authorities may classify farm buildings as Class 10a, which covers non-habitable buildings. They would only make this decision if a classification of Class 7 or Class 8 would not be more appropriate.

When making their decision they consider the building's size, purpose, operations and the extent to which people are employed in the building.

A3.3 Multiple classification

Intent

To permit a building to have more than one classification.

Under [A3.3\(a\)](#), if 10% or less of the floor area of a storey is used for a purpose which could be classified differently to the remainder of that storey, that part may be classified as being the

same as the remainder. Laboratories and sole-occupancy units in Class 2, 3 or 4 parts are excluded from this concession. The reason is that laboratories are considered to have a high fire hazard potential and classifying them with the remainder of the building could, in a majority of cases, endanger occupants of the other part of the building which have a lower fire hazard potential. Also, the intent is not to allow sole-occupancy units in Class 2, 3 or 4 parts to be regarded as another Class such as Class 6 and then not have any fire or sound insulation between the units and any other classification which may have a high fire load and could endanger the occupants of the Class 2, 3 or 4 part.

If the provisions of **A3.3(a)** are used, it should be remembered that it will still be necessary to use the occupant numbers in **Table D1.13** for the particular use of the area. Likewise, the lighting and equipment levels, people occupancy and load profiles for the area of minor use for the purposes of **Section J** must be in accordance with the use of the area.

If the storey has a very large floor area, the 10% or less concession area may also be large, even though the rest of the building is classifiable as a building which ordinarily has a lower risk potential.

Example

An example of the application of this area concession could be as follows:

- if a single storey factory has an office which takes up 8% of the whole storey's floor area, the entire building (including the office) can be classified as being Class 8; however
- if that office area takes up 12% of the storey's floor area, that area must be classified as Class 5, and the remainder of the building as Class 8.

Under **A3.3(b)** and **(c)** Classes 1a and 1b, 7a and 7b, 9a, 9b and 9c, and 10a, 10b and 10c are separate classifications, and if joined together or in close proximity may require fire separation in certain situations. In the BCA, when the designation 'a', 'b' or 'c' is not applied, the reference is to all buildings of the general class (for example, 'Class 9b' refers only to Class 9b buildings, but 'Class 9' refers to both Class 9a, Class 9b and Class 9c buildings).

Plant, machinery and lift motor rooms

Under **A3.3(d)** a plant room, machinery room, lift motor room or boiler room, have the same classification as the part of the building they are in.

These kinds of rooms do not need to be ancillary or subordinate to the part of the building they are in. (That is, the 10% criterion is not applicable).

There are specific provisions for these kinds of rooms. For example, **Section C** requires some of them to be fire separated from the remainder of the building (eg see **C2.13** with regard to elements of the electricity supply system).

A3.4 Parts with more than one classification

Intent

To permit a part of a building to have more than one classification.

Under **A3.4(a)** each part of a building (including the entire building) may have more than one classification. This means, for example, that it is permissible to classify part of a building as a Class 6/7 building, or a Class 5/6 building, or whatever is appropriate.

It is expected that this approach may be taken by a builder who is uncertain of what the precise use of a building will be after its sale, or to maximise the flexibility of the building's use.

Under **A3.4(b)** where a building has more than one classification the more stringent Class requirements will apply.

PART **A4** UNITED BUILDINGS

A4.1 When buildings are united

Intent

To specify that where adjacent buildings are joined through openings in walls, they need not meet additional requirements if they jointly comply with the BCA as if a single building.

It is not unusual for authorities to receive plans proposing the joining of two or more buildings. Joining of buildings could be achieved by breaking openings through walls, or by joining the buildings by a tunnel, bridge or covered walkway.

When joined, if the buildings jointly comply with all the requirements of the BCA applying as if they were a single building, they become a united building.

United buildings are not required to comply with additional BCA provisions. For example, any new openings do not require any form of fire protection not required of a single building.

Note, however, an external wall, which as a result of an interconnection becomes an internal wall, must comply with the requirements for an internal wall.

Interconnected buildings which do not jointly comply with all the requirements applicable to a single building, remain as separate buildings.

This raises the possible need for fire doors, or other forms of protection to be fitted to the new openings.

Multiple allotments or ownership

The BCA does not concern itself with actually prohibiting or permitting the uniting of buildings in separate ownership or on separate allotments. Such matters are dealt with by the relevant local bodies.

Example of connection by bridge

In this example, Building A is connected to Building B by bridge C. There are four different options for designing such a proposal.

The first is a united building

A, B and C are considered as a single structure and comply with the BCA.

The second is three separate buildings

A, B and C are a fire-source feature to each of the others, and are separated by fire walls with the openings protected at the points of connection. In this case, C may require independent support and separate egress to a road or open space, that is not through Buildings A or B. In this case, attention should also be paid to the length of the bridge, as regards distance of travel to an exit.

The third option is the bridge as a portion of Building A

In this option, A and C are one building, meeting all requirements of the BCA as a single or united building. B is a separate building, with suitable fire separation, including fire-doors at the point of interconnection. Bridge C could be supported off Building A, but not off Building B.

The fourth option is having the bridge as a portion of Building B

In this option, B and C are one building, meeting all requirements of the BCA as a single or united building. A is a separate building, with suitable fire separation, including fire doors at the point of interconnection. Bridge C could be supported off Building B, but not off Building A.

In some cases, C will link A and B across a public road, including laneways and the like. Special approvals may be required from various appropriate authorities. However, in such cases:

- if C is supported by means other than off A and B, such support will generally only be permitted if there is no obstruction of the public road;
- care will need to be taken in calculating the distance of travel to an exit if travel is required to be over C and the road is wide; and
- fire-separation may be necessary at each end of the bridge.

If the last stipulation is the case, the following matters need consideration:

- the bridge would probably need to be of fire-rated construction because combustible construction could provide a ready path for the transfer of fire, and non-combustible construction could, in a major fire, distort and collapse onto the road;
- the designer needs to take care that the bridge does not negate the fire separation between the storeys of the building.

A4.2 Alterations in a united building

Intent

To specify that where buildings, united in accordance with [A4.1](#), cease to be connected following alterations or any other building work, each disconnected building must comply with the BCA as a single building.

SPECIFICATION **A1.3** DOCUMENTS ADOPTED BY REFERENCE

1 Schedule of referenced documents

Intent

Provide a listing of documents in Volume One.

The documents listed in this schedule are referenced in the **Deemed-to-Satisfy Provisions** of the BCA.

Referenced documents and Australian Standards

Most referenced documents are Australian Standards, prefixed by AS. Some are jointly produced with New Zealand, and these are prefixed by AS/NZS. There are several non-Australian Standards referenced, and these are found at the end of [Table 1](#).

The adoption of referenced documents

The BCA is quite precise when specifying the version of any referenced document. New, or amendments to existing referenced Australian Standards and other referenced documents are not automatically adopted.

Documents do not become part of the BCA until they have been referenced in [Table 1](#). This enables the ABCB to review the documents and make sure they are not unduly onerous or economically inappropriate before being adopted into the BCA.

How to use Table 1

Column 1 includes the number of the referenced document. In the case of some that are not Australian Standards, it includes an identifying acronym. In several cases, references are only made to specific parts of a document. Here, the relevant part number is included.

Column 2 includes the date the document was released. This distinguishes the document from earlier and later versions.

Column 3 includes the title of the referenced document. In those cases where a specific part has been referenced, the title of the part is noted. Where amendments to the document are included, the number of the amendments are listed.

Column 4 includes the BCA provision by which the document is referenced.

Referenced documents and Deemed-to-Satisfy

No referenced documents need to be used in an Alternative Solution. However, a building proponent may use such documents if they wish. The documents could be used to show achievement with the Performance Requirements or equivalence with the Deemed-to-Satisfy Provisions.

Examples of reference documents other than Australian Standards

[AISC guidelines](#)

The Australian Institute of Steel Construction (AISC) guidelines for assessment of fire-resistance of structural members is a referenced document.

These guidelines detail requirements for the design of steel composite and non-composite members and connections to resist the effects of fire. They also explain required FRLs.

The guidelines are consistent with those being proposed by the Steel Structures Code, but have been extended to cover composite members.

ARI Standards

The two ARI standards referenced are published by the Air-Conditioning and Refrigeration Institute (ARI) in the USA.

ASTM D3018-90

The American Society for Testing and Materials (ASTM) document covers asphalt shingles which meet the Class A fire exposure tests in Test Method E108.

SPECIFICATION **A2.3** FIRE-RESISTANCE OF BUILDING ELEMENTS

1 Use of Specification A2.3

Deemed-to-Satisfy Provisions often require building elements to have an FRL. [Specification A2.3](#) explains how these FRLs are to be determined and, in conjunction with [Table 1](#), spells out how FRLs apply to specific building elements and materials.

2 Fire-resistance level

An FRL is expressed in terms of figures that cover structural adequacy, integrity and insulation.

Examples

A loadbearing wall may require an FRL of 120/60/30—meaning that in the Standard Fire Test the wall must retain its:

- structural adequacy for at least 120 minutes;
- integrity for at least 60 minutes; and
- insulation properties for at least 30 minutes.

A non-loadbearing wall, however, may require an FRL of –/120/120—meaning that in a Standard Fire Test the wall is not required to retain any structural adequacy criterion. However, the wall must maintain its:

- integrity for at least 120 minutes; and
- insulation properties for at least 120 minutes

3 AS 1530.4—Standard Fire Test

[Specification A2.3](#) requires that a prototype of an element being tested must be subjected to the Standard Fire Test, ie the Fire-resistance tests of Elements of Building Construction in AS 1530.4.

4 Non-loadbearing elements ([Clause 6](#) of [Specification A2.3](#))

A non-loadbearing element need not comply with an FRL's structural adequacy requirement.

5 [Table 1](#)—FRLs deemed to be achieved

Some building elements have been tested and their FRLs calculated. Where these are known, they are included in [Table 1](#).

Research results are generally available from the manufacturers who sponsor the tests. These results and other research will form the basis of future amendments to [Table 1](#).

In recent years, a number of the Standards Australia structural codes have included provisions for the calculation of FRLs. Some more complicated building elements have many combinations and permutations, and reference to specific Australian Standards is necessary.

SPECIFICATION **A2.4** FIRE HAZARD PROPERTIES

1 Scope

Intent

To establish the tests required by [Specification C1.10](#) and the method for predicting a material's group number and smoke growth rate index.

This clause deals with the testing to AS/NZS 1530.3 of an assembly of materials where the central core of the assembly is shielded from the effects of fire.

It also contains procedures for predicting—

- a material's group number after being tested in accordance with AS/NZS 3837.
- a material's smoke growth rate index when the material is tested in accordance with AS ISO 9705.

It is necessary to have these procedures in the BCA, as they are not covered in the referenced Standards.

2 Assemblies

2.1 General requirements

Intent

To establish the tests required by [Specification C1.10](#).

[Clause 2.1](#) deals with the installation of an assembly of materials where the central core of the assembly is shielded from the effects of fire.

2.2 Form of test

Intent

To establish the tests required for early fire-hazard properties on assemblies of materials.

[Specification A2.4](#) requires two tests in accordance with [Clause 2.2\(a\)](#) and [Clause 2.2\(b\)](#). They are respectively: AS/NZS 1530.3 for Spread-of-Flame Index and Smoke-Developed Index; and AS 1530.4 for the ability to prevent ignition and to screen the core material from free air.

The test in accordance with AS 1530.4 is conducted on assemblies, as specified in [Specification C1.10](#). It is also used to test if any material in the member or assembly may ignite during the 10 minutes specified by [Clause 2\(d\)\(iii\)](#).

2.3 Test specimens

Intent

To specify the details required for the test specimen.

The assembly to be tested must include all joints, perforations, recesses, and the like. These parts may affect not only its early fire-hazard properties, but are also more likely to affect the passage of air and fire to the assembly's inner core. The requirements for the test specimen apply to both tests required by [Clause 2](#).

2.4 Concession

Intent

To provide a concession for the re-testing of joints, perforations, recesses, and the like which have been previously tested.

[Clause 2.4](#) is based on the assumption that [Clause 2.2](#) tests would be passed by joints, perforations and recesses, which will be smaller in the building member to be used on site than those in the member tested. The concession in [Clause 2.4](#) applies to both the tests in [Clause 2.2](#).

2.5 Smaller specimen permitted

Intent

To allow smaller test specimens when testing for the ability to prevent ignition and screen the core material from free air when appropriate.

The smaller test specimen allowed by [Clause 2.5](#) only applies to the AS 1530.4 test required by [Clause 2.2\(b\)](#).

The smaller test specimen is allowed for practical reasons in the test rig. This is on the basis that the test will affect the specimen in an identical manner to the on-site building member.

The results from a smaller test specimen are limited to those specified by the testing laboratory. In accordance with [Specification A2.4](#), only a Registered Testing Authority may conduct the test.

3 Predicting a material's group number

Intent

To provide a procedure for predicting a material's group number, using data gained from testing the material in accordance with AS/NZS 3837.

[Clause 4](#) of [Specification C1.10](#) specifies the permitted material groups for wall and ceiling linings. A material's group number can be determined by testing the material to AS ISO 9705 or AS/NZS 3837. AS ISO 9705 contains the procedure for determining the material's group number, based on the test data. AS/NZS 3837 contains the methodology for obtaining the data, but doesn't contain the procedure for using the data and predicting the material's group number. [Clause 3](#) of [Specification A2.4](#) contains this procedure.

4 Predicting a material's smoke growth rate index (SMOGR_{RC})

Intent

To provide a procedure for predicting a material's smoke growth rate index (SMOGR_{RC}), using data obtained by testing the material in accordance with AS ISO 9705.

Clause 4 of **Specification C1.10** specifies the maximum smoke growth rate index (SMOGR_{RC}), for wall and ceiling linings. To determine a material's smoke growth rate index (SMOGR_{RC}), the material needs to be tested in accordance with AS ISO 9705. AS ISO 9705 contains the methodology for obtaining the data, but doesn't contain the procedure for converting the data into the material's smoke growth rate index (SMOGR_{RC}). **Clause 4** of **Specification A2.4** contains this procedure.

SECTION **B**

STRUCTURE

B1 Structural Provisions

SECTION B CONTENTS

SECTION B STRUCTURE

PART B1 Structural Provisions

Objective BO1

Functional Statements BF1.1 - BF1.2

Performance Requirements BP1.1 - BP1.3

B1.0 Deemed-to-Satisfy Provisions

B1.1 Resistance to actions

B1.2 Determination of individual actions

B1.3 * * * * *

B1.4 Determination of structural resistance of materials and forms of construction

Specifications

Specification B1.2 Design of Buildings in Cyclonic Areas

PART B1 STRUCTURAL PROVISIONS

Objective

BO1

The Objective is based on the belief that people should not be subject to risk of injury from a building suffering structural failure—**BO1(a)**. Nor should there be any amenity loss caused by structural behaviour—**BO1(b)**. Additionally, other property should not be at risk of physical damage caused by structural failure—**BO1(c)** and people should be safeguarded from injury due to failure or impact with glazing — **BO1(d)**.

The term “structural behaviour” as used in **BO1(b)** can describe deflections, creep, vibration, settlement and the like. Problems with structural behaviour fall short of actual structural failure.

Example

A building could have excessive deflection of a window lintel which causes the glass to shatter. This could interfere with the building’s use without causing it to collapse.

“Loss of Amenity” refers to the loss of a person’s ability to use a building in the manner intended.

Example

Structural deflections could cause a building’s doors to stick, and thus detract from a person’s ability to move about the building.

Functional Statement

BF1.1

In order to achieve **BO1**, a building must withstand any combination of loads to which it may reasonably be subjected. **BF1.1** clarifies that the BCA structural provisions are intended to cover buildings and structures.

BF1.2

Glazing in a building should not cause injury to people due to its failure or people impacting with it because they did not see it.

Performance Requirement

BP1.1

BP1.1 consists of two parts:

- performance attributes that a building is required to have; and
- a list of actions to be considered in association with these attributes.

Performance attributes

BP1.1(a) uses the term "with appropriate degrees of reliability" which can be judged with due regard to the possible consequences of failure and the expense, level of effort and procedures necessary to reduce the risk of failure. The measures that can be taken to achieve the appropriate degree of reliability include:

- choice of a structural system, proper design and analysis;
- implementation of a quality policy;
- design for durability and maintenance; and
- protective measures.

Degrees of reliability of structural elements can be quantified in terms of probabilities of failure with the use of probabilistic models for actions and resistances.

BP1.1(a)(i) is concerned with the serviceability limit states of buildings in terms of local damage, deformation and vibration. Expected actions are actions with high probabilities of occurrence. The acceptable level of serviceability is subjective. The design for serviceability depends to a large extent on professional judgement. The risk of serviceability failure is, historically, of the order of 10^{-1} to 10^{-2} .

BP1.1(a)(ii) is concerned with the ultimate limit states of buildings in terms of strength and stability. Extreme actions are actions with low probability of occurrence. Repeated actions are actions, with high frequencies of occurrence in a given time period, that may cause fatigue or other cumulative failures. The notional probability of failure of structural elements is of the order of 10^{-3} to 10^{-4} for a 50 year reference period. The probability of structural failure is historically of the order of 10^{-6} per year.

BP1.1(a)(iii) is concerned with consequences of unspecified actions and is often referred to as "structural robustness". It includes, but is not limited to, progressive collapse. Ways to improve structural robustness include providing redundancies, minimum resistances, protective measures, etc.

BP1.1(a)(iv) is concerned with damage to other properties, which may be caused by reasons other than structural if BP1.1(a)(i) to (iii) are met.

List of actions

BP1.1(b) lists actions to which a building "may reasonably be subjected". All possible actions cannot be listed. "Engineering judgement" may need to be used to determine all likely actions and in assessing the likely effects of those actions.

Example

Buildings and structures should be able to withstand the effects of wind, rain or snow. However, they would not be expected to withstand the impact of a crashing aeroplane.

BP1.1(b)(xiv) uses the defined term "construction activity actions". The term only refers to construction activities that may have an effect on the final design such as stacking or propping.

The safety of the building during construction is normally controlled by occupational health and safety authorities.

BP1.2

BP1.2 states the principles for the determination of the structural resistance of materials and forms of construction.

It should be noted that the construction activities referred to in **BP1.2(a)** may be more than those contained in the defined term of “construction activity actions”. For example, welding of structural steel might cause distortion or change the characteristics of the steel, and hence need to be accounted for. For this reason, the defined term has not been used in **BP1.2(a)**.

BP1.3

Glazing in a building is not always readily visible to all people. It is therefore important to avoid human impact where possible. This may not always be possible. **BP1.3** therefore contains three parts:

- if glazing is broken due to human impact, it must fail in so that small pieces will not cause injury to people (**BP1.3(a)**);
- if human impact could occur, the glazing should be of a strength to resist that impact without breaking (**BP1.3(b)**); and
- to make it more visible, glazing should be marked with a motive or the like (**BP1.3(c)**).

PART B1 STRUCTURAL PROVISIONS

Deemed-to-Satisfy Provisions

B1.0 Deemed-to-Satisfy Provisions

Intent

To clarify that **BP1.1** to **BP1.3** will be satisfied if compliance is achieved with **B1.1**, **B1.2**, and **B1.4**.

Where a **Building Solution** is proposed to comply with the **Deemed-to-Satisfy Provisions**, the requirements of **BP1.1** to **BP1.3** may be satisfied by complying with **B1.1**, **B1.2**, and **B1.4**.

Where a Building Solution is proposed as an Alternative Solution to the Deemed-to-Satisfy Provisions, the relevant Performance Requirements must be determined in accordance with **A0.10**. (See comment on **A0.10**).

B1.1 Resistance to actions

Intent

To specify the method of achieving compliance with **BP1.1** and **BP1.2**.

A building or structure must be designed to resist the most critical effect resulting from different combinations of actions. The actions must be combined taking into account the characteristics of the actions and the probability of the simultaneous occurrence of two or more actions. The levels of reliability of the structure when subject to combined actions should be consistent with the levels of reliability implicit in the design events for natural phenomenon (see comments on **Table B1.2(b)**). When designing for the maximum combined actions, a principle frequently adopted is that the maximum is likely to occur when at least one of the actions is at its maximum value.

B1.2 Determination of individual actions

Intent

To specify the principles for the determination of each action referred to in **BP1.1(b)** using the 2002 editions of AS/NZS 1170 Parts 0, 1, 2 and 3, and the 2007 edition of AS 1170 Part 4.

Construction activity actions

The term “construction activity action” only refers to construction activities that may need to be accounted for in the final design such as stacking of materials and floor to floor propping.

Windows forming part of a barrier

A window forming part of a barrier is not required to comply with AS/NZS 1170.1. However, a window serving as a barrier must comply with the glazing assembly provisions of AS 2047 or AS 1288. These provisions consider the wind loading on the glass and human impact requirements.

Table B1.2a

A generic description of building types has been provided to which Importance Levels have been assigned. The “Importance Level” concept is applicable to building structural safety only. More specific examples are provided in the following Table. The examples are not exhaustive.

Importance Level	Examples of building types
1	Farm buildings Isolated minor storage facilities Minor temporary facilities.
2	Low rise residential construction Buildings and facilities below the limits set for Importance Level 3.
3	Buildings and facilities where more than 300 people can congregate in one area. Buildings and facilities with a primary school, a secondary school or day care facilities with a capacity greater than 250. Buildings and facilities with a capacity greater than 500 for colleges or adult educational facilities Health care facilities with a capacity of 50 or more residents but not having surgery or emergency treatment facilities Jails and detention facilities Any occupancy with an occupant load greater than 5000 Power generating facilities, water treatment and waste water treatment facilities, any other public utilities not included in Importance Level 4 Buildings and facilities not included in Importance Level 4 containing hazardous materials capable of causing hazardous conditions that do not extend beyond property boundaries.
4	Buildings and facilities designated as essential facilities Buildings and facilities with special post disaster functions Medical emergency or surgery facilities Emergency service facilities: fire, rescue, police station and emergency vehicle garages Utilities required as backup for buildings and facilities of Importance Level 4 Designated emergency shelters Designated emergency centres and ancillary facilities Buildings and facilities containing hazardous materials capable of causing hazardous conditions that extend beyond property boundaries.

Importance levels must be assigned on a case by case basis.

Example

A hospital may be of Importance Level 4 if it is the only hospital in an area. The same hospital may be of Importance Level 3 if it is one of many in an area.

A general method for the determination of the Importance level of any building is to assess the hazard to human life and the impact on the public in the event of building failure as follows:

Building Importance Levels					
		Impact on the public			
		I (Low)	II (Moderate)	III (Substantial)	IV (Extreme)
Hazard To Human Life	A (Low)	1	2	2	3
	B (Moderate)	2	2	3	3
	C (Substantial)	2	3	3	4
	D (Extreme)	3	3	4	4

The annual probability of exceedance varies with the type of action.

Example

Building failures due to earthquake or cyclone may be widespread and therefore have more impact on the public than say thunderstorms, that affect relatively smaller areas.

Table B1.2b

The annual probabilities of exceedance in **Table B1.2(b)** originated from calibrations derived from experience with minor adjustments carried out to achieve consistency.

In cyclonic areas (wind regions C and D as described in AS/NZS 1170.2) it is necessary for metal roof assemblies to be tested in accordance with **Specification B1.2**. (See **B1.2(c)(iii)**).

B1.3 * * * * *

The content of **B1.3**, which existed in BCA 2009, has been removed. The provision number **B1.3** has been retained without text so as not to change the numbering of the current BCA from that of BCA 2009.

B1.4 Determination of structural resistance of materials and forms of construction

Intent

To specify deemed-to-satisfy materials and forms of construction.

If the materials and construction listed in **B1.4** are used, they must comply with the requirements outlined in the relevant sub-clauses.

The structural performance of a building is dependent, not only on the determining of the applicable actions, but also on the methods used to determine resistance to those actions. **B1.4** provides a list of material design standards that can be used together with **B1.2**.

The weight of roof or ceiling insulation, particularly if additional ceiling insulation is used for compliance with the energy efficiency provisions, needs to be considered in the selection of plasterboard, plasterboard fixings and building framing.

For designers seeking structural compliance via “Alternative Solutions”, a major principle in determining structural resistance is that the reliability level of the structure or its components may be at least equal to that already achieved in the Deemed-to-Satisfy Provisions. For a more complete explanation, the reader is referred to ISO 2394—General principles on reliability of structures.

B1.4(h) clarifies which type of glazed assemblies must comply with AS 2047 and which must comply with AS 1288. The reference to heritage windows is intended to apply to windows in heritage buildings. The method of determining a heritage building is normally covered by the appropriate State or Territory authority.

The use of toughened and some heat strengthened glass may involve a relatively small risk of breakage resulting from nickel sulphide (NiS) inclusions. Breakage may cause the glass to dislodge from the opening potentially causing injury to people or property damage. As set out in **B1.4(h)(iii)**, glass must be selected to minimise this risk. .

Heat soaking referred to in **B1.4(h)(iii)(D)(aa)** will significantly reduce but not totally eliminate the risk of fracture due to nickel sulphide. Heat soaked thermally toughened soda lime silicate safety glass has a safer breakage behaviour when compared with annealed glass. It also has a known level of residual risk of spontaneous breakage arising from the possible presence of critical nickel sulphide inclusions in the thermally toughened soda lime silicate glass.

Suitable protection, referred to in **B1.4(h)(iii)(D)(bb)**, could be considered to be a projection provided by a balcony or awning that extends from the building an appropriate distance in relation to the height of the adjacent glazed panel.

B1.4(i) only applies where a “primary building element” is considered susceptible to attack by subterranean termites. “Primary building element” excludes from the coverage of **B1.4(i)** building elements which may provide some bracing to a wall, but it is not required as part of their primary function. An example would be plasterboard not required for bracing or external cladding.

B1.4(i)(i) deems that several specified primary building elements are not subject to termite attack.

B1.4(i)(ii) only requires the attachment of a notice regarding the method or system used to protect against termite attack where that method or system is one described in AS 3660.1.

SPECIFICATION **B1.2** DESIGN OF BUILDINGS IN CYCLONIC AREAS

1 Scope

Intent

To clarify that Specification B1.2 contains requirements for the design of metal roofing cladding assemblies in cyclonic areas.

This specification must be read in conjunction with the provisions of AS/NZS 1170.2. The ABCB commissioned research to establish a national consistent testing regime for metal roof cladding assemblies in cyclonic areas. The results of this research are contained in Specification B1.2.

2 Roof cladding assemblies

Intent

To define the expected performance of roof cladding assemblies in cyclonic areas when subjected to the specified test regime (Table 1).

Strength performance of roofing system

Low cycle fatigue cracking of metal roof cladding elements during tropical cyclones is a complex process where small changes in load, geometry or material properties can significantly affect the fatigue performance of the cladding system (includes immediate supports, fixings and cladding). The consequences of failure of an element can quickly lead to more elements progressively failing. These failed elements become wind driven debris and so pose a threat to people and other structures as potential missiles.

Table 1

The fatigue loading sequence defined in Table 1 is to simulate the wind load induced by a cyclonic event. In order to have a repeatable standard test that can be performed by different testing laboratories within a reasonable time frame on different types of test equipment, the loading sequence is a simplification of the dynamic wind loading environment. In the formulation of the fatigue loading sequence assumptions such as cyclone counts, load range, cyclone duration, wind direction change, building orientation and building geometry have been made.

If a system does not successfully resist the fatigue loading sequence in Table 1, it does not comply.

The test section consists of cladding elements, fastenings and immediate supporting members assembled together in a manner identical to those parts of the particular roof which the test section is intended to replicate.

FIRE RESISTANCE

- C1** **Fire Resistance and Stability**
- C2** **Compartmentation and Separation**
- C3** **Protection of Openings**

SECTION C CONTENTS

SECTION C FIRE RESISTANCE

Section C Fire Resistance

Objective CO1
Functional Statements CF1 - CF2
Performance Requirements CP1 - CP9
Verification Methods CV1 - CV2

Part C1 Fire Resistance and Stability

C1.0 Deemed-to-Satisfy Provisions
C1.1 Type of construction required
C1.2 Calculation of rise in storeys
C1.3 Buildings of multiple classification
C1.4 Mixed types of construction
C1.5 Two storey Class 2, 3 or 9c buildings
C1.6 Class 4 parts of buildings
C1.7 Open spectator stands and indoor sports stadiums
C1.8 Lightweight construction
C1.9 * * * * *
C1.10 Fire Hazard Properties
C1.11 Performance of external walls in fire
C1.12 Non-combustible materials

Part C2 Compartmentation and Separation

C2.0 Deemed-to-Satisfy Provisions
C2.1 Application of Part
C2.2 General floor area and volume limitations
C2.3 Large isolated buildings
C2.4 Requirements for open spaces and vehicular access
C2.5 Class 9a and 9c buildings
C2.6 Vertical separation of openings in external walls
C2.7 Separation by fire walls
C2.8 Separation of classifications in the same storey
C2.9 Separation of classifications in different storeys
C2.10 Separation of lift shafts
C2.11 Stairways and lifts in one shaft
C2.12 Separation of equipment
C2.13 Electricity supply system
C2.14 Public corridors in Class 2 and 3 buildings

Part C3 Protection of Openings

C3.0 Deemed-to-Satisfy Provisions
C3.1 Application of Part
C3.2 Protection of openings in external walls

- C3.3 Separation of external walls and associated openings in different fire compartments
- C3.4 Acceptable methods of protection
- C3.5 Doorways in fire walls
- C3.6 Sliding fire doors
- C3.7 Protection of doorways in horizontal exits
- C3.8 Openings in fire-isolated exits
- C3.9 Service penetrations in fire-isolated exits
- C3.10 Openings in fire-isolated lift shafts
- C3.11 Bounding construction: Class 2, 3 and 4 buildings
- C3.12 Openings in floors and ceilings for services
- C3.13 Openings in shafts
- C3.14 * * * * *
- C3.15 Openings for service installations
- C3.16 Construction joints
- C3.17 Columns protected with lightweight construction to achieve an FRL

Specifications

- Specification C1.1 Fire-Resisting Construction
- Specification C1.8 Structural Tests for Lightweight Construction
- Specification C1.10 Fire Hazard Properties
- Specification C1.11 Performance of External Walls in Fire
- Specification C2.5 Smoke-Proof Walls in Health-Care and Aged Care Buildings
- Specification C3.4 Fire Doors, Smoke Doors, Fire Windows and Shutters
- Specification C3.15 Penetration of Walls, Floors and Ceilings by Services

SECTION C FIRE RESISTANCE

Objective

CO1

Basis of Objective

This Objective is based on the belief that a building should:

- provide people with an environment which, during a fire, will minimise the risk of them suffering illness or injury;
- provide people with an evacuation route which will minimise the risk of them suffering illness or injury while escaping a fire;
- facilitate the role of emergency services personnel, such as the fire brigade, if it becomes necessary for them to undertake such operations as fire-fighting and search and rescue;
- assist in minimising the risk of fire spreading from one building to another; and
- not have a structural failure during a fire that results in damage to another building, allotment or road.

Spread of fire

There is a continuing debate regarding the means by which the BCA should minimise the risk of fire spreading from one building to another. Should the greater degree of fire protection be in the building on fire, or should it be in the building at potential risk of the fire spreading?

Generally, the BCA provisions aim to minimise the spread of fire from the building on fire, but there are some provisions that limit the spread of fire from an adjacent building.

Consequently, **CO1(d)** states that the spread of fire is to be avoided “between buildings”—that is, in either direction.

Protection of other property

The BCA is principally designed to maximise (within reasonable bounds) the safety, health and amenity of people in and around buildings. Protection of property, either the subject building or what is termed “other property”, is not generally a primary aim of the BCA—although it may sometimes be a consequence of the provisions of the BCA.

However, there are some exceptions to this rule, and the inclusion of “other property” in **CO1(e)** is one of these. In this context, a building is expected to maintain the level of structural sufficiency necessary to prevent it causing damage to any other property as a result of fire. The reason **CO1(e)** concerns itself with the protection of other property is primarily because fire from a building should not pose a serious risk to the health, safety and amenity of the public or occupants of another building. See **A1.1** for definition of “other property”.

Functional Statements

CF1

Structural stability

A building must remain structurally stable during a fire to:

- allow the occupants to safely evacuate;
- allow the fire brigade to undertake search and rescue, if necessary, and fire-fighting operations; and
- avoid damage to another building, allotment or road.

Instability may not contravene the BCA

So long as a building does not endanger life or other property, and the BCA's structural stability criteria have been satisfied, then the building may become structurally unstable after a fire and still comply with the objectives of [Section C](#). It could even collapse, provided none of the building falls in a way that endangers the public or causes damage to another building. For example, if a building falls onto a road, it could endanger the safety of the public and would therefore not achieve the Functional Statement.

CF2

Spread of fire

A building must have in-built safeguards to prevent the spread of fire:

- to allow sufficient time for the occupants to safely evacuate;
- to allow the fire brigade to undertake search and rescue, if necessary, and fire-fighting operations;
- in Class 2 or Class 3 buildings or Class 4 parts used as sole-occupancy units that provide sleeping accommodation to allow sufficient time for the occupants to safely evacuate;
- to an adjoining fire compartment; and
- from one building to another building.

Spread of fire may not contravene the BCA

So long as a building fire does not endanger life or other property, and the BCA's spread of fire criteria have been satisfied, then the building may burn and still comply with the aims of [Section C](#).

Performance Requirements

CP1

Structural stability required during fire

CP1 sets structural stability requirements for building elements during a fire.

CP1 does not make any reference to a fire-resistance level (FRL). FRLs are only included as part of the Deemed-to-Satisfy Provisions.

It may be found by a building proponent using an Alternate Solution that FRLs to building elements are not necessary as other means, such as the use of active systems, satisfy the Performance Requirements.

“To the degree necessary”

CP1 uses the term “to the degree necessary”. This word usage is designed to provide flexibility in the way this provision is implemented. The intended meaning of the term “to the degree necessary” in **CP1** and other Performance Requirements, is explained in **A1.7**.

It means that the BCA recognises that different building elements require differing degrees of structural stability during a fire. The expression is intended to allow the appropriate authority to determine the degree of compliance necessary in each particular case.

Any decision made in this context can extend to not requiring an item to be installed or a particular level of performance to be achieved, if that is the appropriate action to be taken.

“Appropriate to”

The structural stability must be “appropriate to” the criteria listed in **CP1**, which relate to such factors as:

- the likelihood or risk of a fire occurring in the building;
- the load, intensity and potential danger of any fire in the building;
- the difficulty of evacuation and/or rescue;
- a structural element’s exposure to fire in another building, or risk of spreading a fire to another building;
- the fire safety systems in the building, which can affect the rate of fire spread (eg if a sprinkler system is installed in a building, it could either extinguish the fire or reduce its growth rate);
- the size of a fire and the difficulties in effecting an evacuation;
- the fire-fighting operations of the fire brigade; and
- the consequences of the failure of the element (another way of expressing this is to consider that if the element fails, could it result in the failure of another element).
- the time taken from the start of the emergency to the occupants reaching a safe place.

While assessment of a building proposal must have regard to the differing needs of each building element, the proposal must make sure that the elements have an appropriate structural stability during a fire so that:

- the fire does not endanger the occupants by entering escape routes; and
- the fire does not endanger fire fighters while they are undertaking search and rescue operations.

Examples

The following are two examples of what may or may not be “appropriate”. They should not be regarded as absolute, or applicable in all circumstances.

Commercial poultry building

The building concerned is a commercial poultry building which is single storey and occupied by only a few workers, who are likely to know the building well. The building is situated a long distance from any other building and has direct routes to the exit doors.

In such a case, the building elements may not need to be fire protected under **CP1** because the occupants would be able to evacuate quickly and if the building collapses, there is little likelihood of it damaging another building.

High-rise office building

The building concerned is a central city high-rise office building. It is located on the street alignment and close to other similar buildings. In such a case, the structural failure of any of the building elements could lead to danger to building occupants and the general public, failure of building elements intended to protect another building, or the collapse of another element which relies on the first element for structural support.

In this example, building elements may require a high level of protection under **CP1**.

In both cases, the ability of the fire brigade to control a fire also needs to be considered when considering the implications of **CP1**.

If the proposal being considered involves a Building Solution that is taking advantage of the Deemed-to-Satisfy Provisions, the Deemed-to-Satisfy Provisions contain detailed requirements for the fire protection of building elements.

If an Alternative Solution to the Deemed-to-Satisfy Provisions in **Section C** is being used, it may be appropriate to assess it using the **Section C** Deemed-to-Satisfy Provisions for guidance purposes. It is stressed, however, that compliance with the Deemed-to-Satisfy Provisions is not compulsory if alternative means can be found to satisfy the appropriate authority that the Performance Requirements will be achieved. The building proponent should refer to **A0.9** for guidance on acceptable assessment methods for determining compliance with the Performance Requirements.

CP2

Spread of fire

CP2 deals with the spread of fire both within the building and between buildings, and which does not only result from the structural failure of a building element.

CP2 does not make any reference to a fire-resistance level (FRL). FRLs are only included as part of the Deemed-to-Satisfy Provisions. However, proponents of an Alternative Solution should note, if they so wish. See **CF2**.

CP2(a)(i) aims to avoid a situation where fire either endangers occupants evacuating by way of exits, or impedes the capacity of emergency services personnel to access the building and fight the fire or rescue occupants.

CP2(a)(ii) aims to minimise the risk of people in Class 2 and Class 3 buildings and Class 4 parts, for example, if they were sleeping and consequently having difficulty escaping a fire. For this reason, **CP2(a)(ii)** requires that sole-occupancy units and corridors used for escaping be provided, to the degree necessary, with protection to avoid the spread of fire.

CP2(a)(iii) aims to minimise the risk of fire spreading from one building to another that could endanger the occupants of both buildings and impede the actions of the fire brigade. See **CV1** and **CV2** for two means of verifying, under certain circumstances, whether or not the requirements of **CP2(a)(iii)** will be achieved. Other assessment methods for determining compliance with the Performance Requirements are in **A0.9**.

CP2(a)(iv) aims to minimise the risk of fire spreading through a building that could endanger the occupants, and impede the actions of the fire brigade.

CP2(a) uses the term “to the degree necessary”. This word usage is designed to provide flexibility in the way this provision is implemented.

It means that the BCA recognises that different building elements require differing degrees of protection to avoid the spread of fire. The expression is intended to allow the appropriate authority to determine the degree of compliance necessary in each particular case after considering each building scenario.

Any decision made in this context can extend to not requiring an item to be installed or a particular level of performance to be achieved, if that is the appropriate action to be taken.

Building elements must be appropriate to avoid spread of fire, taking into consideration the matters listed in **CP2(b)** including:

- the likelihood or risk of a fire occurring in the building;
- the size, load or intensity of any fire in the building;
- the difficulty of evacuation and/or rescue;
- the building's exposure to fire in another building, or risk of spreading a fire to another building;
- the fire safety systems in the building, which can affect the rate of fire spread (eg if a sprinkler system is installed in a building, it will either extinguish the fire or reduce its growth rate);
- the size of a fire and the difficulties in effecting an evacuation;
- the fire-fighting operations of the fire brigade and the resources available to it;
- the consequences of the failure of the element (another way of expressing this is to consider that if the element fails, could it result in the failure of another element); and
- the time taken from the start of the emergency to the occupants reaching a safe place.

If an Alternative Solution to the Deemed-to-Satisfy Provisions in **Section C** is being used, it may be appropriate to assess it using the **Section C** Deemed-to-Satisfy Provisions for guidance purposes. It is stressed, however, that compliance with the Deemed-to-Satisfy Provisions is not compulsory if alternative means can be found to satisfy the appropriate authority that the Performance Requirements will be achieved. The building proponent should refer to **A0.9** for guidance on acceptable assessment methods for determining compliance with the Performance Requirements.

Examples

The following are two very simple examples of what may or may not be "appropriate". They should not be regarded as absolute, or applicable in all circumstances.

Commercial poultry building

The building concerned is a commercial poultry building which is single storey and is occupied by only a few workers, who are likely to know the building well. The building is situated some distance from any other building and has direct routes to the exit doors.

In such a case, the building elements may not need to be protected against the spread of fire under **CP2(a)** because the building is:

- only one fire compartment;
- people are not sleeping in the building; and
- there is little likelihood of the spread of fire to another building because of the large distance to any other building.

High-rise office building

The building concerned is a central city high-rise office building. It is located on the street alignment and close to other similar buildings.

In such a case, the spread of a fire needs to be avoided because:

- the occupants will take some time to evacuate the building, so there is a need to protect the escape routes;
- there is a need for protection from the spread of a fire between each storey, because each storey is intended to be a separate fire compartment; and
- a fire could easily spread between buildings, because they are close together.

In this example, building elements may require a high level of protection against the spread of fire under **CP2(a)**.

In both cases, the ability of the fire brigade to control a fire would also need to be considered when considering the implications of satisfying **CP2(a)**.

If the proposal being considered involves a Building Solution that is taking advantage of the Deemed-to-Satisfy Provisions, the Deemed-to-Satisfy Provisions contain detailed requirements for the fire protection of building elements.

CP3

Spread of fire and smoke in a patient care area

CP3 deals with the spread of fire and smoke within a patient care area of a Class 9a building.

If a fire occurs in a health-care building, most patients would be unable to leave their beds, or may require assistance to evacuate the building. It is therefore important that the areas of the health-care building used by patients in beds be protected from fire in another part of the building.

See definition of “health-care building” in **A1.1**.

Spread of fire and smoke in aged care buildings

CP3 also applies in Class 9c aged care buildings. In this case it applies throughout the whole building, not just in the resident use areas. This is because if a fire occurs in an aged care building, some residents would be unable to leave their beds, or may require assistance to evacuate the building.

CP4

Fire hazard properties of materials

CP4 deals with the fire hazard properties of materials used in the construction of a building. These include such matters as their smoke, toxic gas and heat generation capacities.

CP4 uses the term “to the degree necessary”. This word usage is designed to provide flexibility in the way this provision is implemented.

It means that the BCA recognises that different materials and assemblies must resist the spread of fire to limit the generation of smoke, heat and toxic gases to differing degrees, depending on the circumstances of their use. The expression is intended to allow the appropriate authority to determine the degree of compliance necessary in each particular case after consideration of the building scenario.

Any decision made in this context can extend to not requiring an item to be installed or particular level of performance to be achieved, if that is the appropriate action to be taken.

The materials used in the building must be appropriate to avoid the spread of fire and the generation of smoke, heat and toxic gases after consideration of the matters listed in **CP4**. The reason for each of these matters is as follows:

- If the occupants can evacuate in a short time, then the smoke, heat and toxic gases generated prior to the completion of the evacuation will be less likely to have an impact on the safety of the occupants than if a longer evacuation time is required.
- The number, mobility and other characteristics of the occupants influence the time taken for the evacuation of the building. If the number of occupants is large, or they are not mobile, such as patients in a hospital or residents of an elderly people's home, the evacuation time could be long. Such an evacuation time may allow the fire to develop and generate greater amounts of smoke, heat and toxic gases that will endanger the safety of the occupants trying to evacuate.
- The function or use of the building has an impact on the types of materials and linings that are part of the building's fire load. This directly influences the rate of spread of any fire in the building.
- Any active fire safety system installed in the building, such as a sprinkler system, may limit the spread of fire and allow additional time for the evacuation of the occupants.

The Deemed-to-Satisfy Provision applicable to **CP4** is **C1.10**. **C1.10** limits the early fire hazard characteristics of materials susceptible to the effects of flame or heat, particularly during the early stages of a fire.

If an Alternative Solution to the Deemed-to-Satisfy Provisions in **Section C** is being used, it may be appropriate to assess it using the **Section C** Deemed-to-Satisfy Provisions for guidance purposes. It is stressed, however, that compliance with the Deemed-to-Satisfy Provisions is not compulsory if alternative means can be found to satisfy the appropriate authority that the Performance Requirements will be achieved. The building proponent should refer to **A0.9** for guidance on acceptable assessment methods for determining compliance with the Performance Requirements.

CP5

“Tilt-up construction”

CP5 is intended to overcome a problem observed when a fire has occurred in a building of “tilt-up construction”, and the panels have collapsed outwards, either during the fire or shortly after with little or no warning, endangering public safety, health, amenity and fire fighting operations.

A wide variety of structural systems and materials are possible to achieve this.

CP5 is only applicable to walls that could collapse as complete panels and, therefore, is not applicable to concrete and clay masonry walls, and the like, because such walls tend to fail in portions, rather than as complete panels.

The height limitation of 2 storeys is based upon the observation that the problem only seems to occur in low-rise buildings. This is due to taller buildings usually having fire rated floors and other building elements to restrain wall panels during a fire.

CP6

Hazardous service equipment

Certain types of equipment installed in buildings, such as boilers and the like, have a high fire potential. Other types of equipment, such as transformers and batteries, have a high potential for explosion. **CP6** aims to minimise the risk of a fire spreading from such equipment to other parts of the building.

CP6 uses the term “to the degree necessary”. This word usage is designed to provide flexibility in the way this provision is implemented.

It means that the BCA recognises that different equipment requires differing levels of protection, depending on the circumstances within which it is used and installed. The expression is intended to allow the appropriate authority to determine the degree of compliance necessary in each particular case.

Any decision made in this context can extend to not requiring an item to be installed or a particular level of performance to be achieved, if that is the appropriate action to be taken.

CP7

Emergency equipment must continue to operate

CP7 is intended to protect emergency equipment from the spread of fire within a building. It is important that emergency equipment continues to operate to the required level during an emergency. The length of time it should continue to operate will depend on the particular equipment.

Examples

CP7 requires that the emergency equipment continue to operate for as long as it is needed. Some examples of where protection may be required include:

- the protection of central smoke control plant required to operate in a fire for sufficient time for the occupants to evacuate; and
- the protection of the power supply to emergency lifts for sufficient time for the use of the lifts.

CP7 uses the term “to the degree necessary”. This word usage is designed to provide flexibility in the way this provision is implemented.

It means that the BCA recognises that different emergency equipment requires differing levels of protection, depending on the circumstances within which it is used and installed. The expression is intended to allow the appropriate authority to determine the degree of compliance necessary in each particular case.

Any decision made in this context can extend to not requiring an item to be installed or a particular level of performance to be achieved, if that is the appropriate action to be taken.

CP8

Openings and penetrations

CP8 requires openings and penetrations in building elements to resist the spread of fire.

CP8 should be read in conjunction with **CP2**. **CP8** deals with any opening or penetration within a building element, and **CP2** deals with the building element itself.

CP8 uses the term “to the degree necessary”. This word usage is designed to provide flexibility in the way this provision is implemented.

It means that the BCA recognises that different building elements require differing levels of protection, depending on the circumstances within which they are used and installed. The expression is intended to allow the appropriate authority to determine the degree of compliance necessary in each particular case.

Any decision made in this context can extend to not requiring an item to be installed or a particular level of performance to be achieved, if that is the appropriate action to be taken.

CP9

Fire brigade access essential

The attending fire brigade must, in many cases, have access to and around a building during a fire, to undertake search and rescue and fire-fighting operations.

Access for the fire brigade should take into consideration such matters as:

- The size and type of the brigade vehicles likely to be required to fight a fire in the building. Consideration should be given to ensuring that the access is wide enough for a large fire truck, able to support the truck's weight, and incorporate a suitable hard stand area if the brigade needs to use pump units to fight the fire.
- The need for the brigade to fight the fire, considering such factors as the size and type of the building, the nature of any fire safety systems in the building, and the contents of the building.

CP9 uses the term "to the degree necessary". This word usage is designed to provide flexibility in the way this provision is implemented.

It means that the BCA recognises that buildings need different types of fire brigade access. These differences depend on the matters listed in **CP9**.

Any decision made in this context can extend to not requiring an item to be installed or a particular level of performance to be achieved, if that is the appropriate action to be taken.

Any access for the fire brigade must be appropriate to their needs and the type of vehicles and equipment to be used, having regard to the matters listed in **CP9**:

- the likelihood or risk of a fire occurring in the building;
- the size, load or intensity of any fire in the building; and
- the fire safety systems in the building, which can affect the rate of fire spread (eg if a sprinkler system is installed in a building, it will either extinguish the fire or reduce its growth rate).

Examples

The following examples indicate circumstances where fire brigade access may not be necessary:

- A small building, with a low level of occupancy and a low fire load may not require access.
- A building located in an area that does not have an operational fire service, or where the fire service is unlikely to reach the building during the course of a fire.

If the proposal being considered involves a Building Solution that is taking advantage of the Deemed-to-Satisfy Provisions, the Deemed-to-Satisfy Provisions contain detailed requirements regarding fire brigade access.

If an Alternative Solution to the Deemed-to-Satisfy Provisions in **Section C** is being used, it may be appropriate to assess it using the **Section C** Deemed-to-Satisfy Provisions for guidance purposes. It is stressed, however, that compliance with the Deemed-to-Satisfy Provisions is not compulsory if alternative means can be found to satisfy the appropriate authority that the Performance Requirements will be achieved. The building proponent should refer to **A0.9** for guidance on acceptable assessment methods for determining compliance with the Performance Requirements.

Verification Methods

CV1

Buildings on adjoining allotments

CV1 is a means to verify whether or not a building proposal achieves the requirements of **CP2(a)(iii)** in minimising the risk of fire spreading between buildings on adjoining allotments. A fire in one building should not cause the spread of fire to another building, because such fire spread potentially endangers public safety, health and amenity.

It is not compulsory for a designer to use **CV1**. The designer has the choice of using:

- **CV1** to verify that a proposal achieves **CP2(a)(iii)**;
- the Deemed-to-Satisfy Provisions of Part **C3**; or
- another means of verifying that **CP2(a)(iii)** will be achieved.

If **CV1** is used to calculate the level of heat flux, it is important to calculate the level at all the points referred to in **Table CV1**. The maximum level is not necessarily at the boundary. The size and shape of the openings will influence the level of heat flux.

Whether a material will ignite from radiant heat depends on the amount of heat and whether an ignition source (such as a spark) is present.

Examples

The following values give some typical examples of the amount of radiant heat necessary to ignite common materials used in buildings and their construction. Note, these figures should not be taken to be absolute, and may be subject to a range of variables.

- **Timber**
 - Ignition in the absence of a spark 35 kW/m²
 - Ignition in the presence of a spark 20 kW/m²
- **Curtain materials**
 - Ignition in the absence of a spark 20 kW/m²
 - Ignition in the presence of a spark 10 kW/m²

There are three mechanisms for transferring heat:

Conduction

Conduction is the transfer of heat from one source to the other when they are in contact.

Convection

Takes place when the flames or fire plume carry the heat to another body. Convection includes the carrying of embers from a burning body that can cause ignition of a second body.

Radiation

Radiation is the transfer of heat from one body to another. In essence this involves one body putting out enough heat to heat up another body without any form of contact, either directly or by way of flames or embers.

Radiation is the main mechanism for heat and fire spread between buildings.

By way of techniques developed in the field of physics, it is possible to calculate the amount of heat given off by a burning building. The answer depends on a number of factors, including:

- the distance from the building;
- the size and shape of the openings in the building;
- the temperature of the fire, which will depend on the:
 - size of the fire, and
 - type of materials burning; and
- the emissivity of any glass in openings in the building. The emissivity is, in comparatively simple terms, a measure of radiant heat reduction through a window opening. The maximum value is 1, but lower figures may be appropriate, depending on such factors as:
 - whether the opening is drencher protected, or
 - whether the opening is a fire window.

CV2

Buildings on the same allotment

CV2 is essentially the same as **CV1**, except that it deals with the spread of fire between two buildings on the same allotment.

It is not compulsory for a designer to use **CV2**. The designer has the choice of using:

- **CV2** to verify that a proposal achieves **CP2(a)(iii)**;
- the Deemed-to-Satisfy Provisions of Part **C3**; or
- another means of verifying that **CP2(a)(iii)** will be achieved.

The figures in **Table CV2** are essentially the same as those in **Table CV1**, if an assumption is made that the boundary dividing the buildings to which **Table CV1** is applied is half way between each building.

For further information on the use of **CV2**, refer to the comments on **CV1**.

PART C1 FIRE RESISTANCE AND STABILITY

Objective

Functional Statements

Performance Requirements

The Objective, Functional Statements and Performance Requirements for **Section C** are at the beginning of **Section C**.

Deemed-to-Satisfy Provisions

C1.0 Deemed-to-Satisfy Provisions

Intent

To clarify that the requirements of **CP1** to **CP9** will be satisfied if a building complies with Parts **C1**, **C2** and **C3**, and Parts **G3** and **H1**, if applicable.

Most buildings

Where a Building Solution is proposed to comply with the Deemed-to-Satisfy Provisions, **C1.0** clarifies that for most buildings compliance with Parts **C1**, **C2** and **C3** will achieve compliance with **CP1** to **CP9**. The exceptions to this general rule are as follows:

- If the building contains an atrium, it must comply with Part **G3** in addition to Parts **C1**, **C2** and **C3**.
- If the building comprises of a theatre, stage or public hall it must comply with Part **H1** in addition to Parts **C1**, **C2** and **C3**.
- If the building contains an atrium and one or more theatre, stage or public hall, it must comply with Parts **C1**, **C2**, **C3**, **G3** and **H1**.

Where a Building Solution is proposed as an Alternative Solution to the Deemed-to-Satisfy Provisions, the relevant Performance Requirements must be determined in accordance with **A0.10**. (See comment on **A0.10**).

C1.1 Type of construction required

Intent

To establish the minimum fire-resisting construction required for Class 2–9 buildings.

Minimum type of construction required

C1.1(a) sets out the minimum type of fire-resisting construction required by the **Deemed-to-Satisfy Provisions** for all Class 2–9 buildings.

C1.1(b) explains that Type A construction is the most fire-resistant, Type C construction is the least fire-resistant, and Type B construction falls between these two.

Class and height (rise in storeys)

Table C1.1 explains that the required type of construction of a building depends on risk levels as indicated by the Class of building and the building's height as indicated by the rise in storeys. Note that there could be other factors that need to be considered. For example, **C2.2** and **Table C2.2** examine the maximum permissible size of fire compartments or atriums in buildings for specific types of construction.

Class of building

The Class of building is a measure of the building's likely:

- use;
- fire load;
- population; and
- mobility of the occupants, such as whether they are sleeping or alert.

Example

Research indicates that if a fire occurs while a person is asleep, the smell of the smoke will not wake them. Response times in residential buildings are longer than in other types of buildings. The BCA thus requires a higher type of construction in residential buildings. See **Table C1.1**.

Height of building (rise in storeys)

The height (rise in storeys) of the building is relevant as a measure of likely evacuation times and evacuation difficulty.

Types of construction and Alternative Solutions

When using an Alternative Solution, Part **C1** does not apply and there is no need to refer to the types of construction. Nonetheless, if building proponents using Alternative Solutions wish to use Part **C1** as part of the solution, they can.

C1.2 Calculation of rise in storeys

Intent

To establish a method for the calculation of the rise in storeys of a building, as a means of helping determine a building's required type of construction.

What is the rise in storeys?—C1.2(a)

Under **C1.2(a)**, the rise in storeys is the sum of the greatest number of storeys at any part of the external walls of a building above ground level and any storeys within the roof space. The reason for the inclusion of any storey within the roof space is that the storey may not have any external walls such as occur with a hip roof.

C1.2(a)(i) and **(ii)** distinguish between the situation where the part of the external walls is within the allotment (in which case it is calculated above finished ground level—**C1.2(a)(i)**), or on the allotment boundary (in which case it is calculated above natural ground level at that point—**C1.2(a)(ii)**).

The rise in storeys is the criteria used to determine the type of construction. This is because the rise in storeys has an impact on:

- the risk of exposure to radiant heat from a fire in another building;
- the risk of emitting radiant heat to another building; and
- the risk to occupants who may need to travel down a stairway to safely evacuate the building.

Definition of storey

“Storey” is defined in **A1.1**. It is advisable to refer to this definition before calculating the rise in storeys of a building.

Calculation of rise in storeys

The calculation of the rise in storeys includes larger mezzanines (see **C1.2(d)(i)**) and situations where two or more mezzanines can create a similar impact to larger mezzanines (see **C1.2(d)(ii)**) because of their potential fire load.

The calculation excludes machinery or similar plant rooms at the top of the building because they do not add significantly to the building’s fire load (see **C1.2(b)(i)**) and storeys below ground level in particular circumstances outlined in **Figure C1.2(1)**. This is because basements are not exposed to radiant heat from a fire in another building, nor do they emit any significant heat horizontally.

C1.2(b)(ii) describes when storeys partly below ground level are not included in the calculation of the rise in storeys, i.e. when they are treated as basement storeys as described above. Whether a storey is to be excluded from the calculation of the rise in storeys is determined by measuring the extent of the storey above the average ground level at the external wall. If the wall is more than 12 m long, consider only the 12 m length of the wall where the average ground level is lowest. If any wall of a storey is more than 1 m above the average ground level, the storey is included in the calculation of the rise in storeys.

The height of a ceiling in a storey above the average ground level adjacent to the external wall can be determined by calculating the area between the ground level and the ceiling for the length of the wall under consideration (the actual length of the wall or 12 metres, whichever is the lesser) and dividing the area obtained by that length (see **Figure C1.2(3)**).

Class 7 or 8 with internal storey height over 6 metres—C1.2(c)

Under **C1.2(c)**, a Class 7 or Class 8 building with more than one storey above ground level (see **C1.2(c)(i)**) and which has an internal storey height of 6 metres or more is, from the point of view of potential fire load, considered to be the equivalent to 2 storeys (see **C1.2(c)(ii)**).

Examples of calculating rise in storeys

Figure C1.2(2) illustrates some examples of calculating the rise in storeys of a building.

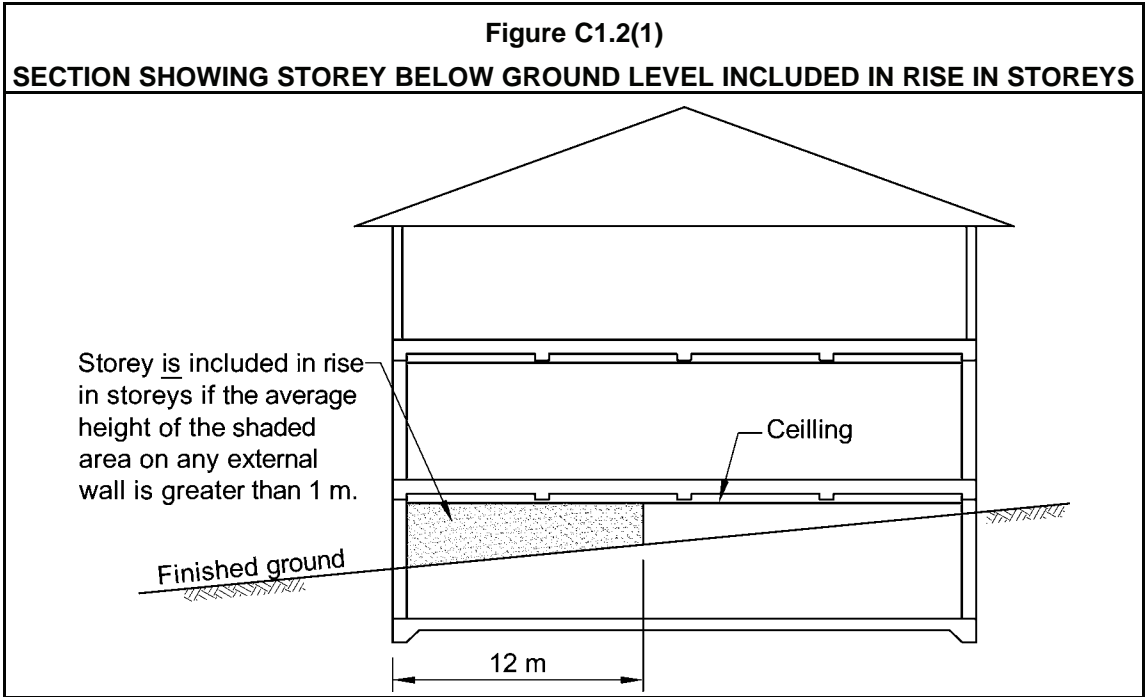
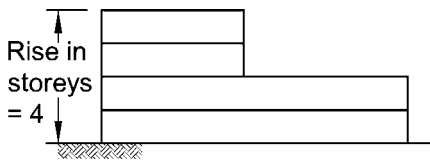
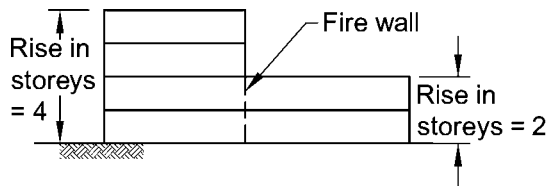

Figure C1.2(2)

EXAMPLES OF CALCULATING THE RISE IN STOREYS OF A BUILDING



(a) Considered as a single building



(b) Considered as two separate buildings

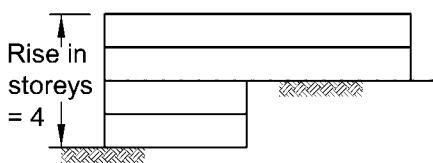

(c) Entire building considered as having a rise in storeys of 4

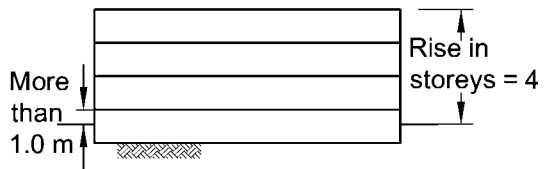

(d) Storey below ground included in calculation of rise in storeys

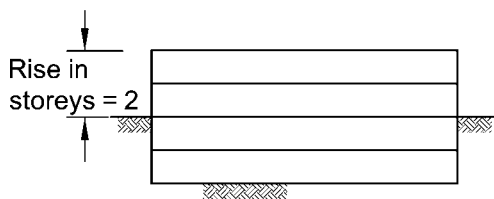

(e) Basement levels are excluded when calculating rise in storeys

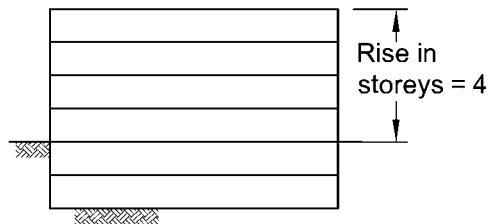

(f) Basement levels are excluded when calculating rise in storeys

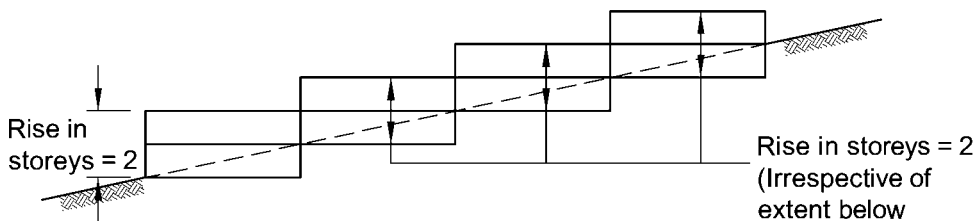

(g) Single building on sloping site

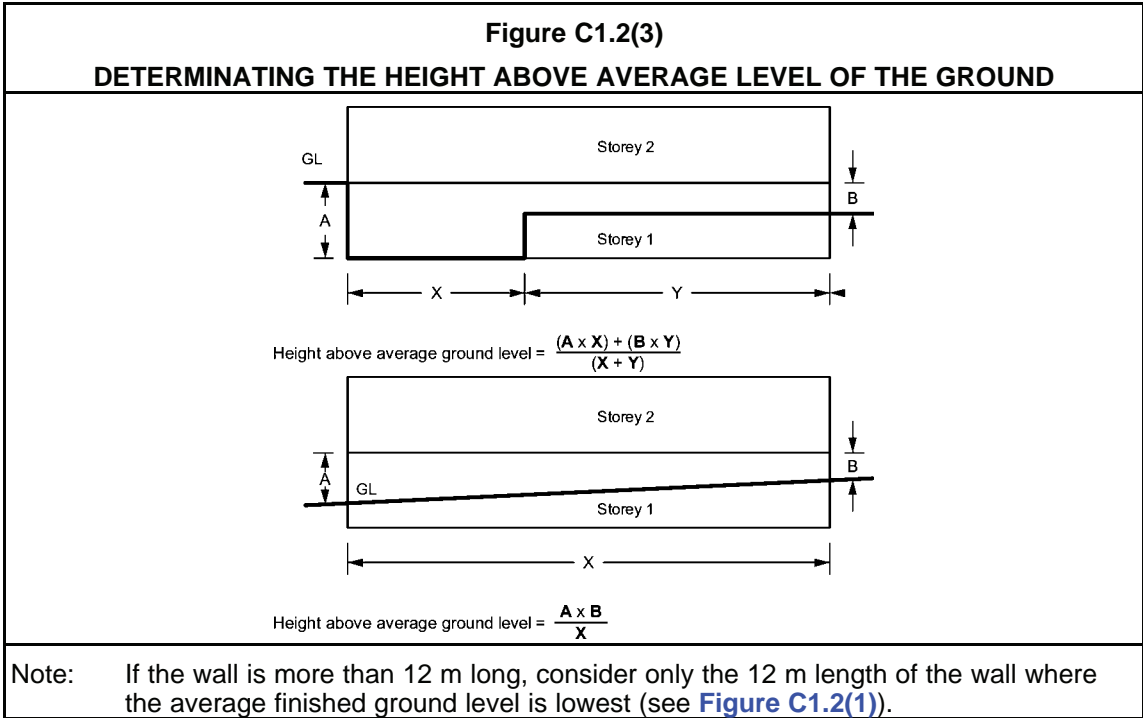

C1.3 Buildings of multiple classification

Intent

To establish the type of construction required for a building that contains more than one Class.

Procedure for determining type of construction

In a building comprising multiple classifications, the type of construction applicable to the classification of the top storey applies to all the storeys below it. [Figure C1.3\(1\)](#) illustrates this. This method is used to determine the type of construction only, and not the FRLs required for the different classifications.

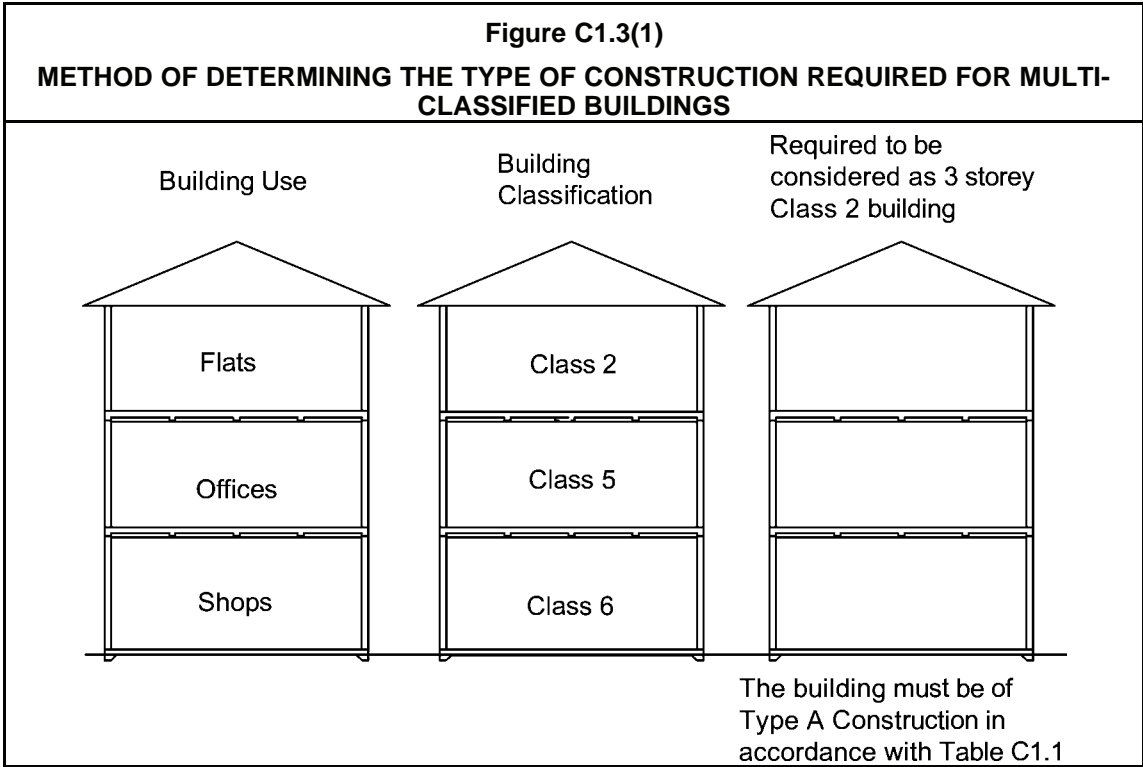

Where a Class 4 part comprises the top storey

To determine the type of construction required when a Class 4 part of a building occupies the whole of the top storey, the class of the next highest storey must be applied to the top storey (see [C1.3\(b\)\(i\)](#)). When a Class 4 part of a building occupies only part of the top storey, the required type of construction is determined by the class of the other part of the top storey (see [C1.3\(b\)\(ii\)](#)).

[C1.6](#) must be used to determine the appropriate FRLs for the building elements in the Class 4 part of the building.

Example

In a 3 storey building with the lower 2 storeys of Class 5 and the top storey entirely of Class 4 the Class 5 classification would be applied to the top storey as shown in [Figure C1.3\(2\)](#). Thus the required type of construction by the use of [Table C1.1](#) would be at least Type B construction.

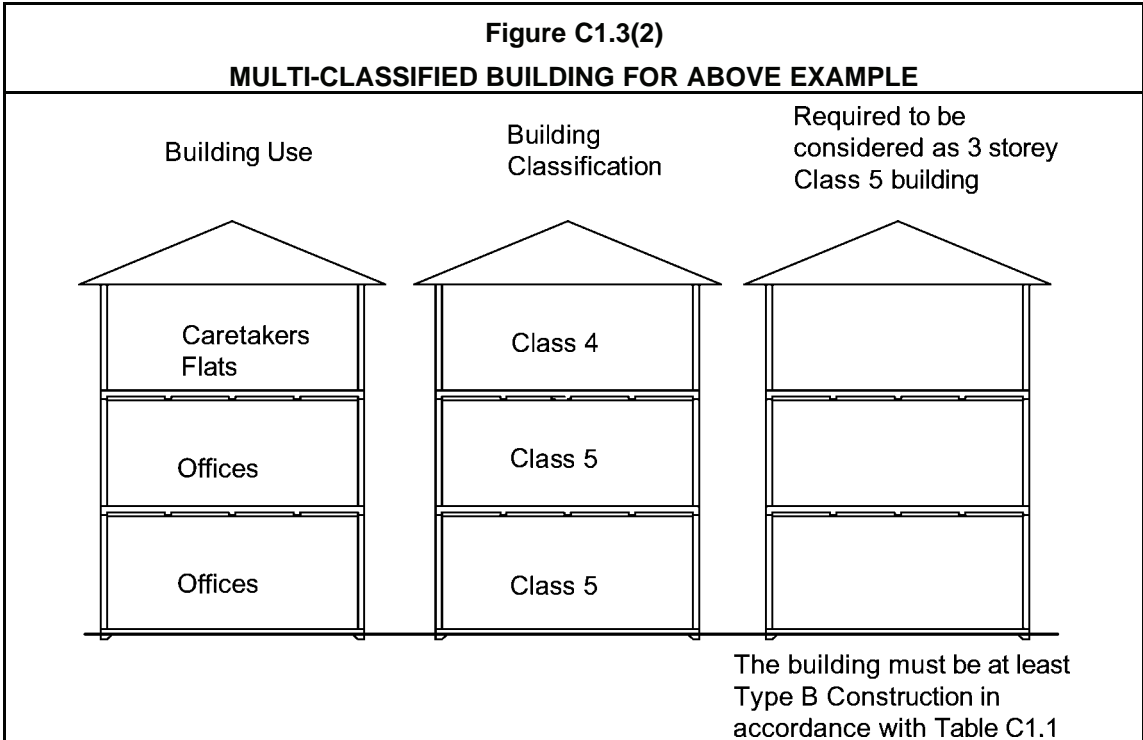

C1.4 Mixed types of construction

Intent

To specify the circumstances in which a building may be of more than one type of construction.

Separation by a fire wall

The only circumstance in which the Deemed-to-Satisfy Provisions allow a building to be of different types of construction is when the types are separated from one another by a fire wall as described in [C2.7\(b\)](#).

Different types must not be above one another

In no case do the Deemed-to-Satisfy Provisions allow different types of construction to be above one another.

C1.5 Two storey Class 2, 3 or 9c buildings

Intent

To grant concessions for:

- low-rise Class 2 and Class 3 buildings provided with a good means of egress; and
- sprinkler protected Class 9c aged care buildings.

Low-rise Class 2 and Class 3 buildings

The concession for Class 2 and Class 3 buildings is made on the basis that the level of risk to occupants does not warrant the full application of the type of construction requirements.

The circumstances outlined in **C1.5(a)** and **(b)** are alternative options. They do not have to both exist to bring the **C1.5** concession into operation.

The concession also applies to a building containing a mixture of Class 2 and Class 3.

Figure C1.5 illustrates an example of the use of the concession allowed by **C1.5**.

Low-rise Class 9c buildings

The concession for Class 9c buildings recognises the benefits of sprinkler systems and differences between Types A, B and C construction. It must be remembered that the Class 9c building must comply with all the other BCA provisions, including the floor area limitations contained in **Table C2.2**.

C1.6 Class 4 parts of buildings

Intent

To specify that Class 4 parts of buildings are subject to the same requirements for fire-resistance levels (FRLs) and separation as would apply to Class 2 parts in similar circumstances.

Class 4 FRLs the same as Class 2

The reason for requiring the same FRL for a Class 4 as a Class 2 building is because the two different classifications have similar fire loads. It should be noted that the Type of construction required for a Class 4 part is determined in accordance with **C1.3**.

In a building fire, the people most at risk include those who are sleeping. It is therefore important that the residential part of the building be fire separated from the other parts. The fire-resistance levels (FRLs) required for structural elements in a Class 4 part of a building are identified in **Tables 3, 4** or **5 of Specification C1.1**.

**Figure C1.5
EXAMPLE OF THE CONCESSION ALLOWED BY C1.5**

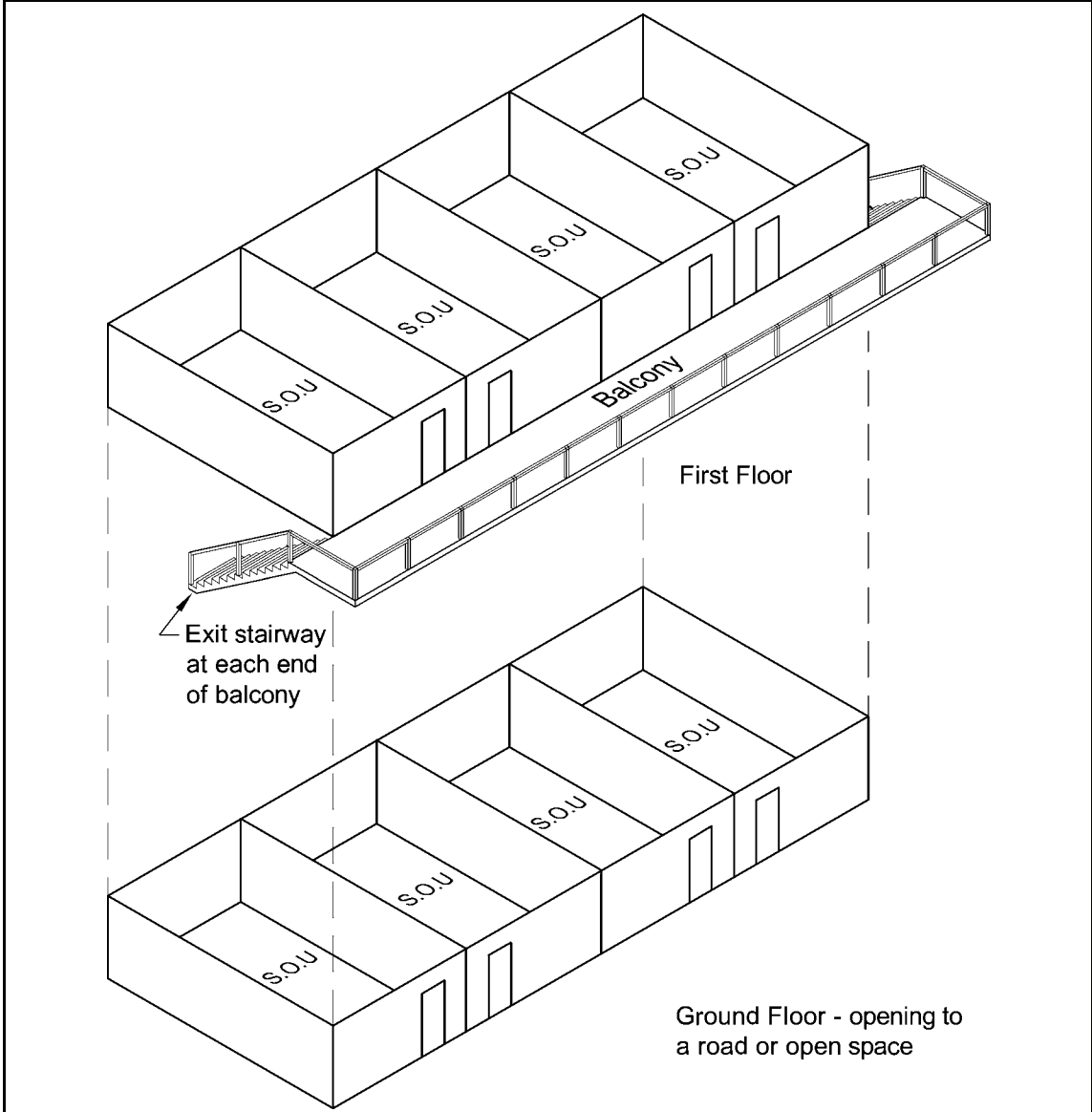

C1.7 Open spectator stands and indoor sports stadiums

Intent

To grant a concession for open spectator stands and indoor sports stadiums.

Indoor sports stadiums

Under specified circumstances (see [C1.7\(a\)](#)), an indoor sports stadium may be of Type C construction.

The reason for this concession is that although an indoor sports stadium may have a high population, particularly during an event, it generally has a lower fire load than other Class 9b buildings. For example, in most stadiums:

- large areas are usually inaccessible to the public (being taken up as part of the sporting events); and
- the finishes are generally spartan.

Open spectator stand

Under specified circumstances (see **C1.7(a)**), an open spectator stand may be of Type C construction. The reason for this concession is that an open spectator stand generally has a low fire load, even though it may have a high population, particularly during an event; and is open at the front thereby not allowing the build up of smoke and heat.

Tier of seating—C1.7(b) and Figure C1.7

C1.7(b) refers to a “tier of seating”. This describes the levels of seating in an open spectator stand. **Figure C1.7** illustrates a single tiered open spectator stand, and a two tiered open spectator stand.

C1.8 Lightweight construction

Intent

To specify the requirements for the use of lightweight construction in:

- circumstances which require walls with a fire-resistance level (FRL);
- certain high use buildings; and
- fire-resisting covering of steel columns or the like.

Definition of “lightweight construction”

Refer to **A1.1** for the definition of “lightweight construction”.

Figure C1.7
SINGLE TIERED AND TWO TIERED SEATING IN AN OPEN SPECTATOR STAND

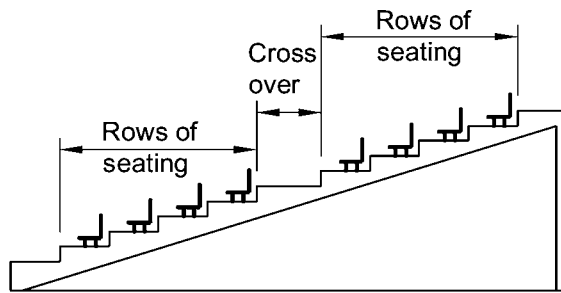

(a) One tier of seating

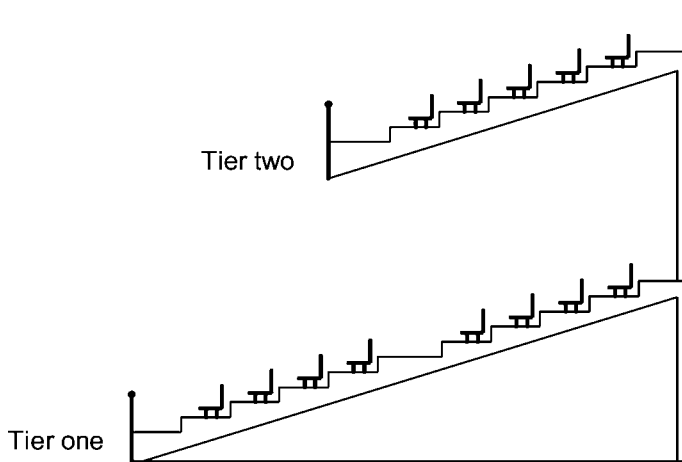

(b) Two tiers of seating

Lightweight construction needs protection

Lightweight construction needs protection to preserve its integrity from mechanical damage in a fire or other situation where it may be particularly subject to risk of damage. This is because it is generally more susceptible to damage than other forms of wall construction, such as concrete (which does not contain soft materials) and masonry thicker than 70 mm.

Specification C1.8

To make sure lightweight construction performs correctly, **C1.8** states that it must comply with **Specification C1.8**. This Specification sets down tests which such construction must satisfy.

Walls required to have an FRL—C1.8(a)(i)

Lightweight construction used in any wall system required to have a FRL must comply with **Specification C1.8** (see **C1.8(a)(i)**).

Walls not required to have an FRL—C1.8(a)(ii)

Lightweight construction must also comply with **Specification C1.8** if it is used in a wall system which is not required to have a FRL, but is specifically listed in **C1.8(a)(ii)** or in a building specifically listed in **C1.8(a)(ii)**.

There is no requirement to comply with **Specification C1.8** where lightweight construction is used for walls which:

- are not listed in **C1.8(a)(ii)**; and
- are in buildings which are not listed in **C1.8(a)(ii)**; and
- do not require fire-resistance levels.

Fire-resisting covering of steel columns—C1.8(b)

C1.8(b) sets out the circumstances under which lightweight construction is permitted to be used as a fire-resisting covering for steel columns and the like.

C1.9 * * * * *

In BCA 1990, this provision related to Class 1 and Class 10 buildings, which are now covered in Volume Two of the BCA. This is the reason why **C1.9** has been left blank.

C1.10 Fire Hazard Properties

Intent
To stipulate the minimum fire hazard properties of materials susceptible to the effects of flame or heat.

Occupants must be able to evacuate

It is important that the spread of fire and the development of smoke be limited during a fire until building occupants have had time to evacuate. See **CP4**.

C1.10(a) lists the linings, materials and assemblies that must comply with **Specification C1.10**.

Materials deemed to comply

C1.10(c)(i) and **(ii)** list materials that are not required to comply with **C1.10(a)**. These materials are deemed to comply and accordingly no tests are required to prove that these materials meet the requirements of **C1.10(a)**.

Fire retardant coatings not acceptable

Some paints have been designed to reduce flame spread on combustible materials. These paints, usually referred to as “fire retardant paint”, cannot be used to achieve any of the required fire hazard properties.

This material is unable to be used because of its susceptibility to damage.

C1.10(b) does not prohibit the use of suitable impregnated materials that achieve the relevant fire hazard properties.

Exempted building parts and materials

C1.10(c)(iii) to **(xiv)** is a practical recognition that a number of building components and materials are unlikely to significantly contribute to the spread of fire and smoke, because of their

size, construction, location and so on. The listed components and materials need not comply with **C1.10(a)**.

C1.10(c)(ix) grants an exemption to permit the use of glass reinforced polyester (GRP) in single storey buildings required to be of Type C construction.

The material is limited to GRP because it does not droop or drip when alight. Furthermore, **C1.10(c)(ix)** limits the disposition and quantity of the GRP for use in the roof. This restriction is to reduce the likelihood of the rapid horizontal spread of fire over large sections of roofing.

Accordingly, for the exemption to be used there must be:

- separation between individual roof lights made of this material;
- a restricted area for each roof light; and
- only a portion of the total roof sheeting made up of GRP.

GRP does not have the Spread-of-Flame Index and Smoke-Developed Index required by the Specification. However, the **C1.10(c)(ix)** concession is provided because if GRP is installed in the prescribed manner, its use in single storey buildings of Type C construction will not materially increase the risk of spread of fire and smoke.

C1.10(c)(xii) refers to elements within buildings such as joinery units, cupboards, shelving and the like which are typically attached to the building structure, however do not form part of the building structure. These elements are exempt as they do not form part of the structure and typically are not included within building works approval. Notwithstanding that these elements are often fixed to the building structure for stability, they are generally of low hazard and may be likened to any building furniture which is not subject to the fire hazard properties provisions.

Likewise, **C1.10(c)(xiii)** exempts certain types of non-building fixtures such as whiteboards, curtains and blinds, etc. Again, these elements are exempt as they do not form part of the structure and typically are not included within building works approval. It should be noted that not all such fixtures are exempt and reference needs to be made to **C1.10(a)** to determine which elements must comply.

C1.11 Performance of external walls in fire

Intent

To minimise the risk of any concrete external wall collapsing outwards as a complete panel during a fire.

See the comments on **CP5** for the reasons for **C1.11**; and why **C1.11** only applies to a building having a rise in storeys of 1 or 2.

Specification C1.11

Specification C1.11 contains:

- detailed solutions to avoid the potential collapse, as whole panels, of concrete external walls in a building with a rise in storeys of 2 or less; and
- minimum design loads which panel connections must resist during a fire, to minimise the risk of panels collapsing outwards.

C1.12 Non-combustible materials

Intent

To permit the use of certain materials which are known to provide acceptable levels of fire safety.

C1.12 lists materials deemed to be non-combustible. These materials may be used wherever a material is required to be non-combustible. In some instances the material may contain combustible components. The materials listed are not intended to apply to fire place hearths required by **G2.3**.

PART C2 COMPARTMENTATION AND SEPARATION

Objective

Functional Statements

Performance Requirements

The Objective, Functional Statements and Performance Requirements are at the beginning of [Section C](#).

Deemed-to-Satisfy Provisions

C2.0 Deemed-to-Satisfy Provisions

Intent

To clarify that the requirements of [CP1](#) to [CP9](#) will be satisfied if a building complies with Parts [C1](#), [C2](#) and [C3](#), and Parts [G3](#) and [H1](#), if applicable.

Where a Building Solution is proposed to comply with the Deemed-to-Satisfy Provisions, [C2.0](#) clarifies that for most buildings compliance with Parts [C1](#), [C2](#) and [C3](#) will achieve compliance with [CP1](#) to [CP9](#). The exceptions to this general rule are set out below:

- If the building contains an atrium, it must comply with Part [G3](#) in addition to Parts [C1](#), [C2](#) and [C3](#).
- A building which comprises a theatre, stage or public hall must comply with Part [H1](#) in addition to Parts [C1](#), [C2](#) and [C3](#).
- If the building contains an atrium and one or more of a theatre, stage or public hall, it must comply with Parts [C1](#), [C2](#), [C3](#), [G3](#) and [H1](#).

Where a Building Solution is proposed as an Alternative Solution to the Deemed-to-Satisfy Provisions, the relevant Performance Requirements must be determined in accordance with [A0.10](#). (See comment on [A0.10](#)).

C2.1 Application of Part

Intent

To clarify that the floor area limitations of Part C2 do not apply to certain buildings.

The floor area limitations of Part C2 do not apply to a carpark containing a sprinkler system complying with [Specification E1.5](#), an open-deck carpark or an open spectator stand.

C2.2 General floor area and volume limitations

Intent

To limit the size of any fire in a building by limiting the size of the floor area and volume of a fire compartment.

Allowable size of the fire compartment

Under [C2.2\(a\)](#) and [Table C2.2](#), the allowable size of the fire compartment depends on two things. The first is the type of construction, which is a measure of a building's ability to resist a fire. The second is the classification of the building, which is an indicator of a building's potential fire load.

Example

In the case of a Class 7 building which has an area of 3 000 m², [C2.2](#) enables three potential solutions. The building can be:

- Type C construction if it is divided into fire compartments with areas less than those specified in [Table C2.2](#), or if use can be made of the concessions and requirements of [C2.3\(a\)](#); or
- Type A or Type B construction, because the area of the building falls within that permitted under [Table C2.2](#).

Machinery and plant rooms

Under [C2.2\(b\)](#), machinery and plant rooms at the top of a building are not included in the calculation of a building's floor area or volume of a fire compartment. The BCA assumes that such rooms represent a low risk to people in case of fire because of the generally:

- low fire load;
- low number of people who use them; and
- as the occupants of most buildings evacuate downwards, a fire in a plant room at the top of a building will generally not interfere with the ability to evacuate.

Atriums

Under [C2.2\(c\)](#), in an atrium, the area of the atrium well above the floor of the atrium is excluded from the volume calculation because there is no space in which to store materials, thus it is assumed that it does not contribute to the fire load. See [Part G3](#).

Class 9c buildings

[Table C2.2](#) allows sprinkler protected Class 9c buildings to have a maximum fire compartment size of—

- if the building is of Type A construction—8 000 m²; or
- if the building is of Type B construction—5 000 m²; or
- if the building is of Type C construction—3 000 m².

Buildings of mixed classifications

C2.2 makes no reference to the use of **Table C2.2** for a building containing mixed classifications. The table specifies the maximum allowable floor area of certain buildings.

To calculate the maximum permissible floor area, firstly take the percentage of each classification as a proportion of the actual floor area of the building.

Then, use this percentage to calculate the proportion of the maximum floor area permitted for that classification in **Table C2.2** and then add each of those calculations together to come to a maximum permitted floor area for the combined classifications. To see this illustrated in simpler terms refer to the example below.

Example

Figure C2.2 shows a building of Type C construction containing a factory (Class 8) with an office (Class 5) at the front. The total area of the building is 2 100 m².

The area of the Class 8 portion of the building is 80% (1 680 m²) of the floor area of the whole building (that is, the combined Class 8 and Class 5 portions).

The area of the Class 5 portion of the building is 20% (420 m²) of the floor area of the whole building (that is, the combined Class 8 and Class 5 portions).

To determine if such a building complies with **Table C2.2**, the following calculations are necessary:

- Maximum area of Class 8 allowed by Table C2.2 = **2 000 m²**
- The percentage of Class 8 is 80% = 80% of 2 000 m² = **1 600 m²**
- Maximum area of Class 5 allowed by Table C2.2 = **3 000 m²**
- The percentage of Class 5 is 20% = 20% of 3 000 m² = **600 m²**
- Maximum allowable floor area = 1 600 + 600 = **2 200 m²**

The maximum allowable floor area of the building is **2 200 m²**. Therefore, the building in this example complies with **Table C2.2**. The fact that the Class 8 portion exceeds 1 600 m² is irrelevant for the purposes of this process. However, that portion is not permitted to exceed 2 000 m².

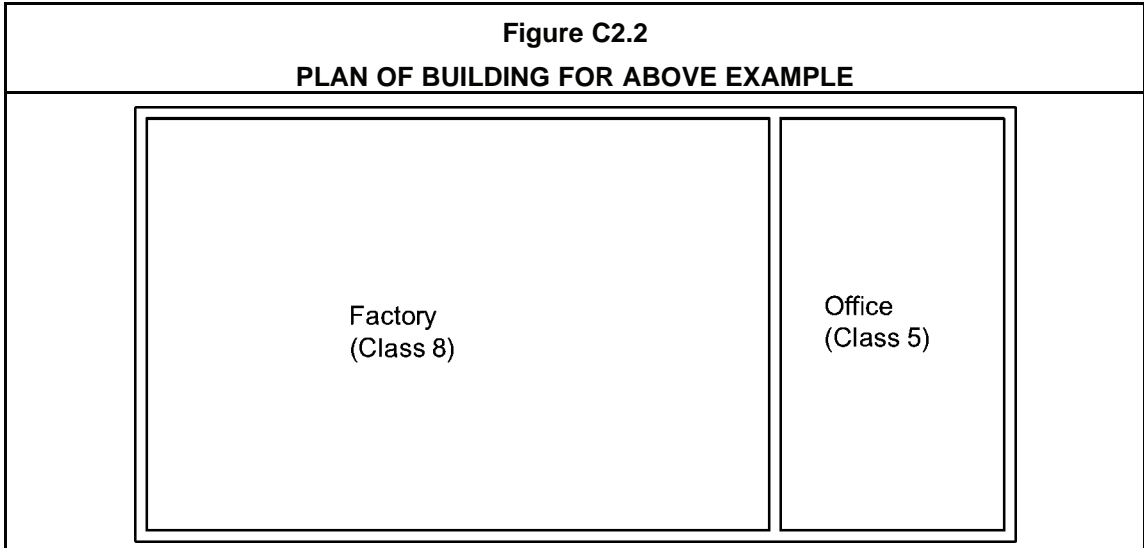

C2.3 Large isolated buildings

Intent

To grant concessions for large isolated buildings from the floor area and volume limitations.

Up to 18 000 m² floor area and 108 000 m³ volume

Under **C2.3(a)**, a building with a floor area of 18 000 m² or less and a volume of 108 000 m³ or less is permitted to have fire compartments which exceed the requirements of **Table C2.2**, if it complies with the requirements outlined below as applicable:

- Where the building is either Class 7 or Class 8—
 - it contains no more than 2 storeys; and
 - it has an 18 m wide open space around the building complying with **C2.4(a)**.
- Where the building is Class 5–9 (including Class 7 and Class 8), it contains a sprinkler system complying with **Specification E1.5** and has vehicular access complying with **C2.4(b)**.

Over 18 000 m² in floor area or 108 000 m³ in volume

Under **C2.3(b)**, a building with a floor area of more than 18 000 m² or a volume of more than 108 000 m³ is permitted to have fire compartments which exceed the requirements of **Table C2.2** if—

- it is protected with a sprinkler system complying with **Specification E1.5**; and
- it has vehicular access complying with **C2.4(b)**.

C2.3 should be read in conjunction with the smoke hazard management systems required by **Table E2.2a**. The reason for this is that the smoke hazard management system will play an important part in occupant safety during a fire in large fire compartments.

More than one building on allotment

Where there is more than one building on the allotment, each building may have fire compartments which exceed the requirements of [Table C2.2](#), if each building complies with [C2.3\(a\)](#) or [C2.3\(b\)](#), or if the buildings are closer than 6 metres, they both must comply with [C2.3\(a\)](#) or [C2.3\(b\)](#), as applicable, as if they were one building.

If the buildings are separated by a fire wall complying with [C2.7](#), the entire building, regardless of the level of fire compartmentation, must comply with [C2.3\(a\)](#) or [C2.3\(b\)](#), as applicable.

If more than two buildings are located on the same allotment and greater than 6 m apart, each individual building must comply with [C2.3\(a\)](#) or [C2.3\(b\)](#), as applicable.

C2.4 Requirements for open spaces and vehicular access

Intent

To set the minimum requirements for open space around a building and the provision of vehicular access for the fire brigade.

The reason for the open space requirement is to minimise the risk of a fire spreading to another building.

[C2.4\(a\)](#) specifies the compliance criteria for the open space required under [C2.3](#). The open space must be wholly within the allotment. However, the open space may also include everything except what is beyond a line drawn six metres from the farthest edge of a road, river or public place adjoining the allotment.

The open space must also include the vehicular access required by [C2.4\(b\)](#), not be used for storage or processing and not be built on, except as specified.

This provision requires the making of a “performance-style” judgement. It is the responsibility of the building proponent to satisfy the appropriate authority that any buildings on the open space will not unduly impede the activities of the fire brigade, nor add to the risk of fire spreading to a building on an adjoining allotment.

[Figure C2.4](#) illustrates compliance with [C2.4](#).

The reason for the fire brigade vehicular access is to enable the brigade to intervene to fight the fire, assist with evacuation, and stop the spread of a fire to another building. The vehicular access also provides other emergency services personnel, such as ambulance officers, with the ability to access the building as necessary.

[C2.4\(b\)](#) specifies the compliance criteria for the vehicular access required by Part [C2](#).

The required vehicular access must have access from the public road system (see [C2.4\(b\)\(i\)](#)) and must have the width, height and loadbearing capacity to allow the passage in a forward direction around the entire building and parking of fire brigade vehicles (see [C2.4\(b\)\(ii\)](#) and [\(iv\)](#)).

It must also have the necessary pedestrian access to the building (see [C2.4\(b\)\(iii\)](#)). This access may be from a public road which otherwise complies with the various requirements of [C2.4\(b\)](#) (see [C2.4\(b\)\(v\)](#)).

To achieve compliance with these provisions it is advisable to check with the local fire brigade, due to the varying sizes and type of equipment and vehicles that may be required to fight a fire.

C2.5 Class 9a and 9c buildings

Intent

To protect patients in a health-care building and residents in an aged care building from the spread of fire and smoke.

General

It should be noted that **C2.5(a)** applies to Class 9a health-care buildings. **C2.5(b)** only applies to Class 9c aged care buildings.

Class 9a buildings—evacuation difficulties

Residents or patients of Class 9a buildings are often unable to evacuate a building without assistance. They may be incapable of walking or bedridden. It is important to make sure that fire and smoke only affects small areas of the building.

C2.5(a)(i) requires compartmentation for the control of smoke and fire.

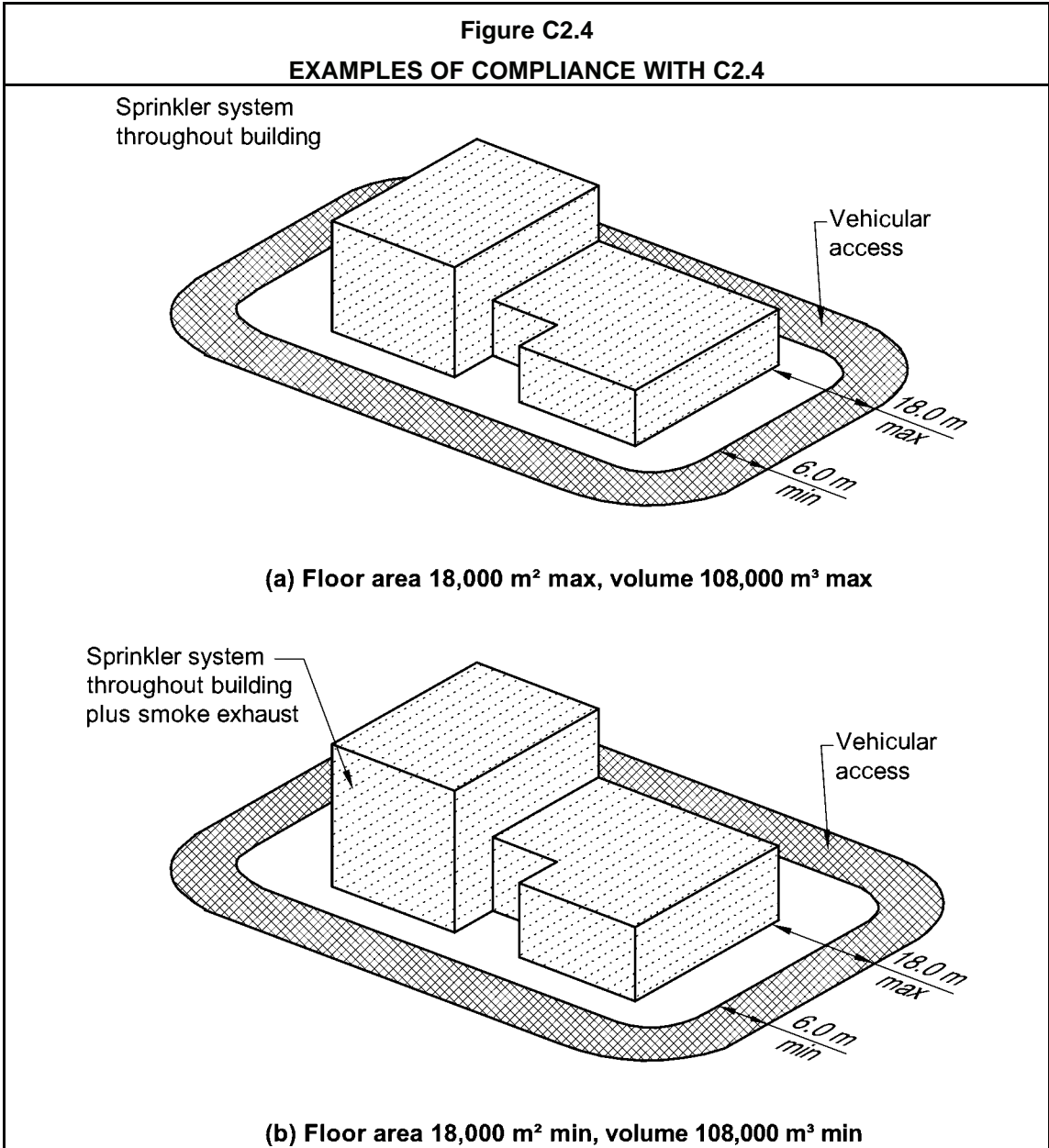

C2.5(a)(ii) and **(iii)** require sub-compartmentation in certain areas to allow for the staged evacuation of patients from the building. However, usually successful evacuation depends on assistance being provided to evacuees by an adequate number of staff.

The requirements for smoke proof walls and doors are contained in **Specification C2.5**.

C2.5(a)(iv) and **(v)** make it necessary to separate potential sources of fire from any patient care area. **C2.5(a)(iv)** has construction requirements for fire compartments in Class 9a buildings. An ancillary use area in **C2.5(a)(v)** is deemed to be an area where there are items of equipment or materials, that have a high potential fire hazard (high fire load or fire source).

C2.5(a)(vi) provides examples of areas covered by **(v)**.

Figure C2.5 illustrates one means of complying with **C2.5**.

The first part of the figure shows how the administrative area of a hospital has been separated from the patient care area by a fire wall because the patient care area has a floor area of 2000 m², the maximum permitted under **C2.5(a)(i)**.

The second part of the figure shows how the ward area must be subdivided into areas with a maximum floor area of 1 000 m² by a wall with an FRL of 60/60/60.

Some floors of Class 9a buildings may require an FRL

Compliance with **C2.5(a)(iv)(B)** may require a floor in a Class 9a building of Type B construction to have a fire-resistance level (FRL). The reason for this is that it is important to inhibit the spread of fire between floors. Separation of storeys in a Class 9a building also requires any openings in external walls to be vertically separated in accordance with **C2.6**.

Class 9c buildings—evacuation difficulties

Residents of Class 9c buildings are often unable to evacuate without assistance. They may be incapable of walking or bedridden. It is therefore important to make sure that fire and smoke only affects small areas of the building, hence allowing residents sufficient time should evacuation be necessary.

Some walls and floors of Class 9c buildings may require an FRL

C2.5(b)(ii) requires certain walls and floors in Class 9c buildings to have a fire-resistance level (FRL). The reason for this is that it is important to inhibit the spread of fire for resident and occupant safety.

C2.5(b)(iii) allows internal walls (other than one bounding a lift or stair shaft) to have an FRL of 60/-/- because the floor is required to have an FRL of 60/60/60. Note that the FRL is only required for structural adequacy because **Table 4** only requires loadbearing walls in these situations to have an FRL with respect to structural adequacy. The lower FRL allowed by **C2.5(b)(iii)** recognises the effectiveness of the required sprinkler systems in Class 9c buildings.

Compartmentation of Class 9c aged care buildings

The compartmentation required by fire rated and smoke proof walls for Class 9c aged care buildings is similar to that required for Class 9a buildings.

The required compartmentation and sub-compartmentation of Class 9c aged care buildings are to allow for the staged evacuation of residents from the building. However, successful evacuation usually depends on assistance being provided to evacuees by an adequate number of staff. The BCA provisions for Class 9c aged care buildings are based on minimal on duty on-site staff being available at any time.

C2.5(b)(i) requires a Class 9c aged care building to be subdivided into areas with a maximum area of 500 m² by smoke walls complying with **Specification C2.5**. No further subdivision of the fire compartments by smoke or fire rated walls is required. This recognises the benefits of sprinkler systems that must be installed in all Class 9c buildings.

An ancillary use area in **C2.5(b)(iv)** is deemed to be an area where there are items of equipment or materials that have a high potential fire hazard (high fire load or fire source). The reason these walls need only be smoke proof, whereas those in a Class 9a building must have an FRL, is that Class 9c buildings must be sprinkler protected.

C2.5(b)(v) provides examples of areas covered by **(iv)**.

Figure C2.5
PLAN SHOWING ONE METHOD OF COMPLYING WITH C2.5(a) FOR CLASS 9a BUILDINGS

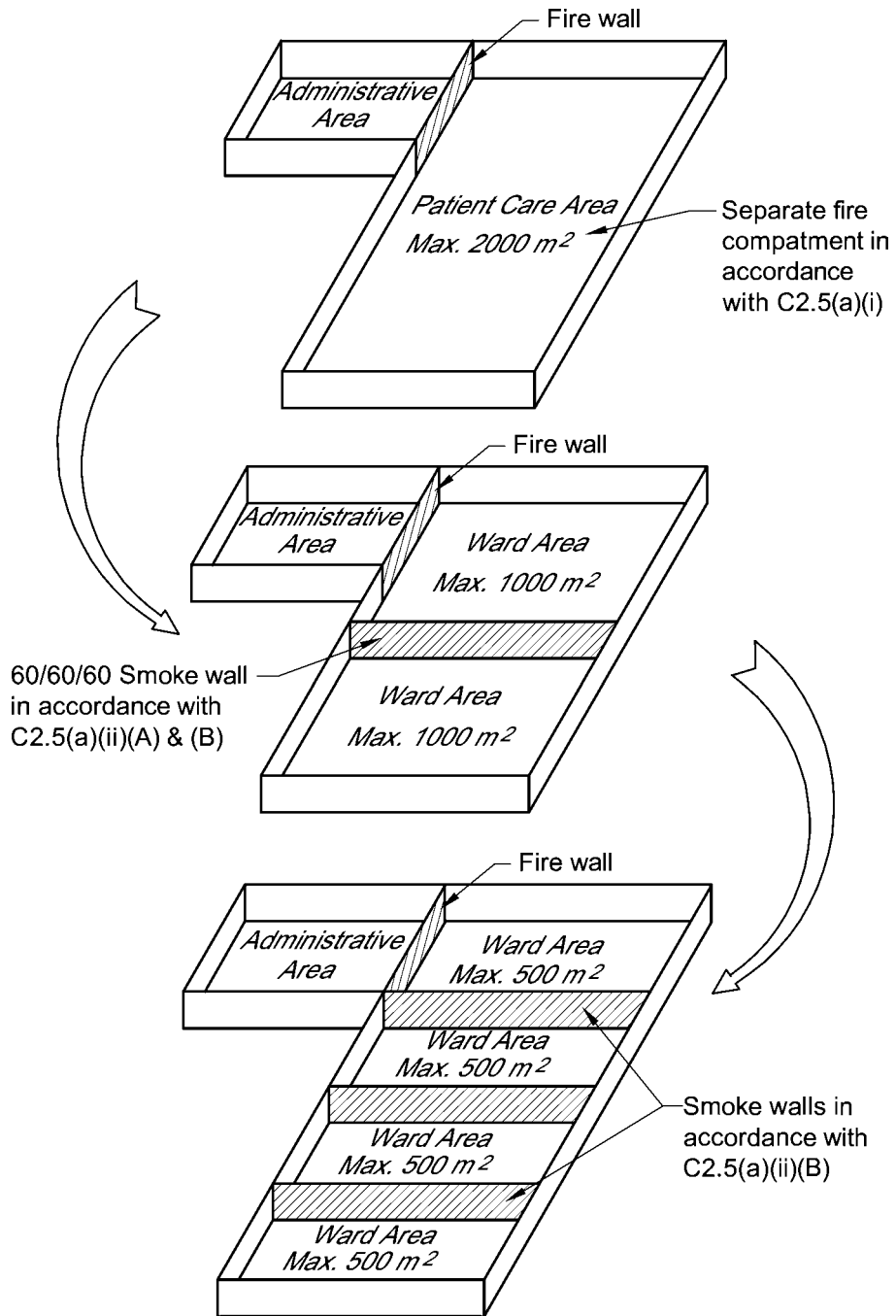

C2.6 Vertical separation of openings in external walls

Intent

To minimise the risk of fire spreading from one floor to another via openings in external walls in buildings of Type A construction.

Buildings of Type A construction

C2.6 generally applies to buildings of Type A construction and Class 9a buildings of Type B construction, because they are the only buildings required to provide fire separation between floors. This separation is achieved by the floor being required to have a fire-resistance level (FRL). It applies to openings above one another in different storeys if they are within a horizontal distance of 450 mm of each other.

It does not apply to:

- sprinkler protected buildings because the sprinklers should prevent the fire developing to the stage where it could spread to the floor above;
- openings in a fire-isolated stair shaft. This is because the stair shaft is not considered to be separate storeys and it is assumed that fire spread between floors will not occur via the stairway; or
- open-deck carparks and open spectator stands. This is because it is unlikely that fire would spread between floors in these types of buildings as their open construction allows the dissipation of the effects of fire.

In addition, Class 9a buildings of Type B construction require openings in external walls to be vertically separated in accordance with **C2.6** as if the building was Type A construction (see **C2.5(a)(iv)**). This can be achieved either by the construction methods outlined below or the installation of sprinklers in the building. The reason for this is that it is important to inhibit the spread of fire between floors in Class 9a buildings.

Protection of vertically separated openings

C2.6 requires the vertical separation of openings in external walls (see **C2.6(a)** and **(b)**) of buildings of Type A construction which do not have a sprinkler system complying with **Specification E1.5**. The vertical separation of openings can be achieved by either of the following methods:

- a non-combustible spandrel or other non-combustible vertical construction having an overall height of 900 mm or more, extending at least 600 mm or more above the upper surface of the intervening floor, and having an FRL of 60/60/60 (see **C2.6(a)(i)**) as shown in **Figure C2.6(1)**; or
- a non-combustible horizontal projection having an outwards projection from the external face of the wall of 1 100 mm or more, an extension along the wall beyond the openings of at least 450 mm, and having an FRL of 60/60/60 (see **C2.6(a)(iv)**) as shown in **Figure C2.6(2)**.

If the external wall of the building is a glass curtain wall, **C2.6(a)(iii)** contains specific provisions to stop or limit the spread of fire and smoke between the glass and the edge of the concrete floor. The details are shown in **Figure C2.6(3)**.

Although it could be argued that the spandrel or vertical projection should have the same FRL as the floor separating the storeys, this has not been found to be necessary.

Meaning of "window or other opening"

C2.6(c) explains the meaning of the term "window or other opening" as used in **C2.6(a)**. Basically, the term is used to describe a part of the external wall which does not have an FRL of at least 60/60/60 to limit the spread of fire from one storey to another by passing out through the window or opening and then re-entering the building through a similar opening (i.e. one without an FRL of at least 60/60/60) on the storey above. Examples of such openings include:

- windows;
- glass curtain walls;
- non-fire rated panels; and
- other parts of the wall that do not have an FRL of at least 60/60/60.

Figure C2.6(1)

SECTION SHOWING USE OF SPANDREL TO SEPARATE EXTERNAL WINDOW OPENINGS

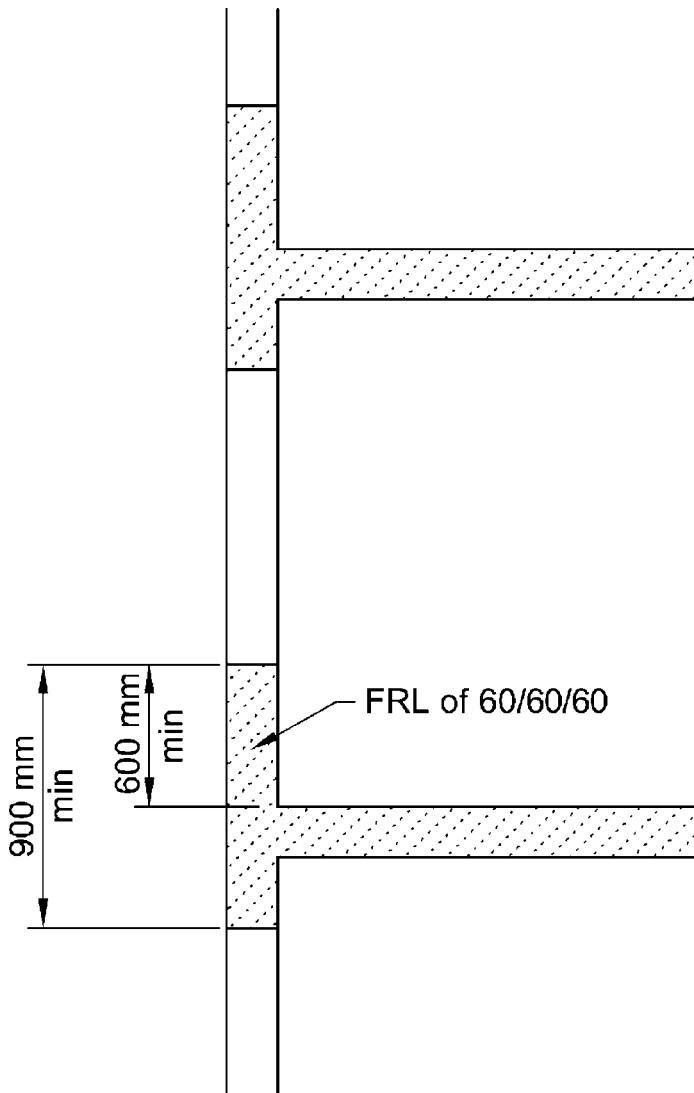

Section

Figure C2.6(2)

EXAMPLE SHOWING USE OF SLAB OR HORIZONTAL CONSTRUCTION TO SEPARATE EXTERNAL WINDOW OPENINGS

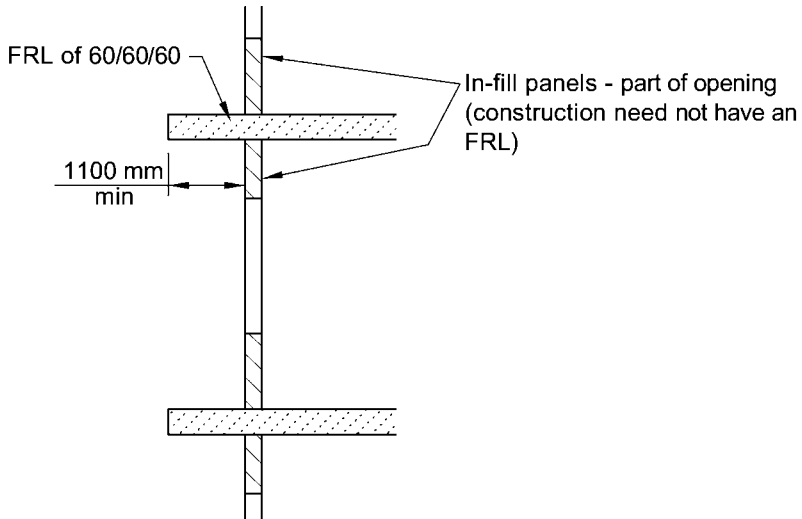

(a) Section

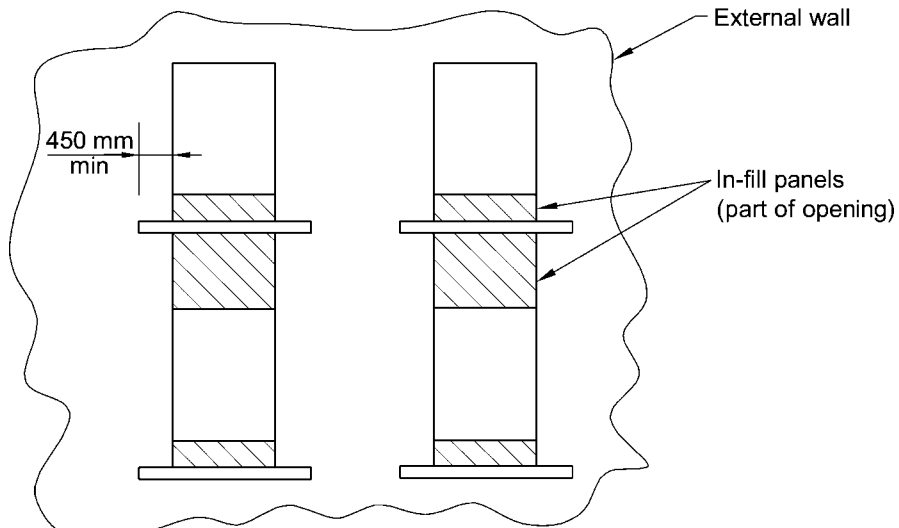

(b) Elevation

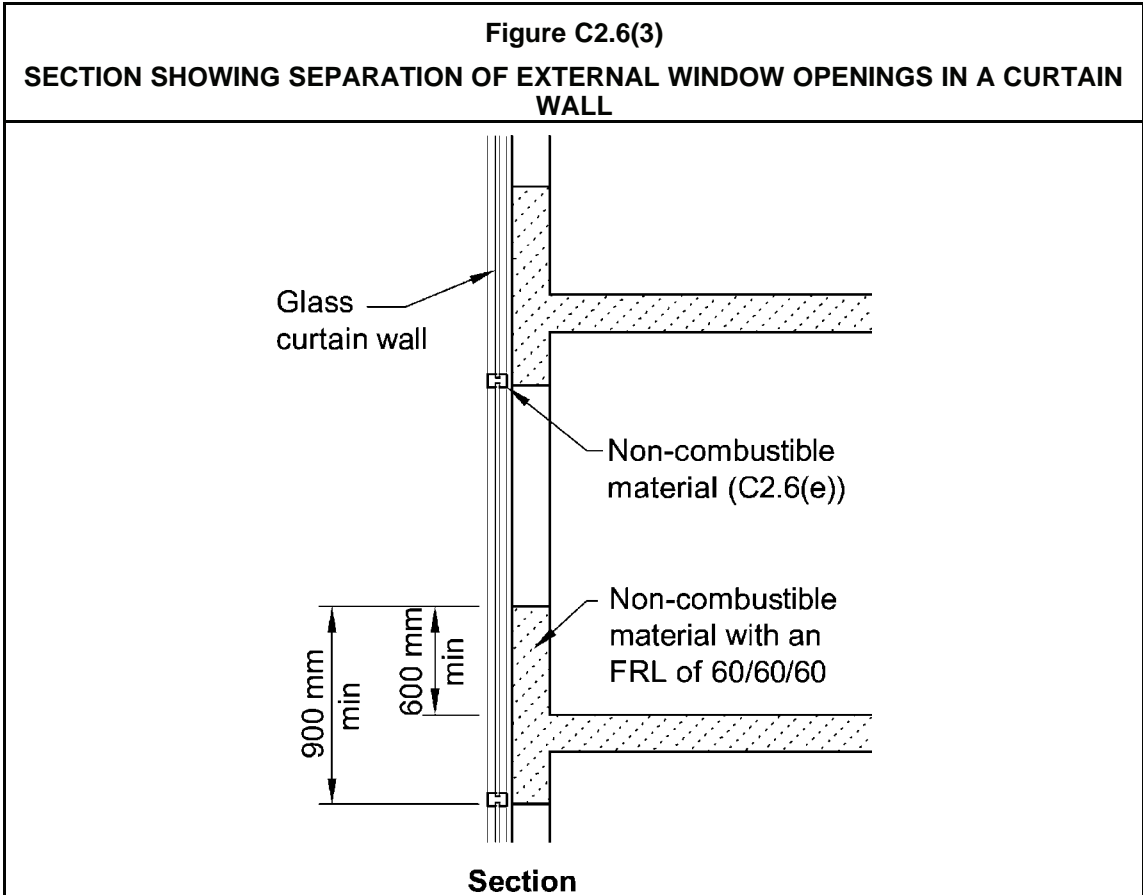

C2.7 Separation by fire walls

Intent

To explain that buildings separated by a fire wall may be considered as fire compartments or be regarded as separate buildings.

Construction

C2.7(a) outlines how a fire wall is to be constructed.

C2.7(a)(i) sets out the required FRL of a fire wall. If any part adjoining the fire wall is required to have a higher FRL, the fire wall must achieve the higher FRL. The exception occurs if an adjoining part is an open-deck or sprinklered carpark that complies with the concessions set out in **Table 3.9, 4.2 or 5.2 of Specification C1.1**.

C2.7(a)(ii) requires all openings in fire walls to not reduce the required FRL of **Specification C1.1** for the fire wall, except where permitted by Part **C3**. In effect, this provision is referring to:

- **C3.5** for doorways in fire walls;
- **C3.6** for sliding doors in fire walls;
- **C3.7** if the fire wall forms separation required for horizontal exits; and
- **C3.15** for openings for service penetrations.

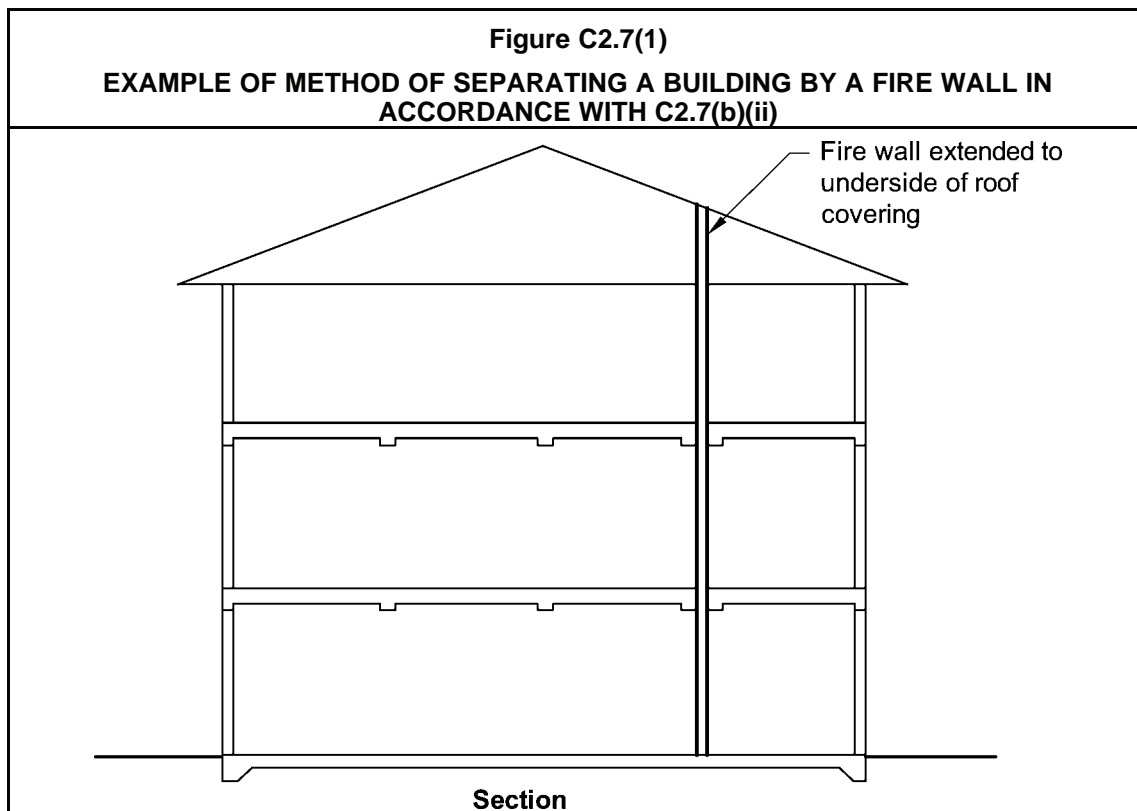

C2.7(a)(iii) indicates which building elements are permitted to pass through or cross a fire wall and prohibits the use of any building element if it reduces the fire wall's FRL below that required. Hence, elements that pass through or cross a fire wall have to be part of the fire wall's tested prototype.

C2.7(a)(iii) grants an exemption to its requirements for small roof battens and roof sarking.

Separation of buildings

C2.7(b) indicates the extent a fire wall divides a building into separate buildings for the Deemed-to-Satisfy Provisions of **Sections C, D** and **E** (see **Figure C2.7(1)**).

The fire wall must extend through all storeys and similar spaces which are common to the subject parts of the building, and any adjoining part of the building, through to the underside of any roof covering (see **C2.7(b)(ii)**).

C2.7(b) outlines the requirements for the extent of a fire wall that separates adjoining parts of a building where the roofs are at different levels.

If buildings, with different roof levels divided by a fire wall, are to be treated as two separate buildings, the fire wall must extend up to the underside of the highest roof or not less than 6 m above the covering of the lowest roof.

Alternatively, **C2.7(b)** allows the fire wall not to extend 6 m above the lower roof if the roof to the lower level building:

- has the FRL prescribed for the fire wall by **Specification C1.1** and no openings are located within 3 m of any wall located above the lower roof; or

- the lower roof is non-combustible and the part of the building below has a sprinkler system complying with **Specification E1.5** installed.

Separation of fire compartments

C2.7(c) clarifies that a fire wall built in accordance with **C2.7(a)** can be considered to divide a building into different fire compartments for the purpose of **Sections C, D and E** (see **Figure 2.7(2)**).

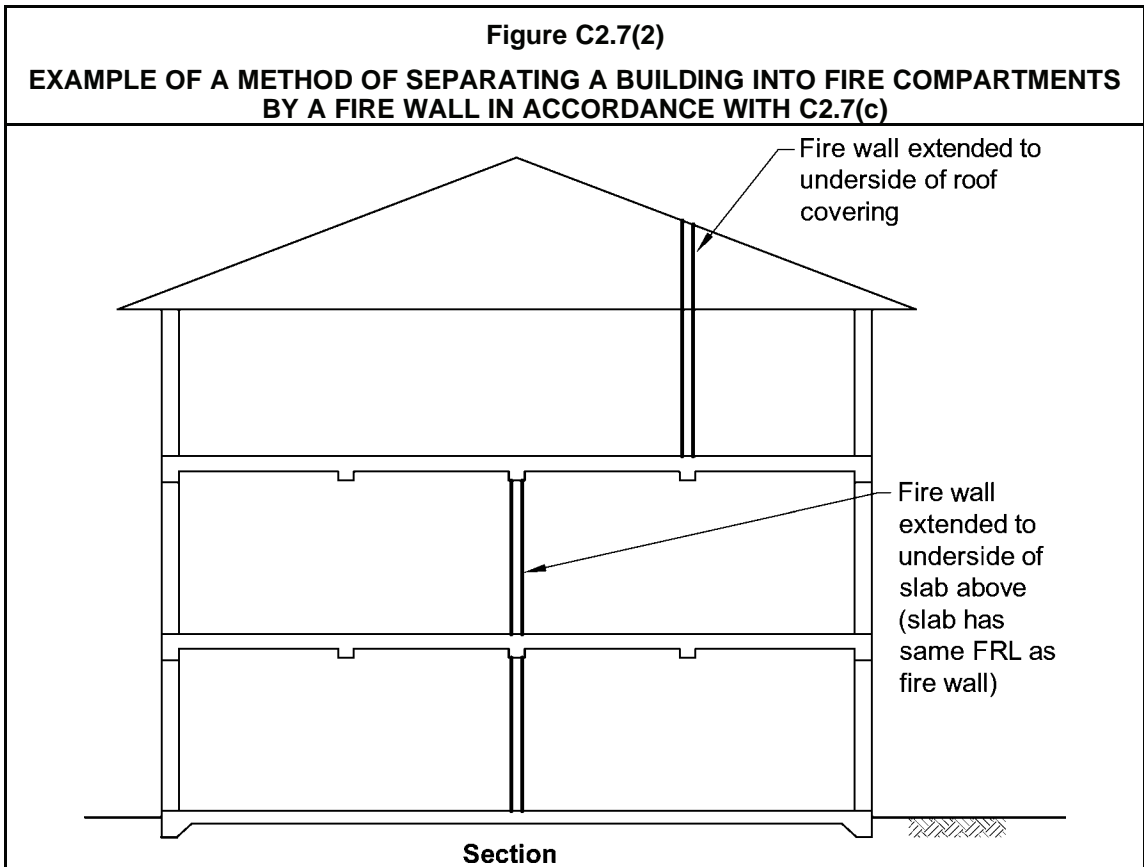

For a fire wall to compartment a building it must extend to the underside of any roof covering or between floors that have an equivalent FRL to the fire wall.

If the building is being separated into fire compartments by a fire wall have different roof levels there is no requirement to extend the fire wall to the underside of the higher roof level or above the lower roof level. This is because the fire wall serves as a means to limit the floor area of the building. When a fire wall is applied in this case, the building cannot be treated as two separate buildings for the purpose of **Sections C, D and E** of the BCA.

Figure C2.7(2) illustrates the case where two fire walls divide storeys but do not align, therefore not meeting the requirements of **C2.7(b)**. In this case, the building cannot be regarded as two buildings divided by a fire wall.

Figure C2.7(3) illustrates a circumstance where a fire wall can be an external wall. This is important to note because of a possible reading of the definition of “fire wall” which indicates that a fire wall would always be an internal wall. For the purposes of Sections C, D and E, the separated building is regarded as two buildings.

C2.8 Separation of classifications in the same storey

Intent

To minimise the risk of a fire in one classification on a storey causing the failure of building elements in another classification on the same storey.

Fire spread between classifications

The fire-resistance level (FRL) required for building elements varies, depending on the expected fire load. This load is measured in the BCA by the building classification. With these differing FRLs, it is important that a fire in one classification does not cause the failure of building elements in any other classification.

There are two options to stop a fire spreading from one classification to another classification on the same storey:

- use the highest of the two fire-resistance levels (FRLs) required for each building element in that storey (see [C2.8\(a\)](#)); or
- place a fire wall between the two different classifications (see [C2.8\(b\)](#) and [\(c\)](#)). In a building of mixed classification [C2.8\(b\)](#) clarifies that for Type A and Type B construction the FRL is the higher of that specified in [Table 3](#) or [4](#) but for Type C construction it is the FRL specified in [Table 5](#). This is because the FRL for firewalls in Type C construction is the same for all Classes.

[Figure C2.8\(1\)](#) illustrates some examples of fire walls separating different classifications within the same storey of a building. In the first diagram, the public corridor must be fire-separated from the Class 6 part (as shown) or the Class 5 part to achieve total fire-separation between the different classifications. If a doorway is located in the fire wall, it must comply with [C3.5](#).

Figure C2.7(3)

EXAMPLE OF FIRE WALL USED AS AN EXTERNAL WALL TO SEPARATE A BUILDING
IN ACCORDANCE WITH C2.7(b)(iii)

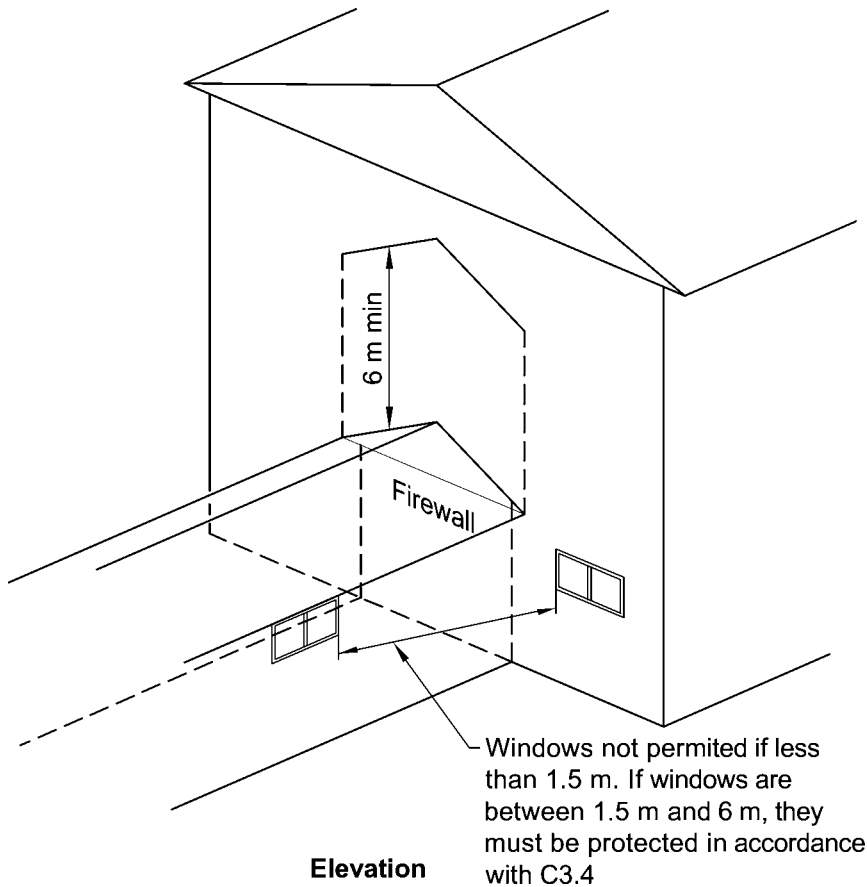

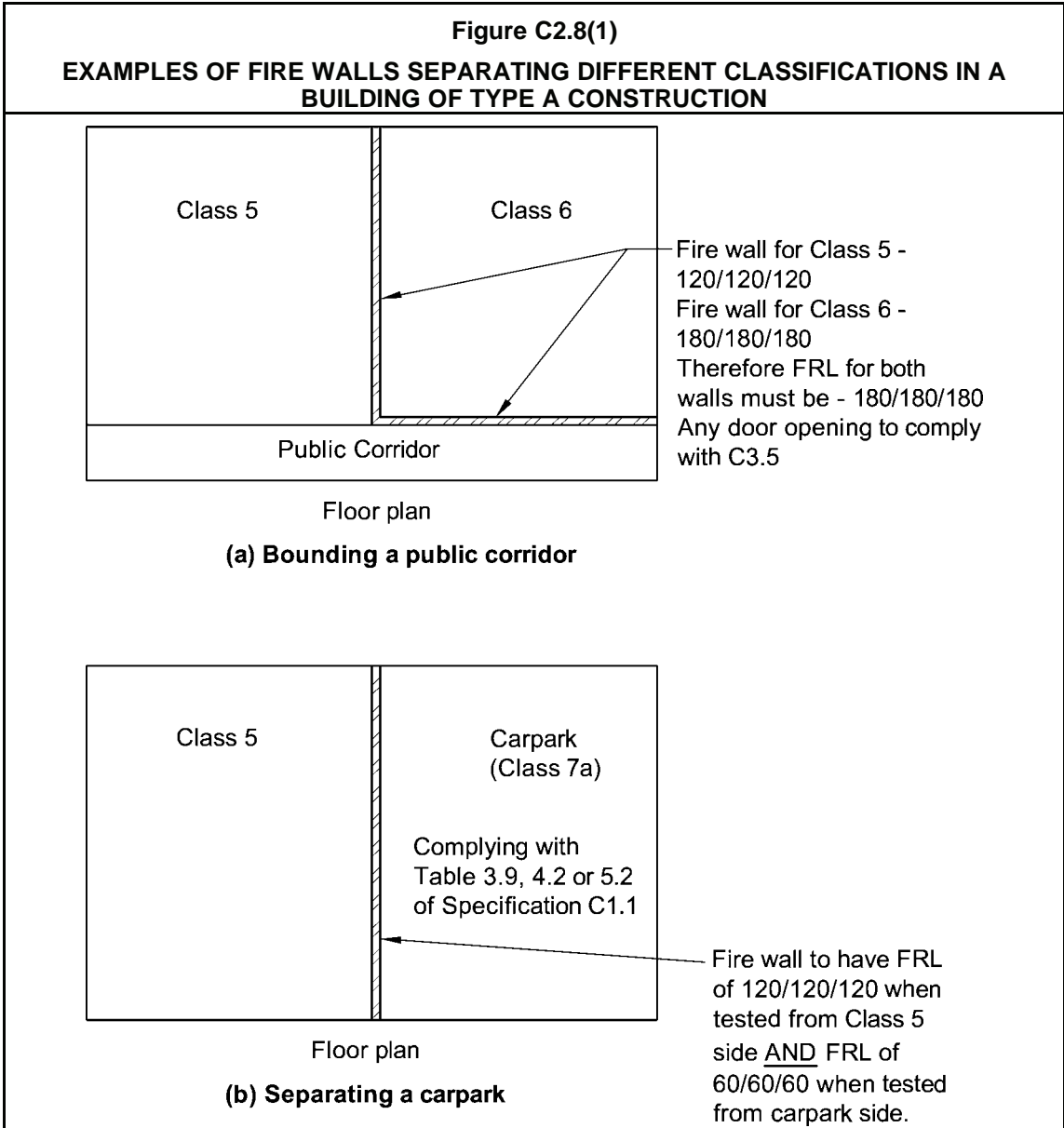

The diagrams in **Figure C2.8(2)** illustrate examples of fire walls separating different classifications within the same storey of a multi-storey building and floors separating different classifications.

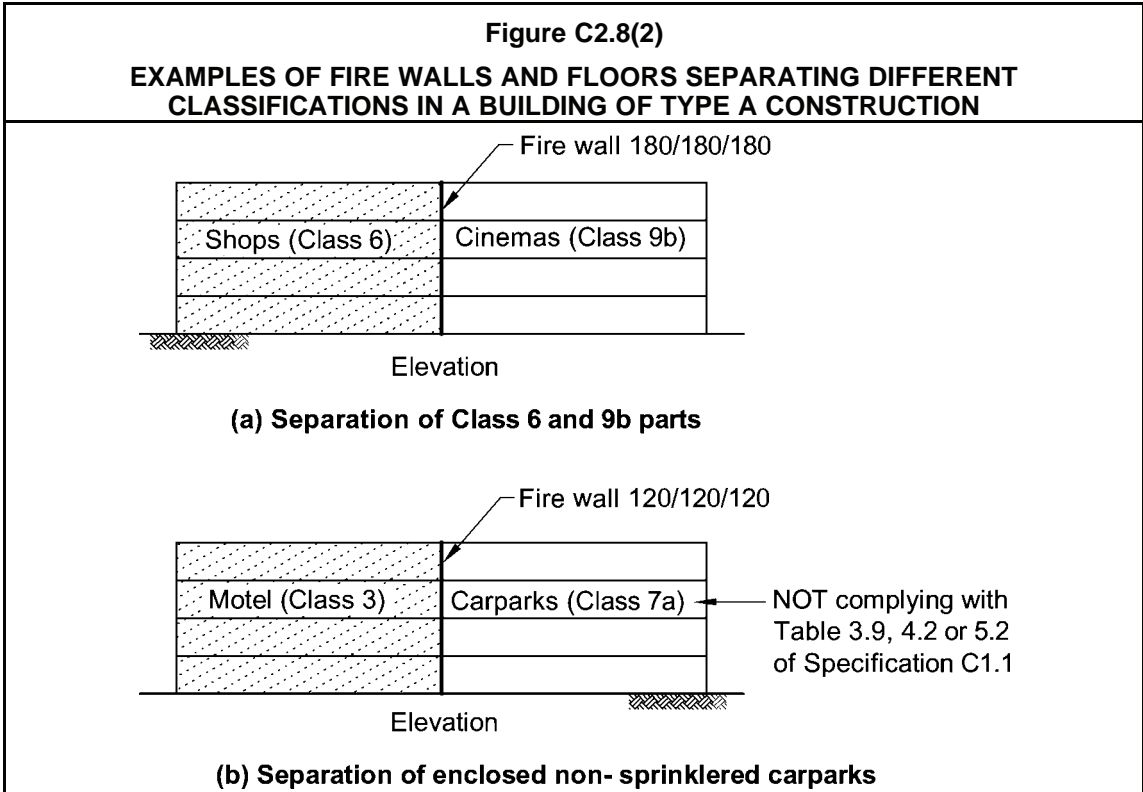

C2.9 Separation of classifications in different storeys

Intent

To minimise the risk of a fire in one classification causing the failure of building elements in another classification in a different storey.

C2.9 specifies the required separation between parts of a building which are of a different classification, situated one above the other.

The aim of **C2.9** is for the fire load of a storey to determine the fire protection of the floor above it. A fire on one storey will affect the storey above to a greater degree than any storey below.

C2.9(a) sets out the requirements for buildings of Type A construction. **Figure C2.9** illustrates an example of the required fire-resistance level (FRL) of floors in a 3 storey building required to be of Type A construction.

C2.9(b) sets out the requirements for buildings of Type B and Type C construction. However, note that **C2.9(b)** is only applicable where one of the parts being separated is Class 2, Class 3 or Class 4 and **Specification C1.1 Clauses 4.1(i)** and **5.1(e)** require floors to be protected if the building is Class 2, 3 or 9.

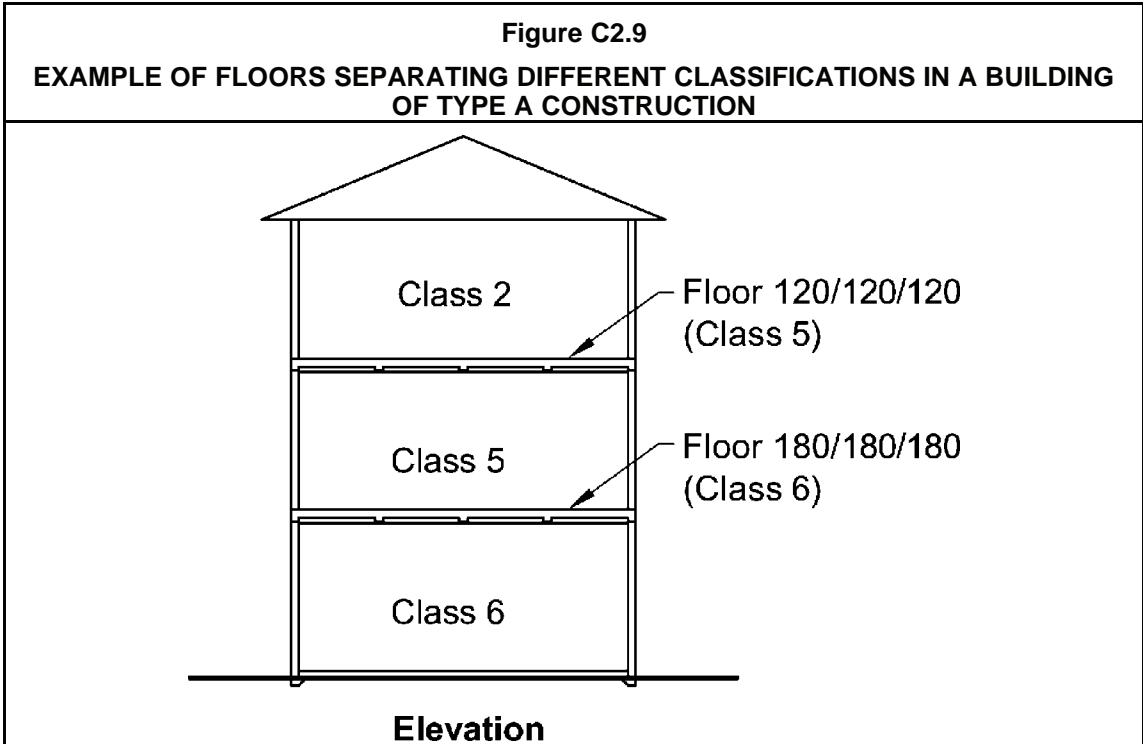

C2.10 Separation of lift shafts

Intent

To minimise the risk of a fire spreading from one floor to another floor of a building by way of a lift opening.

The approach adopted in **C2.10** for lift shafts is similar to that adopted by the BCA for stairway shafts.

C2.10 applies to all classes of buildings and specifies the protection requirements for openings both for lift landing doors and services.

Lifts in Type A and B Construction

In any building required to be of Type A construction, the lift shaft walls must have the relevant fire-resistance level (FRL) prescribed by **Table 3 of Specification C1.1**. It does not matter what Class the building is, nor whether the shaft walls are loadbearing.

In any building required to be of Type B construction, the lift shaft walls must have the relevant FRL prescribed by **Table 4 of Specification C1.1** if they are loadbearing. If they are non-loadbearing they must be of non-combustible construction.

As all emergency lifts are required to be fire separated from the remainder of the building, **C2.10(c)** clarifies that the lift shaft is to have an FRL of not less than 120/120/120.

C2.10(d) only applies to fire-isolated lift shafts. Lift landing doors and indicator panels are covered by **C3.10**. Openings for other services must comply with any other appropriate provisions in **Part C3**.

If a lift is wholly in an atrium, it is not required to be in a fire-isolated shaft. This is because the atrium comprises a single fire compartment.

Patient care and resident areas

Any lift in a patient care area in a Class 9a building, or a resident use area in a Class 9c building is to be in a fire-isolated shaft. In a Class 9a or 9c building that is required to be of Type A or B construction it is to have an FRL of 120/120/120. In a Class 9a or 9c building of Type C construction the shaft is to have an FRL of 60/60/60.

Lifts in Type C construction

Apart from emergency lifts and lifts in patient care and resident use areas, lifts need not be in a fire-isolated shaft if the building is of Type C construction. This is because such buildings are not required to have fire-rated floors or any fire compartmentation between storeys.

C2.11 Stairways and lifts in one shaft

Intent

To maintain a safe evacuation route for people using a fire-isolated stairway, by separating the stairway shaft from the lift shaft.

Lift shafts do not offer the same fire protection to occupants as fire-isolated stairway shafts. This is because lift landing doors to shafts have no insulation properties and do not seal against smoke to the same extent as fire doors to stairway shafts. Also, many lift over-runs are places where rubbish or other combustible materials may accumulate and are therefore potential fire-sources.

C2.12 Separation of equipment

Intent

To limit the spread of fire from service equipment having a high fire hazard or potential for explosion and to ensure emergency equipment continues to operate during a fire.

C2.12 is part of the Deemed-to-Satisfy Provisions for **CP6** and **CP7**.

The types of equipment referred to in **C2.12(a)(i) and (ii)** and **C2.12(c)** need to continue to operate during an emergency, such as a fire. It is therefore important to stop the spread of fire to this equipment.

The requirement under **C2.12(c)** that on-site fire pumps comply with **E1.3**, rather than **C2.12(d)**, recognises the importance of this equipment to fire-fighting.

The types of equipment referred to in **C2.12(a)(iv) and (v)** have a high explosive potential. It is important that any fire in this type of equipment does not spread to other parts of the building.

Not all equipment is required to be protected. Examples are listed in **C2.12(b)**. This equipment is either designed to withstand high temperatures during a fire, or is required to be protected by other parts of the BCA.

Under **C2.12(d)**, the minimum fire-resistance level (FRL) for construction used to separate the equipment listed in **C2.12(a)** from the remainder of the building is 120/120/120, with –/120/30 fire doors. However, if **Specification C1.1** (particularly **Tables 3, 4 or 5**) requires a higher FRL, then that higher FRL applies.

C2.13 Electricity supply system

Intent

To limit the spread of fire from electrical equipment and to enable the uninterrupted operation of emergency equipment during a fire.

C2.13 is part of the Deemed-to-Satisfy Provisions for **CP6** and **CP7**.

Certain types of electrical equipment have a high potential for explosion as well as fire. **C2.13(a)** requires that the doorways to sub-stations be protected with –/120/30 fire doors to avoid the spread of any fire from the electrical equipment.

Some State and Territory authorities may have additional requirements for the construction of electricity sub-stations. See relevant State or Territory Appendix to the BCA.

To enable the required emergency equipment to continue to operate during any emergency, the following must be achieved:

- The main switchboard referred to in **C2.13(b)** must be separated from other parts of the building by construction having a fire-resistance level (FRL) of 120/120/120, and any door openings protected with –/120/30 fire doors.
- The electrical conductors referred to in **C2.13(c)** must comply with the appropriate sections of AS/NZS 3013—Wiring installations—Wiring systems for specific applications, or be protected by fire rated construction with an FRL of 120/120/120.

Protection of electricity supply systems

ABCB funded research determined that providing physical segregation between non-emergency equipment switchgear and emergency equipment switchgear reduces the impact of potential damage from fire by 40%. It is essential that this equipment continue to operate during a fire. **C2.13(d)** therefore requires the emergency equipment to be segregated from the other equipment in all switchboards by metal partitions designed to prevent the spread of any fault from the non-emergency equipment to the emergency equipment.

C2.13(e) lists the emergency equipment required by **C2.13(d)** to be separated from non-emergency equipment in a switchboard.

C2.14 Public corridors in Class 2 and 3 buildings

Intent

To minimise the risk of long public corridors in Class 2 and Class 3 buildings becoming smoke logged.

In a building fire, certain people are subject to greater risks than others, for example, the very young, elderly, people with disabilities, and those who are asleep.

In a Class 2 or Class 3 building there is a very high risk that building occupants will be asleep when a fire occurs. It is important that they be able to safely evacuate the building. To assist in the safe evacuation, long public corridors should not become smoke logged.

C2.14 therefore requires the division of the public corridors into 40 metre lengths, by smoke walls and smoke doors. The details of the smoke walls are set out in **Specification C2.5**, and details for the smoke doors are set out in **Specification C3.4**.

The measurement of the length of the public corridor includes the sum of all connected corridor lengths that are continuous within a separate storey, smoke compartment or fire compartment.

SUPERSEDED
FIRE RESISTANCE

PART **C3** PROTECTION OF OPENINGS

Objective

Functional Statements

Performance Requirements

The Objectives, Functional Statements and Performance Requirements for **Section C** are at the beginning of **Section C**.

Deemed-to-Satisfy Provisions

C3.0 Deemed-to-Satisfy Provisions

Intent

To clarify that the requirements of **CP1** to **CP9** will be satisfied if the building complies with Parts **C1**, **C2** and **C3**, and Parts **G3** and **H1**, if applicable.

See **Deemed-to-Satisfy Provisions** for **C1**. The same applies here.

C3.1 Application of Part

Intent

To clarify which openings must comply with the Deemed-to-Satisfy Provisions of **Part C3**.

Openings listed in **C3.1(a)** need not comply with the Deemed-to-Satisfy Provisions of **Part C3**.

Openings listed in **C3.1(b)** and **(c)** must comply with the relevant **Part C3** Deemed-to-Satisfy Provisions.

C3.2 Protection of openings in external walls

Intent

To require any opening in external walls to be protected, only where the wall is required to have an FRL, to prevent the spread of fire from the boundary of an adjoining allotment, or one building to another building on the same allotment.

C3.2 applies to all Class 2–9 buildings, even those protected by a sprinkler system. The provisions only apply to openings which are exposed to a fire source feature (ie an allotment boundary or another building on the same allotment) and which are located in an external wall required to have an FRL (see **Figure C3.2**).

Any openings in the external walls of buildings separated by fire walls must comply with **C3.2**. In this case, each building is a fire-source feature to the other building (see **Figure C3.2**).

Protection of openings

Openings in an external wall must be protected if within 3 metres of a side or rear boundary (see **C3.2(a)(i)**). Or, under **C3.2(a)(ii)**, if they are within 6 metres of the far boundary of an adjoining road, etc, if the opening is located in a storey above, or a reasonable distance from ground level. Openings must also be protected if they are within 6 metres of another non-Class 10 building on the allotment (see **C3.2(a)(iii)**).

In regards to the protection of openings under **C3.2(a)**, an assessment is required to determine a “reasonable” distance from ground level, on a case by case basis. Discussions with the appropriate authority may be required in this regard.

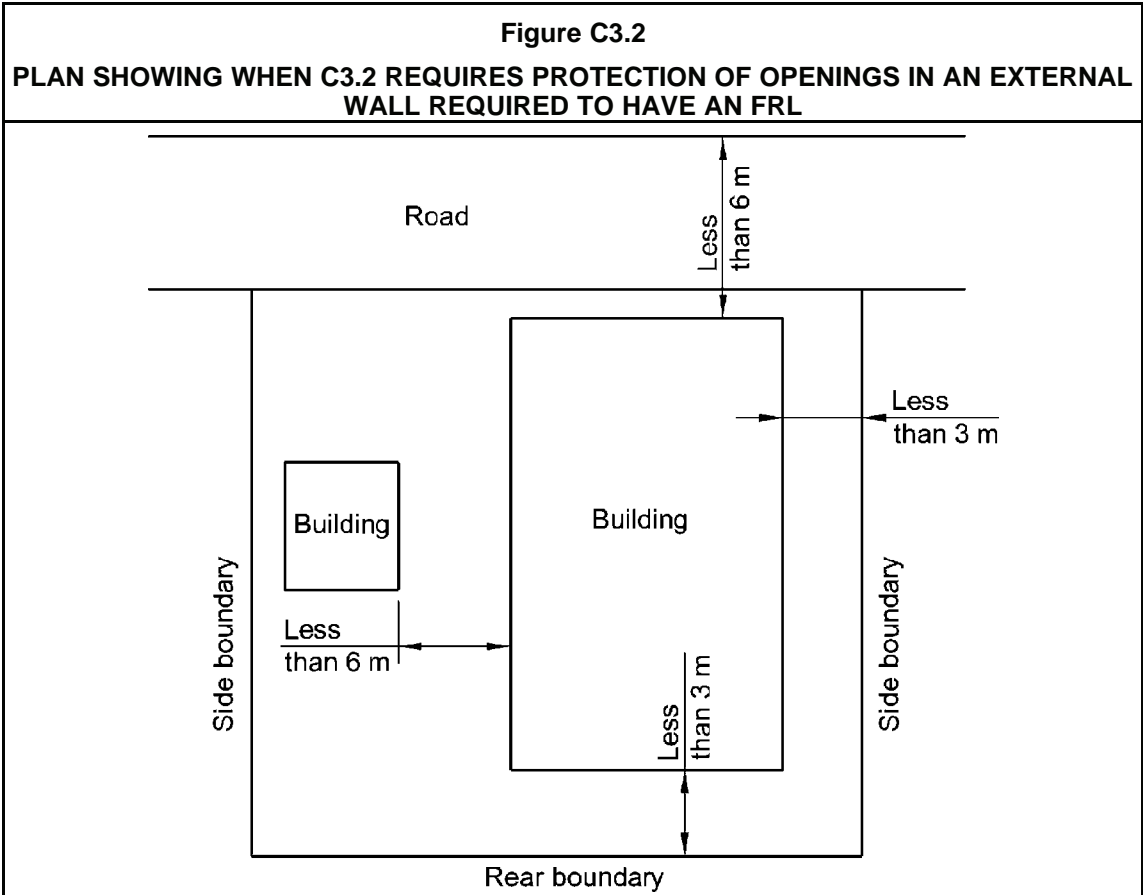

Under **C3.2(b)**, openings in an external wall must be limited to the size specified, if the openings are required to be protected under **C3.2(a)**. This is unless the openings are in a Class 9b open spectator stand.

C3.3 Separation of external walls and associated openings in different fire compartments

Intent

To limit the spread of fire between fire compartments through external walls and the openings in them.

Figure C3.3 illustrates the use of **Table C3.3**.

When the walls are at an angle of 180° or greater, the distance between them may be zero because the effects of radiant heat between the walls is negligible. In practice, the distance between such walls is likely to equal the width of the fire wall.

Sole-occupancy units in Class 2 and Class 3 buildings are not fire compartments to which **C3.3** applies.

**Figure C3.3
PLAN SHOWING ILLUSTRATION OF TABLE C3.3**

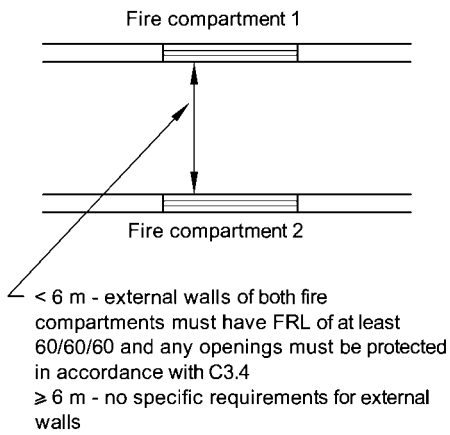

(a) External walls at 0° (parallel)

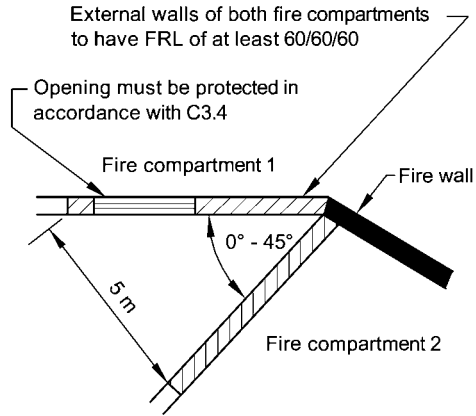

(b) External walls between 0° - 45°

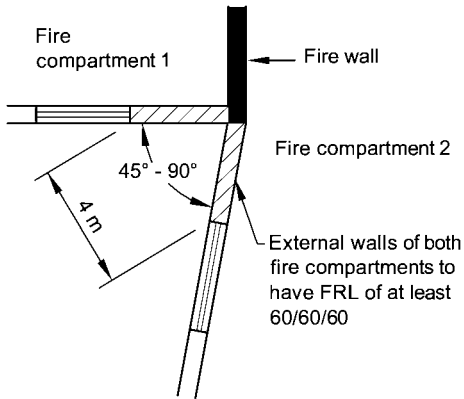

(c) External walls between 45° - 90°

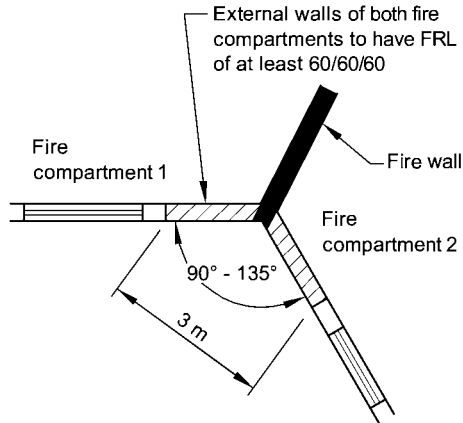

(d) External walls between 90° - 135°

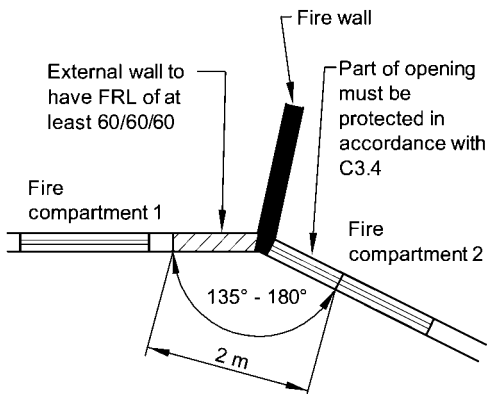

(e) External walls between 135° - 180°

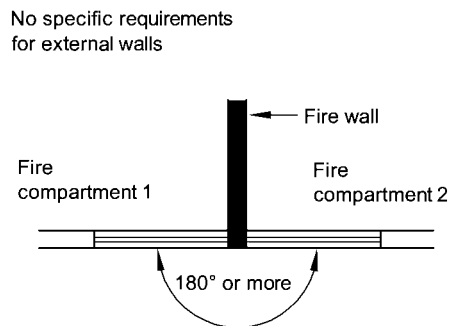

(f) External walls 180° or more

C3.3 applies to both external walls. It does not apply to fire walls separating fire compartments. (A fire wall is not always an internal wall. See **Figure C2.7(3)** of this Guide).

C3.4 Acceptable methods of protection

Intent

To set out acceptable methods of protection required for different types of openings in a building.

C3.4(a) applies where protection is required to doorways, windows and other openings.

C3.4(b) requires fire doors, fire windows and fire shutters to comply with **Specification C3.4**.

C3.4 is referred to by a number of the BCA's Deemed-to-Satisfy Provisions. Some of these provisions will specify whether or not a required sprinkler system must be internal or external. Where external wall wetting sprinklers are proposed, it may be designed using AS 2118.2, even though that Australian Standard is not referenced in the BCA. Please note that there are certain limitations that apply to AS 2118.2, such as the types of glazing applicable and location of sprinkler heads.

Examples

Examples of the references to **C3.4** in the other Deemed-to-Satisfy Provisions include the following:

- **C3.2** refers to **C3.4** for the protection required for openings in the external walls of a building located close to a fire-source feature.
- **C3.3** allows the distance between openings in the external walls of a fire compartment to be closer than allowed by **Table C3.3** if they are protected in accordance with **C3.4**.
- **C3.8** requires the protection of certain window openings in fire-isolated exits.
- **D1.7(c)(ii)**, regarding travel from an exit point of discharge within 6 metres of an opening in an external wall.
- **D1.8**, regarding travel past openings within 6 metres of an external stairway.
- **C3.11(g)(v)(A)** requires the protection of certain windows in bounding walls of Class 2 and 3 buildings and Class 4 parts as an option.

C3.4(a)(i) clarifies that wall-wetting sprinklers are only to be used with doors that are self-closing or automatic closing.

C3.4(a)(ii) clarifies that wall-wetting sprinklers are only to be used with automatic closing windows or permanently closed windows.

For openings other than doorways or windows, **C3.4(a)(iii)(A)** clarifies that internal or external wall-wetting sprinklers are not recognised as an acceptable method of protection for voids under the Deemed-to-Satisfy Provisions. Conventional wall-wetting sprinklers need a medium or surface to act on. An opening consisting of a void does not provide such a medium or surface.

C3.5 Doorways in fire walls

Intent

To maintain the integrity of fire walls by limiting the spread of fire through doorways.

If the opening in the fire wall is for a horizontal exit, refer to **C3.7**.

When a doorway is installed in a fire wall, to achieve the same fire separation as the wall, **C3.5(a)** allows the use of:

- two fire doors, one on each side of the doorway;
- two fire shutters, one on each side of the doorway;
- one fire door and one fire shutter, one on each side of the doorway;
- a single fire door; or
- a single fire shutter.

(See **C3.5(a)(i)**, **C3.5(a)(ii)** and **C3.5(a)(iii)**)

In each option, the single fire door or shutter, or any of the combinations of the two, must have the same fire-resistance level (FRL) as the fire wall. (This is except for the insulation criterion, which must be at least 30 minutes)

When determining the required FRL of the fire door or shutter, **Clause 6 of Specification A2.3** states that non-loadbearing elements need not comply with the structural adequacy criterion. A fire door or shutter is normally regarded as a non-loadbearing element.

Example

Consider the case of a fire wall required to have an FRL of 240/240/240. After taking into account the concession allowed by **Clause 6 of Specification A2.3**, **C3.5** allows any doorway in that wall to be protected by:

- two –/120/30 fire doors, one on each side of the doorway;
- two –/120/30 fire shutters, one on each side of the doorway;
- a –/120/30 fire door and a –/120/30 shutter door, one on each side of the doorway;
- a single –/240/30 fire door; or
- a single –/240/30 fire shutter.

Closure of fire doors and shutters

C3.5(b)(i) states that any fire door or shutter required under **C3.5(a)** must be either self-closing or automatic-closing. If automatic closing, it must be initiated by smoke detectors, or (in specified circumstances) any other detector deemed suitable in accordance with AS 1670.1 (see **C3.5(b)(ii)**). It is important that the detector used is suitable for the location and type of fire likely to occur. The suitability of detectors can be determined by reference to AS 1670.1. These detectors must also be in accord with the relevant provisions of AS 1670.1, and located as specified in **C3.5(b)(ii)**.

Under **C3.5(b)(iii)**, the activation of any other required suitable fire alarm system (including a complying sprinkler system), in either of the fire compartments separated by the fire wall, must operate the automatic closing of the fire door or shutter.

A smoke detector can give false alarms if the atmosphere contains particles such as steam or other vapours that obscure vision (eg kitchens, carparks, etc). If a smoke detector is likely to give a false alarm due to the atmospheric conditions, then a heat detector should be used to comply with **C3.5(b)(ii)**.

Figure C3.5 illustrates the requirements of **C3.5**.

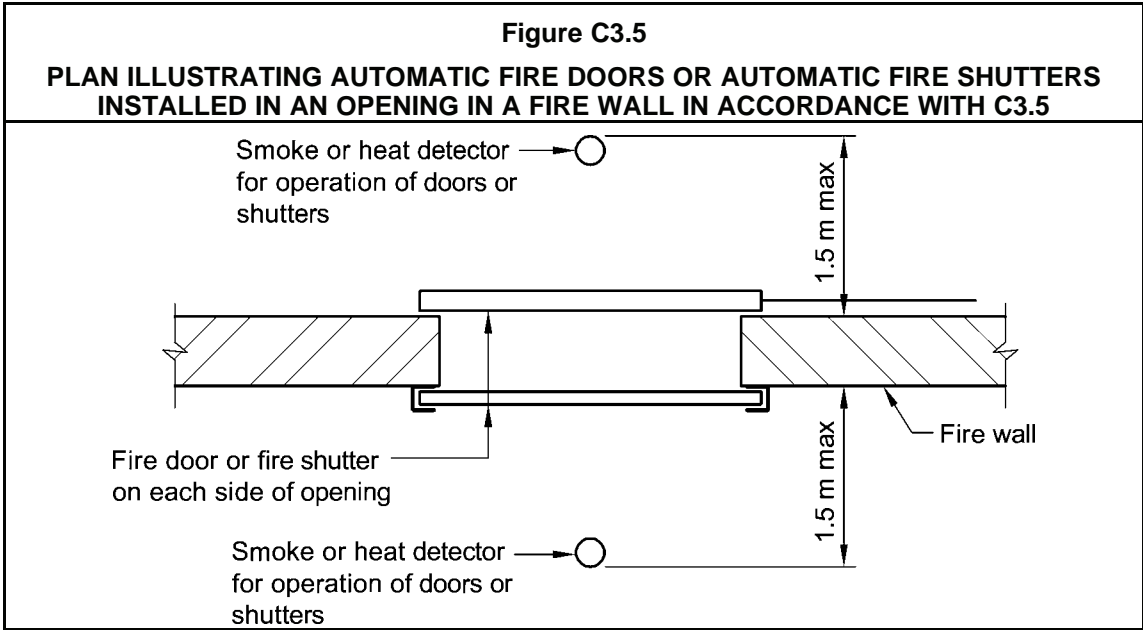

C3.6 Sliding fire doors

Intent

To avoid danger to occupants caused by the automatic closing of a sliding fire door.

It is an acceptable and frequently used option to protect an opening in a fire wall by a sliding fire door held open by an electromagnetic device. However, sliding fire doors tend to be quite large and heavy, presenting a potential danger to occupants passing through while it is closing. To reduce the danger to building occupants the rate of the door's closing is limited and must be by the deactivation of an electromagnetic device (see **C3.6(a)(i)**).

In the event of a power failure, the electromagnetic device must also fail-safe so that the door closes thereby maintaining the integrity of the fire wall (see **C3.6(a)(ii)**).

Warning lights and signs are required to be installed on each side of the door by **C3.6(a)(iii) and (iv)** to indicate the presence and operation of the fire door. **C3.6(b)** requires the electromagnetic device to deactivate and the warning system to operate when there is a fire in a fire compartment on either side of the fire wall. This process must be activated by either smoke detectors or heat detectors (in specific circumstances) installed in accordance with the relevant provisions of AS/NZS 1905.1 and AS 1670.1 (see **C3.6(b)(i)**).

The activation of any other required suitable fire alarm system (including a complying sprinkler system) in either of the fire compartments must also cause the automatic closing of the fire door (see **C3.6(b)(ii)**).

A smoke detector can give false alarms (see comments on **C3.5**). Heat detectors complying with **C3.6(b)(i)** should be used in these circumstances.

C3.7 Protection of doorways in horizontal exits

Intent

To provide occupants using a horizontal exit with the same protection as those using a fire-isolated exit.

Types of doors permissible

The use of fire shutters are prohibited in a horizontal exit by [D2.19\(b\)\(ii\)](#). Similarly, [D2.19\(b\)\(iii\)](#) does not permit sliding doors to be used as horizontal exits.

There are some concessions to these prohibitions (see [D2.19](#)).

The fire doors used for horizontal exits, as referred to in [C3.7](#), must swing in the direction of travel (as required by [D2.20](#)).

If the horizontal exit applies in both directions (ie the doorway may be used to escape from either fire compartment to the other), the installation of two doors may be necessary (see [Figure C3.7](#)).

Buildings other than Class 7 and 8

Unless it is located in a Class 7 or Class 8 building, a doorway which is part of a horizontal exit must be protected by a single fire door complying with [C3.7\(a\)\(i\)](#).

Two fire doors in Class 7 and 8

The reason for allowing two fire doors to be installed in a doorway in Class 7 and Class 8 buildings is because single fire doors with the required fire-resistance level (FRL) are heavy and difficult to open. In combination, the two fire doors must achieve an equivalent FRL to the fire wall.

If two fire doors are installed in a doorway in a Class 7 or Class 8 building, it may be necessary to install a small lobby to allow for the swing of the doors (see [Figure C3.7](#)).

[C3.7\(b\)\(i\)](#) has the same requirements for fire doors as [C3.5](#). Refer to the comments made in [C3.5](#) for application to [C3.7\(a\)](#).

Figure C3.7
PLAN SHOWING HORIZONTAL EXITS IN A FIRE WALL

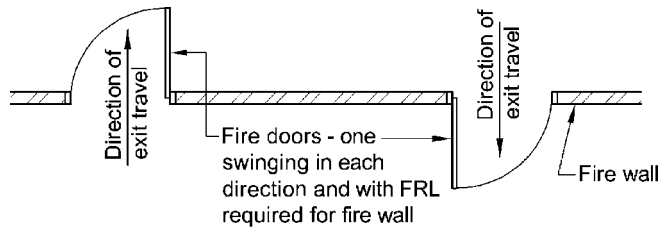

(a) Exit travel in both directions

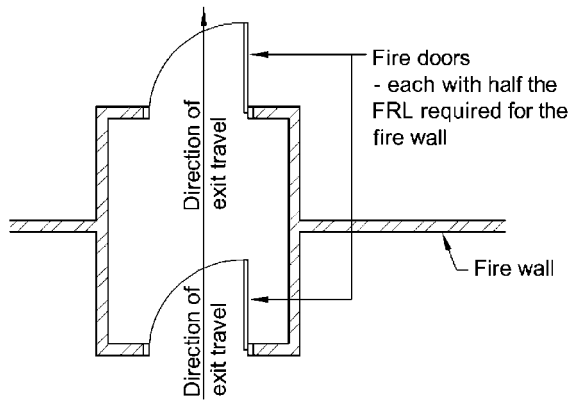

Class 7 or 8 building (use of 2 doors)

(b) Exit travel in one direction

C3.8 Openings in fire-isolated exits

Intent

To maintain the integrity of a fire-isolated exit and to protect people using fire-isolated exits by providing adequately protected door and window openings.

Doorways

Any doorway leading into a fire-isolated exit is a possible source of fire and/or smoke spreading into that exit. The spread of fire or smoke into a fire-isolated exit is dangerous.

It is therefore important that such doorways are protected by fire doors. These fire doors must be self-closing (see [C3.8\(a\)\(i\)](#)) or automatic-closing initiated by smoke detectors or (in specified circumstances) heat detectors (see [C3.8\(a\)\(ii\)](#)).

[C3.8\(a\)](#) has the same requirements for fire doors or shutters as [C3.5](#). Refer to the comments made in [C3.5](#) for application here.

[C3.8\(a\)](#) does not apply to a doorway leading from a fire-isolated exit to a road or open space, because failure of such a doorway is not affected by a fire in the building. However, note that such a doorway may require protection to comply with [C3.2](#).

Windows

C3.8(b) only applies to a window which could expose an evacuating person or fire fighter to radiant heat from a fire in the building. Therefore, **C3.8(b)** does not apply to a window exposed to another window within the same fire-isolated exit.

If a sprinkler system is chosen as the means of protection in accordance with **C3.4**, the sprinkler heads must be located on the side of the window outside the exit.

A window subject to the requirements of **C3.8(b)** may also require protection from an external fire to comply with **C3.2**.

C3.9 Service penetrations in fire-isolated exits

Intent

To maintain the integrity of a fire-isolated exit and to protect the people using them by providing protection to service penetrations.

C3.9 minimises the number of service penetrations into a fire-isolated exit by only allowing the services specified. Each of the services listed in **C3.9(a) and (b)** is essential to maintain a safe environment within the fire-isolated enclosure.

Under **C3.9(c)**, the water supply for fire-fighting may be located within a fire-isolated exit. Hydrants located within a fire-isolated enclosure allow the fire brigade to set up their hoses and other equipment in a protected area before attacking the fire.

The location of any service penetrations into the fire-isolated exit permitted by **C3.9** must not reduce the exit width required by **D1.6**.

C3.9 should be read in conjunction with **D2.7**, which deals more generally with installations in exits and paths of travel.

C3.10 Openings in fire-isolated lift shafts

Intent

To maintain the integrity of a fire-isolated lift shaft and to limit the spread of fire from one floor of a building to another floor by way of a lift shaft.

Any doorway leading into a fire-isolated lift shaft could assist the spread of fire. Any spread of fire into the shaft could endanger the lives and safety of the people using the lift, and lead to the spread of fire to another part of the building. Therefore, it is important that such doorways be protected by fire doors.

AS 1530.4 (the Australian Standard for the Standard Fire Test) requires lift landing doors to be tested for integrity. Such doors are usually of metal construction, and are not required to satisfy any insulation criteria.

Lift indicator panels in excess of 35 000 mm² are considered to represent a sufficient risk of spreading fire into a lift shaft. Indicator panels exceeding this size require backing by material having a fire-resistance level (FRL) of –/60/60.

Small panels of 35 000 mm² or less are unlikely to lead to the spread of fire into the shaft. This exemption is similar in principle to those allowed by **C3.1** for minor openings such as control joints, weep holes, sub-floor ventilators and the like.

C3.11 Bounding construction: Class 2, 3 and 4 buildings

Intent

To maintain the performance of a wall bounding any sole-occupancy unit or public corridor in Class 2 or Class 3 buildings; and any sole-occupancy unit in a Class 4 part.

Protection of doorways

To maintain the fire performance of walls surrounding a sole-occupancy unit and corridors used as egress routes in Class 2 and Class 3 buildings, **C3.11(a)** and **(b)** requires the following doorways to be protected:

- between sole-occupancy units and any public corridor, public hallway or the like (see **C3.11(a)(i)**);
- between sole-occupancy units and any room not within a sole-occupancy unit, such as a common laundry, common sitting room and the like (see **C3.11(a)(ii)**);
- between sole-occupancy units and any landing of an internal, non-fire-isolated stair serving as a required exit (see **C3.11(a)(iii)**);
- between sole-occupancy units (see **C3.11(a)(iv)**);
- between a room not in a sole-occupancy unit (such as a common laundry, common sitting room and the like) and any public corridor, public hallway or the like (see **C3.11(b)(i)**); and
- between a room not in a sole-occupancy unit (such as a common laundry, common sitting room and the like) and any landing of an internal, non-fire-isolated stair serving as a required exit (see **C3.11(b)(ii)**).

To maintain the fire performance of walls surrounding a sole-occupancy unit in a Class 4 part of a building, **C3.11(c)** requires the doorways to the unit to be protected.

Fire protection required for doorways

The degree of fire protection required by **C3.11(d)** for doorways to sole-occupancy units in Class 2 and Class 3 buildings and Class 4 parts is dependant upon the types of construction.

C3.11(d)(i) applies to all Class 2 and Class 3 buildings and Class 4 parts in buildings of Type A construction, except those Class 3 buildings specified in **C3.11(d)(iii)**.

C3.11(d)(ii) applies to all Class 2 and Class 3 buildings and Class 4 parts in buildings of Type B or Type C construction, except those Class 3 buildings specified in **C3.11(d)(iii)**.

C3.11(d)(iii)(A) or (B) only applies to Class 3 residential aged care buildings fitted with a sprinkler system complying with **Specification E1.5**. A Class 3 residential aged care building that does not meet these requirements, must comply with **C3.11(d)(i) or (ii)** as applicable.

C3.11(d)(ii) requires that the door be self-closing to make sure that the door is closed during a fire. The requirement for such doors to be self-closing does not apply to a Class 3 residential aged care building which meets the requirements of **C3.11(d)(iii)(A)**.

Openings other than doorways

Under **C3.11(e)**, openings other than doorways in internal walls which are required to have a fire-resistance level (FRL) for integrity and insulation are permitted only if they do not lower the wall's fire-resisting performance.

Automatically closing doors

Doors required by **C3.11(d)** may be automatic-closing, initiated by smoke detectors or (in specified circumstances) any other detector deemed suitable in accordance with AS 1670.1 (see **C3.11(f)(ii)**). The suitability of detectors can be determined by reference to AS 1670.1. Refer to **C3.5** for door operation requirements as they apply to doors under **C3.11**.

Path of travel to an exit

C3.11(g) applies, in a Class 2 or Class 3 building only, where a path of travel is along an open balcony, landing or the like and it does not provide a person evacuating with a choice of travel in different directions to alternative exits. If this path of travel passes an external wall of another sole-occupancy unit (see **C3.11(g)(i)**) or a room which is not within a sole-occupancy unit (see **C3.11(g)(ii)**), the external wall must be constructed in accordance with **C3.11(g)(iii)**, have any doorways protected in accordance with **C3.11(g)(iv)**, and any window or other openings protected in accordance with **C3.11(g)(v)(A) or (B)**.

The reason for the above construction is to provide building occupants trying to evacuate with protection from radiant heat and flames whilst passing the unit that is on fire.

C3.12 Openings in floors and ceilings for services

Intent

To limit the spread of fire through service openings in floors and ceilings required to resist the spread of fire.

C3.12 applies to floors and ceilings in buildings of Type A, B and C construction.

The performance of a fire resisting element may be compromised if service penetrations are not adequately protected. The method of protection should ensure the fire resisting capabilities of the element being penetrated is maintained. In buildings of Type A construction, the service may be within a fire resisting shaft or protected in accordance with **C3.15**. In buildings of Type B and C construction the service may be within a shaft that does not reduce the fire resistance of the element it penetrates or it must be protected in accordance with **C3.15**.

C3.13 Openings in shafts

Intent

To maintain the fire performance of the floor by limiting the spread of fire through openings in shafts.

C3.13 only applies to buildings of Type A construction, because the other types of construction do not require service shaft walls to have a fire-resistance level (FRL).

C3.13 sets out the detail of the protection required in different circumstances to prevent the spread of fire from one floor to another floor by way of a shaft.

C3.14 * * * * *

In BCA 1990, this provision was performance-based. In subsequent editions of the BCA the provision is covered by the Performance Requirements. **C3.14** has been left blank, rather than renumber subsequent clauses.

C3.15 Openings for service installations

Intent

To maintain the fire performance of building elements by limiting fire spread by way of service penetrations.

C3.15 sets out a number of requirements for protection of service openings. These include:

- The use of tested prototypes in accordance with AS 4072.1 and AS 1530.4 (see **C3.15(a)**).
- Ventilation and air-conditioning ducts complying with AS/NZS 1668.1 (see **C3.15(b)**).
- The use of **Specification C3.15** for metal pipes systems (excluding pipe seals or the like), sanitary plumbing, wire or cable, or clusters of wires or cables, electrical switches, or outlets or the like.

C3.15 considers the protection of openings in elements that are providing a barrier to the spread of fire and are thus required to have an FRL. The elements of an FRL that provide the barrier to spread of fire are insulation and integrity and that protecting an opening in an element an FRL for structural adequacy is unnecessary. For this reason, **C3.15** only applies to an element required to have an FRL with respect to integrity or insulation.

Tested systems permitted

C3.15(a)(i) quite clearly permits the use of tested systems. To comply with this Deemed-to-Satisfy Provision it is necessary for the appropriate authority to be satisfied that the proposal is identical to a tested prototype. AS 1530.4 includes a number of methods of reporting the test results. These include—

- a test report.
- a regulatory information report.
- a test certificate.

Only the test report and regulatory information report contain sufficient information to allow the appropriate authority to be satisfied that the proposal is identical with the tested prototype.

It should be noted that the provision only applies to the service where it penetrates the building element. Although AS 4072.1 and AS 1530.4 requires a tested penetration to extend a specified distance beyond the penetration opening for the purpose of carrying out the test, the BCA only requires the building element and the part of the service penetrating that element to be identical with the tested prototype.

Example

Consider a service penetration consisting of a plastic pipe passing through a concrete floor to a hand basin. AS 1530.4 requires the tested prototype service pipe to extend 2 m above the floor. However, due to the height of the hand basin above the floor, the pipe is unlikely to extend more than say 800 mm. **C3.15(a)(i)** allows this configuration provided it is identical to the tested prototype where the service pipe passes through the floor.

Variation from tested systems for metal piping systems

C3.15(a)(ii) allows a concession from the insulation criteria of a tested prototype specified in **C3.15(a)(i)**. The concession only applies for penetrations by metal piping systems where the service pipe is not located within an exit (see **C3.15(a)(ii)(D)**) and is at least 100 mm from any combustible building element for a distance of 2 m from the penetration of the building element (see **C3.15(a)(ii)(B)**). To ensure that fire is not spread via the conduction of heat from the metal

pipe, it is important that the service pipe be located so that combustible material cannot be located within 100 mm of the pipe for a distance of 2 m from the penetration (see **C3.15(a)(ii)(C)**). One method of achieving this would be to place a guard around the pipe.

In the case of a floor waste, it would not be possible to ensure that no combustible material is located within 100 mm of it. Therefore, **C3.15(a)(ii)** is unlikely to apply to floor wastes.

Approval of other types of penetrations

Specification C3.15 does not apply to larger diameter electrical cables (ie where the opening is larger than those specified in **Clause 5(a) and (b)** of 2 000 mm² or 500 mm²). This does not mean that larger diameter electrical cables cannot be approved under **C3.15**. Larger diameter electrical cables can be approved under **C3.15(a)(i)** (i.e. a tested system) or, if necessary, as an Alternative Solution.

Gas pipes can be approved under **C3.15(a)** or, if necessary, as an Alternative Solution.

C3.16 Construction joints

Intent

To limit the spread of fire between building elements required to be fire-resisting.

To avoid the spread of fire between fire compartments or to another building, construction joints between building elements are normally packed with fire retardant material.

A number of proprietary products are suitable for this purpose, having previously been tested in accordance with AS 1530.4 to demonstrate they have achieved the required fire-resistance level (FRL). The test only needs to record the failure criteria of integrity and insulation. **C3.16** does not require structural adequacy criteria to be achieved, as it is not part of the AS 1530.4 test for these types of materials.

C3.17 Columns protected with lightweight construction to achieve an FRL

Intent

To prohibit columns with lightweight fire protection from lowering the fire-resistance levels (FRLs) of other building elements.

If lightweight fire protection has been inadequately applied to a column, there is an increased risk that the column will transmit heat to another building element (such as a floor or ceiling) through which it passes. The effect is that the column can cause a reduction in the fire-resistance level (FRL) or resistance to the incipient spread of fire of the elements through which it passes. This can result in the spread of fire. To eliminate this potential problem, it is necessary to use a system tested in accordance with AS 1530.4.

SPECIFICATION **C1.1** FIRE-RESISTING CONSTRUCTION

Deemed-to-Satisfy Provisions

1 Scope

Intent

To clarify that **Specification C1.1** contains requirements for fire-resisting construction of building elements.

Note that **Specification C1.1** applies only to the Deemed-to-Satisfy Provisions of the BCA. If an Alternative Solution is used to satisfy a Performance Requirement, it is not necessary to comply with **Specification C1.1**.

Parts **C1**, **C2**, **C3**, **D1**, **D2**, **G2**, **G3** and **H1** of the BCA also contain requirements for building elements to be fire-resisting and to have a fire-resistance level (FRL).

2 General Requirements

2.1 Exposure to fire-source features

Intent

To define how a building element may be exposed to a fire-source feature.

Fire-source feature

Refer to the definition in **A1.1** on the term “fire-source feature”.

A fire-source feature is a possible fire-source external to the building from which fire could spread into the building. It may be an allotment boundary or another building on the allotment from which fire could spread to the subject building.

Clause 2.1 does not consider a building element to be exposed to a fire-source feature if it is shielded from the fire-source feature by another part of the building which:

- has an FRL of 30/-/- or more, and is not transparent or translucent;
- is less than 15 metres above another building on the allotment. Parts of a building more than 15 metres above another building are not deemed to be affected by fire; or
- is below the level of the finished ground at every relevant part of a side or rear boundary.

Figure Spec C1.1(1) illustrates some of the exemptions from the exposure to a fire-source feature.

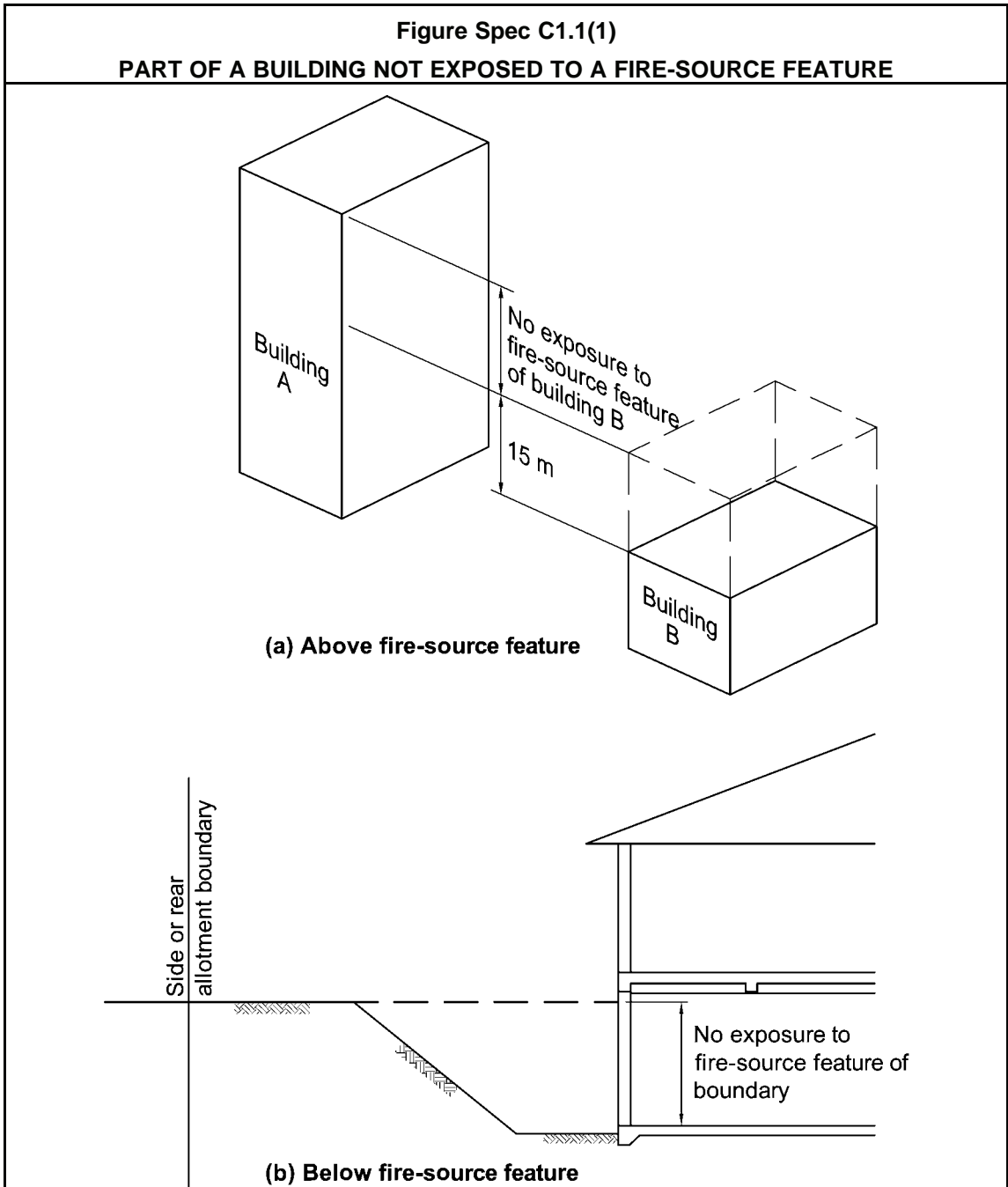

The building element must have an FRL required for the closest part of the element exposed to the fire-source feature (see [Clause 2.1\(c\)\(i\)](#)).

Alternatively, the building element may have a varying FRL according to the individual distance of each section of the building element from the fire-source feature (see [Clause 2.1\(c\)\(ii\)](#)).

Figure Spec C1.1(2) illustrates the alternatives for an external loadbearing wall of a Class 5 building required to be of Type A construction.

2.2 Fire protection for a support of another part

Intent

To minimise the risk that a building element required to have a fire-resistance level (FRL) will fail during a fire due to the failure of another element required to give it vertical or lateral support.

Support of building elements with an FRL

Clause 2.2(a) sets out the requirements for the fire protection of building elements that provide lateral or vertical support to another building element. This is because a building element with an FRL is usually dependent on the support to maintain its FRL.

Accordingly, **Clause 2.2(a)** does not apply to elements that support ceilings required to have a fire-protective covering or a resistance to the incipient spread of fire. Nor to an element required to be non-combustible.

Exceptions of building elements

Clause 2.2(b) lists a number of exemptions to **Clause 2.2(a)(ii)** and **(a)(iii)(B)**.

The lateral support for the types of wall referred to in **Clause 2.2(b)(i)** is considered unnecessary in these cases, because **Clause 5.1(b)** allows the use of brick veneer walls, and **C1.11** enables the prevention of outward collapse of certain external walls by specifying the connection of panels to the building's frame.

The inherent fire resistance of the supports included in **Clauses 3.9, 4.2** and **5.2** is considered adequate in the carpark covered by each clause. It should be noted that compliance with the relevant Table is necessary in order to comply with the relevant clause.

Clause 2.2(b)(iii) exempts roofs providing lateral support to other building elements. This is because of a concession within **Clauses 3.5** for Type A construction. In addition, there is no requirement for Type B and C construction, principally because such buildings are generally low rise.

Clause 2.2(b)(iv) exempts certain columns, as listed in **Clause 2.5**, from having an FRL.

Under **Clause 2.2(b)(v)** a fire wall or fire-resisting wall referred to should not collapse because it is supported by another building element on the other side of the wall.

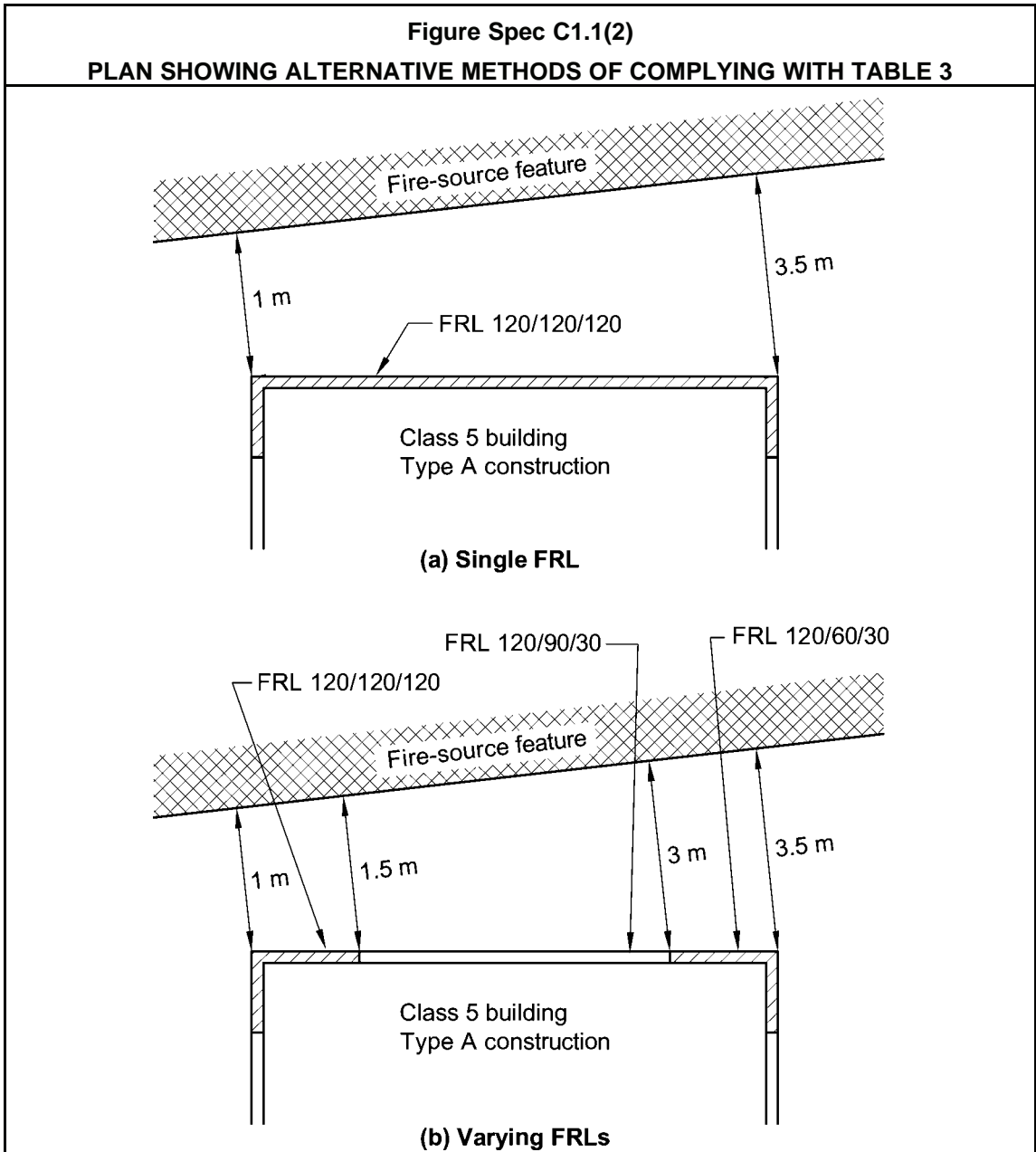

2.3 Lintels

Intent

To minimise the risk that the failure of a lintel over an opening in a wall required to have a fire-resistance level (FRL) will result in the failure of the wall during a fire.

A lintel must have the same FRL as the part of the building containing it. This is unless it does not contribute to the support of a fire door, fire window or fire shutter. Otherwise, the failure of the lintel during a fire could cause the collapse of all, or part, of the wall.

Clause 2.3 only applies to a lintel required by the Deemed-to-Satisfy Provisions to have an FRL.

Clauses 2.3(a) and **(b)** contain some concessions for small openings where the failure of the lintel would not result in a major collapse of the wall and lead to the spread of fire to another building.

2.4 Attachments not to impair fire-resistance

Intent

To minimise the risk that a finish, lining or attachment to a wall or roof required to have a fire-resistance level (FRL) will:

- impair the FRL of the wall or roof to which it is attached;
- compromise the safe evacuation of the building; and
- lead to the spread of fire by way of the building facade.

Clause 2.4 does not prohibit the use of combustible materials as a finish, lining or other attachment to a wall, roof or other building element required to have an FRL.

However, the combustible material can only be used if the material:

- is one of the exemptions from fire hazard properties listed in **C1.10(c)**, or complies with the fire hazard properties prescribed in **Specification C1.10** (see **Clause 2.4(a)(i)**);
- is not located in a position to make a required exit unusable in a fire, therefore it will not compromise the building's safe evacuation (see **Clause 2.4(a)(ii)**);
- will not lead to the spread of fire by way of the building facade (see **Clause 2.4(a)(iii)**); and
- will not impair the FRL of the wall, roof or other building element to which it is attached (see **Clause 2.4(b)**).

Clause 2.4(a) only applies to the use of finishes or linings, and other attachments. **Clause 2.4(b)** prohibits a required FRL of a building part from being reduced by the attachment of facings or finishes or the installation of ducting or any other service.

2.5 General concessions

Intent

To permit the use of certain building practices known to provide acceptable levels of fire safety.

The concessions contained in **Clause 2.5(a)** allow a steel column to not have an FRL in one and, in some cases, two storey buildings.

The basis for this concession is the low rise of such buildings. In many cases, the columns form the legs of a portal frame, with the roof being non-fire rated. In such a case, there would be little benefit in fire rating the column when the roof beams are not rated.

Because of the importance of the structural integrity of a common wall or fire wall in limiting the spread of fire, the concession for steel columns providing lateral support does not apply.

The concessions contained in **Clause 2.5(b)** permit a reduced FRL in timber columns in single storey buildings. One method of determining the FRL of a timber column is to use the charring rate of the type of timber in the column.

The structures on a roof referred to in **Clause 2.5(c)** are not likely to lead to the spread of fire, especially as they are required to be non-combustible. The intent of **Clause 2.5(c)(ii)(E)** is to specify that the concession does not apply to structures that contain units that in turn contain combustible liquids and gases.

The curtain walls referred to in **Clause 2.5(d)** must be non-combustible and protected by an external wall-wetting sprinkler system. When such construction is used, protection is provided from fire spreading to the subject building. For the term “curtain wall”, see **A1.1**. For the purposes of this provision, glass is regarded as non-combustible.

Balconies, verandahs and the like do not generally add a significant fire load to a building. Therefore, they are not required to be in compliance with **Table 3, 4** or **5**. This is provided that occupants are not put at risk during an evacuation because the only means of egress is by way of the balcony, verandah or the like.

Also, if the building is of Type A construction, the balcony, verandah or the like must be situated at a low level of the building, and have non-combustible supports.

2.6 Mezzanine floors: Concession

Intent

To provide concessions for small mezzanines.

The **Clause 2.6** concession does not apply to certain Class 9b buildings, as specified in **Clause 2.6(a)**. The concession only applies to certain small mezzanines, as specified in **Clause 2.6(b)**.

If it complies with the conditions specified in **Clause 2.6(b)**, a mezzanine and its support may be constructed from materials that do not have an FRL and/or are combustible.

Table 2.6 requires an increase in each FRL criterion of each wall or column that supports any other part of the building, and is within 6 metres of the mezzanine. There is no case in which a building element, with an increased fire rating, requires an FRL greater than 240 minutes.

Increasing the FRLs surrounding a mezzanine which is combustible, or which does not have an FRL, recognises the increased fire load that exists within both the mezzanine and the storey as a whole. This recognises the fire load limiting effect of the minimum area requirement in **Clause 2.6(b)(i)**.

2.7 Enclosure of shafts

Intent

To minimise compromising the fire-resisting performance of a shaft.

Shaft enclosures required to be fire-resisting must be completely fire-separated from all other portions of the building by building elements that have the appropriate fire-resistance.

Clause 2.7 complements other requirements for the walls of shafts by requiring that shafts be enclosed at the top and bottom by fire rated construction.

Clause 2.7 grants exemptions for the top and bottom of shafts in cases where the likelihood of fire entering the shaft is unlikely. This occurs when the top of the shaft is the top of the building (see **Clause 2.7(a)**), or the bottom of the shaft is laid on the ground (see **Clause 2.7(b)**).

2.8 Carparks in Class 2 and 3 buildings

Intent

To allow the use of residential levels of fire protection to be used for carparks in certain Class 2 and Class 3 buildings.

Part **A3** classifies a storey used for carparking as Class 7. The fire risks of a single storey carpark in a low-rise Class 2 or Class 3 building are not as substantial as they are in other carparks attached to other classifications, so a concession is suitable. This concession is based upon the assumption that the carpark associated with the Class 2 or 3 building will be for the exclusive use of the building occupants and that the carpark would represent a low fire risk.

The sole purpose of this concession is to allow the carpark and/or ancillary use storey to be regarded as a Class 2 or Class 3 building, as applicable, for the purposes of determining the fire resistance requirements of **Specification C1.1**.

This concession applies to buildings which are otherwise wholly Class 2, wholly Class 3 or a mix of Class 2 and 3 and:

- the storey to which the concession is to apply is used only for carparking, or an ancillary purpose such as storage of normal household items (see **Clause 2.8(a)(i)** and **(b)(i)**);
- in the case of Class 2 buildings, contain no more than 4 storeys (see **Clause 2.8(a)(ii)**); and
- in the case of Class 3 buildings or buildings that are a mix of Class 2 and 3, contain no more than 3 storeys (see **Clause 2.8(b)(ii)**).

The reason for the concession applying to an additional storey in Class 2 buildings is that the residents of these buildings are long term and are usually aware of the building layout and exit routes. This concept is consistent with **D1.3**.

The **Clause 2.8** concession does not apply if the building contains any other classification of building.

2.9 Residential aged care building: Concession

Intent

To allow concessions for the fire protection of certain building elements in Residential aged care buildings when a suitable sprinkler system is used to achieve an adequate level of occupant safety.

“Residential aged care building” is defined in **A1.1**.

This concession is a response to concerns expressed by aged care organisations and health authorities in regards to the impact of certain regulatory requirements on the design and operation of aged care hostels and nursing homes.

The requirements for fire separation of individual sole-occupancy units (including self-closing doors) in aged care hostels was considered to impose unwarranted development costs.

Fire compartmentation and the installation of door closers was considered to be impractical in the daily use of an aged care facility. Self-closing fire doors are too heavy and difficult to operate by frail, elderly people. In a number of cases this resulted in the doors being wedged open, thus negating the fire separation.

The limitation of the Class 1b concessions to buildings having an area of 300 m² or less and 12 occupants or less (see **A3.2**) meant that those concessions could not be used for many aged care hostels. The concessions in **Clause 2.9** are considered to be reasonable for the larger aged care hostels. In some States or Territories it is not acceptable for a Class 1b building to be used to house elderly people or other people who require special care.

The concession contained in **Clause 2.9(a)** applies to the requirements for floors and loadbearing walls as set out in **Tables 3, 4 and 5 of Specification C1.1**. The concession, allowing a reduction in FRLs, is limited to where the wall is an internal wall. An external wall is not subject to this concession.

The concession contained in **Clause 2.9(b)** for non-loadbearing internal walls, allows a reduction in FRLs subject to several conditions outlined in **Clause 2.9(b)**. The conditions outlined in **Clause 2.9(b)** must be achieved for the concession to apply. These conditions require walls to be:

- lined with 13 mm standard grade plasterboard, or a non-combustible material equivalent to 13 mm standard grade plasterboard (see **Clause 2.9(b)(i)**); and
- extend to the underside of the floor above, a ceiling lined with standard grade plasterboard not less than 13 mm thick or equivalent fire protective material, or a non-combustible roof covering. The wall height requirement aims to create a smoke proof wall. This aim requires that joints and the like be sealed to prevent the spread of smoke through potential cracks and openings (see **Clause 2.9(b)(ii)**).

Clause 2.9(b)(iii) requires that any insulation in a cavity in a non-loadbearing internal wall must be non-combustible. This is to limit the spread of fire by way of the wall cavity.

The mandatory use of non-combustible materials prohibits the lining of non-loadbearing internal walls with timber panelling. This does not restrict the use of timber mouldings and the like.

In addition to the above concessions for load bearing and non-load bearing walls, doors in a Class 3 building must still comply with the requirements of **C3.11(d)(ii)**, and walls must still comply with the requirements of Part **F5**—Sound Transmission and Insulation.

Other provisions relating to Residential aged care buildings are contained throughout the BCA. These include:

- **C3.11(d)(ii)**, regarding construction bounding sole-occupancy units and public corridors;
- **Clause 6(c)** of **Specification E2.2a**, regarding warning systems; and
- **Specification E1.5**, regarding sprinkler systems.

3 TYPE A FIRE-RESISTING CONSTRUCTION

3.1 Fire-resistance of building elements

Intent

To specify the fire-resistance level (FRL) and other requirements for building elements in Type A construction.

Table 3 of Specification C1.1 sets out the required FRLs of building elements in a building required to be of Type A construction. The required FRL depends on whether the element is loadbearing or non-loadbearing, if the element comprises or is incorporated in an external wall, and its distance from any fire-source feature.

When using **Table 3 of Specification C1.1**, it should be noted that **Clause 6 of Specification A2.3** permits the deletion of the structural adequacy criteria of an FRL for non-loadbearing elements. The reason for this is that if such an element fails during a fire, there will be no flow-on collapse of other elements. See definition of 'loadbearing' in **A1.1** to assist in understanding this provision.

The following table lists building elements required to be non-combustible, concrete or masonry in a building of Type A construction.

BUILDING ELEMENT	TYPE A CONSTRUCTION
External wall	Non-combustible
Common wall	Non-combustible
Floor and floor framing of lift pit	Non-combustible
All loadbearing internal walls (including those of shafts)	Concrete or masonry
Loadbearing fire walls	Concrete or masonry
Non-loadbearing walls required to be fire-resisting	Non-combustible
Non-loadbearing lift, ventilation, pipe, garbage and like shafts which do not discharge hot products of combustion	Non-combustible

Clause 3.1(a) requires building elements to achieve at least the FRLs set out in **Table 3**.

Clause 3.1(a) only applies to the building elements listed in **Table 3**, and any beams or columns incorporated in such building elements.

Clause 3.1(b) requires the floor and floor framing of lift pits to be non-combustible because of the fire risks caused by the tendency for combustible material to accumulate in these places.

Clause 3.1(c) requires internal walls to extend to a barrier to stop or limit the spread of fire over the top of the wall. **Clause 3.1(c)** only applies to internal walls required to have an FRL with respect to integrity and insulation. This is consistent with the intent that the walls are only required to extend to the underside of a floor or roof, etc when the wall is required to perform a fire separating function.

Clause 3.1(d) requires loadbearing internal walls and loadbearing fire walls (in both cases, including those which are part of a loadbearing shaft) to be of concrete or masonry.

Under **Clause 3.1(e)(i)**, any non-loadbearing internal wall that is required to be fire-resisting must be of non-combustible material.

Under **Clause 3.1(e)(ii)**, any non-loadbearing shaft that is not used for discharging such combustion products as smoke, coals or embers must be of non-combustible construction.

Internal columns can be exposed to a fire-source feature through a window in an external wall. **Clause 3.1(f)** requires such a column within 1.5 metres of a window to have the same FRL as an external column.

3.2 Concessions for floors

Intent

To allow certain floors to not have a fire-resistance level (FRL).

Clause 3.2 grants floors a number of concessions from the FRL requirement. The reason for each of the concessions is listed below:

- there is no fire load below a floor laid directly on the ground, (see **Clause 3.2(a)**);
- there is a low fire load if the space below a Class 2, 3, 5 or 9 building is not a storey or does not contain the listed elements, (see **Clause 3.2(b)**);
- the space below a stage would generally have a low fire load because it cannot be used as a dressing room, storage area, or the like. A fire in the storey below would not affect the stage because it is over a floor with the required FRL. In addition, the stage would not have a room below which might have a high fire load, (see **Clause 3.2(c)**);
- the floor is within a residential sole-occupancy unit. This is because resistance to the spread of fire between sole-occupancy units only is required. The levels connected are within the one sole-occupancy unit and the spread of fire from one sole-occupancy unit to another would not be affected by the construction of an internal floor without the required FRL, (see **Clause 3.2(d)**); and
- no fire separation is required for an open-access floor as a fire in the storey below could not affect the area because it is over a floor with the required FRL, (see **Clause 3.2(e)**).

3.3 Floor loading of Class 5 and 9b buildings: Concession

Intent

To allow a floor or roof in a Class 5 or Class 9b building to have a reduced fire-resistance level (FRL) if it is above a storey with a lower fire load.

Generally, Class 5 and Class 9b buildings have a comparatively low fire load which can be further reduced if the structural carrying capacity of the floor (“live load” or “imposed action”) is restricted because there will be a lower likelihood of the building containing a high level of stored combustible materials. AS 1170.1 and AS/NZS 1170.1 allows certain areas within office (Class 5) and assembly (Class 9b) buildings to have design floor loads of 3 kPa.

In essence, the lower the structural carrying capacity of the storey’s floor, the lower the fire load. This lower fire load in turn permits a reduced FRL for the floor or roof above such a storey.

The philosophy of fire protection in this provision is that the fire load of a storey controls the FRL of the floor or roof above it. This is because a fire on one storey will affect the level above to a greater degree than itself.

Clause 3.3(a) sets out the concession for a floor above, and **Clause 3.3(b)** sets out the concession for the roof above.

3.4 Roof superimposed on concrete slab: Concession

Intent

To allow a non-combustible non-fire-rated roof to be superimposed on a concrete slab roof.

Clause 3.4 allows a concession for a roof of non-fire-resisting construction to be superimposed above a concrete slab roof. Such roofs are usually used for weather protection reasons.

Clause 3.4(a) states that the superimposed roof and any supporting members must be non-combustible.

Clause 3.4(b) states that the concrete slab roof must comply with **Table 3 of Specification C1.1**.

If compliance is achieved with the conditions outlined in **Clause 3.4**, a concession is reasonable because a fire is unlikely to break through the concrete roof slab.

3.5 Roof: Concession

Intent

To allow the roofs of certain buildings not to have a fire-resistance level (FRL).

The roofs of certain types of buildings can be required to have an FRL to limit the spread of fire from the roof to another building, or from another building to the roof. **Clause 3.5** grants a number of concessions by which certain roofs need not have an FRL, provided the roof covering is non-combustible.

In **Clause 3.5(a)**, the BCA assumes that the specified sprinkler system will control any fire prior to it breaking through the roof.

In **Clause 3.5(b)**, the BCA assumes buildings with a rise in storeys of 3 or less will comprise a comparatively low fire risk. Most buildings with a rise in storeys of 3 or less are permitted to be of Type B or Type C construction.

In **Clause 3.5(c)**, the BCA assumes that Class 2 and Class 3 buildings have a relatively low fire load compared to other classifications, and recognises that the potential size of a fire in Class 2 and Class 3 buildings is limited by the bounding construction of the sole-occupancy units. This concession does not apply where another classification forms part of the storey immediately below the roof (eg a restaurant, which is Class 6).

Clause 3.5(d) assumes that the incipient spread of fire resistant ceiling will stop or limit the spread of fire to the roof space or roof of the building for sufficient time for it to be brought under control.

3.6 Roof lights

Intent

To permit roof lights or the like in a roof that is required to either have an FRL or have a non-combustible covering.

The roofs of certain types of building can be required to have an FRL, or to be of non-combustible construction, to limit the spread of fire from the roof to another building. This

is particularly the case with a high rise building. **Clause 3.6** specifies the requirements for such roof lights.

The requirements of **Clause 3.6** aim to minimise the risk that fire will spread by way of roof lights:

- from another building on an adjoining allotment;
- to an adjoining sole-occupancy unit; or
- to an adjoining fire compartment or fire-separated part of the building.

Clause 3.6 facilitates this aim by minimising the:

- roof area which can be comprised of roof lights (see **Clause 3.6(a)**);
- distance a roof light is from an allotment boundary (see **Clause 3.6(b)(i)**);
- distance a roof light is from unprotected parts of the building which are higher than the roof (see **Clause 3.6(b)(ii)**);
- distance a roof light is from roof lights or the like in adjoining sole-occupancy units, if the bounding walls are required to have an FRL (see **Clause 3.6(b)(iii)**); and
- distance a roof light is from any roof light or the like in adjoining fire-separated parts of the building (see **Clause 3.6(b)(iv)**).

In some cases, the BCA requires incipient spread of fire resistant ceilings to stop or limit the spread of a fire to the roof space.

Clause 3.6(c) provision requires that roof lights be installed in a manner which will maintain the requisite level of protection. This is an example of a “performance-type” provision within the Deemed-to-Satisfy Provisions. This is because a ceiling that has resistance to the incipient spread of fire is tested in the horizontal plane.

If roof lights are installed in a building, it may be necessary to install part of the ceiling in the vertical plane to connect the roof light with the ceiling below. Where this occurs, it may be necessary for a building proponent to provide evidence to an appropriate authority that the method proposed will meet the requirements of **Clause 3.6(c)**.

However, in this case, if the material is installed on a vertical plane yet complies in all other respects with the tested prototype, it is unlikely that the ceiling’s fire performance will be affected.

3.7 Internal columns and walls: Concession

Intent

To allow lower fire-resistance levels (FRLs) for internal columns and walls which only support a non-fire-resisting roof.

In the storey immediately below the roof, under circumstances specified in **Clause 3.7**, it is permissible to reduce or (in some cases) delete the FRL of:

- columns, other than those in that are:
 - within 1.5 metres of a window;
 - face that window; and
 - exposed to a fire-source feature through that window; and
- internal walls, other than fire walls and shaft walls.

Clause 3.7 does not negate the need for internal columns to have the same FRL as an external column (set out in **Clause 3.1(f)**) where that internal column is:

- within 1.5 metres of a window;
- faces that window; and
- exposed to a fire-source feature through that window.

3.8 Open spectator stands and indoor sports stadiums: Concession

Intent

To allow lower fire-resistance levels (FRLs) for building elements in open spectator stands and indoor sports stadiums.

The **Clause 3.8** concession is based on the BCA's overall assumption that there is generally a lower risk to the occupants of open spectator stands and indoor sports stadiums than in other buildings. The reasons for this concession are that:

- an open spectator stand generally has a low fire load, even though it may have a high population, particularly during an event, and is open at the front, facilitating the ventilation of smoke and heat; and
- in most indoor sports stadiums large areas are usually inaccessible to the public (being taken up as part of the sporting events) and the finishes are generally spartan.

See **A1.1** for definition of "open spectator stand".

3.9 Carparks

Intent

To allow lower fire-resistance levels (FRLs) for building elements in open-deck or sprinklered carparks.

Clause 3.9 and **Table 3.9** are based on experimental research carried out at the BHP Research Laboratories. The research included full-scale fire tests on open-deck and enclosed carparks, and was supplemented by extensive overseas testing.

The research showed that the **Table 3.9** FRLs will not lead to an unsafe situation or structural failure of a building element in an open-deck carpark, or an enclosed carpark, which is sprinkler protected.

See **A1.1** for definition of "carpark". **Clause 3.9(b)** refines this definition when the expression is used in **Clause 3.9** and **Table 3.9**.

Inclusions

Clause 3.9 concessions include:

- a building which solely comprises a carpark (see **Clause 3.9(a)(i)**);
- the carpark section of a building which, in part, has another use, and where the carpark and that use are fire-separated as required in **Clause 3.9(a)(ii)(A)-(D)** (regardless of the classification of that use, or whether that use is next to, above or below the carpark) (see **Clause 3.9(a)(ii)**);
- any administrative area associated with the carpark, such as ticket selling and fee collection areas (see **Clause 3.9(b)(i)(A)**); and
- in a sprinkler protected carpark, small areas ancillary to a Class 2 or Class 3 building, such as part of the carpark used for normal 'household' storage (see **Clause 3.9(b)(i)(B)**).

Exclusions

Clause 3.9 concessions exclude:

- any area of another Class (see **Clause 3.9(b)(ii)(A)**);
- another Class 7 use (ie other than carparking), (see **Clause 3.9(b)(ii)(A)**); and
- an area “specifically intended” for the parking of vehicles such as trucks, buses, vans and the like (see **Clause 3.9(b)(ii)(B)**).

Clause 3.9 and **Table 3.9**, while using a refined definition of “carpark”, also use the undefined expression “carparking”. This word specifically refers to the parking of cars. This is also the intention of refining the definition of “carpark” as expressed by the use of the words “specifically intended” in **Clause 3.9(b)(ii)(B)**.

The purpose of refining this definition, which is to limit the concessions in **Table 3.9** to areas used for the parking of lighter vehicles (that is, vehicles other than commercial trucks, vans, buses and the like), rather than simply limiting them to areas used for the parking of cars only.

Accordingly, it would seem contrary to the purpose of this clause to exclude from the refined definition and the word “carparking” such vehicles as motor bikes, van-like family vehicles, non-commercial panel vans, and smaller non-commercial utilities.

Table 3.9 permits building elements to have either a specified FRL or a specified surface area to mass ratio. In relation to columns and beams, **Table 3.9** does not require them to have an FRL if they have the specified surface area to mass ratio. Some authorities refer to this ratio as the “heat sink effect”, in that the lower the exposed surface area to mass ratio, the lower will be the member temperature for a given fire.

The concession of **Table 3.9(a)** relating to columns, only applies to columns of any material which support a roof which is not used for carparking, and located 3 metres or more from a fire-source feature to which they are exposed.

The concession of **Table 3.9(b)** only applies to steel columns which support a roof which is used for carparking, and/or located less than 3 metres from a fire-source feature to which they are exposed. This concession is not applicable if the steel columns support any other part of the building which is not used as a carpark.

Columns of any material that do not qualify for **Table 3.9(a)** and **(b)** concessions are subject to **Table 3.9(c)**.

Example

The concession of (b) in the columns section of **Table 3.9** does not apply if the column supports a part of the building specifically intended for the parking of trucks, buses, vans, and the like.

In the section of **Table 3.9** relating to roofs, there is a concession for roofs that are not used for carparking.

A roof used for carparking must comply with any relevant requirements of **Table 3.9** (eg those relating to floor slabs).

3.10 Class 2 buildings: Concession

Intent

To allow low-rise Class 2 buildings which are required to be of Type A construction to be constructed with timber framing and/or non-combustible materials.

Clause 3.10 results from research undertaken by the National Association of Forest Industries, and confirmed by overseas studies.

Clause 3.10 provides a concession to **Clause 3.1(b)**, **(d)** and **(e)** and also to the combustibility requirement of **Clause C2.6** to allow, subject to specified conditions, the use, in certain Class 2 buildings, timber framing instead of an alternative structural support system using non-combustible materials, concrete, or masonry.

Clause 3.10(a)(i) allows the use of timber framing.

Clause 3.10(a)(ii) allows the use of non-combustible materials (such as steel) for firewalls and internal walls required to be fire resisting, instead of concrete or masonry as required by **Clause 3.1(d)**.

Clause 3.10(a)(iii) allows a combination of timber framing and non-combustible materials.

The **Clause 3.10(a)** concession to use timber framing and/or non-combustible materials is conditional on:

- a firewall or internal wall required to be fire-resisting being extended to the underside of the non-combustible roof covering. The wall height requirement, together with the smoke sealing requirement of **Clause 3.10(c)(ii)(D)**, aims to create a smoke proof wall, hence the requirement for sealing any cracks and openings against the spread of smoke, (see **Clause 3.10(a)(iv)**) It should be noted that these walls may need to meet other requirements of Type A construction such as those of **Clause 3.1(c)**;
- only non-combustible insulation being used in a wall cavity. This aims to limit the spread of fire by way of the cavity; and
- an automatic smoke alarm system being installed in the building to give early warning of a fire.

Clause 3.10(b) allows the top three storeys of a four storey Class 2 building to be constructed with timber framing and/or non-combustible materials if they are located above a single storey used for vehicle parking (note that the limitation in **Clause 3.9** by use of the word “carparking” does not apply here) and ancillary purposes. These ancillary purposes include such items as individual storerooms, laundries, and the like.

To achieve this concession, the lowest carparking storey (including the floor/ceiling between the carpark and the storey above) must be constructed of concrete or masonry, and have the FRLs specified in **Table 3**, or reduced by **Clause 3.10(c)**. The floor between the carpark and the storey above must not contain penetrations or openings that would reduce the fire-resisting performance of the floor. The exception to this is a door which is permitted to be a –/60/30 self-closing fire door.

Under the **Clause 2.8** concession, the vehicle parking storey can be classified as a Class 2 building for the purpose of determining the relevant fire-resisting requirements of **Specification C1.1**.

The basis of the **Clause 3.10(b)** concession is that the concrete or masonry floor of the first storey above the lowest carparking storey will provide adequate fire separation. **Clause 3.10** does not require smoke detectors or sprinklers in the lowest carparking storey because a fire occurring in it should not pose an unacceptable risk to occupants evacuating from the upper three storeys.

Compliance must still be achieved with the other requirements of **Specification C1.1** and other parts of the BCA, including the relevant FRLs listed in **Table 3 of Specification C1.1**, and any relevant requirements of **Clause E1.5**.

Subject to the conditions listed, including the installation of a sprinkler system, **Clause 3.10(c)** allows:

- a reduction of the FRL of loadbearing walls (see [Clause 3.10\(c\)\(i\)](#)); and
- the deletion of the FRL for non-loadbearing internal walls (see [Clause 3.10\(c\)\(ii\)](#)).

Reference to [Clause 2 of Specification E1.5](#) indicates that the required sprinkler system need only comply with AS 2118.4—Automatic fire sprinkler systems—Residential. This Standard has been specifically developed to provide a degree of life safety and property protection for occupants of low-rise Class 2 buildings. If the storey used as carpark requires sprinklers by [Clause E1.5](#), then the carpark is considered a Class 7 building for the purposes of applying [Specification E1.5](#) (see [E1.5](#)).

[Clause 3.10\(c\)\(ii\)](#) allows non-loadbearing internal walls to have no FRL. The concession is subject to the requirement that the internal walls be lined on each side with 13 mm standard grade plasterboard or non-combustible materials with a similar fire-resisting performance. This means that all doors from sole-occupancy units to corridors, when applying these concessions, must be smoke proof doors. Self-closing solid core doors satisfy this requirement (see [Specification C3.4](#)).

The [Clause 3.10\(c\)\(ii\)\(B\)](#) provision regarding the height of a non-loadbearing wall, to which this concession is applied, aims to create a smoke proof wall, hence the requirement for sealing any cracks and openings against the spread of smoke.

The [Clause 3.10\(c\)\(ii\)\(C\)](#) requirement that only non-combustible insulation can be used in a cavity in a non-loadbearing wall, to which this concession is applied, aims to limit the spread of fire by way of the cavity.

4 TYPE B FIRE-RESISTING CONSTRUCTION

4.1 Fire-resistance of building elements

Intent

To specify the fire-resistance level (FRL) and other requirements of building elements in Type B construction.

[Table 4 of Specification C1.1](#) sets out the required FRLs of building elements in a building required to be of Type B construction. The required FRL depends on whether the element is loadbearing or non-loadbearing, if the element comprises or is incorporated in an external wall, and its distance from any fire-source feature to which it is exposed.

Although a roof is an external building element that can be exposed to a fire-source feature, it is not required to comply with the FRLs specified under the heading of external wall in [Table 4](#). The FRLs required for a roof are contained under the heading of roofs near the bottom of the Table.

When using [Table 4 of Specification C1.1](#), it should be noted that [Clause 6 of Specification A2.3](#) permits the deletion of the structural adequacy criterion of an FRL for non-loadbearing elements. The reason for this is that if such an element fails during a fire, there will be no flow-on collapse of other elements. See [A1.1](#) for the definition of “loadbearing”.

Generally speaking, Type B construction differs from Type A construction by allowing lower FRLs for external walls, generally not requiring roofs and floors to have an FRL, and not requiring FRLs for ventilation, garbage, and similar shafts.

These differences are based on the lower rise in storeys allowed by [Table C1.1](#); and the smaller size of Type B construction buildings allowed by [Table C2.2](#).

The BCA requires the floors of buildings required to be of Type B construction to have an FRL in Class 2 and Class 3 buildings, if the floor supports different sole-occupancy units (see [Clause 4.1\(i\)](#)), in Class 9a buildings as part of the fire compartments required by [C2.5\(a\)\(iv\)](#) and in Class 9c buildings as part of the fire compartments required by [C2.5\(b\)\(ii\)](#) (see [Clause 4.1\(j\)](#)).

The following table lists building elements required to be non-combustible, concrete or masonry in a building of Type B construction.

BUILDING ELEMENT	TYPE B CONSTRUCTION
External wall	Non-combustible
Common wall	Non-combustible
Floor and floor framing of lift pit	Non-combustible
All loadbearing internal walls (including those of shafts)	Concrete or masonry
Loadbearing fire walls	Concrete or masonry
Non-loadbearing walls required to be fire-resisting	Non-combustible
Non-loadbearing lift, ventilation, pipe, garbage and like shafts which do not discharge hot products of combustion	Non-combustible (subject to conditions outlined in Clause 4.1(h))

[Clause 4.1\(a\)](#) requires building elements to achieve at least the FRLs set out for them in [Table 4](#). [Clause 4.1\(a\)](#) only applies to the building elements listed in [Table 4](#), and any beams or columns incorporated in such building elements.

[Clause 4.1\(b\)](#) requires the floor and floor framing of lift pits to be non-combustible because of the fire risks caused by the tendency for combustible materials or rubbish to accumulate in these places.

[Clause 4.1\(c\)](#) requires stair shafts which support floors or structural parts of floors to either have a specified FRL, or be constructed at the junction of the shaft and floor (or part of floor), so that if the floor falls or collapses (fully or partly) during a fire, the shaft will not be damaged.

[Clause 4.1\(d\)](#) requires internal walls to extend to a barrier to stop or limit the spread of fire over the top of the wall. Such a requirement is not considered necessary when a sole-occupancy unit occupies the whole of the top storey. This concession applies to buildings of Type B construction. [Clause 4.1\(d\)](#) only applies to internal walls required to have an FRL with respect to integrity and insulation. This is consistent with the intent that the walls are only required to extend to the underside of a floor or roof, etc when the wall is required to perform a fire separating function.

[Clause 4.1\(e\)](#) requires loadbearing internal walls and loadbearing fire walls (in both cases, including those which are part of a loadbearing shaft) to be of concrete or masonry.

Under [Clause 4.1\(f\)](#), any non-loadbearing internal wall, which is required to be fire-resisting, must be of non-combustible material.

Under [Clause 4.1\(g\)](#), internal columns and internal walls need not comply with [Table 4](#) if they are:

- in a Class 5–9 building;
- in the storey immediately below the roof; and

- not fire walls or shaft walls.

Under **Clause 4.1(h)**, any non-loadbearing shafts of the type listed which are not used for discharging such combustion products as smoke, coals or embers must be of non-combustible material. In recognition of the comparative likely risk levels, this provision applies to all Class 2, 3 and 9 buildings, and to Class 5–8 buildings where the shaft connects 3 storeys or more. This is because of the increased evacuation, fire-fighting and rescue difficulties that exist in higher buildings.

To protect building occupants of Class 2, 3 and 9 buildings from fire spread between storeys, **Clause 4.1(i)** establishes the minimum fire separation between storeys in such buildings.

This requirement also relates to the fire separation of Class 2, 3 and 9 buildings from a carpark or storage area.

Clause 4.1(j) does not apply if the storeys being separated are within a sole-occupancy unit of a Class 2 or 3 building, because it is likely that the two levels are connected by a non-fire-isolated stairway.

The primary reason for the **Clause 4.1(i)** fire separation requirement is that in a building fire, the highest degree of risk is attached to such people as the very young, people with disabilities, the elderly, and those who are asleep.

Table 5 requires internal walls bounding a stair required to be rated to have an FRL of 60/60/60. The reason for this is because although **Table C1.1** only allows buildings of Type C construction to have a maximum rise in storeys of 2, such buildings may include a basement which is not included in the calculation of rise in storeys. If a stairway in the building connects say a basement with two other storeys, in accordance with **D1.3**, a fire-isolated exit would be required. **Table 5** then sets out the required FRL for the walls of the stairway.

Examples

Buildings, which must comply with **Clause 4.1(i)**, include:

- A Class 2 building (which includes flats, apartments, etc).
- A Class 3 building (which includes hotels, motels, etc).
- The residential part of a school.
- Accommodation for the aged, children or people with disabilities.
- A residential aged care building.
- A Class 9a building (which includes hospitals, etc).
- A Class 9b building, such as schools, theatres, and the like.

4.2 Carparks

Intent

To allow lower fire-resistance levels (FRLs) for building elements in open-deck or sprinklered carparks.

Clause 4.2 and **Table 4.2** are based on experimental research carried out at the BHP Research Laboratories. The research included full scale fire tests on both open-deck and enclosed carparks, and was supplemented by extensive overseas testing.

The research carried out on this matter showed that the **Table 4.2** FRLs will not lead to an unsafe situation or structural failure of a building element in an open-deck carpark, or an enclosed carpark which is sprinkler protected.

See **A1.1** for definition of “carpark”. **Clause 4.2(b)** refines this definition when the expression is used in **Clause 4.2** and **Table 4.2**.

Inclusions and exclusions

Clause 4.2 concessions include:

- a building which solely comprises a carpark;
- the carpark section of a building which elsewhere has another use;
- any administrative area associated with the carpark, such as ticket selling and fee collection areas; and
- in a sprinkler protected carpark, small areas ancillary to a Class 2 or Class 3 building, such as part of the carpark used for normal “household” storage.

Clause 4.2 concessions exclude:

- any area of another Class;
- another Class 7 use (ie other than carparking); and
- an area “specifically intended” for the parking of vehicles such as trucks, buses, vans and the like.

Clause 4.2 and **Table 4.2**, while using a refined definition of “carpark”, also use the undefined expression “carparking”. This word specifically refers to the parking of cars. This is also the intention of refining the definition of “carpark” as expressed by the use of the words “specifically intended” in **Clause 4.2(b)(ii)(B)**.

However, in applying these provisions, it is important to consider the purpose of refining this definition, which is to limit the concessions in **Table 4.2** to areas used for the parking of lighter vehicles (that is, vehicles other than commercial trucks, vans, buses and the like)—rather than simply limiting them to areas used for the parking of cars only.

Accordingly, it would seem contrary to the purpose of this clause to exclude from the refined definition and the word “carparking” such vehicles as motor bikes, van-like family vehicles, non-commercial panel vans, and smaller non-commercial utilities.

Regarding certain types of column and beam, **Table 4.2** permits them to have either a specified FRL or a specified surface area to mass ratio. In other words, in relation to these columns and beams, **Table 4.2** does not require them to have an FRL if they have the specified surface area to mass ratio. Some authorities refer to this ratio as the “heat sink effect”, in that the lower the exposed surface area to mass ratio, the lower will be the member temperature for a given fire.

The concession for columns in **Table 4.2(a)** applies to columns of any material which support a roof which is not used for carparking, and located 3 metres or more from a fire-source feature to which they are exposed.

The concession in **Table 4.2(b)** only applies to steel columns that support a roof which is used for carparking, and/or located less than 3 metres from a fire-source feature to which they are exposed. This concession is also applicable where steel columns support any other part of the building that is not used as a carpark.

Columns of any material which do not qualify for the **Table 4.2(a)** and **(b)** concessions are subject to **Table 4.2(c)**.

For the purposes of this clause, the usual definition of “carpark” is specifically amended (see **Clause 4.2(b)**).

Example

The concession of (b) in the columns section of **Table 4.2** does not apply if the column supports a part of the building specifically intended for the parking of trucks, buses, vans, and the like.

Table 3.9 provisions restricting the roof concession to those roofs that are not used for carparking does not apply to **Table 4.2**.

The differences between **Table 4.2** and **Table 3.9** are based on the lower rise in storeys allowed for Type B construction buildings by **Table C1.1**.

4.3 Class 2 buildings: Concession

Intent

To allow low-rise Class 2 buildings which are required to be of Type B construction to be constructed with timber framing and/or non-combustible materials.

Clause 4.3 results from research undertaken by the National Association of Forest Industries, and confirmed by overseas studies undertaken.

The effect of **Clause 4.3** is to provide a concession to **Clause 4.1** to allow, subject to specified conditions, the use in certain Class 2 buildings of timber framing instead of an alternative structural support system using non-combustible materials, or concrete, or masonry.

Clause 4.3(a)(i) allows the use of timber framing.

Clause 4.3(a)(ii) allows the use of non-combustible materials (such as steel) for fire walls and internal walls required to be fire-resisting, instead of concrete or masonry as required by **Clause 4.1(e)**.

Clause 4.3(a)(iii) allows a combination of timber framing and non-combustible materials.

Table C1.1 limits Class 2 buildings of Type B construction to a rise in storeys of two. For this reason **Clause 4.3** only applies to two storey Class 2 buildings, and no concession is allowed for a two storey timber framed building above a concrete or masonry lower storey, as is allowed in the case of Type A construction buildings by **Clause 3.10**.

The **Clause 4.3(a)** concession to use timber framing and/or non-combustible materials is conditional on:

- a fire wall or internal wall required to be fire-resisting being extended to the underside of the non-combustible roof covering. The wall height requirement, together with the smoke sealing requirement of **Clause 4.3(c)(ii)(D)**, aims to create a smoke proof wall, hence the requirement for sealing any cracks and openings against the spread of smoke;
- only non-combustible insulation being used in a wall cavity. This aims to limit the spread of fire by way of the cavity; and
- an automatic smoke alarm system being installed in the building to give early warning of a fire.

Clause 4.3(b) allows a 2 storey Class 2 building to be constructed with timber framing and/or non-combustible materials if the lowest storey is used for vehicle parking (note that the limitation in **Clause 4.2** by use of the word “carparking” does not apply here) and

ancillary purposes. These ancillary purposes include such items as individual storerooms, laundries, and the like.

To achieve this concession, the lowest carparking storey (including the floor/ceiling between the carpark and the storey above) must be constructed of concrete or masonry, and have the FRLs specified in **Table 4**. The floor between the carpark and the storey above must not contain penetrations or openings that would reduce the fire-resisting performance of the floor. The exception to this is a doorway which is permitted to be protected by a –/60/30 self-closing fire door.

Under the **Clause 2.8** concession, the carparking storey can be classified as a Class 2 building for the purpose of determining the relevant fire-resisting requirements of **Specification C1.1**.

Subject to the conditions listed, including the installation of a sprinkler system, **Clause 4.3(c)** allows a reduction of the FRL of loadbearing elements, and the deletion of the FRL for non-loadbearing elements.

Reference to **Clause 2 of Specification E1.5** indicates that the required sprinkler system need only comply with AS 2118.4—Automatic fire sprinkler systems—Residential. This Standard has been specifically developed to provide a degree of life safety and property protection for occupants of low-rise Class 2 buildings (see **E1.5**).

Clause 4.3(b) allows non-loadbearing internal walls to not have an FRL. The concession is subject to the requirement that the internal walls be lined on each side with 13 mm standard grade plasterboard or non-combustible materials.

The **Clause 4.3(c)(ii)(B)** provision regarding the height of a non-loadbearing wall to which this concession is applied aims to create a smoke proof wall, hence the **Clause 4.3(c)(ii)(D)** requirement for sealing any cracks and openings against the spread of smoke.

The **Clause 4.3(c)(ii)(C)** requirement that only non-combustible insulation can be used in a cavity in a non-loadbearing wall to which this concession is applied aims to limit the spread of fire by way of the cavity.

There is no specific concession to permit the use of solid core doors in Type B construction buildings, unlike that in **Clause 3.10(c)(ii)(E)**, this is because they are already permitted in Type B construction (see **C3.11**).

The result of **Clause 4.3** is that a designer proposing to use the BCA Deemed-to-Satisfy Provisions to design a two storey Class 2 building of Type B construction has three basic options:

- design in accordance with other provisions applicable to buildings of Type B construction which, under **Clause 4.1(b)**, **(e)** and **(f)**, would exclude the use of timber external walls, common walls, loadbearing internal walls, fire walls and non-loadbearing internal walls required to be fire-resisting;
- use timber and/or non-combustible materials in accordance with **Clause 4.3**; or
- comply with **C1.5** and design for Type C construction, which places no limitations on the use of timber.

5 TYPE C FIRE-RESISTING CONSTRUCTION

5.1 Fire-resistance of building elements

Intent

To specify the fire-resistance level (FRL) and other requirements of building elements in a building required to be of Type C construction.

Table 5 of Specification C1.1 sets out the required FRLs of building elements in a building required to be of Type C construction. If the element comprises or is incorporated in an external wall, the required FRL depends on distance from any fire-source feature to which it is exposed.

Although a roof is an external building element that can be exposed to a fire-source feature, it is not required to comply with the FRLs specified under the heading of external wall in **Table 5**. The FRLs required for a roof are contained under the heading of roofs near the bottom of the table.

When using **Table 5 of Specification C1.1**, it should be noted that **Clause 6 of Specification A2.3** permits the deletion of the structural adequacy criteria of an FRL for non-loadbearing elements. The reason for this is that if such an element fails during a fire, there will be no flow-on collapse of other elements. See **A1.1** for definition of “loadbearing”.

Generally speaking, Type C construction differs from Type B construction by allowing lower FRLs for external walls which are located more than 1.5 metres from a fire-source feature, and only requiring a maximum FRL of 90 minutes for any criterion. **Table C2.2** bases these differences on the lower rise in storeys allowed by **Table C1.1**, and the smaller size of Type C buildings allowed.

No building element in a building required to be of Type C construction is required to be non-combustible, or of concrete or masonry.

Clause 5.1(a) requires building elements to achieve at least the FRLs set out for them in **Table 5**. **Clause 5.1(a)** only applies to the building elements listed in **Table 5**, and any beams or columns incorporated in such building elements.

Where **Table 5** requires an external wall to have an FRL, **Clause 5.1(b)** requires that the wall only need be tested from outside to meet the FRL criteria. This allows the use of brick veneer construction where the brick has the required FRL.

Where a fire wall and the specified internal walls are of lightweight construction they must comply with **Specification C1.8**.

Clause 5.1(d) requires internal walls to extend to a barrier to stop or limit the spread of fire over the top of the wall.

The concession contained in **Clause 4.1(d)** for Type B construction with respect to the height of the wall when a sole-occupancy unit occupies the whole of the top storey, does not apply to Type C construction.

To protect building occupants of Class 2, 3 and 9 buildings from fire spread between storeys, **Clause 5.1(e)** establishes the minimum fire separation between storeys in such buildings. This requirement takes into account the special risks that can exist in such buildings.

This requirement also relates to the fire separation of Class 2, 3 and 9 buildings from a carpark or storage area.

Clause 5.1(e) does not apply if the storeys being separated are within a sole-occupancy unit of a Class 2 or Class 3 building, because it is likely that the two levels are connected by a non-fire-isolated stairway and would therefore not be required to be fire separated.

The primary reason for the **Clause 5.1(e)** and **(f)** fire separation requirement is that in a building fire, the highest degree of risk is attached to such people as the very young, people with disabilities, the elderly, and those who are asleep.

Examples

Buildings that must comply with **Clause 5.1(e)** include:

- A Class 2 building (which includes flats, apartments, etc).
- A Class 3 building (which includes hotels, motels, etc).
- The residential part of a school.
- Accommodation for the aged, children or people with disabilities.
- A residential aged care building.
- A Class 9a building (which includes hospitals, etc).
- A Class 9b building, such as schools, theatres, and the like.

5.2 Carparks

Intent

To allow lower fire-resistance levels (FRLs) for building elements in open-deck or sprinklered carparks.

Clause 5.2 and **Table 5.2** are based on experimental research carried out at the BHP Research Laboratories. The research included full scale fire tests on both open-deck and enclosed carparks, and was supplemented by extensive overseas testing.

The research carried out on this matter showed that the **Table 5.2** FRLs will not lead to an unsafe situation or structural failure of a building element in an open-deck carpark, or an enclosed carpark which is sprinkler protected.

See **A1.1** for definition of “carpark”. **Clause 5.2(b)** refines this definition when the expression is used in **Clause 5.2** and **Table 5.2**.

Inclusions and exclusions

The **Clause 5.2** concessions include:

- a building which solely comprises a carpark;
- the carpark section of a building which elsewhere has another use;
- any administrative area associated with the carpark, such as ticket selling and fee collection areas; and
- in a sprinkler protected carpark, small areas ancillary to a Class 2 or Class 3 building, such as part of the carpark used for normal ‘household’ storage.

The **Clause 5.2** concessions exclude:

- any area of another Class;
- another Class 7 use (ie other than carparking); and
- an area “specifically intended” for the parking of vehicles such as trucks, buses, vans and the like.

Clause 5.2 and **Table 5.2**, while using the refined definition of “carpark”, also use the undefined expression “carparking”. This word specifically refers to the parking of cars. This is also the intention of refining the definition of “carpark” as expressed by the use of the words “specifically intended” in **Clause 5.2(b)(ii)(B)**.

However, in applying these provisions, it is important to consider the purpose of refining this definition, which is to limit the concessions in **Table 5.2** to areas used for the parking of lighter vehicles (that is, vehicles other than commercial trucks, vans, buses and the like), rather than simply limiting them to areas used for the parking of cars only.

Accordingly, it would seem contrary to the purpose of this clause to exclude, from the refined definition and the word “carparking”, such vehicles as motor bikes, van-like family vehicles, non-commercial panel vans, and smaller non-commercial utilities.

Regarding certain types of columns and beams, **Table 5.2** permits them to have either a specified FRL or a specified surface area to mass ratio. In other words, in relation to these columns and beams, **Table 5.2** does not require them to have an FRL if they have the specified surface area to mass ratio. Some authorities refer to this ratio as the “heat sink effect”, in that the lower the exposed surface area to mass ratio, the lower will be the member temperature for a given fire.

In the section of **Table 5.2** relating to columns:

- the concession of (a) applies only to steel columns that are located less than 1.5 metres from any fire-source feature; and
- the concession of (b) applies only to columns of any material which are located less than 1.5 metres from any fire-source feature.

Columns of any material that do not qualify for the (a) and (b) concessions are subject to (c).

Roofs that do not qualify for the roof concession in **Table 5.2** must comply with the requirements of **Specification C1.1** for roofs of other buildings.

Table 3.9 provisions restricting the roof concession to those roofs that are not used for carparking does not apply to **Table 5.2**.

The differences between **Table 5.2** and **Table 4.2** are based on the lower rise in storeys allowed for Type C buildings by **Table C1.1**.

SPECIFICATION **C1.8** STRUCTURAL TESTS FOR
LIGHTWEIGHT CONSTRUCTION

Deemed-to-Satisfy Provisions

This Guide does not address, in detail, every provision in this Specification.

Lightweight construction is more susceptible to damage than other forms of fire protection. It therefore needs protection to preserve its integrity in a fire.

Specification C1.8 describes a number of tests on walls of lightweight construction which can be used to demonstrate their acceptance as a fire protection system under the Deemed-to-Satisfy Provisions.

SPECIFICATION **C1.10** FIRE HAZARD PROPERTIES

Deemed-to-Satisfy Provisions

1 Scope

Intent

To set out the scope of [Specification C1.10](#).

It should be noted that [C1.10](#) requires the fire hazard properties of linings, materials and assemblies used in the construction of a building to comply with [Specification C1.10](#). [Specification C1.10](#) sets out the details of these requirements.

2 Application

Intent

To set out clauses in the Specification, that the linings, materials and assemblies must comply with.

Table 1 sets out which Clauses of [Specification C1.10](#) linings, materials and assemblies must comply with.

3 Floor linings and floor coverings

Intent

To prescribe the fire hazard properties of floor linings and floor coverings.

[Clause 3\(a\)](#) states that a floor lining or covering must have a critical radiant flux not less than that in [Table 2](#). A material's critical radiant flux is determined by testing the material in accordance with AS ISO 9239.1. This test is the floor radiant panel test. The higher a material's critical radiant flux is, the better the material performs.

The different requirements for materials are based on the building classification, the location of the material in the building and whether the building contains a sprinkler system. The requirements are higher for aged care buildings and health care buildings due to the limited mobility of occupants in those buildings. The requirements are based on research which indicated that the required egress time in these buildings was greater and therefore proposed levels of control needed to be greater.

[Clause 3\(b\)](#) contains requirements dealing with a material's smoke development rate. A material's smoke development rate is determined by testing the material in accordance with AS ISO 9239.1. This test is the floor radiant panel test. The requirement is only applicable where floor materials and coverings are installed in buildings that do not have a sprinkler system complying with [Specification E1.5](#). [Clause 3\(b\)](#) limits the smoke development rate to not more than 750 percent-minutes.

Table 2 does not contain any requirements for Class 9c buildings that do not contain a sprinkler system. The reason for this is because, pursuant to **E1.5**, all Class 9c buildings must have a sprinkler system installed throughout the building.

4 Wall and ceiling linings

Intent

To prescribe the fire hazard properties of wall and ceiling linings.

Clause 4 specifies that a material used as a wall or ceiling lining must be a Group 1, Group 2 or Group 3 material and used in accordance with **Table 3**. A material's group number is determined by testing the material in accordance with AS ISO 9705, or by prediction after testing in accordance with AS/NZS 3837. AS ISO 9705 is the room fire test. AS/NZS 3837 is the cone calorimeter test. The BCA specifies the method of fixing the test specimen for the AS/NZS 3837 test because it is not included in the Standard.

For the purpose of the BCA, a Group 1 material indicates the best performing material and a Group 4 material is the worst performing material.

The allowable material group number differences are based on the building classification and the location of the material in the building. It is also dependant on whether the building contains a sprinkler system in accordance with **Specification E1.5**, and whether the material is used as a wall lining or a ceiling lining.

The locations within the building referred to in **Table 3** are fire-isolated exits, fire control rooms, public corridors, specific areas and other areas. The definition of specific areas differs according to the use of the building. The specific areas are as follows:

- for Class 2 and 3 buildings, a sole-occupancy unit;
- for Class 5 buildings, open plan offices with a minimum floor dimension/floor to ceiling height ratio >5;
- for Class 6 buildings, shops or other buildings with a minimum floor dimension/floor to ceiling height ratio >5;
- for Class 9a health care buildings, patient care areas;
- for Class 9b theatres and halls, etc, an auditorium;
- for Class 9b schools, a classroom; and
- for Class 9c aged care buildings, resident use areas.

For Class 5 and 6 buildings, the minimum floor dimension and the floor to ceiling height need to be considered when determining "specific areas". An area is a specific area if the minimum floor dimension/floor to ceiling height ratio is more than 5.

Example

Consider the case of a Class 5 building having a 15 m by 20 m open plan office with a ceiling height of 2.5 m. The building also contains an enclosed office having a floor plan of 3 m by 4 m.

For the open plan office area, as the minimum floor dimension (15 m) divided by the ceiling height (2.5 m) is 6, ie. more than 5, it would be deemed a "specific area" and therefore wall and ceiling linings in the area would need to comply with the requirements for Class 5 "specific areas".

For the enclosed office, as the minimum floor dimension (3 m) divided by the ceiling height (2.5 m) is 1.2, ie. less than 5, it would not be deemed to be a "specific area" and therefore

wall and ceiling linings in the enclosed office would need to comply with the requirements for Class 5 “other areas”.

“Other areas” are areas which are not either a fire-isolated exit, a public corridor or a “specific area”.

The requirements differ between the building classifications. These requirements are based on research which indicated that the required egress time differed between the building’s classifications and therefore proposed levels of control needed to be greater.

Clause 4(c) contains requirements dealing with a material’s smoke development rate. The requirements only apply where the wall and/or ceiling lining material is installed in a building that does not have a sprinkler system complying with **Specification E1.5**.

5 Air-handling ductwork

Intent

To specify requirements for air-handling ductwork.

Air-handling ductwork has the potential to cause the rapid spread of fire throughout a building. It is important that the materials used in its construction are appropriate to avoid this potentially dangerous situation. The particular requirements are covered by AS 4254.

6 Lift cars

Intent

To specify requirements for lift cars.

Lift cars are small, enclosed spaces, with minimal ventilation and no active fire suppression equipment. They also have no immediate means of egress. The materials used in their construction must be appropriate to avoid a potentially dangerous situation. The particular requirements are outlined in AS 1735.2. The appropriate Occupational Health and Safety Authorities also enforce these requirements.

Additionally, floor linings and floor coverings must have a critical radiant flux of not less than 2.2, and the wall linings and ceiling linings must be either a Group 1 material or a Group 2 material, which are similar to those required in public corridors.

7 Other materials

Intent

To specify requirements for other locations and materials.

Clause 7 sets out requirements for materials and assemblies not included elsewhere in **Specification C1.10**. The detail is located in **Table 4**. It is important to read the notes to this table because they contain specific requirements.

Fire-isolated exits and fire control rooms

Because fire-isolated exits are considered a safe place for people seeking egress during a fire, it is acknowledged that they should be as safe as possible.

Similarly, fire control rooms are part of a building set aside for the fire brigade to co-ordinate its search, rescue and firefighting operations during a fire. Since fire control rooms are used by the fire brigade during a fire, they should also be as safe as possible.

The basic aim of **Table 4** is to minimise the risk of a fire in a fire-isolated exit and a fire control room.

It could be claimed that fire is unlikely to enter either of these spaces because of their construction and protection, and therefore there is no need for control of the finishes within them. However, compromising the integrity of these spaces is not at all unusual. For example, by—

- removal, alteration or deterioration of fire doors; or
- wedging open fire doors in fire-isolated stairways.

The prescribed Spread-of-Flame Index and Smoke-Developed Index measures aim to limit finishes to those that are no more hazardous than a conventional paint finish on a non-combustible surface.

The requirements for sarking-type materials in a fire-isolated exit or fire control room are contained under the heading of sarking-type material.

Class 9b theatres, public halls and the like

To minimise the spread of fire and smoke in a Class 9b building used as a theatre, public hall or the like, **Table 4** contains specific requirements for—

- fixed seating used by the audience; and
- proscenium curtains.

Escalators, non-required non fire-isolated stairways and ramps, etc.

Table 4 contains requirements for materials not listed elsewhere in **Specification C1.10**, used in stairways, ramps and escalators not required by the BCA, and which are non fire-isolated. These requirements aim to prevent the spread of fire through an unrestricted number of floors through unprotected openings for stairways, ramps and escalators. Further requirements for escalators, non-required non fire-isolated stairways and ramps can be found in **D1.12** and **Specification D1.12**.

Sarking-type material

The requirements in **Table 4** for a sarking-type material, in areas other than fire-isolated exits and fire control rooms, to have a Flammability Index of not more than 5 is to minimise the risk of sarking facilitating the spread of fire.

Example

Before the flammability of sarking was regulated, there was a supermarket fire with the following characteristics:

- The building was single storey, and similar to the current Type C construction.
- The fire was caused by faulty electrical wiring, started in a small switch and staff room, and was noticed by an employee in its initial stages.

Under normal circumstances this fire would be easily extinguished, but it penetrated the ceiling through a small hole for electrical wiring and ignited the sarking immediately above.

The sarking aided the spread of fire through the roof space.

As a result, there was severe damage to the roof structure, including the metal roof cladding, steel purlins, bracing and trusses, timber battens and plaster ceilings, leading to burning debris falling down onto the floor.

As explained above, fire-isolated exits are considered a safe place for people seeking egress during a fire. Likewise, fire control rooms are spaces used by the fire brigade during a fire. Accordingly, both spaces should be as safe as possible and the required Flammability Index is more restrictive.

Other materials

The other materials referred to in [Table 4](#) are materials not referred to in other parts of [Specification C1.10](#) and elsewhere in [Table 4](#). Such materials include, but are not limited to the following:

- Window frames other than timber window frames (timber window frames are exempt from the requirements of [Specification C1.10](#), see [C1.10\(c\)](#)).
- Attachments to walls, floors and ceilings.

SPECIFICATION **C1.11** PERFORMANCE OF EXTERNAL WALLS
IN FIRE

Deemed-to-Satisfy Provisions

1 Scope

Intent

To clarify that **Specification C1.11** aims to minimise the risk, in a fire, of external walls collapsing outwards as complete panels and panels separating from supporting members.

Specification C1.11 contains detailed Deemed-to-Satisfy Provisions that could form part of a Building Solution to achieve **CP5**. These provisions include solutions to avoid the potential collapse outwards, as whole panels, of concrete external walls in a building with a rise in storeys of not more than 2, and minimum design loads which panel connections must resist during a fire.

2 Application

Intent

To clarify that **Specification C1.11** applies only to buildings with a rise in storeys of 2 or less, where those buildings have concrete external walls that could collapse as complete panels.

Specification C1.11 applies only to buildings with a rise in storeys of 2 or less, where the external walls are constructed using tilt-up and precast concrete panels.

Figures Spec C1.11(1) and **Spec C1.11(2)** illustrate some of the types of construction covered by **Specification C1.11**.

Figure Spec C1.11(1)

TYPICAL NON-LOADBEARING PANELS REQUIRED TO COMPLY WITH SPECIFICATION C1.11 (PANELS MAY BE FULL BAY, MULTIPLE VERTICALLY OR HORIZONTALLY SPANNING)

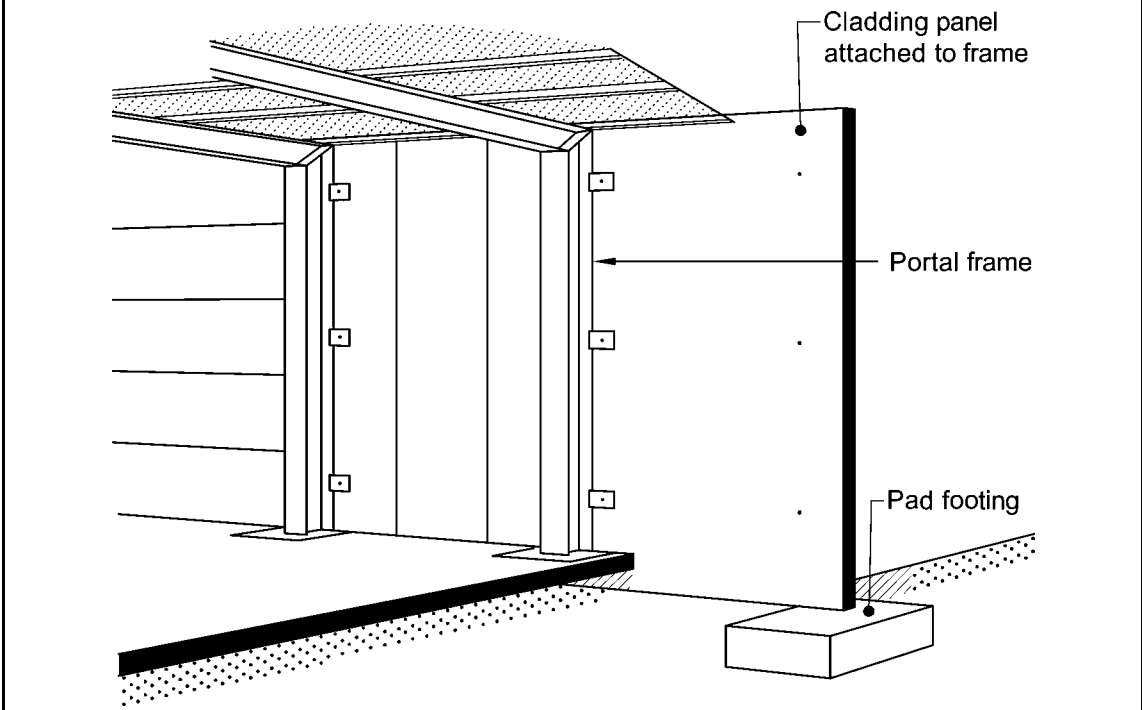

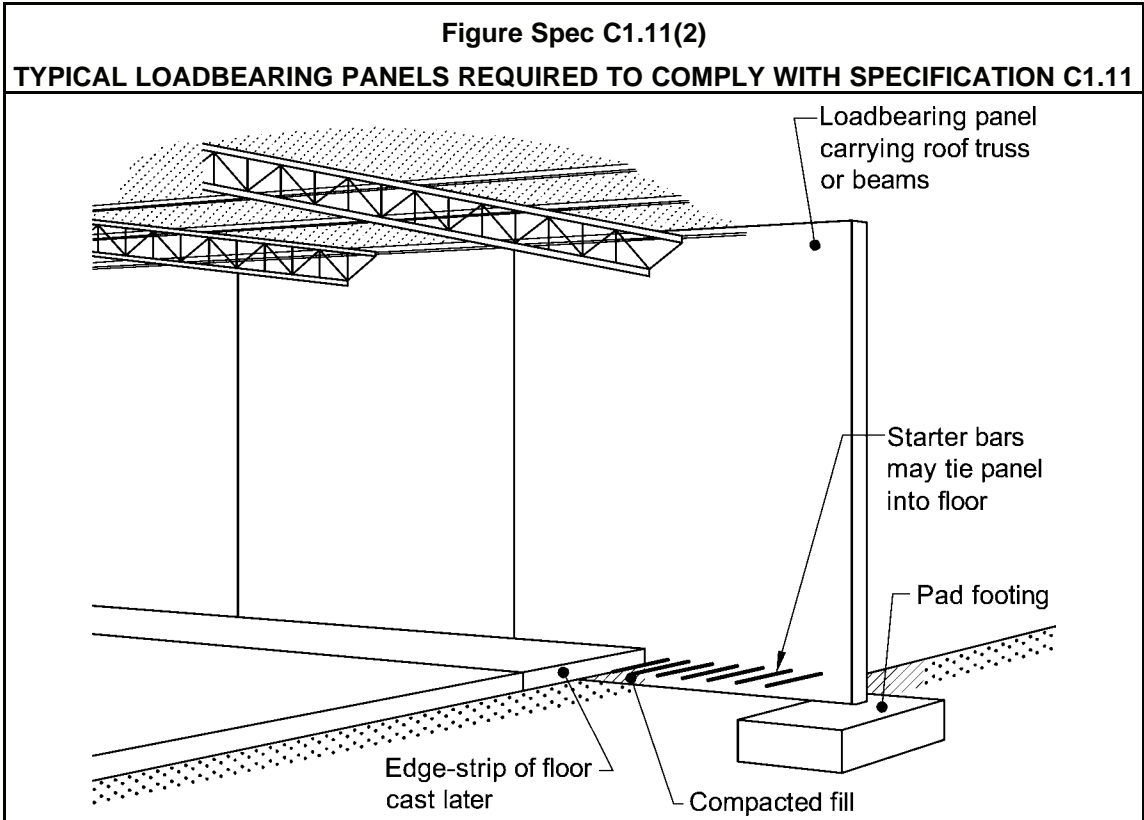

3 General requirements for external wall panels

Intent

To provide general requirements for external wall panels which will minimise the risk of them collapsing in a fire and causing death and/or injury.

The concrete shear cone is the element of a panel that provides the bulk of the interconnection or fixing load capacity of the panel to the main structure. The aim of **Clause 3(a)** is to provide some attachment to the panel after the concrete shear cone has failed during a fire. See **Figure Spec C1.11(3)**.

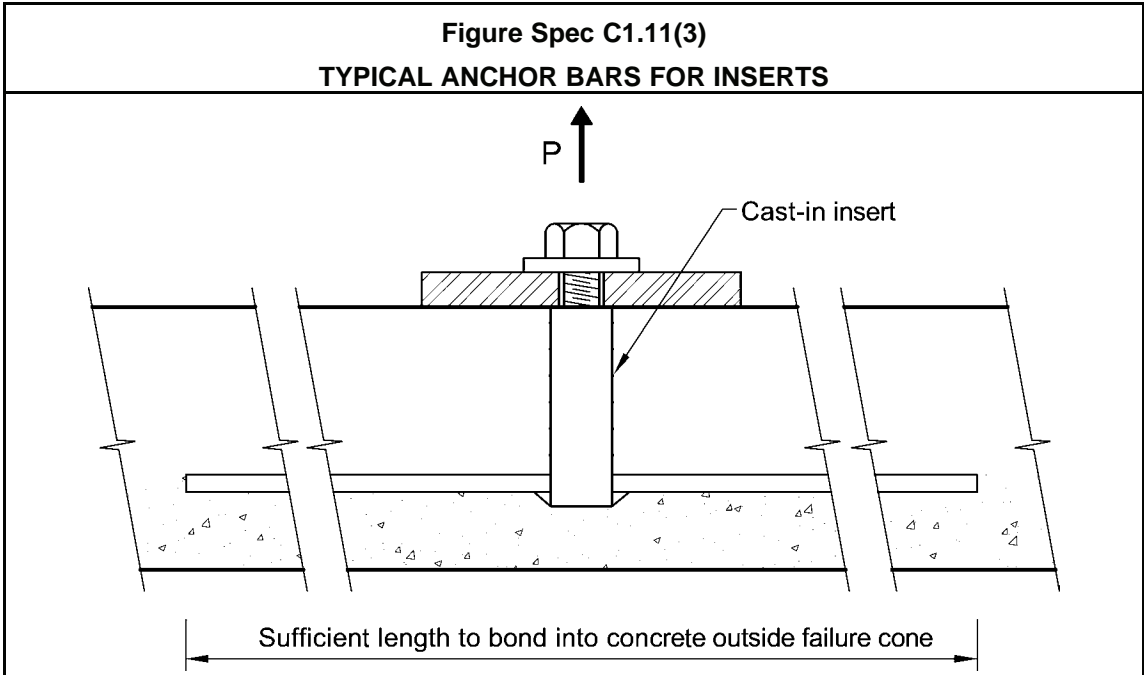

Clause 3(b) sets out the strength capacity required for top inserts or fixings so that the collapsing framework or roof structure will pull the panel inwards. See **Figure Spec C1.11(4)**. The value for outward displacement of one tenth of the panel's height is based on observations of deflections on buildings during a fire.

Figure C1.11(4)
FORCES TO PULL PANEL INWARDS

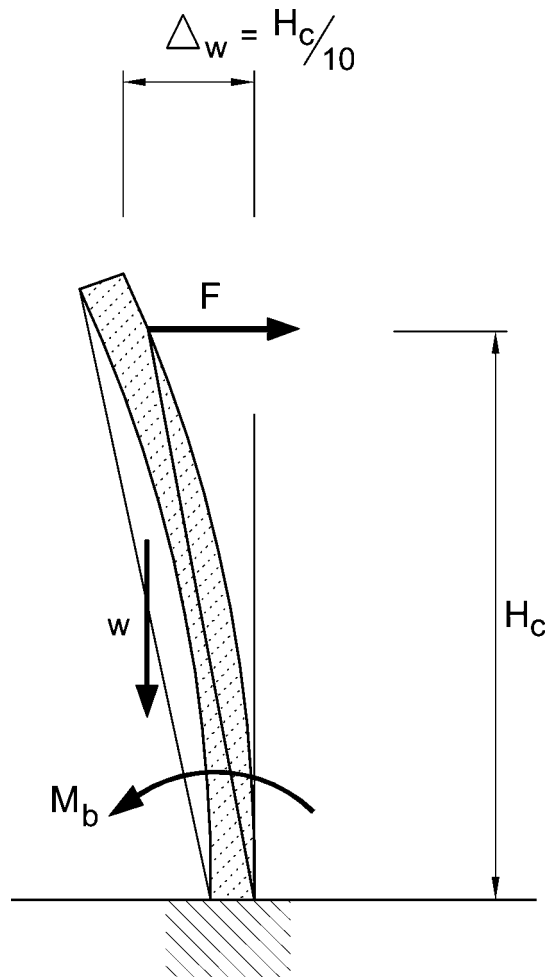

Drilled-in inserts and clips will suffer a greater strength loss from exposure to fire than cast-in inserts. The difference between the factor of two given in [Clause 3\(b\)](#) and of six in [Clause 3\(c\)](#) is based on engineering principles.

The lateral supporting members referred to in [Clause 3\(d\)](#), for “tilt-up type buildings”, may be roof beams or trusses.

Where the wall panels are supported by eaves tie members, [Clause 3\(d\)](#) requires that calculation of the forces in the eaves tie take into account the geometry of the deformations of the eaves tie. [Figure Spec C1.11\(5\)](#) illustrates this requirement.

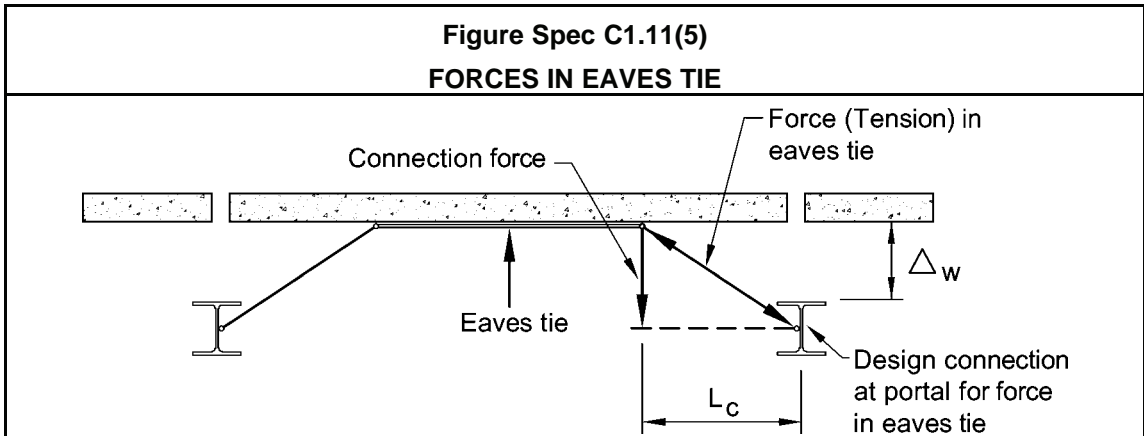

When applying the provisions of **Clause 3(e)**, panels used in a group have to be actually “designed to act as one unit”. It is not enough for the designer just to nominate the number of panels that are to act together.

While **Specification C1.11** mostly applies to vertically spanning panels, **Clause 3(f)** addresses specific provisions applicable to horizontally spanning panels.

4 Additional requirements for vertically spanning external wall panels adjacent to columns

Intent

To provide some additional requirements to enhance the safety of vertically spanning external wall panels which are adjacent to columns.

Observation of the effects of fires shows that during a fire:

- concrete panel walls tend to bow away from a fire;
- steel framework softens; and
- steel columns tend to deflect into the building.

These results create large forces on fixings of concrete wall panels to steel columns. Accordingly, **Clause 4(a)** requires that connections minimise the effect of such forces.

The provisions of **Clause 4(b)** provide two means of complying with **Clause 4(a)**. However, they may not be the only means. **Clause 4(a)** is a performance criterion.

Clause 4(b) provides two strategies for the designer to adopt to minimise fire induced forces on the means used to fix vertically spanning concrete wall panels to steel columns.

If the supporting framework is a material other than steel, such as concrete or timber, the differential deflections assumed by **Clause 4** will not occur, and the requirements of **Clause 4(b)(i)** and **(ii)** will be inappropriate.

Clause 4(b)(i) suggests a design of a fixing that will accommodate the expected differential displacement. **Figure Spec C1.11(6)** illustrates possible solutions to provide for the deflections. The magnitude of the differential deflection given in **Clause 4(b)(i)(A)** and **(B)** is based on observations of buildings under fire conditions.

The solution referred to in **Clause 4(b)(ii)** depends on fixing the concrete panel to the eaves tie member, and taking up the differential deflection in the eaves tie member. The distance this connection must be made away from the column is specified.

If this option is taken, the eaves tie member must be designed to comply with **Clause 3(d)**.

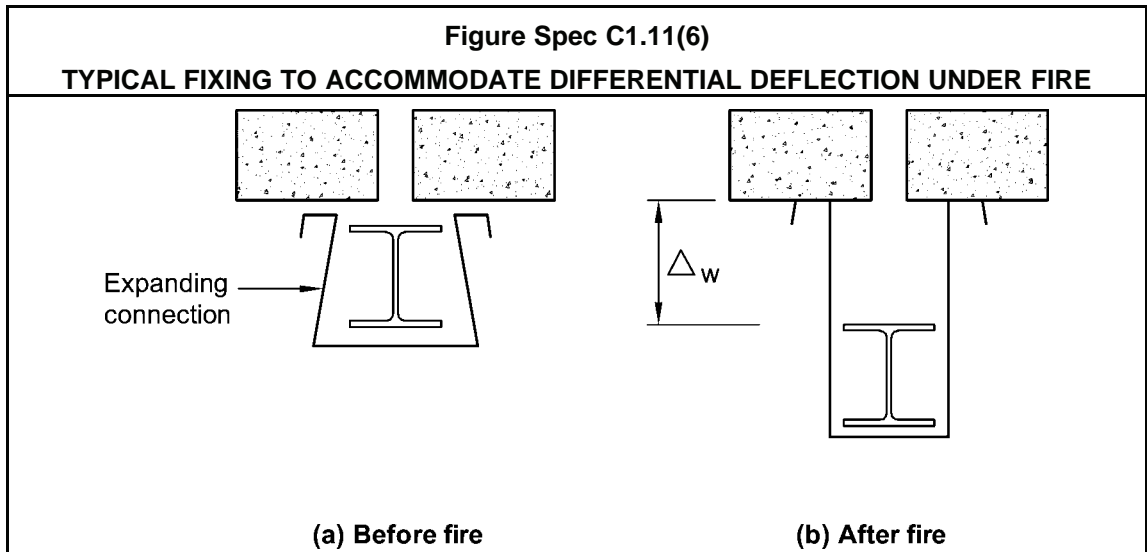

SPECIFICATION **C2.5** SMOKE-PROOF WALLS IN HEALTH-CARE AND AGED CARE BUILDINGS

Deemed-to-Satisfy Provisions

1 Scope

Intent

To prescribe construction requirements for smoke-proof walls required by **C2.5** in health-care and aged care buildings.

Specification C2.5 applies to smoke-proof walls in:

- Class 9a health-care buildings; and
- Class 9c aged care buildings.

2 Class 9a health-care buildings

Intent

To prescribe construction requirements for smoke-proof walls required by **C2.5** in Class 9a health-care buildings.

Clause 2 applies to smoke-proof walls in Class 9a health-care buildings.

3 Class 9c aged care buildings

Intent

To prescribe construction requirements for smoke-proof walls required by **C2.5** in Class 9c aged care buildings.

Clause 3 applies to smoke-proof walls in Class 9c aged care buildings.

The purpose of the smoke-proof walls is to create a “smoke compartment” to stop or limit the spread of smoke to adjoining areas. It is therefore important that all penetrations of the walls and ceiling of the “smoke compartment” be sealed against the penetration of smoke. This includes any light fitting in the flush plasterboard ceiling referred to in **Clause 3(a)(iii)**.

A wall lining need only be applied to one side of the wall to achieve compliance with **Clause 3**.

4 Doorways in smoke-proof walls

Intent

To limit the spread of smoke between smoke-zones by the use of smoke-reservoirs.

SUPERSEDED
FIRE RESISTANCE

SPECIFICATION **C3.4** FIRE DOORS, SMOKE DOORS, FIRE
WINDOWS AND SHUTTERS

Deemed-to-Satisfy Provisions

1 Scope

Intent

To prescribe standards for the construction of fire doors, smoke doors, fire windows and fire shutters.

Specification C3.4 contains detailed Deemed-to-Satisfy Provisions that could form part of a Building Solution for achieving the Performance Requirements relevant to:

- fire doors;
- smoke doors;
- fire windows; and
- fire shutters.

2 Fire Doors

Intent

To specify the fire performance of fire doors to achieve compatibility with the fire performance of the walls in which they are located.

Required fire doors must comply with AS 1905.1, which is the construction Standard for fire doors. This Standard in turn requires that fire doors be tested in accordance with AS 1530.4.

If there is any glazing in the door, the door must not fail by radiation through that glazing within the period specified in the door's FRL criterion of integrity.

In most cases, the BCA requires a fire door to have an FRL of -/60/30. Where a fire door is located in a firewall, a higher FRL is required.

The first criterion of zero minutes is a reference to the structural adequacy of the door. AS 1905.1 does not require a fire door to be tested for structural adequacy.

The final criterion of 30 minutes is a reference to the insulation the door must provide. It is difficult for a fire door to achieve a higher insulation criterion when tested in accordance with AS 1530.4.

Any glass panel in a fire door must not fail through heat radiation during a fire, as measured by the AS 1530.4 test, before the door fails the integrity criterion. If the glass panel fails by radiation, spread of fire could occur due to radiant heat igniting combustible materials.

3 Smoke Doors

Intent

To specify the smoke performance of smoke doors to achieve compatibility with the smoke performance of the walls in which they are located, by minimising the flow of smoke from one side of the door to the other.

Clause 3.1 is a performance criterion for smoke doors. It sets the general requirement that smoke doors must prohibit the passage of smoke from one side to the other; and if glass panels are installed, minimise the risk of injury of people accidentally walking into them. For example, it would generally be acceptable for the panel to be opaque.

To comply with **Clause 3.1**, a building proponent may choose to comply with **Clause 3.2**.

Construction deemed-to-satisfy

Intent

To specify the general requirements under the Deemed-to-Satisfy Provisions for the construction of smoke doors.

Under **Clause 3.2(a)**, the leaves of a smoke door which is intended to achieve the requirements of **Clause 3.1** must swing in both directions, or in the direction of travel. This means that they cannot be sliding doors or roller shutters.

To make sure that a door is adequately smoke sealed during a fire:

- the doors must achieve a resistance to smoke at 200°C for 30 minutes. To achieve this, the door leaves can be at least 35 mm thick solid core timber, or of some other construction if the building proponent can satisfy the appropriate authority that it will achieve the requirements of **Clause 3.2(b)(i)**;
- the leaves must be fitted with smoke seals;
- the door must normally be closed, or automatic-closing;
- where the door is automatic-closing, it must be activated by smoke detectors which comply with the relevant provisions of AS 1670.1 and are located as specified in **Clause 3.2(d)(ii)(A)**. Under **Clause 3.2(d)(ii)(B)**, the doors release and close in a power failure; and
- where the doors are opened manually, they must return to the closed position each time they are opened.

Clause 3.2 requires glazing in smoke doors to comply with AS 1288. The glazing must achieve the requirements of **Clause 3.2(g)(i)** if it is capable of being mistaken for an unobstructed opening as part of an exit. This is achieved by complying with the requirements of **Clause 3.2(g)(ii)**. The intent of **Clause 3.2(g)** is not to permit the glazing in smoke doors to be entirely of clear construction.

Other means of achieving it can be used if the building proponent can satisfy the appropriate authority that they will achieve the requirements of **Clause 3.2(g)(i)**.

There is currently some discussion regarding whether or not seals around smoke resistant doors are required to achieve the same resistance to smoke at 200°C in the same manner as the smoke door leaves under **Clause 3.2(b)(i)**. Any queries on this matter should be referred to the State or Territory body responsible for building regulatory matters.

4 Fire Shutters

Intent

To enable the fire performance of fire shutters to be compatible with the fire performance of the walls in which they are located.

Under **Clause 4(a)(i)**, required fire shutters must have the required FRL determined in accordance with **Specification A2.3**.

Specification A2.3 requires that a prototype of the element being tested must be subjected to the Standard Fire Test. See AS 1530.4.

In order for a fire shutter to comply with **Specification C3.4**, it must be identical to a prototype tested in accordance with AS 1530.4.

When testing the FRL of fire shutters in accordance with AS 1530.4, the structural adequacy criteria is not included. Hence, these criteria are not included in the required FRL of a fire shutter.

Under **Clause 4(a)**, non-metallic fire shutters:

- must be identical to a prototype tested in accordance with AS 1530.4;
- must not be larger than the tested prototype; and
- during the AS 1530.4 testing, the temperature on the non-furnace side of the shutter must not exceed 140 K during the first 30 minutes of the test.

The reason for the last condition is to reduce the amount of radiant heat on the non-fire side of the shutter, which could ignite combustible materials.

Under **Clause 4(b)**, metallic fire shutters can only be used if not prohibited by **C3.5**. Metallic fire shutters are not permitted in certain situations because of the risk that fire could spread by way of radiated heat facilitated by the metal construction of the shutter. Such radiated heat could ignite combustible materials on the non-fire side of the shutter.

If permitted, metallic fire shutters must either comply with AS 1905.2 or be in accordance with **Clause 4(a)**, in that they:

- must be identical to a prototype tested in accordance with AS 1530.4;
- must not be larger than the tested prototype; and
- during the AS 1530.4 testing, the rise in temperature on the non-furnace side of the shutter must not exceed 140 K during the first 30 minutes of the test.

5 Fire Windows

Intent

To specify the fire performance of fire windows to achieve compatibility with the fire performance of the walls in which they are located.

Required fire windows must have the required FRL determined in accordance with **Specification A2.3**.

Specification A2.3 requires that a prototype of the element being tested must be subjected to the Standard Fire Test. See AS 1530.4.

Therefore, in order for a fire window to comply with **Specification C3.4**, it must be identical to a prototype tested in accordance with AS 1530.4.

When testing the FRL of fire windows in accordance with AS 1530.4, the structural adequacy and insulation criteria are not included. Hence these criteria are not included in the required FRL of a fire window.

SPECIFICATION **C3.15** PENETRATION OF WALLS, FLOORS
AND CEILINGS BY SERVICES

Deemed-to-Satisfy Provisions

Specification C3.15 sets out details of permissible service penetrations through walls, floors and ceilings, and was developed using building practices that are in general use. The Specification permits the use of metal pipe systems and conduits (but not flue pipes) which do not satisfy the insulation criteria of AS 1530.4, provided certain criteria are met.

Specification C3.15 does not apply to larger diameter electrical cables (ie where the opening is larger than those specified in **Clause 5(a) and (b)** of 2000 mm² or 500 mm²). This does not mean that larger diameter electrical cables cannot be approved under **C3.15**. Larger diameter electrical cables can be approved under **C3.15(a)(i)** or, if necessary, as an Alternative Solution.

SECTION **D**

ACCESS AND EGRESS

- D1** **Provision for Escape**
- D2** **Construction of Exits**
- D3** **Access for People with Disabilities**

SECTION D CONTENTS

SECTION D ACCESS AND EGRESS

Section D Access and Egress

Objective DO1
Functional Statements DF1 - DF2
Performance Requirements DP1 - DP9
Verification Method DV1

Part D1 Provision for Escape

D1.0 Deemed-to-Satisfy Provisions
D1.1 Application of Part
D1.2 Number of exits required
D1.3 When fire-isolated stairs and ramps are required
D1.4 Exit travel distances
D1.5 Distance between alternative exits
D1.6 Dimensions of exits and paths of travel to exits
D1.7 Travel via fire-isolated exits
D1.8 External stairways or ramps in lieu of fire-isolated exits
D1.9 Travel by non-fire-isolated stairways or ramps
D1.10 Discharge from exits
D1.11 Horizontal exits
D1.12 Non-required stairways, ramps or escalators
D1.13 Number of persons accommodated
D1.14 Measurement of distances
D1.15 Method of measurement
D1.16 Plant rooms and lift machine rooms: Concession

Part D2 Construction of Exits

D2.0 Deemed-to-Satisfy Provisions
D2.1 Application of Part
D2.2 Fire-isolated stairways and ramps
D2.3 Non-fire-isolated stairways and ramps
D2.4 Separation of rising and descending stair flights
D2.5 Open access ramps and balconies
D2.6 Smoke lobbies
D2.7 Installations in exits and paths of travel
D2.8 Enclosure of space under stairs and ramps
D2.9 Width of stairways
D2.10 Pedestrian ramps
D2.11 Fire-isolated passageways
D2.12 Roof as open space
D2.13 Goings and risers
D2.14 Landings
D2.15 Thresholds
D2.16 Balustrades or other barriers

- D2.17 Handrails
- D2.18 Fixed platforms, walkways, stairways and ladders
- D2.19 Doorways and doors
- D2.20 Swinging doors
- D2.21 Operation of latch
- D2.22 Re-entry from fire-isolated exits
- D2.23 Signs on doors

Part D3 Access for People with Disabilities

- D3.0 Deemed-to-Satisfy Provisions
- D3.1 General building access requirements
- D3.2 Access to buildings
- D3.3 Parts of buildings to be accessible
- D3.4 Exemptions
- D3.5 Accessible carparking
- D3.6 Signage
- D3.7 Hearing augmentation
- D3.8 Tactile indicators
- D3.9 Wheelchair seating spaces in Class 9b assembly buildings
- D3.10 Swimming pools
- D3.11 Ramps
- D3.12 Glazing on an accessway

Specifications

- Specification D1.12 Non-Required Stairways, Ramps and Escalators
- Specification D3.6 Braille and Tactile Signs
- Specification D3.10 Accessible water Entry/Exit for swimming pools

SECTION D ACCESS AND EGRESS

Issues — Part D3 and the relevant performance provisions

Compliance with Disability Discrimination Act 1992 (DDA)

Section 23 of the *Disability Discrimination Act 1992* (DDA) makes it unlawful to discriminate against another person on the ground of the person's disability in relation to a number of aspects of access to, or use of, premises. The DDA also provides that the relevant Minister may, by legislative instrument, formulate standards in relation to any area in which it is unlawful to discriminate against another person on the ground of a disability. The Disability (Access to Premises — Buildings) Standards (Premises Standards) were formulated following requests for improved certainty under the DDA in satisfying its requirements for non-discriminatory access to premises. The BCA provisions for access for people with a disability have been aligned with the technical provisions in the Premises Standards. This results in a uniform set of requirements that will apply both in relation to non-discriminatory access under the DDA and in relation to the requirements for access that must be complied with in order to obtain a building approval under building law.

Objective

DO1

Safe, equitable and dignified access—DO1(a)

DO1(a) requires the provision of safe, equitable and dignified access to a building and its services, as far as is reasonable. Several of these terms are explained below.

As far as is reasonable

There may be occasions when the application of a rule is “unreasonable”. Use of the phrase “as far as is reasonable” indicates that the BCA provisions are not absolute. This is consistent with the intent of the DDA.

Equitable

One of the primary intentions of the DDA is to provide people with a disability with the same rights as the rest of the community.

The word “equitable” combines concepts of fairness and equality. It does not mean that all people must be able to do precisely the same thing in the same way. However, if some people can use a building for a particular purpose, then most people should be able to use the building for that purpose.

Examples

If most members of the community enter a building at a particular point, normally the front entrance, people with a disability should be able to enter the same building at that point.

However, this may not mean entry through the same door. For example, a revolving door may not be suitable for guide dogs or wheelchairs. However, people who use guide dogs or wheelchairs should be able to enter the building at an adjacent door.

The concept of “equitable” does not necessarily mean that everybody should be able to access all parts of a building.

Dignified

A person with a disability should be able to gain access to and within a building, and to the services and facilities of buildings, in a manner which is not devaluing or demeaning.

Safeguarding people evacuating—DO1(b)

DO1(b) refers to safeguarding occupants while evacuating in an emergency. This includes people with a disability who cannot independently use exits and may require specific egress arrangements.

Example

A person who is able to walk without assistance is able to reach a public space on an upper level of a building with dignity, perhaps by walking up a flight of stairs. A person with a mobility disability should also be able to access that space with similar dignity. It is unlikely that having to be carried up the stairs would achieve this requirement.

Functional Statements

DF1

DF1(b) refines the intention of **DO1(a)**.

It also excludes the application of **DF1(b)** to a Class 4 part of a building.

DF2

DF2 refines the intention of **DO1(b)**. A building must provide the capacity for occupants to evacuate in a safe and timely manner, without being overcome by the effects of the emergency (for example, smoke, heat or flame in the case of a fire).

DF2 does not apply to the internal parts of any sole-occupancy unit located within a Class 2 or Class 3 building or a Class 4 part. The design of the internal parts of sole-occupancy units is not regulated in regards to egress, as occupants will generally be familiar with egressing the units and the distances to travel to doors leading out of the units will generally not be excessive.

Performance Requirements

DP1

Standard of access to and within a building

DP1 refines the intention of **DO1(a)**. A building must, as far as is reasonable, provide safe access for people to all the services and facilities in it.

It also excludes the application of **DP1** to a Class 4 part of a building.

Emphasis on access for people

The required access is for people, including people with a disability.

To the degree necessary

DP1 uses the term “to the degree necessary”. See **A1.7**.

DP2

Safe movement required within a building

DP2 generally sets the performance required for safe movement within a building for most people, including those with a disability.

Safe gradient—**DP2(a)**

The **DP2(a)** requirement for a safe gradient is to facilitate access and safety for all people, and refers to the crossfall as well as the longitudinal grade.

Doors—**DP2(b)**

DP2(b) aims to make sure people are not put at risk by doors impeding egress or causing them to be trapped.

Stairways and ramps—**DP2(c)**

Slip-resistant walking surfaces—**DP2(c)(i)**

People moving on stairways and ramps should not slip and fall. This is a particular issue during an emergency.

Handrails—**DP2(c)(ii)**

Handrails may be necessary to assist people using stairways and ramps, particularly in helping them maintain their stability.

Landings for ramps—**DP2(c)(iii)** and **(iv)**

Under **DP2(c)(iii)** and **(iv)**, it is necessary to provide landings for ramps as well as stairways. As with stairways, the landings on a ramp are used as a place to rest when necessary. Landings at doorways provide a level plane from which doors may be safely opened.

Safe passage on stairways—**DP2(c)(v)**

DP2(c)(v) requires that a stairway must be suitable for the safe passage of people, and appropriate to the nature, volume and frequency of use. This is a reference to the riser and

going of the treads, and the width of the stairway. Hence the rise, going and width may differ between buildings as long as a safe passage is provided.

DP3

Barriers

DP3 principally relates to barriers which are meant to prevent people accidentally falling through an opening, etc.

Barriers and children

Children are at particular risk of falling off, over or through ineffectively designed or constructed barriers. Accordingly, **DP3** makes specific reference to the need for such barriers to restrict the passage of children.

Use of windows as barriers

Provided it achieves the requirements of **DP3** (such as having the required strength and not opening far enough to permit the passage of children), a window can act as a barrier. In other words, it will stop people, including children, from accidentally falling.

DP3 limitations

Areas where barriers may interfere with use

DP3 does not apply where the use of a balustrade or the like would be inconsistent with the use of the area.

Examples

Loading docks, where a barrier would inhibit the unloading of trucks or other vehicles.

The stage of a theatre, where a barrier would interfere with the viewing of the performance.

Railway platforms, where a barrier would result in people not being able to get on or off a train.

Fire-isolated stairways or ramps

Fire-isolated stairways or ramps and the like are exempted from **DP3(d)** because unsupervised children are unlikely to have access to such areas.

Class 7 and Class 8 buildings

Class 7 (other than carparks) and Class 8 buildings are exempted from **DP3(d)**. This is for two primary reasons:

- unsupervised children are unlikely to have access to such buildings; and
- large numbers of people, particularly members of the general public unfamiliar with the building or its environs, are unlikely to have access to such buildings.

Carparks are not included in this exemption from compliance with **DP3(d)** as they are often public in nature.

DP4

Number, dimensions and distribution of exits

DP4 is the Performance Requirement for the number, dimensions and distribution of exits.

DP4(a)—the travel distance will affect the time taken to evacuate the building. Greater distances will require greater evacuation times.

DP4(b)—the number of occupants can affect the evacuation time. A greater number of people will require a greater evacuation time through a single exit. This time can be reduced by such means as:

- increasing the number and/or width of the exits, or
- reducing the travel distance to the exits by utilising other options for their location.

DP4(b)—the mobility and other characteristics of occupants will have a direct effect on the evacuation time. Matters to be considered include whether the occupants are likely to have limited mobility or capacity to find their way unassisted, and the type and the extent of that limitation. For example, people may be in beds or have some kind of ambulatory-related disability, or may be asleep or anaesthetised, or may be under the influence of drugs or otherwise confused.

DP4(c)—the function or use of the building will have an effect on the building's fire load.

DP4(d)—the height of the building will affect the distance a person escaping from the building would have to travel. The height therefore has an impact on the evacuation time.

DP4(e)—to ensure the safety of occupants, an exit from a level below ground level needs to satisfy different criteria to that of an exit from levels above ground. For example, an exit from a basement must take account of criteria such as:

- the difficulty in naturally venting smoke from a fire because of the lack of windows; and
- the need for occupants to evacuate in the direction of smoke travel (which will be upwards). This is the opposite to upper storeys, where people would be evacuating downwards and the smoke would be travelling upwards.

DP5

Fire-isolated exits

DP5 is the Performance Requirement for determining when fire-isolated exits are necessary to provide protection for evacuating occupants.

Use of fire-isolated exits

Fire-isolated exits are used in multi-storey buildings to:

- enable people to evacuate safely past a storey on fire;
- facilitate fire brigade access to carry out operations such as search and rescue and fire-fighting; and
- minimise the distance people need to travel in a fire affected area before they are able to access a "safe place", such as a fire-isolated stairway.

Criteria for fire-isolated exits

Fire-isolated exits must be installed when necessary, and must be appropriate to a number of factors.

DP5(a)—the number of storeys connected by the exit will affect the distance a person has to travel while escaping from the building, and, therefore, will also affect the evacuation time.

DP5(b)—fire safety systems are expected to reduce the rate of fire spread (eg if a sprinkler system is installed, it will either extinguish the fire or reduce its growth rate), therefore allowing greater evacuation times.

DP5(c)—the function or use of the building will have an effect on the building's fire load.

DP5(d)—the number of storeys passed through by the exits will affect the distance a person escaping from the building would have to travel, and therefore has an impact on the evacuation time.

DP5(e)—“fire brigade intervention” is the terminology used in the BCA to determine the time taken by the brigade to arrive at the building (presuming that the building is in an area served by a fire brigade) and any likely action of its officers (eg whether they will undertake a search and rescue operation, and the likely time for that operation).

DP6

Paths of travel to an exit

DP6 is the Performance Requirement for paths of travel to an exit. It is separate from **DP4** because the needs for paths of travel are often different from the needs for exits.

Class 2 or Class 3 buildings or Class 4 parts

The limitation attached to **DP6** indicates that it does not apply within a sole-occupancy unit of a Class 2 or Class 3 building or Class 4 part. The design of the internal parts of sole-occupancy units is not regulated in regards to egress, as occupants will generally be familiar with egressing the units and the distances to travel to doors leading out of the units will generally not be excessive.

The exception to the general rule concerning the path of travel to the door leading out of a sole-occupancy unit of a Class 2 or Class 3 building or Class 4 part is when smoke hazard management matters are being considered. For more information on the reason for this exception, refer to Part **E2**.

Criteria for paths of travel to exits

As set out in **DP6**, paths of travel to exits must have dimensions appropriate to a number of factors, including:

- **DP6(a)**—the number of occupants can affect the evacuation time—the greater the number of people the greater the evacuation time required (this time can be reduced by increasing the number and/or width of (exits) and paths of travel to exits);
- **DP6(a)**—the mobility and other characteristics of occupants will have a direct impact on the evacuation time—matters to be considered include whether the occupants are likely to have limited mobility or capacity to find their way unassisted, and the type and the extent of that limitation (for example, people may be in beds or have some kind of ambulatory-related disability, or may be asleep or anaesthetised, or may be under the influence of drugs or otherwise confused); and
- **DP6(b)**—the function or use of the building takes account of any special provisions such as movement of beds in hospitals.

DP7

* * * * *

The content of **DP7**, which existed in BCA 2010, has been removed. The Performance Requirement number **DP7** has been retained without text so as not to change the numbering of the current BCA from that of BCA 2010.

DP8

Carparking spaces for people with a disability

DP8 is the Performance Requirement for carparking spaces for people with a disability.

If carparking is provided in or around a building, suitable carparking spaces must be provided for people with a disability. These spaces are required to be larger than a conventional space. This facilitates a person transferring from a vehicle to a wheelchair or other mobility aid positioned between vehicles.

DP9

Hearing augmentation

DP9 is the Performance Requirement for hearing augmentation and refines the intention of **DO1(a)**. A building must, as far as is reasonable, provide safe access for people to all the services, facilities and features. **DP9** relates to the inclusion of hearing augmentation systems where an inbuilt audible communication system is used for entry, information, entertainment, or provision of a service. This requirement is not intended to apply to equipment such as televisions, music systems etc that are provided for the purposes of improving an occupant's general comforts and ambience but which are not associated with the specific functioning of the building or specific services or entertainment provided.

It does not apply to a Class 4 part of a building.

It is also important to note that it does not apply to an inbuilt communication system used only for emergency warning purposes.

Verification Method

DV1 Wire balustrades

DV1 is a means to verify whether or not a proposed wire balustrade achieves the requirements of **DP3(e)** and **(f)**, in other words whether the wire balustrade is—

- constructed to prevent people from falling through the barrier; and
- capable of restricting the passage of children.

DV1 cannot be used to verify compliance with the other provisions of DP3.

It is not compulsory for a designer to use **DV1**. The designer has the choice of using—

- **DV1** to verify that the proposal achieves **DP3(e)** and **(f)**; or
- the Deemed-to-Satisfy Provisions in **D2.16(i)**.

As set out in **DV1(a)**, the Verification Method may be carried out on—

- a prototype that is identical to that proposed to be installed; or
- a wire balustrade installed on site.

The meaning of the phrase "prototype that is identical to that proposed to be installed" is similar to that for the testing of prototypes for fire resistance. That is, it must be identical with respect to the type of wire, the wire diameter, the number of lays, the wire tension, the post spacing and size, etc.

The test procedure is slightly different for balustrades with horizontal or near horizontal wires and vertical wires or near vertical wires (see the test procedures set out in **DV1(c)(ii)**).

If **DV1** is to be used for horizontal or near horizontal wire balustrades, **DV1(c)(vi)**, whereby the deflection of the tensioned wires is measured as part of the prototype test, allows a simple method of checking that the balustrade wires installed on site have been installed at the required tension if a tension gauge is not available.

PART **D1** PROVISION FOR ESCAPE

Objective

Functional Statements

Performance Requirements

The Objective, Functional Statements and Performance Requirements precede Part**D1**.

Deemed-to-Satisfy Provisions

D1.0 Deemed-to-Satisfy Provisions

Intent

To clarify that the requirements of **DP1** to **DP9** will be satisfied if compliance is achieved with Parts **D1**, **D2** and **D3** in the case of all buildings, and Part **G3** in the case of buildings with an atrium, Part **H1** in the case of theatres, stages and public halls, and **Part H2** for public transport buildings.

Most buildings

Where a Building Solution is proposed to comply with the Deemed-to-Satisfy Provisions, **D1** clarifies that for most buildings compliance with Parts **D1**, **D2** and **D3** will achieve compliance with **DP1** to **DP9**. The exceptions to this general rule are set out below.

Buildings with an atrium

If the building contains an atrium, it must comply with Part **G3** in addition to Parts **D1**, **D2** and **D3**.

Theatres, stages and public halls

A building which comprises a theatre, stage or public hall must comply with Part **H1** in addition to Parts **D1**, **D2** and **D3**.

Atrium and theatre, stage or public hall

If the building contains an atrium and one or more of a theatre, stage or public hall, it must comply with Parts **D1**, **D2**, **D3**, **G3** and **H1**.

Buildings in alpine areas

A building located in an Alpine Area must comply with Part **G4** in addition to Parts **D1**, **D2** and **D3**.

Public transport buildings

A building associated with public transport services, such as railway stations, bus interchanges, airports and ferry terminals must comply with Part **H2** in addition to Parts **D1**, **D2** and **D3**.

Where a Building Solution is proposed as an Alternative Solution to the Deemed-to-Satisfy Provisions, the relevant Performance Requirements must be determined in accordance with **A0.10**. (See comment on **A0.10**).

D1.1 Application of Part

Intent

To exempt internal parts of sole-occupancy units in Class 2 and Class 3 buildings and Class 4 parts from the Part **D1** Deemed-to-Satisfy Provisions.

Sole-occupancy units—Class 2 and Class 3

The Part **D1** Deemed-to-Satisfy Provisions do not apply within a sole-occupancy unit of a Class 2 or Class 3 building and Class 4 parts.

This is because most occupants are familiar with the layout of their unit. The units are small in area compared to sole-occupancy units in other classes of building. They will also have a low level of occupancy and a lower fire load than most commercial and industrial buildings.

Additionally, such units will be separated from the rest of the building by fire-rated construction, or sprinklers will be installed. Except when considering smoke-hazard management matters, the path to the door leading out of sole-occupancy units is not regarded as part of the path of travel to an exit. See Part **E2**.

D1.2 Number of exits required

Intent

To require the provision of sufficient exits to enable safe egress in case of an emergency.

All buildings—**D1.2(a)**

Under **D1.2(a)**, all buildings must have at least one exit from each storey. The remainder of **D1.2** sets out the circumstances in which more than one exit may be required.

Why do some buildings require multiple exits?

The purpose of regulatory control over the number of exits in a building is to maximise the opportunities for people to have egress from the building in an emergency.

Egress from some buildings can be very difficult (for example, particularly tall or large buildings, or even small buildings which have a complex passageway design). It may be necessary to provide several alternative exits.

Horizontal exits

While a number of the **D1.2** provisions refer to “horizontal exit”, they do not require the installation of a horizontal exit. Rather, where a horizontal exit exists or is proposed, at least two additional exits must be provided. Where there is no horizontal exit, there must still be at least two exits.

Class 2 to Class 8 buildings—D1.2(b)

The **D1.2(b)(i)** provision regarding an effective height of 25 metres recognises the effective operating height for fire brigade ladders and other fire-fighting and rescue equipment. Above this height, fire-fighting, rescue and egress problems increase considerably.

D1.2(b)(ii)—Class 2 and Class 3 buildings complying with C1.5

C1.5 provides a concession for Class 2 and Class 3 buildings (having a rise in storeys of two), in that if they comply with certain conditions they may be of Type C construction. In order to qualify for that concession such buildings must have at least 2 exits.

This provision recognises that Class 2 and Class 3 buildings constructed in accordance with **C1.5** include additional evacuation provisions.

Basements—D1.2(c)

“Basement” is not defined in the BCA. A basement is regarded as a below-ground-level storey not counted in the rise in storeys.

Any basement in excess of the minimum floor area specified in **D1.2(c)(i)** which has a travel distance to an exit in excess of that specified in **D1.2(c)(ii)**, must have at least two exits. The reason for this is that basements present difficulties in terms of egress and fire-fighting. These include:

- the difficulty in naturally venting smoke from a fire because of the lack of windows; and
- the need for occupants to evacuate in the direction of smoke travel. This is the opposite to upper storeys, where people would be evacuating downwards and the smoke travelling upwards.

Class 9 buildings—D1.2(d)

All Class 9 buildings

D1.2(d)(i) covers Class 9 buildings with a rise in storeys of more than six (additional to the provisions which apply to Class 2 to Class 8 buildings) and Class 9 buildings with an effective height of more than 25 metres (which is the same as for Class 2 to Class 8 buildings, and recognises the effective operating height for fire brigade ladders and other fire-fighting and rescue equipment).

D1.2(d)(i) recognises the emergency egress requirements for Class 9 buildings. Such buildings could contain large numbers of people who may be unfamiliar with the building’s egress provisions. They might also be confused and in various stages of immobility.

D1.2(d)(i) does not refer to “whichever is the lesser”, nor, for that matter, “whichever is the greater”—meaning that both are applicable.

Additional requirements for some Class 9 buildings

In **D1.2(d)(ii)–(vi)**, and **D1.2(e)** and **(f)**, the BCA recognises that some Class 9 buildings (patient care areas, aged care buildings, early childhood centres, schools, spectator stands, storeys or mezzanines containing more than 50 people as calculated under **D1.13**) present difficult evacuation conditions (requiring two exits additional to any horizontal exits) because of such factors as:

- the age and nature of the occupants;
- the density of occupation (for example, occupants per m²); and
- the unfamiliarity of occupants with the emergency evacuation requirements.

Exits must be accessible—**D1.2(g)**

There is little point requiring exits if they are not accessible at all times. **D1.2(g)** requires that occupants must be able to access an exit. Where two or more exits are required, at least two exits (allowing for the fact that one of the exits may be made inaccessible by an emergency, such as a fire) should be accessible.

Such access must not be through another sole-occupancy unit because access to the unit may be locked or barred.

D1.3 When fire-isolated stairs and ramps are required

Intent

To indicate when fire-isolated stairways and ramps are required to enable safe egress in case of a fire.

D1.3 and DP5

D1.3 comprises the Deemed-to-Satisfy Provisions for **DP5**.

Purpose of fire-isolated exits

Fire-isolated exits are required in multi-storey buildings to enable people to evacuate past a storey on fire. They also help the fire brigade carry out search and rescue and fire-fighting.

Such exits minimise the distance people need to travel in a fire-affected area before accessing a "safe place", such as a fire-isolated stairway.

Fire-isolated exits may be:

- fire-isolated stairways;
- fire-isolated ramps; and
- fire-isolated passageways connected to fire-isolated stairways or ramps.

D1.3 sets out when stairways and ramps connecting storeys in a building are required to be fire-isolated. This only applies to a stairway or ramp serving as a required exit. Therefore, from the definition of "exit", **D1.3** only applies to those providing egress to a road or open space. Combined with the provisions of **D1.2** that exits are required from every storey, a stairway or ramp serving as an exit will generally be connecting storeys. However, the term "exit" could also apply to a stairway or ramp from a basement that exits vertically, directly to a road or open space and thus, does not technically connect storeys.

D1.3 only applies to stairways that are required exits and therefore does not apply to stairways between split levels of a single storey of a building or those leading from the front door of a building.

Exceptions

External stairways

Under certain specified conditions, **D1.8** permits the use of external stairways in place of fire-isolated stairways.

Class 2 buildings—D1.3(a)(i)

D1.3(a)(i) permits Class 2 buildings to have non-fire-isolated exits provided they do not connect, pass through or pass by more than three consecutive storeys, plus an extra storey of any classification under specified conditions. The terms “connect”, “pass through” and “pass by” include the following situations:

- Where the exit provides access to the storey.
- Where the exit passes through the storey but does not necessarily provide access to or egress for the storey.
- Where the exit is external to the building, ie passes by the storey but does not necessarily provide access to or egress for the storey.

With regard to the allowance for 3 storeys, the BCA assumes that residents of Class 2 buildings tend to be long-term occupants, and aware of their surroundings. This makes them likely to be able to exit quickly without the need for fire-isolated exits.

An extra storey of any classification may be included under certain circumstances where the fire risk associated with the extra storey is low. The circumstances are:

- where the extra storey is used for a carpark or other ancillary purposes. In Class 2 buildings a carpark usually represents a low fire risk, and is unlikely to have many occupants for any length of time. The inclusion of the extra storey applies when the building only consists of a Class 2 building and a carpark. The building may also include a Class 3 part, however in such a case, the Class 3 portion of the building would control the number of storeys connected by a non-fire-isolated exit (see comments on **D1.3(a)(ii)**); and
- where the building contains a sprinkler system. This concession recognises the ability of sprinkler systems to extinguish or contain a fire thereby allowing additional time for occupants to escape; and
- where the exit is separated from the extra storey by walls having an FRL consistent with those required for a public corridor in a Class 2 or 3 building. By having separating walls with an FRL and by preventing any connection to the extra storey for the purpose of providing access to or egress for that storey, the non-fire-isolated exit is protected from the fire risk associated with the extra storey.

Class 3 buildings—D1.3(a)(ii)

D1.3(a)(ii) permits Class 3 buildings to have non-fire-isolated exits provided they do not connect, pass through or pass by more than two consecutive storeys, plus an extra storey of any classification under specified conditions. The terms “connect”, “pass through” and “pass by” include the following situations:

- Where the exit provides access to the storey.
- Where the exit passes through the storey but does not necessarily provide access to or egress for the storey.
- Where the exit is external to the building, ie passes by the storey but does not necessarily provide access to or egress for the storey.

The allowance for two storeys is based on residents of a number of Class 3 buildings being less familiar with the building layout and paths of travel to an exit than residents of a Class 2

building. The differential between Class 2 and Class 3 buildings recognises a higher potential level of risk in Class 3 buildings.

An extra storey of any classification may be included under certain circumstances where the fire risk associated with the extra storey is low. The circumstances are:

- where the extra storey is used for a carpark or other ancillary purposes. In Class 3 buildings a carpark usually represents a low fire risk, and is unlikely to have many occupants for any length of time. The inclusion of the extra storey applies when the building only consists of a Class 3 building and a carpark. The building may also include a Class 2 part, however in such a case, the Class 3 portion of the building would control the number of storeys connected by a non-fire-isolated exit; and
- where the building contains a sprinkler system. This concession recognises the ability of sprinkler systems to extinguish or contain a fire; and
- where the exit is separated from the extra storey by walls having an FRL consistent with those required for a public corridor in a Class 2 or 3 building. By having separating walls with an FRL and by preventing any connection to the extra storey for the purpose of providing access to or egress for that storey, the non-fire-isolated exit is protected from the fire risk associated with the extra storey.

Class 9a health-care buildings—D1.3(b)(i)

Under **D1.3(b)(i)**, required exits in Class 9a health-care buildings need to be fire-isolated if they connect, pass through or pass by more than two consecutive storeys, or the areas they connect, pass through or pass by include one or more patient care areas. The terms “connect”, “pass through” and “pass by” include the following situations:

- Where the exit provides access to the storey.
- Where the exit passes through the storey but does not necessarily provide access to or egress for the storey.
- Where the exit is external to the building, ie passes by the storey but does not necessarily provide access to or egress for the storey.

Open spectator stands—D1.3(b)(ii)

D1.3(b)(ii) allows an exemption for open spectator stands because of their open nature, which means that the build up of smoke is unlikely.

Class 5–9 buildings containing sprinklers—D1.3(b)(iii)

D1.3(b)(iii) does not apply to:

- a Class 9a building.
- a Class 9c aged care building.
- an open spectator stand.

D1.3(b)(iii) permits other Class 5–9 buildings to have non-fire-isolated exits provided they do not connect, pass through or pass by more than two consecutive storeys, plus an extra storey of any classification under specified conditions. The terms “connect”, “pass through” and “pass by” include the following situations:

- Where the exit provides access to the storey.
- Where the exit passes through the storey but does not necessarily provide access to or egress for the storey.
- Where the exit is external to the building, ie passes by the storey but does not necessarily provide access to or egress for the storey.

An extra storey of any classification may be included under certain circumstances where the fire risk associated with the extra storey is low. The circumstances are:

- where the building contains a sprinkler system. This concession recognises the ability of sprinkler systems to extinguish or contain a fire; and
- where the exit is separated from the extra storey by walls having an FRL consistent with those required for a public corridor in a Class 2 or 3 building. By having separating walls with an FRL and by preventing any connection to the extra storey for the purpose of providing access to or egress for that storey, the non-fire-isolated exit is protected from the fire risk associated with the extra storey.

D1.4 Exit travel distances

Intent

To maximise the safety of occupants by enabling them to be close enough to an exit to safely evacuate.

Travel distances

The **D1.4** travel distances are based on an assumption of what is considered “reasonable” distances to be travelled by occupants in reaching an exit.

Method of measurement

The travel distances specified in **D1.4** are measured in accordance with **D1.15**.

Class 2 and Class 3 buildings and Class 4 parts—**D1.4(a)** and **(b)**

D1.4(a)(i)(A) and **(B)** require a shorter travel distance, to a single exit, for Class 2 and Class 3 buildings and Class 4 parts than is required for Class 5 to Class 9 buildings.

The distance occupants of sole-occupancy units in Class 2 and Class 3 buildings and Class 4 parts must travel to leave their unit is not part of the distance specified in **D1.4**. Accordingly, the permitted distance of travel from the point at which the occupant leaves the unit must take account of the time needed for the occupant to reach that point from within the unit.

Distance of travel must factor in the time occupants need to wake up, become alert to their predicament, and exit in a state of confusion.

This process of becoming alert will inevitably require more time to exit. Therefore the distance of travel to an exit should be shorter.

Figure D1.4(1) illustrates various methods of complying with **D1.4** for Class 2 and Class 3 buildings.

Class 5 to Class 9 buildings—**D1.4(c)(i)**

D1.4(c)(i) sets out the maximum travel distance in Class 5–9 buildings. This includes Class 9c aged care buildings, but excludes Class 9a buildings, which must comply with **D1.4(d)**. (See comments on **D1.4(d)** for the reason Class 9a buildings are treated differently). The additional travel distance allowed in Class 9c buildings recognises the effectiveness of sprinkler systems that must be installed in these buildings.

The distances specified allow people to evacuate in a reasonable time, assuming that they are not asleep.

In case a fire blocks a path of travel, **D1.4(c)(i)** requires that alternative routes must be available within 20 metres of the starting point, unless it is possible to reach a single exit within 20 m.

The conditional reference in **D1.4(c)** to sub-clauses **(d)**, **(e)** and **(f)** refers to special provisions for particular types of building.

Figure D1.4(2) illustrates various methods of complying with **D1.4** for Class 5 and Class 6 buildings.

Class 5 and Class 6 buildings—D1.4(c)(ii)

D1.4(c)(ii) provides a concession for Class 5 and Class 6 buildings served by a single exit opening onto a road or open space. The concession only applies to the storey at the level of access to a road or open space.

D1.4(c)(ii) uses the phrase "at the level of access to a road or open space". The term "level" does not require the storey to be physically level or flush with the road or open space to obtain the concession, but simply requires that the storey is at a level from which occupants finally leave the building to reach a road or open space. The concession allows a greater travel distance of 30 m in lieu of 20 m to a single exit on the basis that occupants, including customers of a shop, are—

- generally aware of their surroundings in these types of buildings which are typically small shops or offices located at or near ground level; and
- familiar with the location of the exit which is typically the main entrance to the shop or office; and
- familiar with the path of travel to reach the exit thereby allowing a prompt and direct egress from the space.

Small shops and offices at or near ground level also tend to have an open plan layout thereby allowing the exit to be easily sighted to permit safe and speedy egress where the space is located in close proximity to the external ground surface such as a road or open space.

The concession is applicable to a number of cases such as to any Class 5 and 6 parts of a building located in a storey at the level of access to a road or open space even though the storey may be served by more than one exit, subject to that part otherwise complying with **D1.4(c)(ii)**.

The concession is also available for Class 5 or 6 parts of a building containing other classifications (refer to **A1.7(a)**).

The conditional reference in **D1.4(c)** to sub-clauses **(d)**, **(e)** and **(f)** refers to special provisions for particular types of building.

Patient care areas—D1.4(d)

Patient care areas in Class 9a buildings can present particular problems in case of emergency egress. Such areas are likely to be occupied by people who are either fully or partly non-ambulatory, and in many cases confused or incapacitated by drugs and medical and post-operative conditions.

Accordingly, the allowable distance of travel to an exit in the patient care areas of a Class 9a building is less than for Class 5–8 buildings, non-patient care areas of Class 9a buildings, and Class 9b buildings.

D1.4(d) should be read in conjunction with **C2.5**.

Figure D1.4(1)

DISTANCES TO EXITS IN CLASS 2 AND CLASS 3 BUILDINGS

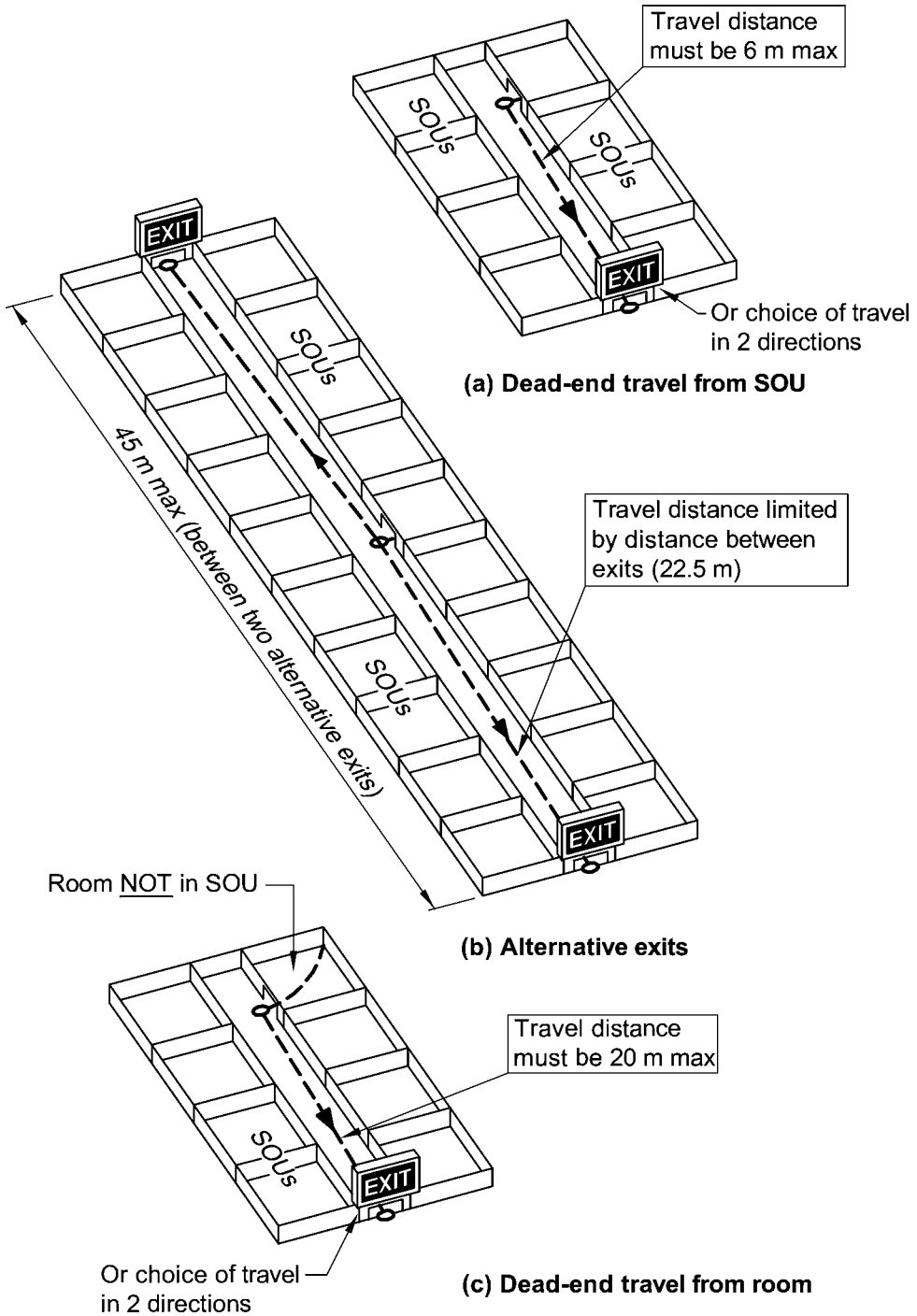
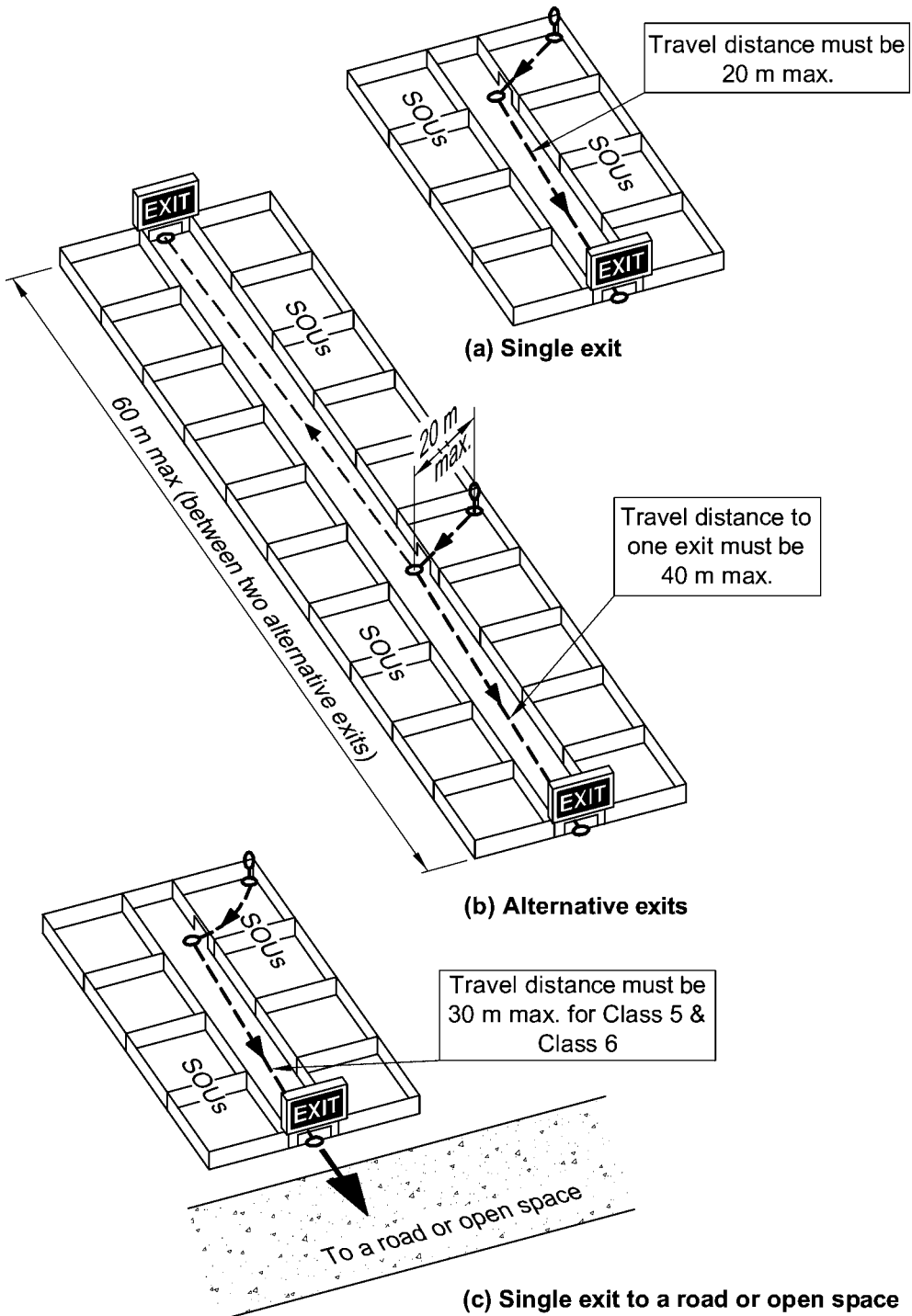

Figure D1.4(2)

DISTANCES TO EXITS IN CLASS 5 TO CLASS 9 BUILDINGS



Open spectator stands—D1.4(e)

The construction of an open spectator stand is such that the build up of smoke is unlikely. Greater distances of travel to an exit are therefore permitted.

Assembly buildings—D1.4(f)

The concession available for assembly buildings is based on a specific level of fire and smoke separation being provided between the area being evacuated and the circulation space passed through to reach an exit.

To obtain the concession, **D1.4(f)(iii)** limits the distance of travel through the room being evacuated and across the circulation space outside that room to the exit.

D1.5 Distance between alternative exits**Intent**

To require that if an exit is inaccessible, access to any required alternative exit must be available within a reasonable distance.

Why is this matter regulated?

Where a building requires multiple exits, the exits maximise the choices of a person evacuating, in case one exit becomes blocked.

Uniform distribution of exits—D1.5(a)

D1.5(a) requires that where multiple exits exist, they must be distributed as uniformly as practicable to improve the level of safety when evacuating.

Minimum and maximum distances are set

D1.5 specifies the minimum and maximum permitted distances between alternative exits (for example, two exits may be located next to one another, so long as they are not each other's alternative in an emergency). Where scissor stairs are used, the shafts will be adjacent and separated by fire-resisting construction. However, the access doors to the alternative scissor stairs must comply with the minimum separation distance.

Minimum distance—D1.5(b)

The minimum distance minimises the risk of fire spreading to block the alternative exit.

Maximum distance—D1.5(c)

The maximum distance between alternative exits minimises the need to travel too far to reach an exit.

Convergence distance—D1.5(d)

If alternative paths of travel converge too closely, both paths can be blocked by the same fire. The minimum distance between the paths of travel aims to negate this.

The minimum convergence distance only comes into operation when the paths of travel have already diverged to that distance. The paths can commence more closely together than the distance specified.

Method of measurement

The travel distances specified in **D1.5** are measured in accordance with **D1.5**.

Figure D1.5(1) illustrates the method of measuring the maximum and minimum distances between exits.

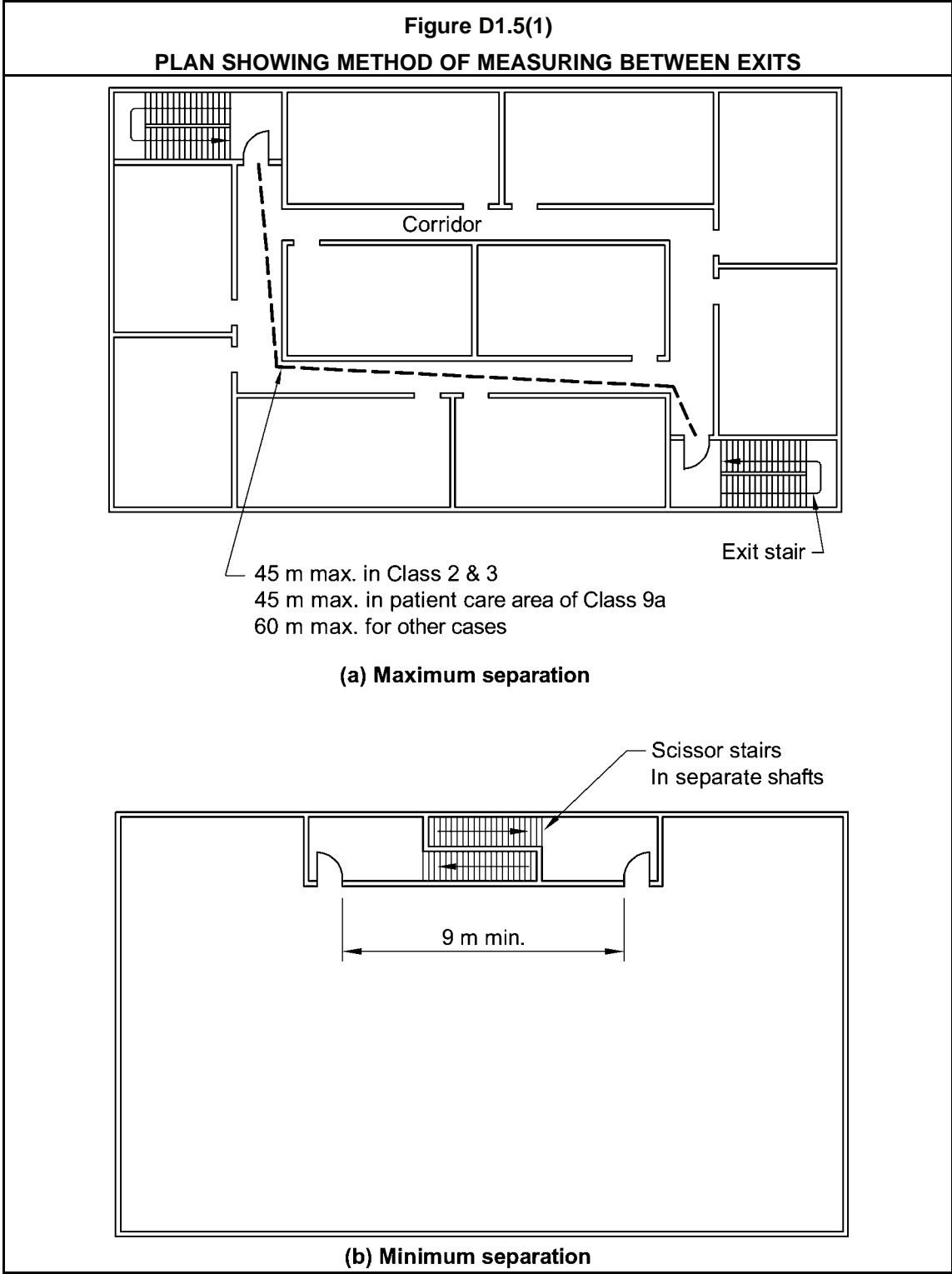
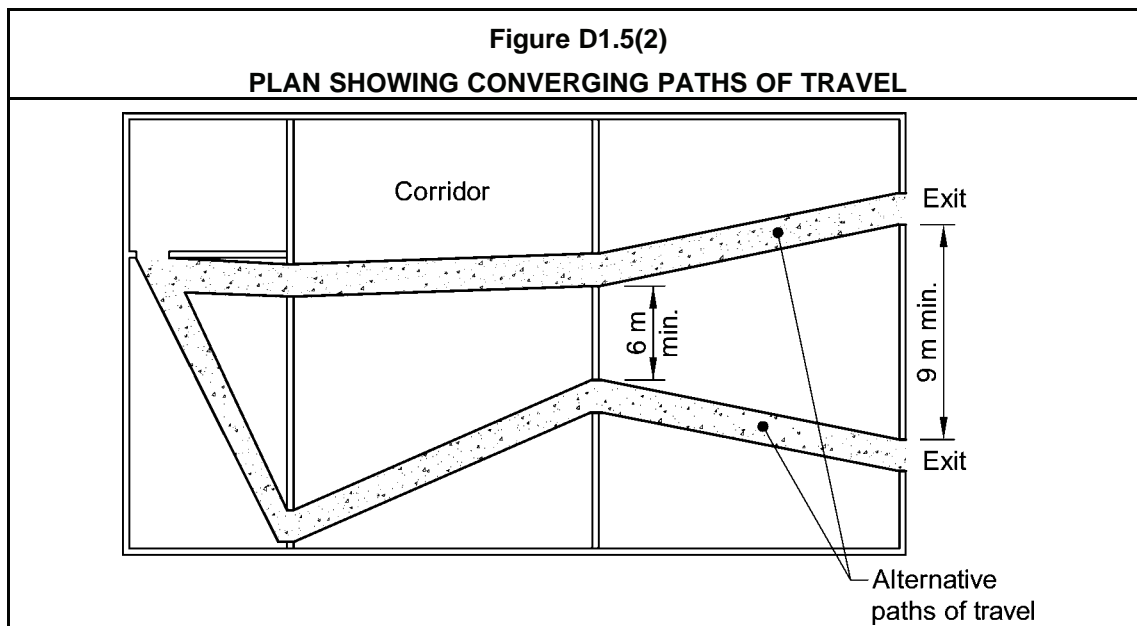

Figure D1.5(2) illustrates the convergence prohibition on alternative paths of travel.



D1.6 Dimensions of exits and paths of travel to exits

Intent

To require exits and paths of travel to an exit to have dimensions to allow all occupants to evacuate within a reasonable time.

Height of exits and paths of travel—D1.6(a)

The **D1.6(a)** requirement for a minimum height of two metres is considered to be a reasonable minimum for most people to safely walk through to gain egress.

The reduction to a minimum of 1980 mm for doorways is to allow for a standard door frame.

Exit and path of travel widths

Width required to allow safe exit

The required exit and path of travel widths have been determined on the basis of an estimate of the width required to allow the safe exit of a given number of people expected in particular buildings.

Minimum unobstructed width

Exit and path of travel width—D1.6(b)

D1.6(b) clarifies that the unobstructed width of any exit or path of travel to an exit is to not be less than the dimensions prescribed. These may then be added to achieve the aggregate width that is required.

D1.6(b)(iii) applies to Class 9c aged care buildings. The additional width at doorways is to allow for greater manoeuvrability of beds, mobile baths, wheelchairs, walking frames and other equipment throughout the resident use areas.

Figure D1.6(1) illustrates two examples of how compliance with the corridor width provisions in a Class 9c aged care building may be achieved.

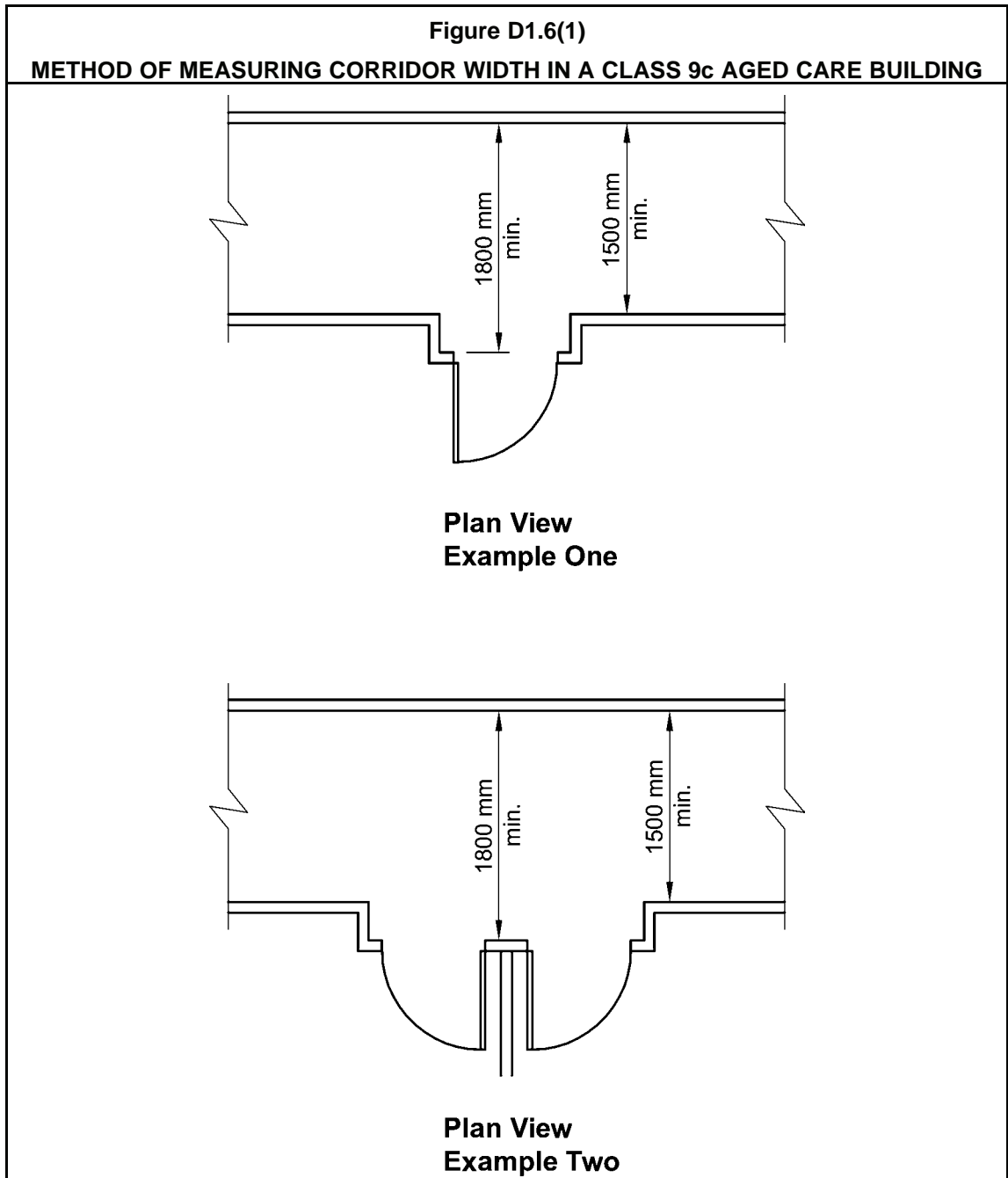

Storeys accommodating up to 200 people—D1.6(c)

Buildings, other than ward and treatment areas of a Class 9a building, accommodating up to 200 people (see **D1.6(b)** and **(c)**) require minimum widths of:

- 1 metre for 0 to 100 people;

- 1.25 metres for 101 to 125 people;
- 1.5 metres for 126 to 150 people;
- 1.75 metres for 151 to 175 people; and
- 2 metres for 176 to 200 people.

See Figure D1.6(2)

Storeys accommodating more than 200 people—D1.6(d)

Above 200 people (see **D1.6(d)**), there is a division between those buildings which have a change of floor level by way of stairways or ramps with a gradient greater than 1 in 12, and those which do not have such a change in floor level. The reason for this differentiation is that the change in floor level has the potential to create problems at exits, which could cause injuries and delays. The difference can be outlined as follows, and is illustrated in **Figure D1.6(2)**:

- Change in floor level by stairway or ramp greater than 1:12—**D1.6(d)(i)**
 - 2.5 metres for 201 to 260 people;
 - 3 metres for 261 to 320 people;
 - 3.5 metres for 321 to 380 people;
 - and so on.
- Every other case—**D1.6(d)(ii)**
 - 2.5 metres for 201 to 275 people;
 - 3 metres for 276 to 350 people;
 - 3.5 metres for 351 to 425 people;
 - and so on.

Aggregate width of exit or path of travel—D1.6(c), (d) and (e)

D1.6(c), (d) and (e) refer to the required width of an exit or path of travel to an exit in terms of an “aggregate unobstructed width”. The exit or path may be less than the total required width (although each must achieve the minimum required width), but when the width of each exit or path is added together, the specified aggregate unobstructed width must be achieved.

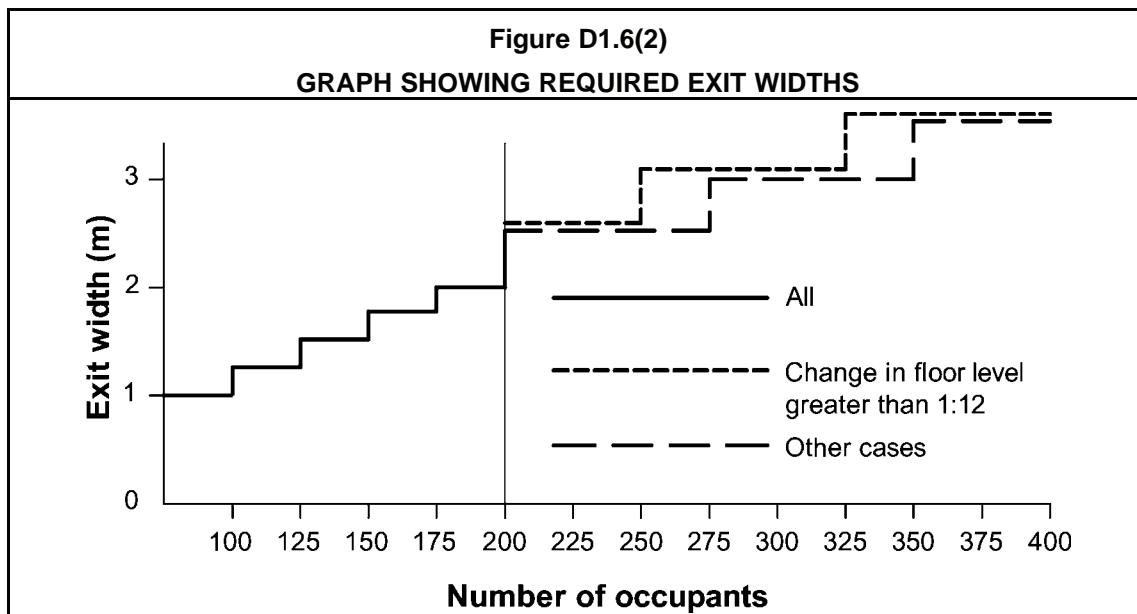

Doorway widths—D1.6(f)

The width of a doorway must be clear of all obstructions. This includes door handles or other attachments or any part of the door leaf and any part of the door frame, including the door stop.

Patient care areas—D1.6(f)(i) and (ii)

D1.6(f)(i) and **(ii)** provide additional width for doorways in patient care areas to allow for the turning circle of beds, and other egress difficulties, such as those experienced by patients who require ambulatory assistance.

Width of a doorway—D1.6(f)(iii)

The width of a doorway comprising part of the exit or path of travel is permitted to be 250 mm less than the width of each exit. This allows for the installation of a standard door frame.

In the case of an exit comprising multiple doorways, this concession may be applied to each individual doorway.

Figure D1.6(3) shows alternative examples of the exit door width for a building requiring a total exit width of three metres.

Aged care buildings—D1.6(f)(iv)

D1.6(f)(iv) applies to Class 9c aged care buildings. The additional width of doorways is to allow for greater manoeuvrability of beds, mobile baths, wheelchairs, walking frames and other equipment throughout resident use areas.

Minimum permitted width of a doorway—D1.6(f)(v)

No doorway should be less than 750 mm in width, except doorways which open into toilets and bathrooms. However, minimum width requirements do apply to doorways which provide access to facilities required for people with disabilities (see **D3.2** and **F2.4**).

Exceptions to the exit and path of travel width

Treatment areas, ward areas—D1.6(b)(ii) and (c)(ii)

D1.6(b)(ii) and **(c)(ii)** specify additional width requirements for the exit and path of travel to allow for the turning circle of beds.

Open spectator stand—D1.6(e)

D1.6(e) provides an exception for large open spectator stands to the exit and path of travel width required for other buildings.

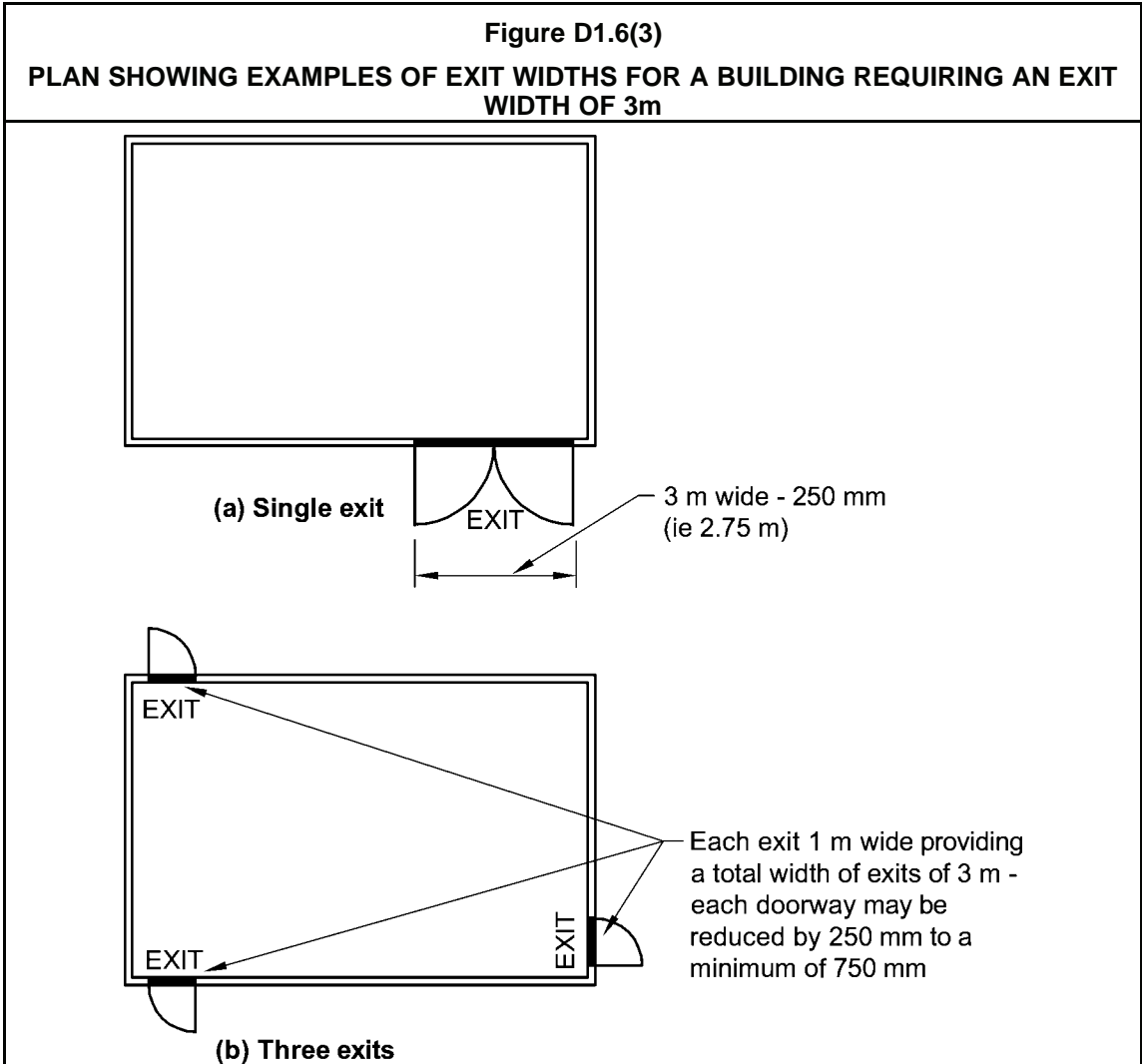

Exit or path of travel width must not be reduced—D1.6(g)

Under **D1.6(g)**, the required unobstructed width of exit or path of travel must not be reduced in the direction of egress. This provision aims to avoid congestion in an exit or a path of travel to an exit.

Example

A restaurant is located on the fifth floor of a building.

The restaurant may seat 250 people. This would require an aggregate exit width of 2.5 metres. One stairway, 2.5 metres in width, is provided to achieve the exit requirement.

The fourth floor of the same building may be used as an office, with 100 staff, requiring an aggregate exit width of only 1 metre.

The 2.5 metre wide stairway from the fifth floor cannot be reduced to 1 metre when it reaches the fourth floor. The stairway must retain its 2.5 metre width throughout its length.

The exit width is not required to increase to 3.5 metres below the 4th floor. The BCA makes the assumption that the occupants of both floors are unlikely to all be exiting through the same part of the stairway at the same time.

If the restaurant was below the office, the stairway could begin at 1 metre in width at the office, but would have to increase to 2.5 metres after it passed the restaurant.

Method of measurement of required width and height of stairways and ramps

Under **D1.6(h)(i)**, the required stairway width must be measured clear of obstructions, including handrails and projecting balustrades.

Example

A stairway has handrails along both sides and they are located within the width of the stairway (as opposed to along the top of a banister along the edge of the stairway).

In this case, the required stairway width must be measured between the handrails (presuming that there are no other obstructions intruding into the stairway).

Under **D1.6(h)(ii)**, the required width of a stairway must continue to a height of 2 metres above the stair. This measurement is consistent with other similar BCA requirements.

Figure D1.6(4) illustrates compliance with **D1.6(h)**.

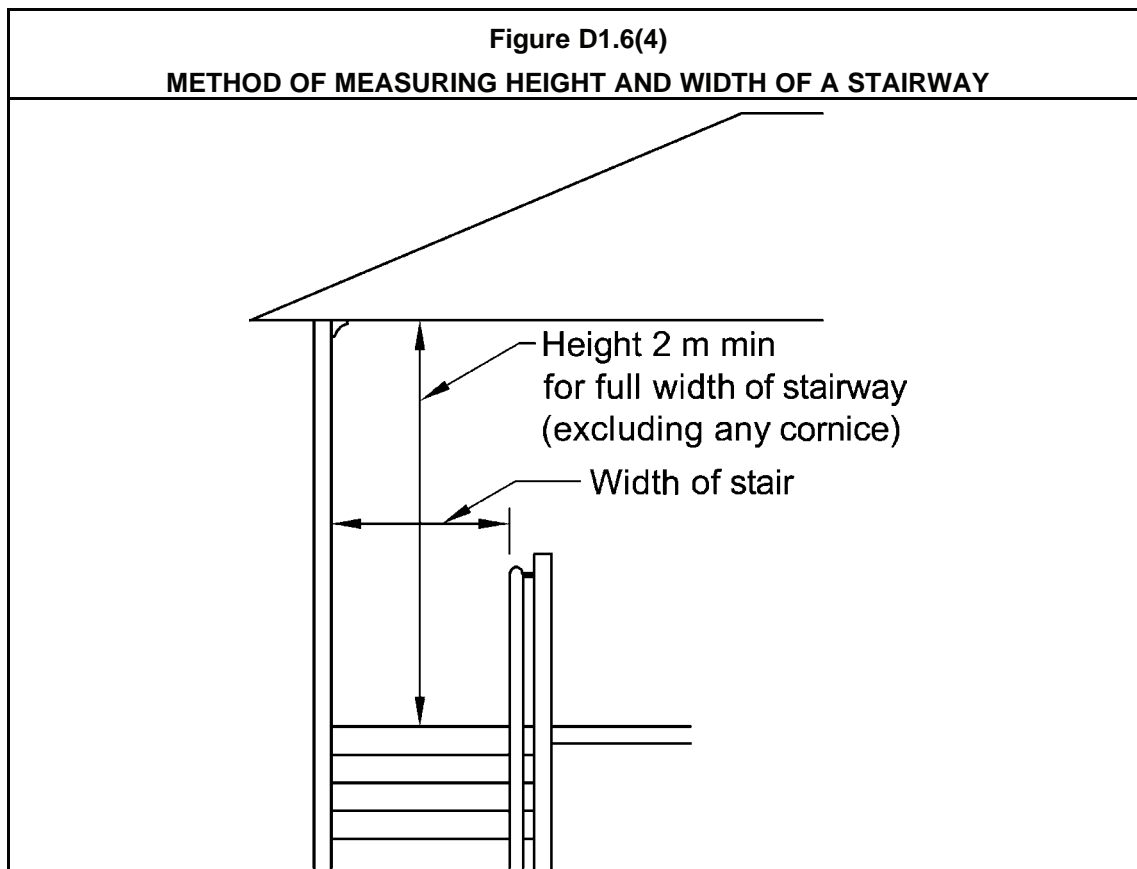

D1.7 Travel via fire-isolated exits

Intent

To enable occupants to safely enter a fire-isolated exit which discharges to a safe location.

Access to fire-isolated exits—D1.7(a)

D1.7(a) requires that a doorway must not open into a fire-isolated exit unless it opens from a public area, a sole-occupancy unit which occupies a whole floor, or a toilet. This is to limit the number of entry points into a fire-isolated exit to retain its fire-resisting performance.

Note that **D1.7(a)(i)** refers to a “public corridor, public lobby, or the like”. A smoke lobby which serves at least two sole-occupancy units is a “public lobby”, and can open directly into a fire-isolated exit. **Figure D1.7(1)** illustrates permitted and prohibited entry into a fire-isolated passageway from sole-occupancy units in a shopping centre.

Discharge to areas not roads and open spaces—D1.7(b)

D1.7(b)(i) requires fire-isolated exits to discharge to roads or open spaces. However, there are some exemptions:

- **D1.7(b)(ii)** sets out the requirements for a fire-isolated exit to discharge into an area within a building (including the requirement that it be open for at least two thirds of its perimeter, to aid smoke ventilation); and

- **D1.7(b)(iii)** sets out the requirements for a fire-isolated exit to discharge into a covered area outside the building (including the requirement that it be open for at least one third of its perimeter, to aid smoke ventilation).

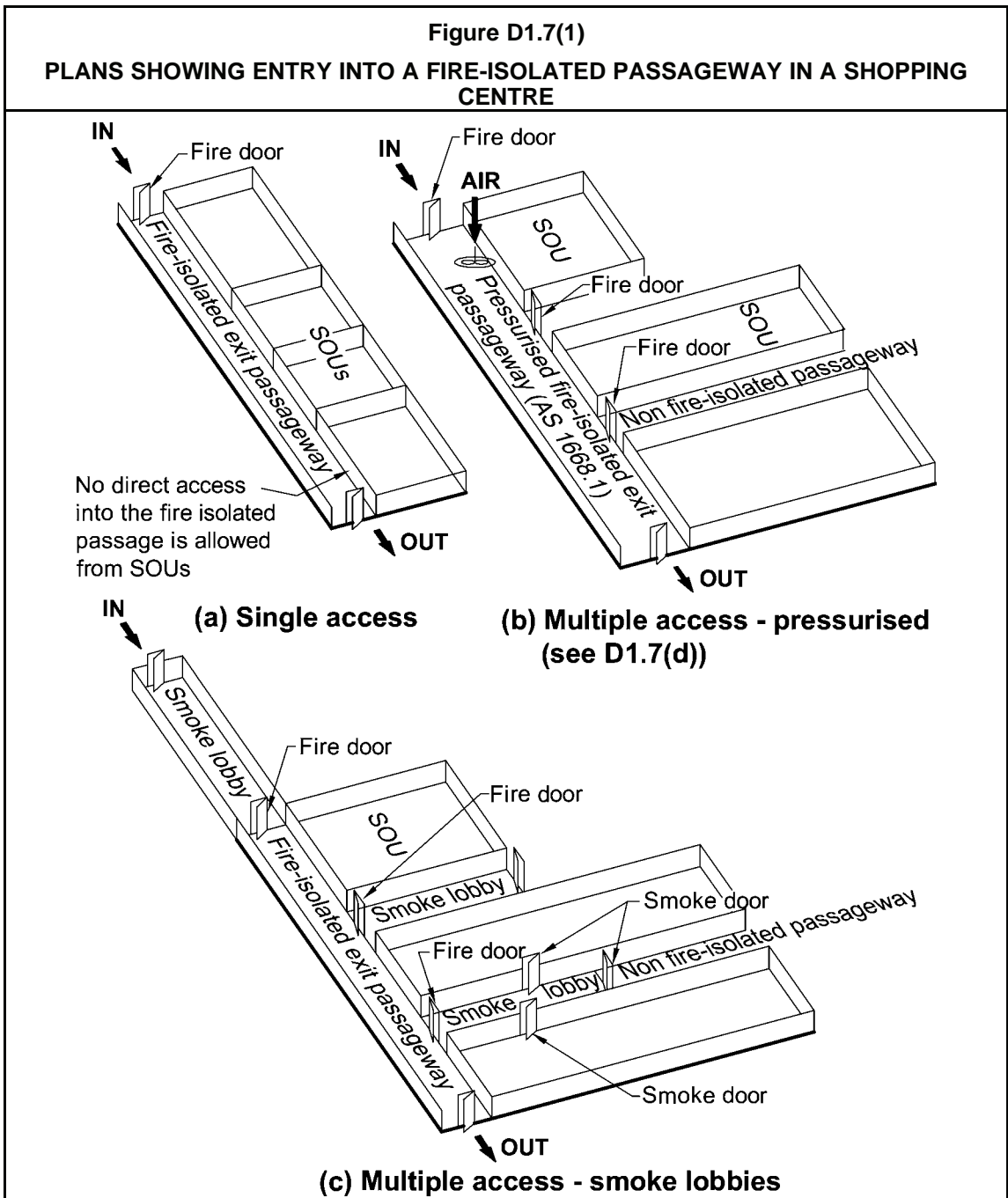

Figures D1.7(2) and (3) illustrate some of the options available by the use of D1.7.

Figure D1.7(2)

EXAMPLE OF DISCHARGE OF FIRE-ISOLATED STAIR COMPLYING WITH D1.7(b)(ii)

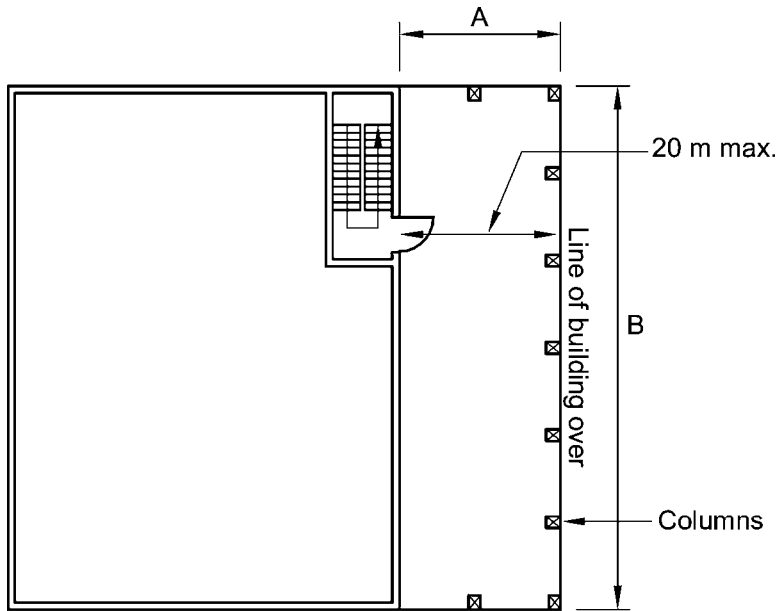

Sum of openings $W = 2A + B$ - aggregate width of columns
 This must be at least $\frac{2}{3}$ of perimeter.
 ie $\frac{2}{3}$ of $(2A + 2B - \text{aggregate width of columns})$

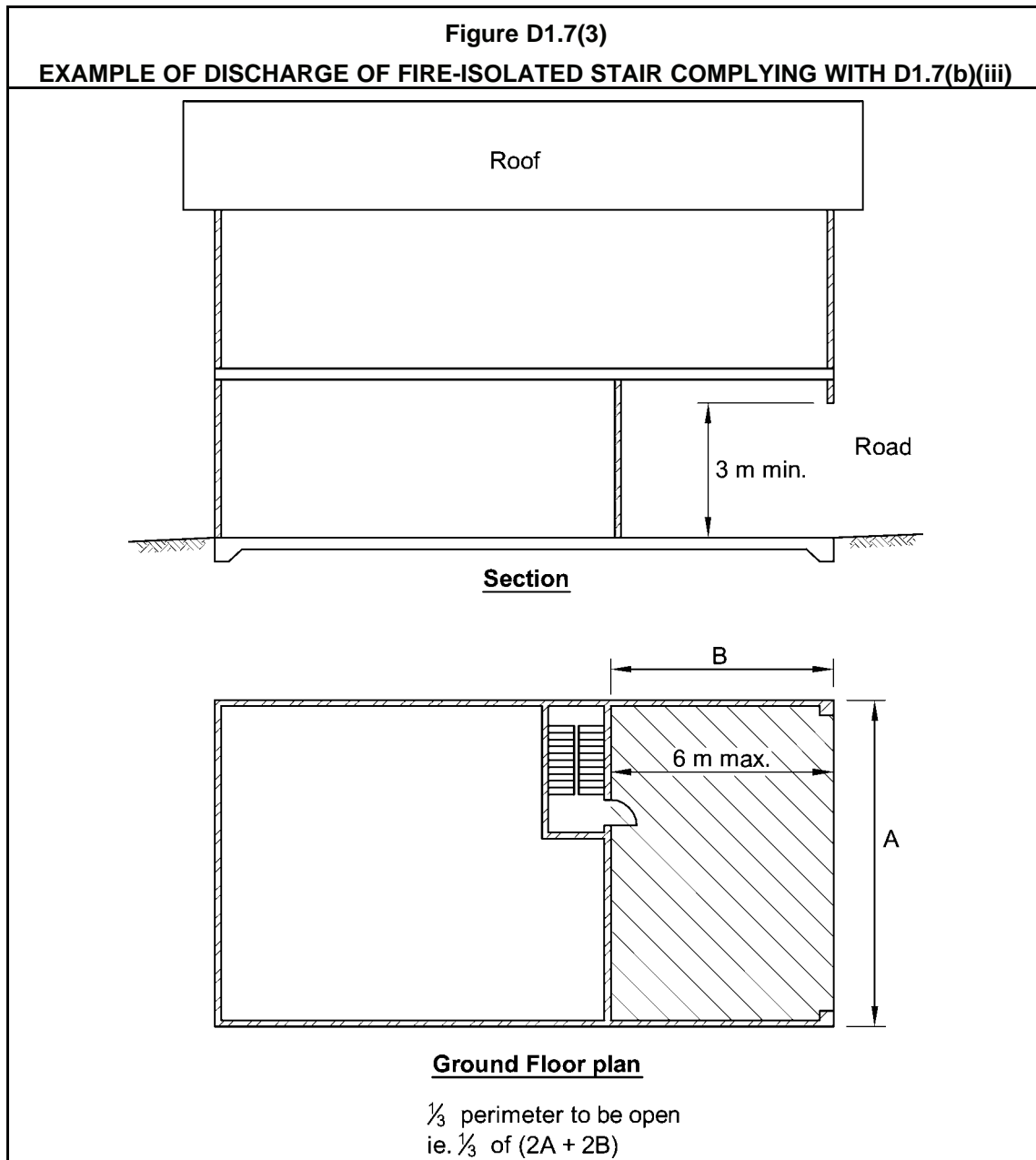

Travel within 6 metres of an external wall—D1.7(c)

D1.7(c) sets out the FRL and opening protection requirements where the path of travel from the point of discharge of a fire-isolated exit to a road or open space necessitates passes within six metres of any part of the external wall of the building being evacuated. The provision only applies at the level of discharge. So if the exit discharges at ground level, any first storey wall or window would not need protection. The reason is that a fire on the first floor is unlikely to affect people exiting one storey below.

Figure D1.7(4) illustrates when walls and window openings require protection in accordance with **D1.7(c)**.

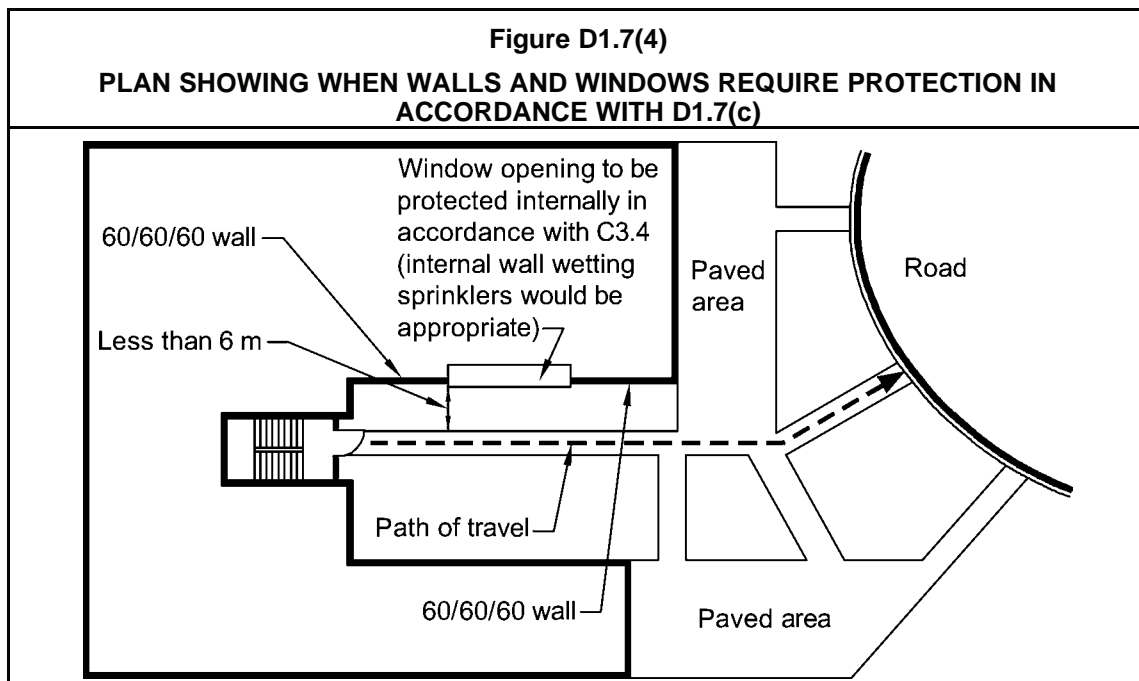

Smoke lobby or pressurised system—D1.7(d)

D1.7(d) requires the use of a smoke lobby or a pressurisation system to stop the entry of smoke into the fire-isolated exit, if more than two access doorways described in **D1.7(a)(i)** or **(ii)** are provided in the same storey. This provision must be read in conjunction with **D1.7(a)**, it does not over-ride it. See **Figure D1.7(1)**

Ramps in Class 9 buildings—D1.7(e)

D1.7(e) requires a ramp where there is any change in level in a fire-isolated passageway in a Class 9 building and that change is less than 600 mm.

D1.8 External stairways or ramps in lieu of fire-isolated exits

Intent

To detail the circumstances in which an external stairway or ramp can be provided instead of a fire-isolated stairway or fire-isolated ramp.

Alternative to required fire-isolated stairways or ramps

Compliance with **D1.8** for external stairway or ramp is only required where the external stairway or ramp is proposed as an alternative to a required fire-isolated stairway or ramp. In other words, if a fire-isolated stairway or ramp is not required by the BCA, compliance is not required with **D1.8**.

External stairways and ramps permitted to 25 metres

The use of an external stairway or ramp is permitted instead of a fire-isolated stairway or ramp up to a height of 25 metres. The reason external stairways or ramps are not permitted above this height is because of:

- the risk that people would suffer vertigo above this level;
- the risk that weather conditions, particularly wind, may become more severe above this height; and
- the need to enable any person who gets into difficulties on the stairway to be rescued by way of fire brigade ladders or other rescue equipment, which generally do not reach above this height.

Fire protection required

Fire protection from the external wall of the building near the external exit and any openings in that wall, is required under **D1.8(a)** and **(b)** to ensure that an average person using the exit is afforded adequate protection from flames and radiant heat from a fire within the building.

D1.8(c) provides two separate methods of protecting the external exit from a fire from within the building:

- protect the external wall of the building and any openings in the wall, within the prescribed distances to the exit (see **Figure D1.8(1)**); or
- protect the exit by shielding construction where the exit is within the prescribed distances to the building (see **Figure D1.8(2)**).

**Figure D1.8(1)
PROTECTION OF THE EXTERNAL EXIT USING THE EXTERNAL WALL OF THE
BUILDING IN ACCORDANCE WITH D1.8(c)(i)**

The exit incorporates part of the external balcony as the communal thoroughfare for occupants exiting via the external stair and is therefore considered part of the external exit

 External exit

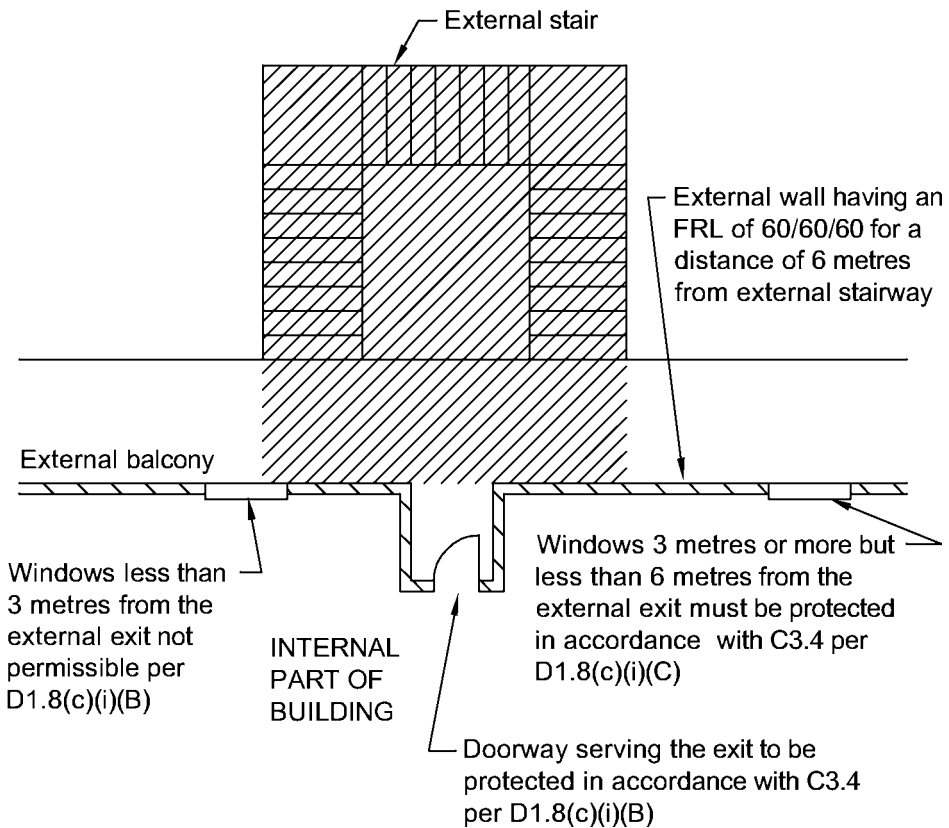

D1.8(d) provides requirements for the shielding construction and protection of any openings in that construction.

Figure D1.8(2)

PROTECTION OF THE EXTERNAL EXIT USING SHIELDING CONSTRUCTION IN ACCORDANCE WITH D1.8(c)(ii)

The external exit is considered to be any part of the stair that would be used by any occupant travelling down the stair. The perpendicular extension from the main balcony would be only used by the occupants of that level and is no different to the requirements of main external balcony

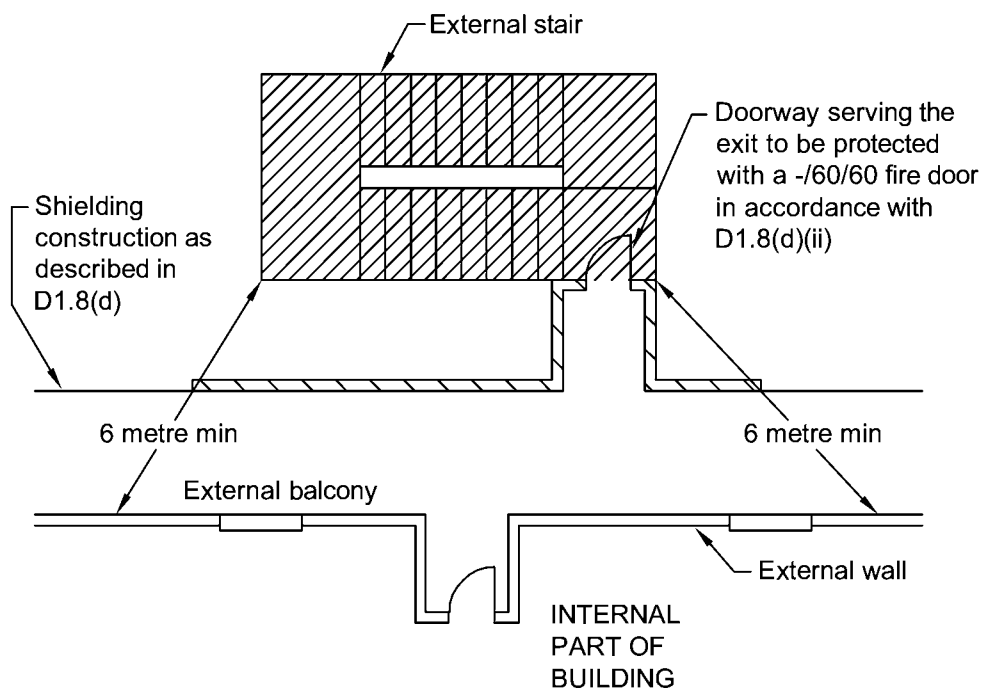

D1.9 Travel by non-fire-isolated stairways or ramps

Intent

To require that a person using a non-fire-isolated stairway or ramp be provided with a safe evacuation path.

Continuous means of travel—D1.9(a)

D1.9(a) requires that occupants in a required non-fire-isolated stairway or ramp are able to continue all the way down to the level from which egress to a road or open space is available.

D1.9(a) refers to a continuous means of travel comprising flights of stairs and landings. It would generally not be acceptable for an entire or substantial proportion of a storey to be called a “landing”.

The first diagram in **Figure D1.9(1)** illustrates non-compliance with **D1.9(a)** because the stair does not provide a continuous path of travel to the level providing egress to a road or open space. The second diagram in **Figure D1.9(1)** illustrates a method of compliance with **D1.9(a)**.

Required stairways and ramps

The distances specified in **D1.9** apply only to a required non-fire-isolated stairway or ramp.

Figure D1.9(2) illustrates the method of measuring a travel distance down a stairway.

Distances for non-fire-isolated stairways—D1.9(b) and (c)

D1.9(b) and **(c)** provide requirements for the overall travel distances permitted on non-fire-isolated stairways. **Figure D1.9(3)** illustrates compliance with **D1.9(b)** and **(c)**.

Distance from stairway to discharge point—D1.9(d) and (e)

D1.9(d) and **(e)** provide requirements for the travel distance permitted from the base of the non-fire-isolated stairway to the discharge point (note that this distance is part of the distances required under **D1.9(b)** and **(c)**). **Figure D1.9(4)** illustrates compliance with **D1.9(d)** and **(e)**.

Class 2 or Class 3 requiring 2 or more exits—D1.9(f)

D1.9(f) provides the additional requirements for Class 2 and Class 3 buildings which are required to have 2 or more exits.

Figure D1.9(5)

Figure D1.9(5) illustrates one method of an exit system in a Class 5–9 building complying with **Section D**.

Figure D1.9(1)
SECTION SHOWING COMPLIANCE WITH D1.9(a)

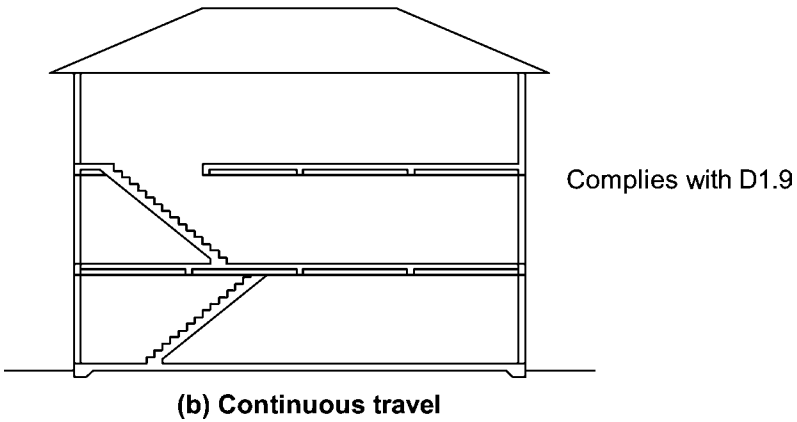
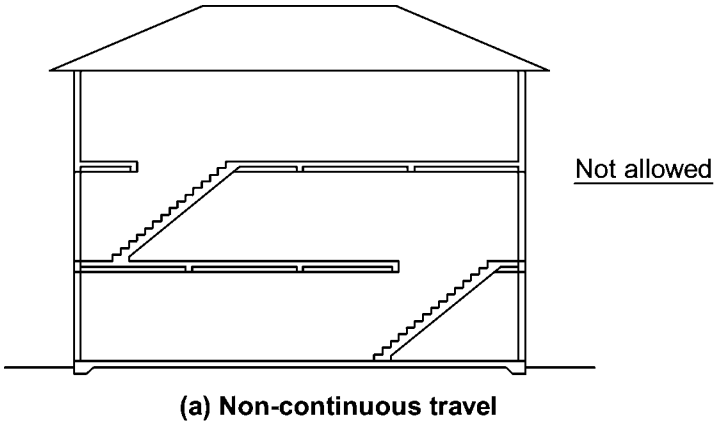

Figure D1.9(2)
METHOD OF MEASURING TRAVEL DISTANCE DOWN A STAIRWAY

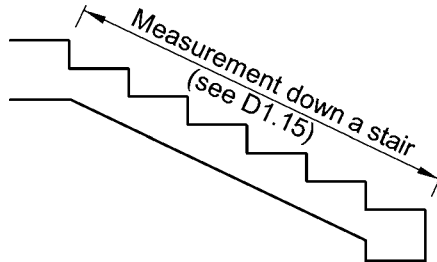

Figure D1.9(3)

METHOD OF MEASURING OVERALL DISTANCE OF TRAVEL VIA NON-FIRE-ISOLATED STAIRWAYS

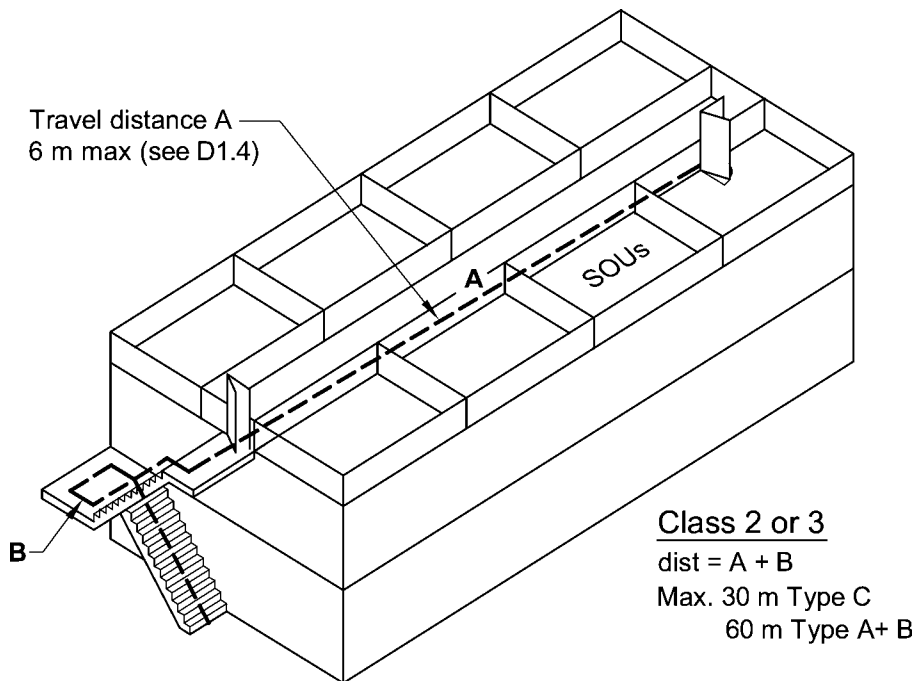
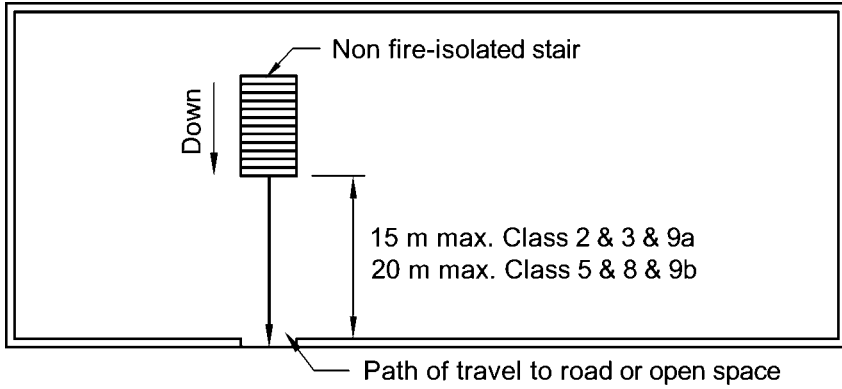
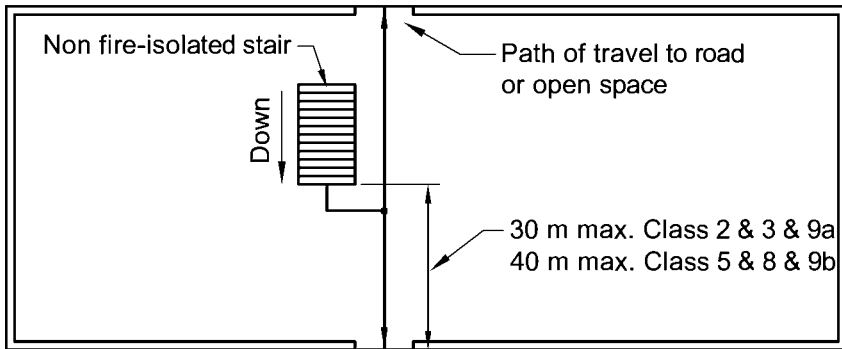

Figure D1.9(4)

PLANS SHOWING COMPLIANCE WITH D1.9(d) AND (e) FOR THE DISCHARGE OF NON-FIRE-ISOLATED STAIRWAYS



(a) Single point of egress



(b) Alternative points of egress

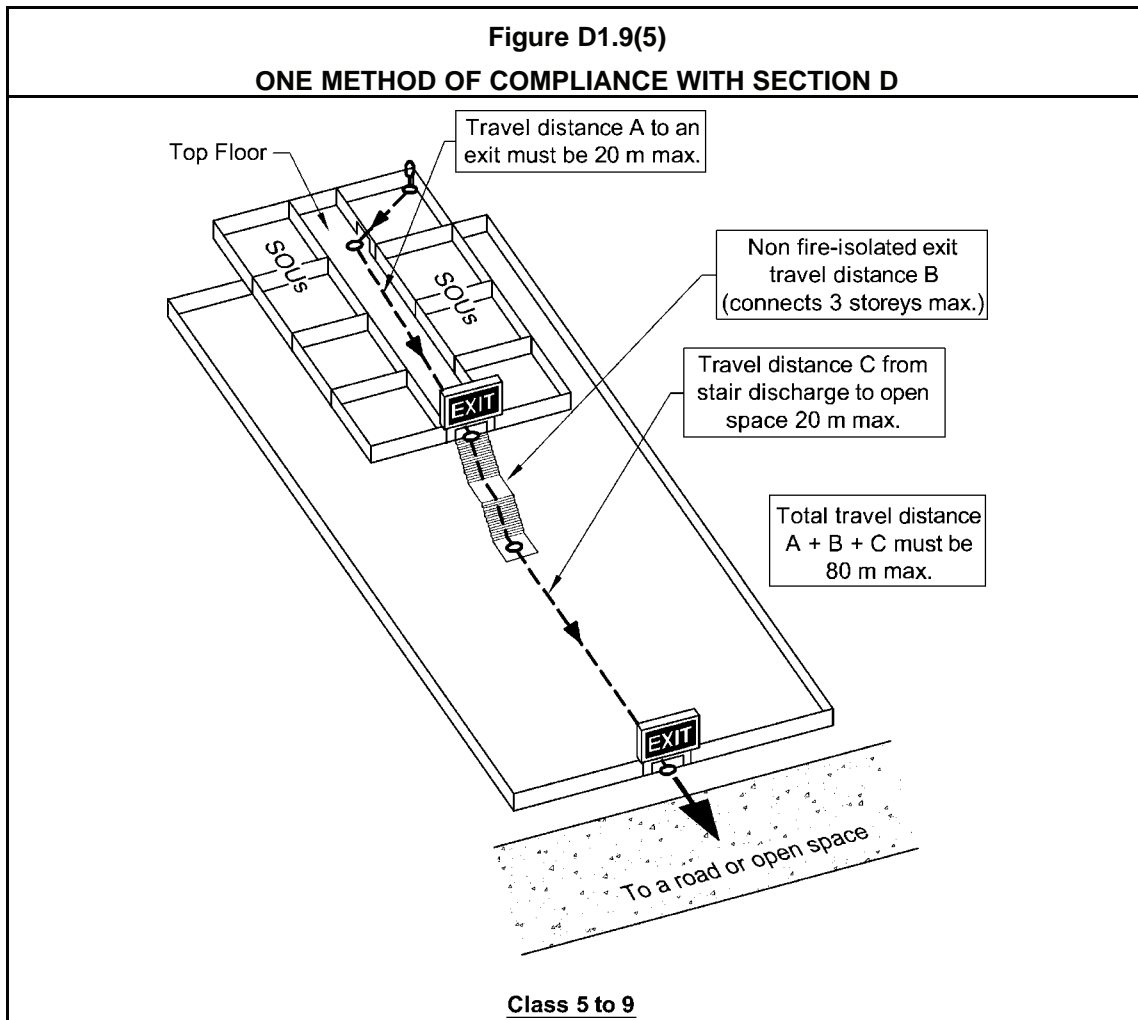

D1.10 Discharge from exits

Intent

To require the safe discharge from an exit to a road or open space.

Egress not to be blocked—D1.10(a)

D1.10(a) requires that an exit must not be blocked at the point of discharge.

Barriers (such as bollards) must be installed, if they are necessary to prevent vehicles blocking access to, or discharge from, an exit.

Link between open space and a road—D1.10(b) and (c)

If an exit discharges to an open space, D1.10(b) and (c) require that a safe means of travel be provided from the open space to a road. This means that the following criteria must be satisfied:

- **D1.10(b)**—to maximise the safety of people moving towards a road during an evacuation, the width of the path of travel from the open space to the road must be at least that required for the exit (and in no case less than one metre).
- **D1.10(c)**—to minimise the risk from falling or tripping, any stairways or ramps must comply with the rest of the BCA (eg construction of treads, landings etc). This may include the provision of ramps suitable for people with disabilities.

The link between the road and open space must be open to the sky for its length.

Discharge points to be well separated—D1.10(d)

D1.10(d) requires that the discharge points of alternative exits be as far apart as possible, so that if the discharge from one of them is blocked, the other will still operate satisfactorily.

Open spectator stand—D1.10(e)

D1.10(e) requires that exits from an open spectator stand not discharge to the ground in front of the stand. There may be a large number of people viewing the event from the front of the stand, and they may obstruct the path of those evacuating.

There is also a risk that the front of the stand could be subject to severe heat radiation. Also the only egress to the road from the ground in front of the stand may be through the stand.

Auditorium—D1.10(f)

Under **D1.10(f)**, only two thirds of the required width of exits from an auditorium, such as a theatre or hall, are to discharge into an entrance foyer where the auditorium can accommodate more than 500 people. This restriction applies because there may be a large number of people in the foyer, possibly waiting for the next show, or to gain access to another auditorium. These people would obstruct the path of the people evacuating.

D1.11 Horizontal exits

Intent

To detail how the installation of horizontal exits in a building is permitted as an alternative to a conventional exit.

Difficult evacuations

Originally, provision was made for horizontal exits between fire compartments because some occupants can have difficulty evacuating, particularly those confined to bed or have a disability.

Subsequently, it was accepted that horizontal exits would be of value in other buildings, where they could overcome problems associated with large fire compartments, eg excessive distances to travel to exits.

Purpose of horizontal exits

The use of horizontal exits can overcome some of the difficulties outlined above, although they need to be used in conjunction with some other form of exit.

In an emergency, the Deemed-to-Satisfy Provisions require that occupants travel for limited distances before they reach a place of safety. A “place of safety”, in the case of horizontal exits, means the connecting fire compartment to which people will flee.

For a horizontal exit to comply with the Deemed-to-Satisfy Provisions of **Section D**, it must meet the following criteria:

- The distance of travel to the exit must not exceed that specified elsewhere in the BCA.
- The protection for a place of safety from its adjoining fire compartment is provided by a fire wall. The fire wall has a fire rating to match the classification of the fire compartments it divides and is expected to withstand a burnout of the respective areas. This provides an appropriate level of safety to people using the horizontal exit as they may have to remain in the place of safety for an extended period before evacuating via other exits.
- There must be another exit (other than a horizontal exit) from each place of safety entered by way of a horizontal exit. After escaping to the place of safety it should not be necessary to return to the area being evacuated to continue to evacuate from the building. **D1.11(c)** specifies a limit for the number of horizontal exits in a storey for buildings of other than Class 9a and Class 9c buildings.
- The place of safety must be large enough to temporarily accommodate the people from the area the horizontal exit is being provided for. It is important to note that if there is only one other exit in the fire compartment then the place of safety is to be large enough to accommodate all the occupants of the fire compartment. This is necessary because if the other exit is blocked then all the occupants will be required to exit through the horizontal exit. This is necessary until vertical evacuation is available. Since this accommodation is only for a short period, the areas specified generally only allow for people to stand. However, the larger areas specified for Class 9a health-care buildings and Class 9c aged care buildings allows for patients or residents on beds to be wheeled through the horizontal exit to be accommodated in the place of safety.
- The path to the place of safety is to have dimensions equal to those of the horizontal exit to assist with the smooth evacuation of occupants.
- The swing of the horizontal exit door must be the same as other exit doors. This means that if the area is more than 200 m² (as specified in **D2.20(b)**), the door is to swing in the direction of egress. If the FRL of the fire wall is three or four hours, two fire doors may be provided to achieve this FRL. In such cases, for both doors to swing in the one direction, a vestibule must be formed, as shown in **Figure D1.11**.
- To make sure that evacuation is always possible, it is not permitted to have a horizontal exit to a separate sole-occupancy unit. This is because the owner or occupier of the other unit may lock the door for security reasons, barring entry (or exit) in an emergency.
- Where egress is required in either direction, two doors swinging in opposite directions or a 180° swinging door (complying with all BCA requirements including fire and smoke sealing capacities) may be used.

Other uses of horizontal exits

Horizontal exits may be useful as a means of evacuation from many health-care buildings. They can also be an advantage in large floor area buildings which need to be sub-divided by fire walls to reduce the size of the fire compartments. These fire walls can then be penetrated to create horizontal exits.

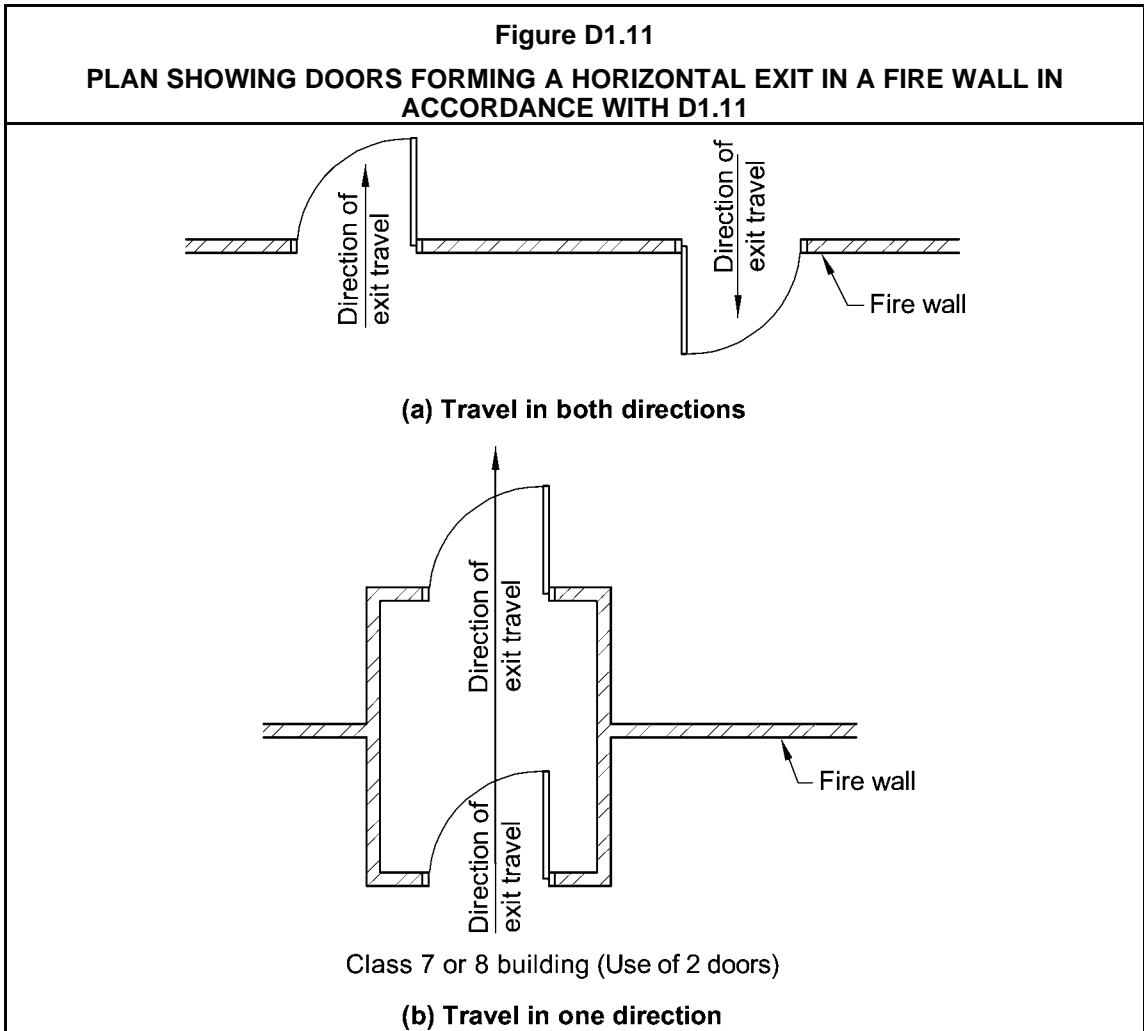

D1.12 Non-required stairways, ramps or escalators

Intent

To limit the spread of fire and smoke through unprotected openings for stairways, ramps, escalators and moving walkways.

Application

D1.12 only applies to:

- escalators;
- moving walkways and travelators;
- non-required non-fire-isolated stairways; and
- non-required non-fire-isolated ramps.

What is a non-required non-fire-isolated stairway or ramp?

Builders etc may choose to interconnect two or three storeys of a building with a non-required stairway, ramp or the like in accordance with **D1.12**.

Example

A two storey shop or suite of offices may be within a multi-storey building where all storeys are connected by a stairway which is both required and fire-isolated. This stairway may be external to the sole-occupancy unit which comprises the shop or office suite. For easy access within the sole-occupancy unit, another stairway may be located within the shop or office suite interconnecting the two storeys. That stairway is additional to the required stairway, and is not required to be fire-isolated.

Patient care and resident use area—**D1.12(a)**

D1.12(a) prohibits the use of a non-required non-fire-isolated stairway or ramp in a patient care area of a Class 9a building and a resident use area of a Class 9c aged care building. The prohibition is because of the difficulties in evacuating bed-ridden, or otherwise mobility-impaired occupants. This prohibition applies to **D1.12(d)**, despite that provision's general reference to Class 9 buildings.

D1.12(b) allows any number of storeys to be connected in certain buildings as follows:

- The open nature of the construction of an open spectator stand, sports stadium, carpark, atrium, and a stairway or ramp located outside a building is such that the build-up of smoke is unlikely. **D1.12(b)(i)**, **(ii)** and **(iii)** permit any number of interconnected floors in such cases.
- In a Class 5 or Class 6 building containing a sprinkler system, **D1.12(b)(iv)** allows connection of any number of storeys if the interconnecting stairway, ramp, or escalator and the like complies with **Specification D1.12**.

Atriums and Part G3—**D1.12(b)(ii)**

- While **D1.12(b)(ii)** refers to atriums, there are additional requirements for atriums in Part **G3**.

Number of interconnected storeys is restricted—**D1.12(c)** and **(d)**

D1.12 restricts the number of storeys which can be interconnected by a non-required non-fire-isolated stairway, ramp or the like. This recognises that an unprotected opening for a stairway, ramp, escalator or the like can lead to the spread of fire or smoke from one floor to another.

The restriction applies if:

- **D1.12(c)(i)**—a Class 2–9b building (excluding Class 9a) contains a sprinkler system, no more than three consecutive storeys can be linked, one of which storeys must directly egress to a road or open space. This recognises the effectiveness of a sprinkler system in controlling the spread of fire; or
- **D1.12(c)(ii)**—the building is an unsprinklered Class 2 or Class 3 building, two consecutive storeys can be linked, one of which must directly egress to a road or open space. Part **D1** does not generally apply to sole-occupancy units in Class 2 or Class 3 buildings, or Class 4 parts, and there is no restriction on an internal non-required non-fire-isolated stairway, ramp or the like linking two storeys in, for example, a two storey penthouse suite; or
- **D1.12(d)**—in a Class 5 or Class 6 building which does not qualify under **D1.12(b)(iv)**, and in Class 7–9b buildings (excluding a patient care area in a Class 9a, see **D1.12(a)**), two consecutive storeys can be linked.

Neither storey is required to provide direct egress to a road or open space and there is no requirement for a sprinkler system as part of this provision. As the stairway or ramp is not required by the BCA for emergency evacuation purposes, this provision is in accord with the remainder of the BCA.

D1.13 Number of persons accommodated

Intent

To establish a methodology for calculating Deemed-to-Satisfy building populations which are permissible in the design and checking of applications when more accurate figures are not available.

D1.13 not to be used for non-BCA purposes

D1.13 and **Table D1.13** are used to calculate the anticipated number of people in particular types of building. From these calculations, minimum exit widths and the required number of sanitary and other facilities can be determined.

D1.13 and **Table D1.13** are not intended to restrict the number of occupants using a building, or to enforce any building use or licensing requirements.

Use of Table D1.13

If more accurate information is available on the expected population of a building, it should be used in preference to **Table D1.13**. This information may include:

- **D1.13(b)**—if the building is an assembly building or room, its seating capacity can be used; or
- **D1.13(c)**—where there is limited public access, a statement from the building owner as to the number of occupants who will use the building; or
- **D1.13(c)**—a study of the number of people using similar buildings. Such a study must include the number of people at various times. As an example, if the building is to be used as a shop, the figures must include the maximum numbers of people expected at peak times (such as before Christmas).

Example

It would be appropriate to use an alternative means of assessing the number of occupants when:

- under **D1.13**, a restaurant is deemed to accommodate one person for every square metre of floor area;
- if a specific restaurant has fixed tables, booths, dining alcoves and architectural features which occupy significant floor space, the actual number of patrons able to be accommodated may be much less than the number calculated using **D1.13**; and
- in such a case, it may be appropriate to use another method for calculating the number of people accommodated (such as counting the number of seats available for use by patrons), and hence calculating the total width of exits to be provided; however
- if such an approach is adopted, due allowance must be made for the employees, as well as the potential for alternative seating layouts which could increase the number of people in the restaurant.

The area per person contained in **Table D1.13** for computer rooms applies to rooms housing computer infrastructure such as computer servers and where low occupant numbers occur.

These circumstances are similar to those found in switch or transformer rooms. For computer training rooms and office areas containing computers, the area per person for an office or school classroom, as appropriate, should be used.

D1.14 Measurement of distances

Intent

To identify the nearest part of an exit for the purposes of measuring travel distance.

Why is this important?

D1.14 describes the point at which an exit has commenced with respect to both fire-isolated and non-fire-isolated exits.

Figures D1.15(1) and **D1.15(2)** illustrate methods of measuring the distance of travel specified in the BCA.

D1.15 Method of measurement

Intent

To specify the method of measuring the distance of travel to an exit in various situations.

Path a person would walk

The distance of travel to an exit is measured by determining the path a person would walk from the most remote area of the building to the nearest exit.

Measure around any built obstructions

It is necessary to measure around any walls, or other built obstructions (including a wall, a demountable wall, and permanent fixed seating). See **D1.15(f)** and **(g)**.

Furnishings do not need to be taken into account

Generally, furniture, cars in a carpark and some non-built or non-fixed obstructions are not taken into account in the calculation of travel distance. However, there may be occasions when such matters must be taken into account.

Figures D1.15(1) and D1.15(2)

Figure D1.15(1) illustrates, by example, the method of measuring the distance of travel for Class 2 and Class 3 buildings and Class 4 parts.

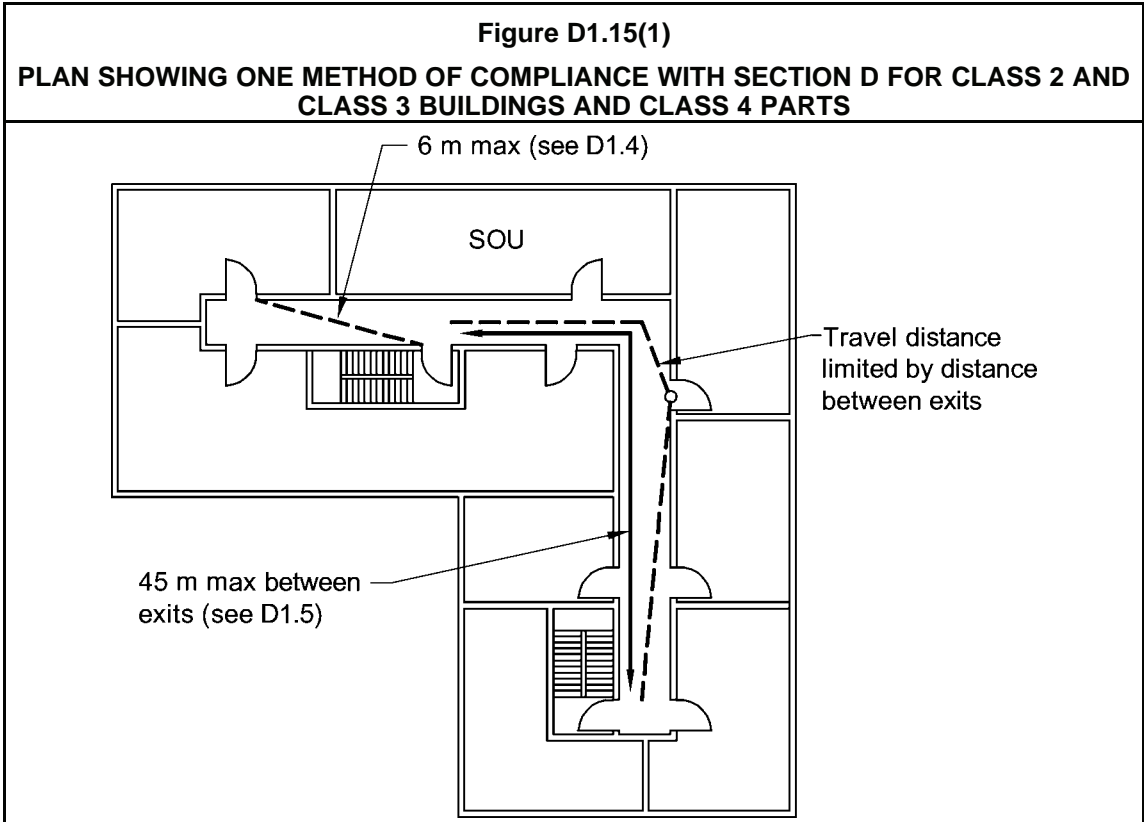
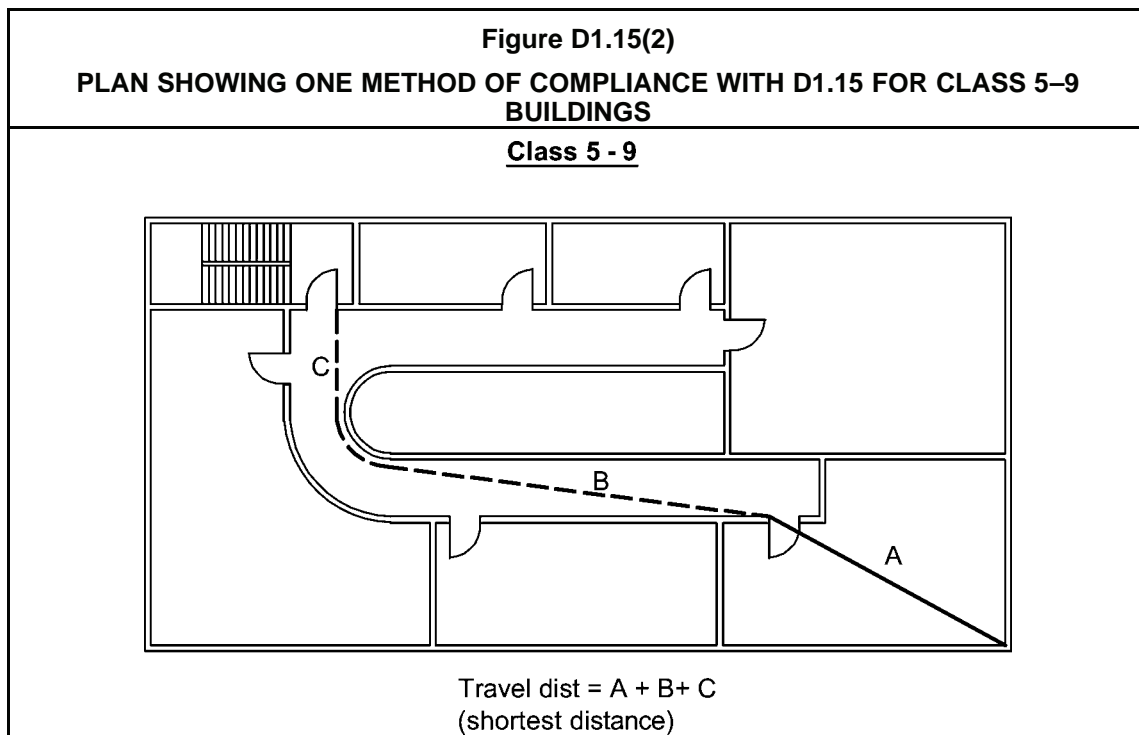

Figure D1.15(2) illustrates, by example, the method of measuring the distance of travel for Class 5–9 buildings.



D1.16 Plant rooms and lift motor rooms: Concession

Intent

To provide concessions for small plant and lift motor rooms.

Why are concessions made?

Concessions (such as the use of a ladder in lieu of a stairway) are granted for small plant or lift motor rooms for the following reasons:

- the usual occupants of a small plant or lift motor room are trained personnel who should be familiar with its layout;
- it is reasonable to assume that if the plant or lift motor room is small, so also will be the number of people who will ever occupy it;
- the small size of the room means that there is not a significant distance to travel to gain egress; and
- in the larger rooms which qualify for this concession, and multiple exits are provided, only one needs to be a stair.

Figure D1.16 illustrates some possible methods of using the concessions contained in **D1.16**.

Figure D1.16
PLANS SHOWING USE OF D1.16

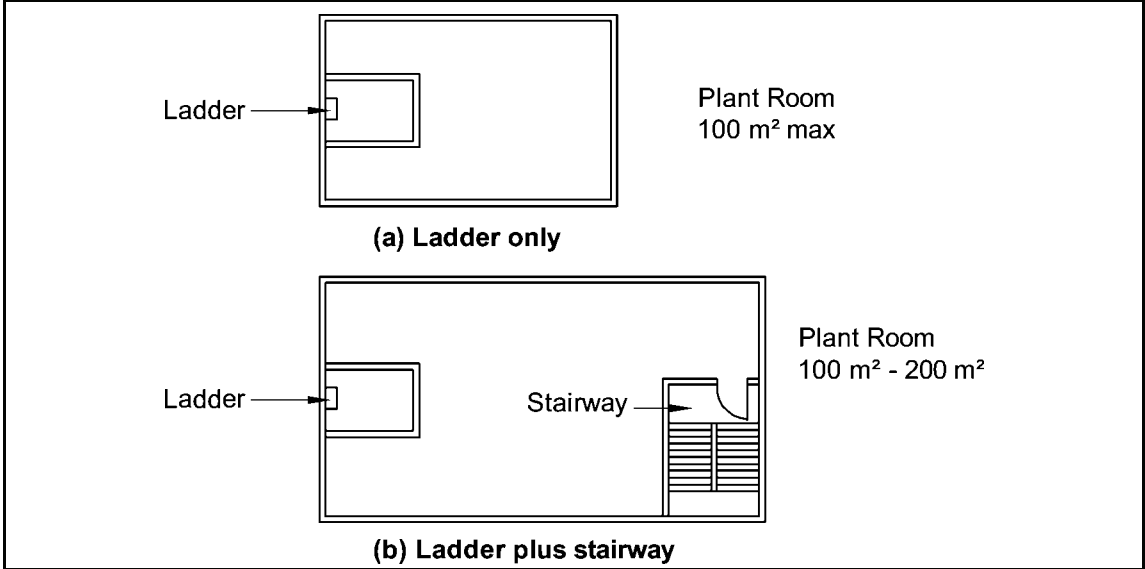

PART D2 CONSTRUCTION OF EXITS

Objective

Functional Statements

Performance Requirements

The Objective, Functional Statements and Performance Requirements for the whole of **Section D** are all located in the same position, preceding Part **D1**. The Comments on these provisions are located in the corresponding section of this Guide.

Deemed-to-Satisfy Provisions

D2.0 Deemed-to-Satisfy Provisions

Intent

To clarify that the requirements of **DP1** to **DP9** will be satisfied if compliance is achieved with Parts **D1**, **D2** and **D3** in the case of all buildings, and Part **G3** in the case of buildings with an atrium, Part **H1** in the case of theatres, stages and public halls, and **Part H2** for public transport buildings.

See **Deemed-to-Satisfy Provisions** of **D1.0**.

D2.1 Application of Part

Intent

To clarify that Part **D2** does not apply within a sole-occupancy unit in a Class 3 building (except for **D2.13**, **D2.14(a)**, **D2.16** and **D2.21**) nor within a sole-occupancy unit in a Class 2 building or Class 4 part (except for **D2.13**, **D2.14(a)**, **D2.16** and **D2.18**).

Where a path to the door is not a path of travel to an exit

Except as outlined below, Part **D2** does not apply within sole-occupancy units in Class 2 or Class 3 buildings or Class 4 parts. The path from within the units to the door opening from them is not regarded as a path of travel to an exit. For these buildings, the path of travel to an exit

commences at the outside of the door to the sole-occupancy unit. The path inside the unit, leading to the door, is part of the “evacuation route” (see the definition of this term in [A1.1](#)).

Exceptions

D2.13 deals with the construction of stair treads and risers. For the safety of people moving within a sole-occupancy unit, it is important that stair treads and risers are safe to use.

D2.14(a) requires the installation of landings in stairways. For the safety of people moving within a sole-occupancy unit, it is important that landings be provided. This also links with **D2.13(a)** to limit the maximum number of risers in a flight of stairs to 18.

D2.16 deals with balustrades. Appropriate balustrades are required to minimise the risk of people falling from a landing, balcony, roof with public access, flight of stairs and the like.

D2.18 allows steeper stairs to infrequently used areas of a building. This concession applies to infrequently used areas such as machinery rooms, boiler rooms, etc and attics and storerooms in sole-occupancy units in Class 2 buildings and Class 4 parts. Under **D2.18**, the designer has the choice of designing the stair, landing, balustrade and other barrier and handrail to comply with the appropriate provisions of the BCA or with AS 1657.

D2.2 Fire-isolated stairways and ramps

Intent

To maintain a sufficient level of fire safety to enable the use of fire-isolated stairways and ramps during an emergency.

Materials and construction methods

D2.2 sets the criteria for the materials and methods of construction used in stairways and ramps within a fire-resisting shaft.

Integrity of fire protection to be maintained—**D2.2(a)** and **(b)**

D2.2(a) and **(b)** set out the requirements for maintaining the integrity of the fire protection to the shaft of a fire-isolated stairway and ramp. These provisions reflect the fact that:

- occupants who use the stairway or ramp during a fire will expect to remain reasonably safe while evacuating, relying on the protection provided by the fire-isolated stairways and ramps to safely evacuate the building; and
- the stairway or ramp provides protection to the fire brigade to undertake search and rescue, and fire-fighting operations.

D2.3 Non-fire-isolated stairways and ramps

Intent

To maintain a sufficient level of safety for the use of stairways and ramps during an emergency.

Safe egress required

Where the installation of non-fire-isolated stairways and ramps is required by the BCA, they must provide a safe means of egress.

Such stairways and ramps will not be within a fire-resisting shaft, but they are nonetheless expected to be structurally sound, and constructed of materials which will not readily support combustion.

D2.3 requires that required non-fire-isolated stairways and ramps must be either constructed in accordance with **D2.2** or the alternative options set out in **D2.3(a)–(c)**.

Glued timber members—D2.3(c)(iii)

D2.3(c)(iii) permits the use of glued timber members under certain conditions. The aim of these conditions is to minimise the risk represented by certain types of glue which delaminate during a fire.

D2.4 Separation of rising and descending stair flights

Intent

To minimise the risk that an occupant mistakenly passes the lowest storey providing escape when evacuating.

Risk of missing the lowest egress floor—D2.4(a)

A danger exists that, in an emergency, a person may mistakenly pass the lowest floor providing direct egress to a road or open space. **D2.4(a)** minimises the risk of this by requiring that there is no direct connection between the rising and descending flight of a stairway at the level from which egress is obtained.

Separation required—D2.4(b)

If, in order to achieve **D2.4(a)**, rising and descending flights of stairs are separated by construction (which may in places be common to the two flights), that construction must comply with the smoke separation requirements contained in **Clause 2 of Specification C2.5**.

Figure D2.4 illustrates one method of compliance with **D2.4**.

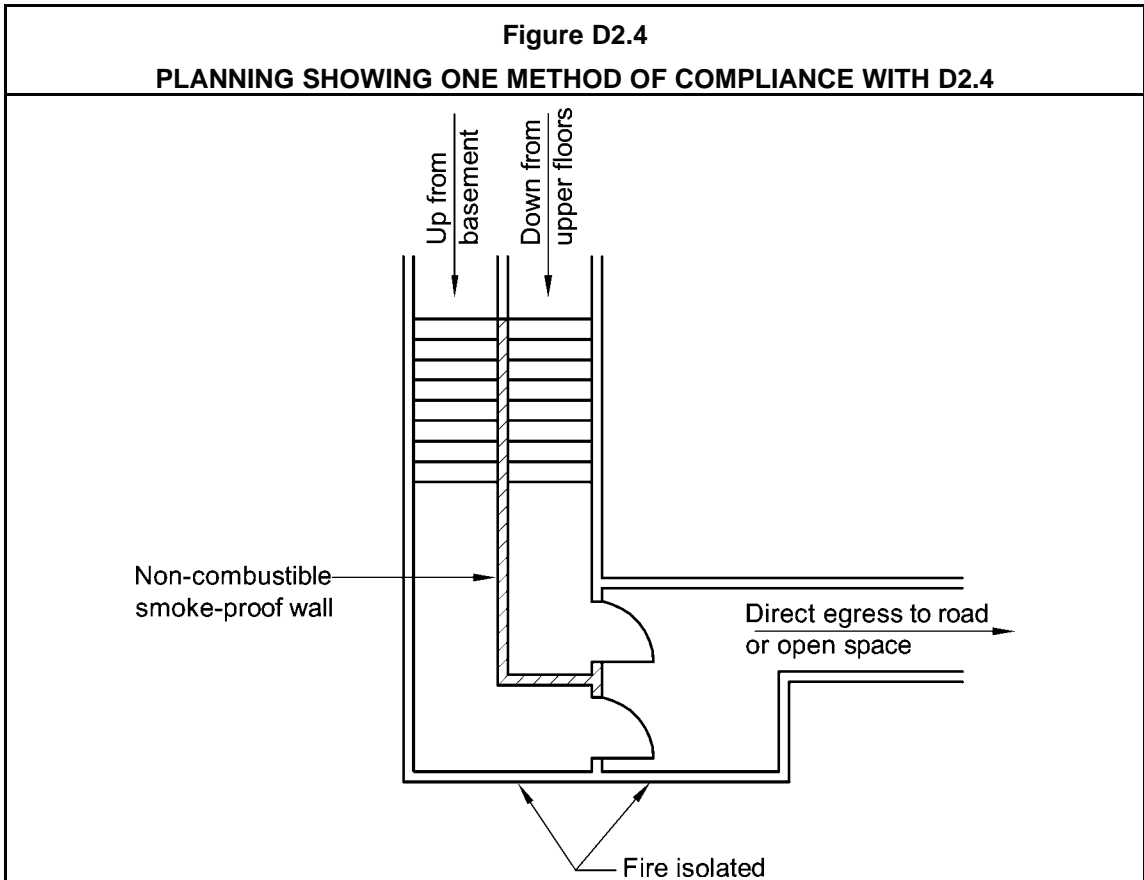

D2.5 Open access ramps and balconies

Intent

To specify the requirements for natural ventilation of smoke from an open access ramp or balcony which forms part of a required exit system.

Background

Table E2.2a allows the use of an open access ramp or balcony instead of stairwell pressurisation. If this option is chosen then **D2.5** aims to prevent the entry of smoke into a fire-isolated exit by allowing smoke to vent naturally through an open access ramp or balcony, before it reaches the fire-isolated exit.

Ventilation openings—D2.5(a)

D2.5(a) sets out the requirements for ventilation openings where an open access ramp or balcony forms part of a required exit. This helps the evacuation of occupants using the exit by enabling the natural ventilation of smoke.

Enclosure permitted up to 1 metre—D2.5(b)

The reason for permitting an enclosure up to a height of one metre under **D2.5(b)** is to allow for a solid balustrade or balcony.

No more than 25 percent enclosed above 1 metre—D2.5(b)

Note that the opening above one metre cannot be enclosed for more than 25 percent of the area of its sides. This allows for adequate smoke ventilation, while permitting some limited enclosure.

Figure D2.5 illustrates three methods of compliance with **D2.5**, and one method that does not comply.

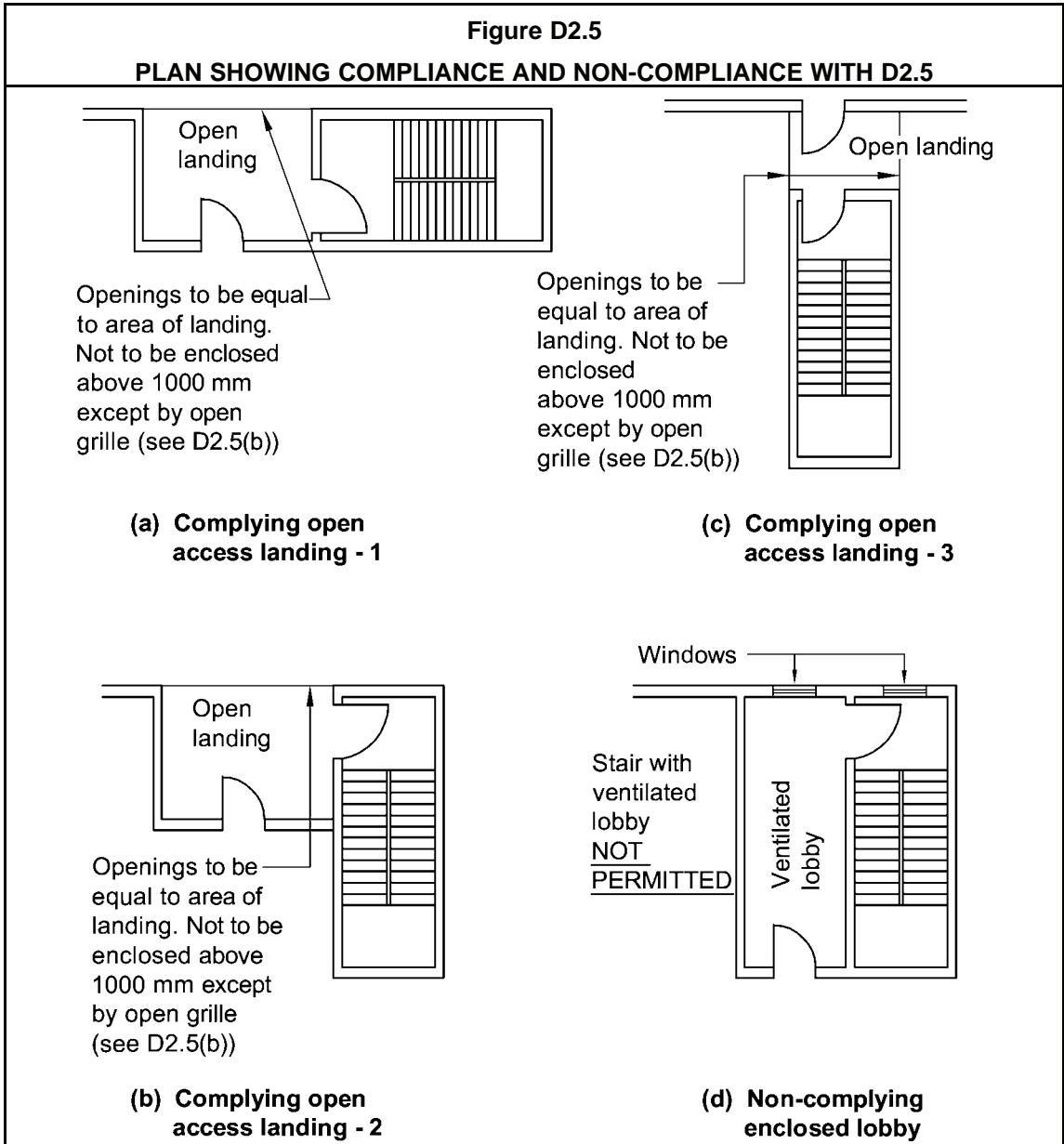

D2.6 Smoke lobbies

Intent

To prevent smoke entering a fire-isolated exit.

Smoke lobbies required by D1.7

D2.6 only applies to a smoke lobby required by D1.7.

A smoke lobby required by D1.7 must be constructed in accordance with each of the requirements in D2.6(a)–(d).

Intumescent putty—D2.6(b)(iii)

The intumescent putty referred to in D2.6(b)(iii) is intended to expand when exposed to fire, thus sealing any opening at the top of the lobby against smoke. If another material is proposed, it must be no less effective than the putty.

D2.7 Installations in exits and paths of travel

Intent

To maximise the safety of occupants evacuating to or within exits by limiting the types of services which may be located in exits and paths of travel.

Services in exits and paths of travel

Paths of travel within a building must continue to provide safe evacuation during an emergency. To achieve this, D2.7 restricts the installation of certain services in fire-isolated exits, non-fire-isolated exits, and certain paths of travel to exits.

Access to services—D2.7(a)

D2.7(a) prohibits access to services (apart from fire-fighting and detection equipment) from within a fire-isolated exit because they are a potential source of smoke or fire. Doors to service enclosures, if left open, could also hamper evacuation. The prohibition also means that maintenance equipment will not be placed within the enclosure.

Chutes and ducts—D2.7(b)

D2.7(b) prohibits any chute or duct carrying products of combustion from a boiler, incinerator fireplace or the like from being installed in:

- any required exit (ie both fire-isolated exits and non-fire-isolated exits); and
- any corridor, hallway, lobby or the like leading to a required exit (ie it does not apply to other paths of travel to an exit).

An opening from a chute or duct that forms part of a smoke hazard management system is permitted.

Gas and fuel services—D2.7(c)

D2.7(c) prohibits the installation of any gas or other fuel service in a required exit (ie both fire-isolated exits and non-fire-isolated exits). This prohibition does not apply to a path of travel to an exit.

Other services—D2.7(d)

Under specified conditions, **D2.7(d)** allows certain electrical and communication services to be located in:

- **D2.7(d)(iv)**—any required non-fire-isolated exit (installation in required fire-isolated exits is effectively prohibited by the reference to **D2.7(a)**); and
- **D2.7(d)(v)**—any corridor, hallway, lobby or the like leading to a required exit (ie it does not apply to other paths of travel to an exit).

Electrical wiring—D2.7(e)

D2.7(e) allows electrical wiring to be installed within a fire-isolated exit if the wiring is associated with specified equipment and systems serving the exit or systems used for alarms and monitoring of fire safety systems.

D2.8 Enclosure of space under stairs and ramps

Intent

To minimise the risk of a fire starting under a stairway and endangering the safe evacuation of the building occupants.

Fire risk from spaces under stairways or ramps

Spaces under stairways are often used for a range of purposes. It is common practice to have a cleaner's store located in such spaces. These stores often contain flammable cleaning agents.

Required fire-isolated stairways or ramps—D2.8(a)

Space is part of the fire-isolated shaft

If the stairway or ramp is fire-isolated, and the space below is part of the fire-isolated shaft, that space must not be used as a cupboard or the like.

Space is not part of the fire-isolated shaft

If the stairway or ramp is fire-isolated, and the space below is not part of the fire-isolated shaft, that space may be used as a cupboard etc. This could be created by placing a fire rated slab under the flight of stairs. This is shown in **Figure D2.8**.

Required non-fire-isolated stairways or ramps—D2.8(b)

If the stairway or ramp is non-fire-isolated, any cupboard underneath must be fire separated from the stairway. The construction must have an FRL of 60/60/60, with a self-closing –/60/30 fire door.

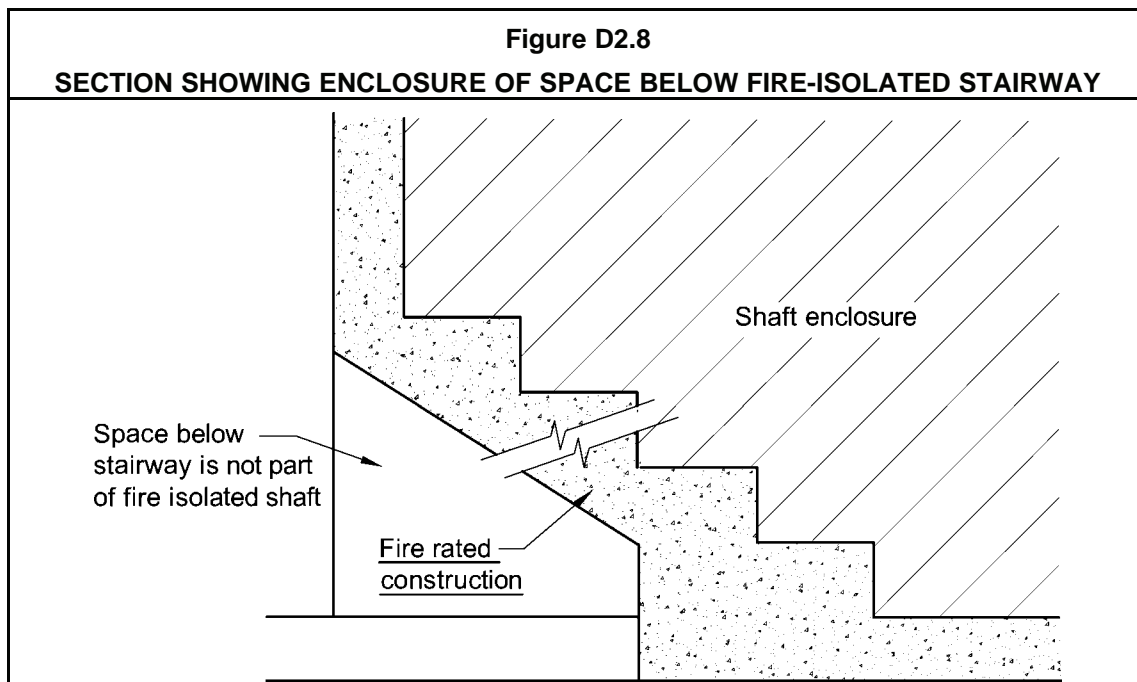

D2.9 Width of stairways and ramps

Intent

To establish requirements for the safe use of wide stairways and ramps.

Width of two metres—D2.9

Most people using stairways tend to move in easy reach of a handrail or balustrade. This tendency is particularly pronounced during an emergency evacuation. The **D2.9** maximum of two metres (effectively permitting a reach of one metre to either side) is considered reasonable.

Wider stairways are permitted, with more than two metres between the handrails. However, for the purposes of calculating required widths, such stairways are deemed to add no more than two metres to the aggregate required width.

Example

If a building is required to have a path of travel to an exit with a width of four metres, a stairway with four metres of width between its handrails will not comply, as it will be deemed to only provide two metres of width. Therefore, an intermediate handrail should be provided or a further two metres must be provided by other means.

D2.10 Pedestrian ramps

Intent

To allow the use of a ramp as a required exit, instead of a stairway.

Ramps instead of stairways—D2.10(a)

Under **D2.10(a)**, a fire-isolated ramp may be used instead of a fire-isolated stairway if:

- the construction enclosing the ramp complies with the requirements of the BCA for fire-isolated stairways; and
- the width and ceiling height of the ramp complies with the requirements of the BCA for fire-isolated stairways.

Specified ramp gradients—D2.10(b)

D2.10(b) specifies safe gradients for a ramp used as a required exit. They are determined having regard to likely users.

Ramps for people with disabilities, as specified by Part **D3**, require a gradient of not less than 1:14, and in other cases, not less than 1:8.

D2.10(b) relates to a ramp being used as a fire-isolated exit. If the ramp is also used for access it must comply with the requirements for such ramps in Part **D3**.

D2.11 Fire-isolated passageways

Intent

To make a fire-isolated passageway safe from a fire outside.

Protection of fire-isolated passageways—D2.11(a)

Under **D2.11(a)**, the required FRL of a fire-isolated passageway must (except as set out in **D2.11(b)**):

- **D2.11(a)(i)**—not fall below the required FRL of any fire-isolated stairway or ramp which discharges into the passageway; and
- **D2.11(a)(ii)**—in every other case, not fall below 60/60/60.

The FRL test is for a fire outside the passageway, in another part of the building. It is extremely unlikely that a fire will occur inside a fire-isolated passageway.

Top of a fire-isolated passageway—D2.11(b)

Despite the requirements of **D2.11(a)**, **D2.11(b)** allows the top of a fire-isolated passageway to be constructed without an FRL on the condition that its walls are built up to either of the following:

Non-combustible roof covering—D2.11(b)(i)

The top construction of a fire-isolated passageway need not have an FRL if the walls continue to the underside of a non-combustible roof covering.

Incipient spread of fire resistant ceiling—D2.11(b)(ii)

Under **D2.11(b)(ii)**, a fire-isolated passageway need not have a top construction with an FRL, and need not have its walls extend to the underside of a non-combustible roof covering if the walls extend to the underside of a ceiling which is resistant to the incipient spread of fire for at least 60 minutes.

Figure D2.11

ELEVATIONS SHOWING ALTERNATIVE METHODS OF PROTECTING A FIRE-ISOLATED PASSAGEWAY FROM A FIRE IN ANOTHER PART OF THE BUILDING

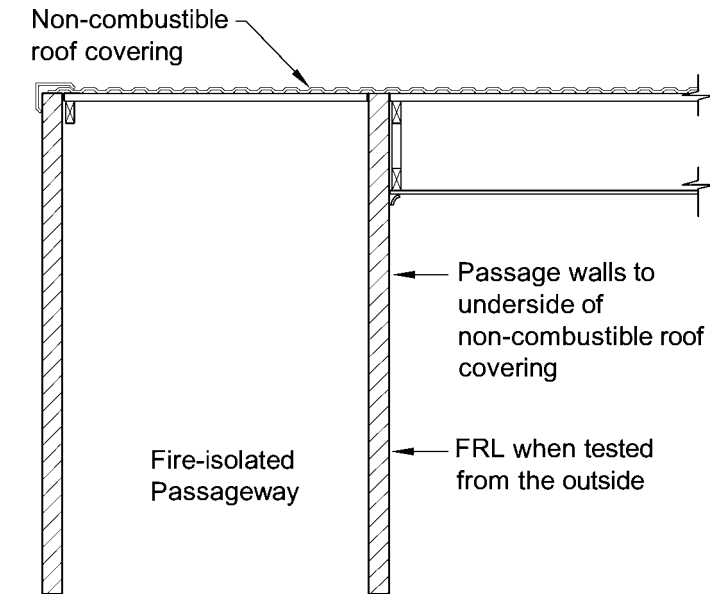

(a) Wall extending to roof covering

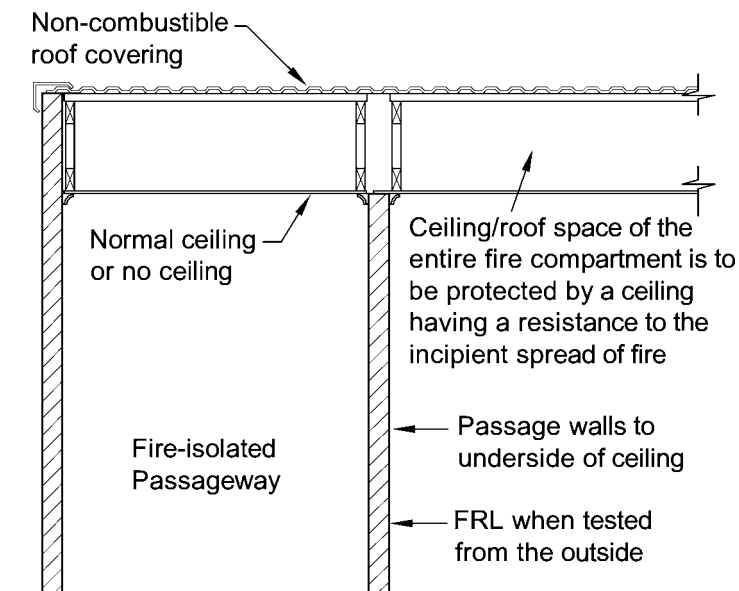

(b) Wall extending to ceiling

Such a ceiling will prevent the ignition of combustible materials in the roof or ceiling space from a fire below. For the ceiling to be effective, the whole fire compartment surrounding the passageway must also be covered. This will minimise the risk of a fire spreading into the fire compartment's roof or ceiling space, and entering the passageway from above. An incipient

spread of fire resistant ceiling is not required over the passageway, because it is extremely unlikely that a fire will start there.

It is important that the junction between the top of the wall and the incipient spread of fire resistant ceiling is adequately sealed to maintain the integrity of the barrier.

Figure D2.11 illustrates this comment.

D2.12 Roof as open space

Intent

To allow a roof of a building to be used as a point of discharge from an exit.

Roof must be protected

Exits must provide egress to a road or an open space. **D2.12** applies where the open space is provided by a roof. To maximise the safety of people who must use a roof as the point of discharge from an exit, such a roof is required:

- **D2.12(a)**—to have an FRL sufficient to protect people on the roof from fire below during evacuation from the building; and
- **D2.12(b)**—not to have any openings within three metres of the path of travel to the portion of the roof being used as open space, and from that portion to a road. This protects a person passing such openings from being affected by a fire on the other side of such openings.

Safe path of travel to road

Once on the roof, a safe path of travel must be provided to a road. See **D1.10**.

D2.13 Goings and risers

Intent

To enable the safe movement of people using stairways.

Background to **D2.13**—goings and risers

The going and riser requirements in **D2.13** date from a substantial reform carried out in 1987, based on international research.

Safe stairway requirements

No more than 18 nor less than 2 risers—**D2.13(a)(i)**

D2.13(a)(i) states that a stairway must have no more than 18 nor less than 2 risers in each flight. Where there are less than 2 risers in a flight, they do not comprise a stairway for the purposes of the BCA.

Eighteen risers is considered to be the maximum reasonable number that an average person can negotiate before requiring a rest.

Winders are counted as part of the maximum number of 18 risers. More than one riser is considered necessary for a person to observe and adjust to a change in level.

Going and riser heights—D2.13(a)(ii) and (iii)

The purpose of **D2.13(a)(ii)** and **(iii)** and **(b)(iii)** and **(iv)** is to achieve constant going and riser heights deemed safe for people to walk up and down. This minimises the risk of people tripping on uneven stairs. **Table D2.13** expresses ratios between stairways which are considered safe for use.

Openings in stair risers—D2.13(a)(iv)

D2.13(a)(iv) allows the use of open stair risers. However, it limits the opening to 125 mm to minimise the risk to children.

Treads—D2.13(a)(v)

Under **D2.13(a)(v)**, treads must be slip resistant, or have a non-skid strip to avoid people slipping over and injuring themselves. The non-skid strip need only be on the tread's nosing. This provision is written as a performance statement, specific provisions have not been developed.

Solid treads—D2.13(a)(vi)

Under **D2.13(a)(vi)**, where a stairway is of a specified height, solid treads must be used so that people cannot see through them. This minimises the risk to people affected by vertigo.

Change in direction—D2.13(a)(vii)

Under **D2.13(a)(vii)**, stairways in Class 9b buildings require a change in direction of at least 30° at specified points. This limits the distance a person can trip or fall down the stairways. This sort of occurrence is more likely to take place in buildings with large numbers of people who are unfamiliar with the building or its stairways.

Winders in lieu of landings—D2.13(a)(viii) and (b)(i)

Under **D2.13(a)(viii)**, winders in lieu of landings are not permitted in a required stairway. Under **D2.13(b)(i)** winders in lieu of landings are permitted in non-required stairways provided that not more than 3 winders in lieu of a quarter landing or not more than 6 winders in lieu of a half landing are used.

Sloping public walkways — D2.13(c)

When a stairway discharges directly to a sloping public walkway or road, it is extremely difficult to maintain a constant riser height without setting the stairway back from the walkway. **D2.13(c)** therefore allows a variation in the riser height in these situations.

See **Figure D2.13**

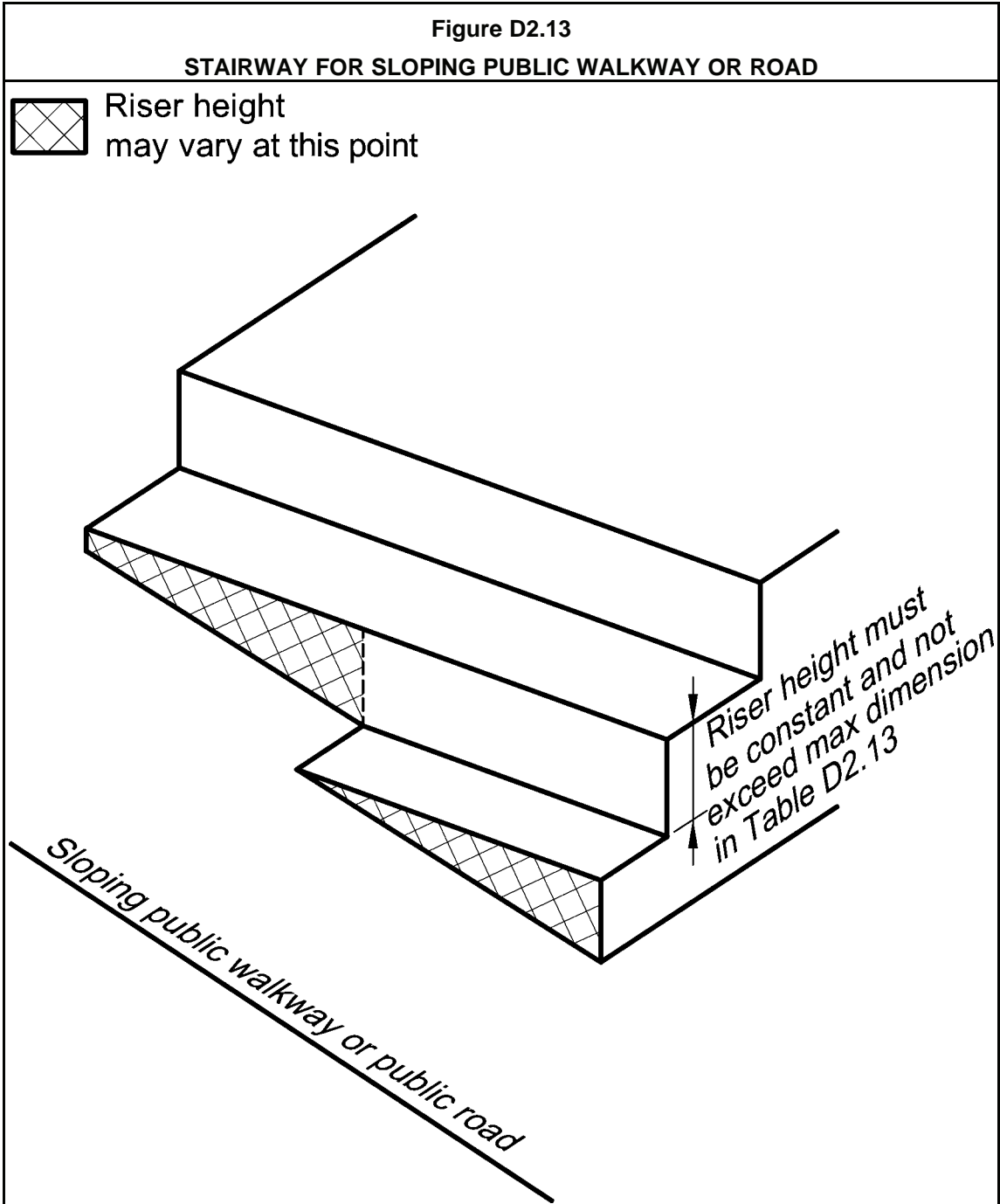

Table D2.13

Purpose

Table D2.13 addresses both public and private stairways, and provides information on acceptable maximum and minimum risers and goings. It also illustrates the method of

measuring the rise and going of stairway treads and the maximum gap between treads referred to in [D2.13\(a\)\(iv\)](#).

Stairway that is curved or circular in plan view

Note (b) of [Table D2.13](#) allows the use of a stairway which is curved, or circular in plan view.

D2.14 Landings

Intent

To enable the safe movement of people using stairways.

Purpose of a landing in a stairway

The purpose of a landing is to limit the number of risers to provide a rest area for the people using the stairway, and to allow the stairway to change direction if needed.

Maximum grade of 1:50—[D2.14\(a\)](#)

The maximum grade of 1 in 50 required under [D2.14\(a\)](#) makes sure that the landing is as level as possible, but still allows a slight slope for drainage if necessary.

Minimum landing length—[D2.14\(a\)\(i\)](#)

The minimum length of a landing allows people using the stairway to rest, and reduces the risk of a person falling more than one flight of stairs.

Non-slip finish or non-skid strip—[D2.14\(a\)\(ii\)](#)

The non-slip finish or non-skid strip is to prevent a person slipping on the landing.

Class 9a buildings—[D2.14\(b\)](#)

[D2.14\(b\)](#) provides two options for landings in Class 9a buildings. The aim is to aid the use of a stretcher.

[Figure D2.14](#) illustrates the method of measuring the length of landings as required by [D2.14](#).

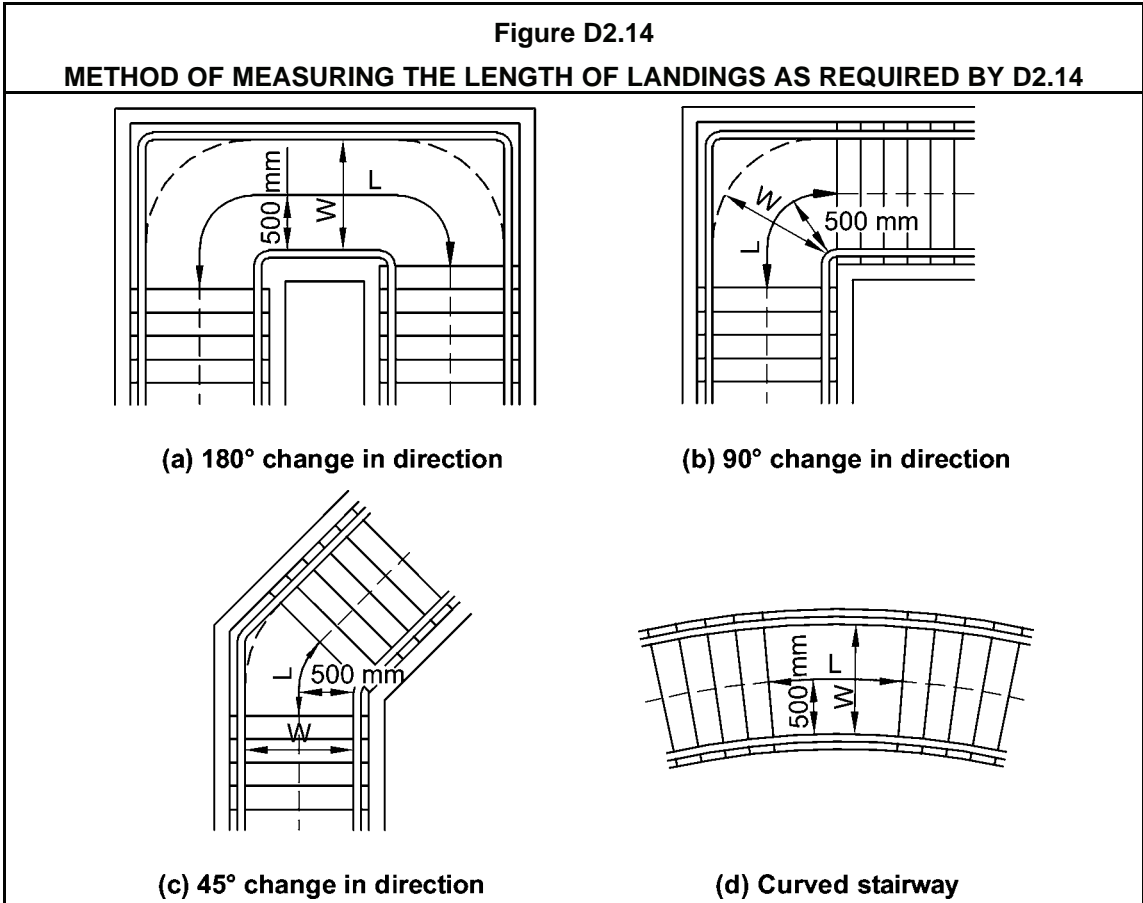

D2.15 Thresholds

Intent

To reduce the risk of a person tripping on an unseen step in a doorway.

Step prohibited too close to a door

It is difficult to see a step or ramp which is too close to a door. People can trip, particularly if the ramp or step is on the opposite side of a door. **Figure D2.15(1)** illustrates the area where a step is not allowed in a doorway.

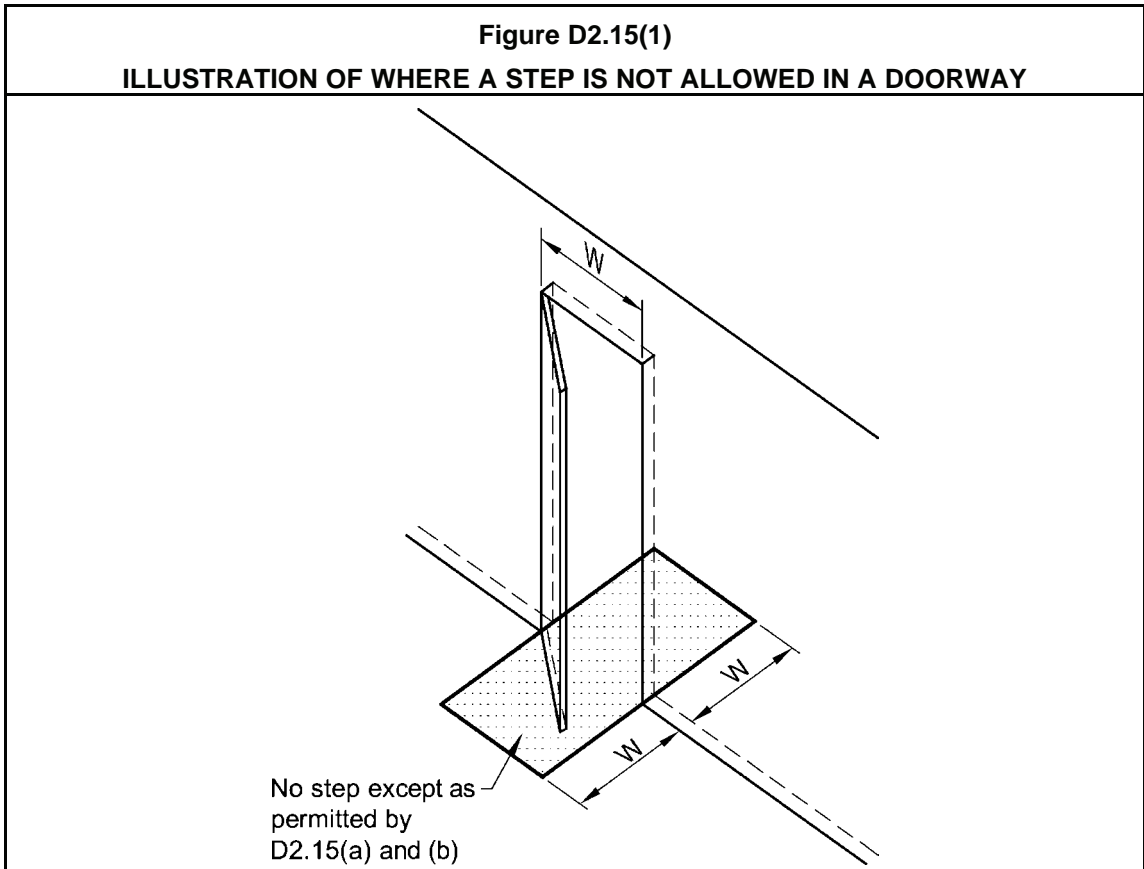

Concessions—D2.15(a), (b) and (c)

Concessions are granted in specified circumstances. These include:

- **D2.15(a)**—in the patient care areas of a hospital; and
- **D2.15(b)**—in Class 9c aged care buildings; and
- **D2.15(c)**—in other buildings, to allow for weatherproofing under an external door.

Class 9c aged care buildings— D2.15(b)

The threshold of a doorway in a Class 9c aged care building, which is subject to a change in level, may incorporate a ramp and cannot be provided with a step. This is a safety requirement due to the varying mobility of the residents. The ramp may have a maximum slope of 1 in 8 and a maximum height of 25 mm. **Figure D2.15(2)** illustrates an example of a ramp at a doorway threshold in an aged care building.

Figure D2.15(2)

ILLUSTRATION OF RAMP AT DOORWAY THRESHOLD IN AGED CARE BUILDING

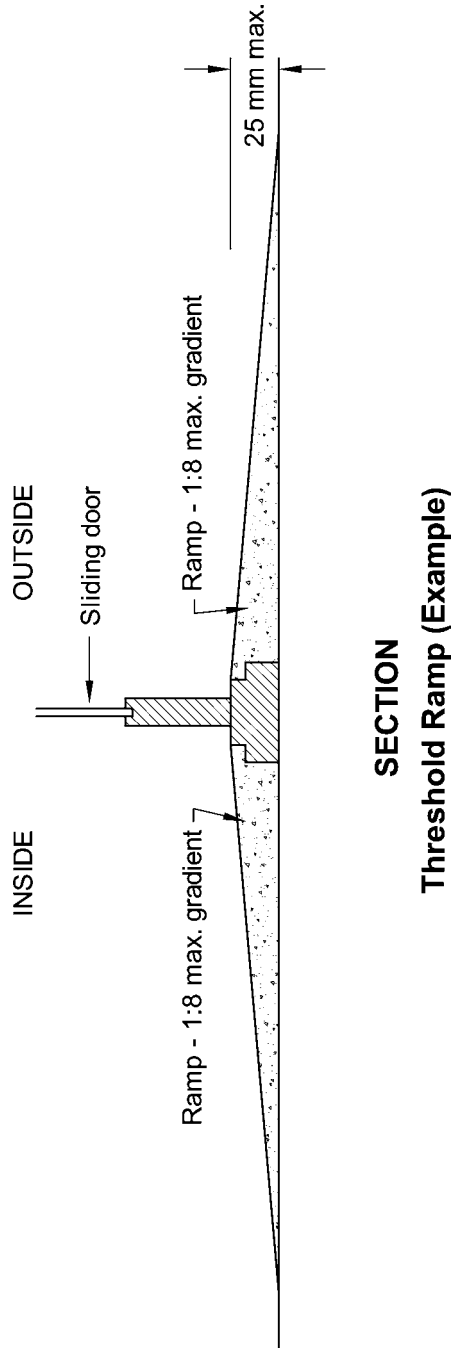

D2.16 Balustrades or other barriers

Intent

To minimise the risk of a person falling from a roof, stairway, raised floor level or the like.

D2.16 and DP3

This is the **Deemed-to-Satisfy Provision** for DP3.

Where balustrades are required

D2.16(a) sets out when balustrades are required. It should be noted that a balustrade is only required where an identified hazard of falling is present. **D2.16(b)** provides an exemption for the installation of balustrades in areas that would be inappropriate due to their inherent functions. These areas include at the perimeter of a stage, rigging loft or the like, or areas referred to in **D2.18**. The reference to 'or the like' could include such areas as the passenger loading points on railway platforms. The following specific provisions apply to balustrades:

- **D2.16(c)(i)**—for fire-isolated exits, where unaccompanied children are unlikely to be present.
- **D2.16(c)(ii)**—for Class 7 buildings (other than car parks) and Class 8 buildings, which are assumed to have a low occupancy rate and where unaccompanied children are unlikely to be present.
- **D2.16(d)**—for non-fire-isolated stairways and ramps.
- **D2.16(e)**—for horizontal surfaces.
- **D2.16(f)**—for certain Class 9b buildings, where lesser heights are permitted to allow uninterrupted viewing of a performance. These lower heights are not expected to be a problem, because unaccompanied children are unlikely to be present.
- **D2.16(g)** and **(h)**—provide the required construction details regarding height and the gap between balusters. To lessen the risk of children climbing and falling from high balconies, the design must not incorporate horizontal rails or other similar features.

When measuring the height of the balustrade, allowance should be made for floor finishes such as tiles and carpet when they are to be installed at a later time.

- **D2.16(g)**—the slope of 1:20 is included to distinguish between the floor of a ramp and the floor of a landing that has a slight slope for drainage purposes. The result is that if the floor has a slope of less than 1:20, it is considered as a landing and must have a balustrade with a height of not less than 1 m above the floor. In all other cases, the floor is considered to be a ramp, where the balustrade must have a height of not less than 865 mm above the floor.

A transition zone is permitted where the balustrade above the stair nosings and landing meet. This overcomes the need for a step in the top of the balustrade to maintain the 1 m height above the landing. See **Figure D2.17(2)**.

Figures D2.16(1) and **D2.16(2)** illustrate the various requirements for balustrades.

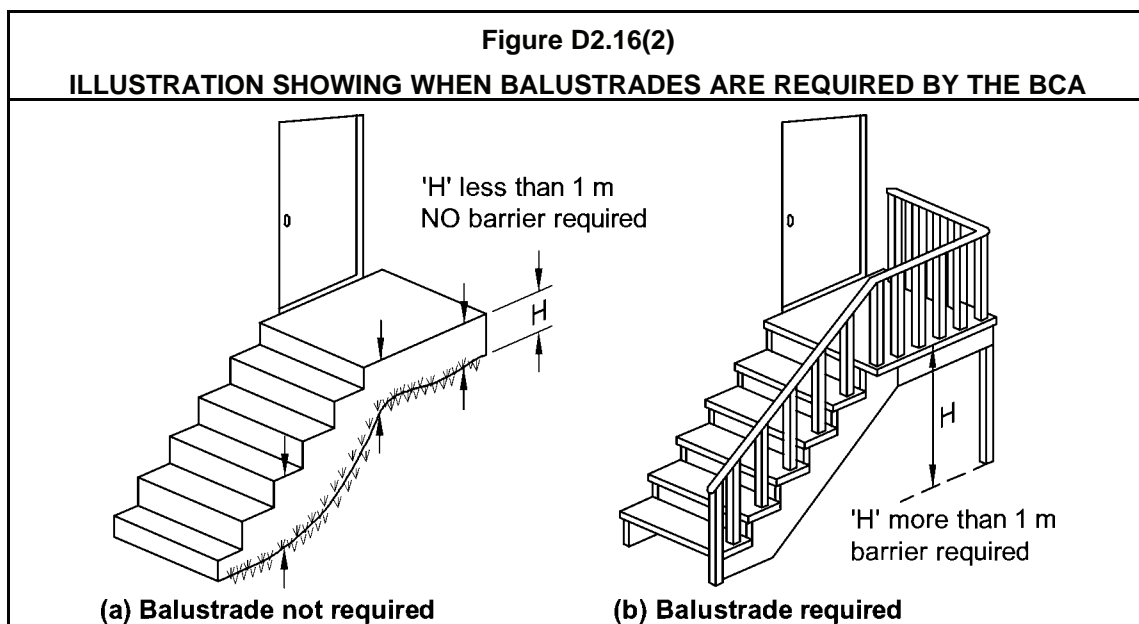
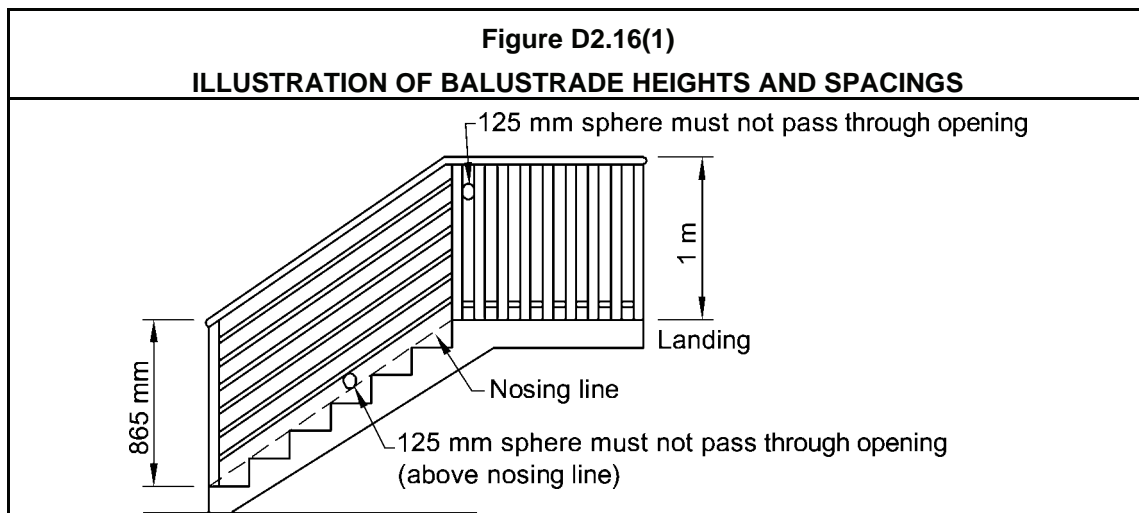

Wire balustrades

Wire balustrades deflect under loading conditions, even when tightly tensioned, and therefore some doubt has been expressed as to whether they can meet the requirements of [D2.16\(h\)\(ii\)](#) not to permit a 125 mm sphere to pass through. Also, some concern has been expressed that in time the wire tends to lose its tension and could therefore allow the passage of the 125 mm sphere.

In 2003, the ABCB commissioned research to determine how to overcome these difficulties. The results of this research is contained in [D2.16\(i\)](#).

[D2.16\(i\)](#) allows the use of wire balustrades without the need to demonstrate that the balustrade would not permit the passage of a 125 mm sphere provided the wire diameter, lay and type, post spaces, etc. are satisfied. If it is proposed to differ any of the specified criteria, then it would be necessary to demonstrate to the approval authority that the Performance Requirement had been satisfied by the use of an Alternative Solution.

To assist in the application of **D2.16(i)**, the following terms have been defined:

- Continuous – where the wire spans three or more supports.
- Non-continuous – where the wire only spans between two supports.
- Pulley block – a device consisting of a wheel in which a wire runs around to change its direction.
- Permissible deflection – is the allowable bending of the wire.
- Support rails – are horizontal components of the balustrade system that span across the top and bottom to provide structural support.

D2.16(i) provides for three alternative systems, namely—

- horizontal wire systems; and
- non-continuous vertical wire systems; and
- continuous vertical or near vertical wire systems.

For the purpose of **D2.16(i)**, a wire balustrade consist of a series of tensioned wire rope connected to either vertical or horizontal supports serving as a guard to minimise the risk of a person falling from a roof, stairway, raised floor level or the like.

A wire balustrade excludes wire mesh fences and the like.

Tables D2.16a and **D2.16b** contain tension requirements for wires in vertical and horizontal wire balustrade systems with varying post spacings, wire spacings and wire types, whereas **Table D2.16c** only contains deflection requirements for use in horizontal and vertical balustrade systems. With the latter, deflection is referred to as an "offset" and is limited to systems that use non-continuous wires. The figures contained in the three tables were derived from testing the spacing combinations in order to prevent the passage of a 125 mm diameter solid cone penetrating between the wires at a predetermined force. The tables also contain additional guidance to ensure that the wire tension will be maintained during the life of the balustrade.

For safety, sharp ends of wires at terminations and swages need to be removed and no wire end should protrude more than half the diameter of the wire from the swage or termination fitting.

D2.17 Handrails

Intent

To provide handrails to a stairway or ramp, in corridors in Class 9a and 9c buildings and in corridors required to be accessible by people with a disability.

D2.17 addresses requirements regarding the location, spacing and extent of handrails. Where both balustrade and handrail matters require consideration, **D2.17** must be read in conjunction with those of **D2.16**.

Handrail location and separation—**D2.17(a)(i)–(ii)**

D2.17(a)(i) and **(ii)** set out the location and separation requirements for handrails. For intermediate handrails, see the requirements in **D2.9**.

Handrail heights

Primary schools—**D2.17(a)(iv)**

D2.17(a)(iv) requires a second handrail located at a practical height between 665 mm and 750 mm in a primary school, to aid children who are generally shorter than adults.

865 mm height requirement—D2.17(a)(v)

Under **D2.17(a)(v)**, the height of handrails is a minimum of 865 mm, so that they are comfortable to use for most people and provide adequate stability support and assistance.

Continuous handrails

D2.17(a)(vi) requires a continuous handrail between stair flight landings. It does not apply around a landing between flights, as such a requirement would often be impractical.

Obstructions placed on handrails to prevent people deliberately sliding down them must be considered on a case by case basis to determine whether a hand hold is broken. Ball type stanchions at the top of supports to handrails may be permissible. See **Figure D2.17(1)**.

Handrails in Class 9a corridors—D2.17(b)(i)

The **D2.17(b)(i)** provisions requiring handrails on at least one side of corridors in a Class 9a building are intended to assist patients.

Handrails in Class 9c corridors—D2.17(b)(ii)

The **D2.17(b)(ii)** provisions requiring handrails in corridors in a Class 9c building are intended to assist residents. The handrails are required on both sides of the corridor to assist residents accessing the common areas such as dining rooms and recreation rooms in their day to day living.

People with a disability—D2.17(c)

D2.17(c) is provided to remind users of the BCA that there are specific requirements for handrails to provide access for people with a disability under **Part D3**.

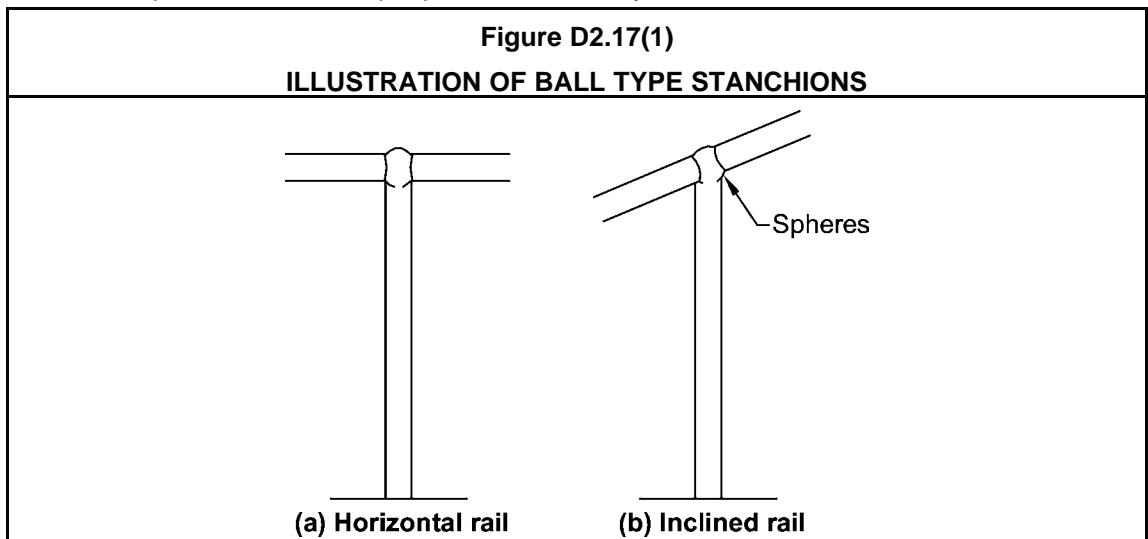
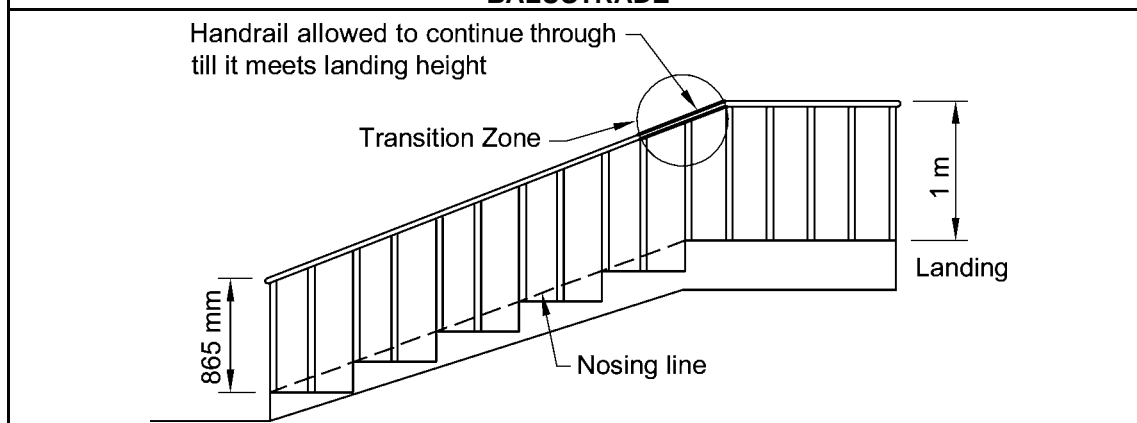

Figure D2.17(2) illustrates the use of handrails complying with **D2.17**.

Figure D2.17(2)

ILLUSTRATION OF HANDRAILS COMPLYING WITH D2.17 WHICH FORM PART OF A BALUSTRADE



D2.18 Fixed platforms, walkways, stairways and ladders

Intent

To provide appropriate access and egress from infrequently used areas.

Reasons for different requirements

Some areas are only accessed by maintenance or specialist workers. In such areas, access and egress requirements for members of the public no longer apply, and the requirements are permitted to fall outside the various measurements applying elsewhere.

In Class 2 buildings or Class 4 parts, this includes non-habitable rooms such as attics, storerooms and the like that are not used on a frequent or daily basis. In such cases, the designer has the choice of designing the stair, landing, balustrade or other barrier and handrail to comply with the appropriate provisions of the BCA or with AS 1657.

D2.19 Doorways and doors

Intent

To minimise the risk that a door may obstruct a person evacuating.

D2.19 and D2.20 have the same intent

D2.19 should be read in conjunction with D2.20 because its intent is the same.

Clarification of when a doorway (or door) is "serving as (or in) a required exit", "forming part of a required exit" or "in the path of travel to a required exit"

D2.19 refers to a "doorway serving as a required exit or forming part of a required exit". D2.20 refers to a "door in a required exit or forming part of a required exit". D2.21 refers to a "door in a required exit, forming part of a required exit or in the path of travel to a required exit".

The three different terms have application to doorways and doors in three different situations described below. To understand the differences between these terms, it is necessary to

understand what an exit is, as described in the definition of "exit". Also, **D1.14** Measurement of distances, provides guidance by describing when the "nearest part of an exit" includes a doorway and when it does not.

The definition of "exit" indicates that stairways (internal or external), ramps and fire isolated passageways are all exits if they provide egress to a road or open space, as are doorways opening to a road or open space and horizontal exits. Stairways and ramps that serve as exits may either be fire-isolated or non-fire-isolated, as determined by **D1.3**.

D1.14 describes the "nearest part of an exit" for the purpose of measuring distances (prescribed by **D1.15**), indicating when a doorway is considered to be part of the exit.

The nearest part of the exit is the nearest part of the doorway providing access to a fire-isolated stairway, fire-isolated passageway or fire-isolated ramp, horizontal exit, and a doorway opening to a road or open space. For a non-fire-isolated stairway however, it is the nearest riser, and for a non-fire-isolated ramp, it is the nearest part of the ramped floor. The measurement to the nearest part of a doorway for a fire-isolated exit, horizontal exit and a doorway opening to a road or open space, indicates that the doorway forms part of the exit.

A "doorway serving as a required exit" or a "door in a required exit" means one that is acting as the exit itself, such as the final doorway or door—

- opening to a road or open space; or
- in a horizontal exit.

In this case, the nearest part of the doorway itself is the nearest part of an exit. The doorway or door opening to a road or open space may be a doorway or door from a space or room, or from a corridor.

A "doorway forming part of a required exit" or a "door forming part of a required exit" means a doorway or door that provides access to or is within—

- a fire-isolated stairway or ramp; or
- a fire-isolated passageway.

In this case, the nearest part of the exit is the doorway providing access to the fire-isolated stairway, ramp or passageway. Therefore, any doorway or door that leads into or out of a fire-isolated stairway, ramp or passageway is a doorway or door forming part of a required exit.

A "doorway or door in the path of travel to an exit" is a doorway or door that is not serving as, providing access into, or in, a required exit and does not form part of a required exit. It includes a doorway or door—

- opening from any space in a storey such as an office, conference room, storeroom, sanitary compartment, or the like, into a public corridor (that is not fire-isolated) or open plan public space or the like within the building, or a non-fire-isolated stairway or ramp serving as a required exit; or
- opening from one public corridor into another public corridor or public space within the building.

A doorway or door in a path of travel to an exit is any door, excluding cupboards and service openings, that a building occupant must pass through to reach the exit from the storey.

Aged care buildings— D2.19(a)

D2.19(a) applies to all doorways in resident use areas of Class 9c aged care buildings, including doorways in paths of travel to an exit, doorways serving as required exits and doorways forming part of required exits.

Doorways within resident use areas of an aged care building must not be provided with revolving doors, roller shutter doors, tilt up doors or sliding fire or smoke doors. These types of door can impede the movement of residents and also hinder egress from the building.

Required exits and patient care areas

D2.19(b) applies only to doorways serving as a required exit, or forming part of one, and to doorways in a patient care area of a Class 9a building.

D2.19(b) does not apply to any other doorways (eg a doorway within a path of travel to an exit).

Revolving, sliding or tilt-up doors and roller shutters—D2.19(b)(i), (ii) and (iii)

Under **D2.19(b)(i), (ii) and (iii)**, revolving, sliding or tilt-up doors and roller shutters are either prohibited or limited because of their potential to obstruct people evacuating. They can also pose problems if they fail in an emergency.

If people are impeded at a doorway, this can lead to congestion. In an extreme case, it can lead to the crushing of people as they wait for a door to open.

Concession for small Class 6–8 buildings—D2.19(b)(ii)(A)

The reason for the concession (subject to specified criteria) for roller shutters or tilt-up doors in small Class 6, Class 7 and Class 8 buildings is that the number of people in the area will be low. Note that this concession does not apply to revolving or sliding doors.

Power-operated doors—D2.19(b)(iv) and D2.19(c)

D2.19(b)(iv) sets out the requirements for power-operated doors in required exits and patient care areas.

D2.19(c) applies to power-operated doors in a path of travel to a required exit. It applies the same provisions for power-operated doors in exits or forming part of an exit contained in **D2.19(b)(iv)(A)** by specifying the maximum force required to open the door if there is a malfunction or power failure. The reason for this is that a door in a path of travel may also inhibit safe egress if it cannot be readily opened.

Sliding door opening force

The reference in **D2.19(b)(iii)(B)** and **(iv)(A)** to a force of 110 newtons is to a relatively small force which most people, including the elderly and the young, could reasonably be expected to use to open a door.

D2.20 Swinging doors

Intent
To minimise the risk that a door may obstruct a person evacuating.

D2.20 and **D2.19** have the same intent

D2.20 should be read in conjunction with **D2.19** because its intent is the same.

Required exits

D2.20 applies only to swinging doors in doorways serving as a required exit or forming part of a required exit (eg a doorway leading to, or within a fire-isolated exit). It does not apply to other doorways (eg a doorway within a path of travel to an exit).

Egress and the swing of a door—D2.20(a)

Under **D2.20(a)**, egress from a required exit must not be impeded by the swing of a door.

The measurement of the clear width for the safe passage of people evacuating must include any door furniture, such as a door handle.

Doors into a fire-isolated exit are permitted to encroach more than 500 mm as long as they do not impede the path of travel of people already in the exit.

Figure D2.20 illustrates a method of compliance with **D2.20(a)**.

Door must swing in the direction of egress—D2.20(b)

Under **D2.20(b)**, doors are required to swing in the direction of egress to aid evacuation. If a door swings against the direction of egress, the first person to it may not be able to open it because of the pressure of the other people behind them. This could delay evacuation.

Concession for small buildings or parts of buildings

D2.20(b) provides a concession (under specified criteria) for small buildings or parts of buildings. The reason for allowing a door to swing against the direction of travel in such buildings is because the number of people likely to use the door will probably be low. This in turn minimises the risk caused by delays induced by opening a door towards the person attempting to gain egress.

D2.20(b)(i) requires these doors that swing against the direction of egress to be fitted with a device for holding the door in the open position. **D2.20(b)(i)** does not require the door to be fixed in the open position at all times that the building is legally occupied. Although this may be desirable, because of climatic conditions, the weather conditions on a particular day, or for security reasons it may not be possible or desirable for the occupants.

Hindrance—D2.20(c)

Under **D2.20(c)**, swinging doors must not hamper occupants evacuating.

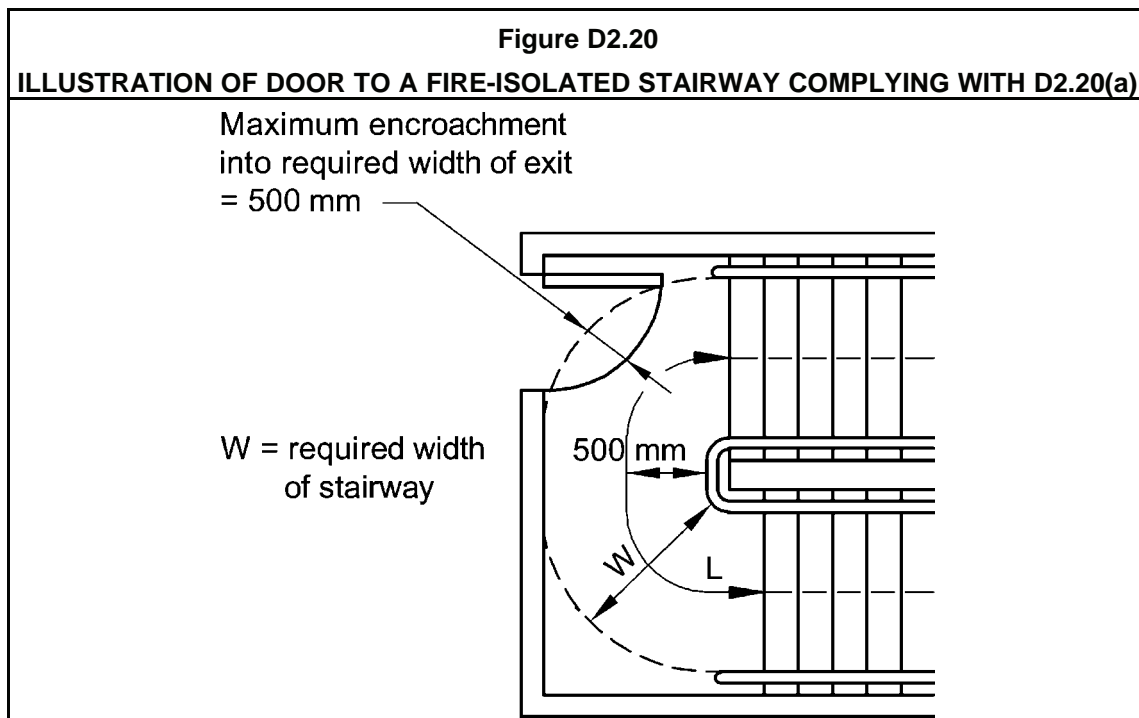

D2.21 Operation of latch

Intent

To minimise the risk that evacuation will be delayed by the operation of a door latch.

Application

D2.21 applies to all doors:

- in a required exit (eg an external doorway leading from the building);
- forming part of a required exit (eg a door leading to or within a fire-isolated exit); and
- in a path of travel to a required exit.

“Single hand downward action”

If the opening action of a door latch cannot be a pushing action, it must be a single downward action, capable of being activated with a single hand.

D2.21 prohibits the use of devices such as deadlocks and knobs (where the knobs must be operated in a twisting or similar motion).

This provision takes account of the need for an emergency opening mechanism to be operable by people with a hand or arm related disability, burns to their hands, or with perspiring or wet hands.

The height of the opening device from the floor specified in **D2.21** is consistent with that contained in AS 1428.1 “Design for Access and Mobility”. This is a comfortable height for most people to use.

Ease of egress versus security

The building regulatory system principally exists to protect the safety, health and amenity of people in buildings. The safety of property, while important, is generally considered to be a secondary matter. **D2.21** is designed to maximise the safety of people and prevent them being trapped within a building during a fire.

The risks to people using the building are too great to allow for the use of property security devices, such as deadlocks. Even “after hours” locks, which require human intervention (such as unlocking first thing in the morning and locking last thing at night) to allow egress during times when the public are accessing the building, are not considered to be adequately safe.

D2.21 exceptions

There are several exceptions to **D2.21(a)**. These include:

- **D2.21(a)(i)**—strongrooms and vaults, both for security purposes, and the fact that the general public would ordinarily be very unlikely to access such places;
- **D2.21(a)(ii)(A)**—sole-occupancy units within flats, because the people in the units will generally be in possession of keys to unlock the door;
- **D2.21(a)(ii)(B)**—sole-occupancy units within motels or hotels, because the people in the units will generally be in possession of keys to unlock the door. However this sub-clause does not include the entrance door to sole-occupancy units in boarding-houses, guest houses, hostels, lodging-house or backpackers accommodation as the occupant may not always have possession of keys to unlock the door;
- **D2.21(a)(ii)(C)**—small sole-occupancy units in Class 5–8 buildings, where it would be difficult to overlook the presence of anyone at closing time; and
- **D2.21(a)(ii)(D)**—restricted access spaces and rooms otherwise inaccessible to people at all times, such as cleaners’ rooms and the like.

Special security arrangements—D2.21(a)(iii)

D2.21(a)(iii) provides for special arrangements to be made where particular security issues arise. If this option is taken, the appropriate authority will need to be satisfied that, in the event of an emergency, access to exits will be enabled immediately with effectively no time delay.

Where the option for human control is exercised under **D2.21(a)(iii)(B)**, the person controlling the unlocking system **MUST** be available at ALL times. It is not acceptable for the system to be left uncontrolled. Nor is it acceptable for that person to be absent from the control post while carrying out any other work duties. A beeper or some other type of personally carried device warning of an emergency is not adequate to effect immediate opening of the locked doors. If the controlling person is absent for any reason, there must be a process enabling their relief by an equally trained person.

Fail-safe devices—D2.21(a)(iv)

D2.21(a)(iv) provides an exemption for buildings fitted with automatic “fail-safe devices”, where the devices are activated by another active system.

In this case, the appropriate authority must be satisfied that:

- the device is genuinely “fail-safe” (while not specifically referenced in **D2.21(a)(iv)**, this would include during power failures); and
- in the event of an emergency, access to exits will be enabled immediately, with effectively no time delay.

Examples

After hours shop security may be of considerable importance, and a “fail-safe” option may be preferable to the alternative.

A special accommodation house or an institution may have residents who may be inclined to “wander”, and a “fail-safe” option may be preferable to the alternative.

D2.21 and Class 9b buildings—D2.21(b)

Egress from Class 9b buildings is a complex issue. They are often accessed by the general public, and include buildings which have people unfamiliar with their surroundings. This environment is not conducive to orderly or easy evacuation especially in places such as cinemas, theatres, sporting complexes and nightclubs.

D2.21(b) makes special provision for those which accommodate more than 100 people.

D2.21(b) differs from the usual **D2.21** provisions in that:

- it prohibits the use of a door handle type opening device (other than a bar) or other device (including levers or knobs) requiring more than a pushing action; and
- it applies to only one door leaf of a two-leaf door set. However, the other door must also swing open if it is needed to satisfy the required width of egress.

The provisions of **D2.21(b)** do not apply to schools, early childhood centres, or buildings such as churches, mosques and temples used for religious purposes. Such buildings must comply with **D2.21(a)**.

Schools and early childhood centres are excepted because:

- the occupants are under almost constant adult supervision;
- most schools have a communication system with which occupants are familiar;
- most occupants are adequately controlled enabling easier evacuation; and
- they are used during daylight hours, and door handles and their function are more easily identified and familiar to occupants.

Testing of fire door furniture

Required fire doors must be tested as a complete unit, including the frame and furniture. The test on a fire door installed in an exit, or forming part of an exit, includes the opening devices to be used to comply with **D2.21**.

D2.22 Re-entry from fire-isolated exits

Intent

To minimise the risk that a person becomes trapped in a fire-isolated exit.

Facilitate entry to another exit route

It is not unknown for a fire-isolated exit to become unusable during an emergency. In high-rise buildings, hospitals and Class 9c aged care buildings people must be able to leave the exit and proceed to an alternative exit to evacuate. It is unlikely that the second exit will also be unusable.

One option is for a person in a fire-isolated stairway to enter a storey and gain access to the alternative exit through that storey.

D2.22(a)(iii) applies to the whole fire-isolated exit serving a storey above an effective height of 25 m. This means that a fire-isolated exit serving a storey below an effective height in a building with an effective height 25 m or greater, is treated the same as one in a building with an effective height of less than 25 m, provided it does not also serve a storey that is located above an effective height of 25 m.

It should be noted that if a fire-isolated passageway serves two stairways, one of which serves a storey above an effective height of 25 m, then **D2.22(a)(iii)** will apply, i.e. the doors cannot be locked from the inside.

Example

Consider a building consisting of a 5 storey podium and a main tower with an effective height of 25 m. Any fire-isolated stairway and associated fire-isolated passageway serving the tower must not have doors locked from within the exit. However, because the storeys in the podium are below an effective height of 25 m, any fire-isolated stairway and associated fire-isolated passageway that only serves those storeys may have a door locked from within the exit.

See [Figure D2.22](#).

Figure D2.22 ILLUSTRATION OF EXITS SERVING STOREYS ABOVE AND BELOW AN EFFECTIVE HEIGHT OF 25 M

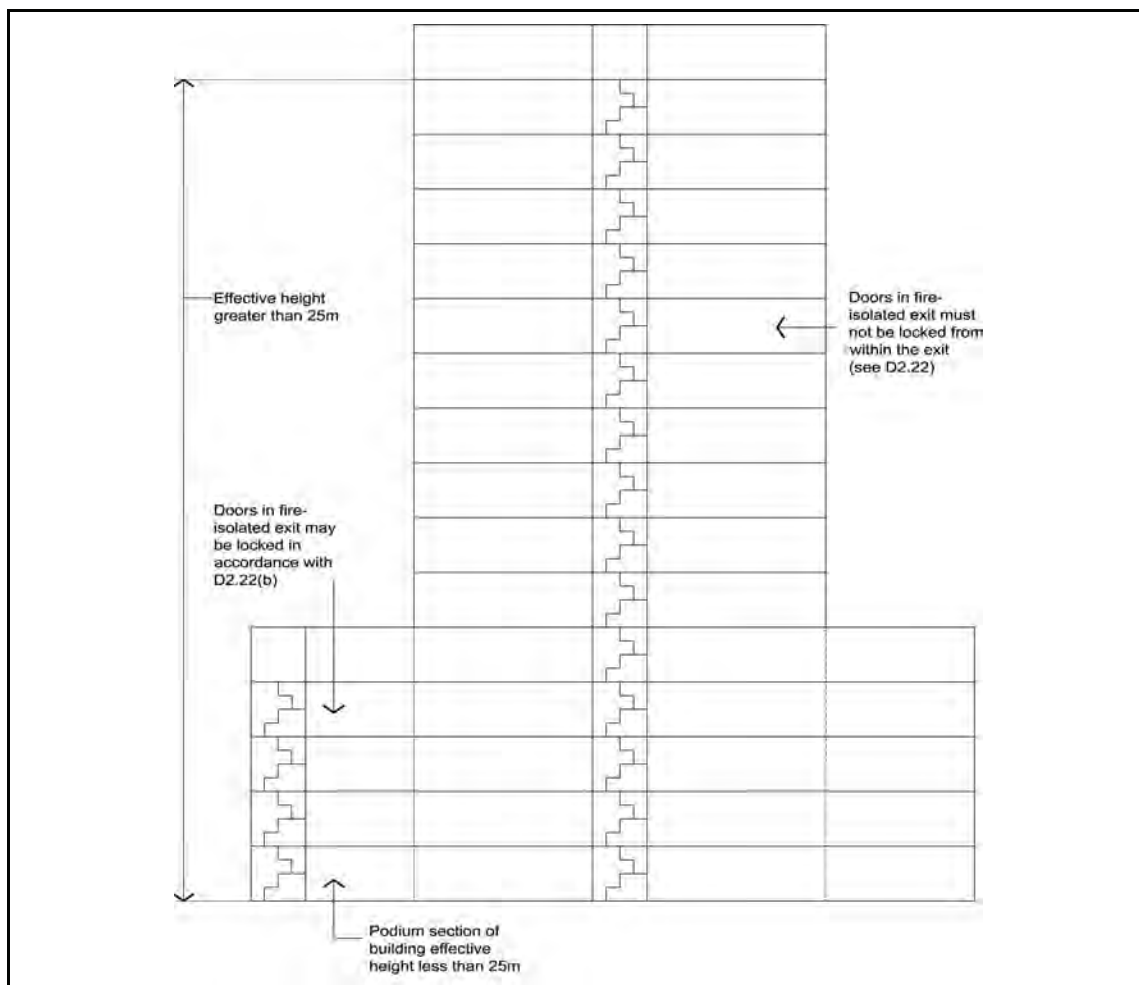

Mistaken entry

Under normal conditions of use, it is also possible that a person may mistakenly enter a fire-isolated exit. That person should not be required to travel all the way down the stairway to be able to leave it, especially in a high-rise or Class 9c aged care building.

Every fourth storey re-entry

The ability to enter at each floor of a building could be unnecessary and lead to a breach of a building's security. Accordingly, entry at every fourth floor (under [D2.22\(b\)\(i\)](#)) will achieve the intent of this provision, without significantly interfering with the building's security. Where this option is taken, all doors must be operable by a fail-safe device activated by a fire alarm.

Intercommunication systems

An alternative method of minimising the risk of a person being trapped in a fire-isolated stairway is to provide an intercommunication system under [D2.22\(b\)\(ii\)](#). Where this option is taken, all doors must be operable by a fail-safe device activated by a fire alarm.

D2.23 Signs on doors

Intent
To require the use of signs warning against impairing certain doors.

Blocked doors

The doors referred to in [D2.23\(a\)](#) are all required for evacuation in an emergency. Their obstruction could result in the death of people attempting to evacuate.

Open doors

Fire and smoke doors are designed to minimise the risk to people inside a fire compartment and a fire-isolated exit. A door kept open in a storey experiencing a fire could result in the emergency exit becoming unusable, or could aid the spread of fire and/or smoke to other parts of the building. If all exits are affected, people will have no way of evacuating the building.

PART **D3** ACCESS FOR PEOPLE WITH A DISABILITY

Objective

Functional Statements

Performance Requirements

The Objective, Functional Statements and Performance Requirements for **Section D** precede **Part D1**.

Deemed-to-Satisfy Provisions

D3.0 Deemed-to-Satisfy Provisions

Intent

To clarify that the requirements of **DP1** to **DP9** will be satisfied if compliance is achieved with Parts **D1**, **D2** and **D3** in the case of all buildings, Part **G3** in the case of buildings with an atrium, Part **H1** in the case of theatres, stages and public halls, and **Part H2** for public transport buildings.

See comments under **D1.0**. They apply here.

D3.1 General building access requirements

Intent

To specify when access for people with a disability must be provided to buildings and parts of buildings.

Extent of access within buildings

The extent of access required depends on the classification of the building. Buildings and parts of buildings must be accessible as set out in **Table D3.1** unless exempted by **D3.4**.

Class 1b buildings

While access requirements do not apply to Class 1a buildings (typically a detached house, town house or terrace house), they do apply to certain Class 1b buildings used for short-term holiday accommodation such as cabins in caravan parks, tourist parks, farm stay, holiday resorts and similar tourist accommodation. This accommodation itself is typically rented out on a commercial basis for short periods and generally does not require the signing of a lease agreement. Short-term accommodation can also be provided in a boarding house, guest-house, hostel, bed and breakfast accommodation or the like.

Where four or more dwellings used for short-term holiday accommodation on the same allotment are constructed or upgraded, a ratio of accessible dwellings is required. Where there is a newly constructed single Class 1b building, [Table D3.1](#) requires that access be provided to and within at least one bedroom, at least one of each type of room or space for use in common by residents, and to and within all rooms or spaces for use in common on floors served by a lift or accessible ramp.

Class 2 buildings

While the access provisions do not apply to the internal parts of sole-occupancy units, [Table D3.1](#) does require that the common areas on one floor containing sole-occupancy units and at least one of each type of common area such as a games room or gymnasium be accessible. Where a lift or accessible ramp serves other levels, common areas on the levels served must also be accessible. There is no requirement to make private areas provided for the exclusive use of a limited number of residents accessible. For example, a roof top tennis court or spa that is only available to the penthouse suite is not required to be accessible.

Class 3 buildings

[Table D3.1](#) requires that the common areas on one floor containing sole-occupancy units be accessible. Where a lift or accessible ramp serves other levels, common areas on the levels served must also be accessible. [Table D3.1](#) also requires access to be provided to at least one of each type of room or space used in common by the residents, such as TV lounges and dining rooms. For example, a two storey Class 3 building need not have the upper storey accessible so long as there is no unique room or space available to all residents on the upper storey and that upper storey is not served by a lift or accessible ramp.

A ratio of accessible sole-occupancy units is required. Where more than 2 accessible sole-occupancy units are required in a Class 3 building, they are to be representative of the range of rooms available, taking into account amenity and pricing. For example, in a large hotel required to have 10 accessible rooms, the rooms must be distributed to provide a variety of views, proximity to features and price ranges. No more than 2 accessible sole-occupancy units can be located adjacent to each other. When there is more than one accessible sole-occupancy unit, alternate left and right-handed sanitary facilities must be provided in the accessible sole-occupancy units. This ensures the availability of choice for people who, for example, need to transfer from a wheelchair from one side or the other.

Class 5, 6, 7b, 8 and 9a buildings

[Table D3.1](#) requires that access be provided to all areas within the building normally used by the occupants, with the exception of those areas that are exempted by [D3.4](#). The term “occupants” refers to any person using the building including visitors, employees, employers and owners.

Class 7a carpark

Access must be provided to any level containing accessible carparking spaces.

Class 9b buildings

Access must be provided to all areas normally used by the occupants with the exception of those areas that are exempted by **D3.4**. In an assembly building other than a school or an early childhood centre, access need not be provided to tiers or platforms containing seating areas if no wheelchair seating spaces are provided on those levels.

Wheelchair seating spaces must be provided in locations that are representative of the fixed seating locations provided. Wheelchair seating spaces must be located to take into account amenity, proximity to facilities, available sightlines and pricing. It would not be acceptable in a Class 9b building in which fixed seating is provided to have all wheelchair seating spaces provided in a single location. In the case of assembly buildings such as theatres and concert halls, areas used by the occupants include change rooms, offices, orchestra pits, stages or the like.

Some Class 9b buildings may be public transport buildings. The passenger use areas of these buildings may be subject to **Part H2** in addition to the general access provisions.

Class 9c buildings

The BCA access provisions and AS 1428.1 are focussed on the needs of people with a disability and not specifically aged persons. For this reason, the access provisions of AS 1428.1 have not been applied to all sole-occupancy units in Class 9c buildings but only to those specific rooms that are required to be provided for people with a disability. The extent of access to be provided in Class 9c aged care buildings is similar to that for Class 3 buildings.

Class 10 buildings

Certain Class 10a buildings such as a toilet block in a park, a public structure for the purpose of providing shelter, or change rooms associated with a sports field are required to be accessible if they are located in an accessible area. Generally, these facilities would be close to a carpark or at the beginning of a walkway. However, in some circumstances, a Class 10a building may be a considerable way into a nature walk where it may not be possible to provide an accessible path of travel. In such cases the Class 10a buildings need not be accessible.

Where a Class 10b swimming pool is a public pool such as a health centre pool, Council pool or a common use pool associated with a Class 3 building, and has a perimeter measured at the water's edge of more than 40 metres, **Table D3.1** requires at least one form of entry for people with a disability be provided. Methods for accessing a swimming pool can be found in **D3.10**.

Some Class 10 buildings may be public transport buildings (for example an open railway platform). The passenger use areas of these buildings may be subject to **Part H2** in addition to the general provisions.

D3.2 Access to buildings

Intent

To specify the extent of access for people with a disability that must be provided.

D3.2(a) requires accessways to be provided to accessible buildings from the main points of a pedestrian entry at the allotment boundary and from any accessible car parking space or accessible associated buildings connected by a pedestrian link.

In **D3.2(b)** the principal pedestrian entrance is to be accessible in all cases and not less than 50% of all pedestrian entrances, including the principal pedestrian entrance, are to be accessible. In buildings with a total floor area more than 500 m², an inaccessible entrance cannot be more than 50 m from an accessible entrance. This ensures that situations where

people have to travel an unreasonable distance between entrances are avoided. An entrance that serves only an area exempted by **D3.4** need not be accessible.

The principal pedestrian entrance is required to be accessible in all cases because it would be the most commonly used entrance by all building users. This is particularly important in public buildings where the principal entrance is often used as a focus for events or as a ceremonial entrance, particularly in hotels and theatres.

Designers should consider the proximity of ramps or lifting devices to stairs or steps at an entrance. People who require a ramp or lifting device at an entrance should not have to travel significantly greater distances to use the entrance than people without a disability.

Similarly, for convenience, the ramp or lifting device should be located as close as possible to any vehicular drop off point or taxi rank servicing a building entrance.

Where an entrance has multiple doorways, the BCA does not require all of them to be accessible:

- If an entrance doorway is manually operated, the minimum dimensions required to provide access must be provided by the opening of a single leaf, so that a person with a disability only has to negotiate their entry through one door leaf.
- If the doorway is automatically operated, the minimum dimension can be provided using two leaves.

D3.3 Parts of buildings to be accessible

Intent

To specify the requirements for accessways within buildings which must be accessible.

In most buildings, access is to be provided to all parts of the building normally used by the occupants with the exception of areas exempted by **D3.4**. However, it is not intended that access for people who use wheelchairs be provided within non-accessible sanitary facilities or non accessible sole-occupancy units.

Similarly, although stairways are not allowed on an accessway, they are allowed on other paths of travel. The specified provisions of AS 1428.1 provide technical information on how stairways and ramps are to be made safe and accessible for people with an ambulant disability or vision impairment. It is important to note that different requirements are specified for fire-isolated stairways and ramps and other stairways and ramps.

D3.3(c)(i) covers passing spaces on accessways to ensure that a person does not have to retrace their journey for an unreasonable distance to pass another person if the accessway is not sufficiently wide for passing to occur at any point. The minimum dimensions for a passing space are contained in AS 1428.1. Space for passing to occur need only be provided where there is not a direct line of sight to the end of the accessway.

D3.3(c)(ii) covers turning spaces on accessways to ensure that a person does not have to reverse for an unreasonable distance if they encounter a dead-end or need to retrace their journey. The minimum dimensions for a turning space are contained in AS 1428.1. Turning spaces are required within 2 metres of the end of an accessway if it is not possible to continue to travel along the accessway, and at least every 20 metres along an accessway whether or not there is a direct line of sight.

In **D3.3(d)** and **(e)** a passing space may also serve as a turning space and the circulation space required at an intersection of accessways is sufficient for passing or turning to occur. In this situation a dedicated passing or turning space would not be required at those locations.

Some storeys or levels, other than the entrance storey, in certain small buildings are not required by **D3.3(f)** to be provided with access via a passenger lift or a ramp complying with AS 1428.1. This exemption applies only to Class 5, 6, 7b and 8 buildings with 2 or 3 storeys (that is a building with 1 or 2 storeys in addition to the entrance level). This could be a building with 1 or 2 storeys above the entrance level or below it. The exemption states that if the size of each storey (other than the entrance level) is less than 200 m² access via a passenger lift or ramp complying with AS 1428.1 is not required to the other levels. However, if the entrance level to a 3 storey building was 600 m², the 1st storey was also 600 m² and the 2nd storey was only 150 m², access would be required via a passenger lift or ramp complying with AS 1428.1 to all levels. Even though access via a ramp or lift is not required to certain storeys or levels, all other accessible features required by the BCA, except accessible unisex sanitary compartments and accessible unisex showers (see **F2.4(i)**), are required on the non-entrance levels.

D3.4 Exemptions

Intent

To provide exemptions to the Deemed-to-Satisfy Provisions for access by people with a disability.

This provision provides details on buildings or parts of buildings not required to be accessible under the BCA. **D3.4** details exemptions to the requirements for access to certain areas within buildings where providing access would be inappropriate because of the nature of the area or the tasks undertaken. These areas could include rigging lofts, waste containment areas, foundry floors, loading docks, fire lookouts, plant and equipment rooms and other similar areas. Assessment of these areas is on a case-by-case basis.

While these areas are not required to be accessible nothing in the BCA prevents a designer from providing greater access than the required provisions, should they desire to do so.

D3.5 Accessible carparking

Intent

To clarify the minimum Deemed-to-Satisfy Provisions for accessible carparking.

Table D3.5 provides details of the number of accessible carparking spaces required in a carpark depending on the classification of the building and based on the ratio of the total number of carparking spaces provided. If the carpark serves a multi-classified building, the number of accessible carparking spaces required should be calculated by determining the number of spaces serving each of the classifications. The specifications for accessible carparking spaces, contained in AS 2890.6, aim to maximise the area available to people with a disability to get into and out of their vehicles. However;

- while at least one carparking space complying with AS 2890.6 is required in any carpark covered by **D3.5**, signage and markings designating an accessible carparking space are only required in a carpark with more than a total of 5 spaces; and
- accessible carparking spaces are not required in a carpark where carpark users do not park their own vehicles, such as a carpark that has a valet parking service.

The most appropriate location for the accessible car parking spaces will be, to some extent, determined by the use and function of the building. For example, a carpark associated with a cinema might have the accessible carparking spaces as close as possible to the main pedestrian entrance and ticketing area.

It may be more appropriate in a building with multiple pedestrian entrances, such as a shopping centre, to distribute accessible carparking spaces to ensure that the distance between the accessible car parking spaces and the entrances to the buildings are minimised.

D3.6 Signage

Intent

To assist people with a disability to easily identify the facilities, services and features provided in a building.

D3.6 provides requirements for signage in buildings required to be accessible by **Part D3**. Signage is only required by **Part D3** in particular situations.

D3.6(a) provides that all sanitary facilities, except those within a sole-occupancy unit of a Class 1b or Class 3 building, must have braille and tactile signage compliant with **Specification D3.6** and AS 1428.1. In addition, all accessible unisex sanitary facilities must have the international symbol of access and information on whether the facility allows for left or right handed transfer (**D3.6(c)**). Signage in accordance with AS 1428.1 must also identify any ambulant accessible sanitary facilities and must be located on the door of the ambulant accessible compartments.

Any space with a hearing augmentation system must have braille and tactile signage as well as the international symbol for deafness at the entry to the space.

D3.6(b) provides that signage including the international symbol for deafness in accordance with AS 1428.1 must be provided in a room with a hearing augmentation system. The signage must indicate the type of hearing augmentation, and the area of the room covered. Signage must also indicate if receivers are used in the room, and where they may be obtained if this is the case.

D3.6(e) and **D3.6(f)** provide that directional information including the international symbol of access must be provided at any pedestrian entrance that is not accessible or a bank of sanitary facilities that does not include a unisex accessible sanitary facility. The directional information must identify where the nearest accessible entrance or accessible sanitary facility can be found.

D3.7 Hearing augmentation

Intent

To assist people with a hearing impairment to be made aware of communications associated with a building's use.

D3.7 provides requirements for provision of hearing augmentation systems in accessible buildings. There are a number of hearing augmentation systems available. A decision on which system to use will depend on a number of factors, such as the size and use of the space, external interferences and building materials used.

Hearing augmentation coverage is not required to 100% of the floor area of rooms because such coverage could spill over into adjoining rooms and affect the operation of the system installed in those rooms, and because design considerations such as interference and building design mean that it is difficult to ensure complete coverage in any room.

D3.7(a) provides that hearing augmentation systems must be provided where an inbuilt amplification system is provided (other than one only used for emergency warning) in a room in a Class 9b building, in certain types of rooms such as auditoriums, conference rooms, and at

ticket offices, teller's booths, reception areas and similar areas where the public is screened from the service provider.

D3.7(b) sets out requirements for hearing augmentation systems where they are required under **D3.7(a)**. Requirements for hearing augmentation can be met by use of either an induction loop, or the use of receivers or similar systems. Where an induction loop is provided, it must cover at least 80% of the floor area of the room or space that is served by the inbuilt amplification system.

For hearing augmentation systems using audio receivers, the system must cover at least 95% of the floor area of the room or space served by the inbuilt system, and a minimum number of receivers must be provided in a ratio depending on the number of people who may be accommodated in the room (calculated by reference to **D1.13**).

D3.7(d) provides that screens or scoreboards associated with a Class 9b building that are capable of displaying public announcements must be capable of supplementing any public address system (other than a public address system used for emergency warning purposes only).

D3.8 Tactile indicators

Intent

To assist blind or vision impaired people to avoid hazardous situations.

Warning Tactile Ground Surface Indicators (TGSIs) are intended only to be used for specific hazard identification in those areas identified within **D3.8**. This includes:

- at the top and bottom of stairways, escalators and ramps except those only leading to areas exempted under **D3.4**; and
- where there is an overhead obstruction less than 2 m above the floor along the pathway, in the absence of a suitable barrier that would prevent a person from hitting the overhead obstruction.

D3.8(c) permits raised dome buttons on handrails as an alternative in some aged care buildings. The reason for the alternatives in aged care buildings is that ground surface indicators may hinder people using walking frames or the like.

Note that TGSIs are not required on enclosed landings between flights of stairs where no other entrance/exit leads onto/off the landing.

The specifications for TGSIs are contained in sections 1 and 2 of AS 1428.4.1.

D3.9 Wheelchair seating spaces in Class 9b assembly buildings

Intent

To specify the requirements for wheelchair seating spaces in Class 9b assembly buildings.

D3.9 provides requirements for the provision of wheelchair seating spaces in Class 9b assembly buildings. This includes the number of wheelchair seating spaces to be provided in theatres, cinemas and the like, their positioning within the general seating area and how they are to be grouped with other seats or wheelchair spaces. The dimensions of wheelchair seating spaces must comply with AS 1428.1.

Table D3.9 provides requirements relating to the number and permissible grouping of wheelchair seating spaces, depending on the number of fixed seats in the room or space.

Grouping all wheelchair spaces together potentially limits the seating options for family or friends accompanying a person using a wheelchair, so requirements are included that spaces be provided both singly and in groups. Wheelchair seating spaces may be provided by having removable seats so that, if the wheelchair spaces are not required, seats for other patrons can be installed in those locations. However, building managers would need to ensure that management practices in relation to removable seating do not discriminate.

D3.9(b) imposes additional requirements on wheelchair seating spaces in cinemas. In cinemas of less than 300 seats, wheelchair seating spaces must not be provided in the front row of seats. In cinemas with more than 300 seats, not less than 75% of required wheelchair seating spaces must be located in rows other than the front row. The location of wheelchair seating spaces must be representative of the range of seating provided.

D3.10 Swimming pools

Intent

To specify the requirements for accessible swimming pools.

D3.10 provides the requirements for making swimming pools accessible to people with a disability. Swimming pools, required by **Table D3.1** to be accessible, must provide not less than one means of accessible water entry and exit in accordance with **Specification D3.10**.

Table D3.1 requires that swimming pools with a perimeter greater than 40 m be accessible if they are associated with a building required to be accessible. Private swimming pools are not required to be accessible.

D3.10(b) provides the means by which accessible water entry and exit may be provided. **D3.10(c)** provides that where a swimming pool has a perimeter of more than 70 m, entry must be provided by at least one of the following: a fixed or movable ramp and an aquatic wheelchair, a zero depth entry and an aquatic wheelchair, or a platform style swimming pool lift and an aquatic wheelchair. Accordingly, only swimming pools of less than 70 m in perimeter may provide a sling-style swimming pool lift as the sole means of water entry and exit.

Under **D3.10(d)** latching devices on gates and doors which form part of a swimming pool safety barrier need not comply with AS 1428.1.

D3.11 Ramps

Intent

To specify the requirements for ramps forming part of an accessway.

Ramps may be used as part of an accessway where there is a change in level. The ramp must comply with the requirements specified in AS 1428.1 including a maximum gradient, landings, TGSIs, handrails and kerbing, as appropriate for the type of ramp.

A ramp cannot be used on an accessway to connect one level to another if the vertical rise is greater than 3.6 metres. This is to ensure that the ramp does not cause undue fatigue for a user to the point where the ramp becomes unusable.

Where a ramp is installed on a path of travel used solely for servicing an area exempted under **D3.4** the requirements of AS 1428.1 are not mandatory.

D3.12 Glazing on an accessway

Intent

To specify the requirements for glazing within an accessway.

This provision requires there to be a contrasting strip, chair rail, handrail or transom across all frameless or fully glazed doorways and surrounding glazing capable of being mistaken for an opening. The purpose of this requirement is to assist a person who has a vision impairment to be able to identify the presence of the glazing and avoid injury caused by contact with the glazing. A contrasting strip with a series of dots, unconnected patterns or shapes that do not provide high levels of contrast would not meet the requirements of this provision.

SPECIFICATION **D1.12** NON-REQUIRED STAIRWAYS, RAMPS
AND ESCALATORS

Deemed-to-Satisfy Provisions

This Guide does not address every provision in this Specification. However, there are more comments which should be made:

Purpose of Specification D1.12

Specification D1.12 establishes requirements for the construction and installation of stairways, ramps and escalators not required by the BCA, and which are not fire-isolated. These requirements aim to prevent the spread of fire through an unrestricted number of floors through unprotected openings for stairways, ramps and escalators.

Consistency with atrium requirements

Specification D1.12 is consistent with the provisions of Part **G3**, which, without imposing additional requirements, allows an atrium to connect two non-sprinkler protected storeys or three sprinkler protected storeys.

Need for fire shaft

There does not yet appear to be a practical method of applying this Specification without the construction of a fire shaft. Such a shaft provides the necessary fire separation between the floors. Its construction is similar to that of a fire-isolated stairway shaft.

SPECIFICATION **D3.6** BRAILLE AND TACTILE SIGNS

Deemed-to-Satisfy Provisions

1 Scope

Intent

To clarify that [Specification D3.6](#) provides the design and installation details for braille and tactile signs.

2 Location of braille and tactile signage

This clause provides requirements for the location of braille and tactile signs. The correct placement of braille and tactile signs is important in ensuring that they are able to be used. [Clause 2](#) describes where required signs are to be located accounting for the range of a person's reach and sight lines. Where possible, signs are not to be placed on doors, to avoid the hazard of a door being opened onto a person attempting to read the sign.

3 Braille and tactile sign specification

[Clause 3](#) provides specifications for braille and tactile signs to ensure a consistent approach is used and to ensure that the signage is usable.

4 Luminance contrast

[Clause 4](#) provides requirements for luminance contrast for braille and tactile signs. Luminance contrast is the amount of light reflected from one surface or component, compared to the amount of light reflected from the background or surrounding surfaces. Specifying a minimum luminance contrast between signs and the surface they are mounted on and between a sign and its characters, assists people with a vision impairment in finding and accessing information on signs.

5 Lighting

[Clause 5](#) provides that sufficient illumination of signs must be available to ensure that the level of luminance contrast is achieved at times when the sign is required to be read.

6 Braille

[Clause 6](#) provides specifications for braille used on signs to ensure that signage is consistent and usable.

SPECIFICATION **D3.10** ACCESSIBLE WATER ENTRY/EXIT FOR SWIMMING POOLS

Deemed-to-Satisfy Provisions

1 Scope

Intent

To clarify that **Specification D3.10** provides the design and installation details for accessible water entry/exit for swimming pools. **Specification D3.10** must be read in conjunction with **D3.10**.

2 Fixed or moveable ramp

Clause 2 provides specifications for fixed and moveable ramps, which are allowed as a method of water entry and exit by **D3.10(b)(i)**, in conjunction an aquatic wheelchair as described in **Clause 6**.

3 Zero depth entry

Clause 3 provides specifications for zero depth entries, which are allowed as a method of water entry and exit by **D3.10(b)(ii)**, in conjunction with an aquatic wheelchair as described in **Clause 6**. The term 'zero depth entry' is used to describe entry into a pool that provides a gentle gradient into the water not exceeding 1:14.

4 Platform swimming pool lift

Clause 4 provides specifications for platform swimming pool lifts, which are allowed as a method of water entry and exit by **D3.10(b)(iii)**, in conjunction with an aquatic wheelchair as specified in **Clause 6**. A platform swimming pool lift consists of a platform onto which an aquatic wheelchair is wheeled. The platform is then raised, positioned over the water and then lowered into the water.

5 Sling-style swimming pool lift

Clause 5 provides specifications for sling-style swimming pool lifts, which are allowed as a method for water entry and exit by **D3.10(b)(iv)**, but which may only be the sole method of water entry for swimming pools with a perimeter of less than 70 m (**D3.10(c)**). A sling-style swimming pool lift is used to assist in transferring a person directly from their wheelchair. The person in the wheelchair may position themselves into the sling when detached from the lifting device. This allows the person to transfer by the poolside or in the privacy of a changing area. The sling is then attached to the lifting device and the person is transferred into the pool without their wheelchair.

6 Aquatic wheelchair

Clause 6 provides specifications for aquatic wheelchairs to ensure their suitability for use for water entry and exit. An aquatic wheelchair is used in conjunction with a fixed or movable ramp, a zero depth entry and a platform swimming pool lift. An aquatic wheelchair is designed to be used and immersed in water and is usually constructed of plastic or a similar material that does not react adversely when exposed to water.

SERVICES AND EQUIPMENT

- E1** **Fire Fighting Equipment**
- E2** **Smoke Hazard Management**
- E3** **Lift Installations**
- E4** **Emergency Lighting, Exit Signs and Warning Systems**

SECTION E CONTENTS

SECTION E SERVICES AND EQUIPMENT

PART E1 Fire Fighting Equipment

- Objective EO1
- Functional Statement EF1.1
- Performance Requirements EP1.1 - EP1.6
- E1.0 Deemed-to-Satisfy Provisions
- E1.1 * * * * *
- E1.2 * * * * *
- E1.3 Fire hydrants
- E1.4 Fire hose reels
- E1.5 Sprinklers
- E1.6 Portable fire extinguishers
- E1.7 * * * * *
- E1.8 Fire control centres
- E1.9 Fire precautions during construction
- E1.10 Provision for special hazards
- Specification E1.5 Fire Sprinkler Systems
- Specification E1.8 Fire Control Centres

PART E2 Smoke Hazard Management

- Objective EO2
- Functional Statement EF2.1
- Performance Requirements EP2.1 - EP2.2
- E2.0 Deemed-to-Satisfy Provisions
- E2.1 Application of Part
- E2.2 General requirements
- E2.3 Provision for special hazards
- Specification E2.2a Smoke Detection and Alarm Systems
- Specification E2.2b Smoke Exhaust Systems
- Specification E2.2c Smoke-and-Heat Vents

PART E3 Lift Installations

- Objective EO3
- Functional Statements EF3.1 - EF3.3
- Performance Requirements EP3.1 - EP3.4
- E3.0 Deemed-to-Satisfy Provisions
- E3.1 * * * * *
- E3.2 Stretcher facility in lifts
- E3.3 Warning against use of lifts in fire
- E3.4 Emergency lifts
- E3.5 Landings
- E3.6 Passenger lifts
- E3.7 Fire-service controls
- E3.8 Aged care buildings

Part E4 Emergency Lighting, Exit Signs and Warning Systems

Objective EO4

Functional Statement EF4.1

Performance Requirements EP4.1 - EP4.3

E4.0 Deemed-to-Satisfy Provisions

E4.1 * * * * *

E4.2 Emergency lighting requirements

E4.3 Measurement of distance

E4.4 Design and operation of emergency lighting

E4.5 Exit signs

E4.6 Direction signs

E4.7 Class 2 and 3 buildings and Class 4 parts: Exemptions

E4.8 Design and operation of exit signs

E4.9 Sound systems and intercom systems for emergency purposes

PART E1 FIRE FIGHTING EQUIPMENT

Objective

EO1

Fire in buildings

If a fire occurs in a building it must not endanger evacuating occupants or spread to another building.

Facilities to fight a fire in its early stages

Simple and lightweight equipment allows occupants to attack a fire during its early stages. Provision of this equipment often helps occupants to either extinguish or limit the development of a fire before the fire brigade arrives.

Facilities to assist the fire brigade

To assist in stopping or limiting the spread of fire, facilities must be provided to assist the fire brigade.

Functional Statement

EF1.1

Suitable facilities to be installed

Suitable facilities may need to be installed in a building to minimise the risk of fire spread to:

- enable occupants to evacuate;
- enable occupants and the fire brigade to fight the fire and for the fire brigade to undertake rescue operations;
- minimise the damage which could result from fire spreading to other parts of the building or other buildings.

Facilities may be manually or automatically operated, and include: fire hydrants; fire hose reels; sprinkler systems; portable fire extinguishers.

Buildings may incorporate a fire-control centre.

Performance Requirements

EP1.1

Fire hose reels

Fire hose reels in buildings allow occupants to fight a fire. The fire may be in its infancy, and early control or extinguishment may reduce the hazard, allow more time for evacuation and prevent structural damage.

“To the degree necessary”

See the explanation of this term in [A1.7](#).

Criteria for fire hose reels

As set out in [EP1.1](#), fire hose reels must be installed when necessary, and be appropriate to a number of factors, including:

- the size of the fire compartment which is a measure of the size of any potential fire;
- the function of the building will affect the fire load in the building;
- the fire-safety systems which can affect the rate of fire spread (eg if a sprinkler system is installed in a building, it should extinguish the fire or reduce its growth rate); and
- the fire hazard which means the danger in terms of potential harm and degree of exposure arising from the start and spread of fire, and the smoke and gases generated by a fire.

Deemed-to-Satisfy Provisions

[E1.4](#) provides a number of examples where fire hose reels must be installed if the proposal being considered involves a Building Solution which uses the Deemed-to-Satisfy Provisions.

Alternative Solutions

If an Alternative Solution is used, it may be appropriate to assess it using [E1.4](#) for guidance purposes. However, it is stressed that compliance with [E1.4](#) is not compulsory if alternative means can be found to satisfy the appropriate authority that the Performance Requirements will be achieved.

EP1.2

Fire extinguishers

Fire extinguishers in buildings allow occupants to fight fires. Extinguishment may complete all the functions listed in [EP1.1](#) above.

Fire extinguishers should be located in plain view, along normal paths of travel and near exits where possible. They should not be located in hazardous places.

“To the degree necessary”

This expression’s use in [EP1.2](#) indicates that the BCA recognises that not all buildings need fire extinguishers; and fire extinguishers are used for specific purposes, as set out in AS 2444.

Any decision made in this context can extend to not requiring an item to be installed or a particular level of performance to be achieved, if that is the appropriate action to be taken.

Criteria for fire extinguishers

As set out in **EP1.2**, fire extinguishers must be installed when necessary, and be appropriate to a number of factors, including:

- the function or use of the building will affect the fire load in the building;
- the fire-safety systems in the building which can affect the rate of fire spread (eg if a sprinkler system is installed in a building, it should extinguish the fire or reduce its growth rate); and
- the fire hazard which means the danger in terms of potential harm and degree of exposure arising from the start and spread of fire, and the smoke and gases generated by a fire.

Deemed-to-Satisfy Provisions

Table E1.6 provides a number of examples where fire extinguishers must be installed if the proposal being considered involves a Building Solution which uses the Deemed-to-Satisfy Provisions.

Alternative Solutions

If an Alternative Solution is being used, it may be appropriate to assess it using **Table E1.6** for guidance purposes. However, it is stressed that compliance with **Table E1.6** is not compulsory if alternative means can be found to satisfy the appropriate authority that the Performance Requirements will be achieved.

EP1.3

Fire hydrants

The intent of installing a fire hydrant system is to provide adequate water, under sufficient pressure and flow, to allow the fire brigade to fight fires.

Under its Application provision, **EP1.3** only applies to buildings located in an area serviced by a fire brigade. This is primarily because the pressures and flows from a fire hydrant are such that hydrants should only be used by the fire brigade.

It is expected that designers will meet any special fire brigade requirements, which may cover such matters as the types of couplings and special flows and pressures to suit a particular nozzle.

“To the degree necessary”

The use of the expression “to the degree necessary” in **EP1.3** indicates that the BCA recognises that not all buildings need fire hydrants.

Any decision made in this context can extend to not requiring an item to be installed or a particular level of performance to be achieved, if that is the appropriate action to be taken.

Criteria for fire hydrant systems

As set out in **EP1.3**, a fire hydrant system must be installed when necessary, and be appropriate to a number of factors, including:

- the need to meet the requirements of the local fire brigade (because of the pressures and flows), fire hydrants should only be used by the fire brigade;
- the floor area of the building which is a measure of the size of any potential fire; and
- the fire hazard which means the danger in terms of potential harm and degree of exposure arising from the start and spread of fire, and the smoke and gases generated by a fire.

Deemed-to-Satisfy Provisions

E1.3 provides a number of examples where fire hydrants must be installed if the proposal being considered involves a Building Solution which uses the Deemed-to-Satisfy Provisions.

Alternative Solutions

If an Alternative Solution is used, it may be appropriate to assess it using **E1.3** for guidance purposes. However it is stressed that compliance with **E1.3** is not compulsory if alternative means can be found to satisfy the appropriate authority that the Performance Requirements will be achieved.

EP1.4

EP1.4 is not limited to sprinkler systems

A sprinkler system is only one type of automatic fire suppression system. **EP1.4** is not limited to sprinkler systems. If it can be demonstrated that another automatic fire system can control the development and spread of a fire, it may comply with **EP1.4**. Its activation must be “automatic” and must not depend on human intervention.

Life safety and fire suppression

Automatic fire suppression systems, such as sprinkler systems, are normally used in a building to contain and extinguish fire. When an automatic fire suppression system operates, it not only controls or limits the fire development, but statistics show that, in most cases, the fire is extinguished before the fire brigade arrives at the building.

An automatic fire suppression system is regarded as part of a building’s life safety package because:

- if the system extinguishes the fire before it fully develops, the fire will not endanger the occupants; and
- if the system limits or controls the spread of a fire, it allows occupants more time to evacuate to a safe place.

“To the degree necessary”

The use of the expression “to the degree necessary” in **EP1.4** indicates that the BCA recognises that not all buildings need an automatic fire suppression system.

Any decision made in this context can extend to not requiring an item to be installed or particular level of performance to be achieved, if that is the appropriate action to be taken.

Criteria for automatic fire suppression systems

As set out in **EP1.4**, an automatic fire suppression system, such as a sprinkler system, must be installed when necessary, and be appropriate to a number of factors.

When implementing, the likely size and intensity of a fire should be taken into consideration. This can be as measured by:

- the size of the fire compartment which is a measure of the size of any potential fire;
- the function or use of the building will affect the fire load in the building;
- the fire hazard which means the danger in terms of potential harm and degree of exposure arising from the start and spread of fire, and the smoke and gases generated by a fire; and

- the height of the building, because once a building gets above a certain height it becomes extremely difficult (and eventually impossible) for the fire brigade to undertake external rescue or firefighting from ladders and the like. The height also affects evacuation time.

Deemed-to-Satisfy Provisions

E1.5 provides a number of examples where a sprinkler system must be installed if the proposal being considered involves a Building Solution which uses the Deemed-to-Satisfy Provisions.

Alternative Solutions

If an Alternative Solution to the Deemed-to-Satisfy Provisions in Part **E1** is being used, it may be appropriate to assess it using **E1.5** for guidance purposes. However, it is stressed that compliance with **E1.5** is not compulsory if alternative means can be found to satisfy the appropriate authority that the Performance Requirements will be achieved.

EP1.5

Firefighting services in buildings under construction

A fire in a building under construction represents a significant public safety, health and amenity risk. Accordingly, there is a need for firefighting in such buildings.

This Performance Requirement recognises the fact that a significant number of fires occur in buildings during their construction or major refurbishment. Statistics indicate that a number of fires have been started by sparks. The fire has then spread because services were turned off for construction purposes.

“To the degree necessary”

The use of the expression “to the degree necessary” in **EP1.5** indicates that the BCA recognises that not all buildings need firefighting services during construction.

Any decision made in this context can extend to not requiring an item to be installed or a particular level of performance to be achieved, if that is the appropriate action to be taken.

Criteria for firefighting services in buildings under construction

As set out in **EP1.5**, firefighting services must be installed in buildings under construction when necessary, and must be appropriate to a number of factors, including:

- the fire hazard which means the danger in terms of potential harm and degree of exposure arising from the start and spread of fire, and the smoke and gases generated by a fire; and
- the height the building has reached during its construction which is a measure of the extent to which the fire brigade can fight any fire from the outside of the building.

Deemed-to-Satisfy Provisions

E1.9 provides a number of examples where firefighting services must be installed if the proposal being considered involves a Building Solution which uses the Deemed-to-Satisfy Provisions.

Alternative Solutions

If an Alternative Solution to the Deemed-to-Satisfy Provisions in Part **E1** is being used, it may be appropriate to assess it using **E1.9** for guidance purposes. However, it is stressed that compliance with **E1.9** is not compulsory if alternative means can be found to satisfy the appropriate authority that the Performance Requirements will be achieved.

EP1.6

Fire control centres

EP1.6 requires that a part of a building be set aside for the fire brigade to co-ordinate its search and rescue, and firefighting operations during a fire. These areas are referred to as “fire control centres”.

“To the degree necessary”

The use of the expression “to the degree necessary” in **EP1.6** indicates that the BCA recognises that not all buildings need a fire control centre.

Any decision made in this context can extend to not requiring an item to be installed or a particular level of performance to be achieved, if that is the appropriate action to be taken.

Criteria for co-ordination facilities

As set out in **EP1.6**, co-ordination facilities must be installed when necessary, and be appropriate to a number of factors, including:

- the function or use of the building will affect the fire load in the building;
- the floor area of the building which is a measure of the size of any potential fire; and
- the height of the building which is a measure of the extent to which the fire brigade can fight any fire or carry out rescue operations from the outside of the building and the evacuation time.

Deemed-to-Satisfy Provisions

E1.8 provides a number of examples where a fire control centre must be installed if the proposal being considered involves a Building Solution which uses the Deemed-to-Satisfy Provisions.

Alternative Solutions

If an Alternative Solution to the Deemed-to-Satisfy Provisions in Part **E1** is being used, it may be appropriate to assess it using **E1.8** for guidance purposes. However, it is stressed that compliance with **E1.8** is not compulsory if alternative means can be found to satisfy the appropriate authority that the Performance Requirements will be achieved.

PART E1 FIRE FIGHTING EQUIPMENT

Deemed-to-Satisfy Provisions

E1.0 Deemed-to-Satisfy Provisions

Intent

To clarify that the requirements of EP1.1 to EP1.6 will be satisfied if compliance is achieved with E1.1 to E1.10.

E1.1 * * * * *

In BCA 1990 this clause contained provisions relating to Class 1 and Class 10. provisions for Class 1 and Class 10 buildings are now covered in Volume Two. E1.1 has been left blank rather than renumber subsequent clauses.

E1.2 * * * * *

In BCA 1990 this clause contained requirements for fire mains and water-supply services. These provisions are now covered by the referenced Standard AS 2419.1. E1.2 has been left blank rather than renumber subsequent clauses.

E1.3 Fire hydrants

Intent

To require the installation of suitable fire hydrant systems to facilitate the fire brigade's firefighting operations.

When required—E1.3(a)

Fire hydrants are needed to prevent the spread of fire between buildings and fire compartments. They are basically needed for fire brigade use and are not intended for use by occupants. Properly trained people and special equipment are needed for effective firefighting using a fire hydrant system.

The floor area of 500 m² referred to in E1.3(a)(i) represents the level of hazard which justifies the installation of a fire hydrant system.

If the building is in a remote area not serviced by a fire brigade, E1.3(a)(ii) allows it to be constructed without a fire hydrant system. The reason for this is that the fire hydrants are intended for use only by a fire brigade.

AS 2419.1—E1.3(b)(i)

Under E1.3(b)(i), the installation of a fire hydrant system, including the associated water supply, pipe work, pumps, and so on, must be in accordance with AS 2419.1. If any conflict exists

between AS 2419.1 and the BCA, then the BCA takes precedence. Additional information can be obtained by reference to the Standard, including an informative Appendix titled “Guide to the Use of this Standard”.

AS 2419.1 provides the details for determining the number of fire hydrants required and where they should be located.

Location—E1.3(b)(ii)

Generally, **E1.3(b)(ii)** requires the installation of internal fire hydrants on the storey they are to service. The reason for this is to eliminate running a fire hydrant hose up or down a stairway. Also, if the sole-occupancy units are in different ownership or leasehold, access between them may be difficult.

E1.3(b)(ii) grants a concession when a sole-occupancy unit occupies more than one storey. The concession is conditional on the fire hydrant being located at the level of egress from the sole-occupancy unit.

In the case of a Class 2 or Class 3 building or a Class 4 part, there is no limitation on the size or number of storeys within the sole-occupancy unit which can be served by the fire hydrant.

For Class 5 to Class 9 buildings the concession is limited to sole-occupancy units with only two storeys, where the fire hydrant at the entrance level provides total hose coverage. AS 2419.1 provides details of the required coverage.

Pumpsets

Requirements for pumpsets, including the location of pumprooms, etc., is contained in AS 2419.1

Water source, pressures and flows

The for the water supply and source, and the required flows and pressure for the fire hydrant system to operate effectively are contained in AS 2419.1.

E1.4 Fire hose reels

Intent

To require the installation of suitable fire hose reel systems to enable, where appropriate, a building’s occupants to undertake initial attack on a fire.

When required—E1.4(a)

Refer to **EP1.1** for the reasons why the BCA requires the installation of fire hose reels in buildings.

E1.4(a)(i) does not require the installation of fire hose reels in a Class 9c aged care building. It is recognised that occupants close to the point of ignition often provide the most effective means of extinguishing a small fire before it grows. In this case staff and visitors, if not some residents, can be effective in performing this function. To do so, they require appropriate means of extinguishment.

It is considered that the provision of portable extinguishers in an aged care building provides adequate means for staff and visitors to attack the fire. The additional level of fire safety associated with the provision of fire hose reels is not considered necessary.

It is not expected that the number of staff available in an aged care building will be adequate to both fight a growing fire with fire hose reels and evacuate residents. This is particularly the case

when it is noted that the BCA provisions for aged care buildings are based on minimum staffing levels. When a fire becomes too large to be attacked with portable extinguishers, staff will be fully involved in closing doors and evacuating residents rather than fighting the fire.

E1.4(a)(ii) does not require the installation of fire hose reels in classrooms and associated corridors of primary and secondary schools. However, it should be noted that where fire hose reels are not installed in these buildings, portable fire extinguishers must be installed in accordance with **E1.6**.

The concession not requiring the installation of fire hose reels in classrooms, etc is based on normal school use when teachers or school staff could be expected to be in control of students for the purpose of evacuation. Fire hose reels are required in other areas of the school such as halls, gymnasiums, etc where activities take place outside normal school hours and with outside organisations that are not under the control of teachers or school staff.

E1.4(b)(i) requires the installation of fire hose reels where internal fire hydrants are provided.

This requirement applies irrespective of whether the fire hydrants are required under **E1.4(b)(ii)** as a result of the floor area of a fire compartment exceeding 500 m².

E1.4(b)(ii) also states that, for the purposes of **E1.4**, a sole-occupancy unit in a Class 2 or Class 3 building or a Class 4 part is considered to be a fire compartment.

The 500 m² floor area referred to in **E1.4(b)(ii)** represents the level of hazard which justifies the installation of fire hose reels to allow occupants the opportunity to attempt an initial attack on a fire.

System design—**E1.4(c)**

E1.4(c)(ii) generally requires the installation of fire hose reels on the storey they are to service. This eliminates the need to run a fire hose up or down a stairway. Also, if the sole-occupancy units are in different ownership or leasehold, access between them may be difficult. It means that anyone using the fire hose will be able to get away quickly if the fire gets out of control.

E1.4(c)(ii) grants a concession when a sole-occupancy unit occupies more than one storey. The fire hose reel must be located at the level of egress from the sole-occupancy unit.

In the case of a Class 2 or Class 3 building or a Class 4 part, there is no limitation on the size or number of storeys within the sole-occupancy unit served by the hose.

For Class 5–9 buildings, the concession is limited to sole-occupancy units with only two storeys, where the fire hose reel at the entrance level provides total hose coverage.

E1.4(d), (e) and **(f)** relates to the positioning of fire hose reels to help occupants attack a fire in its early stages. These provisions emphasise the importance of the location of fire hose reels to ensure safety.

E1.4(d) ensures that fire hose reels are located to achieve the system coverage required by AS 2441. The fire hose reels can be located internally, externally or in any combination to achieve this coverage as set out in **E1.4(e)**.

Fire hose reels are not permitted to be installed within a fire-isolated exit, thereby avoiding having the hose pass through the door to access the fire. Such an arrangement would require the exit to be open, and therefore cause a significant risk of smoke entering.

The same concerns do not apply to the other Deemed-to-Satisfy Provisions listed in **E1.4(f)**. In the cases listed below, the door may remain open for the hose to pass through.

- **C2.5(a)(v)** deals with walls in Class 9a buildings which are required to separate ancillary areas located within a patient care area and containing equipment or materials that are a high potential fire hazard.

- Likewise, **C2.5(b)(iv)** deals with similar walls in Class 9c buildings.
- **C2.12** deals with the fire isolation of specified hazards and equipment such as lift motors, lift control panels, emergency generators, central smoke control plant, boilers and batteries.
- **C2.13** deals with doors to electricity substations, and the like.
- **C3.11** deals with doors to sole-occupancy units of Class 2 or Class 3 buildings. To require the placement of a fire hose reel in each sole-occupancy unit could be impractical, therefore fire hose reels are allowed to be placed in a common area and then pass through the entrance door to the unit.
- **C3.13** deals with openings in shafts. **C2.12** deals with the fire isolation of specified hazards and equipment.

E1.4(e) is applicable to individual fire hose reels, such that the choices offered in **E1.4(e)(i)**, **(ii)** or **(iii)** are applied to the location of each hose reel in turn, to assure that coverage is achieved. However **E1.4(e)(iii)** is only applicable when the application of **E1.4(e)(i)** or **(ii)** does not achieve coverage.

The individual application means that when each hose reel is located adjacent to a hydrant or an exit, a check for coverage should be done before the next location is chosen.

Once coverage has been achieved, it is not necessary to install any more hose reels, even if additional exits or hydrants are provided for the storey.

Alternatively, if hose reels have been located adjacent to all relevant hydrants or exits without achieving coverage, **E1.4(e)(iii)** permits the additional hose reels needed to achieve coverage to be located in a path of travel to an exit.

E1.5 Sprinklers

Intent

To require the installation of suitable fire sprinkler systems where necessary to address specific hazards.

When required

Refer to the comment on **EP1.4** for the reasons why the BCA requires the installation of sprinkler systems in buildings.

Table E1.5 sets out when sprinklers are required in a building, while **Specification E1.5** sets out the type of sprinkler required and other technical details. The notes to **Table E1.5** also contain useful information on other Parts of the BCA requiring the installation of sprinklers within a building.

Specification E1.5 allows the use of a residential sprinkler system in certain Class 2, Class 3 and Class 9c aged care buildings.

Table E1.5

Table E1.5 specifies when sprinklers are required in a building and which parts of the building must be sprinkler protected. Unless a fire wall or other construction with the appropriate FRLs separates parts of building required to have sprinklers from a part of a building not required to have sprinklers, then the sprinkler requirements must be applied to the whole building.

Table E1.5 requires all buildings with an effective height of more than 25 metres (except those which only contain an open-deck carpark) to be sprinkler protected. The provision regarding an effective height of 25 metres recognises the effective operating height for fire brigade ladders and other firefighting and rescue equipment.

Notes 1, 2 and 3 to **Table E1.5** contain useful references to other BCA provisions that may require the installation of a sprinkler system.

E1.6 Portable fire extinguishers

Intent

To require the installation of suitable portable fire extinguishers, where necessary, to address specific hazards.

When required

Refer to the comment on **EP1.2** for the reasons why the BCA requires the installation of portable fire extinguishers in buildings.

Table E1.6 sets out when portable fire extinguishers are required in a building and the class of extinguisher to be used.

The installation of portable fire extinguishers must be in accordance with Sections 1, 2, 3 and 4 of AS 2444. The other sections of AS 2444 deal with “Selection and distribution of portable fire extinguishers in vehicles and small craft” and “Selection and location of fire blankets”, neither of which are applicable to the BCA. If any conflict exists between AS 2444 and the BCA, then the BCA takes precedence. Additional information can be obtained by reference to the Standard.

It should be noted that **Table E1.6** requires the installation of fire extinguishers in classrooms and associated corridors in primary and secondary schools not provided with fire hose reels. The reason for this requirement is that **E1.4(a)(ii)** does not require the installation of fire hose reels in these buildings, even if the floor area of a fire compartment exceeds 500 m².

E1.7 * * * * *

This clause originally contained provisions relating to fire alarms. These provisions are now covered in Part **E2**. **E1.7** has been left blank rather than renumber subsequent clauses.

E1.8 Fire control centres

Intent

To require the provision of suitable fire control centres to facilitate fire brigade operations.

When required

Refer to the comment on **EP1.6** for the reasons why the BCA requires the installation of fire control centres in buildings.

E1.8(a) requires all buildings with an effective height of more than 25 metres to be provided with a fire control centre. Because of their height these buildings require special co-ordination of fire brigade operations. The **E1.8(a)** reference to an effective height of 25 metres recognises the operating height for fire brigade ladders and other firefighting and rescue equipment.

E1.8(b) requires a fire control centre for Class 6–9 buildings with a total floor area of more than 18 000 m².

The measurement concerned is of the total building floor area, not the area of an individual sole-occupancy unit or fire compartment.

Class 6 and Class 9 buildings have been included because of their high potential fire load, and the likelihood of large populations unfamiliar with their layout or evacuation procedures.

Class 7 and Class 8 buildings have been included because of the potential size and severity of fires in such buildings.

Specification E1.8 sets out the construction details of such a centre and the facilities it must contain.

E1.9 Fire precautions during construction

Intent

To require adequate firefighting equipment within a building during its construction.

When required

Refer to the comment on **EP1.5** for the reasons why the BCA requires the installation of firefighting equipment in buildings during their construction.

E1.9(a) requires the installation of suitable fire extinguishers in all buildings under construction. They are to be placed adjacent to exits on each storey so that they can be easily found by workers if a fire occurs.

Once a building reaches a height of about 12 metres, firefighting in a building under construction becomes increasingly difficult. The installation of fire hydrants, fire hose reels and booster connections (required under **E1.9(b)**) assist in overcoming such difficulties.

The fire hydrants and fire hose reels are not required on the two upper floors because services such as water supply may not be installed. Also, if a fire occurred on these floors, it could be fought from the floors below.

E1.10 Provision for special hazards

Intent

To require the installation of additional fire safety measures where special hazards exist.

When required

The other Deemed-to-Satisfy Provisions of Part **E1** set out the required firefighting equipment and co-ordination facilities required in a building to deal with “expected” or “usual” hazards. However, it is not possible to take account of every possible hazard. **E1.10** may even require additional provision for special hazards where Part **E1** does not otherwise apply.

Additional provision for special hazards must be made to allow for effective firefighting operations taking into consideration:

- the nature of the materials stored, displayed or used in the building or on the allotment; or
- inadequate water supply for firefighting.

Examples

Special fire hazards may exist for hazards under **E1.10(a)** in a warehouse used to store highly volatile or combustible materials, and also, at a site where highly combustible chemicals are manufactured.

Hazards under **E1.10(b)** may include sites where little or no water is available for firefighting.

The BCA Deemed-to-Satisfy Provisions do not specify what the special provisions must be. Each case must be assessed on its own merits.

SPECIFICATION **E1.5** FIRE SPRINKLER SYSTEMS

Deemed-to-Satisfy Provisions

1 Scope

Intent

To state that **Specification E1.5** gives the design and installation details for sprinkler systems required by the Deemed-to-Satisfy Provisions.

Design and installation—sprinkler systems

Clause 1 deals with the intent.

Examples

A number of the **Deemed-to-Satisfy Provisions** require the installation of sprinklers in accordance with **Specification E1.5**. These include:

- **E1.5**—Sprinklers;
- **Part E2**—Smoke Hazard Management;
- **C2.3(b)**—Large isolated buildings;
- **Specification G3.8**—Fire and smoke control in buildings containing atriums;
- **Clauses 3.9, 4.2 and 5.2** of **Specification C1.1** when granting a concession for enclosed carparks;
- **Clause 2.9** of **Specification C1.1** for residential aged care buildings; and
- **Clauses 3.10 and 4.3** of **Specification C1.1** for multi-storey, timber framed, Class 2 buildings.

2 Adoption of AS 2118

Intent

To adopt the appropriate Australian Standard for the design and installation of sprinkler systems.

Adoption of three Parts of AS 2118

Specification E1.5 adopts three Parts of AS 2118:

- AS 2118.1—*Automatic fire sprinkler systems Part 1: Standard*;
- AS 2118.4—*Automatic fire sprinkler systems Part 4: Residential*; and
- AS 2118.6—*Automatic fire sprinkler systems Part 6: Combined sprinkler and hydrant*.

AS 2118.1 applies to all classes of buildings—Clause 2(a)

Part 1 of AS 2118 applies to all Classes of building.

AS 2118.4—Clause 2(b) and (d)

These clauses allow the use of Part 4 of AS 2118 for Class 2, Class 3 and Class 9c buildings as appropriate. The reason for using the term “as appropriate” is that AS 2118.4 applies to low-rise Class 2, Class 3 and Class 9c buildings. The scope of AS 2118.4 states that it only applies to those buildings containing no more than four storeys. If the building exceeds this height, it must comply with AS 2118.1.

The sprinkler system specified under AS 2118.4 has been designed for use in low-rise residential buildings. AS 2118.4 also takes into consideration the economic aspects of a sprinkler system.

AS 2118.4 provides the requirements for sprinklers in residential buildings.

A sprinkler system installed in accordance with AS 2118.4 is designed to prevent the fire reaching the stage at which “flashover” occurs (ie total involvement of a room’s contents in a fire), thus reducing the risks to occupants.

Smoke detection matters are dealt with in Part E2.

Combined sprinkler and hydrant systems—Clause 2(c)

Clause 2(c) allows the installation of a combined sprinkler and hydrant system provided it complies with AS 2118.6.

3 Separation of sprinklered and non-sprinklered areas

Intent

To require the fire separation of sprinklered parts of a building from non-sprinklered parts of the building.

Size and intensity of an assumed fire

The design of a sprinkler system is based on the size and intensity of an assumed fire in the building. The BCA assumes that fire size is controlled by the sprinkler system.

A fire in a non-sprinklered part of a building

If a fire starts in a non-sprinklered part of the building, its development will be uncontrolled. It can even reach a size which could over-ride the sprinkler system if it spreads to the sprinklered part of the building (ie it could be beyond the design capacity of the system).

Separation between sprinklered and non-sprinklered parts

Clause 3(a) applies wherever there is a specific Deemed-to-Satisfy Provision.

The fire separation required by AS 2118.1 may differ from that required by the BCA. **Clause 3(b)** clarifies that if a difference exists between AS 2118.1 and the BCA, the BCA takes precedence.

AS 2118.1 generally requires a 120/120/120 FRL separation between the sprinklered and non-sprinklered parts of a building to minimise the risk of fire spread from non-sprinklered parts (where a fire’s development is substantially uncontrolled) to a sprinklered part (where the sprinkler system is designed on the basis of a likely fire in that part of the building).

4 Protection of openings

Intent

To require the fire separation of sprinklered parts of a building from non-sprinklered parts of the building.

The aim of **Clause 4** is similar to **Clause 3**, but it particularly deals with the protection of openings, in the construction, between sprinklered and non-sprinklered parts of a building.

5 Fast response sprinklers

Intent

To allow the use of fast response sprinkler heads.

Where “fast response” sprinkler heads register a specific external temperature, their reaction time is much shorter than for a “normal” sprinkler head. They also have different discharge characteristics. Where “fast response” sprinkler heads are used, the sprinkler system must be designed specifically for their use.

6 Sprinkler valve enclosures

Intent

To require the location of sprinkler valves in a secure, easily accessible area.

Sprinkler control valves—location

Sprinkler control valves must be located in a secure area to prevent unauthorised tampering or vandalism.

“Direct egress to a road or open space”

Clause 6(a) requires that sprinkler alarm valves be in a room having “direct egress to a road or open space”. The intent is to help fire brigade personnel gain quick access to valves, and, if the need arises, to exit quickly.

When interpreting the expression “direct egress to a road or open space”, it should be noted that **D1.10(c)** requires that if an exit discharges to open space which is at a different level from the public road to which it is connected, the path of travel to the road must be by a ramp or stairway complying with the BCA.

The aim is to provide quick egress, if the need arises. For this purpose it would be reasonable to limit the stairway to one flight. The landing and stairway must not expose a user to fire or smoke generated by a fire in the building. Care must therefore be taken to make sure windows and other openings are correctly located, and that the external walls of the building have an appropriate FRL.

7 Water supply

Intent

To require an adequate water supply when a sprinkler system has been installed.

Grades of water supply

A Grade 1 water supply is required for buildings greater than 25 metres in effective height (see [Clause 7\(a\)](#)), and a Grade 3 supply for buildings less than this height. See [Clause 7\(b\)](#).

AS 2118.1 defines a Grade 1 water supply as being a supply connected to two separate sources, each capable of providing water at the relevant hazard class. [Clause 7\(a\)](#) provides concessions for the secondary water supply in certain circumstances.

A Grade 3 water supply is a supply provided from a single source which does not satisfy the requirements of a Grade 2 water source (a Grade 2 water supply being one which provides a higher reliability of supply than Grade 3).

8 Building occupant warning system

Intent

To maximise the effectiveness of a sprinkler system by alerting the occupants throughout the building of a potential emergency.

AS 1670.1

[Clause 8](#) requires a sprinkler system to be connected to activate a warning system complying with [Specification E2.2a](#), [Clause 6](#). This is an AS 1670.1 warning system which is to operate throughout the occupied parts of the building.

Different types of warning devices permitted

AS 1670.1 allows the warning system to be:

- a warning system complying with AS 2220;
- electronic sounders generating evacuation tones in accordance with AS 2220; or
- another warning device approved by the appropriate authority.

See AS 2220.

9 Connection to other systems

Intent

To allow the interconnection of a sprinkler system with other fire safety systems.

Activation of smoke hazard management system

Modern fire safety designs allow for the interaction of the various safety systems during a fire. [Clause 9](#) requires that where a smoke hazard management system is activated by a smoke detector, “wherever practicable” it must also be activated by the sprinkler system.

Note this provision only applies “wherever practicable”. In other words, if a building proposal includes a smoke hazard management system which is activated by smoke detectors, but it is proposed that the smoke hazard management system will not be activated by the sprinkler system, the building proponent must satisfy the appropriate authority that it is not practicable to do so.

10 Anti-tamper devices

Intent

To provide for the continued operational effectiveness of sprinkler heads located above a theatre or public hall stage.

Stages used for live performances—high fire load

Stages used for live performances can contain high fire loads due to the scenery and other props used in these productions, and particularly hazardous stage activities, such as pyrotechnics.

Clause 10 requires that sprinkler valves be fitted with anti-tamper devices connected to a monitoring panel.

11 Sprinkler systems in carparks

Intent

To provide for sprinkler systems in certain carparks to operate independently or be isolated from the system in other parts of the building.

Carparks

Table 3.9 of **Specification C1.1** grants concessions for the FRL of structural members within carparks in buildings required to be of Type A construction. Therefore, **Clause 11** of **Specification E1.5** only applies to such buildings.

Clause 11 does not apply to **Tables 4.2** and **5.2** of **Specification C1.1** for carparks in buildings required to be of Type B or Type C construction.

If a building required to be of Type A construction contains an enclosed carpark, in order to take advantage of the concession allowed by **Table 3.9**, it must contain a sprinkler system which is independent or can be separately isolated.

The reason for this requirement is so that the carpark’s protection is available at all times, and is not affected by such factors as maintenance or shutdown in other parts of the building.

12 Class 9c aged care buildings

Intent

To ensure greater reliability of sprinkler systems in Class 9c buildings.

Clause 2(d) of **Specification E1.5** allows a sprinkler system in a Class 9c building to comply with AS 2118.4 instead of AS 2118.1. **Clause 12(a)** requires the addition of a monitored main valve and control valve assembly in accordance with AS 2118.1. The reason for the additional requirement is to ensure greater reliability of the sprinkler system.

Clause 12(b) specifies system monitoring requirements to enable a timely and appropriate response by the local fire brigade to emergencies.

Clause 2.10.1.3 of AS 2118.4 sets out the requirements for the installation of sprinklers in roof spaces, etc. Spaces such as roof spaces, crawl spaces, spaces below floor and above ceilings, and other concealed spaces that are not intended, nor used, for living purposes, storage or the installation of equipment such as flexible ductwork, heating and refrigeration equipment, are not required to be protected by sprinklers.

Roof and ceiling spaces that contain only items such as electrical wiring for light fittings and exhaust fans, etc are not required by this provision to be provided with sprinklers.

SPECIFICATION **E1.8** FIRE CONTROL CENTRES

Deemed-to-Satisfy Provisions

1 Scope

Intent

To clarify that **Specification E1.8** provides the construction and content details for fire control centres and rooms.

Fire control centres or rooms

Specification E1.8 sets out the construction and content details for fire control centres and rooms required by the BCA.

A fire control room is a fire control centre in a dedicated room with specific requirements. See **Clause 6** which requires that where a fire control centre is in a building of more than 50 metres in effective height, the centre must be in a separate room. Clauses 2 to 5 of **Specification E1.8** set out the requirements for fire control centres (including fire control rooms) while Clauses 6 to 12 set out additional requirements for fire control centres which are required to be located in a dedicated room, which is commonly referred to as a fire control room.

2 Purpose and content

Intent

To clarify the facilities a fire control centre must contain.

Fire control centre required by **E1.8**

E1.8 sets out when a fire control centre is required in a building.

Exclusive purpose of centre

Clause 2 sets out that a fire control centre must be for the exclusive purpose of:

- directing firefighting operations and other functions of the fire brigade, such as search and rescue operations (this requirement reflects the importance placed on fire brigade operations); and
- other measures directly relating to occupant safety or security.

In this context, the centre or room cannot be used for any other purpose.

3 Location of fire control centre

Intent

To require that a fire control centre be conveniently placed to allow egress.

Egress

Egress from the fire control centre must not involve a change in level exceeding 300 mm. This is to help fire brigade officers carrying their equipment and make entry easy.

4 Equipment not permitted within fire control centre

Intent

To limit the type of equipment allowed in a fire control centre.

Extraneous equipment not allowed

Since the fire control centre will be occupied by fire brigade personnel during a fire, possibly for a period long after the other occupants have evacuated, it must be suitable for directing fire brigade operations. Equipment which does not assist in this function, or could endanger the fire brigade personnel, is not allowed in the centre.

5 Ambient sound level for a fire control centre

Intent

To minimise the risk of the sound levels in a fire control centre interfering with the room's function.

Noise must not interfere with communications

The fire control centre is used to direct fire brigade operations during a fire in the building, possibly for a period long after the other occupants have evacuated. This involves communication with other fire brigade officers outside the centre. It is therefore important that ambient sound levels do not interfere with that communication.

6 Construction of fire control room

Intent

To set out the construction details of fire control rooms.

Buildings over 50 metres in effective height

E1.8 requires certain buildings to contain a fire control centre. Clause 6 only applies to those buildings with an effective height greater than 50 metres. In these buildings, a fire control centre must be within a dedicated room known as a fire control room. Since the fire control room will be occupied by fire brigade personnel during a fire in the building, it must be fire separated from the remainder of the building.

7 Protection of openings in a fire control room

Intent

To require that the fire-resisting performance of a fire control room is maintained.

Openings must be fire protected

The aim of [Clause 7](#) is similar to [Clause 6](#), except that [Clause 7](#) deals with openings in the construction separating the fire control room from the remainder of the building.

8 Doors to a fire control room

Intent

To require adequate access to a fire control room.

Application

Refer to comment on [Clause 1](#).

Access

The main provisions deal with access to the fire control room. Since it will be necessary for the fire brigade to gain access to the fire control room while the building is being evacuated, access to it must not be obstructed by people evacuating.

Providing access by way of two paths of travel is to help fire brigade access. One of those paths must be from the front entrance of the building, and the other must be from a public place or a fire-isolated passage which leads from a public place.

9 Size and contents of a fire control room

Intent

To set out the contents required in a fire control room.

Application

Refer to comment on [Clause 1](#).

[Clause 9\(a\)](#) sets out the minimum size and contents required in a fire control room.

[Clause 9\(b\)](#) lists additional items which may be contained in a fire control room. This list is not exhaustive, other items may be added provided the floor area of the room is increased, as required by [Clause 9\(c\)](#).

[Clause 9\(c\)](#) sets out the area requirements for fire control rooms.

10 Ventilation and power supply for a fire control room

Intent

To reduce the likelihood of smoke accumulating in a fire control room.

Application

Refer to comment on [Clause 1](#).

Since the fire control room will be occupied by fire brigade personnel, possibly for a period long after the other occupants have evacuated, it must have adequate means of preventing the accumulation of smoke. The room can have either natural ventilation complying with [Clause 10\(a\)](#) or a pressurisation system complying with [Clause 10\(b\)](#).

If natural ventilation is used, then the window or door must not open to another part of the building.

If a pressurisation system is used, it must comply with AS/NZS 1668.1 and the other provisions of [Clause 10\(b\)](#). This is achieved by treating the room similarly to a fire-isolated stairway, which includes:

- activation of the system;
- air change rates;
- protection of fans, motors and duct work;
- protection of the electrical supply to the system; and
- relief air devices.

11 Sign for a fire control room

Intent

To require that a fire control room is appropriately identified.

Application

Refer to comment on [Clause 1](#).

[Clause 11](#) achieves the intent by requiring the placement of a sign on the door to the room. Such a sign is required on all doors to a fire control room.

12 Lighting for a fire control room

Intent

To provide sufficient illumination to the fire control room during an emergency.

Application

Refer to comment on [Clause 1](#).

Since the fire control room will be occupied by fire brigade personnel during a fire in the building, possibly for a period long after the other occupants have evacuated, it must have appropriate levels of lighting. As the lighting must be maintained while the room is in use, it must be emergency lighting in case of failure of the building's normal lighting system.

Normally, emergency lighting is only used for evacuation purposes. A fire control room is used to direct fire brigade operations, which will include such actions as reference to building plans, and the reading of other information. The amount of emergency lighting in the room must therefore be increased to 400 lux.

PART E2 SMOKE HAZARD MANAGEMENT

Objective

E02

Safeguard occupants from illness and injury

Part E2 aims to safeguard building occupants from illness or injury from the products of combustion (including smoke and toxic gases). **E02(a)** deals with warning of a fire and **E02(b)** deals with requirements for evacuating.

Smoke and toxic gases kill

Smoke and toxic gases are the main causes of death in building fires. Such deaths have occurred in locations remote from the fire to where smoke and gases have spread. Smoke and toxic gases cause disorientation, incapacitation and ultimately death, depending on the concentration and length of exposure.

Management of the smoke and toxic gas hazard is crucial for occupant safety. This is best achieved through a combination of active and passive measures, such as:

- building materials and finishes;
- compartmentation;
- egress;
- smoke and toxic gas detection;
- fire suppression; and
- smoke and toxic gas control by mechanical means.

Part E2 addresses some of the active measures which, together with the relevant provisions in other Parts of the BCA, provide appropriate strategies for the protection of occupants.

Functional Statement

EF2.1

Buildings—adequate safeguards

EF2.1 requires that a building have safeguards to warn occupants of a fire so they may safely evacuate before the conditions in any evacuation route become untenable, due to the effects of fire.

Performance Requirements

EP2.1

Sleeping accommodation—smoke alarms

A Class 2, 3, 9a and 9c building and a Class 4 part must contain automatic warning on the detection of smoke for occupants in sleeping areas, so they may be alerted to a fire.

EP2.2

Evacuation routes must remain tenable

Occupants must be given time to evacuate before the onset of untenable conditions. **EP2.2(a)** specifies these conditions as dangerous temperatures, low visibility and dangerous levels of toxicity.

Hence, evacuation time must take account of a range of factors including the following:

- **EP2.2(b)(i)**—the difficulty of evacuation and/or rescue. An example is where there is a large number of occupants, or they are not mobile, such as patients in a hospital or residents of an elderly people's home. Here the evacuation time could be high.
- **EP2.2(b)(ii)**—the likelihood or risk of a fire occurring in the building, which can have an influence on risk levels during evacuation and along the evacuation route.
- **EP2.2(b)(iii)**—the time necessary to travel to an exit, and the difficulty of evacuation and/or rescue.
- **EP2.2(b)(iv), (v) and (vi)**—the size, load or intensity of any fire in the building, which has a clear influence on the speed of fire development and spread, and heat and toxic gas characteristics.
- **EP2.2(b)(vii)**—the fire safety systems in the building can influence the rate of fire spread and intensity and toxic gas development (eg if a sprinkler system is installed, it should extinguish the fire or reduce its growth rate).
- **EP2.2(b)(viii)**—the firefighting operations of the fire brigade and the resources available to it, which influences the extent to which a fire can develop before the fire brigade is likely to bring it under control.

Under its Limitation provision, **EP2.2** does not apply to open-deck carpark or open spectator stands where the smoke and hot gases can vent naturally, thereby allowing occupants to safely evacuate.

PART E2 SMOKE HAZARD MANAGEMENT

Deemed-to-Satisfy Provisions

E2.0 Deemed-to-Satisfy Provisions

Intent

To clarify that the requirements of **EP2.1** and **EP2.2** will be satisfied if compliance is achieved with **E2.1** to **E2.3** and, in buildings containing atriums, **Part G3**.

E2.1 to **E2.3** and **EP2.1** and **EP2.2**

Where a **Building Solution** is proposed to comply with the **Deemed-to-Satisfy Provisions**, except in buildings containing atriums, compliance with **E2.1** to **E2.3** achieves compliance with **EP2.1** and **EP2.2**.

Buildings with atriums

In addition to achieving compliance with **E2.1** to **E2.3**, to achieve compliance with **EP2.1** and **EP2.2** buildings with atriums must also comply with **Part G3**.

Where a **Building Solution** is proposed as an **Alternative Solution** to the **Deemed-to-Satisfy Provisions**, the relevant **Performance Requirements** must be determined in accordance with **A0.10**. (See comment on **A0.10**).

E2.1 Application of Part

Intent

To specify when **E2.2** and **E2.3** do not apply.

Open-deck car parks and open spectator stands—E2.1(a)

E2.1(a), **E2.2** and **E2.3** do not apply to open-deck car parks or open spectator stands. **EP2.2** does not apply to such buildings because the smoke and hot gases can vent naturally.

Smoke exhaust systems and smoke-and-heat vents—E2.1(b)

Under **E2.1(b)**, the **E2.2** and **E2.3** provisions regarding smoke exhaust systems and smoke-and-heat vents do not apply to small areas used for short periods.

A small area will be easily evacuated before smoke build-up and if the area is only used for short periods, the risk of occupants being trapped in it during a fire is low.

E2.2 General requirements

Intent

To specify the requirements for minimising the smoke risks.

Class 2–9 buildings—E2.2(a)

Class 2–9 buildings must comply with **E2.2(b)**, **(c)** and **(d)**, which cover the fire mode operation of air-handling systems so that they do not contribute to the spread of smoke during a fire. This assists to maintain the basic smoke integrity of the fire compartments.

In addition to **E2.2(b)**, **(c)** and **(d)**, Class 2–9 buildings must comply with the requirements of **Table E2.2a**, which provides some general and specific strategies for smoke hazard management.

In addition to **E2.2(b)**, **(c)** and **(d)** and **Table E2.2a**, Class 6 and Class 9b buildings must comply with the requirements of **Table E2.2b**, where applicable, which provides some general and specific strategies for smoke hazard management.

Air-handling system which is not part of a smoke hazard management system—E2.2(b)

Smoke must not cross smoke barriers

E2.2(b) requires that an air-handling system that is not part of a smoke hazard management system be designed and installed with suitable strategies to ensure that, during a fire, it does not:

- recycle air (and therefore smoke) from one fire compartment to another; or
- otherwise contribute to the spread of smoke between fire compartments.

Comply with AS/NZS 1668.1—E2.2(b)(i)

The effect of **E2.2(b)(i)** is that in a fire, an air-handling system must either operate as a smoke control system in accordance with AS/NZS 1668.1 (as specified in **E2.2(b)(i)**) or shut down (as specified in **E2.2(b)(ii)**).

A smoke purging system, in accordance with AS/NZS1668.1, is allowable in buildings not covered by the general provisions in **Table E2.2a**, and, in some instances, in conjunction with other measures in accordance with **Table E2.2a**.

Non-smoke control system—E2.2(b)

An air-handling system not designed as a smoke control system must comply with the requirements set out in **E2.2(b)** as follows:

- Automatic smoke dampers—**E2.2(b)(ii)(A)**

Where the air-handling system is shut down in fire mode, it must incorporate automatic smoke dampers where the ducts penetrate any fire barriers.

This requirement may apply to an air-handling system which supplies outside air to a group of residential sole-occupancy units.

- System shut down—**E2.2(b)(ii)(B)**

The air handling system must shut down, and smoke detectors must automatically activate smoke dampers.

- Class 2 and Class 3 buildings

Sole-occupancy units in Class 2 and Class 3 buildings are, under **E2.2(b)**, regarded as separate fire compartments.

Sections 5 and 11 of AS/NZS 1668.1—**E2.2(c)**

Air-handling systems, other than one in a carpark, serving more than one fire compartment covered by Sections 5 and 11 of AS/NZS 1668.1 must be designed and installed in compliance with those sections of the Australian Standard. This will restrict the spread of smoke between fire compartments.

Provisions on the operation of carpark ventilation systems during a fire in the carpark are included under the general provisions in **Table E2.2a**.

Smoke detection systems to operate AS/NZS 1668.1 smoke control systems—**E2.2(d)**

An AS/NZS 1668.1 system for zoned smoke control and automatic air pressurisation for fire-isolated exits must be controlled by a smoke detection and alarm system installed in compliance with **Specification E2.2a**. Activation of these systems also requires the activation of a building occupant warning system.

E2.3 Provision for special hazards

Intent

To state that some special hazards may require additional smoke hazard management measures.

Additional smoke hazard measures

E2.3 states that certain factors may need additional smoke hazard management measures.

E2.3 reinforces the need for careful consideration and sound professional judgement in the application of the smoke hazard management provisions of the BCA.

Examples

E2.3 may be applicable in situations where:

- A child care centre is located above ground floor level or within a commercial building. Safety of children is paramount. They will need assistance to evacuate. As egress arrangements depart from providing exits direct to a road or open space, (usually provided at ground floor level) so does the potential for things to go wrong. The BCA does not specifically address child care centres at other than the ground floor.
- Occupants are held under detention in a correctional or health-care facility. The BCA does not specifically address the special circumstances surrounding these facilities. To ensure an acceptable level of safety is provided to occupants, special provisions may need to be provided.
- A high hazard process is carried out in an industrial building. Due to the variance in such processes, it would be difficult to develop specific generic provisions. Such processes may also be subject to other legislation. Hence each process should be considered on its merits and additional safeguards provided as necessary.

Deemed-to-Satisfy Provisions—Tables E2.2a and E2.2b

Table E2.2a—General Provisions

Table E2.2a and EP2.1 and EP2.2

EP2.1 requires automatic warning on the detection of smoke in buildings having sleeping accommodation, so that occupants may be alerted to the fire hazard. **EP2.2**, in terms of maintaining safe conditions in any evacuation route, deals with the period of time it would take occupants to evacuate that part of the building.

Table E2.2a provides whole-building strategies

Table E2.2a provides smoke hazard management strategies structured to help application to buildings of mixed classification. In the case of a multi-classified building, each classifiable part must comply with the relevant provisions for its classification. Certain Class 6 and Class 9b parts of buildings must also comply with the specific provisions in **Table E2.2b**.

Fire-isolated exits

Fire-isolated exits enable the safe evacuation of occupants, and also aid fire brigade access. Smoke must not unduly affect the conditions in such exits during an evacuation.

To minimise smoke intrusion, the exits may need to be pressurised with outside air for the entire exit route. See the following examples. Alternatively, the exits may be provided with open access ramps or balconies from which smoke can vent naturally.

Examples

Pressurised fire-isolated exits are required where:

- tenable conditions must be maintained for an extended period due to a long distance of travel, such as exits which serve storeys above 25 metres in effective height or which are more than 60 metres in length to a road or open space;
- tenable conditions must be maintained for an extended period of time to enable the safe evacuation of non-ambulatory occupants, such as in health-care buildings with a rise in storeys of more than 2;
- the exits are the only possible means of escape, such as those serving basements more than two storeys below ground; or
- the risk of smoke intrusion into the exits is high on account of a particular building characteristic, such as is generally the case in a building containing an atrium.

Buildings over 25 metres in effective height

In buildings more than 25 metres in effective height, tenable conditions need to be maintained in the fire-isolated exits and, where practicable, in other parts of the building to enable the staged evacuation of occupants.

Occupants of such buildings may continue to occupy compartments remote from the fire for an extended time before evacuation. Accordingly, suitable measures must be adopted to minimise the spread of smoke from the fire-affected compartment to non-affected compartments by way of a number of potential leakage paths.

These paths include lift shafts, air-handling ducts, services risers, building penetrations, spandrels, and the like, through which smoke can be driven by buoyancy, expansion, stack and wind effects, and air-handling systems.

In order to minimise the spread of smoke, a zone smoke control system is considered necessary in buildings more than 25 metres in effective height. This does not apply to the residential parts of a building in view of:

- the alternative protection provided by the fire compartmentation of sole-occupancy units;
- separation of public corridors by bounding construction; and
- division of such corridors by smoke-proof walls into lengths of not more than 40 metres (see [C2.14](#)).

Additionally, this requirement does not apply to a single fire compartment in a Class 5, 6, 7b 8 or 9b building in an otherwise residential building. The reasons for this exemption are:

- the provision of a zone smoke control system is considered inappropriate for a single compartment in a building; and
- any single fire compartment Class 9b building or Class 6 building with a floor area greater than 2000 m² is also subject to the provisions of [Table E2.2b](#), ensuring that smoke hazard management considerations are applied; and
- to require compliance could create an anomaly with the exemption of sporting complexes, including gymnasiums and swimming pools from required smoke hazard management measures under [Table E2.2b](#).

Notwithstanding the above, a smoke detection and alarm system must be provided in residential and health-care buildings to provide early warning to occupants who may be asleep, confused, or non-ambulatory and dependent on assistance.

[Table E2.2a](#) provisions are additional to other safety provisions for buildings with an effective height of more than 25 metres.

Buildings less than 25 metres in effective height

In buildings less than 25 metres in effective height, the necessary levels of protection may be achieved by measures other than zone smoke control, depending on the Class and rise in storeys of the building.

In buildings other than health-care buildings, zone smoke control may be substituted by either stairway pressurisation, smoke detection, or sprinkler protection. The rise in storeys before which the provisions become applicable depends on the building's classification and use.

The above measures do not apply to the residential parts of a building because of the passive protection provided to such parts. However, where one or more fire-isolated exits join residential and non-residential parts, other than open-deck carparks, the fire-isolated exits must either be pressurised, or the non-residential parts provided with smoke detection or sprinkler protection. This is necessary to compensate for the potential additional hazard associated with the particular mix of Classes.

In health-care buildings, zone smoke control may be substituted by a sprinkler system, providing residential sprinkler heads are used in patient care areas. The fast response of residential sprinkler heads promotes life safety by limiting fire growth and smoke development. Where zone control is not adopted, the air-handling systems must generally be shut down not only to maintain the integrity of the smoke and fire compartmentation, but also to minimise the spread of smoke within the fire-affected compartment.

Notwithstanding the above, a smoke detection and alarm system must be provided in residential and health-care buildings.

Large Class 7 or 8 buildings subject to C2.3

These provisions set out the smoke hazard management measures for large isolated Class 7 or 8 buildings subject to the requirements of [C2.3\(a\)](#) with a floor area of 18 000 m² or less and a volume of 108 000 m³ or less. Such buildings are required to have—

- a sprinkler system (see [Specification E1.5](#) for details) and be provided with perimeter vehicular access complying with [C2.4\(b\)](#); or
- an automatic fire detection and alarm system (see [Clause 7 of Specification E2.2a](#) for details); or
- an automatic smoke exhaust system (see [Specification E2.2b](#) for details); or
- automatic smoke and heat vents (see [Specification E2.2c](#) for details); or
- natural smoke venting (see [Table E2.2a](#) for details).

Large Class 5 to 9 buildings subject to C2.3

These provisions set out the smoke hazard management measures for large isolated Class 5 to 9 buildings subject to the requirements of [C2.3\(b\)](#) having a floor area exceeding 18 000 m² or having a volume exceeding 108 000 m³.

Such buildings are required to have—

- where there is a ceiling height of 12 metres or less, either a specified automatic smoke exhaust system (see [Specification E2.2\(b\)](#) for details), or an automatic smoke-and-heat ventilation system (see [Specification E2.2\(c\)](#) for details); or
- where there is a ceiling height of more than 12 metres, a specified automatic smoke exhaust system (see [Specification E2.2\(b\)](#) for details).

Roller shutters

Roller shutters and doors can be used for smoke venting purposes in accordance with the table if they are “readily openable”. A building proponent must satisfy the appropriate authority that such roller shutters and doors achieve the “readily openable” requirement.

However, if the openings are also used for egress purposes, they must also comply with the requirements of relevant provisions such as [D2.19](#) and [D2.21](#).

Class 7a buildings

A carpark ventilation system is consistent with the treatment of miscellaneous air-handling systems in AS/NZS 1668.1. Accordingly, the electric power and control cabling for a carpark ventilation system need not be fire rated.

Likewise, a concession is granted to allow fans with metal blades suitable for operating at normal temperatures to be used instead of fans required to operate at elevated temperatures as required by Clause 4.8.1 of AS 1668.1.

To make sure that the manual override provision of Clause 5.5.3 of AS/NZS 1668.1 is not subject to the control of any general installation main switches, the power supply arrangement must comply with AS 3000.

Basements (other than Class 7a buildings)

The provisions for basements are more stringent due to the special problems they pose for evacuation, search and rescue, and firefighting operations.

As the total floor area of the basement increases to above 2 000 m², certain minimum measures have been stipulated. In basements with three or more below ground storeys, a sprinkler system is considered necessary.

Atriums

The provisions of this Part, as well as [Part G3](#), apply to atrium buildings.

Table E2.2b—Specific Provisions

Table E2.2b and Class 6 and Class 9b buildings

The provisions of **Table E2.2b** are additional strategies which only apply to certain Class 6 and Class 9b buildings where there is a high risk that occupants may not be able to safely evacuate the fire-affected compartment. This risk may be due to factors such as:

- building design;
- function;
- usage;
- fire load; or
- nature of occupancy.

Occupants of such buildings are also not necessarily familiar with the building or the procedures for evacuation.

Maintenance of safe conditions in evacuation routes

Table E2.2b addresses requirements under **EP2.2** in terms of maintaining safe conditions in any evacuation route within the fire-affected compartment of Class 6 and Class 9b buildings, for the period of time it would take occupants to evacuate that part of the building.

Class 6 buildings

There are specific provisions for large Class 6 buildings in **Table E2.2b** for the installation of either an automatic smoke exhaust system or automatic smoke-and-heat vents to control smoke during a fire. These apply to the whole fire compartment where the floor area of the Class 6 part of the fire compartment is more than 2 000 m².

There are specific concessions that vary these requirements. These are—

- for buildings where the floor area of the fire compartment does not exceed 3 500 m², it is permitted to install—
 - an automatic smoke detection and alarm system in lieu of a smoke exhaust or smoke venting system if the building is single storey; or
 - a sprinkler system if the building has a rise in storeys of not more than 2.
- for single storey shops with a floor area less than 2 000 m² (within a larger fire compartment) which have a main entrance opening to a road or open space and are smoke separated from the fire compartment. See **Example 1**.
- for another part of the building with a different classification (ie other than Class 6) which is smoke separated, including openings, junctions and joints of building elements, etc., from the Class 6 part.

Example 1

Example 1 looks at a single storey shopping complex which does not contain a mall, as shown in **Figure E2.2b(1)**. The fire compartment has a floor area of 5 300 m², so smoke exhaust/venting is required. The floor area of the fire compartment is more than 3 500 m², therefore a smoke detection and alarm system or a sprinkler system cannot be used in lieu of smoke exhaust venting. However, smoke exhaust venting need not be provided in shops A and C because their individual floor areas are less than 2 000 m², they are not interconnected to shop B, and their main entrances open to a road or open space.

Smoke exhaust or smoke-and-heat venting must be provided to shop B.

Shop	Area	Entry	Smoke exhaust OR smoke-and-heat vents OR smoke detection and alarm OR sprinkler system
A	900 m ²	From open space	None required
B	2 500 m ²	From open space	Smoke exhaust or smoke-and-heat venting required as the floor area exceeds 2 000 m ²
C	1 900 m ²	From open space	None required

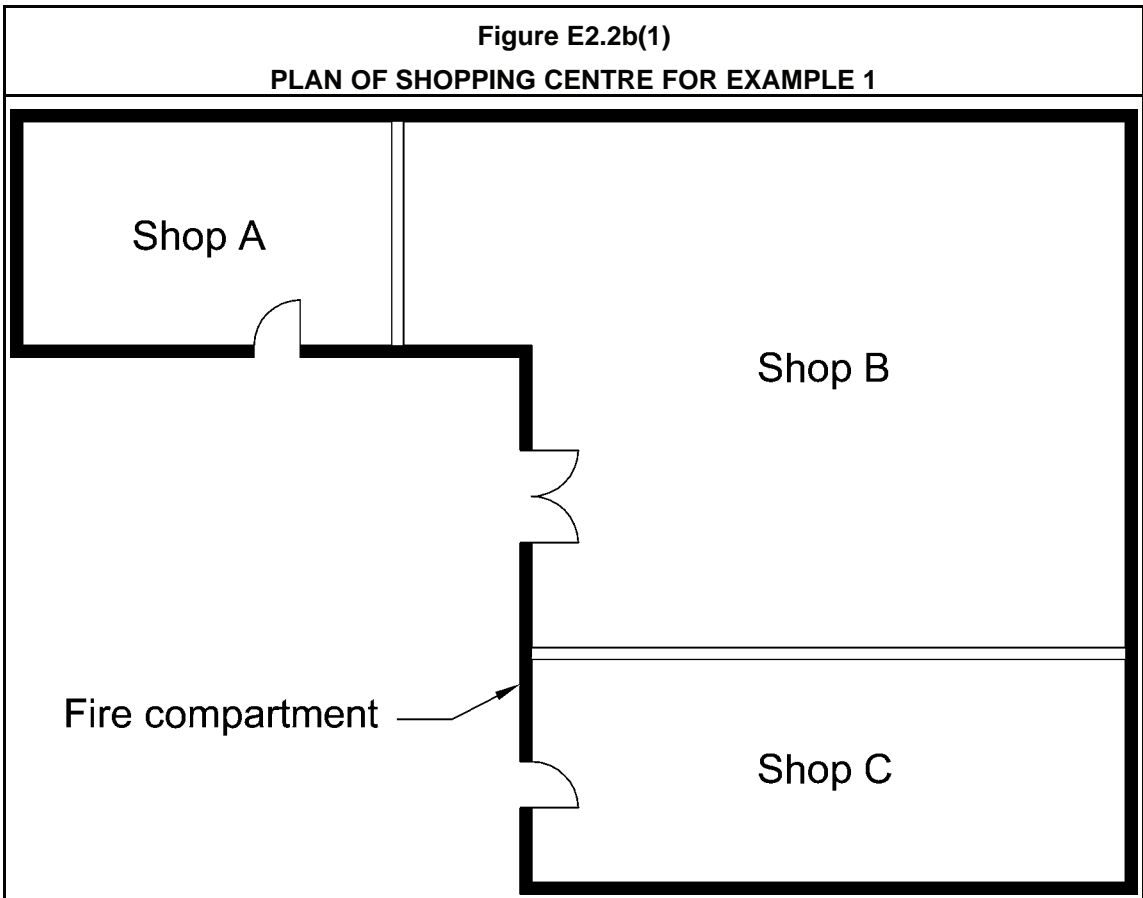

The specific smoke hazard management provisions for Class 6 buildings containing shops and an enclosed common walkway or mall are similar. Where such a building has a fire compartment with a floor area of more than 2 000 m², an automatic smoke exhaust system or an automatic smoke-and-heat vent system to control smoke during a fire is required.

However, where a single storey shop does not open onto the mall and its main public entrance opens to a road or open space, it does not need to have any smoke exhaust or smoke venting, if its floor area does not exceed 2 000 m². This is similar to the concession for a shop in a building which does not contain a mall.

Another concession applies to shops that open onto the mall. They do not need to have any smoke exhaust or smoke venting system if their individual floor areas are less than 1 000m².

A concession is also available for another part of the building with a different classification (ie other than Class 6) which is smoke separated, including openings, junctions and joints of building elements, etc., from the Class 6 part.

In a Class 6 building containing a mall, a sprinkler system can also be used in lieu of a required automatic smoke exhaust system or an automatic smoke-and-heat vent system, if the floor area of the whole fire compartment is not more than 3 500 m².

Example 2

Example 2 looks at a single storey shopping complex containing a mall, as shown in [Figure E2.2b\(2\)](#). The fire compartment is 15 900 m², therefore smoke exhaust/venting is required (if the floor area of the fire compartment had been less than 3 500 m², a sprinkler system could have been used instead of a smoke exhaust/venting system). Smoke exhaust or venting is not required to shop B, which opens onto the mall, because the floor area is less than 1 000 m². It is also not required to shop D, because the floor area is less than 2 000 m², it does not open onto the mall, and the main entrance is to a road or open space.

Shop	Area	Entry	Smoke exhaust OR smoke-and-heat vents
A	900 m ²	From open space	None required as it is single storey, the floor area is less than 2 000 m ² and the main entrance opens to a road or open space
B	900 m ²	From mall	None required as the floor area is less than 1 000 m ²
C	900 m ²	From mall and open space	None required as the floor area is less than 1 000 m ²
D	1 900 m ²	From open space	None required as it is single storey, the floor area is less than 2 000 m ² and the main entrance opens to a road or open space
E	1 900 m ²	From mall	Required as the floor area is over 1 000 m ² and opens onto mall
F	1 900 m ²	From mall and open space	Required as the floor area is over 1 000 m ² and opens onto mall
G	2 500 m ²	From open space	Required as the floor area is more than 2 000 m ²
H	2 500 m ²	From mall	Required as the floor area is over 1 000 m ² and opens onto mall
I	2 500 m ²	From mall and open space	Required as the floor area is over 1 000 m ² and opens onto mall

Shop	Area	Entry	Smoke exhaust OR smoke-and-heat vents
Mall	—	—	Required as the fire compartment has a floor area over 2 000 m ²

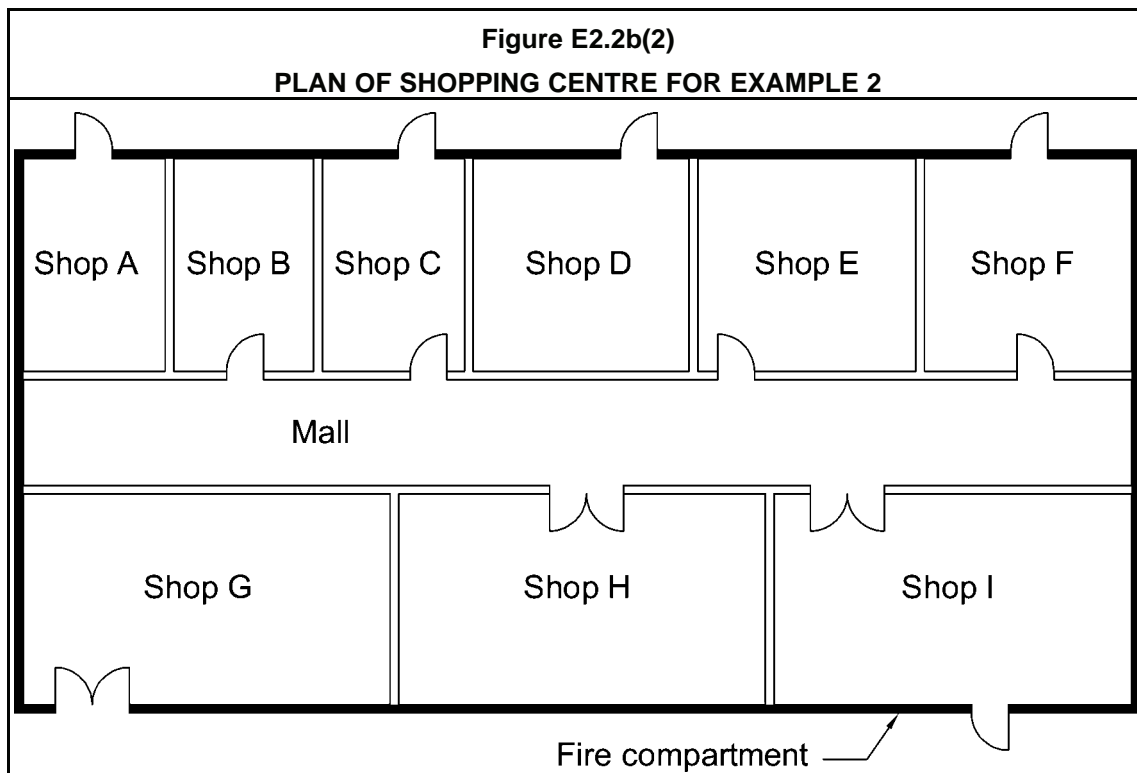

Class 9 assembly buildings

Table E2.2b—greater uniformity and consistency

Assembly buildings cover a wide range of uses with varying degrees of hazards. **Table E2.2b** addresses some of the uses to enable greater uniformity in the treatment of the buildings or parts of buildings. It provides for assembly buildings generally, except for certain low hazard occupancies which have been exempted from compliance.

Exempted assembly buildings

Certain **Table E2.2b** provisions for assembly buildings do not apply to schools, apart from the automatic shutdown of air-handling systems in lecture theatres. This is because such buildings may have alarm systems with which the occupants are familiar, and the occupants are usually under a sufficient level of control to enable quick and orderly evacuation.

Concessions are granted for sporting complexes, excluding indoor stadiums with total spectator seating of more than 1000, principally because the risk levels are not high, particularly with regard to open-air complexes. Buildings used solely for religious worship are also exempt.

Assembly buildings with floor area over 2 000 m²

The **Table E2.2b** provisions for smoke exhaust or smoke-and-heat vents are applicable to fire compartments having a floor area of more than 2 000 m², except that certain concessions apply to low rise buildings.

If the floor area of the fire compartment is not more than 5 000 m², smoke extraction need not be provided if the building has a rise in storeys of two or less, and a smoke detection and alarm system, or a sprinkler system is installed.

Nightclubs, discotheques and the like

The **Table E2.2b** provisions apply to all nightclubs, discotheques and the like, regardless of the floor area, in recognition of the high hazards generated by such factors as:

- occupant density;
- access control;
- indoor environment;
- quantity and location of soft furnishings;
- whether or not smoking is permitted; and
- occupant behaviour.

Exhibition halls

The **Table E2.2b** provisions for exhibition halls which are used for trade displays and the like are based on them having hazards similar to those for shopping centres and indoor markets.

Theatres and public halls

The **Table E2.2b** provisions only apply to those theatres and public halls which are considered a high hazard occupancy due to the potential fire load associated with the stage and backstage areas and/or rigging lofts. Under Part **H1**, such theatres and public halls are also required to be sprinkler protected or have the stage and backstage areas separated from the audience by a proscenium wall.

The **Table E2.2b** provisions for these occupancies are similar to those for assembly buildings. The provision for automatic shutdown of air-handling systems (which do not form part of a smoke management system) is applicable in all such buildings, including those serving school lecture theatres not more than 2 000 m² in area.

Other assembly buildings

Table E2.2b includes provisions for general assembly buildings not covered elsewhere. Museums and art galleries with fire compartments in excess of 2000 m² are covered by these provisions.

SPECIFICATION **E2.2a** SMOKE DETECTION AND ALARM SYSTEMS

Deemed-to-Satisfy Provisions

1 Scope

Intent

To state that **Specification E2.2a** relates to the installation and operation of automatic alarm systems.

Automatic smoke detection and alarm systems

Specification E2.2a covers the technical requirements for smoke detection and alarm systems, including such detection as is necessary to activate smoke control systems.

2 Type of system

Intent

To specify compliance requirements for required automatic smoke detection and alarm systems.

Types of smoke detection and alarm systems

Clause 2 covers smoke detection and alarm systems directly referenced in **Tables E2.2a** and **E2.2b**. The application of smoke detection to smoke control systems is addressed in **Clause 5**.

Clause 2 indicates the types of system, in terms of smoke alarm and/or smoke detection, applicable to various Classes of buildings. A smoke detection system is considered necessary in certain Class 3 and Class 9a buildings to facilitate system monitoring as required by **Clause 7**.

Smoke alarm systems

Smoke alarm systems are required in:

- Class 2 buildings;
- smaller Class 3 buildings (see **Clause 2(a)(ii)** regarding larger Class 3 buildings);
- Class 4 parts; and
- smaller Class 9a buildings (see **Clause 2(c)(ii)** regarding larger Class 9a buildings).

Smoke detection systems

Smoke detection systems are required (and in some cases are the sole requirement to satisfy smoke hazard management provisions) in:

- Class 2 buildings;

- smaller Class 3 buildings;
- larger Class 3 buildings;
- Class 4 parts;
- Class 5–8 and Class 9b buildings (note that a smoke detection system complying with **Clause 4** and not a smoke alarm system complying with **Clause 3** is required in these buildings);
- smaller Class 9a building (see **Clause 2(c)(ii)** regarding larger Class 9a buildings); and
- larger Class 9a buildings (note that a smoke detection system complying with **Clause 4** and not a smoke alarm system complying with **Clause 3** is required in these buildings);
- Class 9c buildings.

Combined systems

Combined smoke alarm and smoke detection systems are permitted (as specified) in:

- Class 2 buildings;
- smaller Class 3 buildings (see **Clause 2(a)(ii)** regarding larger Class 3 buildings); and
- Class 4 parts.

A smoke alarm system and a smoke detection system are only required to be installed when required by **Table E2.2a** or **Table E2.2b**.

3 Smoke alarm system

Intent

To specify requirements for required automatic smoke alarm systems.

Smoke alarm systems—**Clause 3(a)**

Smoke alarm systems must include smoke alarms which comply with AS 3786 (see **Clause 3(b)**).

Power to smoke alarm systems must come from the electrical power supply to that part of the building served by the smoke alarm system.

Use of other suitable alarms—**Clause 3(b)**

A smoke alarm can give false alarms if the atmosphere contains particles, such as steam or other vapours, which obscure vision. For example, in a kitchen or a bathroom these conditions may be present. **Clause 3(b)** therefore allows the use of a more suitable alarm in these locations. It is important that the alarm used is suitable for the location and type of fire likely to occur. The suitability of alarms can be determined by reference to AS 1670.1. The alternative of an alarm acknowledgement facility complying with AS 1670.1 provides occupants with an opportunity to mitigate the effects of spurious or unwarranted alarms.

Smoke alarms and residential buildings—**Clause 3(c)**

Clause 3(c) details the installation requirements for automatic smoke alarms in residential buildings (excluding Class 9 buildings).

Smoke alarms located within each sole-occupancy unit need not be interconnected to provide a common alarm.

Smoke alarms located outside the sole-occupancy units, in public corridors and other common areas within the building, must be interconnected to provide a common building alarm in order to alert all building occupants to the potential hazard in the common evacuation routes.

In buildings which do not contain a sprinkler system, **Clause 3(c)(ii)** requires smoke alarms to be installed in public corridors and other internal public spaces. Such spaces would include public foyers, reception areas and enclosed carparks. However, these spaces would not include fire-isolated exits, as they are subject to separate smoke hazard management provisions under **Table E2.2a**.

Smoke alarms and health-care buildings—Clause 3(d)

The application of **Clause 3(d)** is limited by the provisions of **Clause 2(c)** to small health-care buildings, where not more than six patients are accommodated in beds.

Clause 3(d) requires smoke alarms to be installed in public corridors and other internal public spaces. Such spaces would include public foyers, reception areas and enclosed carparks. However, these spaces would not include fire-isolated exits, as they are subject to separate smoke hazard management provisions under **Table E2.2a**.

Interconnection of smoke alarms is required due to the level of compartmentation and the need to alert staff to help occupants who may be confused, non-ambulatory or otherwise dependent on assistance. Manual call points are also necessary in view of the nature of the occupancy.

4 Smoke detection system

Intent

To specify requirements for required automatic smoke detection systems.

Smoke detection systems—Clause 4(a)

Clause 4(a)(i) specifies the circumstances in which AS 1670.1 applies.

Clause 4(a)(ii) specifies that the smoke detection system must activate a suitable building occupant warning system.

Use of other suitable detectors—Clause 4(b)

A smoke detector can give false alarms if the atmosphere contains particles, such as steam or other vapours which obscure vision. For example, in a kitchen or bathroom these conditions may be present. **Clause 4(b)** therefore allows the use of a more suitable detector in these locations. It is important that the detector used is suitable for the location and type of fire likely to occur. The suitability of detectors can be determined by reference to AS 1670.1. The alternative of an alarm acknowledgement facility complying with AS 1670.1 provides occupants with an opportunity to mitigate the effects of spurious or unwarranted alarms.

Residential buildings—Clause 4(c)

Clause 4(c) details the installation requirements for automatic smoke detection systems in residential buildings (excluding Class 9 buildings).

In buildings which do not contain a sprinkler system, **Clause 4(c)(ii)** requires smoke detectors to be installed in public corridors and other internal public spaces. Such spaces would include public foyers, reception areas and enclosed carparks. However, these spaces would not include fire-isolated exits which are addressed in **Table E2.2a**, commercial storerooms, cleaner's rooms, service cupboards or the like.

Health-care buildings—Clause 4(d)

Clause 4(d) applies to all Class 9a buildings which have a smoke detection system. **Clause 4(d)(i)(A)** applies to both within the patient-care area and the path of travel after a person leaves the patient-care area.

Manual call points are required in evacuation routes in view of the nature of the occupancy.

Aged care buildings—Clause 4(e)

In an aged care building, an automatic smoke detection system must be installed in accordance with AS 1670.1. Subject to **Clause 4(a)** of Specification E2.2a, Clause 4.3 of AS 1670.1 lists areas where detectors are required. Manual call points are also necessary in larger buildings in view of the nature of the occupancy.

5 Smoke detection for smoke control systems

Intent

To specify the smoke detection requirements applicable to smoke control systems.

AS/NZS 1668.1 systems—Clause 5(a)

Clause 5(a) covers smoke detection associated with AS/NZS 1668.1 stair pressurisation systems referenced in **Table E2.2a**. It requires the installation of additional detectors adjacent to each bank of lift landing doors. Lift shafts form one of the principal paths for smoke spreading between floors in a multi-compartmented building.

Location and sensitivity—Clause 5(b)

Clause 5(b) covers the location and sensitivity of smoke detectors associated with smoke control systems referenced in:

- **Table E2.2b**, regarding automatic shutdown of air-handling systems.
- **Specification E2.2b**, regarding the smoke exhaust system.

Activation—Clause 5(c)

Under **Clause 5(c)**, smoke detectors which activate a smoke control system must:

- form part of the building's AS 1670.1 smoke detection system or be a separate dedicated system; and
- activate a building occupant warning system complying with **Clause 6**, unless they initiate shutdown of an automatic air-handling system only, in which case they need not activate a building occupant warning system.

6 Building occupant warning system

Intent

To specify the application of building occupant warning systems.

Residential buildings—Clauses 6(a) and (b)

Because of the protection provided by the fire compartmentation of sole-occupancy units in residential buildings, it is not mandatory for a building occupant warning system to have

sounders or speakers installed within each sole-occupancy unit. Accordingly, **Clauses 6(a)** and **(b)** provide for the sound pressure levels to be measured at the entry to each sole-occupancy unit.

Residential aged care and health-care buildings—Clauses 6(c) and (d)

Clauses 6(c) and **(d)** provide for the warning signals to be modified in certain areas within residential aged care and health-care buildings to minimise trauma to occupants who may be confused or immobile. However, in such instances, adequate warning must always be available to staff, carers, employees and the like.

Class 9c aged care buildings—Clause 6(e)

Clause 6(e) requires warning signals to be modified in certain areas within Class 9c aged care buildings to minimise trauma to residents who may be confused or immobile. However, in such instances, adequate warning must always be available to staff, carers, employees and the like. Aged care facilities may contain more than one building. Nevertheless, staff are required to be notified irrespective of their location.

Additional provisions in E4.9

The separate provisions under **E4.9** are for sound systems and intercom systems for emergency purposes in certain buildings.

7 System monitoring

Intent

To specify the system monitoring requirements in high risk occupancies.

High risk occupancies

Clause 7 specifies the system monitoring requirements in high risk occupancies, to enable a timely and appropriate response by the local fire brigade to emergencies in such buildings as:

- certain residential, health-care and aged care buildings;
- shops and assembly buildings provided with mechanical or natural smoke extraction systems; and
- large uncomparted factories and warehouses.

The Standard referenced for the alarm monitoring system is AS 1670.3

SPECIFICATION E2.2b SMOKE EXHAUST SYSTEMS

Deemed-to-Satisfy Provisions

1 Scope

Intent

To state that **Specification E2.2b** outlines the requirements for mechanical smoke exhaust systems.

Mechanical smoke exhaust systems

Specification E2.2b contains the requirements for mechanical smoke exhaust systems.

2 Smoke exhaust capacity

Intent

To specify the capacity and exhaust rates required of mechanical smoke exhaust systems.

Height below the smoke layer—Clause 2(a)

Clause 2(a) defines the height to be maintained to the underside of the smoke layer. This height is used to determine the smoke exhaust capacity for various design fires under steady state conditions.

Exhaust rates—Clause 2(b)

Clause 2(b) requires exhaust rates be determined using **Figure 2.1** of **Specification E2.2b**. It specifies the exhaust rate required relative to the height to the underside of the smoke layer for various fire sizes.

How to use Figure 2.1 of Specification E2.2b

The following needs to be known to use **Figure 2.1** of **Specification E2.2b**:

- The Class of the subject building or part (in the case of Class 9 buildings the use of the building will also need to be considered).
- Whether or not that building or part is to be sprinklered.
- The fire heat release rate measured in megawatts (MW).
- The MW amount is represented in **Figure 2.1** by a specific line which can be identified in the legend inserted in the Figure.

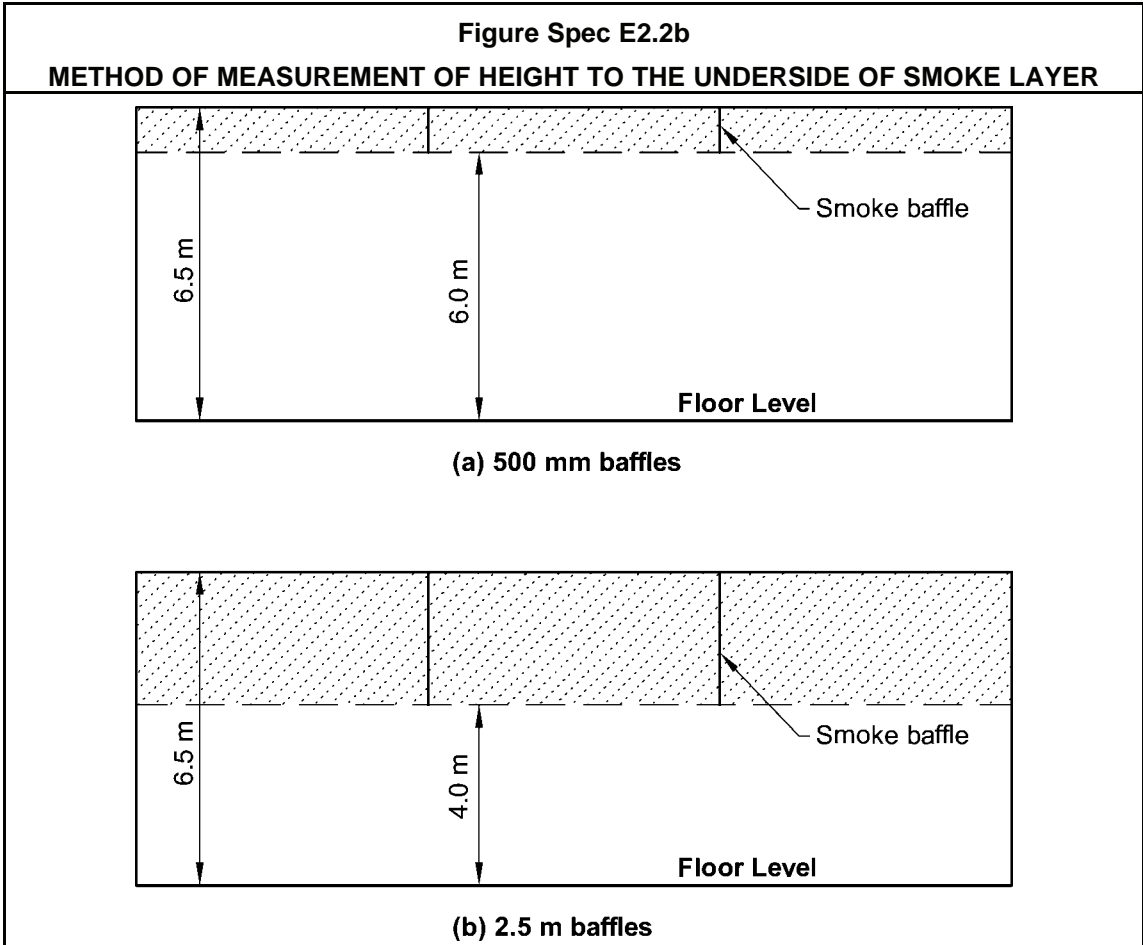

Smoke exhaust rates

The smoke exhaust rate in [Figure 2.1](#) of [Specification E2.2b](#) is based on the rate at which air is drawn (ie “entrained”) into a plume of smoke which is generally symmetrical around a vertical axis where that plume is rising into the hot layer formed by the smoke reservoir.

The height to the underside of the smoke layer is measured from the highest floor level to the underside of the smoke reservoir. The smoke reservoir’s depth is determined by the depth of the smoke baffles/curtains required by [Clause 4](#). See [Figure Spec E2.2b](#).

3 Smoke exhaust fans

Intent

To specify the operational requirements for smoke exhaust fans.

Operational requirements for smoke exhaust fans

[Clause 3](#) describes the operational requirements for smoke exhaust fans to ensure their design performance is maintained for an appropriate time, when operating in high temperature conditions. Fans must also be rated for ambient temperature operation to facilitate routine

maintenance. These provisions also apply to dual purpose fans, that is those used for normal air-handling operations as well as for smoke exhaust.

4 Smoke reservoirs

Intent

To specify the requirements for smoke reservoirs, to enable the containment of smoke in the upper levels of compartments.

Smoke reservoirs—Clause 4(a)

Clause 4(a) requires the division of fire compartments into smoke reservoirs.

Smoke reservoirs are necessary to contain the hot layer in the upper levels of compartments, thus preventing the lateral spread of smoke resulting in excessive cooling and downward mixing of the smoke with the relatively clear layer below which:

- enables occupants to make their way through the comparatively clear air below the hot smoke layer; and
- maintains the smoke above any openings between compartments, thus minimising the risk that smoke will migrate to other areas.

Smoke reservoir dimensions—Clauses 4(b) and (c)

Horizontal area to be less than 2 000 m²—Clause 4(b)

To maximise the effectiveness of smoke reservoirs, the horizontal area formed by a reservoir is limited by **Clause 4(b)** to 2 000 m².

Maximum length in a shopping mall—Clause 4(b)

The maximum length of a smoke reservoir in a shopping mall is limited by **Clause 4(b)** to 60 metres, due to the distance people would be expected to travel below a smoke layer while evacuating to a safe place, having regard to the potential for smoke, from a fire in a mall or adjacent specialty shop, to flow into more than one reservoir.

Depth—Clause 4(c)

Clause 4(c) specifies that the smoke reservoir must be of “sufficient” depth to contain the smoke layer.

Bulkhead or smoke baffle—Clause 4(d)

Clause 4(d) deals with the location and depth of a bulkhead or smoke baffle/curtain. Any bulkhead and smoke baffle/curtain must be non-combustible. **Clause 4(d)** applies only to multi-storey fire compartments.

Smoke needs to be contained within the floor reservoir, and so the integrity of the containment must be maintained at the edges of voids in buildings, such as atriums, by the provision of non-combustible bulkheads or baffles.

5 Smoke exhaust fan and vent location

Intent

To make sure that exhaust fans and vents do not draw clean air up through the smoke layer.

Prevention of “plug-holing”

For a given depth of smoke layer, there is a maximum rate at which smoke can be extracted from a single inlet before air is drawn from below the smoke layer. This is sometimes referred to as “plug-holing”.

Where the smoke layer is relatively shallow, more than one extraction point may be needed to minimise “plug-holing”. It may also be necessary to distribute the extraction points to prevent the formation of stagnant regions leading to excessive cooling and downward mixing of smoke with the relatively clear air below.

Specific criteria are not given as the design is dependent on actual building layout.

6 Make-up air

Intent

To provide air to replace that being exhausted by the smoke exhaust system.

Maintenance of the smoke layer—Clause 6(a)

It is necessary to introduce “make-up air” to replace the air being exhausted by the smoke exhaust system, to:

- maintain the smoke layer at a level which keeps a reasonable amount of clear air underneath; and
- minimise the risk that smoke will flow below the lower levels of the smoke reservoir and migrate to other areas.

Low velocity—Clause 6(b)

Make-up air introduced below the smoke layer must be at relatively low velocities, to minimise any disturbance to the smoke layer. Make-up air introduced at higher velocities may cause:

- smoke to be drawn down from the hot layer, called the “venturi effect”, leading to a loss of visibility in the space below; and
- difficulties for people attempting to exit against the in-rush of air through doorways.

Multi-storey fire compartments—Clause 6(c)

Clause 6(c) deals with the provision of make-up air across any vertical opening from the building void to the fire-affected storey. This aims to minimise the risk of smoke spreading from the fire-affected storey to other storeys.

Non-prescriptive provisions

Specific criteria are not given in **Clause 6** as the design is dependent on actual building layout.

7 Smoke exhaust system control

Intent

To specify the control requirements for smoke exhaust systems and automatic make-up air arrangements.

Sequential activation—Clause 7(a)

To make sure that the smoke exhaust fan (or fans) operate in the designed manner, **Clause 7(a)** requires that the fans are activated sequentially by smoke detectors, and arranged in zones to match the smoke reservoir served by the fan (or fans).

Automatic shutdown—Clause 7(b)

Clause 7(b) requires air handling systems (which generally supply air to upper storeys in high rise buildings) to shut down on the activation of the smoke exhaust system where the air handling system:

- does not form part of the smoke hazard management system;
- is not an individual room unit operating at a rate of less than 1000 L/s; or
- is not a miscellaneous exhaust air system installed in accordance with Sections 5 and 11 of AS/NZS 1668.1.

This requirement minimises any disturbance to the hot smoke layer and limits smoke being distributed to other non-fire-affected areas of the building by way of the system.

Clause 7(b) is subject to **Clauses 7(c)** and **(d)**.

Concessions—Clauses 7(c) and (d)

A number of additional concessions to **Clause 7(b)** are allowed, including:

- **Clause 7(c)**—systems supplying a single storey fire compartment may supply 100 per cent outside air to the non-fire-affected areas as a means of supplying make-up air for the extraction system serving fire-affected areas; and
- **Clause 7(d)**—systems supplying a multi-storey fire compartment must supply 100 per cent outside air to the non-fire-affected areas as a means of supplying make-up air for the extraction system serving fire-affected areas.

Override control—Clauses 7(e) and (f)

To allow manual control of the smoke exhaust system by the fire brigade, **Clause 7(e)** requires an override control to be located adjacent to the fire indicator panel.

In a theatre, an additional manual control must be provided in accordance with **Clause 7(f)** to allow the stage manager to control the smoke exhaust system during a performance. This is considered necessary because of any special effects which may cause a false alarm.

Electric cabling—Clause 7(g)

To reduce the risk of the smoke exhaust system failing during a fire, **Clause 7(g)** requires the electric cabling to the system's essential components to be protected from fire in accordance with AS/NZS 1668.1.

8 Smoke detection

Intent

To clarify the location of the requirements for the installation of a smoke detection system.

The smoke detection requirements for smoke exhaust systems are addressed in [Clause 5](#) of **Specification E2.2a**. Such smoke detection systems designed to operate smoke-and-heat vents must also activate an occupant warning system.

SPECIFICATION **E2.2c** SMOKE-AND-HEAT VENTS

Deemed-to-Satisfy Provisions

1 Adoption of AS 2665

Intent

To nominate AS 2665 as the basis for the installation of automatic smoke-and-heat vents, and specify its limitations.

AS 2665

AS 2665 is adopted as the requirement for the installation of a system of automatic smoke-and-heat vents.

Smoke-and-heat vents

Smoke-and-heat vents are dependent on the temperature of the hot smoke layer or the presence of smoke for effective operation. The area of the smoke reservoirs is, therefore, limited by AS 2665 to 1500 m², which is smaller in size than that for mechanical smoke exhaust systems.

It is important to note that the maximum length of a smoke reservoir in a shopping mall is limited to 60 metres due to the distance people travel below a smoke layer while evacuating, having regard to the potential for smoke from a fire in a mall or adjacent specialty shop to flow into more than one reservoir.

AS 2665 requires all smoke-and-heat vents within the same reservoir to operate simultaneously to prevent the formation of stagnant regions leading to excessive cooling and downward mixing of smoke with the clear air below.

In the event of loss of power to operating mechanisms (such as actuators or solenoids), AS 2665 requires smoke-and-heat vents to fail-safe open.

Permanently open vents may be used to replace all or part of the total number of smoke-and-heat vents provided they comply with the relevant parts of AS 2665.

2 Controls

Intent

To specify the controls for automatic smoke-and-heat vents.

Smoke-and-heat vents

Smoke-and-heat vents installed for smoke hazard management purposes in accordance with [Table E2.2b](#) must primarily be initiated on the detection of smoke to enable early operation of the vents.

Where smoke-and-heat vents are installed in Class 7 and Class 8 buildings in accordance with **C2.3(a)**, the operation of the vents by means of fusible links is considered adequate.

The smoke detection requirements for smoke exhaust systems are addressed in **Clauses 5 and 7** of **Specification E2.2a**. Such smoke detection systems designed to operate smoke-and-heat vents must also activate an occupant warning system.

Override control

It is important to note that to allow manual control of the smoke exhaust system by the fire brigade, AS 2665 requires an override control to be located adjacent to the fire indicator panel.

PART E3 LIFT INSTALLATIONS

Objective

EO3

All people using a building, including those with disabilities, must be able to travel safely in a lift. Lifts must help emergency services personnel to evacuate sick or injured people. Lifts should also help the fire brigade to transport fire fighters and their equipment.

Functional Statements

EF3.1

EF3.1 only applies where a passenger lift is provided.

Under **EF3.1(a)**, the lift must be suitable for people with a disability.

EF3.2

In high-rise buildings and those Class 9a buildings that have patient care areas above road or open space level, a lift must be able to assist emergency services personnel such as:

- ambulance officers carrying equipment to assist a sick or injured person; and
- the fire brigade with equipment.

Lifts in these buildings must also assist with the evacuation of any person unable to use a stairway unassisted.

EF3.3

People must be warned not to use a lift during a fire or other emergencies.

EF3.3 applies to all passenger lifts.

Performance Requirements

EP3.1

Under **EP3.1(a)**, where emergency lifts are required under **EP3.2**, at least one of those required lifts, to the degree necessary, must have stretcher facilities. Where there is a single emergency lift it must be the stretcher lift.

Under **EP3.1(b)**, where passenger lifts are provided (and **EP3.1(a)** does not apply because an emergency lift is not required under **EP3.2**), at least one of those passenger lifts must have stretcher facilities.

When a person becomes injured in a building, a stretcher may be needed to evacuate them.

EP3.1 does not contain any specification of what is acceptable as “stretcher facilities”. However, as a guide, **E3.2** contains suitable dimensions for a lift car required to accommodate a stretcher.

EP3.2

In high-rise buildings (ie with an effective height of more than 25 metres), and those Class 9a buildings which have patient care areas above road or open space level, a lift must be available to aid the fire brigade and any other emergency services personnel.

EP3.2 expects that any lift described above is adequately protected in case of fire.

Emergency lifts must service the same floors as any other lift. Therefore, if a level such as a plant-room level does not have any lifts serving it, there is no necessity to provide an emergency lift service to that plant-room level.

EP3.3

A suitable notice must be provided, or other measure taken, so that people do not use a lift during a fire or other emergency. This applies to all passenger lifts.

EP3.4

EP3.4 should be read in conjunction with Part **D3**. Where access to upper floors is provided by lifts to satisfy Part **D3**, or where lifts are installed in a building that is required to be accessible under Part **D3**, those lifts must be suitable for use by people with a disability.

E3.6 provides information on limitations to the use of various types of passenger lifts in certain situations. It also provides information on the size of lift cars and platforms, the application of features such as lighting, door opening widths, handrails and audible and visual information for specific lift types.

PART E3 LIFT INSTALLATIONS

Deemed-to-Satisfy Provisions

E3.0 Deemed-to-Satisfy Provisions

Intent

To clarify that **EP3.1** to **EP3.4** will be satisfied if compliance is achieved with **E3.1** to **E3.8** and, for public transport buildings, **Part H2**.

E3.1 to **E3.7** and **EP3.1** to **EP3.4**

Where a Building Solution is proposed to comply with the Deemed-to-Satisfy Provisions, compliance with **E3.1** to **E3.8** and **Part H2** achieves compliance with **EP3.1** to **EP3.4**.

Where a Building Solution is proposed as an Alternative Solution to the Deemed-to-Satisfy Provisions, the relevant Performance Requirements must be determined in accordance with **A0.10**. (See comment on **A0.10**).

E3.1 * * * * *

In BCA 1990 this clause contained provisions relating to Class 1 and Class 10 buildings. Provisions for Class 1 and Class 10 buildings are now covered by Volume Two. **E3.1** has been left blank rather than renumber subsequent clauses.

E3.2 Stretcher facility in lifts

Intent

To require lifts to be able to accommodate a stretcher.

Under **E3.2(a)**, stretcher facilities are required in one of the emergency lifts required by **E3.4**. Where no emergency lift is required and passenger lifts are provided, then stretcher facilities are to be provided to one lift serving any storey above an effective height of 12 metres.

Where there is just a single emergency or passenger lift that lift must have stretcher facilities.

E3.2(b) sets out the minimum dimensions of a lift car to accommodate a stretcher. It is allowable to have a protuberance or an openable recess in the lift car to accommodate a stretcher with the dimensions stated.

E3.3 Warning against use of lifts in fire

Intent

To alert people to the dangers of using lifts during a fire.

E3.3 applies to all passenger lifts, even if the building has an effective height of less than 12 metres.

A suitable warning sign must be provided near a lift or lift call button, so that people do not use a lift at an inappropriate time (note that **E3.3(b)** specifies that such a sign must warn occupants against lift use during a fire).

E3.3 does not apply to small lifts, such as “dumb waiters”, not intended to accommodate a person.

E3.3(b) and **Figure E3.3** specify the nature, content, and minimum dimensions for the warning sign. The size and colour of the lettering on the sign are important, so that the sign can be easily read and stand out against the background colour.

E3.4 Emergency lifts

Intent

To require that suitable lifts be available for emergency services personnel.

E3.4 only applies to buildings with an effective height above 25 metres, and in certain Class 9a buildings.

E3.4(b) clarifies that a passenger lift may be used as an emergency lift, provided it satisfies the other provisions of **E3.4**.

An emergency lift must serve all the floors in a building served by passenger lifts but is not required to serve other floors such as those containing only plant and equipment.

One emergency lift is not required to serve all floors in a building. Just as one bank of passenger lifts may serve certain floors, so may emergency lifts.

E3.4(c)(i) requires that where more than one passenger lift serves a floor, at least two emergency lifts must serve that floor.

E3.4(c)(ii) requires that if the passenger lifts are in separate shafts, the emergency lifts must also be in separate shafts. This maximises the probability of the emergency lifts operating in an emergency, by minimising the risk that a fire in one shaft will endanger both lifts. It also excludes from its requirements a lift that is within an atrium and not wholly contained within a shaft.

To protect people using an emergency lift during a fire, **E3.4(d)** requires it to be within a fire-resisting shaft in accordance with the requirements of **C2.10**.

Appendix A of AS 1735.1 and AS 1735.2 contains specific provisions for emergency lifts. These provisions allow emergency services personnel to override the operation of the lift, including the re-call of the lift to a nominated floor. Note **E3.5** with regard to the non-applicability of Clause 12.2 of AS 1735.2.

The **E3.4(e)(ii)(A)** dimensions for an emergency lift in a Class 9a building serving a patient care area are to accommodate a stretcher or bed for non-ambulatory patients.

The **E3.4(e)(ii)(B)** requirement for an emergency lift in a Class 9a building serving a patient care area to be connected to a standby power supply (if the building has such a system) is in recognition of the risk likely in the event of a power failure.

Under **E3.4(e)(iii)**, all emergency lifts serving buildings with an effective height of more than 75 metres must be capable of carrying a weight of at least 600 kg. This recognises the increased difficulties emergency services personnel (particularly fire brigade officers) face in carrying heavy equipment to such heights.

E3.5 Landings

Intent

To require that safe movement be available to and from lift landings.

Under **E3.5(a)**, Clause 12.2 of AS 1735.2 does not apply because it only requires a width of path of travel from a lift landing to an exit to be 1 000 mm. This is considered to be inadequate. Access to and egress from lift landings must therefore comply with **Section D**, including access for people with disabilities.

E3.5(c) references the fact that **Section D** includes provision for access for people with disabilities.

E3.6 Passenger lifts

Intent

To require that lifts necessary for use by people with a disability are suitable.

E3.6 only applies when a passenger lift is required by **D3.3(b)** for vertical movement of people with a disability. **E3.6** describes limitations to the use of various types of passenger lifts in certain situations. It also provides information on the size of lift cars and platforms, the application of features such as lighting, door opening widths, handrails and audible and visual information for specific lift types.

The floor plate sizes of low-rise lifts are limited to those sizes specified in the applicable Australian Standard and generally are 810 mm x 1200 mm or 1100 mm x 1400 mm depending on the type of lift. Lifts that can travel beyond 12 m are required to have a larger lift floor plate size of 1400 mm x 1600 mm.

There are a number of limitations on the use of stairway platform lifts (AS 1735.7) including that they must not be installed if it is possible to use another type of passenger lift described in **E3.6**.

Some types of lifts must not be used in high traffic public use areas of certain buildings. For example, an AS 1735.7 or AS 1735.15 lift must not be used at the entry to a theatre. However, these types of lifts may be used to provide access to the stage in a theatre because the access to the stage is not considered to be a high traffic public use area.

E3.7 Fire-service controls

Intent

To require fire-service controls in all passenger lifts.

By having all lift cars fitted with fire-service controls there is no confusion as to which lift car can be used by emergency services personnel, and it also increases the reliability of having an operational lift in the event of an emergency. This does not require all passenger lifts to be increased in size to take a stretcher.

E3.8 Aged care buildings

Intent

To require the installation of a lift where residents of a Class 9c aged care building are on levels not having access to a road or open space.

E3.8 applies to Class 9c aged care buildings. It requires all levels of aged care buildings to have direct access to a road or open space via a ramp or lift capable of carrying a stretcher. This is to overcome the difficulty experienced by some residents negotiating stairways and enable the use of stretcher facilities on all levels of an aged care building. It also assists with the daily functioning of the building, especially with the use of mobile baths and other equipment.

PART E4

EMERGENCY LIGHTING, EXIT SIGNS AND WARNING SYSTEMS

Objective

EO4

Provision of light, signage and warning

This Objective covers three of the basic elements required to help occupants evacuate a building in an emergency:

- light to see the evacuation route;
- signage to indicate the evacuation route; and
- warning of the emergency, so they know they need to evacuate.

Functional Statement

EF4.1

Emergency lighting—EF4.1(a)

Artificial lighting is often one of the first things to fail during a building emergency. This can significantly impair the ability of the occupants to evacuate the building. Accordingly, a building must provide adequate lighting on the failure of artificial lighting in an emergency.

Warning of occupants—EF4.1(b)(i)

Many of the emergency protection systems built into the BCA are time related, particularly those designed to protect occupants from a fire. The effectiveness of this protection may be negated if occupants are not made aware of the need to evacuate. It is essential that adequate early warning systems advise of the need to evacuate the building as soon as possible.

Evacuation management systems—EF4.1(b)(ii)

Emergency evacuation requires all evacuations to maximise the opportunity for occupants to reach a place of safety. Since the BCA generally relates to the construction of a building, rather than its on-going use, it can only require the installation of a system to assist in the management of the evacuation process. It cannot demand, for example:

- training, so that the evacuation process is undertaken automatically;
- allocation of staff to assist with evacuation, particularly if the building is likely to contain occupants who have been unable to benefit from prior training; or
- a detailed evacuation plan.

Identification of exits and paths of travel—EF4.1(b)(iii)

Occupants need to be able to identify their route to safety without hesitation. The emergency route must be signed in a way which is clear and unambiguous.

Performance Requirements

EP4.1

Emergency lighting

The intent of **EP4.1** is to provide occupants with satisfactory emergency lighting. Such lighting must provide sufficient visual conditions in a building to aid safe evacuation during an emergency. Accordingly, it must supply sufficient light to:

- minimise the risk of panic;
- illuminate the safe route to an emergency exit; and
- otherwise assist in the orderly and safe evacuation of the building.

EP4.1 Limitations

EP4.1 does not apply within sole-occupancy units of Class 2, 3 or 9c buildings or within the Class 4 part of a building.

Operation when artificial lighting fails

An emergency lighting system in a building only needs to operate on the failure of the normal artificial lighting system (see **EF4.1(a)**).

“To the degree necessary”

EP4.1 uses the expression “to the degree necessary”. The BCA recognises that not all buildings need emergency lighting.

Any decision made in this context can extend to not requiring an item to be installed or a particular level of performance to be achieved, if that is the appropriate action to be taken.

Criteria for emergency lighting

As set out in **EP4.1**, emergency lighting must be installed when necessary, and be appropriate to a number of factors, including:

- the use of the building will affect the fire load in the building;
- the size of the building's floor area which is a measure of the size of any potential fire, and the area through which occupants must travel to reach safety; and
- the distance of travel to an exit which is a measure of the distance occupants must travel to reach safety (and therefore the time necessary to reach safety).

“Appropriate to”

The lighting must be “appropriate to” the matters listed in **EP4.1**, which relate to the amount of light in a particular building, and which is necessary to enable evacuation in an emergency.

Examples

The following are two examples of what may or may not be “appropriate” in this case. They should not be regarded as absolute.

Commercial poultry building

A commercial poultry building:

- has a high level of natural light;

- is occupied by only a few workers, likely to know the shed well;
- is rarely occupied by humans at night;
- is without a substantial floor space accessible by humans; and
- has short and direct routes to the exit doors.

In such a case, it may be reasonable for no emergency lighting to be provided.

Cinema

A cinema, however:

- has no natural light; and
- is occupied regularly by large numbers of people who do not know the building or its evacuation plan well.

In such a case, even having no regard to the floor area or the distance of travel to an exit, it is probable that the building will require emergency illumination.

Deemed-to-Satisfy Provisions

E4.2 provides a number of examples where emergency lighting systems must be installed if the proposal being considered involves a Building Solution which utilises the Deemed-to-Satisfy Provisions.

Alternative Solutions

If an Alternative Solution is being used, it may be appropriate to assess it using **E4.2** for guidance purposes.

Stand-by lighting and safety lighting

The emergency lighting system should not be confused with the following:

Stand-by lighting

This is a term used to describe a lighting system providing a relatively high lighting level to allow normal activities to continue in case of a failure of the normal lighting system.

Example

A generator may be used to provide a “working” level of light in case of a power failure. Such a level of light may be much more than is required to achieve a safe evacuation.

Safety lighting

This is a term used to describe a lighting system provided for the safety of occupants working near hazardous equipment or processes.

Example

The safe operation of specific equipment may require a level of lighting beyond that normally required for work conditions, and significantly beyond that required for safe evacuation.

EP4.2

Identification of exits

The intent of **E4.2** is to provide occupants with clear and concise information on what route to take to evacuate a building in an emergency. This may require the installation of emergency signage or other suitable means to identify egress routes and exits and assist in orderly evacuation.

This information must be easily obtainable, despite the reduced lighting conditions, even though emergency lighting systems have been provided.

EP4.2 Limitations

EP4.2 does not apply within sole-occupancy units of Class 2 or 3 buildings or within the Class 4 part of a building.

“To the degree necessary”

EP4.2 uses the expression “to the degree necessary”. The BCA recognises that not all buildings need signs or markers to facilitate evacuation.

Any decision made in this context can extend to not requiring an item to be installed or a particular level of performance to be achieved, if that is the appropriate action to be taken.

Criteria for identification of exits

A building proposal must make sure that the means used to identify egress routes and exits are sufficient to enable occupants:

- to locate the exits;
- to find their way to the exits;
- to clearly see any signs or other markers; and
- to be able to continue to see any signs or markers during their evacuation, in case of a failure of the normal lighting system.

Examples

The following are two examples of what may or may not be suitable exit identification. They should not be regarded as absolute.

Commercial poultry building

A commercial poultry building:

- has a high level of natural light;
- is occupied by only a few workers, who are likely to know the shed well;
- is rarely, if ever, occupied by people at night; and
- has direct routes to the exit doors.

In such a case, occupants will be able to easily find the way to the exits. Accordingly, exit signs would not be necessary.

Cinema

A cinema, however:

- has no natural light; and
- is occupied regularly by large numbers of people who do not know the building or its evacuation routes.

In such a case, clear and illuminated signage would be required, located in common view points to encourage evacuees to continue travelling in a specific direction.

Deemed-to-Satisfy Provisions

If a builder is undertaking a Building Solution using the Deemed-to-Satisfy Provisions, there are a number of relevant provisions regarding:

- the installation of exit signs; and
- the size, colour and wording of signs.

Alternative Solutions

If an Alternative Solution is being used, it may be appropriate to assess it using the [Part E](#) Deemed-to-Satisfy Provisions for guidance purposes.

EP4.3

Early warning and communication

The intent of [EP4.3](#) is to maximise the opportunities for occupants to evacuate. This may include giving them as early a warning as possible and providing means of communicating both the need for evacuation and the process of evacuation.

Evacuation management systems

Emergency evacuation requires that the evacuation maximises the opportunity for occupants to reach a place of safety. Since the BCA relates to the construction of a building it can only require the installation of a system. It cannot require:

- training, so that the evacuation process is undertaken automatically;
- allocation of staff to assist with evacuation, particularly if the building is likely to contain occupants who have been unable to benefit from prior training; or
- a detailed evacuation plan.

“To the degree necessary”

[EP4.3](#) uses the expression “to the degree necessary”. The BCA recognises that different buildings require differing types and degrees of sound systems and intercom systems for occupants in an emergency.

Any decision made in this context can extend to not requiring an item to be installed or a particular level of performance to be achieved, if that is the appropriate action to be taken.

Criteria for sound system and intercom system for emergency purposes

As set out in [EP4.3](#), to warn occupants and assist with an evacuation, a sound system and intercom system for emergency purposes must be appropriate to a number of factors, including:

- the floor area of the building which is a measure of the size of any potential fire, the area to be covered by a warning sound or signal, and the difficulty of intercommunication;
- the function of the building will affect the fire load in the building, and the difficulty such a load may cause in evacuating occupants; and
- the height of the building which is a measure of the difficulty of evacuation, search and rescue, and communication.

“Appropriate to”

The sound system and intercom system for emergency purposes must be “appropriate to” the matters listed in [EP4.3](#), which principally relate to the type of system which is necessary to enable evacuation in an emergency.

The BCA recognises that different emergency warning and communication needs may exist, depending on the size of the building, its function, use and height.

Examples

The following reveal what may or may not be “appropriate”. They should not be regarded as absolute.

Commercial poultry building

A commercial poultry building:

- has a comparatively small floor area accessible by occupants;
- is occupied by only a few workers, who are likely to know the shed well; and
- has good sight lines around the building.

In such a case, the ability of occupants to notice an emergency starting, particularly a fire, and their capacity to easily notify other occupants and exit quickly may mean that there is little or no need for sound systems and intercom systems.

Cinema

In a cinema, however, there is a large number of people who do not know the building or its evacuation routes.

In such a case, the building's occupants may be:

- unlikely to notice the commencement of an emergency, which could involve electrical or equipment failure in parts of the building beyond the auditorium; and
- unlikely to automatically know when or how to exit the building.

Accordingly, there may be a need for specialised sound systems and intercom systems.

Deemed-to-Satisfy Provisions

If the proposal being considered involves a Building Solution which utilises the Deemed-to-Satisfy Provisions, the Deemed-to-Satisfy Provisions provide a number of situations where sound systems and intercom systems for emergency purposes must be installed.

Alternative Solutions

If an Alternative Solution is being used, it may be appropriate to assess it using the [Part E4](#) Deemed-to-Satisfy Provisions for guidance purposes.

PART **E4** **EMERGENCY LIGHTING, EXIT SIGNS AND WARNING SYSTEMS**

Deemed-to-Satisfy Provisions

E4.0 Deemed-to-Satisfy Provisions

Intent

To clarify that compliance with **EP4.1** to **EP4.3** will be achieved by compliance with **E4.1** to **E4.9**.

Where a Building Solution is proposed to comply with the Deemed-to-Satisfy Provisions, **E4.0** clarifies that if compliance can be demonstrated with **E4.1** to **E4.9**, then compliance has been achieved with **EP4.1** to **EP4.3**.

Where a Building Solution is proposed as an Alternative Solution to the Deemed-to-Satisfy Provisions, the relevant Performance Requirements must be determined in accordance with **A0.10**. (See comment on **A0.10**).

E4.1 * * * * *

In accordance with the decision not to change the numbering of the BCA from that of the previous edition, the space previously occupied by this provision has been left blank. The previous **E4.1** provisions are now located in the BCA Performance Requirements.

E4.2 Emergency lighting requirements

Intent

To minimise the risk of death or injury to occupants during an emergency because of an inability to see their way along an exit path of travel.

Reasons for emergency lighting

See the comment on **EP4.1**.

Locations for emergency lighting

E4.2 sets out the locations in buildings, and in some cases the classes of building, in which emergency lighting must be installed.

Each sub-provision of **E4.2** must be considered separately. It is possible that more than one may apply to any single building. Where any sub-provision requires emergency lighting, such lighting must be provided, even though another sub-provision may appear to provide an exemption.

Example

Consider a single storey building comprised of three open plan Class 6 sole-occupancy units of 150 m² each, where each sole-occupancy unit has one exit direct to open space:

- **E4.2(e)** specifies that emergency lighting is not required in each sole-occupancy unit (note that the 300 m² minimum in **E4.2(e)(i)** applies to an individual sole-occupancy unit); but
- **E4.2(f)** specifies that every room or space to which there is public access (in this case, each entire sole-occupancy unit—note that the 300 m² minimum in **E4.2(f)(i)** applies to the entire storey) must have emergency lighting.

In this case, as **E4.2(f)** requires emergency lighting, such lighting must be provided despite the fact that the sole-occupancy units do not require such lighting under **E4.2(e)**.

Extent of emergency lighting

All fire-isolated exits—E4.2(a)

Emergency lighting is required to be installed in all fire-isolated exits, because it is unusual for them to be provided with sufficient amounts of natural lighting for safe evacuation.

Storeys over 300 m² in Class 5–9 buildings—E4.2(b)

Emergency lighting is required in every storey with a floor area over 300 m² in a Class 5–9 building, as follows:

- Every passageway, corridor, hallway, or the like forming part of a path of travel to an exit, because these areas are unlikely to be provided with sufficient amounts of natural lighting for safe evacuation.
- Any room larger than 100 m² which does not open to a corridor or other space containing emergency lighting, or a road or open space.
- Any room larger than 300 m². Note that this size of room is relatively large, and **E4.2(b)(iii)** applies irrespective of whether or not the room opens to a corridor or other space containing emergency lighting or a road or open space.

Class 2, Class 3 and Class 4—E4.2(c)

Emergency lighting is required in any passageway, corridor, hallway, or the like in Class 2 and Class 3 buildings and Class 4 parts, if the distance of travel from the door leading from a sole-occupancy unit is greater than six metres to:

- a fire-isolated exit;
- an external stairway used in lieu of a fire-isolated stairway;
- an external balcony leading to a fire-isolated exit; or
- a road or open space.

This provision reflects the likelihood that such buildings will be occupied at night, when the occupants are likely to be asleep.

Non-fire-isolated stairways—E4.2(d)

Emergency lighting is required to be installed in all required non-fire-isolated stairways (note that **E4.2(d)** applies even if the other provisions of **E4.2** do not require the installation of emergency lighting).

Sole-occupancy unit in Class 5, Class 6 or Class 9—E4.2(e)

Emergency lighting is required to be installed in a sole-occupancy unit of a Class 5, Class 6 or Class 9 building if:

- the area of the unit is larger than 300 m²; and
- the exit from the unit does not open to the specified areas or spaces which are likely to have adequate natural lighting.

Publicly accessible room in Class 6 or Class 9b—E4.2(f)

Emergency lighting is required to be installed in every publicly accessible room or space in a Class 6 or Class 9b building if:

- the area of the storey is relatively large (ie greater than 300 m²);
- any point on the floor is more than 20 metres from the specified doorways (which is a distance compatible with **Section D** requirements);
- egress requires a vertical rise of 1.5 metres;
- egress requires any vertical rise, if insufficient light is not admitted from outside the building; or
- the storey provides a path of travel from another storey included in **E4.2(f)(i)–(iii)**. In this case, once a person enters an area with emergency lighting, then that lighting must be maintained throughout the remainder of the egress path.

This provision reflects the likelihood that such buildings are used by large numbers of the public who do not have any knowledge of the building or its exits.

Class 9a—E4.2(g)

Emergency lighting is required to be installed in the specified areas in Class 9a buildings, because such buildings are used by patients who may require assistance to evacuate.

Class 9c—E4.2(h)

Emergency lighting is required to be installed throughout Class 9c aged care buildings excluding within the sole-occupancy units. The requirement is generally aligned with the principles for emergency lighting in Class 9a buildings as described above.

Required fire control centres—E4.2(h)

Emergency lighting is required to be installed in required fire control centres, because they are designed for use by the fire brigade during an emergency, such as a fire.

E4.3 Measurement of distance

Intent

To clarify how distance must be measured for the purposes of emergency lighting required under **E4.2**.

Reasons for emergency lighting

See the comment on **EP4.1**.

To which distances does E4.3 refer?

While not specifically stated, the intention is that the distances referred to in E4.3 to be those calculated in accordance with E4.2(c) and (f)(ii).

Most direct route

The E4.2(c) and (f)(ii) distances are required to be measured the same way as those specified in Section D. See D1.15.

E4.4 Design and operation of emergency lighting

Intent

To specify how an emergency lighting system must operate, to minimise the risk of death or injury to occupants during an emergency because of an inability to see their way along an exit path of travel.

Reasons for emergency lighting

See the comment on EP4.1.

Emergency lighting system and safe evacuation

An emergency lighting system must provide the visual conditions necessary for safe evacuation during an emergency such as a fire. It must be installed in accordance with AS/NZS 2293.1.

It should be noted that this is an emergency lighting system which is only required to operate during an emergency. F4.4(a)(i) requires artificial lighting to be provided within required stairways, passageways and ramps, but does not require such lighting to be illuminated at all times.

E4.5 Exit signs

Intent

To minimise the risk of death or injury to occupants during an emergency because of an inability to find an exit.

Reasons for exit signs

See the comment on EP4.1.

Locations of exit signs

E4.5 sets out the locations in a building requiring the installation of exit signs. Signs must be clearly visible to occupants approaching the exit. They need to be located on, above or adjacent to the specified exits and doors.

Some exemptions to E4.5

E4.7 provides some exemptions to E4.5. See E4.7.

E4.6 Direction signs

Intent

To minimise the risk of death or injury to occupants during an emergency because of an inability to find their way along an exit path of travel.

Reasons for direction signs

Exits may not be visible from all locations within a building. In such cases, exit signs with directional indicators (such as arrows) are required to clearly indicate the direction of travel to required exits.

E4.7 Class 2 and 3 buildings and Class 4 parts: Exemptions

Intent

To specify some circumstances where risk levels do not warrant compliance with [E4.5](#).

Class 2 buildings—[E4.7\(a\)](#)

The BCA considers that the risks to occupants of units within a Class 2 building are less than those to occupants of Class 3 buildings and Class 4 parts. This is because occupants of Class 2 buildings are assumed to be more familiar with:

- the layout of their unit;
- the layout of the building within which the unit is located; and
- Class 4 parts attached to parts of a building with different (and usually greater) fire loads.

Consequently, [E4.7\(a\)](#) grants an exemption for Class 2 buildings from the need to comply with [E4.5](#), on the condition that the buildings comply with certain specific provisions.

With regard to [E4.7\(a\)\(i\)](#), while the size and wording of the exit sign are specified, the structure, method of attachment, or colour and the like are not specified. However, the colour of the word must contrast with that of the background. The building proponent can make this decision as long as the appropriate authority is satisfied.

With regard to [E4.7\(a\)\(ii\)](#), if a suitable alternative means of notification can be found to the requirements of [E4.7\(a\)\(i\)](#), it may be used. The decision is made by the building proponent, who must satisfy the appropriate authority.

Entrances to Class 2, Class 3 or Class 4—[E4.7\(b\)](#)

The BCA assumes that the occupants of units in Class 2 or Class 3 buildings, or in Class 4 parts of a building are familiar with the layouts of their units to allow [E4.7\(b\)](#) to grant an exemption so that exit signs are not required above what is described as the “entrance door”, being either:

- the main door from the unit into the remainder of the building; or
- the door leading directly outside from the unit.

E4.8 Design and operation of exit signs

Intent

To specify how exit signs must be designed and operate, to minimise the risk of death or injury to occupants during an emergency because of an inability to find an exit.

Criteria for exit signs

E4.8 sets out the provisions for required exit signs, which must meet the following criteria:

- they must be visible at all times when the building is occupied by a person who has a legal right of entry. Exit signs have a function during normal periods to make occupants aware of the location of exits; and
- the system must be installed in accordance with AS/NZS 2293.1.

E4.9 Sound systems and intercom systems for emergency purposes

Intent

To minimise the risk of death or injury to occupants through lack of knowledge that an emergency exists or an evacuation is required.

Reasons for emergency warning systems

See the comment on **EP4.3**.

Types of buildings requiring such a system

E4.9 sets out the types of buildings requiring the installation of a sound system and intercom system.

AS 1670.4

Building proposals using the Deemed-to-Satisfy Provisions to achieve the Performance Requirements must comply with **AS 1670.4**, where applicable.

Building with an effective height of more than 25 metres—**E4.9(a)**

In a building with an effective height of more than 25 metres, if a fire starts on one floor, there is a considerable risk that occupants of the other floors might not be aware it has started. Co-ordination of the evacuation process is important. This reduces confusion and congestion in the stairways and accordingly the time taken for the evacuation.

The people most at risk

In a building fire, the highest degree of risk is attached to such people as the very young, people with certain types of disability (such as a mobility disability), the elderly, and those asleep.

The BCA cannot address all possible permutations of people who are likely to be in any particular building. Nonetheless, it does attempt to address the risks that are most likely to be attached to the people most likely to be in particular types of building.

Installation for larger buildings

In most cases, the need to install a sound system and intercom system only applies to larger buildings. The reason for this requirement is the heightened risk that occupants may not be aware of a fire in another part of the building.

Residential aged care and Class 9a buildings

In Class 3 residential aged care buildings and in Class 9a buildings, many of the occupants or patients are unable to evacuate without assistance. There is also an enhanced risk in many of these buildings that residents or patients will be traumatised by loud or insistent alarms. To minimise this risk, the sound system and intercom system:

- must be arranged to warn occupants, including staff, residents and patients; and
- may be adjusted to take account of any special issues regarding residents or patients.

It should be noted that **E4.9** does not apply to aged care buildings. The reference to aged persons in **E4.9(b)(ii)** is not a reference to an aged care building as defined in the BCA. The reference is intended to apply to a Class 3 building used to accommodate the listed people, but not an aged care building. During an evacuation staff would be assisting the occupants to evacuate and would not be expected to perform the function of fire wardens.

HEALTH AND AMENITY

- F1** **Damp and Weatherproofing**
- F2** **Sanitary and Other Facilities**
- F3** **Room Heights**
- F4** **Light and Ventilation**
- F5** **Sound Transmission and Insulation**

SECTION F CONTENTS

SECTION F HEALTH AND AMENITY

Part F1 Damp and Weatherproofing

- Objective FO1
- Functional Statements FF1.1 - FF1.3
- Performance Requirements FP1.1 - FP1.7
- F1.0 Deemed-to-Satisfy Provisions
- F1.1 Stormwater Drainage
- F1.2 * * * * *
- F1.3 * * * * *
- F1.4 * * * * *
- F1.5 Roof coverings
- F1.6 Sarking
- F1.7 Waterproofing of wet areas in buildings
- F1.8 * * * * *
- F1.9 Damp-proofing
- F1.10 Damp-proofing of floors on the ground
- F1.11 Provision of floor wastes
- F1.12 Sub-floor ventilation
- F1.13 Glazed assemblies

Part F2 Sanitary and Other Facilities

- Objective FO2
- Functional Statements FF2.1 - FF2.4
- Performance Requirements FP2.1 - FP2.6
- F2.0 Deemed-to-Satisfy Provisions
- F2.1 Facilities in residential buildings
- F2.2 Calculation of number of occupants and facilities
- F2.3 Facilities in Class 3 to 9 buildings
- F2.4 Accessible sanitary facilities
- F2.5 Construction of sanitary compartments
- F2.6 Interpretation: Urinals and washbasins
- F2.7 Microbial (legionella) control
- F2.8 Waste management

Part F3 Room Heights

- Objective FO3
- Functional Statement FF3.1
- Performance Requirement FP3.1
- F3.0 Deemed-to-Satisfy Provisions
- F3.1 Height of rooms and other spaces

Part F4 Light and Ventilation

Objective FO4

Functional Statements FF4.1 - FF4.3

Performance Requirements FP4.1 - FP4.5

F4.0 Deemed-to-Satisfy Provisions

F4.1 Provision of natural light

F4.2 Methods and extent of natural lighting

F4.3 Natural light borrowed from adjoining room

F4.4 Artificial lighting

F4.5 Ventilation of rooms

F4.6 Natural ventilation

F4.7 Ventilation borrowed from adjoining room

F4.8 Restriction on position of water closets and urinals

F4.9 Airlocks

F4.10 * * * * *

F4.11 Carparks

F4.12 Kitchen local exhaust ventilation

Part F5 Sound Transmission and Insulation

Objective FO5

Functional Statement FF5.1

Performance Requirements FP5.1 - FP5.6

Verification Methods FV5.1 and FV5.2

F5.0 Deemed-to-Satisfy Provisions

F5.1 Application of Part

F5.2 Determination of airborne sound insulating ratings

F5.3 Determination of impact sound insulation ratings

F5.4 Sound insulation rating of floors

F5.5 Sound insulation rating of walls

F5.6 Services

F5.7 Isolation of pumps

Specification F5.2 Sound Insulation for Building Elements

Specification F5.5 Impact Sound—Test of Equivalence

PART F1 DAMP AND WEATHERPROOFING

Objective

FO1

Safeguard occupants and protect the building—FO1(a)

FO1(a) aims to minimise the risk of water leaking into or accumulating within a building and causing musty, damp and unhealthy conditions or damaging building elements by corrosion.

Examples

- Damp conditions in houses can cause serious diseases. What appear to be less serious illnesses, such as colds, can have serious consequences, particularly for children and the elderly.
- Rotten floorboards can collapse, causing injury.
- Electrical connections can corrode, causing failure of safety devices, or increasing the risk of electrocution.
- Penetration of moisture into building elements can cause degradation to a building long before the damage is detected.

Protect other property from damage—FO1(b)

FO1(b) aims to minimise the risk of other property being damaged by surface water redirected from a building or any associated sitework.

Example

Construction on an allotment must not cause re-directed water damage to “other property”, including:

- any building on the same allotment;
- any building on an adjoining allotment;
- any adjoining allotment (whether there is a building on it or not); and
- any road.

Functional Statements

FF1.1

Protection from re-directed surface water

People and other property are to be protected from any problems caused by surface water re-directed by a building and any sitework involved in its construction. Remedial works must be

undertaken to dispose of any surface water which, because of any variation or addition to its flow caused by any building or sitework, causes harm to people or other property.

FF1.2

Resistance to rain, surface water and ground water

A building must resist:

- rain water, coming through the roof or walls, due to poor waterproofing or flashing;
- surface water, coming through openings which are too low; and
- ground water, which could rise up through porous floors or walls.

Ground water could enter a building if there are inadequate damp-proof courses or vapour barriers installed, or if other ways of resisting the rising damp have not been provided.

FF1.3

Overflow from bathrooms and laundries

The development of unhealthy conditions or damage caused by dampness or overflow from bathrooms, laundries and the like, must be prevented. Such problems may arise from showers and bathrooms being incorrectly sealed, allowing water to leak into other parts of the building.

Performance Requirements

FP1.1

Surface water from a 1 in 20 year storm

Surface water from a 1 in 20 year storm collected or concentrated by a building or sitework must be disposed of without damage to other property.

Construction should not cause stormwater problems on other properties, worse than those which existed previously.

Example

As a general rule, undeveloped land tends to absorb rainwater, usually resulting in comparatively slow run-off.

However, a building's hard surfaces, such as roofs and pavements, cause comparatively quick run-off. Consequently, the design of the surface-water disposal system must make provision for run-off stormwater from hard surfaces collected or concentrated by a building or sitework.

Why 1 in 20 year storms?

The storm intensity has been limited to a 1 in 20 year storm. This is considered an appropriate limit, fair on the person responsible for the building and siteworks and the person responsible for properties affected by re-directed surface water.

FP1.2

Surface water from a 1 in 100 year storm

Building and siteworks must be arranged so that surface water from a 1 in 100 year storm does not enter a building.

Why 1 in 100 year storms?

A 1 in 20 year storm has a less intense flow of water than a 1 in 100 year storm, which is what the subject building must be protected from.

It is considered more important to prevent water entering a building than it is to prevent water entering a neighbouring allotment or property.

Limitations

The limitations contain several exemptions to **FP1.2**. These are based on the belief that the use and safety levels of the exempted buildings will not be significantly diminished by surface water entering them.

Limitation (a) regarding Class 7 and Class 8 buildings refers only to such buildings which, in a particular case, do not exhibit any need for compliance with **FP1.2**. Such buildings must be considered on a case-by-case basis. However, it is the responsibility of a building proponent to satisfy the appropriate authority that the exemption should apply.

FP1.3

Outfall, water entrance and water damage

Under **FP1.3(a)**:

- a drainage system for surface-water disposal must have an appropriate outfall and avoid damage to the building;
- outfall includes a kerb and channel, a soakage system, and a natural watercourse; and
- the decision as to what is acceptable is made by the appropriate authority.

Under **FP1.3(b)**, a drainage system for the disposal of surface water must avoid water entering a building. This provision is intended to prevent water causing internal damage to a building, or causing injury or illness to occupants.

The **FP1.3(b)** prohibition on water entering the building:

- does not prohibit a drainage system that passes drainage water through a building (probably by way of pipes) without causing damage; and
- clearly does not prohibit water entering a building when it is required for various purposes.

Under **FP1.3(c)**, a drainage system for the disposal of surface water must avoid water damaging a building. Such damage could be caused by a building's subsidence.

FP1.4

Roofs and walls to prevent water penetration

Roofs and walls (including windows, doors and other openings in the walls) must prevent water penetration which could cause dangerous conditions, loss of amenity or dampness and deterioration of building elements.

Limitations

The limitations contain several exemptions to **FP1.4**. These are based on the belief that the use and safety levels of the exempted buildings will not be significantly diminished by water entering them.

Limitation (a), regarding Class 7 and Class 8 buildings, refers only to such buildings which, in a particular case, do not exhibit any need for compliance with **FP1.4**. Such buildings must be considered on a case-by-case basis. However, it is the responsibility of a building proponent to satisfy the appropriate authority that the exemption should apply.

FP1.5

Moisture from the ground

Building elements must be protected from deterioration and occupants must be protected from unhealthy or dangerous conditions or a loss of amenity caused by moisture from the ground (causing such problems as rot, rising damp, rust, and so on). In essence, this requires that the materials and components which make up building elements must either be fit for this purpose or made fit by protection.

Examples

The following may be acceptable to achieve compliance with **FP1.5**. They should not be regarded as absolute.

- damp-proof course in masonry walls above finished ground level;
- vapour barrier under a concrete slab;
- adequate sub-floor ventilation;
- painted or other similar protective coatings on steel and timber on or near ground level;
- appropriate concrete cover on steel reinforcing;
- galvanised coatings on steel; and
- specific concrete mixes to achieve required protection levels.

FP1.6

Water overflows from bathrooms and laundries

Water overflows from bathrooms, laundries and the like must be prevented from penetrating downwards—ie to a storey below—to either another sole-occupancy unit used for sleeping accommodation or a public space. Such overflows are potentially unhealthy and structurally damaging, and can be disruptive for neighbours.

FP1.7

Water — fittings, linings and concealed spaces

The structure of a building and the amenity of its occupants must be protected by preventing water from penetrating behind fittings and linings and into concealed spaces of toilets, bathrooms, laundries and the like.

PART F1 DAMP AND WEATHERPROOFING

Deemed-to-Satisfy Provisions

F1.0 Deemed-to-Satisfy Provisions

Intent

To clarify that the requirements of **FP1.1** to **FP1.7** will be satisfied if compliance is achieved with **F1.1** to **F1.13**.

The BCA does not contain any Deemed-to-Satisfy Provisions which can be followed as a means of complying with **FP1.4** for water penetration through external walls. However, it is still compulsory to comply with this Performance Requirement.

This approach has not changed from the previous edition of the BCA.

F1.1 Stormwater Drainage

Requires compliance with AS/NZS 3500.3.2 to achieve compliance with the Performance Requirements.

F1.2 * * * * *

In BCA 90, this provision was performance based. In subsequent editions of the BCA, the provision is covered by the Performance Requirements. **F1.2** has been left blank rather than renumber subsequent clauses.

F1.3 * * * * *

In BCA 90, this provision was performance based. In subsequent editions of the BCA, the provision is covered by the Performance Requirements. **F1.3** has been left blank rather than renumber subsequent clauses.

F1.4 * * * * *

In BCA 90, this provision was performance based. In subsequent editions of the BCA, the provision is covered by the Performance Requirements. **F1.4** has been left blank rather than renumber subsequent clauses.

F1.5 Roof coverings

Intent

To prevent water penetration of roofs which could cause:

- (1) unhealthy and dangerous conditions or loss of amenity for occupants; or
- (2) dampness and deterioration of building elements.

Roofing materials and fixing methods

F1.5 contains reference to Australian Standards and other reference documents for a range of roofing materials and fixing methods suitable for the prevention of water penetration.

Concrete and terracotta tiles — cyclonic areas

F1.5(a) and **(b)**, with regard to the use of concrete and terracotta roofing tiles, are not applicable to cyclonic areas, because the AS 2050 fixing details are inadequate for use in such areas. Accordingly, fixing in cyclonic areas must be approved by the appropriate authority.

F1.6 Sarking

Intent

To prevent water penetration of roofs and walls which could cause:

- (1) unhealthy and dangerous conditions or loss of amenity for occupants; or
- (2) dampness and deterioration of building elements.

Sarking to comply with AS/NZS 4200 Parts 1 and 2

F1.6 references the Standard for sarking materials where sarking is required for weatherproofing roofs and walls (eg under roof tiles or on walls before weatherboards are fixed).

F1.7 Waterproofing of wet areas in buildings

Intent

To prevent water penetration from wet areas in buildings which could cause:

- (1) unhealthy and dangerous conditions or loss of amenity for occupants; or
- (2) dampness and deterioration of building elements.

Wet areas to be impervious to water

F1.7 requires that certain areas designated as “wet areas” be made impervious to water. This applies to showers, floors and walls adjacent to baths, tubs or laundry troughs, basins, sinks and urinals. The aim is to protect adjacent areas from damage by water splashed from these fixtures.

Adoption of AS 3740 — F1.7(a)

F1.7(a) requires Class 2 and 3 buildings and Class 4 parts to be impervious to water in accordance with AS 3740.

F1.8 * * * * *

In BCA 90, this provision was performance based. In subsequent editions of the BCA, the provision is covered by the Performance Requirements **F1.8** has been left blank rather than renumber subsequent clauses.

F1.9 Damp-proofing

Intent

To prevent moisture from the ground penetrating a building where it could cause:

- (1) unhealthy and dangerous conditions or loss of amenity for occupants; or
- (2) dampness and deterioration of building elements.

Damp must not rise from the ground — F1.9(a)

Damp must be prevented from reaching:

- a building's lowest floor timbers;
- suspended concrete floors or other suspended floors;
- supporting beams or girders; and
- walls above damp-proof courses.

Damp-proof course — AS/NZS 2904 or AS 3660.1 — F1.9(b)

AS/NZS 2904 and AS 3660.1 are referenced as alternative options for damp-proof course materials and installation details.

Exemptions — F1.9(c)

F1.9(c) contains exemptions to **F1.9(a)** because the safety level of buildings will not be significantly diminished by moisture from the ground.

F1.9(c)(i) regarding Class 7 and Class 8 buildings refers only to such buildings which, in a particular case, do not exhibit any need for compliance with **F1.9**. Such buildings must be considered on a case-by-case basis. However, it is the responsibility of a builder to satisfy the appropriate authority that the exemption should apply.

F1.10 Damp-proofing of floors on the ground

Intent

To prevent moisture from the ground penetrating a building where it could cause:

- (1) unhealthy and dangerous conditions or loss of amenity for occupants; or
- (2) dampness and deterioration of building elements.

Damp must not rise from the ground

F1.10 covers floors resting on the ground. The aim is to prevent ground dampness causing:

- unhealthy and dangerous conditions or loss of amenity for occupants; or
- dampness and deterioration of building elements (which, in this case, includes surfaces and linings inside the building, such as floor tiles, wall paint and the like).

Vapour barriers — AS 2870

AS 2870 is referenced for acceptable materials and installation details for vapour barriers to stop ground moisture reaching the upper surface of floors and walls.

Exemptions — F1.10(a) and (b)

Exemptions apply to **F1.10** where:

- weatherproofing is not required for Class 7 or Class 8 buildings where there is no necessity for compliance, sheds forming part of a building used for other purposes, and so on (see the Limitations to **FP1.4** for a listing of exempted buildings); and
- the base of a stairway or lift or similar shaft is suitably drained.

Figure F1.10 illustrates a method of installing damp-proofing in sub-floor structures.

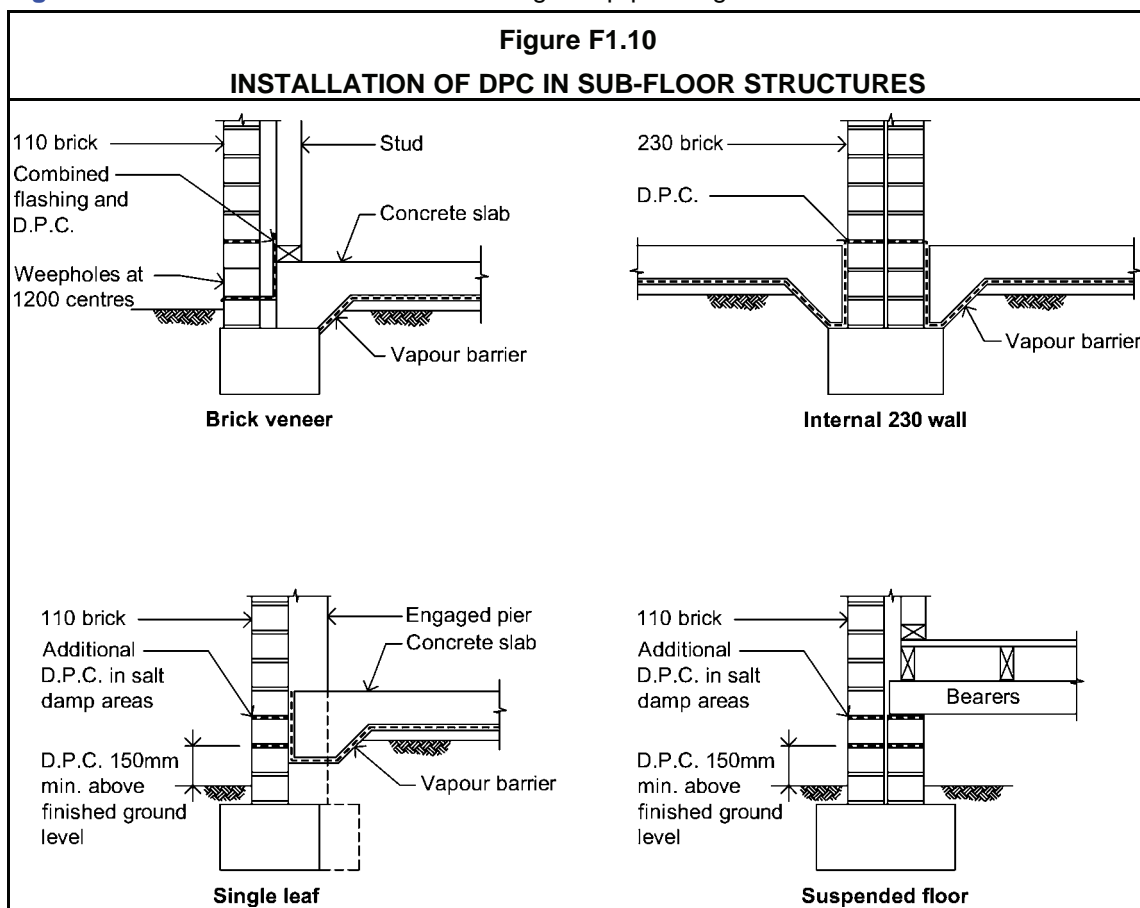

F1.11 Provision of floor wastes

Intent

To prevent water from any bathroom or laundry in Class 2 and Class 3 buildings or Class 4 parts from penetrating any sole-occupancy unit or public space, which is in a level below, which could cause:

- (1) unhealthy and dangerous conditions or loss of amenity for occupants; or
- (2) dampness and deterioration of building elements.

Floor wastes are to be installed in bathrooms and laundries in Class 2 and Class 3 buildings and Class 4 parts, where those bathrooms and laundries are above another sole-occupancy unit or public space.

The aims of this requirement are to minimise water overflows from fixtures in the specified rooms:

- causing costly and possibly dangerous water damage to other sole-occupancy units;
- creating unhealthy conditions in public spaces in buildings; and
- disrupting and intruding on neighbours in the unit below.

F1.12 Sub-floor ventilation

Intent

To prevent rising dampness which could cause:

- (1) unhealthy and dangerous conditions or loss of amenity for occupants; or
- (2) dampness and deterioration of building elements.

Sub-floor ventilation is cross ventilation of the sub-floor space between the underside of the floor and ground surface under the lowest suspended floor of a building.

Ground moisture rising into or entering the sub-floor space can create a damp environment which encourages timber rot and fungus growth. Sub-floor ventilation increases air flow, reducing any damaging water vapour in the sub-floor space.

Factors that can affect achieving satisfactory levels of sub-floor ventilation include height above ground, prevailing breezes (air transfer), differential temperature and humidity between the sub-floor and the external environment and good building practice.

The amount of sub-floor ventilation required for a building is related to the relative humidity likely to be encountered in that location. For the purposes of the Deemed-to-Satisfy Provisions, Australia has been divided into three broad climatic zones based on the prevailing relative humidity.

The climatic zones were determined by analysis of the average relative humidity at 9 am and 3 pm in January and July. The season with the highest relative humidity is used. Generally this is July for southern Australia and January for northern Australia. The climatic zone limits are described in [Figure F1.12](#).

Table F1.12 specifies the minimum amount of sub-floor ventilation openings and height of sub-floor framing members above ground level for the three climatic zones illustrated in [Figure F1.12](#). The table allows sub-floor ventilation rates to be halved if the ground within the sub-floor space is sealed by an impervious membrane because humidity levels in the space will not be affected by moisture from the soil.

F1.12(g) specifies additional requirements for preventing deterioration of sub-floor members where the ground or sub-floor space is excessively damp, as would occur in areas with high water tables, poor drainage or in areas frequently affected by flooding or water inundation.

F1.13 Glazed assemblies

Intent

To prevent water penetration of windows which could cause:

- (1) unhealthy and dangerous conditions or loss of amenity for occupants; or
- (2) dampness and deterioration of building elements.

F1.13 requires windows, etc to comply with the AS 2047 requirements for resistance to water penetration. The provision does not apply to:

- some Class 7 and 8 buildings;
- garages, tool sheds, sanitary compartments and the like forming part of a building used for other purposes; and
- open spectator stands and open-deck car parks.

The exemptions are consistent with limitations in **FP1.4** (see **FP1.4**).

PART F2 SANITARY AND OTHER FACILITIES

Objective

FO2

FO2 is based on the concept that occupants must be:

- protected from illness caused by infection and a lack of adequate personal-hygiene facilities;
- protected from loss of amenity due to a lack of adequate hygiene facilities;
- be provided with appropriate laundering and cooking facilities; and
- able to be removed from sanitary compartments in an emergency.

Examples

- The BCA requires sanitary facilities to be installed at a rate based on the number of people in a building. If insufficient, unacceptable queuing may result.
- Loss of amenity can occur if users are not provided with sufficient privacy.

Adequate laundry and cooking facilities should be available to health-care buildings and early-childhood centres, as well as residents of Class 2 buildings and Class 4 parts.

Functional Statements

FF2.1

To achieve **FO2**, a building must be provided with:

- sanitary and personal-hygiene facilities suitable to the building's functions; and
- adequate means for the prevention of contaminants to hot water, warm water and cooling water systems.

FF2.2

Health-care buildings, early-childhood centres, Class 2 buildings and 9c buildings and Class 4 parts must be provided with laundry facilities. Under the **FF2.2** Application provision, **FF2.2** does not apply to any other buildings.

Class 2 buildings and 9c buildings and Class 4 parts are required to have laundry facilities because occupation is generally of a permanent nature. Laundry facilities are not required in other buildings. For example, a hotel, motel or boarding school may have its own laundry facilities, or have an arrangement with a commercial laundry. Sole-occupancy units in Class 3 buildings are not occupied by the same people for extended periods of time, so they are not required to be provided with laundry facilities.

FF2.3

Health-care buildings, early-childhood centres, Class 2 buildings and 9c buildings and Class 4 parts must be provided with cooking facilities. Under the **FF2.3** Application provision, **FF2.3** does not apply to any other buildings.

As for laundry facilities, Class 2 buildings 9c buildings and Class 4 parts are required to have cooking facilities because their occupation is generally of a permanent nature. Cooking facilities are also required in health-care buildings and early-childhood centres because the occupants of these places may require specific types of food not easily available from outside (eg special dietary needs).

Cooking facilities are not required in other buildings. For example, a hotel, motel or boarding school may have its own cooking facilities, have an arrangement with a commercial caterer, or choose to have no cooking facilities at all. It is assumed that the same people do not occupy sole-occupancy units in Class 3 buildings for extended periods of time, so they are not required to be provided with cooking facilities.

FF2.4

Sanitary compartments are to be constructed so that unconscious occupants are able to be removed.

Performance Requirements

FP2.1

FP2.1 recognises that the number, type and location of sanitary facilities are dependent on:

- what the building is used for; and
- the number, gender and particular needs of the occupants.

FP2.2

Health-care buildings, early-childhood centres, Class 2 and 9c buildings and Class 4 parts must be provided with either:

- laundry facilities; or
- space for laundry facilities.

A building's function or use will determine the appropriate number and location of the laundry facilities or space.

FP2.3

Health-care buildings, early-childhood centres, Class 2 and 9c buildings and Class 4 parts must be provided with adequate cooking facilities. This means:

- washing facilities for both food and utensils used for the preparation and consumption of food, in conjunction with adequate waste-water disposal;
- a means of cooking food, which may be either fixed in place (such as a wall-mounted oven) or a removable appliance (such as a microwave unit); and

- space to allow food to be prepared.

FP2.4

Class 9a and 9c buildings with wards or bedrooms must have facilities for emptying bedpans and the like, such as a slop hopper.

FP2.5

Sanitary compartments are to be large enough or have another suitable means that enables the removal of an unconscious occupant.

FP2.6

Buildings must have hot water, warm water and cooling water installations that minimise the risk of major disease outbreak caused by the harmful levels of micro-organisms.

This Performance Requirement does not apply to a system serving only a single sole-occupancy unit in a Class 2 or 3 building or Class 4 part.

PART F2 SANITARY AND OTHER FACILITIES

Deemed-to-Satisfy Provisions

F2.0 Deemed-to-Satisfy Provisions

Intent

To clarify that complying with **Part F2** and, for public transport buildings, **Part H2** will satisfy the requirements of **FP2.1-FP2.6**.

F2.1 Facilities in residential buildings

Intent

To specify the minimum acceptable sanitary, bathing, laundry and cooking facilities required in Class 2 buildings, Class 3 buildings (for residents only), Class 9c buildings (for residents only) and Class 4 parts.

F2.1 and **Table F2.1** lists the type and number of facilities required in Class 2 buildings, Class 3 buildings (for residents only), Class 9c buildings (for residents only) and Class 4 parts. The reason that aged care buildings are included is that they are regarded as residential buildings because they are the residents' home. All the listed facilities are to be provided separately.

For laundry facilities—Class 2 buildings and Class 4 parts must be provided with a means to wash clothes. In Class 2 buildings, laundry facilities must be provided as follows:

- within each sole-occupancy unit:
 - at least one washtub; and
 - at least one space for a washing machine; or
- as a separate group for each four (or less) sole-occupancy units:
 - a washtub; and
 - at least one washing machine.

Example

In a Class 2 or Class 3 building or Class 4 part, a washbasin and a washtub are required. Although the placing of laundry facilities in a bathroom is permitted, a separate washbasin and washtub are still required.

Class 4 parts must be provided with at least one washtub and at least one space for a washing machine.

For drying clothes—Class 2 buildings and Class 4 parts must be provided with some means to dry clothes. In Class 2 buildings, clothes-drying facilities must be provided as follows:

- within each sole-occupancy unit:

- at least 7.5 metres of drying line; or
- at least one space for a drying cabinet or appliance; or
- as a separate group for each four (or less) sole-occupancy units:
 - at least 7.5 metres of drying line; or
 - at least one drying cabinet or appliance.

Class 4 parts must be provided with at least one clothesline or hoist; or at least one space for a drying cabinet or appliance.

For food—in Class 2 buildings (in each sole-occupancy unit) and Class 4 parts, the following must be provided:

- at least one kitchen sink; and
- facilities for the preparation and cooking of food (see [FP2.3](#)).

For bathing and toiletry in residences—at least either one bath or shower, and at least one closet pan and one washbasin must be provided:

- in each sole-occupancy unit in Class 2 buildings;
- for each 10 residents (or less) in a Class 3 building or group of buildings for whom private facilities are not provided (note the concession where urinal facilities are provided); and
- in each Class 4 part.

For staff toilets—eleven or more Class 2 sole-occupancy units in either one building, or several buildings, on an allotment must have a toilet and handbasin for use by maintenance or ground staff who, when working on the allotment, may not have access to a toilet within a specific unit.

The limit of 11 or more units recognises that, in smaller complexes, the size of any common area is also likely to be small and if someone is employed to tend such an area they will only be on-site for a limited time.

For Class 3 building facilities—the patrons' facilities may be grouped together and do not need to be in the building where sleeping accommodation is provided.

Example

An example of grouped facilities could be sanitary facilities located in a freestanding ablution block that services several accommodation units.

The facilities for a Class 3 building contained in [Table F2.1](#) are those for the residential portion of the building only. Facilities for employees in Class 3 buildings are contained in [Table F2.3](#).

For aged care buildings—the facilities listed in items (a) to (c) of [Table F2.1](#) apply to the residential portion of Class 9c aged care buildings only. The kitchen and laundry facilities listed in items (d) and (e) of [Table F2.1](#) need not be located in the resident use area. The clinical hand washing basin listed in item (f) of [Table F2.1](#) is intended for use by staff, etc. and therefore would be best placed in the resident use area. Sanitary facilities for employees in aged care buildings are contained in the general part of [Table F2.3](#). They can be utilised by the occupants when required.

F2.2 Calculation of number of occupants and facilities

Intent

To provide a method for calculating the number of occupants and facilities for the purposes of [Part F2](#).

If the number of people who will occupy a building is known, it should be used. However, in the absence of more accurate information, **D1.13** must be used. **D1.13** is used in several Parts of the BCA, such as in calculating minimum exit widths, as well as the number of sanitary and other facilities. **D1.13** does not restrict the number of occupants using a building, or enforce any building use or licensing requirements. Refer also to comments on **D1.13**.

As specified in **D1.13(b)**, if the building is an assembly building or room, its fixed seating provisions give an indication of capacity.

Any other suitable means, as specified in **D1.13(c)**, may include a statement from the building owner as to the number of occupants where there is limited public access.

Example

An alternative means of assessing the number of occupants may be appropriate in the following case.

A specific restaurant may have fixed tables, booths, dining alcoves and architectural features which occupy a significant proportion of the floor space, so the actual number of patrons able to be accommodated may be much less than the number calculated using the one person for every square metre of floor area in **D1.13**.

In such a case, it may be appropriate to count the number of seats available for use by patrons or some other method. However, due allowance would need to be made for the employees, as well as the potential for alternative seating layouts which could then increase the number of people in the restaurant.

For consideration of gender—the number of sanitary facilities should be calculated on the basis that the population of males and females in a building will usually be about equal. Where a building will be occupied predominantly by one sex, the proportion of toilets can be adjusted accordingly.

Examples

It may be appropriate to vary the proportion of female and male toilets in:

- a gymnasium which has appropriate permission to cater for a single sex;
- a single-sex sports facility, such as either an all-male football club or an all-female netball club;
- all-male or all-female prisons; and
- medical or hospital facilities that cater for a specific sex, such as prostate-cancer specialists, gynaecological clinics and maternity hospitals.

For unisex facilities—under **F2.2(c)**, a unisex facility for people with disabilities can be counted as a facility for both a male and a female. **F2.2(d)** defines the meaning of ‘unisex facility’ for the purposes of Part **F2**. These provisions aim to encourage the installation of toilets for people with a disability.

Examples

If there is a requirement for a toilet block to contain 10 toilets for males and 10 toilets for females (a total of 20 toilets), they may be provided as a total of 19 toilets, ie:

- 9 male;
- 9 female; and
- 1 unisex toilet for people with a disability.

In another case where there is a requirement for 1 toilet for males and 1 toilet for females, providing a single unisex facility may satisfy this requirement. However, if a urinal is also required it cannot be in the unisex facility.

F2.3 Facilities in Class 3 to 9 buildings

Intent

To specify the minimum acceptable sanitary, bathing, laundry and cooking facilities required in Class 3 buildings (for employees only) and in Class 5-9 buildings.

F2.3 and **Table F2.3** contain the requirements for the type and number of facilities required. They are based on the preface that a higher ratio of sanitary facilities is required in buildings where occupants spend a long time.

Example

A higher ratio of toilets is required in a Class 7 or Class 8 workplace (where employees could spend all day) than in a Class 6 department store (where customers could be expected to spend less time).

The BCA currently covers the separation of male and female toilets by way of **F2.3(b)** and **(c)**, which provide for specific exemptions permitting unisex and combined facilities. These provisions underline the intention that the BCA requires separate facilities under all other circumstances in the buildings covered by **Table F2.3**.

Except in schools and early-childhood centres, separation of facilities for employees and the public is not required (see **F2.3(d)**). Separation is required in schools to maintain the teacher/student relationship, while in early-childhood centres it is required because of the:

- provision of junior toilets;
- use of the toilets as training facilities; and
- need to keep the children under observation.

Toilet facilities for females must be provided with a means of disposal of sanitary napkins etc (see **F2.3(e)**). This might include an incinerator, or a bin and disposal service. This provision also applies to unisex or male/female shared toilets.

For health-care buildings—in addition to **Table F2.3**, **F2.3(f)** requires facilities for meals and laundering because the patients live in the building.

F2.3(f)(i) therefore requires:

- a kitchen or other facilities for the preparation and cooking or reheating of food;
- a kitchen sink for the washing of plates, cutlery, cooking utensils, and the like; and
- a washbasin for kitchen staff to wash their hands.

Because of the amount of linen and clothes requiring laundering in these buildings, **F2.3(f)(ii)** requires laundry facilities; or places for the holding and dispatching soiled linen, clothing, and the like; and the receipt and storage of clean linen.

For early childhood centres—**F2.3(g)(i)** requires a kitchen because young children may require food, possibly in the form of special diets. The kitchen must comprise:

- facilities for the preparation and cooking of food for infants;
- a kitchen sink; and

- space for a refrigerator.

If the building accommodates children younger than three-years old, there may also be a need to carry out washing of nappies and other clothing. **F2.3(g)(iii)(A)** therefore requires the installation of laundry facilities (but not drying facilities) in these buildings comprising:

- a washtub; and
- space in the same room for a washing machine.

For a department store, the number of facilities for employees is calculated at a different rate to that for customers. For employees it is consistent with other buildings containing employees, while for customers it is considerably less. Therefore, when calculating the number of toilets in a department store, the number required for staff must be added to the number required for customers. The BCA does not require facilities for staff to be in an area separate from customers (except as required by **F2.3(d)**), but a separation may be needed under some other regulations, such as workplace or health regulations, so should be checked.

Experience has shown that there can be excessive delays and queueing at female toilets at certain theatres or cinemas. **Table F2.3** therefore requires additional facilities for females in single auditorium theatres and cinemas. For the purposes of **Table F2.3**, a single auditorium theatre or cinema is considered to be one that contains only one auditorium and the performance results in peak use of toilets before a performance and at intermission. When a theatre or cinema contains two or more auditoriums and the start and intermissions are at different times, less delays and queueing occur.

A concession is provided to permit the provision of fewer facilities for the public where the people accommodated are under certain numbers. Facilities must still be provided for employees, and, if necessary, members of the public can share these facilities (see **Table F2.3**).

Notes to **Table F2.3** are provided and the Table should be read in conjunction with the notes.

Note 3—Any reference to employees in **Table F2.3** should be read in the wider context of all who work in the building. This includes those who may not technically be employed, such as owners and, if there is any doubt regarding their status, managers.

In addition to **F2.3**, Occupational Health and Safety legislation may require supplementary facilities. This can include showers and change rooms in some work places, depending on the nature of the work and working conditions of the employees.

F2.4 Accessible sanitary facilities

Intent

To specify the minimum acceptable sanitary and bathing facilities required for people with a disability in Class 1b, Class 2, Class 3, Class 5-9 and Class 10a buildings.

Section D requires equitable and dignified access to buildings and the services they provide. **Section D** and **Part F2** are also intended to apply inclusively to people with a disability (see **FP2.1**). Not only must people with a disability be able to access a building's toilet and bathing facilities, those facilities must be usable by them.

F2.4 refers to **Table F2.4(a)** and **Table F2.4(b)** to determine the numbers of accessible sanitary facilities, and AS 1428.1 for details of the construction of accessible facilities. Facilities such as washbasins, a shelf or bench top and adequate means of disposing of sanitary towels must be inside the unisex toilet compartment and not outside in a public area. **F2.4** also requires sanitary compartments suitable for use by a person with an ambulant disability to be provided in certain

circumstances, in addition to compartments for use by a person using a wheelchair. Where two or more of each type of unisex accessible sanitary facilities are provided in a building, the number of left and right handed mirror image facilities must be provided as evenly as possible. This is required because some people transfer from their wheelchairs from the right hand side and some from the left.

Table F2.4(a) provides minimum requirements for the provision of accessible unisex sanitary compartments, commonly referred to as unisex accessible toilets. Unisex accessible sanitary compartments are required on each storey where sanitary compartments are provided. If the male or female toilets are located separately and not in a single bank then the unisex accessible toilet is only required at one of those banks. However, clear directional information about the location of the closest unisex accessible toilet must be provided. If there are multiple banks containing male and female sanitary compartments on a storey, there must be a unisex accessible sanitary compartment at not less than 50% of those banks.

Table F2.4(b) provides minimum requirements for the provision of accessible unisex shower facilities in buildings where showers are required (by the BCA) to be provided.

F2.4(e) requires that facilities be constructed in accordance with AS 1428.1. It is important to note that AS 1428.1 contains provisions for both wheelchair accessible facilities and those for people with an ambulant disability. These provisions include:

- grabrails;
- circulation space;
- access door width and swing;
- height of fixtures;
- lever handles for taps; and
- space under the front of basins.

A toilet that is suitable for a person with an ambulant disability is not intended for use by a person using a wheelchair. An accessible path of travel need not be provided to such a toilet.

F2.5 Construction of sanitary compartments

Intent

To specify the construction expected to provide an acceptable level of privacy in toilets while facilitating assistance in an emergency.

Privacy in toilets is considered to be an amenity issue. There is a high level of privacy expected in unisex toilets while there are lower levels expected in early-childhood centres and facilities used by primary school children. There is also an intermediate level expected between compartments in single-sex toilets.

F2.5 permits early-childhood centres to be constructed without doors and partitions between toilets because it is necessary for staff to keep the children under regular observation. Under **F2.5(a)(ii)**, a concession is also provided on the height of partitions for facilities used by primary school children. These concessions in **F2.5** should not be applied to staff facilities.

F2.5(b) requires means of removing an unconscious occupant from a fully enclosed sanitary compartment. If the enclosure has gaps that are large enough to allow access for a person into the sanitary compartment, the compartment is not intended to be considered enclosed for the purposes of this clause.

The exception to **F2.5(b)** is where there is a clear space of at least 1.2 m between the closet pan and the doorway, as measured in accordance with **Figure F2.5** in the BCA.

F2.6 Interpretation: Urinals and washbasins

Intent

To clarify what is meant by the expressions 'urinal' and 'washbasin'.

Urinals and hand-washing facilities are often not constructed as single units, but as a length of trough. **F2.6(a)** and **(b)** clarify that the words 'urinal' and 'washbasin' apply to individual facilities, or to a length of trough, in the case of a urinal; and a specific part of a hand-washing trough.

F2.6(a)(iii) allows a closet pan (also called a 'toilet pan' or 'closet fixture') to be used in place of a urinal. Such a closet pan must be additional to the required number of closet pans, and so must not be counted once as a urinal and once as a pan when calculating the total number of facilities.

F2.7 Microbial (legionella) control

Intent

To make sure that hot water, warm water and cooling water systems in certain facilities minimises the risk of a major disease outbreak.

Legionella and other dangerous bacteria may multiply in hot water, warm water and cooling water systems to numbers that can cause serious outbreaks. AS/NZS 3666.1, referenced by **F2.7**, contains measures for designing, installing and commissioning hot water, warm water and cooling water systems, aimed at minimising the risk of a major disease outbreak.

Legionella and other dangerous bacteria may multiply in hot water, warm water and cooling water systems to numbers that can cause serious outbreaks.

This provision applies to all buildings except systems that only serve a single sole-occupancy unit in Class 2 or 3 building or Class 4 part. This limitation is consistent with the intent of AS/NZS 3666.1 and the limitation of **FP2.6**.

F2.8 Waste management

Intent

To require adequate devices in Class 9a and 9c buildings containing ward areas or bedrooms for the emptying of containers of sewage and dirty water.

Class 9a buildings, such as hospitals and nursing homes, are likely to be occupied by people who can only carry out their toilet and bathing functions in commode chairs or into containers. To minimise disease, **F2.8(a)** require slop-hoppers. These are special fixtures with a grate, flushing apparatus and tap which are used for emptying bedpans and the like.

Aged care buildings are likely to be occupied by people with similar difficulties to those occupying Class 9a buildings. To minimise disease, **F2.8(b)** requires the installation of slop-hoppers and appliances for either disinfecting pans or an adequate means for disposal of receptacles in Class 9c aged care buildings. If one device can undertake all tasks required by **F2.8(b)**, then it may be utilised.

PART **F3** ROOM HEIGHTS

Objective

FO3

Basis of Objective

FO3 is based on the belief that people should not be subject to risk of injury or loss of amenity caused by the inadequate height of a room or space.

Risk of injury

The height of certain rooms and spaces must be controlled to prevent injury to occupants.

Loss of amenity

The height of certain rooms and spaces must be controlled to prevent a loss of amenity to occupants.

Functional Statement

FF3.1

Height suitable for use of a room or space

Buildings must provide a height suitable for the intended use of rooms and spaces. 'Intended use' recognises that the height required in rooms and spaces is directly related to the room's function.

Performance Requirement

FP3.1

Sufficient height

FP3.1 adds the term 'sufficient' when describing the required level of performance. The required height must be considered in light of intended function.

The Deemed-to-Satisfy Provisions specify different heights for different room or building types.

Measurement of height

To achieve the requisite level of performance, it is necessary, when measuring the height of a ceiling, to make the measurement:

- from the floor to the underside of the ceiling lining; or
- if there is no ceiling lining, to the underside of the floor or roof above.

Exposed beams are permitted to encroach below the minimum ceiling height, but care should be taken to make sure that adequate height is still available.

In the case of stairs and ramps, the measurement is taken vertically from the nosing line of the stairway treads or the floor surface of the ramp, landing or the like, with no overhead projection encroachments permitted.

PART F3 ROOM HEIGHTS

Deemed-to-Satisfy Provisions

F3.0 Deemed-to-Satisfy Provisions

Intent

To clarify that **FP3.1** will be achieved by compliance with **F3.1**.

F3.1 Height of rooms and other spaces

Intent

To establish a range of reasonable ceiling heights suitable for particular rooms and spaces.

2.4 metres

Generally, the minimum ceiling height has been set at 2.4 metres:

- **F3.1(a)(iii)** deals with habitable rooms (apart from kitchens) in Class 2 and Class 3 buildings and Class 4 parts;
- **F3.1(b)(i)** apart from some specified exceptions, in Class 5-8 buildings;
- **F3.1(c)(i)** and **(iii)** deals with Class 9a patient-care areas, treatment rooms, clinics, waiting rooms, passageways and corridors;
- **F3.1(d)(i)** is for school classrooms and smaller assembly buildings;
- **F3.1(e)(ii)** and **(iii)** deal with corridors, etc and habitable rooms (apart from kitchens) in Class 9c aged care buildings; and
- **F3.1(f)(ii)** deals with commercial kitchens.

2.1 metres

A reduced height of 2.1 metres is permitted in areas unlikely to be occupied for long periods, where the reduction from 2.4 metres will not adversely affect occupant safety, health or amenity. Such areas include:

- kitchens or laundries or the like in Class 2 and Class 3 buildings and Class 4 parts;
- corridors and passageways or the like in Class 2 and Class 3 buildings and Class 4 parts;
- corridors and passageways or the like in Class 5-8 buildings; and
- various bathing facilities, small storage areas, airlocks, garages, carparking facilities, tearooms and the like, which are located in any building.

2.0 metres

A reduced height of 2 metres is permitted above stairways and ramps as these areas are used for transient purposes and therefore a reduction from the required height in corridors and rooms (2.1 and 2.4 metres generally) will not adversely affect occupant safety, health or amenity.

Ceiling heights above 2.4 metres

Some specific use areas require a ceiling height greater than 2.4 metres in recognition of the activities or equipment likely to be used in those areas, such as:

- operating theatres or delivery rooms which require a ceiling height of three metres to accommodate special lighting fixtures, air monitoring equipment, and medical apparatus; and
- larger assembly buildings, including corridors where the corridor serves a building or part of a building that accommodates more than 100 persons.

PART F4 LIGHT AND VENTILATION

Objective

FO4

FO4(a) aims to minimise the risk of injury, illness or loss of amenity to occupants from shortages of natural or artificial light.

FO4(b) aims to minimise the same as above, from a shortage of fresh air.

Functional Statements

FF4.1

FF4.1 requires that a building space must have openings providing enough natural light for a room to fulfil its purpose.

FF4.2

FF4.2 requires that a building space used by occupants must have artificial light, which will, when there is insufficient natural light, provide enough light to allow safe movement in the room.

FF4.3

FF4.3 requires that a building space used by occupants must have ventilation that provides adequate air, so the room can fulfil its purpose. "Adequate air" includes both quantity and quality.

The building and its location may impose constraints on the quality of the ventilation air.

Example

A building's location may impose constraints on the quality of the ventilation air such as when the building is in a central business district. Here, even locating intakes at the highest point on the building could still draw in significant quantities of vehicle exhaust fumes. The air may not be totally "fresh". Nonetheless, efforts must be made to make sure the air is of adequate quality.

Ventilation standards are influenced by many factors, including:

- the number of people being provided with air;
- activities in the building which might lead to a build-up of toxic gases;
- climatic conditions; and
- the distribution of ventilation openings.

Some of the primary problems, which a ventilation system must attempt to overcome, include:

- excessive heat;
- excessive humidity; and
- offensive odours.

Performance Requirements

FP4.1

FP4.1 includes the concept of even distribution, and relates required lighting levels to the function of the building.

The level of natural light must be appropriate to the function of each part of the building (this differs from the **FP4.2** requirement for artificial light).

FP4.2

FP4.2 relates required lighting levels to the use of each part of the building. Unlike **FP4.1** with regard to natural light, **FP4.2** does not include the concept of even distribution.

The level of artificial light must be appropriate to the use of the building to enable safe movement by occupants (this differs from the **FP4.1** requirement for natural light).

FP4.3

FP4.3 requires a building's ventilation system to include for the supply of outdoor air.

FP4.4

Where a mechanical air-handling system is installed, **FP4.4** requires it to achieve control with regard to the following:

- smells considered objectionable (including food, cooking and toilet odours); and
- the accumulation of germs, harmful microbes, other disease-causing agents, and poisons.

FP4.5

FP4.5 requires that any contaminated air be disposed of so that it does not cause any nuisance or hazard to:

- occupants (of either the subject building, or any other building);
- people on neighbouring allotments; or
- people on a road.

PART **F4** LIGHT AND VENTILATION

Deemed-to-Satisfy Provisions

F4.0 Deemed-to-Satisfy Provisions

Intent

To clarify that **Part F4** will satisfy the requirements of **FP4.1 - FP4.5**.

Where a Building Solution is proposed to comply with the Deemed-to-Satisfy Provisions, **F4.0** clarifies that compliance with **F4.1–F4.12** will achieve compliance with **FP4.1–FP4.5**.

Where a Building Solution is proposed as an Alternative Solution to the Deemed-to-Satisfy Provisions, the relevant Performance Requirements must be determined in accordance with **A0.10**. (See comment on **A0.10**).

F4.1 Provision of natural light

Intent

To specify the rooms in Classes of buildings where natural light is required.

See **FF4.1** and **FP4.1** for information on the reasons for the BCA natural light provisions.

The provision of natural light is substantially a health and amenity issue. It is considered of particular importance in all “living” and “sleeping” areas in residential buildings occupied by people for an extended period of time. The BCA consistently assumes that this is the case with Class 2 buildings and Class 4 parts, but not with Class 3 buildings.

Occupants of Class 3 and Class 9a buildings do not reside in the same building for an extended period of time. **F4.1** extends this assumption to the “living” areas (shared and unshared) of such buildings. For this reason, the BCA only requires the provision of natural light to sleeping areas in Class 3 and Class 9a buildings.

F4.1(b) assumes that in Class 3 buildings the occupants spend more time in their “sleeping” accommodation than they do in “living” areas. This is usually the case in Class 2 buildings and Class 4 parts.

F4.1(c), with regard to Class 9a and 9c buildings, takes account of the fact that occupants will generally be in their beds throughout the day and natural light will be important to them.

It is considered desirable that school and pre-school children are able to view the outside environment, and work or play using natural light. Accordingly, buildings such as kindergartens and schools must provide natural light to playrooms and classrooms.

F4.2 Methods and extent of natural lighting

Intent

To specify the requirements for the size and location of windows, including roof lights to provide required natural lighting.

A window includes roof lights, glassed louvres and glazed doors (see definition in [A1.1](#)).

F4.2(a)(i) sets out the requirement for natural light provided by windows other than roof lights. **F4.2(a)(ii)** sets out the requirement for natural light provided by roof lights. To achieve the requirements for natural light when both windows and roof lights are provided, a proportional combination of **F4.2(a)(i)** and **(ii)** can be used through **F4.2(a)(iii)**. This is explained in the following example.

Example

Method for determining proportional combination of windows and roof lights.

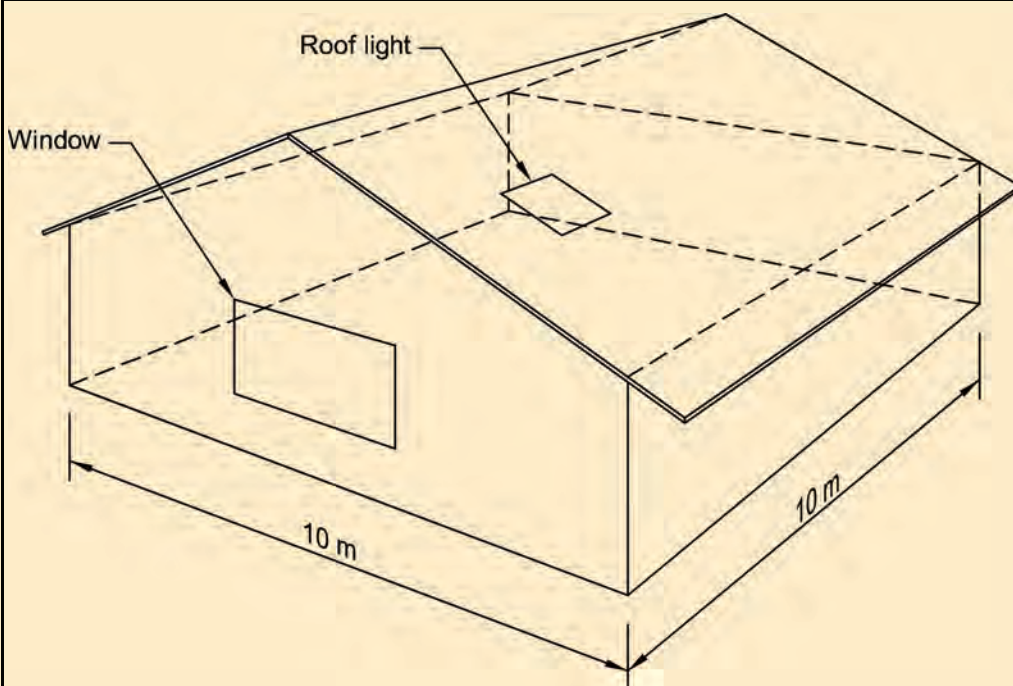

Description of above diagram

Area of the room which requires natural light is 100 m².

No natural light borrowed from adjoining rooms.

General requirements

Required windows to provide natural light must have a light transmitting area of at least 10% of the floor area.

$$10\% \text{ of } 100 \text{ m}^2 = 10 \text{ m}^2$$

Or, roof lights to provide natural light must have a light transmitting area of at least 3% of the floor area.

$$3\% \text{ of } 100 \text{ m}^2 = 3 \text{ m}^2$$

Calculations

Formula — for the area of windows required to compensate for roof light short fall

Area of room covered by the roof light = (Area of roof light) / 0.03

Required window area = [(Floor area) – (Area covered by the roof light)] / 10

Area of windows required to compensate for roof light short fall

If the roof light = 1 m²

Area of room covered by the roof light = (1 m² / 0.03)

$$= 33.33 \text{ m}^2$$

Required window area = (100 m² – 33.33 m²) / 10
= 6.67 m²

Formula — for the area of roof lights required to compensate for window short fall

Area of room covered by the window = (Area of window) / 0.1

Required roof light area = [(Floor area) – (Area covered by the window)] / 33.33

Area of roof lights required to compensate for window short fall

If the window = 5 m²

Area of room covered by the window = (5 m² / 0.1 m²)

$$= 50 \text{ m}^2$$

Required roof lights area = (100 m² – 50 m²) / 33.33
= 1.5 m²

Notes:

1. For the purpose of this table a window excludes a roof light.
2. The same proportional calculation principle applies if—
 - (a) two or more windows are used; or
 - (b) two or more roof lights are used.

All windows, both required and non-required, must comply with the various requirements of the BCA's fire-safety provisions, such as **C3.2** for openings in external walls, and **Clause 3.6 of Specification C1.1** for roof lights.

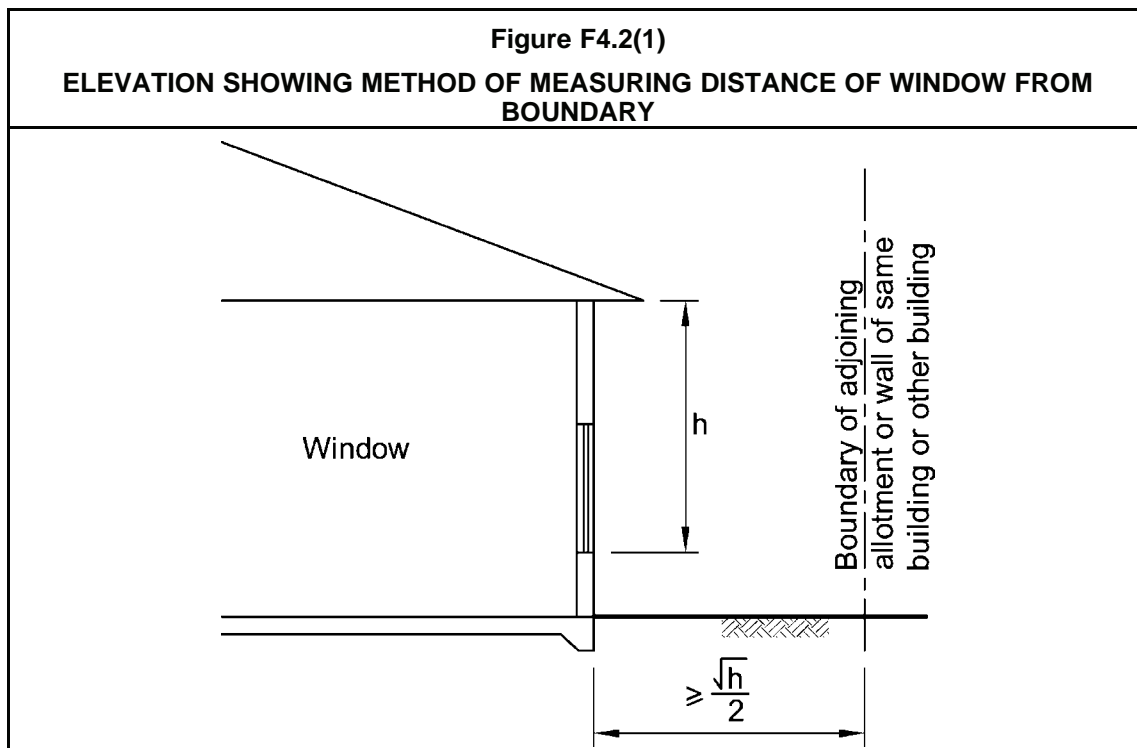

F4.2(b) does not prohibit windows closer to the boundary than one metre (or three metres in the case of a patient-care area in a Class 9a building). However, if a window is located within these distances, **F4.2(b)** does not allow it to be considered as providing required natural light to the subject room.

It should be noted that **F4.2(b)** does not apply to Class 9c buildings. **F4.2(c)** contains specific provisions for these buildings.

Figure F4.2 illustrates the method of measuring the distance of the window from:

- an adjoining allotment boundary;
- a wall of the same building; and
- a wall of another building on the same allotment.

F4.2(c) contains requirements for Class 9c aged care buildings. The requirement for the window sill to be not more than 1 m above floor level and at least 3 m from an adjoining allotment, another building or wall is to maintain amenity for residents who spend a significant amount of time sitting on chairs or lying in bed. **Figure F4.2(2)** illustrates the method of measuring these distances.

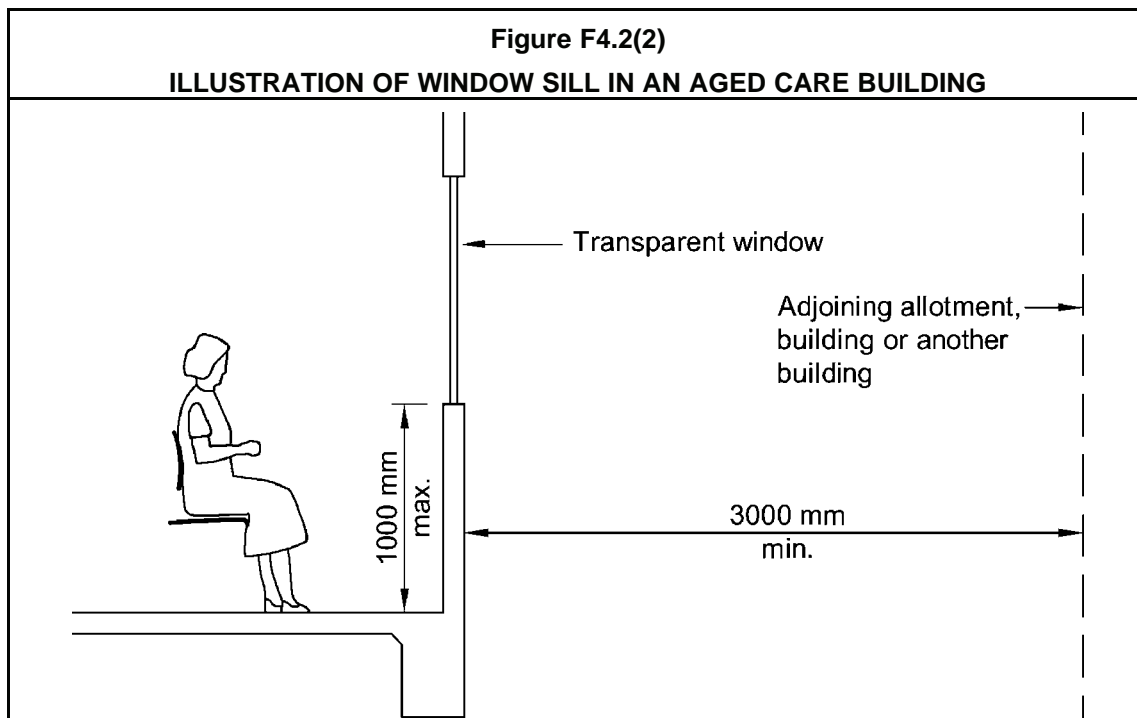

F4.3 Natural light borrowed from adjoining room

Intent

To allow natural light to be “borrowed” from an adjoining room.

F4.3 applies only to a room in:

- a Class 2 building;
- a Class 4 part; or
- a sole-occupancy unit in a Class 3 building.

For these Classes, it is sometimes acceptable for a room’s required natural light to be “borrowed” from an adjoining room (ie an adjoining room’s light can be used to help make up the total amount of natural light required in the subject room).

The use of borrowed light is acceptable if the provisions of **F4.3** are applied to the subject room and to the total area of each relevant room.

Any borrowed natural light must be from an adjoining room over which occupants of the subject room have some control. **F4.3(a)(i)** therefore requires that the adjoining room be within the same sole-occupancy unit or be an enclosed verandah on common property. As a consequence, the required natural light cannot be from another sole-occupancy unit.

Direct natural light provided from another source is intended to mean light from a window or roof light in the subject room. As the provision relates to natural lighting obtained from an adjoining room, 'another source' refers to direct natural light provided to the subject room which does not meet the required allowance of either 10% or 3% of the floor area for roof lights and windows respectively. By not meeting the required amount of natural light, the 'direct natural light from

another source' can be used as a supplement to the natural light required from an adjoining room.

To borrow natural light from another room, **F4.3(a)(ii)** allows light to pass through a glass panel or opening from an adjoining room which, under **F4.3(a)(iii)**, must have windows, roof lights or a combination of windows and roof lights of a minimum size in proportion to the combined floor areas of both rooms. The minimum size of the glass panel or opening, and the minimum size of the window to the adjoining room, are illustrated in **Figure F4.3**.

The area of openings needed to transmit natural light from an adjoining room may be reduced proportionally to the size of any openings in the subject room which transmit natural light directly from the outside.

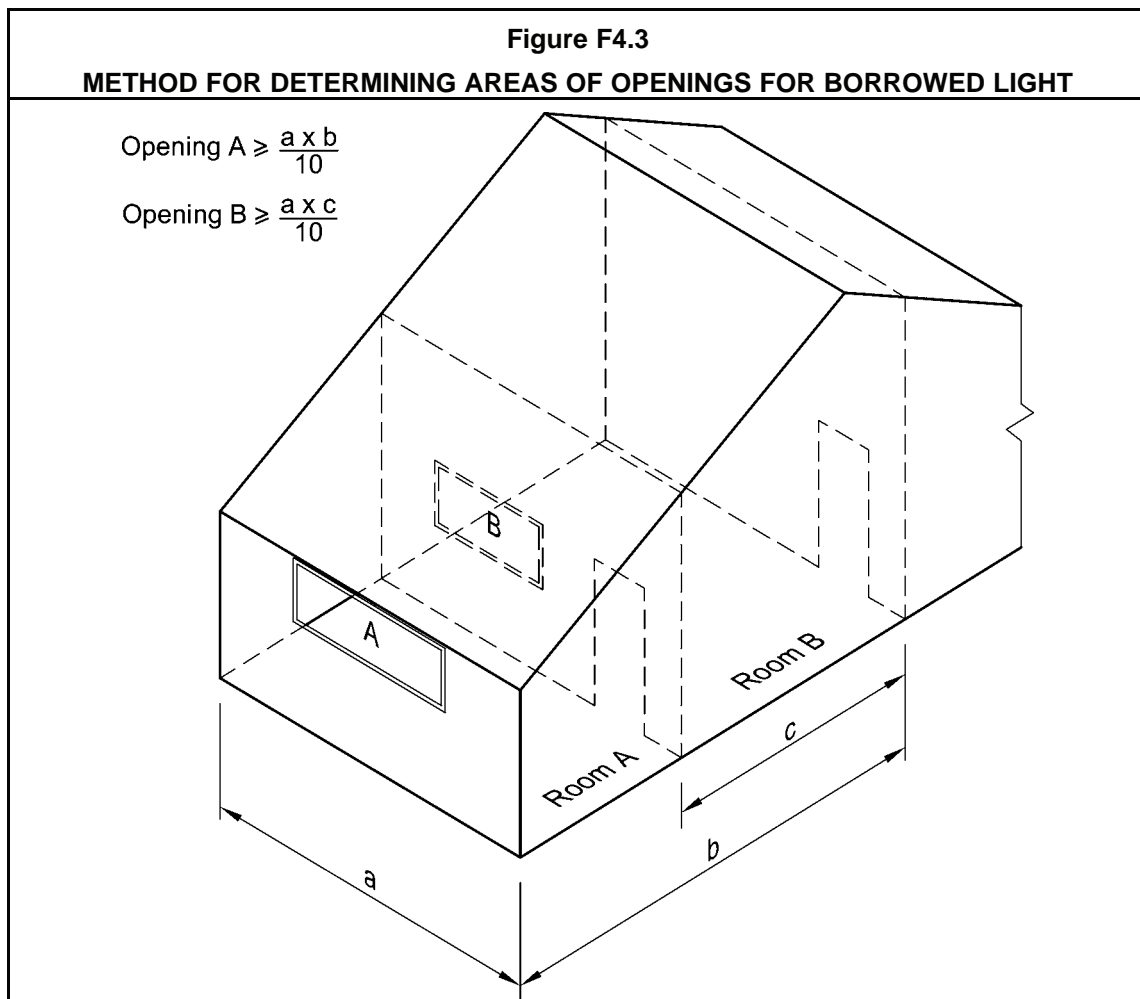

The same principle for Opening A in **Figure F4.3** can be applied for roof lights by substituting the required 10% opening in respect to the combined floor area with 3% of the combined floor area. It is also permitted to use a proportional combination of windows and roof lights. See the example in the comments on **F4.2** for an explanation.

F4.4 Artificial lighting

Intent

To specify the location and other requirements for required artificial lighting.

Artificial lighting is required where it is necessary to minimise any hazard to occupants during an emergency evacuation.

F4.4(a)(i) sets out those places where artificial lighting is always required. However, it does not require such lighting to be illuminated at all times.

F4.4(a)(ii) sets out those places where artificial lighting is required if an **F4.2** required standard of natural lighting required by **F4.2** is unavailable, and the periods of occupation of the areas, or the use of the space, will create an undue hazard during an evacuation.

Determination of whether or not the periods of occupation of the specified areas will create an undue hazard during an evacuation is a judgement, which requires a “performance-type” assessment.

Class 4 parts of buildings are subject to **F4.4(a)(ii)** only with regard to wet areas and airlocks. (Any required stairways and the like in the rest of the building, which contains the Class 4 part, are required to be artificially lit under **F4.4(a)(i)**).

Class 2 buildings are subject to **F4.4(a)(ii)** with regard to wet areas, airlocks and any common areas such as stairways, etc used in common by occupants.

Class 3 and Class 5–9 buildings are subject to **F4.4(a)(ii)** with regard to all rooms frequently occupied, and all corridors, stairways and similar circulation routes and paths of egress. Unless they are “frequently occupied”, wet areas (including those in Class 3 buildings) are not subject to **F4.4(a)(ii)**.

Apart from the “performance-type” judgement regarding the location of artificial lighting in those areas specified in **F4.4(a)(ii)**, the remainder of the requirements are contained in the AS/NZS 1680.0 specified in **F4.4(b)**.

F4.4(c) gives a concession for compliance with **F4.4(a)** in specific buildings which have lower levels of lighting as part of their normal operation. For example, the lighting levels specified in AS/NZS 1680.0 would be inappropriate during the screening of a movie in a cinema or may lead to damage of artworks in a gallery.

F4.5 Ventilation of rooms

Intent

To state the natural and mechanical ventilation requirements for rooms and buildings.

The specified rooms and buildings, and any other room occupied by a person for any purpose, must be provided with either:

- natural ventilation complying with **F4.6**; or
- mechanical ventilation or an air-conditioning system that complies with both of the Standards referenced in **F4.5(b)**.

F4.6 Natural ventilation

Intent

To specify the requirements for the size and location of windows providing required natural ventilation.

F4.6 requires that permanent openings, windows, doors or other openable means provide natural ventilation. It also deals with the size of such openings, and the locations to which such openings must open.

F4.6(b)(i) requires a judgement regarding what is “suitably sized”; and **F4.6(b)(ii)** requires a judgement regarding what is “open”.

F4.6 does not require any of the required natural ventilation to be “fixed ventilation” or “permanent openings” as against “devices which can be opened”. The building proponent can make the decision.

If the natural ventilation openings are used only for ventilation purposes, roller shutters and doors can cover the openings if they achieve the performance standard in **F4.6(a)** and **(b)**. However, if the openings are also used for egress purposes, they must comply with the requirements of provisions such as **D2.19** and **D2.21**.

F4.7 Ventilation borrowed from adjoining room

Intent

To allow natural ventilation to be “borrowed” from adjoining rooms.

F4.7(a) applies only to:

- Class 2 buildings;
- Class 4 parts; and
- sole-occupancy units in Class 3 buildings.

F4.7(b) applies only to Class 5–9 buildings.

It is sometimes acceptable for a room’s required natural ventilation to be “borrowed” from an adjoining room (ie an adjoining room’s ventilation can be used to help make up the total amount of ventilation required).

The use of borrowed ventilation is acceptable if the provisions of **F4.7** are applied to the subject room and to the total area of each relevant room.

Any borrowed natural ventilation to a room must be from a room over which the occupants have some control. **F4.7(a)** therefore requires that the adjoining room be:

- within the same sole-occupancy unit; or
- an enclosed verandah on common property.

In a Class 2 or Class 3 building or Class 4 part, this requirement means that the natural ventilation cannot be from another sole-occupancy unit.

F4.7(a) and **(b)** allows a window, an opening, a ventilating door, or the like, to be used to “borrow” ventilation air from an adjoining room. The minimum area required for ventilation in residential buildings is illustrated in **Figure F4.7**.

In Class 5–9 buildings, the area of ventilation opening required under **F4.7(b)** is similar to that required for residential buildings, except that:

- the area of ventilation opening must be increased from 5% to 10%; and
- any part of the ventilation opening between the rooms more than 3.6 metres above the floor must not be included as part of the required ventilation area.

Under **F4.7(c)**, the area of openings needed to transfer natural ventilation borrowed from an adjoining room may be reduced proportionally to the size of any window or other opening in the room which receives natural ventilation directly from the outside.

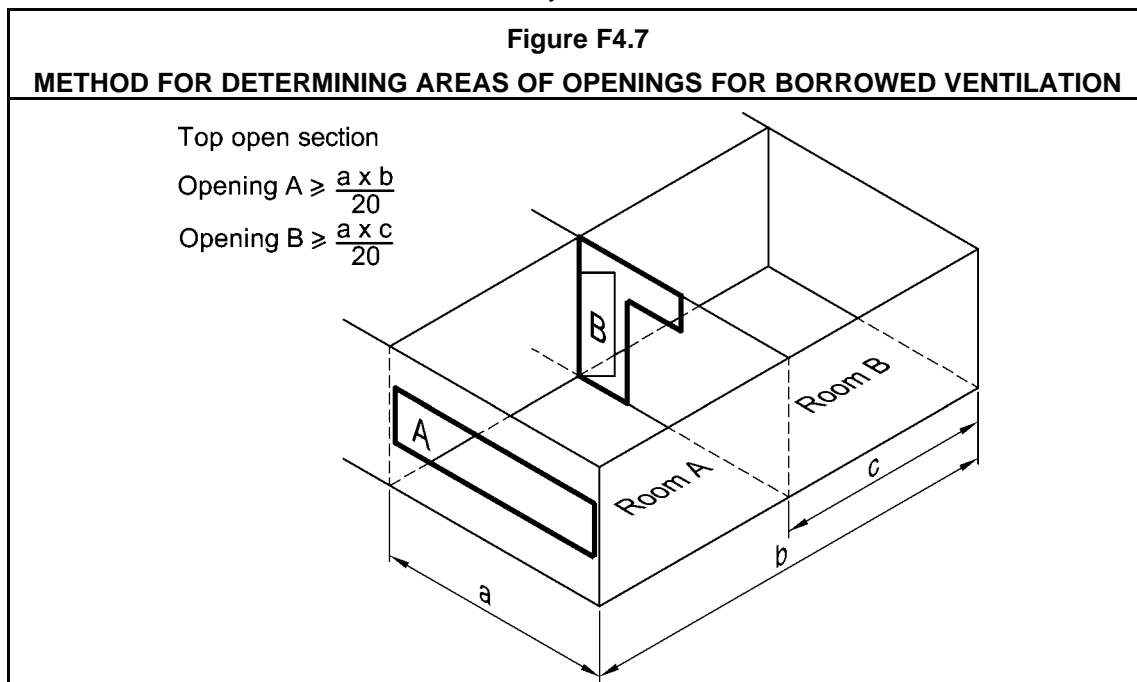

F4.8 Restriction on position of water closets and urinals

Intent

To minimise the impact of unpleasant smells.

While **F4.8** prohibits toilets opening directly into specified areas, **F4.9** sets out how toilets can serve those areas by using:

- airlocks or airlock equivalents; or
- mechanical exhaust ventilation and, in some cases, screening.

The odours from toilets can be unpleasant and so it is desirable to minimise their impact on adjacent areas such as:

- a kitchen or pantry;
- public-eating areas, but not domestic-eating areas (other than kitchens);
- Class 3 building dormitories (but no other sleeping areas);
- some assembly buildings (but not kindergartens, primary schools or open spectator stands); and
- most workplaces.

The exclusions include sleeping areas other than Class 3 dormitories. In houses, flats, motels and hotels the odours are usually generated by the resident/s, whereas, in a dormitory there is a high likelihood that:

- the odours are generated by unrelated people;
- the toilet-use ratio is higher; and
- there could also be a privacy issue.

Some other exclusions are kindergartens excluded because staff need to keep children under continuous observation and open spectator stands because these are generally open to the air and therefore inherently well ventilated.

F4.9 Airlocks

Intent

To specify requirements for airlocks or mechanical ventilation where toilets open directly into other rooms.

While [F4.8](#) prohibits toilets opening directly into specified areas, [F4.9](#) sets out how toilets can serve those areas by using:

- airlocks or airlock equivalents; or
- mechanical exhaust ventilation and, in some cases, screening.

It is desirable to minimise toilet odours in particular areas. See [F4.8](#) and [F4.9](#) for airlock and mechanical exhaust ventilation where a builder wishes to locate a toilet close to, or open directly into, the areas specified in [F4.8](#).

F4.10 * * * * *

The content of [F4.10](#), which existed in BCA 1990, has been relocated to [F1.12](#). The Clause number [F4.10](#) has been retained without text so as not to change the numbering of the current BCA from that of BCA 1990.

F4.11 Carparks

Intent

To specify ventilation requirements for carparks, to ensure car fumes are adequately removed.

[F4.11](#) does not apply to an open-deck carpark because such carparks are provided with adequate, permanent, natural ventilation.

AS 1668.2 contains mechanical ventilation requirements for the Deemed-to-Satisfy Provisions.

[F4.11\(b\)](#) contains a “performance-type” requirement for natural ventilation of carparks. Any proposal for such a ventilation system would need to satisfy the appropriate authority that it will be:

- “adequate” for the purpose intended; and
- “permanent”, meaning that consideration should be given to the possibility of openings being blocked or obstructed over time.

AS 1668.2 permits the mechanical ventilation system to be omitted under specified conditions if the building is naturally ventilated.

F4.12 Kitchen local exhaust ventilation

Intent

To minimise the spread of cooking odours and fire from commercial kitchens.

The aim of **F4.12** is to:

- reduce the prevalence of airborne fats, etc building up, and causing health and fire problems;
- reduce steam and smoke from cooking processes; and
- maintain the flow of air to reduce potentially obnoxious odours.

The figures in **F4.12(a)** relate to the size of any electrical or gas cooking apparatus, which may cause these problems.

The figures in **F4.12(b)** relate to the ratio of electrical or gas cooking apparatuses to room size, which may cause these problems.

The Deemed-to-Satisfy Provisions require exhaust hoods to comply with both AS/NZS 1668.1 and AS 1668.2.

PART F5

SOUND TRANSMISSION AND INSULATION

Objective

FO5

Part **F5** addresses sound and its impact on health and amenity, but only within a Class 2, Class 3 and Class 9c buildings. Reasons why it does not cover sound emanating from outside the building include:

- builders, etc have little control over external sound, which is usually intermittent during daylight hours when the background ambience sound within the building is greater; and
- sound generated within a building is more likely to pass through walls and fittings, and cannot be controlled by simply closing a window. Such sounds can be more intrusive and disruptive to occupants.

Functional Statement

FF5.1

To achieve **FO5** in a Class 2, Class 3 and Class 9c buildings, sound transmission must be minimised through a building element that separates:

- sole-occupancy units;
- a sole-occupancy unit and a common space; or
- a sole-occupancy unit from parts of the building with a different classification.

Because of its emphasis on building elements which separate sole-occupancy units and sole-occupancy units and common spaces and parts of the building with a different classification, **FF5.1** does not cover building elements which separate sole-occupancy units from the outside of a building, and therefore does not cover:

- sound generated outside a building; or
- sound escaping from a building and re-entering via an external element.

Performance Requirements

FP5.1

FP5.1 applies to Class 2 and 3 buildings and relates to the floor between sole-occupancy units, sole-occupancy units and specified spaces, and sole-occupancy units and parts of a different classification. It covers both airborne and impact generated sound. **FP5.1** covers sound transmission through floors from a number of specified spaces. A list is included with the

additional words 'or the like'. An example of a floor separating sole-occupancy units from parts of a different classification, would be a floor separating ground floor shops from an apartment level above.

FP5.2

FP5.2 applies to Class 2 and 3 buildings and relates to the walls between sole-occupancy units, sole-occupancy units and specified spaces, and sole-occupancy units and parts of a different classification. It covers both airborne and impact generated sound. **FP5.2(b)** covers sound transmission through walls from a number of specified spaces. A list is included with the additional words 'or the like'. An example of a wall separating sole-occupancy units from parts of a different classification, would be a wall in a building between shops and hotel rooms.

Unlike **FP5.1**, impact generated sound is only a consideration for walls separating a bathroom, kitchen, sanitary compartment or laundry in one sole-occupancy unit from a habitable room (other than a kitchen) in an adjoining unit.

FP5.3

FP5.3 supports the requirements of **FP5.1** and **FP5.2** in that the performance of building elements in Class 2 and Class 3 buildings are not to be compromised because of services that penetrate the elements.

Examples

Sounds prohibited under **FP5.3** include those from a service pipe in the form of:

- pump vibration;
- water hammer; or
- sewerage or sullage discharging in soil or waste pipes.

FP5.4

FP5.4 relates to floors between sole-occupancy units in Class 9c aged care buildings. It covers airborne and impact-generated sounds between units located above one another. It does not cover sound transmission through floors from common spaces, such as a common corridor, laundry or entertainment area.

FP5.5

FP5.5 only applies to Class 9c aged care buildings.

For airborne sound, **FP5.5** relates to the insulation of walls:

- between sole-occupancy units; and
- between sole-occupancy units and a kitchen, bathroom, sanitary compartment (not being an associated ensuite), laundry, plant room or utilities room.

For impact generated sound, **FP5.5** relates to the insulation of walls between sole-occupancy units and a kitchen or laundry.

FP5.6

FP5.6 supports the requirements of **FP5.4** and **FP5.5** in that the performance of building elements in Class 9c aged care buildings are not to be compromised because of services that penetrate the elements

Examples

Sounds prohibited under **FP5.3** include those from a service pipe in the form of:

- pump vibration;
- water hammer; or
- sewerage or sullage discharging in soil or waste pipes.

Verification Methods

FV5.1

FV5.1 is a means of verifying whether a floor achieves the requirements of **FP5.1** and **FP5.3** in minimising the transmission of airborne and impact generated sound through the floor. It only applies to Class 2 and 3 buildings.

It is not compulsory for a designer to use **FV5.1**. The designer has the choice of using:

- **FV5.1** to verify that a proposal achieves **FP5.1** and **FP5.3**;
- the Deemed-to-Satisfy Provisions of **Part F5**; or
- another means of verifying that **FP5.1** and **FP5.3** will be achieved.

If **FV5.1** is used to verify compliance, when tested on site the floor must have a weighted standardised level difference with spectrum adaptation term ($D_{nT,w} + C_{tr}$) not less than 45, and a weighted standardised impact sound pressure level with spectrum adaptation term ($L_{nT,w} + C_I$) not more than 62.

$D_{nT,w}$ is a measure of airborne sound insulation, similar to R_w . C_{tr} is a spectrum adjustment factor which adjusts for low frequency sound levels. C_{tr} has been chosen in recognition of the problems caused by the high bass frequency outputs of modern home theatre systems and music reproduction equipment used by occupants of Class 2 and 3 buildings.

The $D_{nT,w}$ and C_{tr} must be determined in accordance with either AS/NZS 1276.1 or ISO 717.-1. These documents outline how to use test results to determine the $D_{nT,w}$ and C_{tr} of a building element. The test results must be obtained by testing the floor in accordance with ISO 140-4. ISO 140-4 is the method for testing the airborne sound insulation of building elements in the field.

$L_{nT,w}$ is a measure of impact sound insulation. C_I is a spectrum adjustment factor which takes into account certain sounds that are more readily transmitted through floors than others. The lower the $L_{nT,w} + C_I$, the better the floor's impact sound insulation rating.

The $L_{nT,w} + C_I$ must be determined in accordance with AS/ISO 717.2. This document outlines how to use test results to determine the $L_{nT,w}$ and C_I of a building element. The test results must be obtained by testing of the floor in accordance with ISO 140-7. ISO 140-7 is the method for testing the impact sound insulation of building elements in the field.

FV5.2

FV5.2 is a means for verifying if a wall complies with the requirements of **FP5.2(a)** and **FP5.3** in minimising the transmission of airborne sound through the wall. As with **FV5.1** it only applies to Class 2 and 3 buildings.

It is not compulsory for a designer to use **FV5.2**. The designer has the choice of using:

- **FV5.2** to verify that a proposal achieves **FP5.2(a)** and **FP5.3**;
- the Deemed-to-Satisfy Provisions of **Part F5**; or
- another means of verifying that **FP5.2(a)** and **FP5.3** will be achieved.

If **FV5.2** is used to verify compliance, when tested on site the wall must have a weighted standardised level difference with spectrum adaptation term ($D_{nT,w} + C_{tr}$) not less than 45.

$D_{nT,w}$ is a measure of airborne sound insulation, similar to R_w . C_{tr} is a spectrum adjustment factor which adjusts for low frequency sound levels. C_{tr} has been chosen in recognition of the problems caused by the high bass frequency outputs of modern home theatre systems and music reproduction equipment used by occupants of Class 2 and 3 buildings.

The $D_{nT,w}$ and C_{tr} must be determined in accordance with either AS/NZS 1276.1 or ISO 717.-1. These documents outline how to use test results to determine the $D_{nT,w}$ and C_{tr} of a building element. The test results must be obtained by testing the wall/floor in accordance with ISO 140-4 is the method for testing the airborne sound insulation of building elements in the field.

Unlike **FV5.1**, the requirements differ depending on the location of the wall. Walls separating sole-occupancy units require a $D_{nT,w} + C_{tr}$ not less than 45. Walls separating sole-occupancy units and areas such as plant rooms, lift shafts, stairways, public corridors, public lobbies or the like, or parts of a different classification, must have a $D_{nT,w}$ not less than 45. C_{tr} does not apply in these instances, as the walls separate units from areas that are not likely to produce low frequency noise, which C_{tr} accounts for.

Door assemblies are permitted in walls between sole-occupancy units and public corridors, stairways or the like, providing the door assembly has a $D_{nT,w}$ not less than 25. Door assemblies are also permitted in walls between sole occupancy units, providing the door assembly has the same level of sound insulation as the wall ie. $D_{nT,w} + C_{tr}$ not less than 45.

There is no verification method for determining compliance with **FP5.2(b)**. **FP5.2(b)** outlines the impact generated sound insulation requirements for walls. Therefore, in this instance the options for compliance are:

- the Deemed-to-Satisfy Provisions of **Part F5** i.e. discontinuous construction; or
- another means of verifying that **FP5.2(b)** will be achieved.

PART F5 SOUND TRANSMISSION AND INSULATION

Deemed-to-Satisfy Provisions

F5.0 Deemed-to-Satisfy Provisions

Intent

To clarify that the requirements of **FP5.1–FP5.6** will be satisfied if compliance is achieved with **F5.1–F5.7**.

F5.1 Application of Part

Intent

To clarify that **Part F5** only applies to Class 2, Class 3 and Class 9c buildings.

F5.2 Determination of airborne sound insulating ratings

Intent

To clarify the means of determining the airborne sound insulating rating (R_w , $R_w + C_{tr}$).

Throughout the **Part F5** Deemed-to-Satisfy Provisions, some forms of construction are required to have an R_w or $R_w + C_{tr}$. R_w and C_{tr} must be:

- determined under AS/NZS 1276.1 or ISO 717.-1 using laboratory measurements; or
- in compliance with **Specification F5.2**.

R_w is a measure of airborne sound insulation. C_{tr} is a spectrum adjustment factor which adjusts for low frequency sound levels. C_{tr} has been chosen in recognition of the problems caused by the high bass frequency outputs of modern home theatre systems and music reproduction equipment used by occupants of Class 2 and 3 buildings.

The R_w and C_{tr} must be determined in accordance with either AS/NZS 1276.1 or ISO 717.1. These documents outline how to use test results from testing a building element to determine the R_w and C_{tr} of the building element. The test results must be obtained by testing the building element in accordance with ISO 140-3. ISO 140-3 is the method for testing the airborne sound insulation of building elements in the laboratory.

This part previously referenced Sound Transmission Class (STC) ratings as a measure of sound insulation. The STC rating has been replaced by R_w and $R_w + C_{tr}$. A note contained in Specification A1.3 under AS/NZS 1276.1 states that materials tested in accordance with the previous Standard AS 1276 – 1979 must be considered equivalent to R_w values. These tests are only valid if they were issued prior to AS/NZS 1276.1 – 1999 being referenced in the BCA.

F5.3 Determination of impact sound insulation ratings

Intent

To clarify the means of determining the impact sound insulation ratings.

In **F5.4(a)** floors separating certain areas are required to have an $L_{n,w} + C_1$. F5.3(a) outlines that the $L_{n,w} + C_1$ must be:

- determined under AS/ISO 717.2 using laboratory measurements; or
- in compliance with **Specification F5.2**.

$L_{n,w}$ is a measure of impact sound insulation. C_1 is a spectrum adjustment factor which takes into account certain sounds that are more readily transferred through floors than others. The types of impact generated noise passing through floors that the requirements are aimed at minimising are noise associated with footsteps and moving of furniture.

F5.3(b)(i) requires walls of Class 2 and 3 buildings required to have an impact sound insulation rating to be of discontinuous construction. This term is defined in **F5.3(c)** and applies to all of Part F5 including Specifications **F5.2** and **F5.5**.

F5.3(b)(ii) requires walls of a Class 9c aged care building required to have an impact sound insulation rating to:

- for other than masonry, consist of at least two separate leaves that do not have any rigid mechanical connection except at the periphery. (The reason for not allowing rigid connection is to reduce the transmission of impact sound to the sleeping area) ;or
- be identical with a prototype having at least the same resistance to impact sound as a wall complying with **Table 2** of Specification F5.2.

F5.3(c) sets out a definition of discontinuous construction. The definition applies to the whole of Part F5 (including Specifications **F5.2** and **F5.5**) and is a wall having a cavity of at least 20 mm between 2 leaves, and:

- for masonry, only be connected with resilient wall ties. (These are a particular type of wall tie and are sometimes referred to as acoustic wall ties); and
- for other than masonry, other than at the periphery, have no mechanical linkage between the leaves. This means that a staggered stud wall is not deemed to be discontinuous construction.

F5.4 Sound insulation rating of floors

Intent

To minimise the transmission of sound through floors separating sole-occupancy units, and floors separating sole-occupancy units and certain types of space.

F5.4 contains requirements for Class 2, 3 and 9c aged care buildings.

For Class 2 and 3 buildings, a floor requires both airborne ($R_w + C_{tr}$) and impact sound insulation ($L_{n,w} + C_1$) if it separates:

- sole-occupancy units;
- a sole-occupancy unit from a plant room, lift shaft, stairway, public corridor, public lobby or the like; or

- parts of a different classification.

For Class 9c aged care buildings, a floor requires airborne sound insulation if it separates sole-occupancy units.

The requirements differ between Class 2 and 3 buildings, and Class 9c aged care buildings. This is due to sole-occupancy units in Class 2 and 3 buildings being 'noisier' than sole-occupancy units in Class 9c buildings. The reasons include the presence of televisions, stereos and DVDs and activities that may be conducted in Class 2 and 3 buildings. Therefore, C_{tr} and impact sound insulation only apply to Class 2 and 3 buildings. Also, the level of airborne sound insulation required in Class 9c buildings is less.

F5.5 Sound insulation rating of walls

Intent

To minimise the transmission of sound through walls separating sole-occupancy units and walls separating sole-occupancy units and certain types of spaces.

F5.5(a) and **(b)** apply to Class 2 and 3 buildings. **F5.5(a)** covers walls separating sole-occupancy units, and walls separating sole-occupancy units and certain spaces. **F5.5(b)** applies to a door assembly in a wall that separates a sole-occupancy unit from a common area. **F5.5(c)** and **(d)** apply to Class 9c aged care buildings. **F5.5(c)** applies to walls which separate sole-occupancy units and sole-occupancy from certain spaces. **F5.5(d)** applies to a wall that separates a sole-occupancy unit from a kitchen or laundry. **F5.5(e)** and **(f)** contains additional requirements for sound insulated walls.

As with the requirements for floors, the requirements for walls differ between Class 2 and 3 buildings, and Class 9c aged care buildings. This is due to sole-occupancy units in Class 2 and 3 buildings being 'noisier' than sole-occupancy units in Class 9c buildings. The reasons include the presence of televisions, stereos and DVDs and activities that may be conducted in Class 2 and 3 buildings. Therefore, C_{tr} only applies to Class 2 and 3 buildings. Also, the level of airborne sound insulation required in Class 9c buildings is less.

F5.5(a) outlines airborne and impact sound insulation requirements for walls. The airborne sound requirements apply to walls separating sole-occupancy units and a sole-occupancy unit from a plant room, lift shaft, stairway, public corridor, public lobby or the like, or parts of a different classification. For walls separating sole-occupancy units, the wall must have a $R_w + C_{tr}$ not less than 50. For walls separating a sole-occupancy unit from a plant room, lift shaft, stairway, public corridor, public lobby or the like, or parts of a different classification, the wall must have a R_w not less than 50. For walls separating habitable areas (excluding a kitchen) in one sole-occupancy unit from a bathroom, laundry, kitchen or sanitary compartment in an adjoining unit, the wall must be discontinuous construction. For the purpose of the BCA, discontinuous construction is a wall having a minimum 20 mm cavity between 2 separate leaves, with:

- for masonry, where wall ties are required to connect leaves, the ties are of the resilient type; and
- for other than masonry, there is no mechanical linkage between leaves, except at the periphery.

Mechanical linkage at the periphery is referring to the connection of the wall to the floor/roof and adjoining walls such as an external wall etc. A staggered stud wall with common top/bottom plates is not considered to be discontinuous construction.

F5.5(b) provides a concession for a door assembly located in a wall that separates a sole-occupancy unit from public corridor or the like. The door requires an R_w of not less than 30

whereas the wall requires R_w of not less than 450. This concession does not apply to a door assembly in a wall separating sole-occupancy units. In this case the door assembly would need to meet the same requirements for the wall, i.e. $R_w + C_{tr}$ 50.

F5.5(c) applies to Class 9c aged care buildings and covers sound transmission through sole-occupancy units from certain adjoining rooms and spaces. The list of adjoining rooms and spaces does not include the words 'or the like' because it is intended to be specific to only those areas.

The list of other spaces in **F5.5(c)** does not include stairways, public corridors, hallways, etc. The reason is that aged care buildings are to be provided with a level of sound insulation around the resident bedroom/sleeping areas to ensure a level of privacy, but still allow the residents to be reassured they are not alone. If the R_w of the wall is too high it may create a feeling of isolation for the residents and this can be detrimental to their well being. Being able to hear sounds that are outside their bedroom provides reassurance that assistance is available. The walls of sole-occupancy units prescribed in **F5.5(c)** must be at least R_w 45.

F5.5(d) applies to Class 9c aged care buildings and deals with reducing the level of impact sound through the walls of the sole-occupancy units from adjoining kitchens and laundries. To comply with **F5.5(d)**, it is necessary for the wall to have an R_w not less than 45 (as required by **F5.5(c)**) and:

- for other than masonry, consist of at least two separate leaves that do not have any rigid mechanical connection except at the periphery. (The reason for not allowing rigid connection is to reduce the transmission of impact sound to the sleeping area) ;or
- be identical with a prototype having at least the same resistance to impact sound as a wall complying with Table 2 of **Specification F5.2**.

F5.5(e) and **(f)** requires sound insulated walls to extend to either the roof/floor above or a ceiling that provides the required level of sound insulation. This is to ensure that there is no space above the wall which provide a flanking path for sound to travel through.

F5.6 Services

Intent

To minimise the transmission of sound that may arise from services that pass through more than one sole-occupancy unit.

F5.6 details separation requirements for services. The requirements only apply to services which pass through more than one sole-occupancy unit or are located in a wall or floor cavity which separates sole-occupancy units. **F5.6** does not apply if the pipe is only located in a single unit, or any part of a Class 2, 3 or 9c aged care building which is not part of a sole-occupancy unit.

The $R_w + C_{tr}$ values do not take account of the inherent acoustic properties of a pipe material.

F5.7 Isolation of pumps

Intent

To minimise sound transmission from a pump.

F5.7 requires flexible couplings at connection points to or from a pump to minimise vibration and any consequent sound transmission along the piping.

SUPERSEDED
HEALTH AND AMENITY

SPECIFICATION **F5.2** Sound Insulation for Building Elements

Deemed-to-Satisfy Provisions

Specification F5.2 (in conjunction with **Table 2** of **Specification F5.2**) gives information on the weighted sound reduction index (R_w), weighted sound reduction index with spectrum adaptation term ($R_w + C_{tr}$) and weighted normalised impact sound pressure level with spectrum adaptation term ($L_{n,w} + C_l$) for some common forms of building construction. It also list examples of discontinuous construction.

Further information can be obtained through literature produced by building product manufacturers.

SPECIFICATION **F5.5** IMPACT SOUND—TEST OF
EQUIVALENCE

Deemed-to-Satisfy Provisions

Specification F5.5 contains details of the test procedure to determine how a proposed wall system resists the transmission of impact sound, in comparison to a system in **Table 2 of Specification F5.2**.

Clause 2 outlines the construction to be tested, and only requires that the **Table 2 of Specification F5.2** system being used as a test comparison is tested once, so long as certain specified conditions are followed.

Clause 3 outlines the precise method to determine how a proposed wall system resists the transmission of impact sound, in comparison to a system included in **Table 2 of Specification F5.2**. Several referenced documents are used as the basis of the testing procedure.

ANCILLARY PROVISIONS

- G1** **Minor Structures and Components**

- G2** **Heating Appliances, Fireplaces, Chimneys and Flues**

- G3** **Atrium Construction**

- G4** **Construction in Alpine Areas**

- G5** **Construction in Bushfire Prone Areas**

SECTION G CONTENTS

SECTION G ANCILLARY PROVISIONS

Part G1 Minor Structures and Components

Objective GO1

Functional Statements GF1.1 - GF1.3

Performance Requirements GP1.1 - GP1.4

G1.0 Deemed-to-Satisfy Provisions

G1.1 Swimming pools

G1.2 Refrigerated chambers, strong-rooms and vaults

Part G2 Heating Appliances, Fireplaces, Chimneys and Flues

Objective GO2

Functional Statements GF2.1 - GF2.2

Performance Requirements GP2.1 - GP2.2

G2.0 Deemed-to-Satisfy Provisions

G2.1 * * * * *

G2.2 Installation of appliances

G2.3 Open fireplaces

G2.4 Incinerator rooms

Part G3 Atrium Construction

G3.1 Atriums affected by this Part

G3.2 Dimensions of atrium well

G3.3 Separation of atrium by bounding walls

G3.4 Construction of bounding walls

G3.5 Construction at balconies

G3.6 Separation at roof

G3.7 Means of egress

G3.8 Fire and smoke control systems

Specification G3.8 Fire and Smoke Control Systems in Buildings Containing Atriums

Part G4 Construction in Alpine Areas

Objective GO4

Functional Statement GF4.1

Performance Requirements GP4.1 - GP4.4

G4.0 Deemed-to-Satisfy Provisions

G4.1 Application of Part

G4.2 * * * * *

G4.3 External doorways

G4.4 Emergency lighting

G4.5 External ramps

G4.6 Discharge of exits

G4.7 External trafficable structures

G4.8 Fire-fighting services and equipment
G4.9 Fire orders

Part G5 Construction in Bushfire Prone Areas

Objective GO5
Functional Statement GF5.1
Performance Requirements GP5.1
G5.0 Deemed-to-Satisfy Provisions
G5.1 Application of Part
G5.2 Protection

PART G1

MINOR STRUCTURES AND COMPONENTS

Objective

GO1

Coverage

GO1 relates to two distinct matters:

- **GO1(a)–(d)**—swimming pools; and
- **GO1(e)**—the risk of people being locked in confined spaces.

Swimming pools—**GO1(a)–(c)**

GO1(a) aims to minimise health risks to people from discharged waste water from a swimming pool. Such waste can spread disease.

GO1(b) relates to drainage from a swimming pool to protect other property from damage.

GO1(c) relates to preventing access of young children to swimming pools.

GO1(d) aims to prevent injury or drowning of people due to suction from a swimming pool recirculation system.

GO1 is limited in its application around Australia as a number of States and Territories have separate legislation controlling swimming pools and swimming pool fencing.

Accidental locking in small spaces—**GO1(e)**

GO1(e) aims to prevent illness or injury to people from being locked in small spaces which are only intended to be entered for short periods (eg coolrooms).

Functional Statements

GF1.1

Swimming pool drainage

GF1.1 controls the drainage and disposal of water from swimming pools. **GF1.1** does not apply in the Northern Territory.

GF1.2

Swimming pools—access for young children **GF1.2(a)**

GF1.2(a) controls access by young children to swimming pools. This is to provide protection from illness, injury and death resulting from unsupervised access to swimming pools. Accordingly, systems designed as alternatives to the Deemed-to-Satisfy Provisions must be designed, approved and installed to provide equivalent restrictions to a young child.

Application

GF1.2(a) is limited in its application around Australia.

Swimming pools—recirculation systems **GF1.2(b)**

GF1.2(b) controls swimming pool recirculation systems so that people cannot be entrapped by the suction from the system.

GF1.3

Accidental locking in small spaces

GF1.3 aims to make sure that people in confined spaces, such as cooling chambers, strongrooms and vaults, are able to:

- leave the space if the door accidentally closes; and
- alert people outside the confined space if there is an emergency.

Performance Requirements

GP1.1

Swimming pool drainage

GP1.1 relates to swimming pool drainage in two basic ways:

Prevention of illness—**GP1.1(a)**

To comply with **GP1.1(a)**, it will generally be necessary that water must drain away from the pool surrounds and not flow on to the same or adjoining property. Such pooling could cause illness through:

- excessive moisture conditions degrading any building; and
- the creation of disease breeding grounds.

GP1.1(a) also aims to ensure that water is not left in puddles where people could slip. Water should not be left under decking, creating conditions for mosquito breeding and unhealthy pools of stagnant water.

Protection of other property from damage—**GP1.1(b)**

GP1.1(b) requires that pool water not affect other property. Measures must be taken to ensure that water drained from a pool does not affect other buildings.

No Deemed-to-Satisfy Provisions for **GP1.1**

There are no Deemed-to-Satisfy Provisions for **GP1.1**. This is because the solution to compliance with **GP1.1** will vary considerably from allotment to allotment. This does not alter the fact that compliance must be achieved with **GP1.1**.

GP1.2

Swimming pools—access for young children

GP1.2(a) relates to swimming pool barriers. Swimming pool safety fencing should be constructed so as to be impenetrable by young children, having regard to:

- the height and rigidity of the fence;
- any horizontal climbable members;
- openings and footholds in the fence; and
- the operation of self-closing and latching gates.

GP1.2(a)(i) requires barriers be continuous. However, the barrier does not have to be a single form or type of construction (eg: it may consist of allotment fences in combination with building walls).

A barrier must have sufficient structural strength to withstand people leaning or falling against it. Guidance on suitable structural loading criteria can be obtained from AS 1926.

GP1.2(a)(iii) requires that young children be prevented from entering the immediate pool surrounds.

GP1.2(a)(iv) requires any access gates or doors to be self-closing and latching.

The limitation of the application of **GP1.2** is the same for **GF1.2**.

Swimming pools—recirculation systems

GP1.2(b) requires a swimming pool water recirculation system to have appropriate safety measures to avoid the possibility of a person becoming entrapped by the suction of the system. Such entrapment in the past has led to injuries, and when it occurs under water, to drowning.

GP1.3

Accidental locking in small spaces

GP1.3 relates to areas such as refrigeration and cooling chambers. It aims to maximise the safety of people working in them, by preventing them accidentally being trapped inside.

These provisions only relate to chambers of sufficient size for a person to enter.

GP1.3(a) requires a communication system to allow people within the chamber to alert others that they are trapped, etc. The communication system should be able to be seen or heard above any work going on in the building.

GP1.3(b) specifies that the egress route door must:

- be of sufficient size for an adult to move through; and
- be openable from the inside without a key at all times. (This provision overrides any corresponding requirements or concessions in **Section D**).

GP1.4

GP1.4 aims to maximise the safety of people working in strongrooms and vaults of sufficient size to allow people to enter.

Within the vault there must be:

- means of communication with people in the building; and

- an internal light controlled only from within the room (ie: there must be no override switch outside the vault).

Under **GP1.4(c)**, there must be an indicator outside the vault which clearly shows if it is occupied. The indicator should be clearly marked as relating to the actual vault.

PART **G1** Minor Structures and Components

Deemed-to-Satisfy Provisions

G1.0 Deemed-to-Satisfy Provisions

Intent

To clarify that:

- there are no Deemed-to-Satisfy Provisions for compliance with **GP1.1**; and
- compliance with **GP1.2–GP1.4** will be achieved if compliance is achieved with **G1.1** and **G1.2**.

No Deemed-to-Satisfy Provisions for **GP1.1**

There are no Deemed-to-Satisfy Provisions for **GP1.1**. This is because the solution to compliance with **GP1.1** will vary considerably from allotment to allotment. This does not alter the fact that compliance must be achieved with **GP1.1**.

Some options for compliance may be found in Volume Two of the BCA: Part 3.1.2.

Information on drainage requirements may be obtained from the appropriate authority. The legal discharge point from an allotment is generally determined by the appropriate local government authority.

G1.1 Swimming pools

Intent

To minimise the risk of young children sustaining injury as a result of gaining unsupervised access to a swimming pool.

Swimming pools—access for young children

G1.1(a) indicates that the Deemed-to-Satisfy Provisions for swimming pools do not apply in certain States and Territories which have separate legislation for swimming pool safety fencing. **G1.1(a)** lists the relevant applicable legislation.

G1.1(b) indicates that subject to **G1.1(c)** and **(d)**, a barrier installed in accordance with AS 1926 Parts 1 and 2—*Swimming Pool Safety*, will form a suitable barrier to swimming pools associated with a Class 2 or Class 3 building or Class 4 part.

AS 1926 Part 2 provides a number of options for the location of swimming pool safety fencing.

G1.1(c) restricts the use of a child-resistant doorset to only indoor swimming pools. A child-resistant doorset cannot be used to provide access to an outdoor swimming pool.

G1.1(d) requires that a side-hung door forming part of the barrier for an indoor swimming pool must, when opening, only swing away from the pool area. This is consistent with the requirement in AS 1926.1 for the direction of swing of a gate in swimming pool safety fencing.

Examples

Options for the location of safety fencing include:

- enclose the pool with isolation-safety fencing, separating the pool area from any other part of the allotment and any buildings;
- separate the pool area from other parts of the allotment, any buildings and neighbouring allotments, with barriers complying with the relevant Australian Standards provisions for safety fencing;
- if access is provided from the building to an indoor pool area, protect the access door and window openings to the pool area with child-resistant doorsets and child-resistant openable portions of window; and
- if a window forms part of the safety barrier to a swimming pool, the openable parts of the window must be child-resistant.

The operation of self-closing and latching devices on gates should allow it to close and latch from any position—from resting on the latching mechanism to fully open—in accordance with the conditions in AS 2820 (referenced in AS 1926 Part 1).

Water recirculation systems

The requirements for water recirculation systems in swimming pools make provisions for the safety of users by means of minimising the risk of entrapment or injury of people using the pool and provide for the safe operation of skimmer boxes and outlet systems.

The BCA definition of "swimming pool" is specific, it includes a bathing or wading pool and a spa pool. Therefore, the Deemed-to-Satisfy provision, if chosen as the building solution, applies the requirements of AS 1926.3 to all types of pools defined as "swimming pools" under the BCA, irrespective of the definition of swimming pool stated in the Standard.

G1.2 Refrigerated chambers, strong-rooms and vaults

Intent

To maximise the ability of people working in a strongroom, refrigerated chamber, or the like, to escape the room in an emergency.

Accidental locking in small spaces

G1.2(a) specifies the acceptable safety requirements for a cooling chamber, strongroom or vault which people can enter and work within. The door must be operable from the inside without a key (this requirement overrides any corresponding requirements or concessions in [Section D](#)). Also, there must be dedicated controls within the chamber, room or vault for internal lighting and an external indicator lamp to indicate the space is in use. Activation of the external indicator lamp can only be by operation of the internal light from within the chamber, room or vault.

G1.2(a)(iii) requires a dedicated alarm to alert people outside that a person is trapped inside. The alarm must achieve the specified sound pressure level, and should be located where it will be noticed. The activation of the alarm must be controlled from within the chamber, room or vault, and must not be connected to an external device which can override the internal alarm controls.

G1.2(b) sets out the minimum door opening with specified dimensions for refrigerated or cooling chamber (the clear width criterion means that the measurements must be taken at the narrowest point of the opening, including any protruding door or door hardware).

PART G2

HEATING APPLIANCES, FIREPLACES, CHIMNEYS AND FLUES

Objective

GO2

Combustion appliance—GO2(a)(i)

GO2(a)(i) specifies that people must be protected from injury by fire from a combustion appliance. **GO2(a)(i)** applies only to combustion appliances installed within a building.

Pressure vessel—GO2(a)(ii)

GO2(a)(ii) specifies that people must be protected from injury caused by a malfunction of a pressure vessel. **GO2(a)(ii)** applies only to pressure vessels installed within a building.

The malfunction of a pressure vessel could create steam and/or an explosion.

Protection of building—GO2(b)

GO2(b) requires that a building intended to contain a pressure vessel be designed so that any fault to the pressure vessel will not damage the building. The aim is to make sure that the structural stability of the building is not affected.

Functional Statements

GF2.1

Combustion appliances

GF2.1 requires that a heating system be installed to prevent fire spreading to adjoining building elements.

A key expression in **GF2.1** is “controlled combustion”. This expression means that only heating units which burn solid materials or oil must comply with these provisions. The expression applies to open fireplaces, oil heaters, solid-fuel burning stoves, coal heaters, pot-belly stoves, and other such cooking and heating devices.

The expression does not include electric heaters. Nor is it intended to include gas heaters, covered by other State and Territory legislation.

GF2.2

Pressure vessels

Additional measures must be taken when a pressure vessel is installed in a building, due to the potential damage and injury which may be caused by a malfunction.

Performance Requirements

GP2.1

Combustion appliances

When installed in a building, a combustion appliance (including all associated components) must be:

- designed to be robust enough to operate under all applicable heating conditions. It is particularly important that flue systems comply with this requirement, so they are compatible with the primary heating unit;
- installed so that, when in operation, the radiated heat will not affect adjoining building elements (ie burn timber, warp steel lintels, char plasterboard and so on). This not only applies to the actual heating unit, but also to the attached flues, especially where they pass through other areas of the building (such as roofs, ceiling spaces, walls and the like); and
- designed and installed so that the hot products of combustion are properly discharged in a manner which will not cause damage. To do this, builders must make sure flues are adequately joined to create a continuous discharge route. The discharge point must be such that discharged products will not re-enter the building. They should not ignite adjoining combustible materials where the appliance is installed.

GP2.2

Pressure vessels

Because of the dangers of pressure vessels, care has to be taken during installation. (Pressure vessels located outside a building are not covered by the BCA, but may be controlled by other State and Territory legislation).

Issues such as leakage of pressurised liquids and the consequences of the vessel being damaged must be considered. Damage must be avoided to the vessel. Such damage could occur if the vessel is located in an area subject to traffic.

PART **G2** Heating Appliances, Fireplaces, Chimneys and Flues

Deemed-to-Satisfy Provisions

G2.0 Deemed-to-Satisfy Provisions

Intent

To clarify that requirements of **GP2.1** and **GP2.2** will be satisfied if compliance is achieved with **G2.1–G2.4**.

Where a Building Solution is proposed to comply with the Deemed-to-Satisfy Provisions, **G2.0** clarifies that compliance with **G2.1–G2.4** achieves compliance with **GP2.1** and **GP2.2**.

Where a Building Solution is proposed as an Alternative Solution to the Deemed-to-Satisfy Provisions, the relevant Performance Requirements must be determined in accordance with **A0.10**. (See comment on **A0.10**).

G2.1 * * * * *

In BCA 90 this provision was performance based. In subsequent editions of the BCA, the provision is covered by the Performance Requirements. **G2.1** has been left blank rather than renumber subsequent clauses.

G2.2 Installation of appliances

Intent

To specify the Australian Standards which are suitable to achieve compliance with **GP2.1** and **GP2.2** as regards the installation of domestic solid-fuel burning appliances, pressure equipment and the like.

Solid-fuel burning appliances and pressure equipment

G2.2 lists two Standards as Deemed-to-Satisfy Provisions for the installation of domestic solid-fuel burning appliances (see **G2.2(b)**), and pressure equipment (see **G2.2(c)**).

G2.3 Open fireplaces

Intent

To provide for the safe design and installation of open fireplaces.

The design and installation of open fireplaces

G2.3 relates to open fireplaces where timber or other solid material is burned and there is generally no in-built enclosing structure or apparatus across the front to contain sparks, etc.

The construction of a fireplace must comply with the structural requirements in **Section B** of the BCA. The **G2.3** requirements relate to additional measures for fire safety.

G2.3(a) states that the fireplace must have a hearth made of stone, concrete or other similar non-combustible material. The non-combustible material must be similar in nature to stone and concrete. The concessions for non-combustible material in **Section C** of the BCA, particularly **C1.12** (such as plasterboard and similar lightweight materials), must not be construed as complying with these specific provisions.

With the increased danger due to the open-fire area, **G2.3(a)** contains requirements to ensure the area in front of the opening is protected. The hearth is intended not only to protect adjoining building elements from sparks, but also to reduce the danger of logs rolling out. See **Figure G2.3**.

G2.3(b) deals with the construction of a fireplace (additional to the requirements of **Section B**). These relate to the fire box, and the need to ensure that the walls adjacent to the fire can withstand the heat. Concrete blockwork is not allowed to form the fire box, because it performs poorly under repeated heating and cooling cycles.

G2.3(c) contains the requirements for chimneys.

G2.3(c)(i) aims to make sure the masonry of a chimney is capable of withstanding heat. The construction requirements are less than those for the firebox, because the most intense area of the fire is below the actual level of the chimney.

G2.3(c)(ii) contains a requirement to line the chimney with a rendering mix to make sure it draws properly. A smoother surface:

- allows a freer air-flow up the chimney, and therefore removes smoke more effectively; and
- helps to minimise soot build-up, therefore minimising the risk of chimney fires.

G2.3(d) contains a requirement to ensure that damp-proof courses and flashings are installed. Section 3.3 of Volume Two of the BCA contains some options for compliance.

G2.4 Incinerator rooms

Intent

To provide requirements for the safe installation of an incinerator room in a building.

Incinerators, hoppers and incinerator rooms

G2.4(a) contains requirements for incinerators and their hoppers. “Hopper” refers to the area used to feed the incinerator. The requirements for hoppers aim to make sure they do not increase the risk of fire to the adjoining building area.

G2.4(a)(v) states that a hopper must not be located in a required exit. This is to prevent any potential problem where a failure in the hopper could affect the egress route.

G2.4(b) requires an incinerator to be fire separated from the remainder of the building.

**Figure G2.3
FIRE PLACE CLEARANCE FROM COMBUSTIBLE MATERIALS**

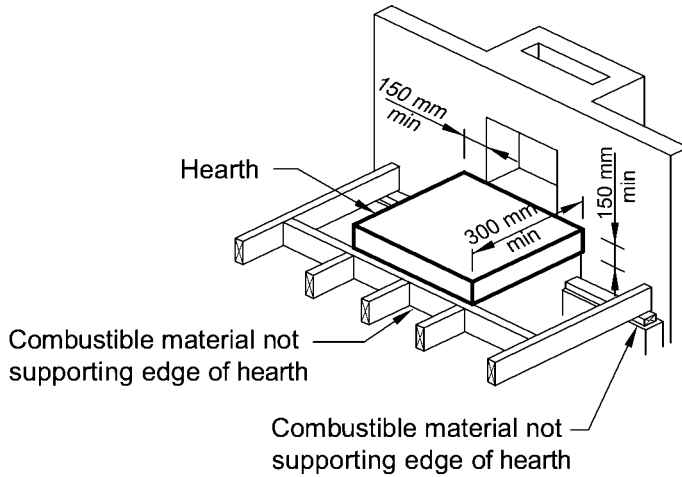

(a) Hearth construction

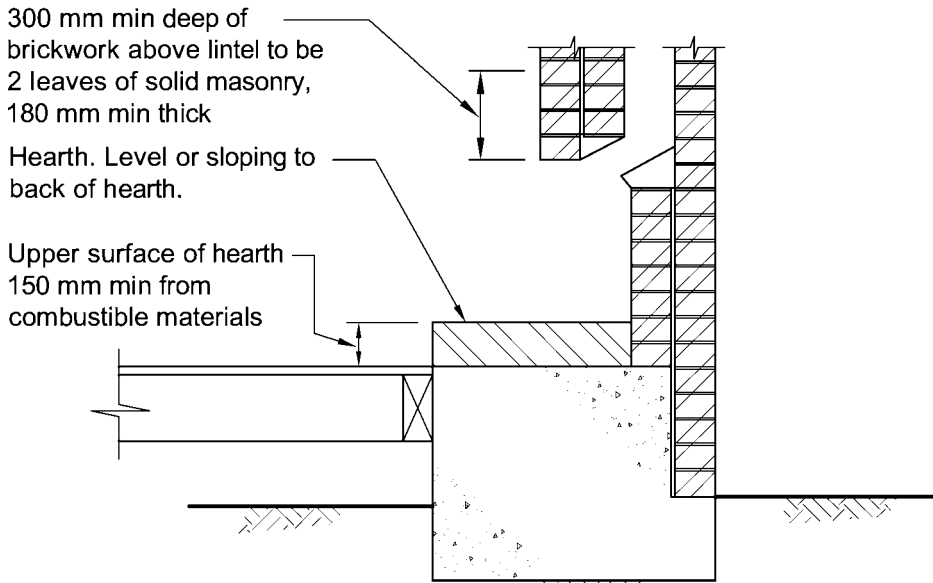

(b) Fireplace construction

PART G3 ATRIUM CONSTRUCTION

Objective

Functional Statements

Performance Requirements

The Objective, Functional Statements and Performance Requirements for Part **G3** are contained in **Sections C, D** and **E**. **Part G3** contains additional Deemed-to-Satisfy Provisions for buildings that contain an atrium.

PART G3 Atrium Construction

Deemed-to-Satisfy Provisions

The Objective, Functional Statements and Performance Requirements for **Part G3** are contained in **Sections C, D** and **E**. **Part G3** contains additional Deemed-to-Satisfy Provisions for buildings that contain an atrium.

G3.1 Atriums affected by this Part

Intent

To clarify which atriums must comply with **Part G3**.

The BCA defines the term “atrium”. It is important to understand this BCA definition before considering **Part G3**. See definition in **A1.1**.

Part G3 does not apply to an atrium if it connects two storeys in a non-sprinkler protected building, or up to three storeys if each of the connected storeys is sprinkler protected and one of those storeys is at a level giving egress to a road or open space.

This provision is consistent with **D1.12**, which deals with the number of floors that can be connected by a non-required non-fire-isolated stairway, ramp or escalator.

G3.2 Dimensions of atrium well

Intent

To minimise the risk that radiant heat from a fire will affect people or materials on the other side of an atrium well.

The BCA defines the terms “atrium” and “atrium well”. It is important to understand these BCA definitions, before considering **Part G3**. See definitions in **A1.1**.

An atrium well is not limited to having a maximum size, nor is there a limitation on its shape, except that it must contain a space throughout which could contain a cylinder with a diameter of 6 metres. This 6 metres is equal to the minimum distance between unprotected openings in external walls of adjoining buildings required by **C3.2**. This diameter void is intended to reduce the effects of radiant heat from a fire:

- affecting occupants evacuating on the other side of the atrium well; and
- igniting materials on the other side of the atrium well.

Figure G3.2 illustrates the method of measuring the atrium well to comply with **G3.2** and the location of an atrium’s bounding walls.

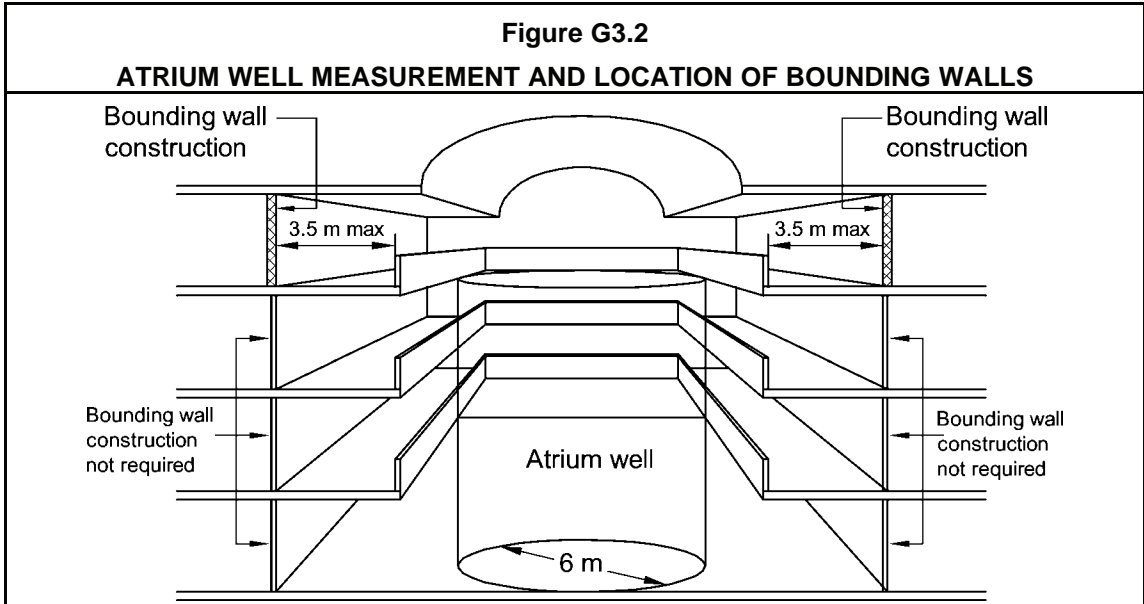

G3.3 Separation of atrium by bounding walls

Intent

To minimise the risk of spread of fire and smoke from or to the atrium or other parts of the building.

G3.3 requires the use of bounding walls, which limit the risk of fire and smoke spreading from the atrium to other parts of the building and other parts of the building to the atrium.

The detailed requirements for bounding walls are explained in the Comments on [Clause 2.4 of Specification G3.8](#).

The bounding wall and 3.5 metre setback requirements do not apply where there are three or less consecutive storeys and:

- one of these storeys is located at the level from which direct egress is provided to a road or open space; and
- the total floor area of these storeys is limited to that specified in [Table C2.2](#) (the floor area referred to in [G3.3\(b\)](#) is that of the three storeys, and not the total floor of the atrium).

[Figure G3.3](#) illustrates the floors included in the area permitted by [Table C2.2](#).

[Figure G3.2](#) illustrates the location of an atrium's bounding walls.

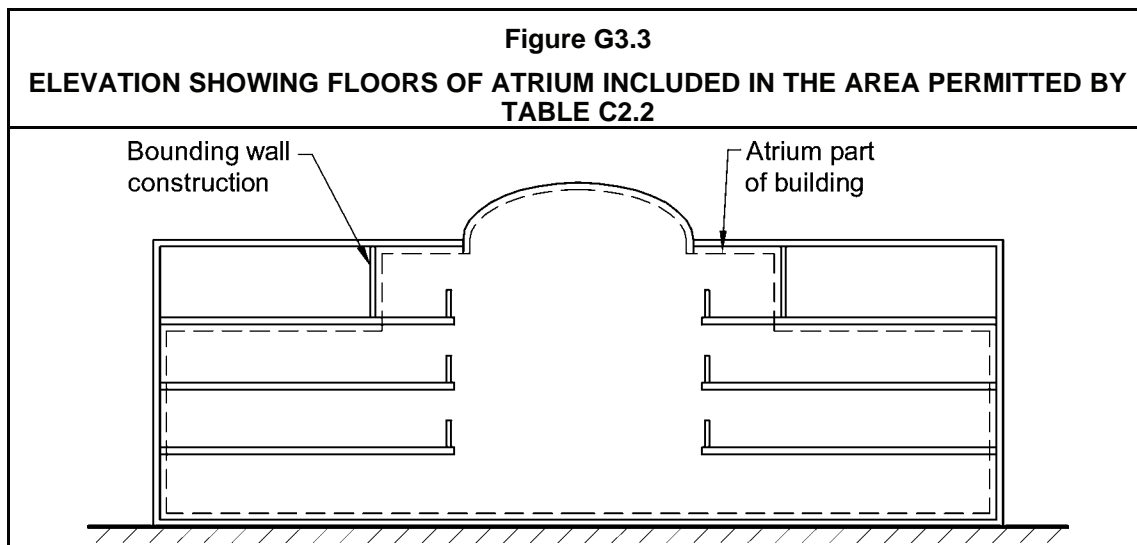

G3.4 Construction of bounding walls

Intent

To limit the spread of fire between different parts of a building by way of an atrium.

G3.4 establishes the required FRL and acceptable construction requirements for the bounding walls required by **G3.3**. See **Figure G3.4**.

The walls bounding an atrium are not fire walls as defined in the BCA. Therefore, these walls do not create separate fire compartments within a storey of the building. The bounding walls define the extent of the part of the building regarded by the BCA to be an “atrium”. See **Figure G3.2**.

G3.4 prescribes two options for construction of bounding walls:

- applies where the bounding walls are constructed of materials with a FRL of 60/60/60; or
- applies where the bounding walls are constructed of fixed toughened or wired safety glass in non-combustible frames.

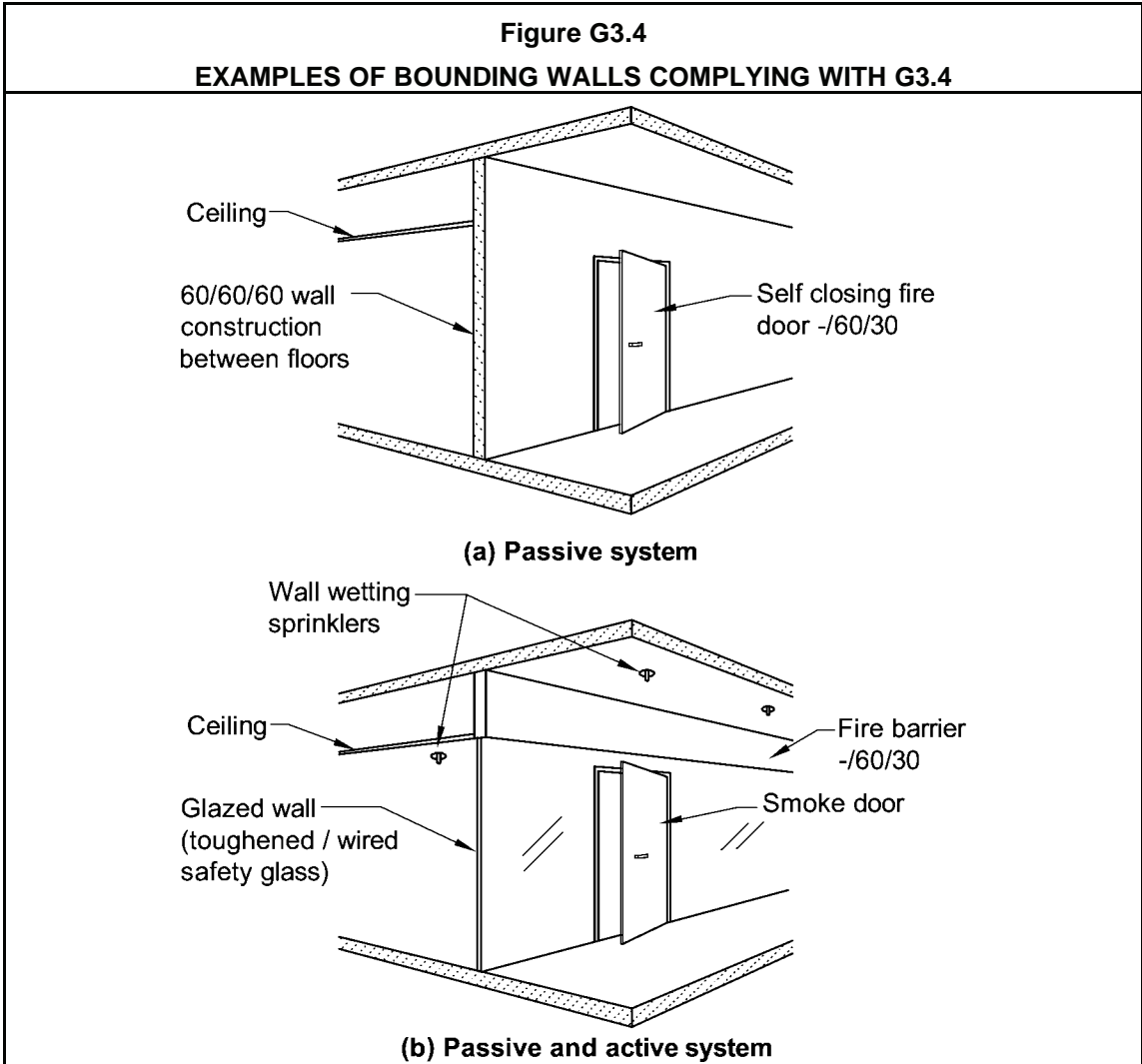

G3.5 Construction at balconies

Intent

To maximise the safety of people who have access around an atrium.

To maximise public safety, a balustrade or barrier is required at the edge of a balcony to an atrium. The balustrade or barrier must:

- have no openings and be non-combustible, to act as a shield from heat during a fire; and
- have a height of 1 metre—which is consistent with **D2.16**.

G3.5 takes precedence over the provisions of **D2.16** for balustrades and other barriers around an atrium.

G3.6 Separation at roof

Intent

To minimise the risk that the roof of an atrium will not remain in place during a fire.

Clause 3 of **Specification G3.8** requires smoke extraction through the roof, or near the top of an atrium—this smoke extraction is required to be by mechanical exhaust or by smoke and heat vents.

It is therefore important that the roof remains in place during a fire and not allow the re-circulation of smoke. To achieve this, **G3.6** requires:

- the roof to have the FRL required by **Table 3** of **Specification C1.1**; or
- the roof structure and membrane to be protected by a sprinkler system.

The materials used in the roof must comply with:

- the fire hazard properties specified in **Specification C1.10**; and
- when the roof is required to have an FRL, **G3.6(a)** does not allow the use of the concessions contained in **Clauses 3.4, 3.5 or 3.6** of **Specification C1.1** for the roof of the atrium.

G3.7 Means of egress

Intent

To require that safe egress is available from an atrium.

Although the building may have an effective height of less than 25 metres, two exits are required from any area within an atrium. This is due to the additional fire hazard associated with atriums.

There may be other parts of the BCA which permit buildings to have only a single exit. **G3.7** overrides any such provisions insofar as they relate to atriums.

All other aspects of the means of access and egress from an atrium must comply with **Section D**.

G3.8 Fire and smoke control systems

Intent

To specify the additional fire and smoke control systems required for an atrium.

Because of the additional fire hazard associated with an atrium, special fire and smoke control measures are required to reduce the likelihood of conditions being reached which could endanger the safety of occupants before they have time to evacuate. These measures are set out in **Specification G3.8**.

SPECIFICATION **G3.8** FIRE AND SMOKE CONTROL SYSTEMS IN BUILDINGS CONTAINING ATRIUMS

Deemed-to-Satisfy Provisions

Specification G3.8 only applies to the Deemed-to-Satisfy Provisions.

1 Scope

Intent

To clarify that **Specification G3.8** includes the requirements for fire and smoke control systems in buildings with an atrium.

Specification G3.8 includes the requirements for fire and smoke control systems in buildings containing an atrium.

Where a sprinkler system is required, it must be installed in the whole building, not just that part in which the atrium is located.

2 Automatic fire sprinkler system

General requirement

Intent

To set out the general requirements for the installation of a suitable sprinkler system in a building containing an atrium.

Generally, a sprinkler system must comply with **Specification E1.5**. The remainder of **Clause 2** of **Specification G3.8** sets out additional requirements for sprinklers in a building containing an atrium.

If any conflict exists between **Specification E1.5** and **Clause 2**, then **Clause 2** takes precedence.

Roof protection

Intent

To set out the roof protection requirements for a building containing an atrium.

Clause 3 requires smoke extraction through the roof, or near the top of the atrium. It is therefore important that the roof remains in place during a fire and does not allow the re-circulation of smoke. To achieve this, **G3.6** requires the roof:

- to have the FRL required by **Table 3** of **Specification C1.1**; or

SUPERSEDED
ANCILLARY PROVISIONS

- structure and membrane to be protected by a sprinkler system.

Figure Spec G3.8 illustrates the alternative protection of an atrium roof.

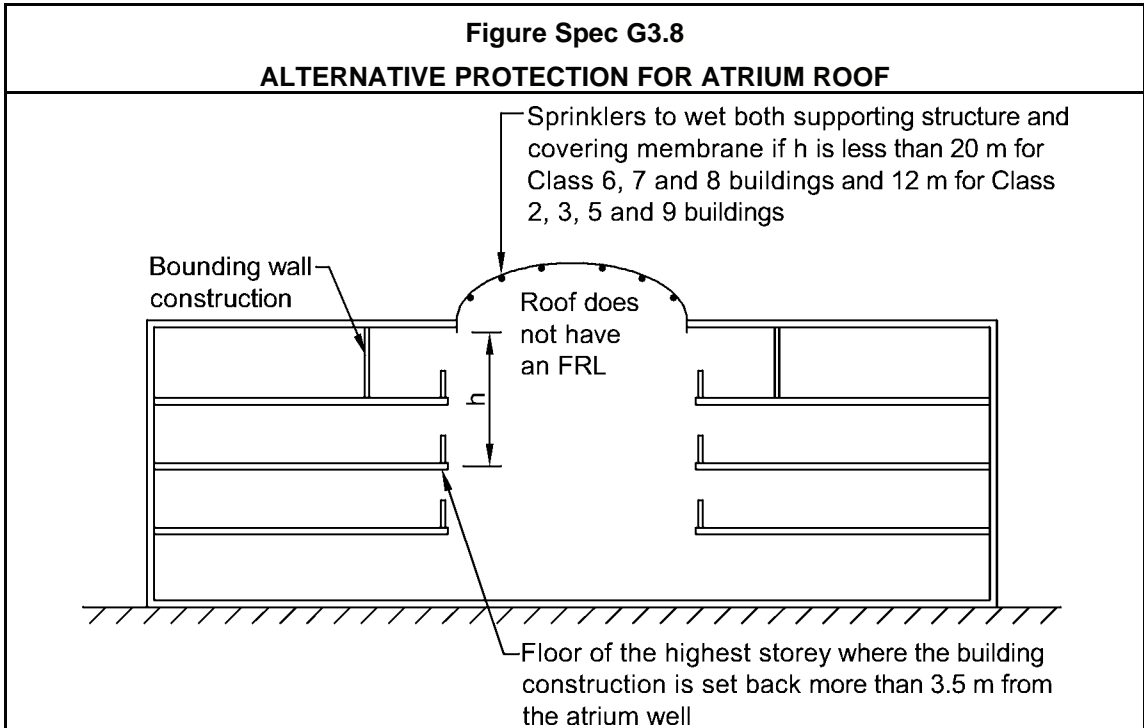

When the roof is required to have an FRL, **G3.6(a)** does not allow the use of the concessions contained in **Clauses 3.4, 3.5 or 3.6** of **Specification C1.1** for the roof of the atrium.

The sprinkler protection requirement only applies to a roof located in an area where a fire could affect its integrity. The distances stated in **Clauses 2.2(a) and (b)** differ because of the different fire loads assumed in the different Classes of building. The heights of the atrium roof have been selected as those beyond which a smoke plume produced by a typical fire would no longer be hot enough to damage an unprotected roof.

The sprinkler heads need only be arranged to give a wetting effect to both the underside of the roof membrane and any part of the supporting structure.

The higher temperature rating of the sprinkler heads is to make sure they do not falsely discharge due to the potentially higher normal temperatures under an atrium roof, especially if a glass or translucent roof is used (as is common practice).

Clause 3 requires smoke extraction through the roof, or near the top of an atrium. The smoke extraction is required to be by mechanical exhaust or by smoke and heat vents.

Atrium floor protection

Intent

To set out fire protection requirements for atrium floors (ie at the lowest level of the atrium).

Because of the height of the roof in an atrium, the sprinklers protecting it are unlikely to be effective at the lowest level of the atrium. Additional sprinklers are therefore normally required to protect that level, as this area is normally a large open space, and is potentially the primary

source of a major fire. Adequate protection of the floor often requires the use of sidewall sprinkler heads, as required by **Clause 2.3(a)**. **Clause 2.3(a)** requires a “performance-type” decision as to the types of sprinklers (sidewall and overhead) and their combination.

Because of the additional fire hazard associated with atriums, **Clause 2.3(b)** requires the use of fast response sprinkler heads. So that the heat does not pass the head without setting it off, larger than normal heat collector plates are required.

Although a “fast response” sprinkler head can activate at the same temperature as a “normal” sprinkler head, its reaction time is much shorter and it has different discharge characteristics. Therefore, **Clause 5** of **Specification E1.5** requires that the sprinkler system be designed specifically for the use of these heads.

Sprinkler systems to glazed walls

Intent

To set out fire protection requirements for glazed walls to an atrium.

Clause 2.4.1 sets out the requirements for sprinkler protection of glazed bounding walls. These requirements are illustrated in **Figure G3.4**.

Under **Clause 2.4.2**, the location of the sprinkler heads must allow full wetting of the glazing without wetting an adjacent head. Consequently, water should run down the window, cooling the glass and therefore creating a resistance to the spread of fire or smoke through the glazed wall by reducing its potential to failure during a fire. It is also important that the adjacent sprinkler head not be wetted, because the cooling effect of the water may delay its activation.

Because of the additional fire hazard associated with atriums, **Clause 2.4.3** requires the use of “fast response” sprinkler heads. So that the heat does not pass the head without setting it off, **Clause 2.4.1** requires the installation of heat collector plates (which increase the sensitivity of the system).

Although a “fast response” sprinkler head can activate at the same temperature as a “normal” sprinkler head, its reaction time is much shorter and it has different discharge characteristics.

Clause 2.4.4 sets out the minimum requirements for water discharge rates. **Clause 5** of **Specification E1.5** therefore requires that the sprinkler system be designed specifically for the use of these heads.

Clause 2.4.4 sets out the required water discharge rates on any glazing in a bounding wall. Because the atrium can have a high fire load and large volume, the higher flow rate of 0.25 L/s.m² is required on the atrium side of the glazing when the wall is not set back from the atrium well.

The importance of the wall sprinklers to glazed walls in a fire is such that **Clause 2.4.5** sets out the minimum potential coverage to be provided by such sprinklers, which in turn determines the characteristics of the water supply in terms of pressure and quantity.

The water supply for the wall wetting system referred to in **Clause 2.4.5** is additional to the water supply for the other sprinklers in the building.

It is assumed that the size of a fire will be controlled by the sprinkler system installed in the building. The greater height required to be covered by a wall wetting sprinkler system in a Class 6, Class 7 or Class 8 part of a building (see **Clause 2.4.5(a)(ii)**) reflects the greater fire load contained in such buildings.

Stop valves

Intent

To set out requirements for sprinkler and wall wetting system stop valves.

When referring to sprinkler and wall wetting stop valves, **Clause 2.5** requires that:

- they be monitored to detect and warn of any unauthorised closure; and
- the sprinkler and wall wetting systems have independent valves.

3 Smoke control system

General requirements

Intent

To set out the general requirements for the installation of a suitable smoke control system in a building containing an atrium.

As generally required by the BCA, mechanical air-handling systems must comply with AS/NZS 1668.1. However, if any conflict exists between AS/NZS 1668.1 and **Specification G3.8**, the Specification takes precedence.

Operation of atrium mechanical air-handling systems

Intent

To set out mechanical air-handling system requirements for an atrium.

The basic operation of the mechanical air-handling system during a fire is to limit the spread of smoke. To achieve this it must:

- maintain a tenable atmosphere along balconies to allow the occupants to evacuate; and
- avoid smoke being drawn into the atrium when a fire occurs in another part of the building, which requires that—
 - the atrium smoke exhaust fans activate only when smoke enters the atrium;
 - the atrium cannot be used as a return air path; and
 - the normal relief or exhaust fans in the atrium must stop normal operation. If necessary, these fans may be designed for exhausting smoke from the atrium.

The intent of the details contained in **Clause 3.2(d)** and **(f)** is to create a negative air pressure on the fire floor or in the fire affected compartment, so that air and any entrained smoke is drawn to it. This creates positive pressure on non-fire floors, so as to prevent the migration of smoke to non-fire floors while exhausting smoke from a fire affected floor.

Activation of smoke control system

Intent

To set out how a smoke control system serving an atrium is to be activated.

The smoke control system may be activated by any of the methods listed in **Clause 3.3(a)**.

The location of the controls for the system may be any of those listed in [Clause 3.3\(b\)](#). Note that the locations are in areas normally accessed and used by the fire brigade during a fire.

Smoke exhaust system

Intent

To set out the design characteristics of a smoke exhaust system serving an atrium.

[Clause 3.4](#) specifies the characteristics on which a smoke exhaust system design must be based, which are:

- the size to which the sprinkler system will limit a fire, in terms of its heat output and perimeter;
- the extent of any smoke plume; and
- the system's discharge rate, as calculated under [Figure 3.4](#) of the BCA.

[Figure 3.4](#) of the BCA must be used to determine the minimum smoke extraction rate from the atrium. The required rate depends on the fire load specified in [Clause 3.4\(a\)](#) and the height of the smoke plume above the floor of the atrium well specified in [Clause 3.4\(b\)](#).

The exhaust rates are based on the need to maintain the smoke plume safely above any egress path.

Upward air velocity

Intent

To enable the movement of smoke to the roof, for venting externally.

If the smoke is allowed to travel up the atrium due to its own buoyancy, in higher atriums it will reach a stage where it will not travel any higher. The reasons for this include:

- the smoke will not have enough buoyancy to reach the top of the atrium; and
- the smoke will entrain air, and cool as it rises.

Accordingly, to make sure the smoke continues to travel up the atrium well, minimum (see [Clause 3.5\(a\)](#)) and maximum (see [Clause 3.5\(b\)](#)) air velocities are specified. The maximum velocity specified in [Clause 3.5\(b\)](#) only applies to an atrium well with a constant plan cross section.

Exhaust fans

Intent

To set out the operational requirements for exhaust fans.

To make sure that exhaust fans operate effectively during a fire, they must be designed to operate for at least 1 hour at a temperature of 200°C (see [Clause 3.6\(a\)](#)).

Under [Clause 3.6\(b\)](#) and [\(c\)](#), to make sure that at least one fan continues to operate during a fire:

- at least three fans are required in atriums adjoined by Class 2, Class 3 or Class 9 parts, because of the heightened risk levels in such areas. This is due to such factors as the

possibility that people will be sleeping and, in Class 9a buildings, the presence of non-ambulatory occupants; and

- at least two exhaust fans are required in all other atriums.

Smoke and heat vents

Intent

To set out requirements for smoke and heat vents, which are permitted in low-rise atriums.

Smoke and heat vents are permitted in low-rise atriums (ie atriums less than 12 metres high), instead of a mechanical smoke extraction system.

The reason for the **Clause 3.7(a)** limit is that 12 metres is considered to be a height to which smoke will travel due to its own buoyancy and still be effectively vented.

Clause 3.7 does not apply where a Class 6 part of a building adjoins the atrium.

Clause 3.7(b) requires that vents be fitted with a manual override switch, for use as necessary by emergency services personnel.

Make-up air supply

Intent

To set out requirements for air flow into an atrium from which smoke-laden air is being extracted.

Clauses 3.1 to **3.7** require that smoke-laden air be exhausted from an atrium. **Clause 3.8** sets out how this exhausted air is to be made-up (ie replaced) in the atrium.

Clause 3.8(a) is a performance criterion that requires make-up air to be provided from outside the atrium at a level at or near the lowest storey of the atrium and non-fire storeys.

To make sure that the area where the bounding walls are set back from the atrium well is kept smoke free, an air velocity of 0.1 m/s is required by **Clause 3.8(b)**. This velocity is consistent with that required through an open door by a fire-isolated stairway pressurisation system which accords with AS/NZS 1668.1.

Clause 3.8(c) provides a means of achieving **Clause 3.8(a)**. It is important that the make-up air assists (and does not disturb) the exhausting of the smoke layer. To achieve this, the make-up air should enter the atrium at as low a level as possible, preferably at the base of the atrium. The make-up air must be provided from:

- openings designed to open to outside air on detection of a fire in the atrium;
- a system of ducts to supply outside air to the atrium; or
- a combination of the above.

If a system of ducts is used to supply the make-up air, to make sure the system operates when needed during a fire, the ducts must have an FRL of 60/60/60 if they pass through a different fire compartment to the atrium.

4 Fire detection and alarm system

Intent

To set out the general requirements for the installation of a suitable fire detection and alarm system in a building containing an atrium.

General

A building's fire detection and alarm system must, in general, comply with AS 1670.1. However, if any conflict exists between AS 1670.1 and **Specification G3.8**, the Specification takes precedence.

Smoke detection system

Intent

To set out requirements for smoke detectors in an atrium.

Clause 4.2 sets out, in detail, the requirements for smoke detectors within an atrium. The aim of these requirements is to make sure that the smoke detection system operates effectively and false alarms are minimised.

Smoke detection in spaces separated from the atrium by bounding walls

Intent

To set out requirements for smoke detectors at return and relief air openings.

Clause 4.3 sets out the requirements for smoke detectors at return and relief air openings.

Alarm systems

Intent

To set out requirements for alarm systems in a building containing an atrium.

Alarm systems required in a building containing an atrium, must include a break glass alarm at each door to a fire-isolated exit. The aim of this provision is that a person is able to break the glass setting off the alarm as they evacuate the building.

Where a sampling type smoke detection system is provided, a staged alarm must be given. The stages are set out in **Clause 4.4(b)(i) to (iii)**. The reason for the staged alarms is to minimise the occurrence of false alarms.

Under **Clause 4.4(c)**, beam and point type smoke detectors (as with a sampling type smoke detection system) must also operate as set out in **Clause 4.4(b)(i) to (iii)**, but at the levels set in AS/NZS 1668.1. This provision only applies to beam and point type smoke detectors required by the BCA.

5 Sound systems and intercom systems for emergency purposes

Intent

To require that a suitable emergency warning and intercommunication system is installed in a building containing an atrium.

Clause 5 requires the installation of a sound system and intercom system for emergency purposes in any building containing an atrium. The system must comply with:

- AS 2220.1 and AS 2220.2; and
- the additional requirements set out in **Clause 5(b)**.

The system is a combination of a sound system and an emergency intercom. The main function of an integrated system is:

- to generate an alert and evacuation signal;
- to facilitate communication with evacuation zones; and
- to provide communication between the building management or emergency services personnel and strategic points within the building.

The operation of the system may be by a number of measures referred to in **Specification G3.8**, including the break glass alarm required by **Clause 4.4(a)**.

6 Stand-by power system

Intent

To require the installation of a suitable standby power system in a building containing an atrium.

Clause 6 only applies where a required path of travel to an exit passes through an atrium (see **Clause 6(a)**).

Under **Clause 6(a)**, because of the need to continue the operation of emergency services, a standby power supply is required. This is particularly important because of the increased fire hazard associated with atriums, and the dangers for occupants if they have to evacuate through atriums.

To make sure it operates when needed during a fire, the standby power supply must:

- automatically come into operation when the normal power supply fails;
- if located within the building, be protected by fire-resisting construction;
- be connected to the safety systems by means of cabling suitable to resist fire; and
- come from two supply sources.

Clause 6 is consistent with the protection required for electricity supply systems in **C2.13**.

Clause 6(c) sets out means of achieving **Clause 6(a)**. To make sure that the necessary power to operate the emergency equipment is available during a fire, it requires the standby power to be from one of the listed alternatives.

7 System for excluding smoke from fire-isolated exits

Intent

To minimise the risk of smoke entering a fire-isolated exit in a building containing an atrium.

Reference to [E2.2](#), and in particular [Table E2.2\(a\)](#), means that all fire-isolated exits serving an atrium must be provided with a pressurisation system in accordance with AS/NZS 1668.1. The reason for this is the additional fire hazard associated with atriums and for occupants evacuating them.

PART G4 CONSTRUCTION IN ALPINE AREAS

Introduction

Special provisions for alpine area construction—reasons

Sub-zero temperatures

Due to the extreme cold, the use of open-fire places and other heating devices is common. This increases the potential for accidents and the possibility of fire.

Accident potential from combustion heaters

Buildings constructed in alpine areas need special consideration because of sub-zero temperatures. The temperatures can create elements which restrict free movement to and from the building. They can also complicate the role of fire brigades and other emergency services.

Alpine areas

Part G4 only applies in “alpine areas”. In NSW, ACT, or Victoria, this means areas more than 1200 metres above Australian Height Datum (AHD). In Tasmania, it is more than 900 metres above the AHD. See **Figure G4.1**.

Objective

GO4

Protection while evacuating

GO4 specifies that occupants of buildings in alpine areas must be protected while evacuating in an emergency. The protection measures are only required to assist while the building is being evacuated. The additional measures included in **Part G4** are necessary because of the conditions which can exist in alpine areas.

Precedence over other BCA provisions

GO4's Application provision clarifies that if there is any contradiction between the requirements in this Part and the rest of the BCA, then the provisions of **Part G4** will take precedence.

Functional Statement

GF4.1

Additional safety measures necessary

GF4.1 adds an additional dimension to **GO4** by indicating that additional measures are necessary because of the difficulties faced by fire brigades in gaining quick access to buildings during an emergency, and maintaining building access and egress during snow conditions.

Precedence over other BCA provisions

The application provision included as part of **GF4.1** clarifies that if there is any uncertainty between the requirements in this Part and the rest of the BCA, then the provisions of **Part G4** will take precedence.

Performance Requirements

GP4.1

External doors must continue to operate

GP4.1 requires external doors to continue to operate effectively in snow conditions so people can leave in an emergency by the normal egress route (ie the doorway).

Such a doorway must not be made inoperable by deposits of snow and ice. Care needs to be taken to avoid locating doorways where:

- snow falling from adjoining roof areas could affect egress paths; and
- re-entrant corners of a building increase the potential for snow to be trapped.

Precedence over other BCA provisions

GP4.1's Application provision clarifies that if there is any uncertainty between the requirements of **GP4.1** and the rest of the BCA, then **GP4.1** will take precedence.

GP4.2

External trafficable structures must be usable

Any external structures used as part of an egress route must remain accessible in snow conditions. An external balcony not designed for egress from the building would not need to comply.

To comply with this provision it is necessary to make sure that snow build up is avoided and that the surfaces reduce the potential for people slipping.

Precedence over other BCA provisions

GP4.2's Application provision clarifies that if there is any uncertainty between the requirements of **GP4.2** and the rest of the BCA, then **GP4.2** will take precedence.

GP4.3

Adjacent areas—snow or falling ice

Areas adjacent to the building should not be subjected to heavy deposits of built-up snow or falling ice which could harm:

- people evacuating (ie roofs must be designed to avoid depositing snow on egress routes from the building); and
- people using the area adjacent to the building (ie snow from the roof area should not cascade on to public thoroughfares and roads or on to adjoining property in a dangerous manner).

Precedence over other BCA provisions

GP4.3's Application provision clarifies that if there is any uncertainty between the requirements of GP4.3 and the rest of the BCA, then GP4.3 will take precedence.

GP4.4

Installation of fire safety equipment

GP4.4(a) requires that a building have equipment to facilitate firefighting operations. With the increased risk of fire development and access problems for fire brigades in alpine areas, it is important that suppression equipment be available to combat a fire in its early stages of development, to possibly prevent the fire reaching an uncontrollable stage.

It is not intended that occupants fight a fire if there is any danger to them. It is essential that occupants be able to evacuate safely before untenable conditions are reached.

Care will need to be taken in design and construction to ensure that water in fire-suppression equipment will not freeze, making the equipment useless.

GP4.4(b) requires the installation of a system to alert occupants of an emergency. Where an external alarm is installed, care must be taken that the sub-zero temperatures do not freeze its mechanism.

Precedence over other BCA provisions

GP4.4's Application provision clarifies that if there is any uncertainty between the requirements of GP4.4 and the rest of the BCA, then GP4.4 will take precedence.

PART G4 Construction in Alpine Areas

Deemed-to-Satisfy Provisions

G4.0 Deemed-to-Satisfy Provisions

Intent

The requirements of **GP4.1–GP4.4** will be satisfied if compliance is achieved with **G4.1–G4.9**.

G4.1 Application of Part

Intent

To clarify that Part G4 applies only to buildings in alpine areas, and its provisions override any others in the BCA which are in conflict.

Buildings in alpine areas only—G4.1(a)

G4.1(a) indicates that the requirements of **Part G4** only apply to buildings constructed in an alpine area. See **Figure G4.1**.

Precedence over other provisions—G4.1(b)

G4.1(b) indicates that the provisions of **Part G4** take precedence over any other provisions in the BCA, but only if they are in conflict.

G4.2 * * * * *

This provision was blank in BCA 1990. **G4.2** has been left blank rather than renumber subsequent clauses.

**SUPERSEDED
ANCILLARY PROVISIONS**

Figure G4.1

MAP SHOWING ALPINE AREAS IN AUSTRALIA

(a) Alpine and sub-alpine regions where snow loads are significant

- | | |
|---------------------------|--------------------|
| <i>Alpine</i> | <i>Sub-alpine</i> |
| NSW | NSW |
| 1. Kiandra | 14. Berridale |
| 2. Mt Kosciusko | 15. Blackheath |
| 3. Perisher Valley | 16. Blayney |
| 4. Thredbo | 17. Bombala |
| | 18. Cooma |
| VICTORIA | 19. Crookwell |
| 5. Falls Creek | 20. Guyra |
| 6. Mt Baw Baw | 21. Jindabyne |
| 7. Mt Buffalo | 22. Katoomba |
| 8. Mt Buller | 23. Lithgow |
| 9. Mt Hotham | 24. Orange |
| TASMANIA | TASMANIA |
| 10. Ben Lommond Ski Field | 25. Bothwell |
| 11. Cradle Valley | 26. Derwent Bridge |
| 12. Great Lake Area | 27. Strathgordon |
| 13. Mt Field Ski Field | |

(b) Sub-alpine regions where snow loads are not significant

- | | |
|--------------|---------------|
| NSW and ACT | VICTORIA |
| 28. Armidale | 31. Bright |
| 29. Canberra | 32. Mansfield |
| 30. Goulburn | 33. Mt Beauty |
| | 34. Omeo |

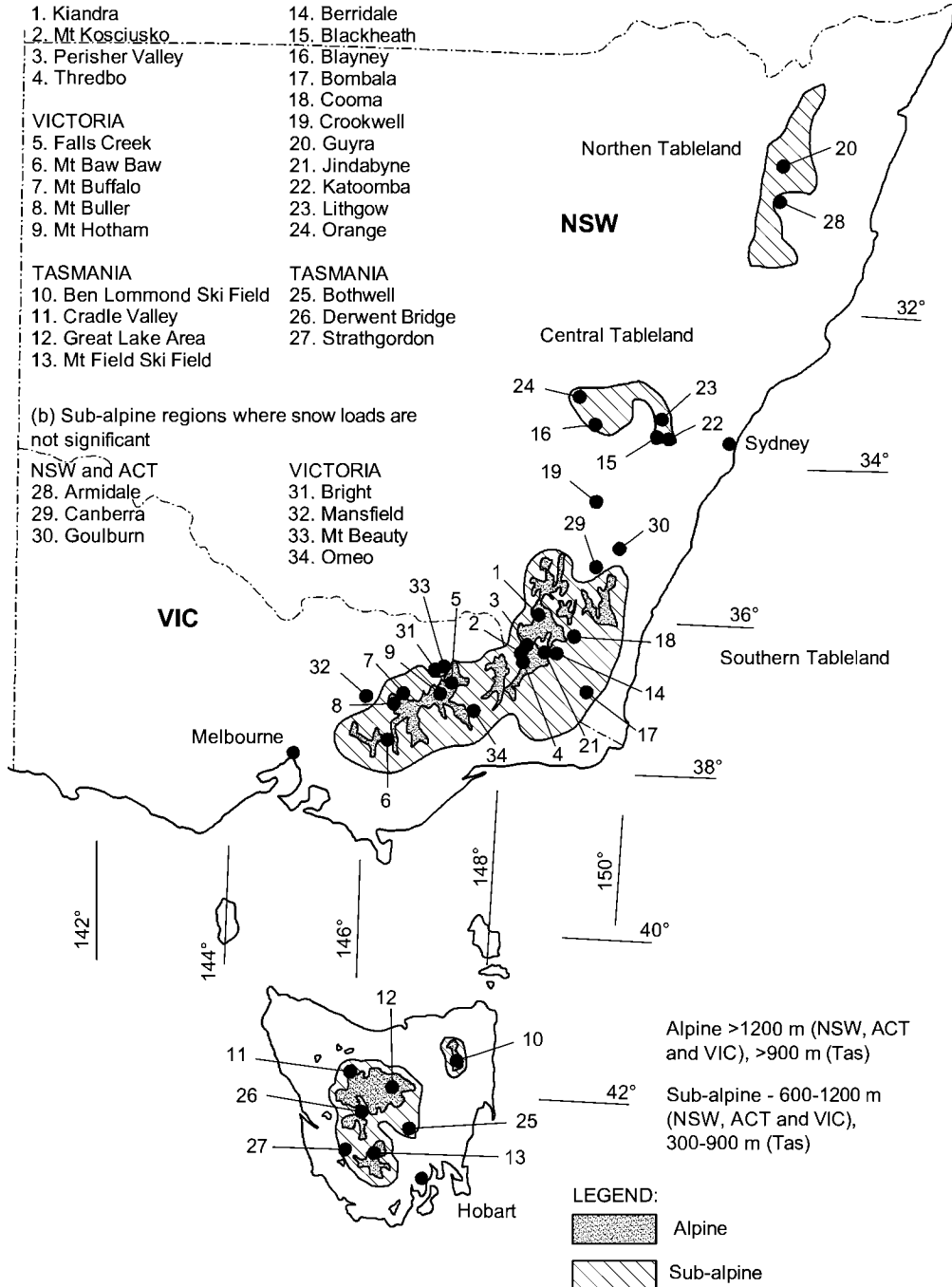

Alpine >1200 m (NSW, ACT and VIC), >900 m (Tas)

Sub-alpine - 600-1200 m (NSW, ACT and VIC), 300-900 m (Tas)

LEGEND:

- Alpine
- Sub-alpine

G4.3 External doorways

Intent

To enable people to evacuate a building in an alpine area in an emergency without being impeded by snow and ice.

Inwards opening external doorways

Doors in non-alpine areas

In most buildings, exit doors must open outwards to assist with evacuation. The outward opening door swings in the direction of people leaving the building. A door opening towards people leaving is considered to be potentially more dangerous because a “crush” may occur, where people pushing against the door prevents it from being opened.

Doors in alpine areas—G4.3(a)(i) and (ii)

In alpine conditions, the swing of outward opening doors may be impeded by snow and ice outside. Therefore, the door is allowed to open inwards provided adequate precautions are taken to enable the door to open towards the flow of people.

As external doors in most buildings open outwards, most people will not necessarily be expecting a door to open inwards. Accordingly, a readily-visible and understood sign must alert people to this feature.

Doorways protected by alcoves or similar

Doorways protected from snow build-up by alcoves, etc are effectively exempt from **G4.3**, so long as they are clearly not subject to the build up of snow.

Alcoves—G4.3(a)(iii)

Where a doorway serves a corridor or stairway, an alcove or recess must be provided to protect against snow build-up. If a design indicates that such an alcove or recess will prevent snow build up, a builder, etc may be able to adopt the approach referenced above, and avoid the necessity for the door to open inwards. See **Figure G4.3**.

G4.3(a)(iii) does not apply where an external doorway opens directly from a room to the outside of the building.

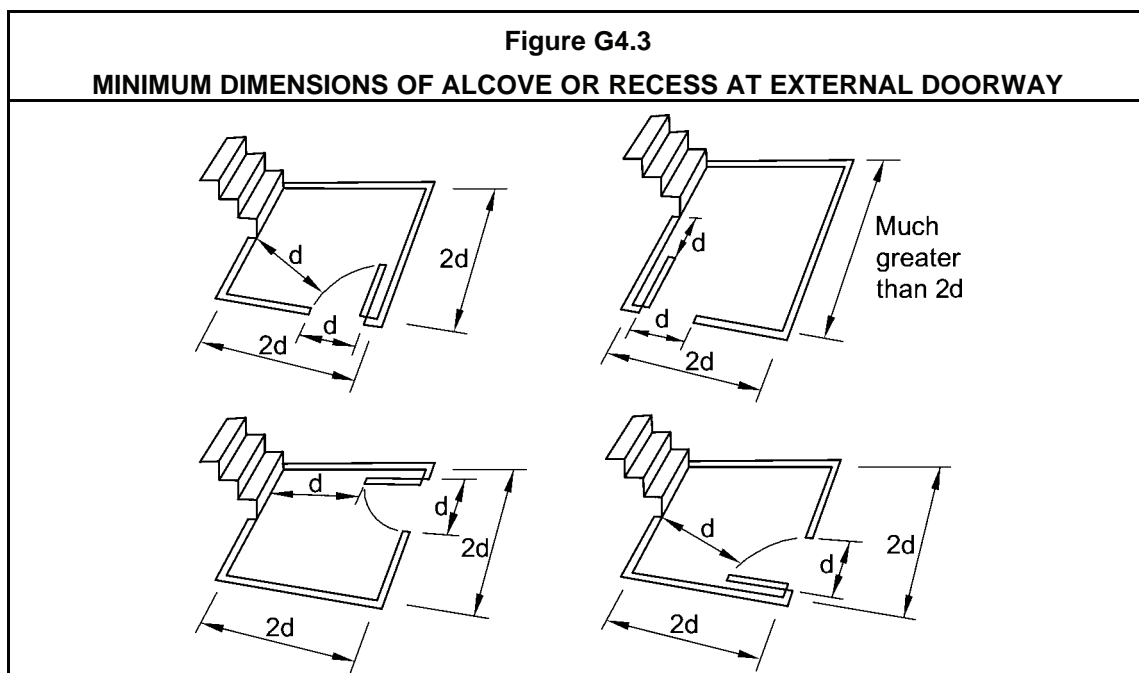

Thresholds to required exit doorways—G4.3(b)

Every threshold to a required exit doorway must be located so that snow, etc will not prevent the door from opening. Accordingly, the threshold may need to be:

- elevated to a point where it is above anticipated snow levels in that area of the building; or
- protected by an awning or similar enclosure which prevents snow from obstructing the doorway.

Attention should be given to the geometry of the building where the threshold is located. The doorway should not be in a place where the roof will deposit large amounts of snow, or at re-entrant corners where snow drifts may form.

This provision only relates to thresholds serving required exits.

G4.4 Emergency lighting

Intent

To enable people to evacuate a building in an alpine area in an emergency without being impeded by lack of light.

Emergency lighting in buildings in alpine areas

G4.4 requires emergency lighting in all Class 2–9 buildings in alpine areas. Expected delays in emergency personnel arriving on the scene, means emergency lighting is necessary to assist people evacuating.

Emergency lighting provides illumination for exit paths, etc during a power failure (which is a likely scenario in a fire). The lighting must be effective and installed to cover exit paths as nominated.

G4.4 and Part E4

The technical aspects of the installation of emergency lighting must be in accordance with **Part E4**. However, the location of emergency lights must comply with **G4.4**, irrespective of any location parameters specified in **Part E4**.

Lighting in stairways—G4.4(a)

G4.4(a) requires lighting to be provided to every stairway within a building, except within a sole-occupancy unit of a Class 2 or 3 building and the Class 4 part of a building. This is to make sure that common exit routes are still negotiable in an emergency.

Lighting in exit paths—G4.4(b)

G4.4(b) requires lighting in main exit paths. The key description is public corridors, public hallways or the like, inferring that any pathway used as a general or common exit route by occupants must be provided with emergency lighting.

Emergency lighting—G4.4(c)

G4.4(c) requires emergency lighting externally above every doorway opening to a road or open space. This enables occupants to negotiate any obstacles when evacuating in darkness.

G4.4(c) applies only to doorways leading directly or via the allotment land to a public road. Doorways opening on to enclosed courtyards or similar enclosed areas are not required to comply.

Emergency lighting and darkness—G4.4(d)

G4.4(d) is a performance criterion, and will require assessment of the building layout to determine the need for emergency lighting in areas other than those specified in **G4.4(a)**, **(b)** and **(c)**. The aim of **G4.4** is to assist people by providing illumination in paths of travel while evacuating the building.

Where the designer or appropriate authority believes there are problems which may be created due to darkness, then emergency lighting must be installed.

Exit signs— Part E4

Note that while it is not referenced in **Part G4**, emergency exit signs need to be installed in accordance with **Part E4**.

G4.5 External ramps

Intent

To enable people to evacuate a building in an alpine area in an emergency without being impeded by steep ramps.

External ramps must not be too steep

G4.5 aims to ensure that egress is not impeded by steep ramps. The maximum slope of 1:12 is less than the 1:8 allowed in **Part D2** because of the difficulty associated with negotiating ramps in snow and ice conditions. **G4.5(a)** acknowledges that if exit ramps are required for access by people with disabilities they must comply with AS 1428.1.

G4.6 Discharge of exits

Intent

To enable people to evacuate and emergency services to access a building in an alpine area in an emergency without being impeded by snow build-up around the building.

Snow build-up between and around buildings

The design and construction of a building in an alpine area must not aid dangerous levels of snow build-up between and around buildings. This control:

- assists with egress in an emergency;
- helps vehicle access around the buildings, both for snow clearing and emergency situations; and
- minimises the risk of snow or ice falling from the roof on to adjoining lots or egress routes.

G4.6(a) addresses the set-back distance for external walls from the boundary of adjoining allotments. The aim is to make sure that a reasonable distance is created between buildings to reduce the amount of snow build-up between properties. **G4.6(a)** applies only to the area adjacent to that part of the wall which is more than 3.6 metres in height.

G4.6(b) describes distances between wings of a building where the exit doorway discharges into this area. The external walls of a building should not create an alcove which traps snow, making evacuation difficult.

G4.6(c) deals with the problem of features adjacent to an exit doorway which could trap snow and complicate egress.

The term “barrier” is used to describe the feature which could entrap snow. Because the aim of **G4.6(c)** is to avoid the problems created by snow drifts, it would be reasonable to interpret “barrier” as including any feature which could hold the snow, including fences, cuttings to roadways, walls of adjacent buildings and the like. See **Figure G4.6**.

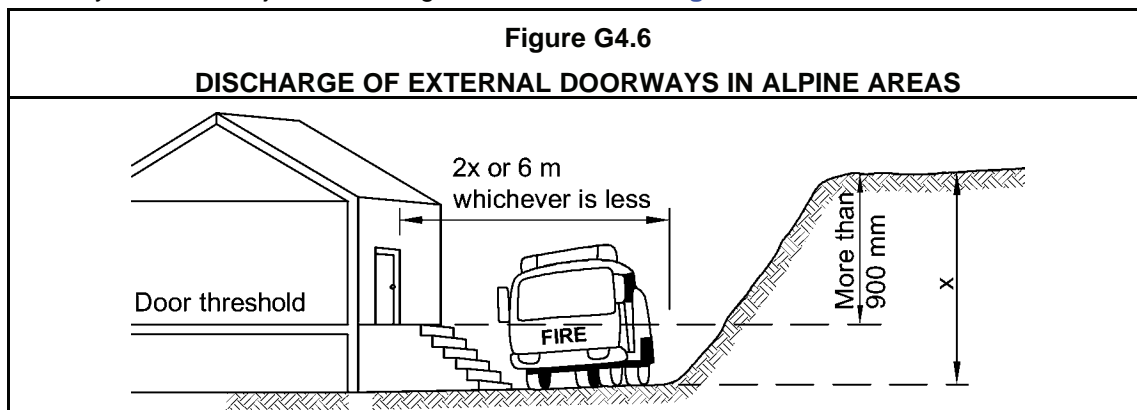

G4.7 External trafficable structures

Intent

To enable people to evacuate and emergency services to access a building in an alpine area in an emergency without being impeded by inadequate structures comprising part of the exit path of travel to a safe place.

Slipperiness and safe barriers

G4.7 aims to make sure that external structures comprising part of the exit path of travel from a building to a safe place:

- have a floor surface preventing people from slipping; and
- have any required balustrade or barrier (ie required by **Part D2**) designed so that it is more than 75 per cent open to minimise snow build-up.

This provision only applies to structures, and not to such paths of travel as steps and ramps created by landscaping.

G4.8 Fire-fighting services and equipment

Intent

To provide for the installation of adequate fire safety equipment suitable to the conditions experienced in alpine areas.

Fire alarm system—G4.8(a)

G4.8(a) requires a manually-operated, fire-alarm system. This system must be supplemented by call-points to notify the local fire authority. The activation mechanism of the manual call-point may also activate the alarm system. This will provide an additional audible warning to the automatic systems required by **E2.2**.

Where an external alarm is installed, sub-zero temperatures must not freeze its mechanism.

Hose reels and hydrants—G4.8(b)

G4.8(b) requires that hose reels and hydrants be installed in all the nominated buildings in accordance with **Part E1**. These systems must be operable in sub-zero conditions, and any water in the mains should not freeze.

Class 4 parts of buildings

G4.8 has not been applied to Class 4 parts of a building. It is extremely unlikely that any of the services and equipment required by **G4.8** will be located within a sole-occupancy unit in any residential building. In, for example, Class 2 and Class 3 buildings it is most likely that such services and equipment will be located in common areas.

The requirement for the installation of fire-fighting services and equipment in the non-Class 4 parts of the building within which the Class 4 part is located, will provide for the safety of the occupants of the Class 4 part.

G4.9 Fire orders

Intent

To enable occupants to evacuate a building in an alpine area in an emergency without being impeded by lack of knowledge of the fire safety system, egress routes or evacuation procedures.

Notices

In Class 2, Class 3 and Class 9 buildings, **G4.9** requires that a notice containing fire orders be displayed. They are necessary because there is a high probability that, in alpine areas, the occupants may be residing overnight or for short periods only, and will be unfamiliar with their surroundings.

Fire escape information needs to be displayed prominently near the main entrance and on each storey so that people new to the building can identify escape features, etc. A suitable location would be near the primary stairway. Additional advice on locating these items can be obtained from the appropriate authority or local fire authority.

Information must be conveyed in a clear and simple manner, because of the varying degree of technical understanding of people reading this information.

Class 4 parts of buildings

Class 4 parts of buildings have not been included in the coverage of **G4.9** because buildings will not typically be used for short term rental accommodation in alpine areas. Therefore, residents are likely to be aware of safety requirements.

PART G5

CONSTRUCTION IN BUSHFIRE PRONE AREAS

Objective

GO5

Australia contains some of the most dangerous bushfire areas in the world and concern over loss of life and property led to the development of **Part G5**.

Within Volume One of the BCA the provisions only apply to a Class 2 or Class 3 building, or a Class 10a building or deck associated with a Class 2 or 3 building, as residential buildings are considered to present the greatest risk to life. The provisions also only apply in areas that have been designated as 'bushfire prone areas'.

GO5, specifically **GO5(b)**, is one of the few Objectives of the BCA which requires the protection of a building as well as its occupants.

Functional Statement

GF5.1

As for **GO5**, **GF5.1** only applies to a Class 2 or Class 3 building, or a Class 10a building or deck associated with a Class 2 or 3 building in a designated bushfire prone area. However **GF5.1** only requires a Class 2 or Class 3 building, or a Class 10a building or deck associated with a Class 2 or 3 building to provide resistance to a bushfire, not total protection.

Performance Requirements

GP5.1

GP5.1 applies only to a Class 2 or Class 3 building, or a Class 10a building or deck associated with a Class 2 or 3 building in a designated bushfire prone area.

The basis of **GP5.1** is that:

- bushfires provide a major risk of ignition while the fire front is passing over a building; and
- the building occupier or the fire brigade may be able to provide a reasonable amount of protection from the spread of fire to the building (i.e. from trees and the like which may still be burning) after a fire front passes.

PART G5

Construction in Bushfire Prone Areas

Deemed-to-Satisfy Provisions

G5.0 Deemed-to-Satisfy Provisions

Intent

To clarify that complying with [G5.1](#) and [G5.2](#) will satisfy the requirements of [GP5.1](#).

G5.1 Application of Part

Intent

To clarify that Part [G5](#) applies only to a Class 2 or Class 3 building, or a Class 10a building or deck associated with a Class 2 or 3 building in a designated bushfire prone area.

G5.2 Protection

Intent

To clarify that compliance with AS 3959 will achieve compliance with [Part G5](#).

[G5.2](#) adopts AS 3959—*Construction of buildings in bushfire-prone areas*. Compliance with this Australian Standard will achieve compliance with [Part G5](#).

The purpose of AS 3959 is to improve the fire resistance performance of buildings that may be subjected to burning debris, radiant heat and flame contact during the passing of a fire front. Construction requirements are dependent on the bushfire hazard level of the site. It should be noted that even though a site may be located in a designated bushfire prone area, if the category of bushfire attack for the particular site is low, there are no special construction requirements specified in AS 3959.

Maintenance plays an important role in the overall strategy of improving the performance of buildings against bushfires. This includes maintenance (or better still, improvement) of the site conditions and maintenance of the building itself.

SPECIAL USE BUILDINGS

H1 Theatres, Stages and Public Halls

H2 Public Transport Buildings

SECTION H CONTENTS

SECTION H SPECIAL USE BUILDINGS

Part H1 Theatres, Stages and Public Halls

- H1.1 Application of Part
- H1.2 Separation
- H1.3 Proscenium wall construction
- H1.4 Seating area
- H1.5 Exits from theatre stages
- H1.6 Access to platforms and lofts
- H1.7 Aisle lights in theatres

Part H2 Public Transport Buildings

- H2.1 Application of Part
- H2.2 Accessways
- H2.3 Ramps
- H2.4 Handrails and grabrails
- H2.5 Doorways and doors
- H2.6 Lifts
- H2.7 Stairways
- H2.8 Unisex accessible toilet
- H2.9 Location of accessible toilets
- H2.10 Symbols and signs
- H2.11 Tactile ground surface indicators
- H2.12 Lighting
- H2.13 Hearing augmentation
- H2.14 Emergency warning systems
- H2.15 Controls

Specifications

Specification H1.3 Construction of Theatres with Proscenium Walls

PART H1 THEATRES, STAGES AND PUBLIC HALLS

Objective

Functional Statements

Performance Requirements

The Objective, Functional Statements and Performance Requirements for **Part H1** are contained in **Sections C, D** and **E**. **Part H1** contains additional Deemed-to-Satisfy Provisions for buildings which contain theatres, stages and public halls.

PART H1 THEATRES, STAGES AND PUBLIC HALLS

Deemed-to-Satisfy Provisions

H1.1 Application of Part

Intent

To clarify which Class 9b buildings are subject to **Part H1**, and to what extent they are subject.

Class 9 buildings and high fire loads—H1.1(a)

Stages used for live performances can contain high fire loads due to the props, scenery, lighting, and the like used in such productions. Such props and scenery are often also stored in backstage areas, which adds to the fire load.

General application of Part H1

In general, **Part H1** applies to specified enclosed Class 9b buildings which:

- in the case of school assembly, church or community halls, contain both a stage and backstage area which exceeds 300 m²;
- are not covered by **H1.1(a)(i)**, and have a stage or backstage area which exceeds 200 m²; or
- have a stage with a rigging loft.

Part H1 does not simply apply to stage and backstage areas, but also to seating areas and aisle lighting.

H1.4 and all Class 9b buildings—H1.1(b)(i)

H1.4 applies to all Class 9b buildings, whether or not they are enclosed, and regardless of size.

H1.7 and all enclosed Class 9b buildings—H1.1(b)(ii)

H1.7 applies to all Class 9b buildings which are enclosed, regardless of their size.

H1.2 Separation

Intent

To protect the audience in a theatre or public hall from a fire on the stage.

Fire safety

H1.2 does not apply to all theatres and public halls. See **H1.1** to determine which buildings need to comply with **H1.2**. A stage and backstage area of a theatre or public hall has a high fire load due to the storage of props and scenery/etc.

The audience must be protected from this fire source by either:

- the installation of a sprinkler system; or
- the construction of a proscenium wall between the stage and the audience area.

H1.3 Proscenium wall construction

Intent

To set out the detailed construction requirements for a proscenium wall.

Proscenium wall—[Specification H1.3](#)

The construction details for a proscenium wall are contained in [Specification H1.3](#).

H1.4 Seating area

Intent

To enable the evacuation of an audience from the seating area.

H1.4 applies to all Class 9 buildings

Under [H1.1\(b\)\(i\)](#), [H1.4](#) applies to all Class 9b buildings, both enclosed and open. This means that it applies to theatres, open-deck spectator stands, sporting stadiums, and the like, wherever the public is seated to view an event.

Maximum slope of the floor—[H1.4\(a\)](#)

[H1.4\(a\)](#) deals with the height difference between the floors supporting seats in a theatre and the like. The maximum slope of the floor of 1 in 8 is consistent with [D2.10\(b\)\(ii\)](#).

This slope cannot be used in aisles required to be accessible by people with disabilities. In such a case, the maximum slope of the aisle is 1 in 14, as required by AS 1428.1.

Height of openings in steps

The maximum gap of 125 mm stipulated in [H1.4\(a\)\(iii\)](#) is consistent with [D2.13\(a\)\(iv\)](#).

Figures [H1.4\(1\)](#) and [\(2\)](#)

Figures [H1.4\(1\)](#) and [\(2\)](#) illustrate methods of complying with [H1.4\(a\)](#) and [\(b\)](#).

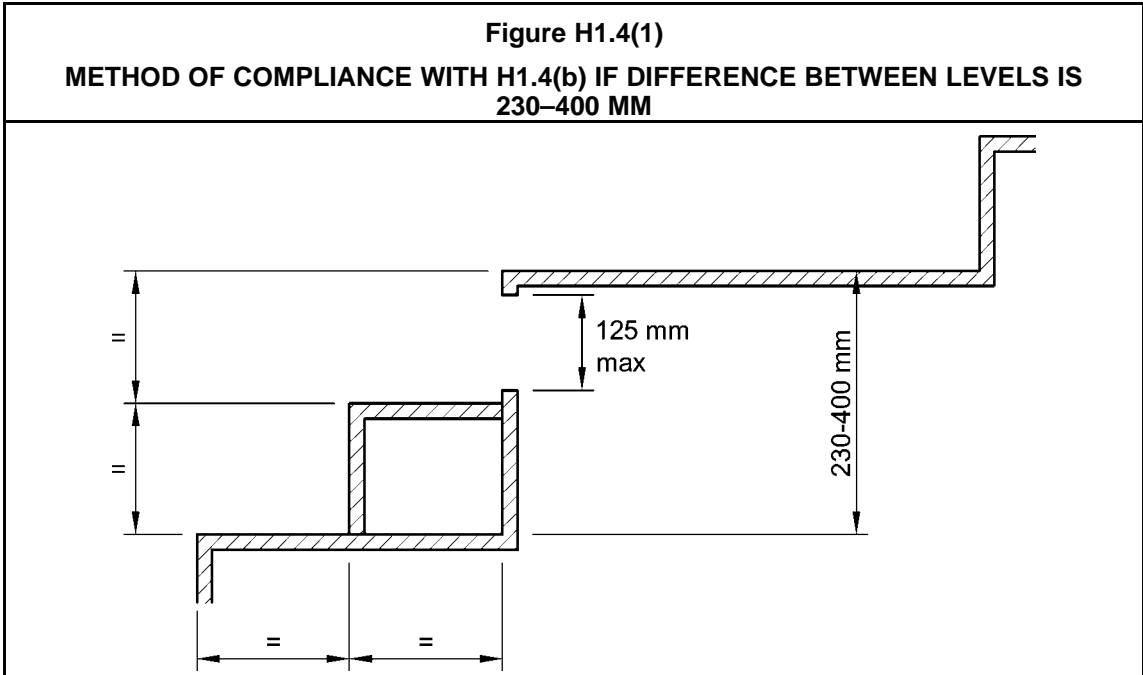

Width of path of travel to an exit—H1.4(c)

It is often impractical to require the standard minimum width of a path of travel to an exit of one metre between rows of fixed seating. **H1.4(c)** allows a reduced width in such cases. This width is based on studies of movement between rows.

Distance between the seats should ordinarily be measured:

- with the seat in the up position if folding seats are used; or
- directly between the seats, as shown in **Figure H1.4(3)**.

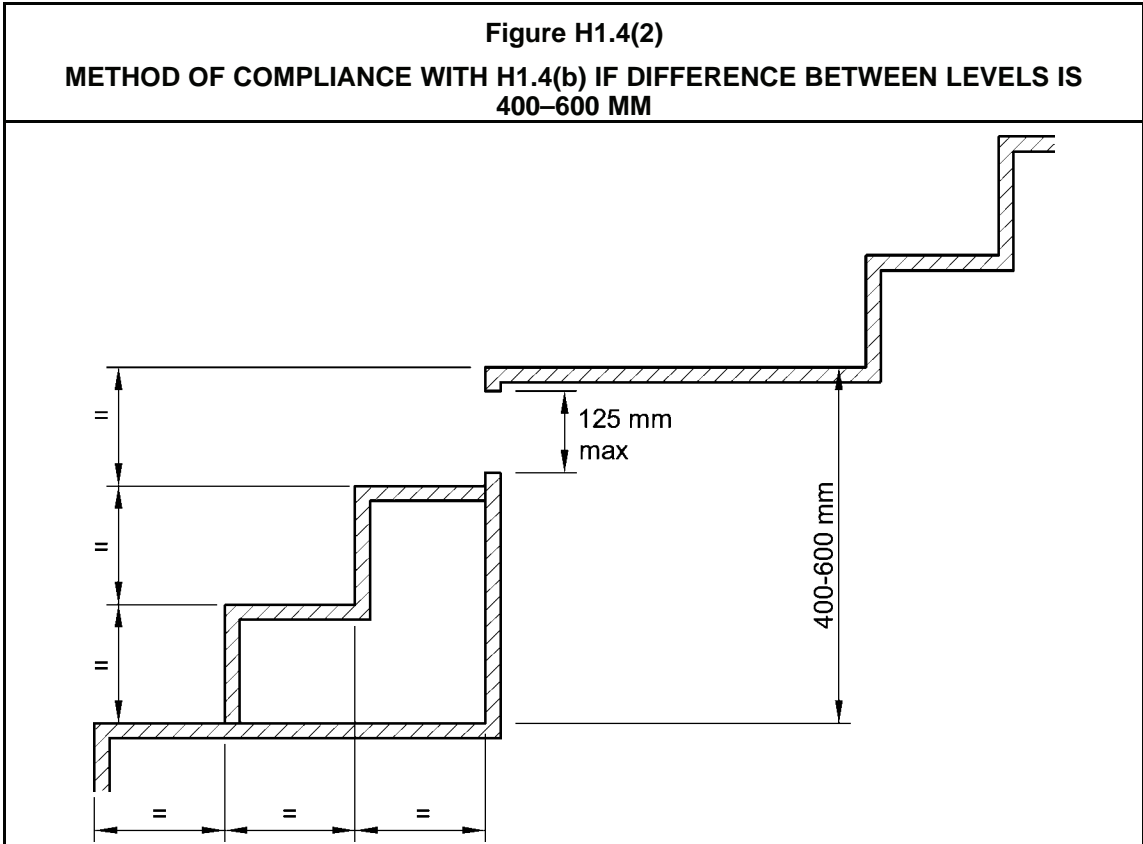

H1.4(c) applies only where the public is seated on fixed seating to view an event.

H1.5 Exits from theatre stages

Intent

To enable safe egress from the stage and backstage areas of a theatre.

Evacuation routes from stage and backstage areas

A stage and backstage area of a theatre or public hall has a high fire load. It is also a potential fire source due to stored props, scenery, lighting, special effects, and the like.

Because of the recognised fire hazard, proscenium walls and curtains are required to separate the stage and backstage areas from the audience.

To maintain this fire separation:

- an evacuation route from the stage side of a proscenium must not pass through the proscenium; and
- required exits from backstage must be independent of the audience evacuation routes.

H1.6 Access to platforms and lofts

Intent

To set out the requirements for stairways to service platforms, rigging lofts, and the like.

Stairways to service platforms and rigging lofts

Stairways to service platforms, rigging lofts, and the like must comply with AS 1657.

H1.7 Aisle lights in theatres

Intent

To make safe evacuation available from theatres.

Aisle lights

H1.7 applies to enclosed Class 9b buildings where:

- lighting is dimmed or extinguished during public occupation; and
- the floor is stepped or inclined at a slope steeper than 1 in 12.

In case of an evacuation, and when the lights are dimmed or extinguished during a performance, **H1.7** requires the installation of aisle lights to avoid people tripping on steps, or falling on a ramp.

Figure H1.4(3)

METHOD OF MEASUREMENT OF CLEARANCE BETWEEN ROWS OF FIXED SEATING

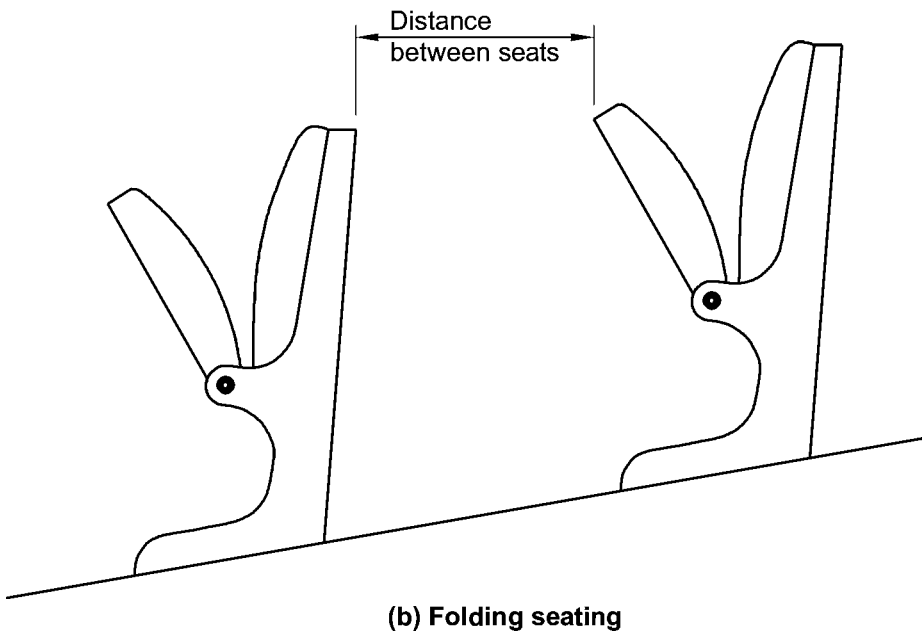
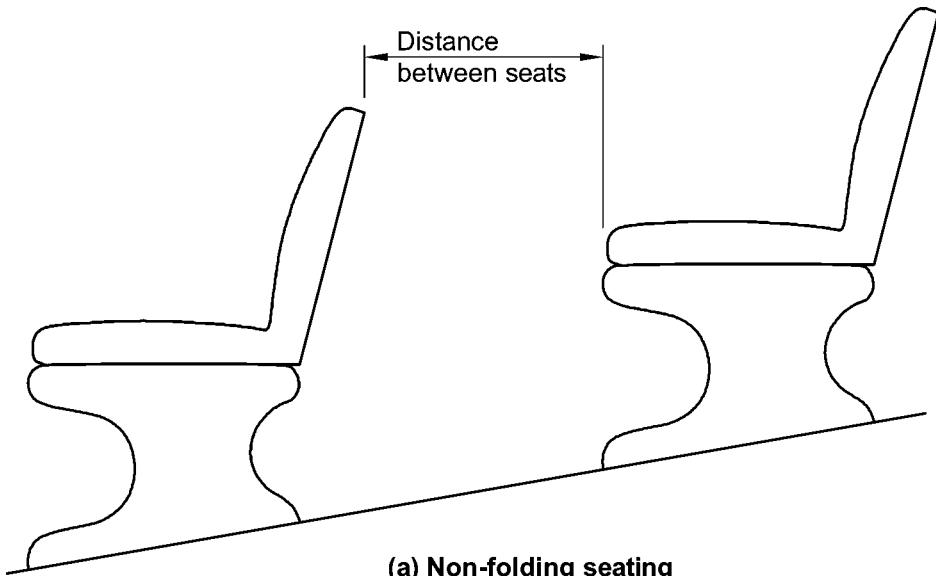

PART **H2** PUBLIC TRANSPORT BUILDINGS

Objective

Functional Statements

Performance Requirements

The Objective, Functional Statements and Performance Requirements for **Part H2** are contained in Sections **D**, **E** and **F**. **Part H2** contains Deemed-to-Satisfy Provisions for Class 9b and Class 10 public transport buildings additional to those contained in **Parts D3**, **E3** and **F2** that apply to public transport buildings.

PART H2 PUBLIC TRANSPORT BUILDINGS

Deemed-to-Satisfy Provisions

H2.1 Application of Part

Intent

To clarify which public transport buildings are subject to **Part H2** and to what extent they are subject.

Part H2 specifically relates to buildings associated with public transport services, such as railway stations, bus interchanges, airports and ferry terminals. These requirements were previously located in the Disability Standards for Accessible Public Transport 2002 (Transport Standards). Some versions of Australian Standards referred to in **Part H2** may be different to those referred to in the remainder of the BCA. The correct version of the Australian Standard to be used can be determined by reference to **Specification A1.3**.

H2.1(a) provides that the Deemed-to-Satisfy Provisions of **Part H2** apply to the passenger use areas of Class 9b or Class 10 buildings used for public transport. Class 9b and Class 10 public transport buildings must also satisfy the Deemed-to-Satisfy Provisions of **Parts D3, E3 and F2**.

H2.1(b) provides a rule for resolving inconsistencies between these requirements imposed on public transport buildings by providing that the Deemed-to-Satisfy Provisions of **Part H2** take precedence where there is a difference.

H2.1(c) provides that, as under the Transport Standards, certain requirements in **Part H2** do not apply to 'airports that do not accept regular public transport services' as defined in the Transport Standards.

H2.1(d) provides that **A3.3(a)** does not apply to **Part H2** because the application of this provision to **Part H2** could result in a different outcome to what would have been achieved under similar provisions that existed in the Transport Standards. Under **A3.3(a)**, if 10% or less of the floor area of a storey is used for a purpose which could be classified differently to the remainder of that storey, that part may be classified as being the same as the remainder.

H2.2 Accessways

Intent

To specify requirements for accessways in buildings covered by **Part H2**.

The requirements for accessways in **H2.2** were previously located in the Transport Standards.

Accessways and manoeuvring areas may be for other purposes, such as standing areas, but it is expected that public transport passengers will be able to transit them and that they remain available for use by people with a disability when required.

Hazards created by poles, columns, stanchions, bollards and fixtures alongside accessways should be avoided. For example, the use of short posts to prevent delivery vehicles from driving onto parts of pedestrian areas, or commercial signs projecting from walls should be avoided.

H2.2(g) requires passing areas to be provided in prescribed locations, with the intent that they be wide enough for 2 people, each using a mobility aid, to pass one another.

H2.3 Ramps

Intent

To specify requirements for ramps in buildings covered by **Part H2**.

The requirements for ramps in **H2.3** were previously located in the Transport Standards.

H2.3 provides requirements for accessible ramps in public transport buildings. Ramps forming part of an accessway must comply with clause 8 of AS 1428.2 (1992).

H2.3(b) provides that **D3.11(a)**, which limits the combined vertical rise of connected ramps to 3.6 m, does not apply to buildings covered by **Part H2**.

H2.4 Handrails and grabrails

Intent

To specify requirements for handrails and grabrails in buildings covered by **Part H2**.

The requirements for handrails and grabrails in **H2.4** were previously located in the Transport Standards.

H2.4 provides requirements for handrails and grabrails in public transport buildings. **H2.4(b)** provides that handrails must be placed along an accessway to assist wherever passengers are likely to require additional support or guidance, such as changes of level, ramps, a narrowing or a change of direction of an accessway. **H2.4(d)** provides, in particular, that a grabrail or handrail must be provided at fixed locations where passengers are required to pay fares.

H2.5 Doorways and doors

Intent

To specify requirements for doorways and doors in buildings covered by **Part H2**.

The requirements for doorways and doors in **H2.5** were previously located in the Transport Standards.

H2.5 provides that doorways and doors must comply with clause 11 (except clause 11.5.2) of AS 1428.2 (1992). The BCA allows for doors that are automatic, power assisted or manual.

H2.6 Lifts

Intent

To specify requirements for lifts in buildings covered by **Part H2**.

The requirements for lifts in **H2.6** were previously located in the Transport Standards.

H2.6 provides that lift facilities must comply with AS 1735.12.

H2.7 Stairways

Intent

To specify requirements for stairways in buildings covered by **Part H2**.

The requirements for stairways in **H2.7** were previously located in the Transport Standards.

H2.7 provides specifications for accessible stairways in public transport buildings.

The requirement for an accessway under the BCA means that stairways cannot be the sole means of access. However, stairways are acceptable as an optional route on an accessway.

H2.8 Unisex accessible toilet

Intent

To specify requirements for unisex accessible toilets in buildings covered by **Part H2**.

The requirements for unisex accessible toilets in **H2.8** were previously located in the Transport Standards.

H2.8 provides that if toilets are provided, at least one unisex accessible toilet must be provided in accordance with AS 1428.1 (2001) clause 10, sanitary facilities.

H2.9 Location of accessible toilets

Intent

To specify requirements for the location of accessible toilets in buildings covered by **Part H2**.

The requirements for the location of accessible toilets in **H2.9** were previously located in the Transport Standards.

H2.9 provides that accessible toilets must be provided in the same location as other toilets.

H2.10 Symbols and signs

Intent

To specify requirements for symbols and signs in buildings covered by **Part H2**.

The requirements for symbols and signs in **H2.10** were previously located in the Transport Standards.

H2.10 provides requirements for symbols and signs, including where signs should be provided, and the specifications that the signs must comply with.

H2.11 Tactile ground surface indicators

Intent

To specify requirements for tactile ground surface indicators (TGSIs) in buildings covered by [Part H2](#).

The requirements for TGSIs in [H2.11](#) were previously located in the Transport Standards.

[H2.11](#) provides that TGSIs must be installed to define key areas on an accessway for people with vision impairment. TGSIs must comply with AS 1428.4 and must indicate changes in direction in accordance with clause 18.1 of AS 1428.2 (1992).

H2.12 Lighting

Intent

To specify requirements for lighting in buildings covered by [Part H2](#).

The requirements for lighting in [H2.12](#) were previously located in the Transport Standards.

[H2.12](#) provides that any lighting provided must comply with the minimum levels of maintenance illumination specified in the notes to clause 19.1 of AS 1428.2 (1992).

H2.13 Hearing augmentation

Intent

To specify requirements for hearing augmentation in buildings covered by [Part H2](#).

The requirements for hearing augmentation in [H2.13](#) were previously located in the Transport Standards.

[H2.13](#) provides that if a public address system is installed, it must comply with clause 21.1 of AS 1428.2 (1992).

H2.14 Emergency warning systems

Intent

To specify requirements for emergency warning systems in buildings covered by [Part H2](#).

The requirements for emergency warning systems in [H2.14](#) were previously located in the Transport Standards.

[H2.14](#) provides specifications for emergency warning systems. [H2.14\(b\)](#) provides that, in the event of an emergency, provision must be made for people with vision impairment to locate the exit path.

H2.15 Controls

Intent

To specify requirements for controls in buildings covered by [Part H2](#).

The requirements for controls in **H2.15** were previously located in the Transport Standards.

H2.15 provides that controls must comply with clause 11 of AS 1428.1 (2001) which covers door handles and hardware, switches and general purpose outlets (power points) and water taps.

SPECIFICATION **H1.3** CONSTRUCTION OF THEATRES WITH
PROSCENIUM WALLS

Deemed-to-Satisfy Provisions

Specification H1.3—Comments

This Guide does not address, in detail, every provision in this Specification. However, there are some comments which should be made.

Specification H1.3—purpose

A stage and backstage area of a theatre or public hall has a high fire load. It is also a potential fire source due to stored props and scenery, etc.

Specification H1.3 deals with how to provide fire separation by a proscenium wall between the stage and backstage areas, and other parts of the building, including those occupied by an audience.

Height and extent of a proscenium wall—fire wall

The height and extent of a proscenium wall are similar to those of a fire wall. Any openings in it must be suitably protected to prevent the spread of a fire to the audience side.

Proscenium curtains

An important part of avoiding the spread of fire from the stage is the protection of the opening to the stage. Protection must be provided while still permitting the audience to view a performance.

Since the opening is too large to protect with an automatically-closing fire door, the aim of providing protection while maintaining functionality is achieved by the use of a proscenium curtain. **Clause 6** of the specification gives two alternative options for such a curtain.

MAINTENANCE

- I1 **Equipment and Safety Installations**
- I2 **Energy Efficiency Installations**

SECTION I CONTENTS

SECTION I MAINTENANCE

PART I1 Equipment and Safety Installations

Objective IO1

Functional Statement IF1.1

Performance Requirements IP1.1 - IP1.2

I1.0 Deemed-to-Satisfy Provisions

I1.1 Safety measures

I1.2 Mechanical ventilation and hot water, warm water and cooling water systems

PART I2 Energy Efficiency Installations

Objective IO2

Functional Statement IF2.1

Performance Requirements IP2.1

I2.0 Deemed-to-Satisfy Provisions

I2.1 Application of Part

I2.2 Components of Services

PART 11

EQUIPMENT AND SAFETY INSTALLATIONS

Objective

IO1 Ongoing safety, health and amenity levels

IO1 reflects the philosophy that throughout the life of a building, safety, health and amenity levels should accord with the Performance Requirements of the BCA.

Functional Statement

IF1.1 Equipment and safety installations

IF1.1 reflects the practical issues involved with applying the Objective **IO1** to buildings, and accordingly limits its application to equipment and safety installations for the purposes of safeguarding people from illness, injury and the loss of amenity.

Performance Requirements

IP1.1 Safety measures

All building measures related to people safety must continue to perform as originally intended.

IP1.2 Mechanical ventilation and hot water, warm water and cooling water systems

Mechanical ventilation and hot water, warm water and cooling water systems must be maintained to ensure that they do not cause illness or injury to building occupants.

PART 11

EQUIPMENT AND SAFETY INSTALLATIONS

Deemed-to-Satisfy Provisions

11.0 Deemed-to-Satisfy Provisions

Intent

To clarify the application of the Performance Requirements in Section I to the Deemed-to-Satisfy Provisions in Part 11, and to clarify which Performance Requirements are relevant to any Alternative Solutions to those Deemed-to-Satisfy Provisions.

11.0(a)

Where a Building Solution is proposed to comply with the Deemed-to-Satisfy Provisions, **11.0(a)** clarifies that compliance with **11.1** will satisfy **IP1.1**, and that compliance with **11.2** will satisfy **IP1.2**.

11.0(b)

Where a Building Solution is proposed as an Alternative Solution to the Deemed-to-Satisfy Provisions, the relevant Performance Requirements must be determined in accordance with **A0.10**. (See comment on **A0.10**).

11.1 Safety measures

Intent

To establish the minimum standard of performance that all safety measures in buildings must be continually able to achieve.

11.1(a)

11.1(a) prescribes the general requirement that all safety measures in buildings must continue to perform at a standard no less than they were originally required to achieve.

11.1(b)

Notwithstanding the general provisions in **11.1(a)**, requirements for specific safety measures are prescribed in **11.1(b)**. These requirements relate to **Tables 11.1** to **11.13**, which list common building safety measures and the applicable BCA provisions that should be used to determine the standard of performance that they must be continually able to achieve.

Additional State and Territory regulations

In some States and Territories additional regulations supplement the provisions of **11.1**. Depending on the State or Territory, these regulations may include specific maintenance and/or certification requirements. Building owners, managers and operators should be familiar with the requirements that are applicable in their State or Territory.

Achieving the required standard of performance

Guidance on methods of ensuring that building safety measures continue to achieve the required standards of performance may be obtained from State and Territory regulations and practice notes, industry standards and advisory notes, information from product manufacturers, and fire engineering design documentation, as applicable.

11.2 Mechanical ventilation and hot water, warm water and cooling water systems

Intent

To set out the maintenance requirements for mechanical ventilation and hot, warm and cooling water systems.

AS/NZS 3666.2

The aim of the reference to AS/NZS 3666.2 is to improve the health and hygiene aspects of air-handling and hot water, warm water and cooling water systems in buildings. AS/NZS 3666.2 covers the most common known sources of the diseases associated with air-handling and water systems in buildings, including Legionnaires' disease, Pontiac fever, and so on.

AS/NZS 3666.2 is not intended to cover "discomfort" symptoms which may affect building occupants.

This provision applies to all buildings except systems that only serve a single sole-occupancy unit in Class 2 or 3 building or Class 4 part. This limitation is consistent with the intent of AS/NZS 3666.2, the limitation of [FP2.6](#) and [F2.7](#).

PART 12

ENERGY EFFICIENCY INSTALLATIONS

Objective

IO2 Energy Efficiency levels

IO2 reflects the philosophy that any energy efficiency measures required for services are to be maintained at the same level of performance throughout the life of a building.

Part 12 does not apply to private dwellings, i.e. Class 1 buildings, therefore it is also not applied to the sole-occupancy units of Class 2 buildings, or Class 4 parts of buildings.

Functional Statement

IF2.1 Reducing greenhouse gas emissions

IF2.1 reflects the practical issue of maintaining the energy efficiency performance of a building's services in order to achieve the Objective **IO2**.

Performance Requirements

IP2.1 Systems and components relating to energy efficiency

The systems and components of a service are to be checked on a regular basis to ensure that they continue to perform at their original level of energy efficiency throughout the life of the building. Failure to maintain systems and components of a service could affect its operation and reduce its energy efficiency performance.

The limitation to **IP2.1** means that this Performance Requirement does not apply to a sole-occupancy unit of a Class 2 building or a Class 4 part of a building. It is not considered appropriate to include maintenance provisions for sole-occupancy units or Class 4 parts of buildings as these are usually privately owned and maintained dwellings.

PART 12

ENERGY EFFICIENCY INSTALLATIONS

Deemed-to-Satisfy Provisions

12.0 Deemed-to-Satisfy Provisions

Intent

To clarify that the requirements of **IP2.1** will be satisfied if compliance is achieved with **I2.1** and **I2.2**.

IP2.1, I2.1 and **I2.2**

Where a Building Solution is proposed to comply with the Deemed-to-Satisfy Provisions, **I2.0** clarifies that compliance with **I2.1** and **I2.2** achieves compliance with **IP2.1**.

Where a Building Solution is proposed as an Alternative Solution to the Deemed-to-Satisfy Provisions, the relevant Performance Requirements are to be determined in accordance with **A0.10**. (See comment on **A0.10**).

12.1 Application of Part

Intent

To clarify the classifications of buildings that are subject to **Part 12**.

Part 12 does not apply to a sole-occupancy unit of a Class 2 building or a Class 4 part of a building. It is not considered appropriate to include maintenance provisions for sole-occupancy units or Class 4 parts of buildings as these are privately owned and maintained residential dwellings.

12.2 Components of Services

Intent

To set out the maintenance requirements for components of services.

I2.2 lists a number of specific components of services that are to be adequately maintained to ensure that they continue to perform as initially intended by the BCA.

The nature and frequency of maintenance is not prescribed because it will vary greatly depending on the type of equipment and the conditions under which it operates. Instead, the emphasis in the BCA is on maintaining the required performance. Manufacturers generally recommend the maintenance needed and there are various trade publications, such as the AIRAH publication DA19 "HVAC & R Maintenance", which also detail appropriate maintenance.

It should be noted that requirements for maintenance are contained in the building regulations of some jurisdictions.

ENERGY EFFICIENCY

- J0** **Energy Efficiency**
- J1** **Building Fabric**
- J2** **Glazing**
- J3** **Building Sealing**
- J4** * * * * *
- J5** **Air-Conditioning and Ventilation Systems**
- J6** **Artificial Lighting and Power**
- J7** **Hot Water Supply and Swimming Pool and Spa
Pool Plant**
- J8** **Access for Maintenance and Facilities for
Monitoring**

SECTION J CONTENTS

Section J Energy Efficiency

Objective JO1

Functional Statement JF1

Performance Requirements JP1 - JP3

Verification Methods JV1 - JV3

Specification JV Annual Energy Consumption Calculation

Part J0 Energy Efficiency

J0.0 Deemed-to-Satisfy Provisions

J0.1 Application of Section J

J0.2 Reducing the heating and cooling loads of a sole-occupancy unit of a Class 2 building or a Class 4 part

J0.3 Ceiling fans

Part J1 Building Fabric

J1.0 Deemed-to-Satisfy Provisions

J1.1 Application of Part

J1.2 Thermal construction-general

J1.3 Roof and ceiling construction

J1.4 Roof lights

J1.5 Walls

J1.6 Floors

Part J2 Glazing

J2.0 Deemed-to-Satisfy Provisions

J2.1 Application of Part

J2.2 * * * * *

J2.3 * * * * *

J2.4 Glazing

J2.5 Shading

Part J3 Building Sealing

J3.0 Deemed-to-Satisfy Provisions

J3.1 Application of Part

J3.2 Chimneys and flues

J3.3 Roof lights

J3.4 Windows and doors

J3.5 Exhaust fans

J3.6 Construction of roofs, walls and floors

J3.7 Evaporative coolers

Part J4 * * * * *

Part J5 Air-Conditioning and Ventilation Systems

J5.0 Deemed-to-Satisfy Provisions

J5.1 * * * * *

J5.2 Air conditioning and ventilation systems

J5.3 Time switch

J5.4 Heating and cooling systems

J5.5 Miscellaneous exhaust systems

Part J6 Artificial Lighting and Power

J6.0 Deemed-to-Satisfy Provisions

J6.1 * * * * *

J6.2 Artificial lighting

J6.3 Interior artificial lighting and power control

J6.4 Interior decorative and display lighting

J6.5 Artificial lighting around a building

J6.6 Boiling water and chilled water storage units

Part J7 Hot Water Supply and Swimming Pool and Spa Pool Plant

J7.0 Deemed-to-Satisfy Provisions

J7.1 * * * * *

J7.2 Hot water supply

J7.3 Swimming Pool Heating and Pumping

J7.4 Spa Pool Heating and Pumping

Part J8 Access for Maintenance and Facilities for Monitoring

J8.0 Deemed-to-Satisfy Provisions

J8.1 Application of Part

J8.2 Access for maintenance

J8.3 Facilities for Energy Monitoring

Specifications

Specification J1.2 Material Properties

Specification J1.3 Roof and Ceiling Construction

Specification J1.5 Wall Construction

Specification J1.6 Floor Construction

Specification J5.2 Ductwork Insulation and Sealing

Specification J5.4 Insulating of Piping, Vessels, Heat Exchangers and Tanks

Specification J6 Lighting and Power Control Devices

SECTION J ENERGY EFFICIENCY

Objective

JO1

Basis of Objective

This Objective reflects the Council Of Australian Governments (COAG) decision in 2009 that a building is to be capable of reducing its greenhouse gas emissions.

National Commitment

In November 1998, all jurisdictions demonstrated their commitment to an effective national greenhouse response by endorsing the National Greenhouse Strategy, a part of which recognised the importance of energy efficiency standards for housing and commercial buildings. An option outlined in the National Greenhouse Strategy was to introduce measures in the BCA to reduce greenhouse gas emissions by efficiently using energy.

On 19 July 2000, the Commonwealth Government announced that agreement had been reached between it and the State and Territory Governments to examine and develop suitable national energy efficiency provisions for domestic and commercial buildings. After taking account of the views of industry, the Commonwealth Government also announced its intention to pursue a strategy that included two elements: firstly, the encouragement of voluntary measures by industry, and secondly, the introduction of minimum mandatory requirements in the BCA.

It is accepted that market failure occurs in some situations and a minimum standard of energy efficiency performance needs to be regulated. For example, a developer who intends to sell a house or building is not concerned about the ongoing energy costs that the occupier is to bear, and as many energy efficiency features cannot be easily retrofitted, it is more cost effective to include them initially. An owner-occupier may have difficulty raising the necessary funds for energy efficiency measures, or may intend to sell the building soon, and so may be prepared to forego the long-term cost savings. Regulations requiring energy efficient performance will act to prevent this.

As a result of the Commonwealth Government's initiative, the Australian Greenhouse Office (AGO) and the Australian Building Codes Board (ABCB) entered into an agreement on 5 January 2001 to develop energy efficiency measures for inclusion in the BCA. Industry is supportive of the need to eliminate worst practice and accepts a minimum mandatory approach as it provides a level playing field. Further, industry takes the view that any building-related regulations should be consolidated in the BCA wherever possible.

In 2003, energy efficiency provisions were introduced into the BCA for housing. In 2005, energy efficiency provisions were introduced for other residential buildings. In 2006, those provisions were expanded to include all other Classes of buildings, as well as enhancing the stringency for houses to a target of 5 stars. In 2010, all measures were further strengthened.

Goal

The underlying goal is to reduce greenhouse gas emissions. Initially it was achieved by efficiently using energy. In BCA 2010, this was broadened to also require that equipment use a low greenhouse intensity energy source.

It should also be noted that the goal is not occupant comfort directly. The measures are based on achieving an internal environment in which occupants may not always be comfortable, but the conditions are sufficiently tolerable for occupants to minimise their use of services including artificial heating, cooling or lighting.

The energy used over the life of a building has an operational energy component and an embodied energy component. Operational energy is the focus of the ABCB at this time; broader environmental sustainability measures are being considered by governments.

Functional Statement JF1

JF1

JF1 refines the intention of **JO1**.

The Functional Statement has two parts. The first outlines that a building is to be capable of efficiently using energy. The word “capable” is important, as energy consumption in a building is highly dependent on how the building is used. Energy efficiency cannot be assured simply by ‘building-in’ appropriate measures, as the building also needs to be operated, managed and maintained in an appropriate way.

The second part addresses the need for a low greenhouse gas intensity source or a renewable source of energy.

The greenhouse gas intensity of energy sources vary. For example, natural gas has a low greenhouse gas intensity compared with electricity generated from coal.

For the purposes of **Section J**, the renewable energy source must be on-site (so not Greenpower) and includes solar, geothermal, wind and bio-fuels.

Heat reclaimed from another source includes the heat recovered for water heating and water chilling from co-generation type processes as well as other industrial processes.

Performance Requirements

JP1

Efficient use of energy

JP1 refines the intention of **JO1** and covers those aspects of the building fabric and services that are to be considered for the building to achieve the required thermal performance. The words “envelope” and “services” are italicised in the text to indicate that they are terms defined in the BCA, specifically for the BCA use and context (the definition may not be appropriate in another context).

‘To the degree necessary’

The term “to the degree necessary” has been included because:

- there may be a minimum energy consumption below which it may be unnecessary or impractical to regulate; or
- there may be some building types for which it may be unnecessary or impractical to regulate; or
- some of the features may not be appropriate for some building types.

It may also be inappropriate to require energy efficiency in some instances, for example where there may be a conflict with safety or health requirements.

When considered in conjunction with **JP1(h)**, the term “to the degree necessary” may be used to justify an Alternative Solution that utilises renewable energy sources.

‘Facilitate’

The term "facilitate" is used in **JP1** to highlight the need to consider the installation of energy efficiency measures in a building where there is likelihood that an artificial heating or cooling system will be installed in the building irrespective of the initial design.

The term also indicates that energy efficiency is not assured but may only be achieved if the building is operated, managed and maintained correctly.

‘Permanent’

In **JP1(d)** the term ‘permanent’ is used to describe features that will have a long term impact on the building. This includes natural features of the landscape, such as mountains and escarpments, while permanent man made features would include buildings likely to be in place for a long period of time.

‘The energy source of the services’

JP1(h) permits the energy source of the service to be considered. This means that the net energy obtained for services from renewable energy sources such as solar, geothermal, wind and bio-fuels may be considered as "free" energy in calculating the energy consumption. Similarly, heat reclaimed from another “free” source such as a by-product from co-generation type processes as well as other industrial processes, which would otherwise be rejected from the building could be considered as "free" energy in calculating the energy consumption.

JP2

A separate Performance Requirement has been included for the provision of features that facilitate maintenance. This Performance Requirement relates to **IP2.1**. However, where **IP2.1** requires the maintenance of components essential for the efficient use of energy, the intention of **JP2** is to ensure that adequate provision is made for such maintenance to be carried out.

JP2 does not apply to the services of a sole-occupancy unit in a Class 2 building or of a Class 4 part of a building. This is consistent with not applying maintenance requirements to Class 1 buildings, i.e. private residences.

JP3

JP3 addresses the greenhouse gas pollution potential of the energy source and requires the source to be of a low greenhouse gas intensity such as natural gas or renewable energy sources such as solar, wind or geothermal, in preference to electricity or oil. Accordingly, for the purposes of the BCA, Greenpower is not an on-site renewable energy source.

Reject heat may be from a refrigeration chiller, a co-generation type process, or industrial process equipment.

Note that this requirement only applies to heating and not cooling, lighting or other services which still require electricity.

Verification Methods

JV1 * * * * *

The content of **JV1**, which existed in BCA 2009, has been relocated to **J0.2**. The Verification number **JV1** has been retained without text so as not to change the numbering of the current BCA from that of BCA 2009.

JV2 * * * * *

The content of **JV2**, which existed in BCA 2007, has been removed. The Verification number **JV2** has been retained without text so as not to change the numbering of the current BCA from that of BCA 2007.

JV3 Verification using a reference building for a Class 3 building

This Verification Method compares the energy consumption of a proposed building to the energy consumption of a reference building based on the Deemed-to-Satisfy Provisions. If the energy consumption of the proposed building does not exceed the energy consumption of the reference building, compliance with **JP1** is achieved.

Through this modelling process, it must be demonstrated that an Alternative Solution is equivalent to, or better than, the Deemed-to-Satisfy Provisions. This equivalency is also one of the Assessment Methods recognised in the BCA.

JV3 includes provisions in **JV3(a)(ii)** designed to protect the thermal performance of the building's envelope from "trading" off its performance.

The steps to using this Verification Method are:

1. Determine the annual energy consumption allowance by modelling a reference building, i.e. a Deemed-to-Satisfy complying building based on the criteria in **JV3(d)**.
2. Calculate the theoretical annual energy consumption of the proposed Alternative Solution using either the subject building's criteria or that in **Specification JV**.
3. Calculate the theoretical annual energy consumption of the proposed Alternative Solution, with the services modelled as if they were the same as that of the reference building.
4. Compare the theoretical annual energy consumption calculated in steps 2 and 3 to the annual energy consumption allowance calculated in step 1 to ensure that in both cases, the annual energy consumption is not more than that allowed.

The same software must be used in all modelling runs.

JV3 can be used for all buildings using the occupancy profiles and other assumptions appropriate for the subject building or those provided in **Specification JV**.

JV3(d)(i)(E) permits the profiles and internal heat loads of the proposed buildings to be used in the calculations provided the operating hours are not less than 2,500 per year. The profiles and loads of **Specification JV** need only be used if the hours of operation are less than 2,500 per

year. Alternatively, the profiles and loads of **Specification JV** can be used in all cases. The reason for permitting the expected profiles and internal loads of the proposed building to be used is that, provided the numbers of hours of operation are reasonable, different hours and loads have minimal impact on the modelled outcome as the same values must be used in assessing the reference building as well as the proposed building.

JV3(g) requires the Alternative Solution to be able to achieve all the criteria used in the annual energy consumption calculation method. This means that the solution must include such features as a time switch that is capable of turning lighting and air-conditioning plant on and off in accordance with the occupancy and operating profiles used. It also means that the method or software for calculating the annual energy consumption must be capable of modelling all Deemed-to-Satisfy Provisions in Parts **J1** to **J7**. If the software does not have provisions for, say an "occupant activated device" in a Class 3 building, then the Alternative Solution demonstrated to be compliant using **JV3** would still need to include that device.

The following flowchart illustrates how **JV3** can be used to assess different Alternative Solutions.

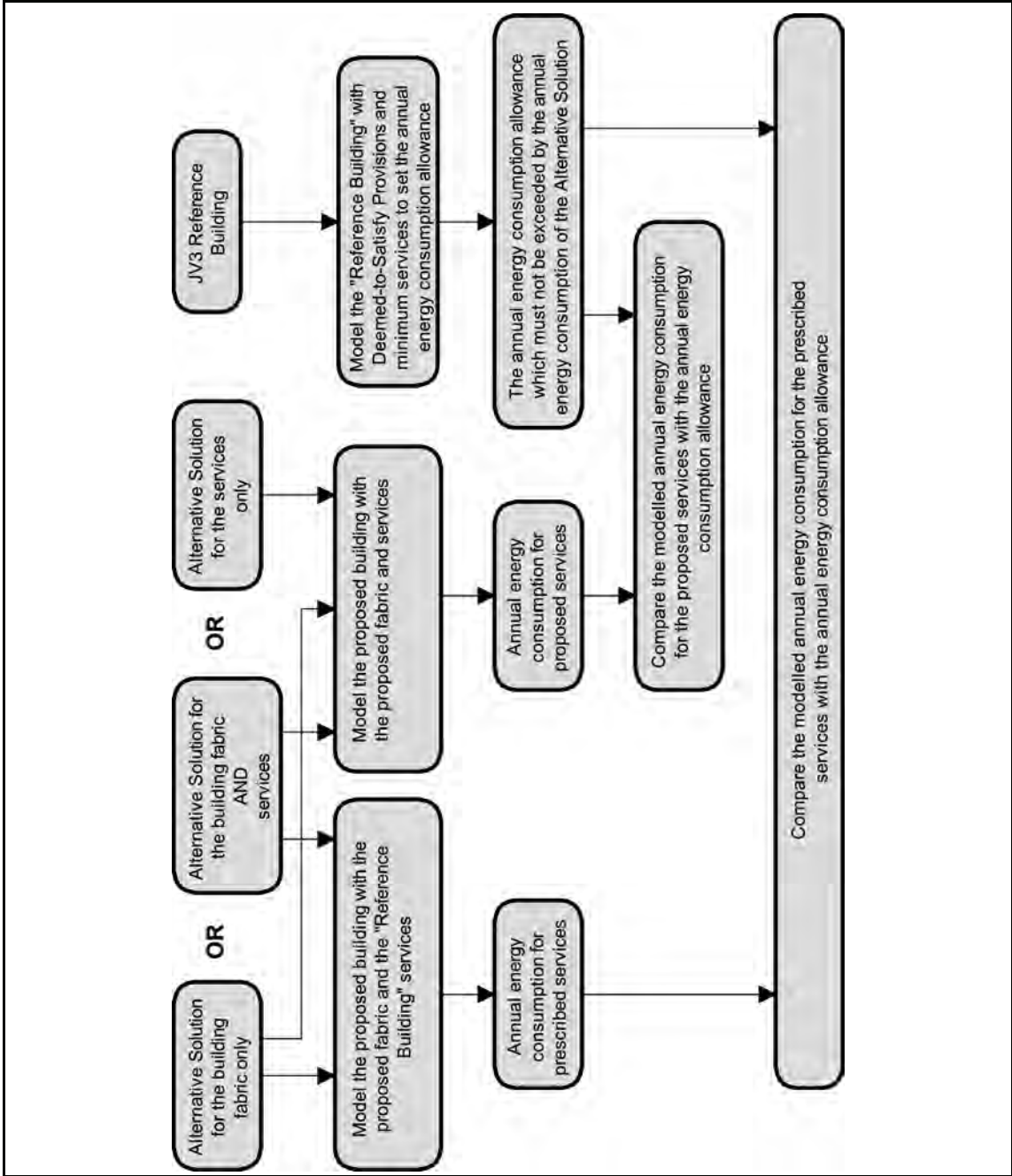

SPECIFICATION **JV**

ANNUAL ENERGY CONSUMPTION
CALCULATION

1. Scope

Intent

To clarify the requirements of the calculation for the annual energy consumption of services.

2. Annual energy consumption of services

Intent

To outline the inclusions in the method of calculation of annual energy consumption.

The Specification sets out a standard procedure for calculating annual energy consumption. Although the values stated may not be those actually achieved in some buildings, they are considered the most typical. They do not have to be used as part of the Verification Method provided the operating hours of the building per year used in the calculation are not less than 2,500 hours (see **JV3(d)(i)(E)(aa)**).

Table 2a to **2g** provide occupancy and equipment operation profiles for different building classifications and uses. Those for office buildings are the same as those used in the Australian Building Greenhouse Rating Scheme (ABGR) with respect to people and air-conditioning but not for lighting and office equipment. ABGR has higher values for equipment use.

PART J0 Energy Efficiency

Deemed-to-Satisfy Provisions

J0.0 Deemed-to-Satisfy Provisions

Intent

To clarify that **JP1** and **JP3** will be satisfied if compliance is achieved with Parts **J1** to **J7**.

Where a Building Solution is proposed to comply with the Deemed-to-Satisfy Provisions, **J0.0** clarifies that compliance with Parts **J1** to **J7** achieves compliance with **JP1** and **JP3**.

Where a Building Solution is proposed as an Alternative Solution to the Deemed-to-Satisfy Provisions, the relevant Performance Requirements must be determined in accordance with **A0.10**. (See comment on **A0.10**).

The Deemed-to-Satisfy Provisions described are limited to the most common forms of construction and the simplest forms of buildings. It is expected that the more innovative construction techniques and the more complex buildings will be designed and assessed using a performance approach.

The measures have been developed using a cost-effectiveness model.

A major consideration in developing the measures was the likelihood of a building being heated or cooled by an air-conditioning system, and whether the Deemed-to-Satisfy Provisions should assume this to be the case, or only apply the provisions if a heating or cooling system is installed. It is recognised that most Class 3, 5, 6 and 9 buildings and some Class 7 and 8 buildings are heated or cooled, and this is the basis of the provisions. Consideration was also given to the fact that although the first owner may be prepared to 'manage' their building in the appropriate manner, the next owner or tenant may not, and instead may install air-conditioning.

Because of the performance-based structure of the BCA, an Alternative Solution may be proposed instead of the Deemed-to-Satisfy Provisions.

J0.1 Application of Section J

Intent

To clarify which provisions of Section J apply to dwellings and which provisions apply to other buildings.

J0.1 explains which provisions need to be complied with for—

- a sole-occupancy unit of a Class 2 building or a Class 4 part; and
- all other classifications.

J0.1(a) explains that, for the thermal performance of the building fabric, there are two paths for compliance depending on whether the building contains dwellings (i.e. sole-occupancy units in a Class 2 building or a Class 4 part) or not. For the fabric of dwellings, compliance must be in

accordance with **J0.2** while for other uses, compliance must be in accordance with **Parts J1** to **J3**. For services, all building must comply with **Parts J5** to **J8**.

All buildings must comply with **J0.1(b)** to **(e)**, including sole-occupancy units of a Class 2 building or Class 4 part, due to these matters not being assessed by software complying with the ABCB Protocol for House Energy Rating Software.

The means of compliance is explained in **Figure J0.1**.

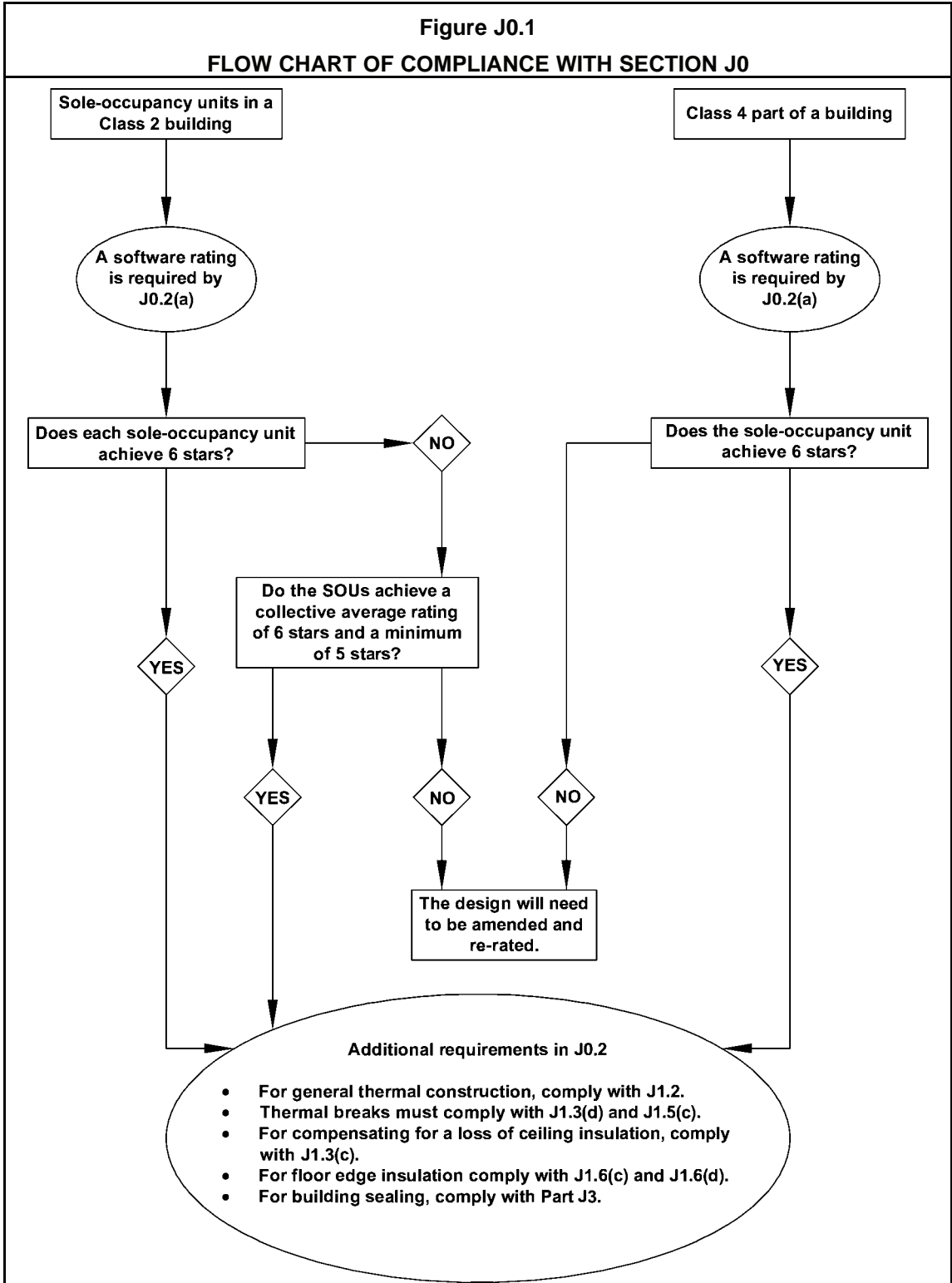

J0.2 Reducing the heating and cooling loads of a sole-occupancy unit of a Class 2 building or a Class 4 part

Intent

To clarify how the shell of a sole-occupancy unit of a Class 2 building or a Class 4 part are to comply.

In order to reduce the heating or cooling loads, the fabric of a sole-occupancy unit of a Class 2 building or a Class 4 part must achieve the required house energy rating. It must also comply with a few general Deemed-to-Satisfy Provisions relating to the insulation standard, installation of insulation, thermal breaks, sealing, etc.

The measures for a sole-occupancy unit of a Class 2 building or a Class 4 part of a building are similar to those adopted for Class 1 buildings in BCA Volume Two - Housing Provisions. There are several reasons for this, including:

- Many Class 2 and 4 buildings are very similar in thermal performance to Class 1 buildings.
- Being dwellings, there are similarities in their use with high occupancy at night.
- Having all types of dwellings achieving comparable performance provides a consistent approach.

J0.3 Ceiling fans

Intent

To set the minimum requirements for ceiling fans.

A ceiling fan may be required to provide high air movement as part of a house energy rating software solution and two sizes of fans are described in terms of their diameter and the floor area they serve.

PART J1 BUILDING FABRIC

Deemed-to-Satisfy Provisions

J1.0 Deemed-to-Satisfy Provisions

Intent

To clarify that **JP1** and **JP3** will be satisfied if compliance is achieved with Parts **J1** to **J7**.

See comments for Deemed-to-Satisfy Provisions of **J0.0**.

J1.1 Application of Part

Intent

To facilitate the efficient use of energy appropriate for Class 2 to 9 buildings that are conditioned or likely to be conditioned.

The rationale behind exempting Class 7, 8 and 9b buildings that do not have a conditioned space is explained under the definition of a conditioned space. Class 9b buildings cover a wide range of uses and some could reasonably be expected to be air-conditioned at some time in the future while others may not. For example, it may be unlikely that a school gymnasium will be air-conditioned while classrooms may well be when funds are available. Some States are already retrofitting air-conditioning to schools. Note that the phrase "likely by the intended use of the space to be air-conditioned" is in the definition of a conditioned space.

The other exemption is the external elements of an atrium or solarium that is not a conditioned space. The atrium may be attached to a Class 5 building and would otherwise attract some of the requirements appropriate for a Class 5 building. Again, either there is no energy saving to be made by thermally treating the elements, or the saving is below the minimum threshold and so not cost-effective.

J1.2 Thermal construction — general

Intent

To outline the general requirements to insulate a building's fabric and the inherent thermal properties of roof, ceiling, wall and floor materials.

Testing

J1.2(a) requires that insulation must be tested in accordance with AS/NZS 4859.1.

Installation

Care should be taken when installing insulation to ensure a continuous envelope between a conditioned space and either the outside environment or a non-conditioned space.

Insulation is to be fitted tightly to each side of framing members but need not be continuous over the framing member. The Total R-Value requirements in [J1.3](#), [J1.5](#) and [J1.6](#) are calculated for parts of the roof, walls or floor that are clear of any framing members.

The provisions also state that the installation of insulation should not interfere with the safety or performance of domestic services and fittings such as heating flues, recessed light fittings, transformers for low voltage lighting, gas appliances and general plumbing and electrical components. This includes providing appropriate clearance as detailed in relevant legislation and referenced standards such as for electrical, gas and fuel oil installations. Low voltage lighting transformers should not be covered by insulation and be mounted above the insulation rather than on the ceiling. Expert advice may also be needed on how much bulk insulation can be placed over electrical wiring.

Note that the addition of insulation to other building elements may alter the fire properties of those elements. Re-testing or re-appraisal of these elements may be required.

Airspace adjoining reflective insulation

For reflective insulation to achieve its tested R-Value, the airspace adjoining the insulation needs to be a certain width. This width varies depending on the particular type of reflective insulation and the R-Value to be achieved.

Where the width of airspace is to be achieved in a wall cavity or the like, care should be taken to ensure compliance with all other applicable BCA provisions. For example, the provisions relating to weatherproofing masonry may require a greater width of cavity.

Compression of bulk insulation

The R-Value of bulk insulation is reduced if it is compressed. The allocated space for bulk insulation is therefore to allow the insulation to be installed so that it maintains its correct thickness unless exempted such as at wall studs. This is particularly relevant to wall and cathedral ceiling framing whose members can only accommodate a limited thickness of insulation. In some instances, larger framing members or thinner insulation material, such as polystyrene boards, may be necessary to ensure that the insulation achieves its required R-Value.

Artificial cooling

Artificial cooling of buildings in some climates can cause condensation to form inside the layers of the building envelope. Such condensation can cause significant structural or cosmetic damage to the envelope before it is detected. Associated mould growth may also create health risks to the occupants. Effective control of condensation is a complex issue. In some locations a fully sealed vapour barrier may need to be installed on the more humid, or generally warmer, side of the insulation.

J1.3 Roof and ceiling construction

Intent

To clarify the minimum Total R-Value that is to be achieved by a roof or ceiling, according to the building classification and climate zone in which it is located.

[J1.3](#) covers roofs, including their ceilings, and any ceiling that is part of an intermediate floor being part of the building's envelope, or where there is no ceiling.

[J1.3 \(a\)](#) and [Table J1.3a](#) detail the insulation properties required of a roof or ceiling. [Table J1.3a](#) provides the minimum Total R-Value to be achieved by the roof or ceiling.

Part or all of this may be provided by the roof construction itself and any inherent insulating property of the roof and airspaces reduces the amount of insulation needed.

A ceiling that is part of the envelope but is below a non-conditioned space such as a plant room is covered in **J1.6**.

The direction of heat flow stated should not be taken as the only direction in which any insulating properties operate but it is a statement of the prominent direction for that particular climate zone. It is assumed that materials, be they construction materials or insulating materials, will also have insulating properties in the other direction. For a residential building, the night time direction is important as the building is most likely to be occupied at that time and the outside temperature likely to be the lowest of the day.

The Total R-Value in **Table J1.3a** is dependant on the climate zone and also the colour of the roof. A light colour is beneficial in a hot climate. An industry recognised international standard for testing absorptance is ASTM E903. Typical thermal absorptance values using that standard are provided below.

Typical Absorptance Values

Colour	Value
Slate (dark grey)	0.90
Red, green	0.75
Yellow, buff	0.60
Zinc aluminium — dull	0.55
Galvanised steel — dull	0.55
Light grey	0.45
Off white	0.35
Light cream	0.30

Because of the high thermal conductance of metal, a thermal break is required by **J1.3(d)** where the ceiling lining of a building is fixed directly to the underside of the metal purlins or metal battens of a metal sheet roof, or where there is no ceiling. The purpose of the thermal break is to ensure that the thermal performance of this form of roof construction is comparable to that of a similar roof with timber purlins or timber battens. This is only required where a metal roofing member has the roofing directly on one side of the member and the ceiling lining directly on the other side of the same member, or no ceiling at all. Once there are two members perpendicular to each other, such as battens and rafters, there is no requirement for a thermal break.

A thermal break may be provided by materials such as 20 mm thick timber or 12 mm thick expanded polystyrene strips, plywood or bulk insulation. The material used as a thermal break must separate the metal purlins or metal battens from the metal sheet roofing and achieve an R-Value of not less than 0.2. Reflective insulation alone is not suitable for use as a thermal break because it requires an adjoining airspace to achieve the specified R-Value.

The loss of ceiling insulation because of downlights, fans and other penetrations means that more energy is lost unless the amount of insulation on the remainder of the ceiling is proportionately increased. **J1.3(c)** requires such compensation. **Table J1.3(b)** contains a minimum "free" allowance.

When considering the loss of insulation because of exhaust fans and recessed downlights, 0.5% of the ceiling area for a 200 m² dwelling would permit 2 bathroom heater-light assemblies, a laundry exhaust fan, a kitchen exhaust fan and either approximately 20 recessed downlights

with 50 mm clearance to insulation, 10 recessed downlights with 100 mm clearance to insulation or only 3 recessed downlights with 200 mm clearance to insulation. It should also be noted that **Table J1.3b** uses the R-Value of the insulation located on the ceiling and is not the Total R-Value required of the roof. The roof has an inherent R-Value and there may also be insulation at the roof line. Note that the table is in R-Value and not Total R-Value.

It should be noted that **J1.3(c)** does not require an increase in ceiling insulation for roof lights.

The weight of roof or ceiling insulation needs to be considered in the selection of plasterboard, plasterboard fixings and building framing.

Details of the Total R-Values of typical constructions are provided in **Specification J1.3**.

J1.4 Roof lights

Intent

To specify requirements for roof lights and provide a reasonable distribution of the roof lights.

J1.4 has values for SHGC and Total U-Values, which are expressed in accordance with the Australian Fenestration Rating Council (AFRC) protocol.

The provisions of **J1.4(a)** require roof lights that form part of the envelope, other than of a sole-occupancy unit of a Class 2 building or a Class 4 part of a building to comply with **Table J1.4**.

J1.4(b) addresses the specific situation where a roof light is needed to meet the requirements of **Part F4**. The allowable area, SHGC and Total U-Value are all relaxed.

Table J1.4 provides the requirements that satisfy **J1.4(a)**.

Table J1.4 contains SHGC and Total U-Values for roof lights with or without a ceiling diffuser. A roof light may achieve the required performance on its own or in conjunction with a ceiling diffuser.

The SHGC and Total U-Values for some simple types of roof light are shown in the tables below. Smaller numbers indicate better glazing element performance. The tables give worst case assessments, which can be improved by obtaining custom product assessments from suppliers, manufacturers, industry associations (including their online resources) and from competent assessors.

WORST CASE WHOLE ROOF LIGHT ELEMENT PERFORMANCE VALUES WITHOUT A CEILING DIFFUSER OR WITH A PERFORATED CEILING DIFFUSER				
Translucent or transparent element description	Domed panel		Flat, framed panel	
	<i>SHGC</i>	<i>Total U-Values</i>	<i>SHGC</i>	<i>Total U-Values</i>
Single layer clear	0.80	8.4	0.79	8.0
Single tinted	0.66	8.4	0.63	7.9
Single layer translucent ("opal")	0.57	8.4	0.56	7.9
Double layer clear	0.71	5.4	0.70	4.9

WORST CASE WHOLE ROOF LIGHT ELEMENT PERFORMANCE VALUES WITH AN IMPERFORATE CEILING DIFFUSER				
----------------------------------------------------------------------------------------------------	--	--	--	--

Translucent or transparent element description	Domed panel		Flat, framed panel	
	SHGC	Total U-Values	SHGC	Total U-Values
Single layer clear	0.72	4.3	0.71	4.2
0.59	0.59	4.3	0.57	4.2
Single layer translucent ("opal")	0.51	4.3	0.50	4.2
Double layer clear	0.64	3.4	0.63	3.2

J1.5 Walls

Intent

To specify the requirements for walls, both external and internal, that are a part of the envelope.

Tables J1.5a and J1.5b provide options for walls, including both external walls and internal walls that, because they are part of the building's envelope, need to have insulating properties. The provision is structured with a required minimum Total R-Value for external walls in J1.5(a) and Table J1.5a which may be reduced in some climate zones for:

- Wall materials of 220 kg/m² surface density and different thermal conductivity values.
- Shading.
- Light coloured walls.
- Improved glazing performance.

A below ground, backfilled wall is exempted in most climate zones. Modelling has shown that only in climate zone 8 does a wall below ground need insulation. In all other instances it provides thermal stability and usually some free cooling.

Opaque curtain walls are considered as walls and so are to meet the Total R-Values for walls. Transparent or translucent elements are considered as glazing because of the solar energy they permit to enter the space.

Shading

For complying with the shading requirement, note that the shading projection for walls is measured from the wall face whereas for glazing the projection is measured from the glass face.

Gutters can only be considered as providing shading if attached to a building projection such as a verandah, fixed canopy, eaves, shading hood, balcony or the like. On their own they are likely to be well above the head of the window and so not likely to produce any significant shading.

High mass walls

Walls with a surface density of 220 kg/m² or more provide an enhanced level of thermal performance in certain climate zones. This is related to their ability to store heat and therefore slow its transfer through the building fabric. These walls are defined by surface density (kg/m²) to reduce the complexity when measuring mass walls with voids (surface density is the mass of one vertical square metre of wall).

As a result of thermal modelling, it has been found that because commercial buildings are more likely to be air-conditioned for long periods, the high mass option is not as beneficial as it is for houses. However, it still offers a benefit, particularly in the temperate climates. Thermal conductivity is the property of a material from which R-Value is derived by dividing the thickness of the material by the thermal conductivity. In some climate zones, a high mass wall may still require some insulation, but less than the insulated framed wall would require. Note also that the options in [Table J1.5a](#) requiring a slab-on-ground, would only apply to the walls on the ground floor.

The following are examples of some typical wall constructions that achieve a surface density of 220 kg/m²:

- Two leaves each of 90 mm thick or greater, clay or concrete masonry.
- 140 mm thick or greater, dense-weight hollow concrete or clay blocks with—
 - 10 mm plasterboard or render;
 - at least one concrete grouted horizontal bond beam; and
 - vertical cores filled with concrete grout at centres not exceeding 1000 mm.
- 140 mm thick or greater, concrete wall panels and dense-weight hollow concrete or clay blocks with all vertical cores filled with concrete grout.
- 190 mm thick or greater, dense-weight hollow concrete or clay blocks with—
 - at least one concrete grouted horizontal bond beam; and
 - vertical cores filled with concrete grout at centres not exceeding 1800 mm.
- Earth-wall construction with a minimum wall thickness of 200 mm.

[Table J1.5a](#) also contains an option for walls using furring channels, which consequently cannot accommodate the insulation required to achieve the Total R-Value. In this case, the furring channels can still be used provided the more stringent glazing energy index is used. This is effectively trading between the thermal performance of walls and glazing without using a Verification Method.

Thermal bridging

Because of the high thermal conductance of metal, a thermal break is required when a metal framed wall is clad with weatherboards, cement sheeting, or the like. This is only required where a metal framed wall member has the cladding directly on one side of the member and the lining directly on the other side of the same member, or where there is no wall lining. The purpose of the thermal break is to ensure that the thermal performance of the metal framed wall is comparable to that of a similarly clad timber framed wall. The thermal break must separate the metal frame from the cladding and achieve an R-Value of not less than 0.2.

A thermal break may be provided by materials such as timber battens, plastic strips or polystyrene insulation sheeting. For the purposes of [J1.5\(c\)](#), expanded polystyrene strips of not less than 12 mm thickness and timber of not less than 20 mm thickness are deemed to achieve an R-Value of not less than 0.2. There is also some bridging occurring in brick veneer walls but it is not as severe as in lightweight framed walls.

Internal walls

Internal walls that are part of the building's envelope, i.e. that separate a conditioned space from a non-conditioned space, require less insulation than an external wall that is part of the envelope.

Envelope walls, other than external walls, are covered by [J1.5\(b\)](#) and [Table J1.5b](#) and the values are based on the degree to which the space is ventilated.

J1.6 Floors

Intent

To outline the minimum insulation requirements for suspended floors and concrete slabs on ground.

The required Total R-Values are in [Table J1.6](#). However, these values can be reduced in climate zones 1 to 6 provided the Total R-Value achieved by the roof is increased to compensate (refer [J1.6\(b\)](#)). For example, if a Total R-Value of 1.5 is required and the floor is a suspended untreated concrete slab with an R-Value of 0.29 downwards and 0.5 of the required Total R-Value is compensated by adding R0.75 to the roof, the added floor insulation R-Value only needs be 0.71. This could be achieved by installing a range of products including reflective insulation, bulk insulation boards or bulk insulation batts on a plasterboard or fibre cement ceiling. This concession is straightforward for a single storey building with one roof and one floor. For a multi-storey building with a series of envelopes around plant rooms at different levels, the concession only applies between the roof and the floor that makes up one envelope, i.e the uppermost envelope.

The Total R-Value required by [J1.6](#) will depend on whether the space above or below is enclosed and the amount of ventilation to that space. For example, even if a carpark is mainly enclosed except for an open ramp, the carpark will be ventilated by more than 1.5 air changes of outside air so being enclosed or unenclosed is, in this case, irrelevant.

An enclosed perimeter means that the lowest floor of a building has a space below which is enclosed by slab-to-slab cladding or walls. The ground-to-floor cladding can have the required sub-floor vents and still be considered enclosed.

Only in alpine areas is insulation required underneath an unheated slab as well as at the edge. However, a heated slab needs insulation underneath and at the edge.

A local under-tile or in-screed heating system in a bathroom, amenity area or the like is not considered to be an in-slab heating system.

Regarding the installation of slab edge insulation in [J1.6\(d\)](#), care should be taken to ensure that the insulation is compatible with the type of termite management system selected.

PART J2

GLAZING

Deemed-to-Satisfy Provisions

J2.0 Deemed-to-Satisfy Provisions

Intent

To clarify that the requirements of **JP1** and **JP3** will be satisfied if a building complies with Parts **J1** to **J7**.

See comments for Deemed-to-Satisfy Provisions of **J0.0**.

J2.1 Application of Part

Intent

To clarify that the **Deemed-to-Satisfy** Provisions of **Part J2** do not apply to—

- a sole-occupancy unit of a Class 2 building or Class 4 part; or
- a Class 7, 8 and 9b building that does not have a conditioned space or where an air-conditioning system needs less than 15 Watts of input power per square metre of the floor area;
- an atrium or solarium that is not a conditioned space.

The Deemed-to-Satisfy Provisions of **Part J2** do not apply to a sole-occupancy unit of a Class 2 building or Class 4 part. This is a consequence of sole-occupancy units in a Class 2 building or Class 4 part of a building being covered by **J0.2**.

See comments for Deemed-to-Satisfy Provisions of **J1.1**.

J2.2 * * * * *

The content of **J2.2**, which existed in BCA 2009, has been removed. The provision number **J2.2** has been retained without text so as not to change the numbering of the current BCA from that of BCA 2009.

J2.3 * * * * *

The content of **J2.3**, which existed in BCA 2009, has been removed. The provision number **J2.3** has been retained without text so as not to change the numbering of the current BCA from that of BCA 2009.

J2.4 Glazing

Intent

To reduce air-conditioning energy consumption attributable to glazing.

By referring to glazing, **J2.4** requires Total U-Values and SHGCs to be assessed for the combined effect of the glass and frame. The measurement of these Total U-Values and SHGCs is specified in the Technical Manual and Procedures Protocol for Energy Rating of Fenestration Products of the Australian Fenestration Rating Council (AFRC) which has been derived from the United States of America National Fenestration Rating Council (NFRC).

Glazing performance and evidence of suitability

Total U-Values and SHGCs are shown for some simple types of residential glazing elements in the table below. (Smaller numbers indicate better glazing element performance). The table gives worst case assessments of glazing elements, which can be improved by obtaining custom product assessments from suppliers, manufacturers, industry associations (including their online resources) and from competent assessors. Custom assessments consider glazing element components in more detail and return the highest levels of assessed performance for a given type of glazing element.

WORST CASE WHOLE RESIDENTIAL GLAZING ELEMENT PERFORMANCE VALUES				
Glass description	Aluminium framing		Timber or uPVC framing	
	Total U-Value	SHGC	Total U-Value	SHGC
Single clear	7.9	0.81	5.6	0.77
Tinted single	7.9	0.65	5.6	0.61
Clear double (3/6/3)	6.2	0.72	3.8	0.68

Typical ranges of generic ratings are set out in the table below to illustrate the levels of performance available through such assessments. Numbers from this table should not be used in compliance calculations.

INDICATIVE RANGES OF WHOLE RESIDENTIAL GLAZING ELEMENT PERFORMANCE VALUES					
Glass description	Comment	Aluminium framing		Timber or uPVC framing	
		Total U-Value range	SHGC range	Total U-Value range	SHGC range
Single (monolithic or laminated)					
Clear	Minimal variation in glass U-Value and SHGC for different glass thicknesses.	7.9 - 5.5	0.81 – 0.64	5.6 – 4.3	0.77 – 0.51
Tinted	Glass SHGC depends on glass thickness and type of tint.	7.9 – 5.6	0.65 – 0.33	5.6 – 4.3	0.61 – 0.25
Coated	Glass U-Value and SHGC depend on coating type.	7.8 – 3.8	0.68 – 0.36	5.5 – 2.9	0.64 – 0.27

INDICATIVE RANGES OF WHOLE RESIDENTIAL GLAZING ELEMENT PERFORMANCE VALUES					
Glass description	Comment	Aluminium framing		Timber or uPVC framing	
		Total U-Value range	SHGC range	Total U-Value range	SHGC range
Tinted + coated	Glass U-Value depends on coating type. Glass SHGC depends on coating type, type of tint and glass thickness.	7.8 – 3.8	0.45 – 0.31	5.5 – 3.1	0.42 – 0.23
Double					
Clear	Glass U-Value depends on cavity width.	6.2 – 3.1	0.72 – 0.63	3.8 – 2.5	0.68 – 0.47
Tinted	Glass U-Value depends on cavity width. Glass SHGC depends on type of tint, tinted glass thickness and cavity width.	6.2 – 3.1	0.57 – 0.36	3.8 – 2.5	0.57 – 0.27
Coated	Glass U-Value depends on cavity width and type of coating. Glass SHGC depends on type of coating and cavity width.	6.1 – 2.4	0.60 – 0.22	3.8 – 2.1	0.59 – 0.17
Tinted + coated	Glass U-Value depends on cavity width and type of coating. Glass SHGC depends on type of coating, tinted glass thickness and cavity width.	6.1 – 2.5	0.41 – 0.21	3.8 – 2.1	0.37 – 0.16

This calculation method is based on an annual dynamic simulation of energy consumption. It is intended for buildings which are fully air-conditioned and have a high day time use. It is about controlling the annual air-conditioning energy consumption, rather than reducing the impact of seasonal peak heating and cooling loads. As the main consideration is to reduce the energy consumed by air-conditioning plant over the year, the factors in the formula also make provision for the various efficiencies of the likely heating and cooling plant.

The calculation lends itself to being expressed in a spreadsheet and is a single formula that covers the total air-conditioning energy consumption for the full year (although the heating and cooling components can be recognised within the formula).

As the relationships are approximately linear, they are expressed arithmetically with a series of constants.

There are different indices in [Table J2.4a](#) for Class 3 buildings, other classes of buildings and display glazing. There are also two stringency options; Option A for most applications and Option B for a wall with less insulation than would otherwise be required (see [Table J1.5a](#)).

The energy indices in [Table J2.4a](#) have been developed on the basis of a facade height equal to the depth of the air-conditioning system's perimeter zone. If this is not the situation with the

proposed design, some of the solar load may be handled by an internal zone possibly leading to poor temperature control in the internal zone. The facade area is based on the occupied floor facade and does not include wall area associated with roof-top plant rooms, parapets or interstitial floors in laboratories or hospitals.

Glazing in the internal fabric of a building, such as between a conditioned office and an unconditioned factory or bulk store, is to be assessed using the appropriate value for the south orientation sector in **Tables J2.4b, J2.4c and J2.4d** with a P/H of 2.0 when determining the shading multipliers. This provides values equivalent to maximum shading.

Example

The following is an example of how these provisions are applied in a north wall of a multi-storey office building in climate zone 4. The proposed facade is 150 m² in area. The facade contains 1 window 2.8 m high and 3.0 m wide (8.4 m² area) with a 1 m projection 200 mm above the window and 8 windows each of 3 m² with no projection. All the glazing is proposed as single glass toned [Total U-Value of glazing (glass and frame) is 6.9 and Solar Heat Gain Coefficient of the glazing (glass and frame) is 0.6].

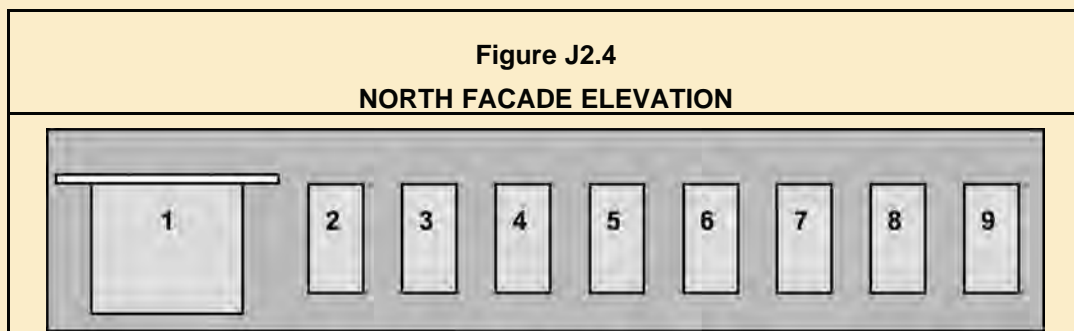

The allowance for the aggregated air-conditioning energy value = 150 x 0.142 (from **Table J2.4a** Energy index option A) = 21.3

The air-conditioning energy value for each glazing element is calculated using the formula:

$$A_1 [SHGC_1 (C_A \times S_{H1} + C_B \times S_{C1}) + C_C \times U_1]$$

where—

A_1 = the area of glazing element 1

$C_{A, B, \& C}$ = the energy constants A, B and C for the specific orientation from **Table J2.4b**

$SHGC_1$ = the SHGC of glazing element 1

S_{H1} & S_{C1} = the heating shading multiplier and cooling shading multiplier for the glazing element 1 obtained from **Table J2.4c** and **Table J2.4d** respectively

U_1 = the Total U-Value of glazing element 1

For window 1: P/H = 1.0/3.0 i.e. 0.33

Hence $S_{H1} = 0.98$ and $S_{C1} = 0.82$ (interpolating values between P/H = 0.2 and 0.8)

Thus $A_1 [SHGC_1 (C_A \times S_{H1} + C_B \times S_{C1}) + C_C \times U_1]$

$$\begin{aligned}
 &= 8.4 [0.6 (-0.16 \times 0.98 + 1.25 \times 0.82) + 0.0 \times 6.9] \\
 &= 8.4 [0.6 (-0.157 + 1.025)] \\
 &= 8.4 \times 0.6 \times 0.868 \\
 &= 4.37
 \end{aligned}$$

For window 2: $A_2 [SHGC_2 (C_A \times S_{H2} + C_B \times S_{C2}) + C_C \times U_2]$

$$\begin{aligned}
 &= 3.0 [0.6(-0.16 \times 1.0 + 1.25 \times 1.0) + 0.0 \times 6.9] \\
 &= 3.0 [0.6(-0.16 + 1.25)] \\
 &= 3.0 \times 0.654 \\
 &= 1.96
 \end{aligned}$$

For all windows:

$$\begin{aligned}
 &= 4.37 + (8 \times 1.96) \\
 &= 20.1
 \end{aligned}$$

As the calculated aggregate air-conditioning energy value for the glazing, at 20.1, is less than the aggregated air-conditioning energy value allowance of 21.3, the glazing complies.

Note that the ABCB has produced a glazing calculator to assist with the above calculations.

J2.5 Shading

Intent

To prescribe the shading projections and devices that may be used to achieve compliance with **J2.4**.

The presence of shading projections and devices will reduce the level of thermal performance that is required of glazing. However, to be effective, shading projections and devices must restrict a significant proportion of solar radiation.

Permanent projections, such as verandahs, balconies, fixed canopies, eaves or shading hoods, must have a means of restricting the amount of solar radiation that reaches the glazing from the sides of the feature. Hence, the requirements in **J2.5(a)** for the feature to extend either side of the glazing or to have a reveal or similar shading element at the side of the shading feature.

External shading devices, such as shutters, blinds, vertical or horizontal building screens are required by **J2.5(b)** to be capable of restricting the amount of summer solar radiation that reaches the glazing by at least 80%. This is the sum of the amount of hour-by-hour summer (December, January, February) solar radiation that does not reach the glazing as a percentage of what would have reached the glazing if the shading device was not fitted.

The amount of summer solar radiation that reaches the window may be measured cumulatively over the three month period December to February if a fixed device is used, alternatively if the device adjusts automatically in response to the sun, the worst case scenario during the period of December to February can be used.

The 80% figure acknowledges that while a device may be capable of providing 100% shade during summer, some leakage of solar radiation may occur at the sides of the device. For example, although adjustable blinds are capable of providing 100% shade when they are fully

closed or lowered, it is accepted that they may allow some summer solar radiation to reach the glazing at the sides of the blinds. Similarly, while a horizontal building screen may have slats which have been designed to provide 100% shade in summer, it is accepted that there may be some leakage of solar radiation at the sides of the slats.

A degree of judgement is required to determine whether the amount of summer solar radiation that reaches the glazing at the sides of a device exceeds that permitted. Generally, a close fitting blind should sufficiently restrict the amount of summer solar radiation that reaches the glazing at the sides of the device. A horizontal building screen that extends either side of the glazing by the same projection distance (P) should also restrict a sufficient amount of solar radiation at the sides of the slats.

Adjustable shading devices can only be recognised in the calculations if they are automatically operated. This is based on the premise that occupants are less likely to operate the devices as those in the best position to operate the devices are less inclined to do so because they are not paying the energy bills.

PART J3 BUILDING SEALING

Deemed-to-Satisfy Provisions

J3.0 Deemed-to-Satisfy Provisions

Intent

To clarify that the requirements of **JP1** and **JP3** will be satisfied if a building complies with Parts **J1** to **J7**.

See comments for Deemed-to-Satisfy Provisions of **J0.0**.

J3.1 Application of Part

Intent

To clarify that the Deemed-to-Satisfy Provisions of **Part J3** do not apply to certain buildings and areas within certain buildings.

J3.1 does not apply where the only conditioning is provided by an evaporative cooler or to openings necessary for the safe operation of a gas appliance.

A building that is conditioned by heating or refrigerative cooling needs to be sealed to conserve energy but one that is conditioned by evaporative cooling does not need to be sealed as windows or doors would need to be opened anyway in order to provide the relief for the ventilation air. However, if the building is in climate zones 4, 6, 7 or 8, or has a refrigerative cooler, then it has to be sealed because of the likelihood of heating during colder periods or to avoid the loss of cooled air when the refrigerated cooler is running.

Ventilation for safe operation of a gas appliance is not covered by the BCA, but is addressed by other legislation. Appropriate ventilation for gas appliances can be obtained from the relevant legislation, reference standards and product installation manuals.

Unique to this Part is that as air-conditioned buildings are often pressurised by the introduction of outside air through a mechanical supply system, it may not be necessary to seal the building to the same degree as for an un-pressurised building.

J3.2 Chimneys and flues

Intent

To provide energy efficiency requirements to chimneys and flues.

The requirements of this Part are to be read in conjunction with the fire safety requirements in **Part G2**.

A solid-fuel burning device is a heater that burns material such as timber, coal and the like. This provision does not apply to gas and liquid fuel burning devices.

J3.3 Roof lights

Intent

To provide energy efficiency requirements for the sealing of roof lights.

Roof lights that are openable must be sealed when closed in order to restrict the loss of conditioned air to the outside environment. It is assumed that most of the habitable rooms in residential type buildings in the cooler climate zones will be heated by installed or portable heaters. However if a non-habitable room is conditioned, either cooled or heated, then it must also be sealed. For the hotter climate zones, the roof lights need be sealed only if conditioning is being installed.

J3.4 Windows and doors

Intent

To provide energy efficiency requirements for the sealing of windows and doors.

Prior to BCA 2010, louvres were exempt from the sealing requirement. This is no longer the case.

An external door opening to a conditioned space must also have a device to prevent significant amounts of conditioned air being continuously lost. This only applies to conditioned spaces greater than 50 m². Devices that may be installed to comply with this requirement may include an airlock, self-closing door, or revolving door. Provisions for people with a disability should also be considered when selecting the device.

There are a couple of exemptions to these requirements, such as for roller shutter doors or the like, that are used for out-of-hours security purposes only, i.e. when conditioning is not operating. Another exemption has been granted for the main entrance to a café, restaurant or open front shop that has a 3 m non-conditioned zone. Where staff are carrying trays of food or drink it may be unsafe to require an airlock, self-closing door or sliding door.

J3.5 Exhaust fans

Intent

To provide energy efficiency requirements for the sealing of exhaust fans.

The sealing of exhaust fans applies to the same spaces and in the same climate zones as described for roof lights. It also only applies to “miscellaneous” exhaust fans, such as smaller fans used for domestic kitchen exhaust. The provisions do not apply to smoke exhaust fans and the like. The term “miscellaneous” is comparable with the use of this term in AS 1668.1 for certain air-handling systems.

A miscellaneous exhaust fan is considered to be adequately sealed if it is fitted with a self-closing damper or similar sealing device.

J3.6 Construction of roofs, walls and floors

Intent

To provide energy efficiency requirements for the sealing of roofs, walls and floors.

The sealing of roofs, walls and floors applies to the same spaces and in the same climate zones as described for roof lights. For the purposes of **J3.6**, caulking includes sealant, expanded foam or other gap filling material.

The acceptable solution of a "close fitting internal lining system" is considered to include an allowance for minimum gaps in internal linings for thermal movement at wall, floor and ceiling junctions.

J3.7 Evaporative coolers

Intent

To provide energy efficiency requirements for the sealing of evaporative coolers when not in use.

Similarly to exhaust fans, an evaporative cooler represents a large opening in the building envelope. This opening needs sealing when the evaporative cooler is not in use, such as in the winter when a heating system may be operating.

PART J4

* * * * *

The content of **Part J4**, which existed in BCA 2009, has been removed. The Part number **Part J4** has been retained without text so as not to change the numbering of the current BCA from that of BCA 2009.

PART **J5** AIR CONDITIONING AND VENTILATION SYSTEMS

Deemed-to-Satisfy Provisions

J5.0 Deemed-to-Satisfy Provisions

Intent

To clarify that **JP1** and **JP3** will be satisfied if compliance is achieved with **Parts J1 to J7**.

See comments for Deemed-to-Satisfy Provisions of **J0.0**.

J5.1 * * * * *

The content of **J5.1**, which existed in BCA 2005, has been removed. The provision number **J5.1** has been retained without text so as not to change the numbering of the current BCA from that of BCA 2005.

J5.2 Air conditioning and ventilation systems

Intent

To set the minimum requirements for air-conditioning and ventilating systems and components.

It should be noted that the BCA cannot mandate operational or administrative matters such as the set point for temperature control devices, nor would it be practical to do so. It can only require that temperature control devices be installed and be maintained.

Note that **J5.2(a)** is about air-conditioning units and systems so the floor area measured would only be that for the space served by that air-conditioning unit or system and not include non-conditioned corridors, toilets, plant rooms and the like.

J5.2(a)(iii) requires the air-conditioning unit or system to stop when a door to a balcony, patio or courtyard of a sole-occupancy unit of a Class 3 building is open for more than 1 minute. This can be achieved by an electric power micro-switch on the door. The 1 minute timing is to allow for people to open and close the door without the air-conditioning stopping and starting each time. However, if the door is left open for more than 1 minute, it ensures that the air-conditioning does not continue to operate.

J5.2(a)(v)(A) outlines that when one space has a different thermal characteristic to another space, and both are conditioned by the same air conditioner, it may be necessary to provide separate temperature control devices in the ductwork supplying the different spaces. For example, consider the differing thermal characteristics between a south facing room and an east facing room. If the temperature sensor is in the east facing room it will activate a higher level of cooling than the south facing room requires, resulting in the south facing room being cooler than desired. An additional temperature control device will prevent this. Where a separate

temperature control device is provided to reheat the air, then at the full supply air rate for the space, it must not increase the supply air temperature by more than 7.5K, as there are more cost effective solutions.

J5.2(a)(v)(C) outlines that the allowable temperature rise can be determined by using an inverse relationship between allowable temperature rise and supply air rate. If, during the reheating, the supply air rate is also reduced then the temperature rise can be proportionally increased above 7.5K at the same rate that the supply air rate has been reduced. For example, the reheat temperature could be increased to 10K when the supply air rate is reduced by 25% or increased to 15K if the supply air rate is reduced by 50%.

J5.2 (a)(vi) requires a fan to be capable of varying its speed where the supply air quantity is to be varied. It is not appropriate to just throttle the supply air with dampers or other devices.

J5.2(a)(vii) requires, in other than an area needing humidity control, outside air economy cycles where they can cost-effectively provide free cooling. They are not considered effective in climate zone 1 and less effective in climate zones 2 and 3 than the other climate zones.

J5.2(a)(ix) limits the power that air-conditioning fans can consume while balancing ductwork size and additional costs. Smaller ductwork is cheaper, but can result in more fan energy for the same air flow. Large ductwork is dearer and may also result in a greater building cost. A system performance approach is preferred to individual component performance, such as coils, filters, attenuators and ductwork, as it is less restrictive and permits innovation. The two sets of values for small and large systems have been developed by modelling typical systems with varying internal loads in both large and small buildings. The values vary depending upon the internal sensible heat load in the space. The power allowances increase for higher air-conditioning sensible heat loads which are determined as part of the air-conditioning plant assessment calculations. The Australian Institute of Refrigeration, Air-conditioning and Heating (AIRAH) Handbook provides guidance on calculating this sensible heat load.

J5.2(b) is about a system that provides mechanical ventilation to satisfy **Part F4**. It may be part of an air-conditioning system described in **(a)** or may be a separate mechanical ventilation system.

J5.2(b)(i) is intended to only apply where the building or part of a building served by the ventilation system is unoccupied. For example, if a ventilation system serves a whole building it is only required to be capable of being inactivated when the whole building is unoccupied. Similarly, if a ventilation system only serves a single floor of a building, the system must be capable of being inactivated when that part of the building is unoccupied.

J5.2(b)(ii)(A) requires that the outside air requirement of **Part F4** not be exceeded by more than 20%. This value is to provide the designers some flexibility when supplying a series of spaces from the one system. Where there is a need for more outside air for one space, a dedicated system should be installed for that space.

J5.2(b)(ii)(B) requires that certain buildings, where there is a high density of people and consequently a high rate of outside air required by **Part F4**, to have facilities to either reclaim energy from the building's exhaust or reduce the outside air rate in proportion to the number of people in the building.

J5.2(b)(iii)(A) defines the maximum allowable fan power to air flow rate ratio in a mechanical ventilation system over 1000 L/s. This provision is about selecting an efficient fan irrespective of the system pressure, but does so based on system performance. The fan power to air flow rate ratio is found by dividing the fan power (W) by the total flow rate (L/s). Note that fan power is a defined term that describes what is intended.

The system flow rate and resistance is determined at the time of design. It should also be noted that the motor efficiency performance is controlled under the Australian Government's Minimum Energy Performance Scheme (MEPS).

J5.2(b)(iii)(B) requires a monitoring system to control the garage ventilation system in a carpark of over 40 vehicles capacity. Contaminants from vehicles are mainly carbon monoxide and nitrous oxide with carbon monoxide likely to reach the health limit before the nitrous oxide. AS 1668.2 - 1991 has provision for reducing the ventilation rate if an atmospheric contaminant monitoring system is installed. If other contaminants, such as from batteries or petrol, are present, a higher minimum rate or a supplementary system may be needed.

J5.3 Time switch

Intent

To specify the requirements for time switch controlling of power supply to air-conditioning and ventilating systems.

Air-conditioning, heating and ventilation systems are to be provided with time switches that can activate and de-activate the respective system. The threshold size criterion is set on the basis of a space served by a smaller system. In such a space, the system is likely to be under the control of the occupants who would be aware of when the system should operate and so could efficiently control the system manually.

J5.4 Heating and cooling systems

Intent

To set the minimum requirements for heating and cooling systems.

J5.4(a)(ii)(A) is similar to the requirement for fan power. It is included to find a cost effective balance between pipe size and additional costs. Small long pipes use more pump energy than larger shorter pipes for the same water flow while large pipes mean greater capital costs. A system performance approach is preferred to individual component resistance, such as coils, heat exchangers, valves and piping, as it is less restrictive and permits innovation. The allowances have been developed by modelling typical systems with varying internal loads and increase with increased cooling or heating loads.

Note that **J5.4(a)(ii)(A)** is about pumps supplying chilled water, condenser water or heating water for air-conditioning systems so the floor area measured would only be that for the spaces served by that air-conditioning system and not include non-conditioned corridors, toilets, plant rooms and the like.

J5.4(a)(ii)(B) outlines that savings can be made in pump energy use if the pump speed can be lowered to meet a change in duty. However, where higher water flow rates though systems may provide higher efficiencies in connected machinery, the pump speed should not be varied. For example, higher flow rates could result in a lower condenser water temperature in a refrigeration machine which, in turn, would result in lower energy use than can be realised from any savings in pump power.

Another instance where the flow rate should not be varied is where safety is reliant on the flow rate being held constant, for example, through boilers or water cooled heat pump air-conditioners.

J5.2(a)(iii) requires the water flow through major items such as boilers and chillers to be stopped when the item is not needed, usually by an automatic valve. This will reduce the amount of water being circulated and the pump energy needed, as well as thermal loss through the additional components.

J5.4(b)(i) specifies the efficiencies required for gas and oil fired heaters that heat a space via heating water, such as boilers. It also requires gas to be the energy source where it is available.

J5.4(b)(ii) gives preference, when directly heating a space, to sources of energy with low greenhouse intensity. **J5.4(b)(ii)(F)** permits reclaimed heat from another process such as from a refrigeration plant, a co-generation plant, and bio-fuels to be used.

J5.4(b)(ii)(H) only allows the use of electricity for heating of space under very limited conditions.

J5.4(b)(iii) requires outdoor heaters to have controls to automatically turn them off when not needed.

J5.4(c) specifies the efficiencies required for package air-conditioning equipment of certain capacities. The standard referred to has various test conditions so this clause requires the equipment to be tested at condition T1. The efficiency of equipment up to 65 kW_r is controlled through the Minimum Energy Performance Standard (MEPS). These standards are part of a program mandated by State and Territory government legislation and regulations which give force to the relevant Australian Standards which contain the technical requirements. The program is managed by a committee consisting of officials from the Commonwealth, State and Territory government agencies and representatives from New Zealand which is ultimately directed by the Ministerial Council on Energy (the Energy Ministers from all jurisdictions).

J5.4(d) expresses the performance of a refrigerant chiller of capacity up to 350 kW_r that is part of an air-conditioning system in accordance with an American Air-Conditioning & Refrigeration Institute standard. This standard requires chillers to be tested at full load and at a series of part loads, which are then integrated into a single number part-load efficiency. Chillers of 350 kW_r capacity and above are regulated under MEPS.

J5.4(e) states the performance criteria of air cooled condenser fan motors that are part of an air-conditioning system.

J5.4(f)(i) and **J5.4(f)(ii)** state the performance criteria of cooling tower fans that are part of an air-conditioning system. These can be determined using any internationally accepted standard such as CTI STD-201(02) and ATC-105(00).

J5.4(g)(i) and **J5.4(g)(ii)** state the performance criteria of closed circuit cooler fans that are part of an air-conditioning system. These can be determined using any internationally accepted standards such as CTI STD-201(02) and ATC-105S(96).

J5.4(h)(i) and **J5.4(h)(ii)** state the performance criteria of evaporative condenser fans that are part of an air-conditioning system. These can be determined using any internationally accepted standard such as ATC-106 (04).

J5.4(i) states the performance criteria of the spray water pump of a closed circuit cooler or evaporative condenser that is part of an air-conditioning system. These can be determined as part of the tests for closed circuit coolers and evaporative condensers.

J5.5 Miscellaneous exhaust systems

Intent

To specify the requirements of miscellaneous exhaust systems.

J5.5 contains requirements for miscellaneous exhaust systems including kitchen hoods, laundry hoods and fume hoods as examples. It also permits an exemption where safety is an issue, such as the exhaust from a chemical storage cabinet. Likewise, fume hoods in some situations can operate on reduced flow while in other situations must operate at full flow.

Where an air-conditioning or supply air system is installed to provide outside air for ventilation, and this air cannot be relieved from the space by other exhaust ventilation systems or by natural means, then a miscellaneous exhaust ventilation system could help to achieve internal air balance. The provisions of this clause are not intended to apply to a miscellaneous exhaust system in these circumstances.

PART J6 ARTIFICIAL LIGHTING AND POWER

Deemed-to-Satisfy Provisions

J6.0 Deemed-to-Satisfy Provisions

Intent

To clarify that **JP1** and **JP3** will be satisfied if compliance is achieved with **Parts J1** to **J7**.

See comments for Deemed-to-Satisfy Provisions of **J0.0**.

J6.1 * * * * *

The content of **J6.1**, which existed in BCA 2009, has been removed. The provision number **J6.1** has been retained without text so as not to change the numbering of the current BCA from that of BCA 2009.

J6.2 Artificial lighting

Intent

To set the minimum requirements for the level of interior artificial lighting.

J6.2(a) - Sole-occupancy units of Class 2 buildings or a Class 4 part

There are two approaches available for the sole-occupancy units of residential buildings in **J6.2(a)(i)**. They are a Lamp Power Density approach or an Illumination Power Density approach. The former is simpler while the latter provides considerably more flexibility for a dwelling with sophisticated lighting control systems. 5 W/m² for inside a dwelling is the criterion in both approaches.

Lamp power density is the simpler means of setting energy consumption at an efficient level for sole-occupancy units of Class 2 buildings or a Class 4 part of a building. It is a defined term and is calculated by adding the maximum power ratings of all the permanently wired lamps in a space and dividing this sum by the area of the space. With this approach there are no concessions for using timers, motion detectors or other control devices.

If the illumination power density approach is used the 5 W/m² can be increased by dividing it by the illumination power density adjustment factor in **Table J6.2b** where applicable. This more complex approach has been included as an increasing number of dwellings are using sophisticated control systems in order to reduce their energy consumption.

Lamps plugged into general purpose socket outlets are excluded through the definition of lamp power density and illumination power density because of the difficulty in regulating such portable appliances.

J6.2(a)(iii) requires the power of the proposed installation to be used and may mean the light fittings be specified or some other administrative condition be applied.

J6.2(a)(iv) requires the less efficient halogen lamps to be separately switched from fluorescent lamps. This is because the halogens may not be needed all the time but would have to be on if they were controlled by the same switch as the more efficient fluorescent.

J6.2(b) - Buildings except for sole-occupancy units of Class 2 buildings or a Class 4 part

J6.2(b) covers other building classifications. Requirements for these types of buildings are more detailed than the requirements for sole-occupancy units of Class 2 buildings or a Class 4 part, in order to cater for the greater range of applications.

Where lamp power density or illumination power density may be used for sole-occupancy units in Class 2 buildings or a Class 4 part of a building, only illumination power density (IPD) can be used to measure compliance for all other applications.

Lighting in non-residential commercial buildings is progressively moving towards the use of fluorescent lamps for general lighting and metal halide lamps for special lighting. At present other lamps are available, but because of the shift to fluorescent lamps for general lighting, the illumination power density levels in **Part J6** have been developed for fluorescent lamps and fittings. The aggregated design illumination load is the maximum load in the lamp's operational cycle.

J6.2(b)(i) describes the process for determining the illumination power allowance for artificial lighting, however it does not apply to the sole-occupancy units of a Class 2 building or a Class 4 part of a building.

Illumination power density values

The maximum values in **Table J6.2(a)** have been derived on the basis of a lighting design complying with the recommendations of AS 1680 for the nature of the task, including an allowance for a safety margin in design and the physical limitation of placing a discrete number of fittings in a uniform array. The maintained illuminance will be designed to suit the use of the area and again is based on the illuminance levels in AS 1680 or an equivalent document from an overseas standards organisation. However, the levels are not being controlled by **Section J** of the BCA; only the power allowance for achieving the desired illuminance.

The following table shows how some of the illumination power density values correspond to the lighting levels of AS 1680.

The allowance is for the power supply to the lighting.

The values have been generally set at a level that can be achieved with reasonable surface reflectances, high efficacy light sources, low loss control gear and high efficiency luminaires. However, the use of the space has also been taken into account. For example, the illuminance power density of a restaurant is 18 W/m² as against the kitchen for the same restaurant at 8 W/m². This enables the type of fittings to be used in the restaurant that provides the desired ambience.

There are two levels for offices. General open areas that are lit to more than 200 lx may use 9 W/m². For offices lit to less than 200 lx, where task lighting is intended to supplement the general lighting, the maximum for the general lighting is only 7 W/m².

Where an application is not specifically listed in **Table J6.2(a)**, note 1 to the table provides values based on the illuminance level.

Location	AS 1680 recommended illuminance, lx	Maximum illumination power density W/m ²	Lumens/Watt
Auditorium, church and public hall	160	10	16
Board room and conference room	240	10	24
Carpark - general	40	6	7
Carpark – entry zone (first 20 m of travel)	800	25	32
Control room, switch room, and the like	160	9	18
Courtroom	320	12	27
Entry lobby	160	15	11
Health-care – examination room	400	10	40
Health-care – patient ward	240	7	34
Health-care – children’s ward	240	10	24
Kitchen and food preparation areas	240	8	30
Laboratory - lit to 400 lx or more	400	12	33
Library – general	240	12	20
Library – reading room	320	10	32
Museum and gallery - circulation, cleaning and service lighting	240	8	30
Office – artificially lit to an ambient level of 200 lx or more	320	9	36
Office – artificially lit to an ambient level of <200 lx	160	7	23
Plant room	80	5	16
Toilet	80	5	16
Restaurant, café, bar, hotel lounge etc	80	18	4.5
Retail space including a museum and gallery that sell art objects	160	22	8
School - General purpose learning area	320	8	40
Storage, shelving no higher than 75% of the height of aisle lighting	160	8	20
Storage, shelving higher than 75% of the height of aisle lighting	160	10	16
Service area, cleaners room and the like	80	5	16

Location	AS 1680 recommended illuminance, lx	Maximum illumination power density W/m ²	Lumens/Watt
Wholesale storage and display area	320	10	32

Illumination power density adjustment factors

It is recognised that there are many variables in lighting that limit the ability to achieve the maximum illumination power density. One is the size of the room and so note 3 of [Table J6.2a](#) explains how the illumination power density may be increased for small rooms. A further series of adjustment factors have been included in [Table J6.2b](#) that allow credit for additional energy control devices.

The adjustment factors are applied to the maximum illumination power density in [Table J6.2a](#). This means that if a designer chooses to use a less efficient light source or luminaire, compliance can be achieved by the use of a supplementary control device such as an occupancy sensor or photoelectric device.

Occupancy sensors represent an efficient way of tailoring the lighting to the usage of the space. The fewer lights that are controlled by an individual sensor the greater the energy saved, however, there is less cost saving on the energy to offset the cost of the sensor. Therefore, there is a graduated scale of adjustment factors for the area of lights controlled.

For lecture theatres, auditoria and large spaces of transient usage, the contribution of detectors should be assessed using an Alternative Solution rather than the Deemed-to-Satisfy Provisions.

Worked example 1 of J6.2(b)(i):

Consider a small laboratory of 5 m by 7 m, i.e. 35 m². It is 2.6 m high. It has an aggregate design illumination power load (load for all light fittings) of 500 W which includes all ballasts.

From [Table J6.2a](#), the maximum illumination power density for a laboratory is 12 W/m².

From note 3 under [Table J6.2a](#), the Room Aspect Ratio is 35 / (2.6 x 24), i.e. 0.56 which is less than the 1.5 threshold in the note.

Therefore the adjustment factor for Room Aspect is:

$$\begin{aligned}
 & 0.5 + (\text{Room Aspect Ratio} / 3) \\
 = & 0.5 + (0.56 / 3) \\
 = & 0.69.
 \end{aligned}$$

Therefore the maximum illumination power density adjusted for room aspect is:

$$\begin{aligned}
 = & 12 / 0.69 \\
 = & 17.4 \text{ W/m}^2.
 \end{aligned}$$

This results in an illumination power load allowance of 609 W (i.e 35 m² x 17.4 W/m²).

As the aggregate design illumination power load is 500 W, the design complies because the value is less than the allowance of 609 W.

Worked example 2 of J6.2(b)(i)

Consider a conference room of 3 m by 10 m, i.e. 30 m² with a full height window along the 10 m length. It has an aggregate design illumination power load (load for all light fittings) of 500 W which includes all ballasts and it has a motion detector and a daylight sensor/dynamic lighting control device which operates all of the lights.

From **Table J6.2a**, the maximum illumination power density for a conference room is 10 W/m².

From **Table J6.2b** the illumination power density adjustment factor for a manually operated dimmer is 0.95 and a daylight sensor/dynamic lighting control device is 0.5.

From note 6 under **Table J6.2b**, the combined adjustment factor for controls is:

$$\begin{aligned}
 &= 0.5 \times (0.95 + [(1 - 0.95) / 2]) \\
 &= 0.5 \times 0.98 \\
 &= 0.49
 \end{aligned}$$

Therefore the maximum illumination power density is:

$$\begin{aligned}
 &= 10 / 0.49 \\
 &= 20.4 \text{ W/m}^2
 \end{aligned}$$

This results in an illumination power load allowance of 612 W (i.e 30 m² x 20.4 W/m²).

As the aggregate design illumination power load is 500 W, the design complies because the value is less than the allowance of 612 W.

J6.3 Interior artificial lighting and power control

Intent

To set the minimum requirements for switches and other lighting control devices.

The lighting control requirements are directed at enabling occupants to save energy on lighting and power when the space is not occupied or the service is not needed.

J6.3(a) requires each room or space to be individually switched or controlled. This is to ensure that when lighting to a small area is required, lighting to a larger area is not also activated.

J6.3(b) requires that an occupant activated device be installed in a sole-occupancy unit of a Class 3 building, based on the likelihood that guests may not switch off the power when leaving the room.

This power includes the lighting, air-conditioning, exhaust fans and bathroom heating when the room is not occupied. The control device is not detailed so the requirements can be met by various systems such as a security device like a room key slot at the door, a motion detector, or any device or system that can monitor the occupancy of the unit. For the purpose of applying this provision, occupancy should be taken as the physical presence of people in the room rather than having someone registered or checked into the unit.

J6.3(c) requires lighting to be locally switched from a position that is visible in the room or in an adjacent room. If the controls are in an adjacent room, then the lighting that is controlled must be visible from the switching position. This is to reduce the possibility of lighting being left on in unoccupied areas because it cannot be seen.

Most buildings are required to have local control of the lighting in manageable blocks. This is to avoid the situation where a large area of lighting has to be switched on when only a small area is required, simply because there is no subdivision of the switching area. Buildings with lighting that is likely to be totally on or totally off, such as a theatre or swimming pool, are exempted.

J6.3(d) requires a non-residential building or storey (i.e. other than a sole-occupancy unit in a Class 2 or 3 and Class 4 part) over 250 m² to have controls to prevent most of the lighting being left on 24 hours a day. This can be a time switch or occupancy sensor. The time switching has to comply with **Specification J6**. Simple manual override switches or bypass switches are not allowed as they give the ability to permanently disable the control. The time switch control does not preclude the need for local control.

J6.3(e) applies to only certain buildings and specifically to switching the lights near windows.

J6.4 Interior decorative and display lighting

Intent

To set the minimum requirements for controlling decorative and display lighting.

These are additional control requirements for decorative and display lighting as distinct from those for other artificial lighting in a space.

J6.5 Artificial lighting around a building

Intent

To set the minimum requirements for exterior artificial lighting.

It is not practical to apply illumination power density to external lighting in the same way as it has been applied to internal lighting because it is difficult to define the relevant area for all situations. The requirements are therefore aimed at ensuring efficient light sources are used or that the lighting only operates when it is required.

All external lighting must be controlled by either a daylight sensor or time switch. When the external lights have a significant load (i.e. more than 100 W), they must also have an average light source efficacy of not less than 60 Lumens/W or be controlled by a motion detector.

J6.6 Boiling water and chilled water storage units

Intent

To set the minimum requirements for controlling boiling water and chilled water storage units.

A time switch is required for boiling water and chilled water storage units that continually maintain water at temperature because they can waste energy overnight and during weekends. This clause is not intended to apply to units that heat or chill water as it is being drawn off.

PART J7 HOT WATER SUPPLY AND SWIMMING POOL AND SPA POOL PLANT

Deemed-to-Satisfy Provisions

J7.0 Deemed-to-Satisfy Provisions

Intent

To clarify that **JP1** and **JP3** will be satisfied if compliance is achieved with **Parts J1 to J7**.

See comments for Deemed-to-Satisfy Provisions of **J0.0**.

J7.1 * * * * *

The content of **J7.1**, which existed in BCA 2005, has been removed. The provision number **J7.1** has been retained without text so as not to change the numbering of the current BCA from that of BCA 2005.

J7.2 Hot water supply

Intent

To set the minimum requirements for hot water systems.

The measures for hot water supply are contained in AS/NZS 3500. In this way, there is little likelihood of clashing with plumbing legislation.

J7.3 Swimming pool heating and pumping

Intent

To set the minimum requirements for swimming pool heating and pump control.

This provision states what energy source may be used to heat a swimming pool. It is to meet the objective of reducing greenhouse gas emissions and the performance requirement of using an energy source that is of low greenhouse intensity or is a renewable source. It also requires a swimming pool to have—

- if heated by gas or heat pump—
 - a cover; and
 - time switch operation for the heater.
- a time switch to control the operation of a circulation pump.

Some jurisdictions may have Performance Requirements for a pool cover under the Smart Approved Water Mark Scheme.

J7.4 has specific requirements for spa heating and pumping therefore for the purpose of this provision a swimming pool does not include a spa.

J7.4 Spa pool heating and pumping

Intent

To set the minimum requirements for a spa heater and pump control.

As for swimming pools, this provision states what energy source may be used to heat a spa. It also requires a spa which is heated by gas or a heat pump to have—

- a cover; and
- a push button and time switch operation for the heater.

680 L is generally accepted as the capacity of when a spa bath becomes a spa pool.

PART J8 ACCESS FOR MAINTENANCE AND FACILITIES FOR MONITORING

Deemed-to-Satisfy Provisions

J8.0 Deemed-to-Satisfy Provisions

Intent

To clarify that **JP2** will be satisfied if compliance is achieved with **J8.1** to **J8.3**.

Where a Building Solution is proposed to comply with the Deemed-to-Satisfy Provisions, **J8.0** clarifies that compliance with **J8.1** to **J8.3** achieves compliance with **JP2**.

See comments for Deemed-to-Satisfy Provisions of **J0.0** as appropriate.

The emphasis for **Part J8** is on being able to maintain the required level of performance. To achieve this, consideration needs to be given to ensuring that there are adequate provisions made in the design for—

- access to carry out any necessary system maintenance; and
- monitoring facilities so that excessive energy use can be detected.

J8.1 Application of Part

Intent

To clarify that the Deemed-to-Satisfy Provisions of **Part J8** do not apply to a sole-occupancy unit of a Class 2 building or a Class 4 part of a building.

Part J8.0 does not apply to private dwellings, i.e. Class 1 buildings, therefore it is also not applied to the sole-occupancy units of Class 2 buildings, or Class 4 parts of buildings.

J8.2 Access for maintenance

Intent

To clarify where access must be provided for maintenance purposes.

One consideration for maintenance is to provide adequate access and space around critical items. Because the access requirements are very different for different plant, the provision cannot be specific. Manufacturers usually provide such information and organisations such as the Australian Institute of Refrigeration, Airconditioning and Heating, also provide guidance information.

J8.3 Facilities for energy monitoring

Intent

To ensure that the building has the facilities to monitor its energy usage.

In order for maintenance personnel to ensure that active energy efficiency items and systems continue to operate at their required level of performance, they need to know the energy usage of the building over time and also the usage of individual services in a large building.

SPECIFICATION **J1.2** MATERIAL PROPERTIES

Deemed-to-Satisfy Provisions

1 Scope

Intent

To clarify that **Specification J1.2** covers the relevant properties attributed to common construction materials, air films and airspaces, and reflective surfaces.

2 Construction Deemed-to-Satisfy

Intent

To detail the relevant properties attributed to common construction materials, air films and airspaces, and reflective surfaces.

The values provided in **Table 2a** are material density values (used in determining if a wall system exceeds 220 kg/m²) and thermal conductivity (k) values for materials. **Tables 2b** and **2c** list the R-Values of airspaces and films and expected added R-Values provided by a reflective surface. All except the material density are used in determining the Total R-Value of a roof, wall or floor system.

The term surface density suggests mass per unit volume but in this context is the mass of the full thickness of 1 square metre of wall surface area.

Clause 2(d) explains the meaning of a ventilated roof space.

SPECIFICATION **J1.3** ROOF AND CEILING CONSTRUCTION

Deemed-to-Satisfy Provisions

1 Scope

Intent

To clarify that **Specification J1.3** outlines the thermal performance of some of the more common forms of roof and ceiling construction.

2 Construction Deemed-to-Satisfy

Intent

To detail the Total R-Values considered to be achieved by common forms of roof construction.

Typical construction

The Total R-Value of the basic roof and ceiling has been determined by adding together the R-Values of the outdoor air film, roof cladding, roof airspace, ceiling sheet lining and internal air film.

The total R-Value of the roof and ceiling materials may need to be adjusted if other building elements, such as sarking, are to also be installed.

Insulation can be installed in the roof, the ceiling, or a combination of both, provided the required thermal performance is achieved and other aspects of the building's integrity are not compromised. It should be noted that the thermal performance of the roof may vary depending on the position of the insulation, the climatic conditions, the design of the building and the way in which it is operated. For example, although not recognised in the values, insulation installed under the roof, rather than on the ceiling, in a building with a large roof space in a cold climate, or when a room is being air-conditioned, may be less effective because of the additional volume of roof airspace that would need to be heated or cooled.

For a material that is not listed as an item in **Figure 2**, other than air, the R-Value may be determined by dividing the thickness of the item in metres by the thermal conductivity in W/m.K (typical values are described in **Specification J1.2**).

Irrespective of the framing material used, the minimum added R-Value specified in **Figure 2** is considered to include an allowance for the effect of thermal bridging created by framing members.

There are a number of different insulation products that may be used to achieve the minimum added R-Value. Care should be taken to ensure that the choice made is appropriate for the construction and climate conditions. For instance, in some climate zones, an impermeable insulation sheet needs to be installed with due consideration of condensation and associated interaction with adjoining building materials.

SPECIFICATION **J1.5** WALL CONSTRUCTION

Deemed-to-Satisfy Provisions

1 Scope

Intent

To clarify that **Specification J1.5** outlines the thermal performance of some of the more common forms of wall construction.

2 Construction Deemed-to-Satisfy

Intent

To detail the Total R-Values considered to be achieved by common forms of wall construction.

Figure 2 provides examples of typical insulation locations in various types of wall construction. The Total R-Value required is achieved by adding the R-Value of the basic wall and the R-Value of any additional insulation incorporated. The Total R-Value of the typical wall construction has been produced by adding together the R-Values for outdoor air film, wall cladding, wall airspace, internal lining and internal air film.

The most common forms of construction for low-rise buildings are represented. It has not been possible to cover other forms of construction, particularly those used for high-rise construction, because of the wide range and the greater influence of winds, cyclones and earthquakes on the elements of the building. The Total R-Value of other forms of construction can be determined by adding the individual R-Values together.

For a material that is not listed as an item in **Figure 2**, other than air, the R-Value may be determined by dividing the thickness of the item in metres by the thermal conductivity in W/m.K (typical values are described in **Specification J1.2**).

Reflective insulation that has just one reflective surface is considered to achieve the R-Values when used in conjunction with the Total R-Value of the common wall construction stated in **Figure 2**. The actual R-Value added by reflective insulation should be determined for each product in accordance with the standards prescribed in the BCA, which take into consideration factors such as the number of adjacent airspaces, dimensions of the adjacent airspace, whether the space is ventilated and the presence of an anti-glare coating.

The width for any reflective airspaces adjacent to reflective insulation will not override other requirements such as minimum cavity requirements for masonry waterproofing.

Where a diagram shows reflective insulation or other insulation, these are indicative only. In some climates and using certain materials, neither may be necessary. In other cases, reflective insulation or insulation may be provided separately or in combination to give the required R-Value.

A minimum thickness of 70 mm is stated for framing. In some cases, the frame thickness may need to be increased to avoid compressing the bulk insulation and thus reducing its R-Value.

Walls with a surface density of 220 kg/m² or more are deemed to achieve acceptable levels of thermal performance in certain climate zones due to their ability to store heat and therefore slow the heat transfer through the building fabric. These walls are defined by surface density (kg/m²) to reduce the complexity when measuring mass walls with voids.

Examples of some typical wall construction that achieve a surface density of 220 kg/m² are provided in [J1.5](#).

SPECIFICATION **J1.6** FLOOR CONSTRUCTION

Deemed-to-Satisfy Provisions

1 Scope

Intent

To clarify that [Specification J1.6](#) outlines the thermal performance of some of the more common forms of floor construction.

2 Construction Deemed-to-Satisfy

Intent

To detail the Total R-Values considered to be achieved by common forms of floor construction.

For a material that is not listed as an item in [Figure 2](#), other than air, the R-Value may be determined by dividing the thickness of the item in metres by the thermal conductivity in W/m.K (typical values are described in [Specification J1.2](#)).

SPECIFICATION **J5.2**

DUCTWORK INSULATION AND
SEALING

Deemed-to-Satisfy Provisions

1 Scope

Intent

To clarify that **Specification J5.2** provides the required performance of ductwork insulation and sealing.

2 Ductwork sealing

Intent

To detail the required performance of ductwork sealing.

Ductwork has joins, and unless sealed these joins will allow heated or cooled air to escape. The requirements do not apply to ventilation ductwork where the air is not heated or cooled. Nor does it apply to ductwork in the space being conditioned as the air is intended for that space anyway.

3 Ductwork insulation

Intent

To detail the required performance of ductwork insulation.

Ductwork needs to be insulated to reduce energy loss. The insulating requirements do not apply to ventilation ductwork where the air is not heated or cooled.

Ductwork requiring insulation includes central air-handling plant, fan-coil units and Variable Air Volume (VAV) boxes but does not include packaged air-conditioning equipment that complies with a MEPS, flexible connection on fans or those fittings that form part of the interface with the conditioned space such as air registers.

Clause 3(d)(i) exempts ductwork within the only or last room served from being insulated on the basis that the heating or cooling effect is intended for that room anyway. If a room where the ductwork is not insulated is sub-divided then insulation will need to be added to the ductwork that passes through the first room to serve the second room. This needs to be considered if the exemption is applied to a part of a building or storey likely to be sub-divided as part of a fit-out.

Clause 3(d)(ii) exempts some components from being insulated but not others such as cushion heads, mixing boxes, VAV boxes and flexible connections other than at fans.

Clause 3(d)(iii) and **Clause 3(d)(iv)** exempt ventilation, outside air or exhaust air ductwork where the air is not heated or cooled or where return air ductwork is in the conditioned space. Also exempt is return air ductwork in another space which is also heated or cooled.

The insulation levels in **Table 3** are minimum material R-Values of the added insulation.

Note that air-handling ductwork must also comply with **Clause 8 of Specification C1.10**.

SPECIFICATION **J5.4** INSULATING OF PIPING, VESSELS, HEAT EXCHANGERS AND TANKS

Deemed-to-Satisfy Provisions

1 Scope

Intent

To clarify that **Specification J5.3** provides the required performance of insulation on piping, vessels, heat exchangers and tanks containing heated or cooled fluids.

2 Insulation

Intent

To detail the required performance of insulation on piping, vessels, heat exchangers and tanks containing heated or cooled fluids.

Piping, vessels, heat exchangers and tanks containing heated or cooled fluids need to be insulated to reduce energy loss. The requirements do not apply to piping that is part of a heating or cooling system within the space being heated or cooled as the heating or cooling effect is intended for that space anyway. The requirements do not apply to floor heating, as the insulation would contradict the aim of the heating.

Table 2a and **Table 2b** specify the insulation required for different situations and climate zones. Where the location is stated as "located internally" there is a small reduction for the required material R-Value of the insulation on the basis that the location's temperature is not as severe as outside the building.

Note that like ductwork insulation, the R-Value is that of the insulation and not the Total R-Value of the pipe, air film and insulation. Where piping has a significant inherent R-Value, it may be subtracted from the material R-Value required.

Clauses 2(c)(iii) and **(iv)** exempt piping that is part of an item of plant such as a chiller or boiler or inside an item of plant such as an airhandling unit or fan-coil unit. A note under **Table 2a** permits insulation levels on small pipes to be halved close to the plant to which it is connected and where passing through a structural member.

SPECIFICATION **J6**

**LIGHTING AND POWER CONTROL
DEVICES**

Deemed-to-Satisfy Provisions

1 Scope

Intent

To clarify the extent of items covered by this Specification.

2 Corridor lighting timer

Intent

To detail the required performance of corridor light timers.

Corridor timers are time delay switches that activate a section of lighting when the button is pressed, and switches the lights off again after a predetermined time, provided the button is not pushed again. The provisions for the minimum distance of travel into the space, and for the 5% of lighting that must remain on in larger areas, is designed to reduce the situation of walking into a dark space to switch on the lighting. In many applications the exit signs will provide the continuous 5% of lighting required.

3 Time switch

Intent

To detail the required performance of time switches.

Time switches are devices that turn lights or equipment on and off at predetermined and pre-programmed times.

4 Motion detectors

Intent

To detail the required performance of motion detectors.

The motion detector requirements are similar to those of the corridor lighting timer, except that a motion detector is activated by the motion of people, and the operation of the lighting is maintained while ever the motion continues.

The advantages of motion detectors are:

- a person does not need to find the button; and

- a person can enter the space with more confidence as another person already within the space would have activated the lighting; and
- the time duration for the lighting to be activated does not need to be as long as it does with a corridor lighting timer because the lighting is continuously reset, whereas with a timer, the duration has to be set for the slowest person travelling the greatest distance.

The clause specifies different requirements for motion detectors for three situations—

- a Class 2, 3 or Class 9c aged care building other than sole-occupancy units; and
- a Class 5, 6, 7, 8, 9a and 9b building; and
- outside a building.