



**National Construction
Code Series
2013
VOLUME ONE**

**Building Code of Australia
Class 2 to Class 9 Buildings**



CONTENTS AND FEATURES INTRODUCTION

General Table of Contents

Introduction

SUPERSEDED
CONTENTS AND FEATURES INTRODUCTION

© 2013 Australian Government and States and Territories of Australia

The *NCC 2013 (Volume One, Volume Two & Volume Three)* and the *Guide to the BCA* is the copyright of the Australian Government and States and Territories of Australia and, apart from any use as permitted under the Copyright Act 1998, no part may be reproduced without prior permission. Requests and enquiries concerning reproduction and rights should be directed in the first instance to the General Manager, Australian Building Codes Board, GPO Box 9839 Canberra ACT 2601.

Australian Building Codes Board

GPO Box 9839 Canberra ACT 2601

Web Site: <http://www.abcb.gov.au>

Email: ncc@abcb.gov.au

The Australian Building Codes Board (ABCB) is established by agreement between the Commonwealth Government and each State and Territory Government. It is a co-operative arrangement between the signatories, local government and the building industry.

ABCB Important Disclaimer

The ABCB gives no warranty or guarantee that Volume One of the BCA is correct or complete. The ABCB shall not be liable for any loss howsoever caused whether due to negligence or otherwise arising from the use of or reliance on Volume One of the BCA.

The ABCB recommends that anyone seeking to rely on Volume One of the BCA obtain their own independent expert advice in relation to building or related activities. Its interpretation in no way overrides the approvals processes in any jurisdiction.

NCC Customer Support

Email: ncc@abcb.gov.au

ISBN 978-0-9579897-6-4 (Volume One Class 2-9 Buildings)

GENERAL TABLE OF CONTENTS

CONTENTS AND FEATURES INTRODUCTION

| | |
|--------------------|---|
| Introduction | 7 |
|--------------------|---|

SECTION A GENERAL PROVISIONS

| | |
|--|----|
| Part A0 Application | 13 |
| Part A1 Interpretation | 16 |
| Part A2 Acceptance of Design and Construction | 33 |
| Part A3 Classification of Buildings and Structures | 35 |
| Part A4 United Buildings | 38 |

SECTION B STRUCTURE

| | |
|-------------------------------------|----|
| Part B1 Structural Provisions | 67 |
|-------------------------------------|----|

SECTION C FIRE RESISTANCE

| | |
|---|----|
| Part C1 Fire Resistance and Stability | 85 |
| Part C2 Compartmentation and Separation | 90 |
| Part C3 Protection of Openings | 99 |

SECTION D ACCESS AND EGRESS

| | |
|---|-----|
| Part D1 Provision for Escape | 156 |
| Part D2 Construction of Exits | 170 |
| Part D3 Access for People with a Disability | 187 |

SECTION E SERVICES AND EQUIPMENT

| | |
|--|-----|
| Part E1 Fire Fighting Equipment | 212 |
| Part E2 Smoke Hazard Management | 228 |
| Part E3 Lift Installations | 250 |
| Part E4 Emergency Lighting, Exit Signs and Warning Systems | 261 |

SUPERSEDED
CONTENTS AND FEATURES INTRODUCTION

SECTION F HEALTH AND AMENITY

| | | |
|----------------|--|-----|
| Part F1 | Damp and Weatherproofing | 271 |
| Part F2 | Sanitary and Other Facilities | 285 |
| Part F3 | Room Sizes | 304 |
| Part F4 | Light and Ventilation | 307 |
| Part F5 | Sound Transmission and Insulation | 314 |

SECTION G ANCILLARY PROVISIONS

| | | |
|----------------|---|-----|
| Part G1 | Minor Structures and Components | 335 |
| Part G2 | Heating Appliances, Fireplaces, Chimneys and Flues | 341 |
| Part G3 | Atrium Construction | 345 |
| Part G4 | Construction in Alpine Areas | 355 |
| Part G5 | Construction in Bushfire Prone Areas | 359 |

SECTION H SPECIAL USE BUILDINGS

| | | |
|----------------|--|-----|
| Part H1 | Theatres, Stages and Public Halls | 364 |
| Part H2 | Public Transport Buildings | 366 |

SECTION I MAINTENANCE

| | | |
|----------------|---|-----|
| Part I1 | Equipment and Safety Installations | 373 |
| Part I2 | Energy Efficiency Installations | 380 |

SECTION J ENERGY EFFICIENCY

| | | |
|----------------|--|-----|
| Part J0 | Energy Efficiency | 399 |
| Part J1 | Building Fabric | 401 |
| Part J2 | Glazing | 410 |
| Part J3 | Building Sealing | 430 |
| Part J4 | * * * * * | 433 |
| Part J5 | Air-Conditioning and Ventilation Systems | 434 |
| Part J6 | Artificial Lighting and Power | 442 |
| Part J7 | Hot Water Supply and Swimming Pool and Spa Pool Plant | 451 |

SUPERSEDED
CONTENTS AND FEATURES INTRODUCTION

| | | |
|---|---|------------|
| Part J8 | Access for Maintenance and Facilities for Monitoring | 453 |
| STATE & TERRITORY APPENDICES | | |
| | Appendix Commonwealth of Australia | 477 |
| | Appendix Australian Capital Territory | 482 |
| | Appendix New South Wales | 492 |
| | Appendix Northern Territory | 548 |
| | Appendix Queensland | 571 |
| | Appendix South Australia | 578 |
| | Appendix Tasmania | 613 |
| | Appendix Victoria | 684 |
| | Appendix Western Australia | 713 |
| INDEX, ABBREVIATIONS AND SYMBOLS | | |
| | Index | 722 |
| | Abbreviations and Symbols | 763 |
| HISTORY OF BCA ADOPTION | | |
| | History of BCA Adoption | 767 |
| LIST OF AMENDMENTS | | |
| | List of Amendments | 785 |

INTRODUCTION

THE NATIONAL CONSTRUCTION CODE SERIES

The National Construction Code Series (NCC) is an initiative of the Council of Australian Governments developed to incorporate all on-site construction requirements into a single code. The Building Code of Australia (BCA) is Volume One and Volume Two of the NCC.

FORMAT

The NCC is published in three volumes:

VOLUME ONE:

pertains primarily to Class 2 to 9 buildings.

VOLUME TWO:

pertains primarily to Class 1 and 10 buildings (houses, sheds, carports, etc).

VOLUME THREE:

pertains primarily to plumbing and drainage associated with all classes of buildings.

All three volumes are drafted in a performance format allowing a choice of *Deemed-to-Satisfy Provisions* or flexibility to develop *Alternative Solutions* based on existing or new innovative building, plumbing and drainage products, systems and designs.

When complying with the *Deemed-to-Satisfy Provisions*, or when developing an *Alternative Solution* in order to comply with the BCA, consideration may need to be given to whether the *Building Solution* impacts on compliance with the Plumbing Code of Australia (PCA).

THE BUILDING CODE OF AUSTRALIA

The BCA is produced and maintained by the Australian Building Codes Board (ABCB) on behalf of the Australian Government and each State and Territory government.

The BCA is a uniform set of technical provisions for the design and construction of buildings and other structures throughout Australia whilst allowing for variations in climate and geological or geographic conditions.

THE AUSTRALIAN BUILDING CODES BOARD

The ABCB is established by agreement between the Australian Government and each State and Territory Government. It is a co-operative arrangement between the signatories, local government and the building industry.

The ABCB's mission is to address issues relating to safety, health, amenity and sustainability in the design, construction and performance of buildings. This is achieved through the NCC and the development of effective regulatory systems and appropriate non-regulatory solutions.

The Board comprises—

- (a) a Chair; and
- (b) the head of each Commonwealth, State and Territory department, statutory body, division, or agency that has the relevant administrative responsibility for NCC matters; and
- (c) a representative of the Australian Local Government Association (ALGA); and

- (d) representatives of the building and construction industry, including one representative with plumbing expertise.

The Building Codes Committee (BCC) is the peak technical advisory body to the ABCB, with responsibility for technical matters associated with the BCA.

The BCC comprises—

- (a) the General Manager of the ABCB; and
- (b) one nominee each of the Australian, State, and Territory Governments and ALGA members of the ABCB; and
- (c) representatives of the building and construction industry.

THE BCA — CONTENT

GOALS

The goal of the BCA is to enable the achievement of nationally consistent, minimum necessary standards of relevant safety (including structural safety and safety from fire), health, amenity and sustainability objectives efficiently.

This goal is applied so that—

- (a) there is a rigorously tested rationale for the regulation; and
- (b) the regulation is effective and proportional to the issues being addressed such that the regulation will generate benefits to society greater than the costs (that is, net benefits); and
- (c) there is no regulatory or non-regulatory alternative (whether under the responsibility of the Board or not) that would generate higher net benefits; and
- (d) the competitive effects of the regulation have been considered and the regulation is no more restrictive than necessary in the public interest.

STATE AND TERRITORY VARIATIONS AND ADDITIONS

Each State's and Territory's legislation adopts the BCA subject to the variation or deletion of some of its provisions, or the addition of extra provisions. These variations, deletions and additions are contained in Appendices to the BCA.

Flags identifying variations are located within relevant provisions and at the beginning of relevant Tables. Additional provisions to a Part of the BCA are identified at the end of that Part.

DEFINITIONS

Words with special meanings are printed in italics and are defined in [A1.1](#).

LEGISLATIVE ARRANGEMENTS

GENERAL

The BCA is given legal effect by building regulatory legislation in each State and Territory. This legislation consists of an Act of Parliament and subordinate legislation which empowers the regulation of certain aspects of buildings and structures, and contains the administrative provisions necessary to give effect to the legislation.

Any provision of the BCA may be overridden by, or subject to, State or Territory legislation. The BCA must therefore be read in conjunction with that legislation. Any queries on such matters should be referred to the State or Territory authority responsible for building regulatory matters.

BCA ADOPTION

The adoption of the BCA is addressed in [Part A0](#) of Volume One.

DOCUMENTATION OF DECISIONS

Decisions made under the BCA should be fully documented and copies of all relevant documentation should be retained.

Examples of the kind of documentation which should be prepared and retained include:

- (a) Details of the *Building Solution* including all relevant plans and other supporting documentation.
- (b) In cases where an *Alternative Solution* has been proposed—
 - (i) details of the relevant *Performance Requirements*; and
 - (ii) the *Assessment Method* or methods used to establish compliance with the relevant *Performance Requirements*; and
 - (iii) details of any *Expert Judgement* relied upon including the extent to which the judgement was relied upon and the qualifications and experience of the expert; and
 - (iv) details of any tests or calculations used to determine compliance with the relevant *Performance Requirements*; and
 - (v) details of any Standards or other information which were relied upon.

STRUCTURE

The BCA has been structured as set out in [A0.3](#) and shown in [Figure A0.3](#). It is the ABCB's intent that the *Objectives* and *Functional Statements* be used as an aid to the interpretation of the BCA and not for determining compliance with the BCA.

FURTHER DEVELOPMENT OF THE BCA

Regular changes are planned to the BCA to improve clarity of provisions, upgrade referenced documents and to reflect the results of research and improved technology.

SECTION **A**

GENERAL PROVISIONS

- A0** **Application**
- A1** **Interpretation**
- A2** **Acceptance of Design and Construction**
- A3** **Classification of Buildings and Structures**
- A4** **United Buildings**

SECTION A CONTENTS

SECTION A GENERAL PROVISIONS

Part A0 Application

- A0.1 Adoption
- A0.2 BCA Volumes
- A0.3 BCA Structure
- A0.4 Compliance with the BCA
- A0.5 Meeting the Performance Requirements
- A0.6 Objectives and Functional Statements
- A0.7 Deemed-to-Satisfy Provisions
- A0.8 Alternative Solutions
- A0.9 Assessment Methods
- A0.10 Relevant Performance Requirements

Part A1 Interpretation

- A1.1 Definitions
- A1.2 Adoption of Standards and other references
- A1.3 Referenced Standards, etc
- A1.4 Differences between referenced documents and the BCA
- A1.5 Compliance with all Sections of the BCA
- A1.6 Application of the BCA to a particular State or Territory
- A1.7 Language

Part A2 Acceptance of Design and Construction

- A2.1 Suitability of materials
- A2.2 Evidence of suitability
- A2.3 Fire-resistance of building elements
- A2.4 Fire hazard properties
- A2.5 Resistance to the incipient spread of fire

Part A3 Classification of Buildings and Structures

- A3.1 Principles of classification
- A3.2 Classifications
- A3.3 Multiple classification
- A3.4 Parts with more than one classification

Part A4 United Buildings

- A4.1 When buildings are united
- A4.2 Alterations in a united building

Specifications

SUPERSEDED
GENERAL PROVISIONS

Specification A1.3 Documents Adopted By Reference
Specification A2.3 Fire-Resistance of Building Elements
Specification A2.4 Fire Hazard Properties

PART A0 APPLICATION

A0.1 Adoption

The dates of adoption of the Building Code of Australia (Volume One) are shown in the “History of BCA Adoption” division at the end of this Volume.

A0.2 BCA Volumes

- (a) The Building Code of Australia consists of two volumes, Volume One and Volume Two.
- (b) This is Volume One of the Building Code of Australia which contains the requirements for—
 - (i) all Class 2 to 9 buildings; and
 - (ii) access requirements for people with a disability in Class 1b and 10a buildings; and
 - (iii) certain Class 10b structures including access requirements for people with a disability in Class 10b *swimming pools*.
- (c) Volume Two contains the requirements for—
 - (i) Class 1 and 10a buildings (other than access requirements for people with a disability in Class 1b and 10a buildings); and
 - (ii) certain Class 10b structures (other than access requirements for people with a disability in Class 10b *swimming pools*); and
 - (iii) Class 10c *private bushfire shelters*.

A0.3 BCA Structure

The structure of the BCA comprises the following as shown in **Figure A0.3**:

- (a) The *Objectives*.
- (b) The *Functional Statements*.
- (c) The *Performance Requirements* with which all *Building Solutions* must comply.
- (d) The *Building Solutions*.

Figure A0.3 — BCA Structure

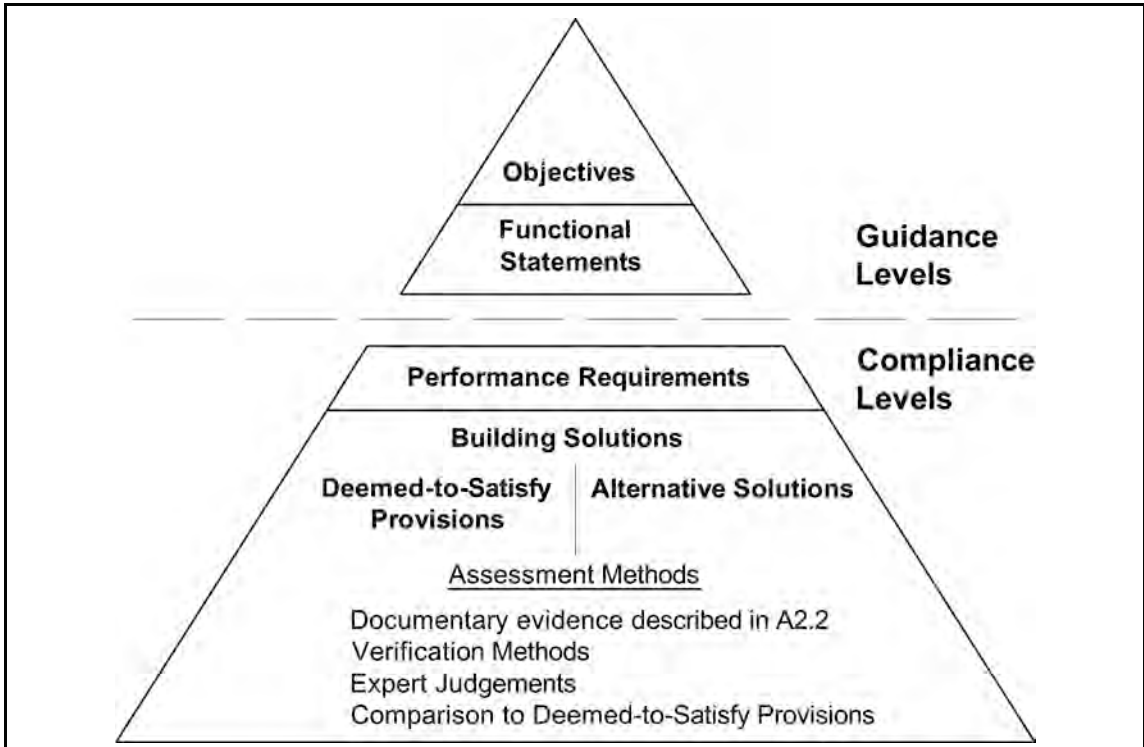

A0.4 Compliance with the BCA

A *Building Solution* will comply with the BCA if it satisfies the *Performance Requirements*.

A0.5 Meeting the Performance Requirements

Compliance with the *Performance Requirements* can only be achieved by—

- (a) complying with the *Deemed-to-Satisfy Provisions*; or
- (b) formulating an *Alternative Solution* which—
 - (i) complies with the *Performance Requirements*; or
 - (ii) is shown to be at least *equivalent* to the *Deemed-to-Satisfy Provisions*; or
- (c) a combination of (a) and (b).

A0.6 Objectives and Functional Statements

The *Objectives* and *Functional Statements* may be used as an aid to interpretation.

A0.7 Deemed-to-Satisfy Provisions

A *Building Solution* which complies with the *Deemed-to-Satisfy Provisions* is deemed to comply with the *Performance Requirements*.

A0.8 Alternative Solutions

- (a) An *Alternative Solution* must be assessed according to one or more of the *Assessment Methods*.
- (b) An *Alternative Solution* will only comply with the BCA if the *Assessment Methods* used to determine compliance with the *Performance Requirements* have been satisfied.
- (c) The *Performance Requirements* relevant to an *Alternative Solution* must be determined in accordance with **A0.10**.

A0.9 Assessment Methods

The following *Assessment Methods*, or any combination of them, can be used to determine that a *Building Solution* complies with the *Performance Requirements*:

- (a) Evidence to support that the use of a material, form of construction or design meets a *Performance Requirement* or a *Deemed-to-Satisfy Provision* as described in **A2.2**.
- (b) *Verification Methods* such as—
 - (i) the *Verification Methods* in the BCA; or
 - (ii) such other *Verification Methods* as the *appropriate authority* accepts for determining compliance with the *Performance Requirements*.
- (c) Comparison with the *Deemed-to-Satisfy Provisions*.
- (d) *Expert Judgement*.

A0.10 Relevant Performance Requirements

In order to comply with the provisions of **A1.5** (to comply with Sections A to J inclusive) the following method must be used to determine the *Performance Requirement* or *Performance Requirements* relevant to the *Alternative Solution*:

- (a) Identify the relevant *Deemed-to-Satisfy Provision* of each Section or Part that is to be the subject of the *Alternative Solution*.
- (b) Identify the *Performance Requirements* from the same Sections or Parts that are relevant to the identified *Deemed-to-Satisfy Provisions*.
- (c) Identify *Performance Requirements* from other Sections and Parts that are relevant to any aspects of the *Alternative Solution* proposed or that are affected by the application of the *Deemed-to-Satisfy Provisions*, that are the subject of the *Alternative Solution*.

PART A1 INTERPRETATION

A1.1 Definitions

Note: States and Territories may vary or add to the definitions contained in **A1.1** at the relevant State or Territory Appendix.

In Volume One of the BCA unless the contrary intention appears—

Accessible means having features to enable use by people with a disability.

Accessway means a continuous *accessible* path of travel (as defined in AS 1428.1) to, into or within a building.

Aged care building means a Class 9c building for residential accommodation of aged persons who, due to varying degrees of incapacity associated with the ageing process, are provided with *personal care services* and 24 hour staff assistance to evacuate the building during an emergency.

Air-conditioning, for the purposes of **Section J**, means a *service* that actively cools or heats the air within a space, but does not include a *service* that directly cools or heats cold rooms, hot rooms or Class 8 *electricity network substations*.

Alpine area means land—

- (a) likely to be subject to significant snowfalls; and
- (b) in New South Wales, A.C.T. or Victoria more than 1200 m above the Australian Height Datum; and
- (c) in Tasmania more than 900 m above the Australian Height Datum.

Alteration, in relation to a building, includes an addition or extension to a building.

Alternative Solution means a *Building Solution* which complies with the *Performance Requirements* other than by reason of satisfying the *Deemed-to-Satisfy Provisions*.

Annual energy consumption means the theoretical amount of energy used annually by the building's *services*, excluding kitchen exhaust and the like.

(NSW, Appropriate authority)

Appropriate authority means the relevant authority with the statutory responsibility to determine the particular matter.

(NSW, Assembly building)

Assembly building means a building where people may assemble for—

- (a) civic, theatrical, social, political or religious purposes including a library, theatre, public hall or place of worship; or
- (b) educational purposes in a *school*, *early childhood centre*, preschool, or the like; or
- (c) entertainment, recreational or sporting purposes including—
 - (i) a discotheque, nightclub or a bar (area of a hotel or motel providing live entertainment or containing a dance floor); or
 - (ii) a cinema; or
 - (iii) a sports stadium, sporting or other club; or
- (d) transit purposes including a bus station, railway station, airport or ferry terminal.

Assessment Method means a method used for determining that a *Building Solution* complies with the *Performance Requirements*.

Atrium means a space within a building that connects 2 or more *storeys*, and—

- (a) is wholly or substantially enclosed at the top by a floor or roof (including a glazed roof structure); and
- (b) includes any adjacent part of the building not separated by an appropriate barrier to fire; but
- (c) does not include a stairwell, rampwell or the space within a *shaft*.

Atrium well means a space in an *atrium* bounded by the perimeter of the openings in the floors or by the perimeter of the floors and the *external walls*.

Automatic means designed to operate when activated by a heat, smoke or fire sensing device.

Average recurrence interval, applied to rainfall, means the expected or average interval between exceedances for a 5 minute duration rainfall intensity.

Average specific extinction area means the average specific extinction area for smoke as determined by AS/NZS 3837.

Backstage means a space associated with, and adjacent to, a *stage* in a Class 9b building for scenery, props, equipment, dressing rooms, or the like.

Building Solution means a solution which complies with the *Performance Requirements* and is—

- (a) an *Alternative Solution*; or
- (b) a solution which complies with the *Deemed-to-Satisfy Provisions*; or
- (c) a combination of (a) and (b).

Carpark means a building that is used for the parking of motor vehicles but is neither a *private garage* nor used for the servicing of vehicles, other than washing, cleaning or polishing.

Certificate of Accreditation means a certificate issued by a State or Territory accreditation authority stating that the properties and performance of a building material or method of construction or design fulfill specific requirements of the BCA.

Certificate of Conformity means a certificate issued under the ABCB scheme for products and systems certification stating that the properties and performance of a building material or method of construction or design fulfill specific requirements of the BCA.

Climate zone means an area defined in **Figure A1.1** and in **Table A1.1** for specific locations, having energy efficiency provisions based on a range of similar climatic characteristics.

Figure A1.1 — CLIMATE ZONES FOR THERMAL DESIGN

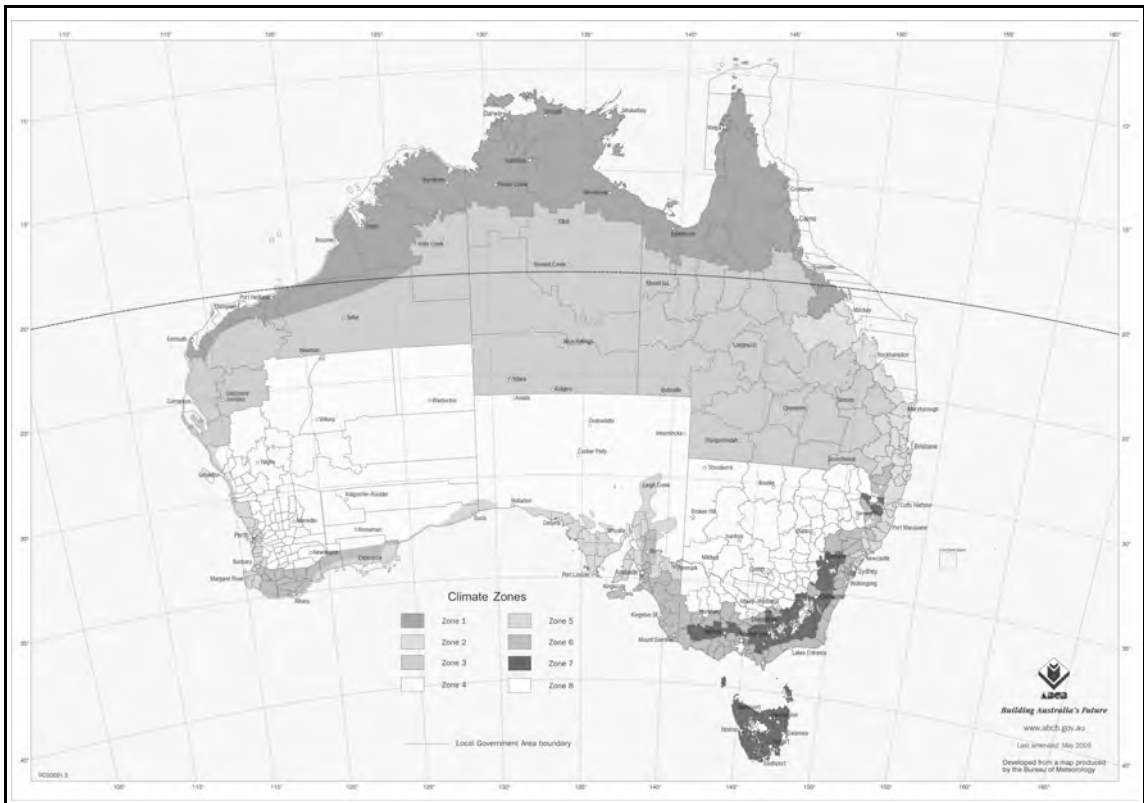

Notes:

1. This map can be viewed in enlargeable form on the Energy Efficiency page of the ABCB web site at www.abcb.gov.au.
2. A Zone 4 area in South Australia, other than a council area, at an altitude greater than 300 m above the Australian Height Datum is to be considered as Zone 5.

These areas have been defined in an enlarged format on the following maps produced by the Department of Planning, Transport and Infrastructure:

Adelaide Hills Council Climate Zone Map

Barossa Council Climate Zone Map

Regional Council of Goyder Climate Zone Map

These maps can be viewed on the Government of South Australia website at www.sa.gov.au

3. Locations in *climate zone 8* are in *alpine areas*.

Table A1.1 CLIMATE ZONES FOR THERMAL DESIGN - VARIOUS LOCATIONS

| Location | Climate zone | Location | Climate zone | Location | Climate zone | Location | Climate zone |
|-------------------------------------|--------------|-----------------|--------------|-------------------|--------------|----------------|--------------|
| Australian Capital Territory | | | | Canberra | 7 | | |
| New South Wales | | | | | | | |
| Albury | 4 | Byron Bay | 2 | Lord Howe Island | 2 | Sydney West | 6 |
| Armidale | 7 | Cobar | 4 | Moree | 4 | Tamworth | 4 |
| Batemans Bay | 6 | Coffs Harbour | 2 | Newcastle | 5 | Thredbo | 8 |
| Bathurst | 7 | Dubbo | 4 | Nowra | 6 | Wagga Wagga | 4 |
| Bega | 6 | Goulburn | 7 | Orange | 7 | Williamtown | 5 |
| Bellingen Shire - Dorrigo Plateau | 7 | Grafton | 2 | Perisher Smiggins | 8 | Wollongong | 5 |
| Bellingen Shire - Valley & seaboard | 2 | Griffith | 4 | Port Macquarie | 5 | Yass | 6 |
| Bourke | 4 | Ivanhoe | 4 | Sydney East | 5 | | |
| Broken Hill | 4 | Lismore | 2 | | | | |
| Northern Territory | | | | | | | |
| Alice Springs | 3 | Elliot | 3 | Renner Springs | 3 | | |
| Darwin | 1 | Katherine | 1 | Tennant Creek | 3 | | |
| Queensland | | | | | | | |
| Birdsville | 3 | Cunnamulla | 3 | Maryborough | 2 | Toowoomba | 5 |
| Brisbane | 2 | Longreach | 3 | Mount Isa | 3 | Torrens Creek | 3 |
| Bundaberg | 2 | Gladstone | 2 | Normanton | 1 | Townsville | 1 |
| Cairns | 1 | Labrador | 2 | Rockhampton | 2 | Warwick | 5 |
| Cooktown | 1 | Mackay | 2 | Roma | 3 | Weipa | 1 |
| South Australia | | | | | | | |
| Adelaide | 5 | Kingscote | 6 | Marree | 4 | Port Lincoln | 5 |
| Bordertown | 6 | Leigh Creek | 5 | Mount Gambier | 6 | Renmark | 5 |
| Ceduna | 5 | Lobethal | 6 | Murray Bridge | 6 | Tarcoola | 4 |
| Cook | 4 | Loxton | 5 | Oodnadatta | 4 | Victor Harbour | 6 |
| Elliston | 5 | Naracoorte | 6 | Port Augusta | 4 | Whyalla | 4 |
| Tasmania | | | | | | | |
| Burnie | 7 | Flinders Island | 7 | Launceston | 7 | Rossarden | 7 |
| Bicheno | 7 | Hobart | 7 | New Norfolk | 7 | Smithton | 7 |
| Deloraine | 7 | Huonville | 7 | Oatlands | 7 | St Marys | 7 |
| Devonport | 7 | King Island | 7 | Orford | 7 | Zeehan | 7 |

Table A1.1 CLIMATE ZONES FOR THERMAL DESIGN - VARIOUS LOCATIONS— continued

| Location | Climate zone | Location | Climate zone | Location | Climate zone | Location | Climate zone |
|--------------------------|--------------|--------------|--------------|--------------------|--------------|--------------|--------------|
| Victoria | | | | | | | |
| Anglesea | 6 | Bright | 7 | Horsham | 6 | Swan Hill | 4 |
| Ararat | 7 | Colac | 6 | Melbourne | 6 | Traralgon | 6 |
| Bairnsdale | 6 | Dandenong | 6 | Mildura | 4 | Wangaratta | 7 |
| Ballarat | 7 | Echuca | 4 | Portland | 6 | Warrnambool | 6 |
| Benalla | 6 | Geelong | 6 | Sale | 6 | Wodonga | 6 |
| Bendigo | 6 | Hamilton | 7 | Shepparton | 4 | | |
| Western Australia | | | | | | | |
| Albany | 6 | Cocos Island | 1 | Kalgoorlie-Boulder | 4 | Port Hedland | 1 |
| Balladonia | 4 | Derby | 1 | Karratha | 1 | Wagin | 4 |
| Broome | 1 | Esperance | 5 | Meekatharra | 4 | Wyndham | 1 |
| Bunbury | 5 | Exmouth | 1 | Northam | 4 | | |
| Carnarvon | 3 | Geraldton | 5 | Pemberton | 6 | | |
| Christmas Island | 1 | Halls Creek | 3 | Perth | 5 | | |

Combustible means—

- (a) Applied to a material — *combustible* as determined by AS 1530.1.
- (b) Applied to construction or part of a building — constructed wholly or in part of *combustible* materials.

Common wall means a wall that is common to adjoining buildings.

Conditioned space means a space within a building, including a ceiling or under-floor supply air plenum or return air plenum, where the environment is likely, by the intended use of the space, to have its temperature controlled by *air-conditioning*, but does not include—

- (a) a non-*habitable room* of a Class 2 building or Class 4 part of a building in which a heater with a capacity of not more than 1.2 kW or 4.3 MJ/hour provides the *air-conditioning*; or
- (b) a space in a Class 6, 7, 8 or 9b building where the input energy to an *air-conditioning* system is not more than 15 W/m² or 15 J/s.m² (54 KJ/hour.m²); or
- (c) a lift *shaft*.

Construction activity actions means actions due to stacking of building materials or the use of equipment, including cranes and trucks, during construction or actions which may be induced by floor to floor propping.

Critical radiant flux means the critical heat flux at extinguishment as determined by AS ISO 9239.1.

Curtain wall means a non-*loadbearing external wall* that is not a *panel wall*.

Deemed-to-Satisfy Provisions means provisions which are deemed to satisfy the *Performance Requirements*.

Defined flood event (DFE) means the flood event selected for the management of flood hazard for the location of specific development as determined by the *appropriate authority*.

Defined flood level (DFL) means the flood level associated with a *defined flood event* relative to a specified datum.

(NSW, Designated bushfire prone area)

Designated bushfire prone area means land which has been designated under a power of legislation as being subject, or likely to be subject, to bushfires.

Detention centre means a building in which persons are securely detained by means of the built structure including a prison, remand centre, juvenile *detention centre*, holding cells or psychiatric *detention centre*.

(NSW, Early childhood centre)

(Tas, Early childhood centre)

(Vic, Early childhood centre)

Early childhood centre means any premises or part thereof providing or intending to provide a centre-based education and care service within the meaning of the Education and Care Services National Law Act 2010 (Vic), the Education and Care Services National Regulations and centre-based services that are licensed or approved under State and Territory children's services law, but excludes education and care primarily provided to school aged children in outside school hours settings.

Effective height means the height to the floor of the topmost *storey* (excluding the topmost *storey* if it contains only heating, ventilating, lift or other equipment, water tanks or similar service units) from the floor of the lowest *storey* providing direct egress to a road or *open space*.

Electric passenger lift means a power-operated lift for raising or lowering people in a car in which the motion of the car is obtained from an electric motor mechanically coupled to the hoisting mechanism.

Electricity network substation means a building in which high voltage supply is converted or transformed and which is controlled by a licenced network service provider designated under a power of legislation.

Electrohydraulic passenger lift means a power-operated lift for raising or lowering people in a car in which the motion of the car is obtained from the action of liquid under pressure acting on a piston or ram, the pressure being generated by a pump driven by an individual electric motor.

Envelope, for the purposes of **Section J**, means the parts of a building's *fabric* that separate a *conditioned space* or *habitable room* from—

- (a) the exterior of the building; or
- (b) a non-*conditioned space* including—
 - (i) the floor of a rooftop plant room, lift-machine room or the like; and
 - (ii) the floor above a *carpark* or warehouse; and
 - (iii) the *common wall* with a *carpark*, warehouse or the like.

Equivalent means equivalent to the level of health, safety and amenity provided by the *Deemed-to-Satisfy Provisions*.

Evacuation route means the continuous path of travel (including *exits*, *public corridors* and the like) from any part of a building, including within a *sole-occupancy unit* in a Class 2 or 3 building or Class 4 part, to a *safe place*.

Evacuation time means the time calculated from when the emergency starts for the occupants of the building to evacuate to a *safe place*.

Exit means—

- (a) Any, or any combination of the following if they provide egress to a road or *open space*—
 - (i) An internal or external stairway.
 - (ii) A ramp.
 - (iii) A *fire-isolated passageway*.
 - (iv) A doorway opening to a road or *open space*.
- (b) A *horizontal exit* or a *fire-isolated passageway* leading to a *horizontal exit*.

Expert Judgement means the judgement of an expert who has the qualifications and experience to determine whether a *Building Solution* complies with the *Performance Requirements*.

External wall means an outer wall of a building which is not a *common wall*.

Fabric means the basic building structural elements and components of a building including the roof, ceilings, walls and floors.

Fan motor power means the power delivered to a motor of a fan, including the power needed for any drive and impeller losses.

Fire brigade means a statutory authority constituted under an Act of Parliament having as one of its functions, the protection of life and property from fire and other emergencies.

Fire compartment means—

- (a) the total space of a building; or
- (b) when referred to in—
 - (i) the *Objective, Functional Statement* or *Performance Requirements* — any part of a building separated from the remainder by barriers to fire such as walls and/or floors having an appropriate resistance to the spread of fire with any openings adequately protected; or
 - (ii) the *Deemed-to-Satisfy Provisions* — any part of a building separated from the remainder by walls and/or floors each having an FRL not less than that *required* for a *fire wall* for that type of construction and where all openings in the separating construction are protected in accordance with the *Deemed-to-Satisfy Provisions* of the relevant Part.

Fire hazard means the danger in terms of potential harm and degree of exposure arising from the start and spread of fire and the smoke and gases that are thereby generated.

Fire hazard properties means the following properties of a material or assembly that indicate how they behave under specific fire test conditions:

- (a) *Average specific extinction area, critical radiant flux* and *Flammability Index*, determined as defined in **A1.1**.
- (b) *Smoke-Developed Index, smoke growth rate index, smoke development rate* and *Spread-of-Flame Index*, determined in accordance with **Specification A2.4**.
- (c) *Group number*, determined in accordance with **Specification C1.10**.

Fire intensity means the rate release of calorific energy in watts, determined either theoretically or empirically, as applicable.

Fire-isolated passageway means a corridor, hallway or the like, of *fire-resisting construction*, which provides egress to or from a *fire-isolated stairway* or *fire-isolated ramp* or to a road or *open space*.

Fire-isolated ramp means a ramp within a *fire-resisting* enclosure which provides egress from a *storey*.

Fire-isolated stairway means a stairway within a *fire-resisting shaft* and includes the floor and roof or top enclosing structure.

Fire load means the sum of the net calorific values of the *combustible* contents which can reasonably be expected to burn within a *fire compartment*, including furnishings, built-in and removable materials, and building elements. The calorific values must be determined at the ambient moisture content or humidity. (The unit of measurement is MJ.)

Fire-protective covering means—

- (a) 13 mm fire-protective grade plasterboard; or
- (b) 12 mm cellulose cement flat sheeting complying with AS/NZS 2908.2 or ISO 8336; or
- (c) 12 mm fibrous plaster reinforced with 13 mm x 13 mm x 0.7 mm galvanised steel wire mesh located not more than 6 mm from the exposed face; or
- (d) other material not less fire-protective than 13 mm fire-protective grade plasterboard, fixed in accordance with the normal trade practice for a *fire-protective covering*.

Fire-resistance level (FRL) means the grading periods in minutes determined in accordance with **Specification A2.3**, for the following criteria—

- (a) *structural adequacy*; and
- (b) *integrity*; and
- (c) *insulation*,

and expressed in that order.

Note: A dash means that there is no requirement for that criterion. For example, 90/–/– means there is no requirement for an FRL for integrity and insulation, and –/–/– means there is no requirement for an FRL.

Fire-resisting, applied to a building element, means having an FRL appropriate for that element.

Fire-resisting construction means one of the Types of construction referred to in **Part C1**.

Fire safety system means one or any combination of the methods used in a building to—

- (a) warn people of an emergency; or
 - (b) provide for safe evacuation; or
 - (c) restrict the spread of fire; or
 - (d) extinguish a fire,
- and includes both active and passive systems.

Fire-source feature means—

- (a) the far boundary of a road, river, lake or the like adjoining the allotment; or
- (b) a side or rear boundary of the allotment; or
- (c) an *external wall* of another building on the allotment which is not a Class 10 building.

Fire wall means a wall with an appropriate resistance to the spread of fire that divides a *storey* or building into *fire compartments*.

Flashover, in relation to *fire hazard properties*, means a heat release rate of 1 MW.

Flammability Index means the index number as determined by AS 1530.2.

Flight means that part of a stairway that has a continuous series of risers, including risers of winders, not interrupted by a landing or floor.

Flood hazard area means the *site* (whether or not mapped) encompassing land lower than the *flood hazard level* which has been determined by the *appropriate authority*.

Flood hazard level (FHL) means the flood level used to determine the height of floors in a building and represents the *defined flood level* plus the *freeboard*.

Floor area means—

- (a) in relation to a building — the total area of all *storeys*; and
- (b) in relation to a *storey* — the area of all floors of that *storey* measured over the enclosing walls, and includes—
 - (i) the area of a *mezzanine* within the *storey*, measured within the finished surfaces of any *external walls*; and
 - (ii) the area occupied by any *internal walls* or partitions, any cupboard, or other built-in furniture, fixture or fitting; and
 - (iii) if there is no enclosing wall, an area which has a use that—
 - (A) contributes to the *fire load*; or
 - (B) impacts on the safety, health or amenity of the occupants in relation to the provisions of the BCA; and
- (c) in relation to a room — the area of the room measured within the finished surfaces of the walls, and includes the area occupied by any cupboard or other built-in furniture, fixture or fitting; and
- (d) in relation to a *fire compartment* — the total area of all floors within the *fire compartment* measured within the finished surfaces of the bounding construction, and if there is no bounding construction, includes an area which has a use which contributes to the *fire load*; and
- (e) in relation to an *atrium* — the total area of all floors within the *atrium* measured within the finished surfaces of the bounding construction and if no bounding construction, within the *external walls*.

Freeboard means the height above the *defined flood level* as determined by the *appropriate authority*, used to compensate for effects such as wave action and localised hydraulic behaviour.

Functional Statement means a statement which describes how a building achieves the *Objective*.

Glazing, for the purposes of **Section J**, means a transparent or translucent element and its supporting frame located in the *envelope*, and includes a *window* other than a *roof light*.

Group number means the number of one of 4 groups of materials used in the regulation of *fire hazard properties* and applied to materials used as a finish, surface, lining, or attachment to a wall or ceiling.

Habitable room means a room used for normal domestic activities, and—

- (a) includes a bedroom, living room, lounge room, music room, television room, kitchen, dining room, sewing room, study, playroom, family room, home theatre and sunroom; but
- (b) excludes a bathroom, laundry, water closet, pantry, walk-in wardrobe, corridor, hallway, lobby, photographic darkroom, clothes-drying room, and other spaces of a specialised nature occupied neither frequently nor for extended periods.

Health-care building means a building whose occupants or patients undergoing medical treatment generally need physical assistance to evacuate the building during an emergency and includes—

- (a) a public or private hospital; or
- (b) a nursing home or similar facility for sick or disabled persons needing full-time care; or
- (c) a clinic, day surgery or procedure unit where the effects of the predominant treatment administered involve patients becoming non-ambulatory and requiring supervised medical care on the premises for some time after the treatment.

Horizontal exit means a *required* doorway between 2 parts of a building separated from each other by a *fire wall*.

House energy rating software means software accredited under the Nationwide House Energy Rating Scheme and is limited to assessing the potential thermal efficiency of the dwelling envelope.

Illuminance means the luminous flux falling onto a unit area of surface.

Illumination power density (W/m^2) means the total of the power that will be consumed by the lights in a space, including any lamps, ballasts, current regulators and control devices other than those that are plugged into socket outlets for intermittent use such as floor standing lamps, desk lamps or work station lamps, divided by the area of the space.

Inclined lift means a power-operated device for raising or lowering people within a carriage that has one or more rigid guides on an inclined plane.

Insulation, in relation to an FRL, means the ability to maintain a temperature on the surface not exposed to the furnace below the limits specified in AS 1530.4.

Integrity, in relation to an FRL, means the ability to resist the passage of flames and hot gases specified in AS 1530.4.

Internal wall excludes a *common wall* or a party wall.

Lamp power density (W/m^2) means the total of the maximum power rating of the lamps in a space, other than those that are plugged into socket outlets for intermittent use such as floor standing lamps, desk lamps or work station lamps, divided by the area of the space.

Latent heat gain means the heat gained by the vapourising of liquid without change of temperature.

Light source efficacy means the luminous flux of a lamp or the total radiant flux in the visible spectrum weighted by the spectral response of the eye, divided by the electric power that will be consumed by the lamp but excluding ballast and control gear power losses.

Lightweight construction means construction which incorporates or comprises—

- (a) sheet or board material, plaster, render, sprayed application, or other material similarly susceptible to damage by impact, pressure or abrasion; or
- (b) concrete and concrete products containing pumice, perlite, vermiculite, or other soft material similarly susceptible to damage by impact, pressure or abrasion; or
- (c) masonry having a thickness less than 70 mm.

Loadbearing means intended to resist vertical forces additional to those due to its own weight.

Low-rise, low-speed constant pressure lift means a power-operated low-rise, low-speed device for raising or lowering people with limited mobility on a carriage that is controlled by the application of constant pressure to a control.

Low-rise platform lift means a power-operated device for raising or lowering people with limited mobility on a platform, that is controlled automatically or by the application of constant pressure to a control.

Luminance contrast means the light reflected from one surface or component, compared to the light reflected from another surface or component.

Mezzanine means an intermediate floor within a room.

Non-combustible means—

- (a) Applied to a material — not deemed *combustible* as determined by AS 1530.1 — Combustibility Tests for Materials.
- (b) Applied to construction or part of a building — constructed wholly of materials that are not deemed *combustible*.

Objective means a statement contained in the BCA which is considered to reflect community expectations.

Open-deck carpark means a carpark in which all parts of the parking *storeys* are cross-ventilated by permanent unobstructed openings in not fewer than 2 opposite or approximately opposite sides, and—

- (a) each side that provides ventilation is not less than $\frac{1}{6}$ of the area of any other side; and
- (b) the openings are not less than $\frac{1}{2}$ of the wall area of the side concerned.

Open space means a space on the allotment, or a roof or similar part of a building adequately protected from fire, open to the sky and connected directly with a public road.

Open spectator stand means a tiered stand substantially open at the front.

Other property means all or any of the following—

- (a) any building on the same or an adjoining allotment; and
- (b) any adjoining allotment; and
- (c) a road.

Outdoor air means air outside the building.

Outdoor air economy cycle is a mode of operation of an *air-conditioning* system that, when the outside air thermodynamic properties are favourable, increases the quantity of outside air used to condition the space.

Outfall means that part of the disposal system receiving *surface water* from the drainage system and may include a natural water course, kerb and channel, or soakage system.

Panel wall means a non-*loadbearing external wall*, in frame or similar construction, that is wholly supported at each *storey*.

Patient care area means a part of a *health-care building* normally used for the treatment, care, accommodation, recreation, dining and holding of patients including a *ward area* and *treatment area*.

Performance Requirement means a requirement which states the level of performance which a *Building Solution* must meet.

Personal care services means any of the following:

- (a) The provision of nursing care.
- (b) Assistance or supervision in—
 - (i) bathing, showering or personal hygiene; or
 - (ii) toileting or continence management; or
 - (iii) dressing or undressing; or
 - (iv) consuming food.
- (c) The provision of direct physical assistance to a person with mobility problems.
- (d) The management of medication.
- (e) The provision of substantial rehabilitative or development assistance.

Piping, for the purposes of **Section J**, means an assembly of pipes, with or without valves or other fittings, connected together for the conveyance of liquids and gases.

Primary building element means a member of a building designed specifically to take part of the loads specified in **B1.2** or **B1.3** and includes roof, ceiling, floor, stairway or ramp and wall framing members including bracing members designed for the specific purpose of acting as a brace to those members.

Private bushfire shelter means a structure associated with, but not attached to, or part of a Class 1a dwelling that may, as a last resort, provide shelter for occupants from immediate life threatening effects of a bushfire.

Private garage means—

- (a) any garage associated with a Class 1 building; or
- (b) any single *storey* of a building of another Class containing not more than 3 vehicle spaces, if there is only one such *storey* in the building; or
- (c) any separate single *storey* garage associated with another building where such garage contains not more than 3 vehicle spaces.

Professional engineer means a person who is—

- (a) if legislation is applicable — a registered *professional engineer* in the relevant discipline who has appropriate experience and competence in the relevant field; or
- (b) if legislation is not applicable—
 - (i) a Corporate Member of the Institution of Engineers, Australia; or
 - (ii) eligible to become a Corporate Member of the Institution of Engineers, Australia, and has appropriate experience and competence in the relevant field.

Public corridor means an enclosed corridor, hallway or the like which—

- (a) serves as a means of egress from 2 or more *sole-occupancy units* to a *required exit* from the *storey* concerned; or
- (b) is *required* to be provided as a means of egress from any part of a *storey* to a *required exit*.

Pump power means the power delivered to a pump, including the power needed for any drive.

R-Value(m².K/W) means the thermal resistance of a component calculated by dividing its thickness by its thermal conductivity.

Reference building means a hypothetical building that is used to calculate the maximum allowable annual energy load, or maximum allowable *annual energy consumption* for the proposed building.

Reflective insulation means a building membrane with a reflective surface such as a reflective foil laminate, reflective barrier, foil batt or the like capable of reducing radiant heat flow.

Registered Testing Authority means—

- (a) an organisation registered by the National Association of Testing Authorities (NATA) to test in the relevant field; or
- (b) an organisation outside Australia registered by an authority recognised by NATA through a mutual recognition agreement; or
- (c) an organisation recognised as being a *Registered Testing Authority* under legislation at the time the test was undertaken.

Renewable energy means energy that is derived from sources that are regenerated, replenished, or for all practical purposes cannot be depleted and the energy sources include, but are not limited to, solar, wind, hydroelectric, wave action and geothermal.

Required means *required* to satisfy a *Performance Requirement* or a *Deemed-to-Satisfy Provision* of the BCA as appropriate.

Residential aged care building means a building whose residents, due to their incapacity associated with the ageing process, are provided with physical assistance in conducting their daily activities and to evacuate the building during an emergency.

Resident use area means part of a Class 9c *aged care building* normally used by residents, and—

- (a) includes *sole-occupancy units*, lounges, dining areas, activity rooms and the like; but
- (b) excludes offices, storage areas, commercial kitchens, commercial laundries and other spaces not for the use of residents.

Resistance to the incipient spread of fire, in relation to a ceiling membrane, means the ability of the membrane to insulate the space between the ceiling and roof, or ceiling and floor above, so as to limit the temperature rise of materials in this space to a level which will not permit the rapid and general spread of fire throughout the space.

Rise in storeys means the greatest number of *storeys* calculated in accordance with **C1.2**.

Roof light, for the purposes of **Section J** and **Part F4**, means a skylight, *window* or the like installed in a roof—

- (a) to permit natural light to enter the room below; and
- (b) at an angle between 0 and 70 degrees measured from the horizontal plane.

Safe place means—

- (a) a place of safety within a building—
 - (i) which is not under threat from a fire; and
 - (ii) from which people must be able to safely disperse after escaping the effects of an emergency to a road or *open space*; or
- (b) a road or *open space*.

Safety measure means any measure (including an item of equipment, form of construction or safety strategy) *required* to ensure the safety of persons using the building.

Sanitary compartment means a room or space containing a closet pan or urinal.

Sarking-type material means a material such as a *reflective insulation* or other flexible membrane of a type normally used for a purpose such as water proofing, vapour proofing or thermal reflectance.

School includes a primary or secondary *school*, college, university or similar educational establishment.

Self-closing, applied to a door, means equipped with a device which returns the door to the fully closed position immediately after each opening.

Sensible heat gain means the heat gained which causes a change in temperature.

Service, for the purposes of **Part I2** and **Section J**, means a mechanical or electrical system that uses energy to provide *air-conditioning*, mechanical ventilation, hot water supply, artificial lighting, vertical transport and the like within a building, but which does not include—

- (a) systems used solely for emergency purposes; and
- (b) cooking facilities; and
- (c) portable appliances.

Service station means a garage which is not a *private garage* and is for the servicing of vehicles, other than only washing, cleaning or polishing.

Shaft means the walls and other parts of a building bounding—

- (a) a well, other than an *atrium well*; or
- (b) a vertical chute, duct or similar passage, but not a chimney or flue.

Shower area means the area affected by water from a shower, including a shower over a bath.

Site means the part of the allotment of land on which a building stands or is to be erected.

Sitework means work on or around a *site*, including earthworks, preparatory to or associated with the construction, *alteration*, demolition or removal of a building.

Small-sized, low-speed automatic lift means a restricted use power-operated device for the infrequent raising or lowering of people with limited mobility on a platform that is controlled automatically but has the capability of being electrically isolated by a key-lockable control.

Smoke-and-heat vent means a vent, located in or near the roof for smoke and hot gases to escape if there is a fire in the building.

Smoke-Developed Index means the index number for smoke as determined by AS/NZS 1530.3.

Smoke development rate means the development rate for smoke as determined by testing flooring materials in accordance with AS ISO 9239.1.

Smoke growth rate index (SMOGR_{RC}) means the index number for smoke used in the regulation of *fire hazard properties* and applied to materials used as a finish, surface, lining or attachment to a wall or ceiling.

Sole-occupancy unit means a room or other part of a building for occupation by one or joint owner, lessee, tenant, or other occupier to the exclusion of any other owner, lessee, tenant, or other occupier and includes—

- (a) a dwelling; or
- (b) a room or suite of rooms in a Class 3 building which includes sleeping facilities; or
- (c) a room or suite of associated rooms in a Class 5, 6, 7, 8 or 9 building; or
- (d) a room or suite of associated rooms in a Class 9c *aged care building*, which includes sleeping facilities and any area for the exclusive use of a resident.

Spread-of-Flame Index means the index number for spread of flame as determined by AS/NZS 1530.3.

Stage means a floor or platform in a Class 9b building on which performances are presented before an audience.

Stairway platform lift means a power-operated device for raising or lowering people with limited mobility on a platform (with or without a chair) in the direction of a stairway.

Standard Fire Test means the Fire-resistance Tests of Elements of Building Construction as described in AS 1530.4.

Storey means a space within a building which is situated between one floor level and the floor level next above, or if there is no floor above, the ceiling or roof above, but not—

- (a) a space that contains only—
 - (i) a lift *shaft*, stairway or meter room; or
 - (ii) a bathroom, shower room, laundry, water closet, or other *sanitary compartment*; or
 - (iii) accommodation intended for not more than 3 vehicles; or
 - (iv) a combination of the above; or
- (b) a *mezzanine*.

Structural adequacy, in relation to an FRL, means the ability to maintain stability and adequate *loadbearing* capacity as determined by AS 1530.4.

Surface water means all naturally occurring water, other than sub-*surface water*, which results from rainfall on or around the *site* or water flowing onto the *site*.

Swimming pool means any excavation or structure containing water and used primarily for swimming, wading, paddling, or the like, including a bathing or wading pool, or spa.

Total R-Value means the sum of the *R-Values* of the individual component layers in a composite element including any building material, insulating material, airspace and associated surface resistances.

Total System Solar Heat Gain Coefficient (SHGC) means the fraction of incident irradiance on *glazing* or a *roof light* that adds heat to a building's space.

Total System U-Value (W/m².K) means the thermal transmittance of the composite element allowing for the effect of any airspaces and associated surface resistances.

Treatment area means an area within a *patient care area* such as an operating theatre and rooms used for recovery, minor procedures, resuscitation, intensive care and coronary care from which a patient may not be readily moved.

Verification Method means a test, inspection, calculation or other method that determines whether a *Building Solution* complies with the relevant *Performance Requirements*.

Vessel means an open, pre-formed, pre-finished concave receptacle capable of holding water, usually for the purpose of washing, including a basin, sink, bath, laundry tub and the like.

Ward area means that part of a *patient care area* for resident patients and may contain areas for accommodation, sleeping, associated living and nursing facilities.

Waterproof means the property of a material that does not allow moisture to penetrate through it.

Water resistant means the property of a system or material that restricts moisture movement and will not degrade under conditions of moisture.

Wet area means an area within a building supplied with water from a water supply system, which includes bathrooms, showers, laundries and *sanitary compartments* and excludes kitchens, bar areas, kitchenettes or domestic food and beverage preparation areas.

Window includes a roof light, glass panel, glass block or brick, glass louvre, glazed sash, glazed door, or other device which transmits natural light directly from outside a building to the room concerned when in the closed position.

A1.2 Adoption of Standards and other references

Where a *Deemed-to-Satisfy Provision* references a document, rule, specification or provision, that adoption does not include a provision—

- (a) specifying or defining the respective rights, responsibilities or obligations as between themselves of any manufacturer, supplier or purchaser; or
- (b) specifying the responsibilities of any trades person or other building operative, architect, engineer, authority, or other person or body; or
- (c) requiring the submission for approval of any material, building component, form or method of construction, to any person, authority or body other than a person or body empowered under State or Territory legislation to give that approval; or
- (d) specifying that a material, building component, form or method of construction must be submitted to any person, authority or body for expression of opinion; or
- (e) permitting a departure from the code, rule, specification or provision at the sole discretion of the manufacturer or purchaser, or by arrangement or agreement between the manufacturer and purchaser.

A1.3 Referenced Standards, etc

- (a) A reference in a *Deemed-to-Satisfy Provision* to a document under **A1.2** refers to the edition or issue, together with any amendment, listed in **Specification A1.3** and only so much as is relevant in the context in which the document is quoted.
- (b) Any—
 - (i) reference in a document listed in **Specification A1.3** (primary document) to another document (secondary document); and
 - (ii) subsequent references to other documents in secondary documents and those other documents,

is a reference to the secondary and other documents as they existed at the time of publication of the primary document listed in **Specification A1.3**.

- (c) The provisions of **(b)** do not apply if the secondary referenced document is also a primary referenced document.
- (d) Where the BCA references a document under **A1.2** which is subject to publication of a new edition or amendment not listed under **Specification A1.3**, the new edition or amendment need not be complied with in order to comply with the *Deemed-to-Satisfy Provisions*.

A1.4 Differences between referenced documents and the BCA

The BCA overrules in any difference arising between it and any Standard, rule, specification or provision in a document listed in **Specification A1.3**.

A1.5 Compliance with all Sections of the BCA

Subject to **A1.6**, Class 2–9 buildings must be so designed and constructed that they comply with the relevant provisions of Sections **A** to **J** (inclusive) of the BCA.

A1.6 Application of the BCA to a particular State or Territory

For application within a particular State or Territory, the BCA comprises—

- (a) Sections **A** to **J** (inclusive); and
- (b) the variations, deletions and additions to Sections **A** to **J** applicable to that State or Territory specified in the relevant Appendix.

A1.7 Language

- (a) A reference to a building in the BCA is a reference to an entire building or part of a building, as the case requires.
- (b) A reference in a *Performance Requirement* of the BCA to “the degree necessary” means that consideration of all the criteria referred to in the *Performance Requirement* will determine the outcome appropriate to the circumstances. These words have been inserted to indicate that in certain situations it may not be necessary to incorporate any specific measures to meet the *Performance Requirement*.
- (c) A reference to “BCA” in this volume, other than in the **Introduction**, means “Volume One of the Building Code of Australia”.

PART A2

ACCEPTANCE OF DESIGN AND CONSTRUCTION

A2.1 Suitability of materials

Every part of a building must be constructed in an appropriate manner to achieve the requirements of the BCA, using materials that are fit for the purpose for which they are intended.

A2.2 Evidence of suitability

- (a) Subject to [A2.3](#) and [A2.4](#), evidence to support that the use of a material, form of construction or design meets a *Performance Requirement* or a *Deemed-to-Satisfy Provision* may be in the form of one or a combination of the following:
- (i) A report issued by a *Registered Testing Authority*, showing that the material or form of construction has been submitted to the tests listed in the report, and setting out the results of those tests and any other relevant information that demonstrates its suitability for use in the building.
 - (ii) A current *Certificate of Conformity* or a current *Certificate of Accreditation*.
 - (iii) A certificate from a *professional engineer* or other appropriately qualified person which—
 - (A) certifies that a material, design, or form of construction complies with the requirements of the BCA; and
 - (B) sets out the basis on which it is given and the extent to which relevant specifications, rules, codes of practice or other publications have been relied upon.
 - (iv) A current certificate issued by a product certification body that has been accredited by the Joint Accreditation System of Australia and New Zealand (JAS-ANZ).
 - (v) * * * * *
 - (vi) Any other form of documentary evidence that correctly describes the properties and performance of the material,
- (b) Evidence to support that a calculation method complies with an ABCB protocol may be in the form of one or a combination of the following:
- (i) A certificate from a *professional engineer* or other appropriately qualified person which—
 - (A) certifies that the calculation method complies with a relevant ABCB protocol; and
 - (B) sets out the basis on which it is given and the extent to which relevant specifications, rules, codes of practice and other publications have been relied upon.
 - (ii) Any other form of documentary evidence that correctly describes how the calculation method complies with a relevant ABCB protocol.
- (c) Any copy of documentary evidence submitted, must be a complete copy of the original report or document.

A2.3 Fire-resistance of building elements

Where a *Deemed-to-Satisfy Provision* requires a building element to have an FRL, it must be determined in accordance with **Specification A2.3**.

A2.4 Fire hazard properties

Where a *Deemed-to-Satisfy Provision* requires a building component or assembly to have a *fire hazard property* it must be determined as follows:

- (a) For *average specific extinction area*, *critical radiant flux* or *Flammability Index* — as defined in **A1.1**.
- (b) For *Smoke-Developed Index*, *Spread-of-Flame Index*, a material's *group number* or *smoke growth rate index* (SMOGR_{RC}) — in accordance with **Specification A2.4**.

A2.5 Resistance to the incipient spread of fire

A ceiling is deemed to have the *resistance to the incipient spread of fire* to the space above itself if—

- (a) it is identical with a prototype that has been submitted to the *Standard Fire Test* and the *resistance to the incipient spread of fire* achieved by the prototype is confirmed in a report from a *Registered Testing Authority* which—
 - (i) describes the method and conditions of the test and form of construction of the tested prototype in full; and
 - (ii) certifies that the application of restraint to the prototype complies with the *Standard Fire Test*; or
- (b) it differs in only a minor degree from a prototype tested under **(a)** and the *resistance to the incipient spread of fire* attributed to the ceiling is confirmed in a report from a *Registered Testing Authority* which—
 - (i) certifies that the ceiling is capable of achieving the *resistance to the incipient spread of fire* despite the minor departures from the tested prototype; and
 - (ii) describes the materials, construction and conditions of restraint which are necessary to achieve the *resistance to the incipient spread of fire*.

ACT A02 to A2.102

PART A3

CLASSIFICATION OF BUILDINGS AND STRUCTURES

A3.1 Principles of classification

The classification of a building or part of a building is determined by the purpose for which it is designed, constructed or adapted to be used.

A3.2 Classifications

Buildings are classified as follows:

Class 1: one or more buildings which in association constitute—

- (a) **Class 1a** — a single dwelling being—
 - (i) a detached house; or
 - (ii) one of a group of two or more attached dwellings, each being a building, separated by a *fire-resisting* wall, including a row house, terrace house, town house or villa unit; or
- (b) **Class 1b** —
 - (i) a boarding house, guest house, hostel or the like—
 - (A) with a total area of all floors not exceeding 300 m² measured over the enclosing walls of the Class 1b; and
 - (B) in which not more than 12 persons would ordinarily be resident; or
 - (ii) 4 or more single dwellings located on one allotment and used for short-term holiday accommodation,

which are not located above or below another dwelling or another Class of building other than a *private garage*.

Class 2: a building containing 2 or more *sole-occupancy units* each being a separate dwelling.

Class 3: a residential building, other than a building of Class 1 or 2, which is a common place of long term or transient living for a number of unrelated persons, including—

- (a) a boarding house, guest house, hostel, lodging house or backpackers accommodation; or
- (b) a residential part of a hotel or motel; or
- (c) a residential part of a *school*; or
- (d) accommodation for the aged, children or people with disabilities; or
- (e) a residential part of a *health-care building* which accommodates members of staff; or
- (f) a residential part of a *detention centre*.

Class 4: a dwelling in a building that is Class 5, 6, 7, 8 or 9 if it is the only dwelling in the building.

Class 5: an office building used for professional or commercial purposes, excluding buildings of Class 6, 7, 8 or 9.

NSW Class 6

Class 6: a shop or other building for the sale of goods by retail or the supply of services direct to the public, including—

- (a) an eating room, café, restaurant, milk or soft-drink bar; or
- (b) a dining room, bar area that is not an *assembly building*, shop or kiosk part of a hotel or motel; or
- (c) a hairdresser's or barber's shop, public laundry, or undertaker's establishment; or
- (d) market or sale room, showroom, or *service station*.

Class 7: a building which is—

- (a) **Class 7a** — a *carpark*; or
- (b) **Class 7b** — for storage, or display of goods or produce for sale by wholesale.

Class 8: a laboratory, or a building in which a handicraft or process for the production, assembling, altering, repairing, packing, finishing, or cleaning of goods or produce is carried on for trade, sale, or gain.

Class 9: a building of a public nature—

- (a) **Class 9a** — a *health-care building*, including those parts of the building set aside as a laboratory; or
- (b) **Class 9b** — an *assembly building*, including a trade workshop, laboratory or the like in a primary or secondary *school*, but excluding any other parts of the building that are of another Class; or
- (c) **Class 9c** — an *aged care building*.

Class 10: a non-habitable building or structure—

- (a) **Class 10a** — a non-habitable building being a *private garage*, carport, shed, or the like; or
- (b) **Class 10b** — a structure being a fence, mast, antenna, retaining or free-standing wall, *swimming pool*, or the like; or
- (c) **Class 10c** — a *private bushfire shelter*.

A3.3 Multiple classification

Each part of a building must be classified separately, and—

- (a)
 - (i) where parts have different purposes — if not more than 10% of the *floor area* of a *storey*, being the minor use, is used for a purpose which is a different classification, the classification applying to the major use may apply to the whole storey; and
 - (ii) the provisions of (i) do not apply when the minor use is a laboratory or Class 2, 3 or 4 part; and
- (b) Classes 1a, 1b, 7a, 7b, 9a, 9b, 9c, 10a, 10b and 10c are separate classifications; and
- (c) a reference to—
 - (i) Class 1 — is to Class 1a and 1b; and
 - (ii) Class 7 — is to Class 7a and 7b; and
 - (iii) Class 9 — is to Class 9a, 9b and 9c; and

- (iv) Class 10 — is to Class 10a, 10b and 10c; and
- (d) A plant room, machinery room, lift motor room, boiler room or the like must have the same classification as the part of the building in which it is situated.

A3.4 Parts with more than one classification

- (a) Notwithstanding **A3.3**, a building or part of a building may have more than one classification applying to the whole building or to the whole of that part of the building.
- (b) If a building or part of a building has more than one classification applying to the whole building or part in accordance with **(a)**, that building or part must comply with all the relevant provisions of the BCA for each classification.

PART **A4**

UNITED BUILDINGS

A4.1 When buildings are united

Two or more buildings adjoining each other form one united building if they—

- (a) are connected through openings in the walls dividing them; and
- (b) together comply with all the requirements of the BCA as though they are a single building.

A4.2 Alterations in a united building

If, after *alterations* or any other building work, two or more of the buildings in **A4.1** cease to be connected through openings in the dividing walls, each of those buildings not now connected must comply with all the requirements for a single building.

SPECIFICATION **A1.3** DOCUMENTS ADOPTED BY REFERENCE

1. Schedule of referenced documents

ACT, NSW, NT, QLD, SA, Tas, Vic Spec A1.3 Table 1

The Standards and other documents listed in **Table 1** are referred to in Volume One of the BCA.

Table 1: SCHEDULE OF REFERENCED DOCUMENTS

| No. | Date | Title | BCA Clause(s) |
|----------------------------------|------|--|------------------------------|
| AS/ISO 717 Part 2 | 2004 | Acoustics — Rating of sound insulation in buildings and building elements Impact sound insulation | F5.3 |
| AS/NZS 1170 Part 0 | 2002 | Structural design actions General principles Amdt 1 Amdt 3 Amdt 4 | B1.1, B1.2, Spec B1.2 |
| Part 1 | 2002 | Permanent, imposed and other actions Amdt 1 Amdt 2 | B1.2 |
| Part 2 | 2011 | Wind actions Amdt 1 Amdt 2 | B1.2, Spec B1.2 |
| Part 3 | 2003 | Snow and ice actions Amdt 1 | B1.2 |
| AS 1170 Part 4 | 2007 | Structural design actions Earthquake actions in Australia | B1.2 |
| AS 1191 | 2002 | Acoustics — Method for laboratory measurement of airborne sound insulation of building elements | Spec F5.5 |
| AS/NZS 1200 | 2000 | Pressure equipment | G2.2 |

Table 1: SCHEDULE OF REFERENCED DOCUMENTS— continued

| No. | Date | Title | BCA Clause(s) |
|---|--|---|--|
| AS/NZS 1276 Part 1 | 1999 | Acoustics — Rating of sound insulation in buildings and of building elements Airborne sound insulation [Note: Test reports based on AS1276 – 1979 and issued prior to AS/NZS 1276.1 – 1999 being referenced in the BCA, remain valid. The STC values in reports based on AS 1276 – 1979 shall be considered to be equivalent to R _w values. Test reports prepared after the BCA reference date for AS/NZS 1276.1 – 1999 must be based on that version] | F5.2 |
| AS 1288 | 2006 | Glass in buildings — Selection and Installation Amdt 1 Amdt 2 | B1.4, Spec C2.5, Spec C3.4 |
| AS 1428 Part 1 Part 1 Part 1 (Supplement 1) Part 2 Part 4 | 2009 2001 1993 1992 1992 | Design for access and mobility General requirements for access — New building work Amdt 1 General requirements for access — New building work General requirements for access — Buildings — Commentary Enhanced and additional requirements — Buildings and facilities Tactile ground surface indicators for orientation of people with vision impairment | A1.1, D2.10, D2.15, D2.17, D3.1, D3.2, D3.3, D3.6, D3.8, D3.9, D3.10, D3.12, Spec D3.10, E3.8, F2.4, G4.5 H2.7, H2.8, H2.10, H2.15 H2.2 H2.2, H2.3, H2.4, H2.5, H2.7, H2.10, H2.11, H2.12, H2.13, H2.14 H2.11 |
| AS/NZS 1428 | | Design for access and mobility | |

Table 1: SCHEDULE OF REFERENCED DOCUMENTS— continued

| No. | Date | Title | BCA Clause(s) |
|--------------------|------|--|--|
| Part 4.1 | 2009 | Means to assist the orientation of people with vision impairment — Tactile ground surface indicators Amdt 1 | D3.8 |
| AS 1530 | | Methods for fire tests on building materials, components and structures | |
| Part 1 | 1994 | Combustibility test for materials | A1.1 |
| Part 2 | 1993 | Test for flammability of materials Amdt 1 | A1.1 |
| Part 4 | 2005 | Fire-resistance tests on elements of construction [Note: Subject to the note to AS 4072.1, reports relating to tests carried out under earlier editions of AS 1530 Parts 1 to 4 remain valid. Reports relating to tests carried out after the date of an amendment to a Standard must relate to the amended Standard] | A1.1, C3.15, C3.16, Spec A2.4, Spec C3.15 |
| AS/NZS 1530 | | Methods for fire tests on building materials, components and structures | |
| Part 3 | 1999 | Simultaneous determination of ignitability, flame propagation, heat release and smoke release | A1.1, Spec A2.4 |
| AS 1562 | | Design and installation of sheet roof and wall cladding | |
| Part 1 | 1992 | Metal Amdt 1 Amdt 2 Amdt 3 | B1.4, F1.5 |
| AS/NZS 1562 | | Design and installation of sheet roof and wall cladding | |
| Part 2 | 1999 | Corrugated fibre-reinforced cement | F1.5 |
| Part 3 | 1996 | Plastics | B1.4, F1.5 |

Table 1: SCHEDULE OF REFERENCED DOCUMENTS— continued

| No. | Date | Title | BCA Clause(s) |
|------------------------------|------|--|---|
| AS 1657 | 1992 | Fixed platforms, walkways, stairways and ladders — Design, construction and installation (SAA Code for Fixed Platforms, Walkways, Stairways and Ladders) | D1.16, D2.18, H1.6 |
| AS/NZS 1664 Part 1 | 1997 | Aluminium structures Limit state design Amdt 1 | B1.4 |
| Part 2 | 1997 | Allowable stress design Amdt 1 | B1.4 |
| AS/NZS 1668 Part 1 | 1998 | The use of ventilation and airconditioning in buildings Fire and smoke control in multi-compartment buildings Amdt 1 | C2.12, C3.15, Spec C2.5, D1.7, Spec E1.8, E2.2, Spec E2.2a, F4.12, Spec G3.8 |
| AS 1668 Part 2 | 1991 | The use of mechanical ventilation and air-conditioning in buildings Mechanical ventilation for acceptable indoor-air quality | F4.5, F4.11, F4.12, J5.2 |
| AS 1668 Part 2 | 2012 | The use of ventilation and airconditioning in buildings Mechanical ventilation in buildings | F4.5, F4.11, F4.12, J5.2 |
| AS 1670 Part 1 | 2004 | Fire detection, warning, control and intercom systems — Systems design, installation and commissioning Fire Amdt 1 | C3.5, C3.6, C3.7, C3.8, C3.11, D2.21, G4.8, Spec C3.4, Spec E2.2a, Spec G3.8 |
| Part 3 | 2004 | Fire alarm monitoring | Spec E2.2a |

Table 1: SCHEDULE OF REFERENCED DOCUMENTS—continued

| No. | Date | Title | BCA Clause(s) |
|--------------------|------|---|--------------------------|
| Part 4 | 2004 | Sound systems and intercom systems for emergency purposes | E4.9, Spec G3.8 |
| AS/NZS 1680 | | Interior lighting | |
| Part 0 | 2009 | Safe Movement | F4.4 |
| AS 1684 | | Residential timber-framed construction | |
| Part 2 | 2010 | Non-cyclonic areas | B1.4, B1.5, F1.12 |
| | | Amdt 1 | |
| Part 3 | 2010 | Cyclonic areas | B1.4, B1.5, F1.12 |
| | | Amdt 1 | |
| Part 4 | 2010 | Simplified — non-cyclonic areas | B1.4, B1.5, F1.12 |
| | | Amdt 1 | |
| AS 1720 | | Timber structures | |
| Part 1 | 2010 | Design methods | B1.4 |
| | | Amdt 1 | |
| | | Amdt 2 | |
| Part 4 | 1990 | Fire resistance of structural timber | Spec A2.3 |
| AS 1735 | | Lifts, escalators and moving walks | |
| Part 11 | 1986 | Fire-rated landing doors | C3.10 |
| Part 12 | 1999 | Facilities for persons with disabilities | E3.6, H2.6 |
| | | Amdt 1 | |
| AS 1860 | | Particleboard flooring | |
| Part 2 | 2006 | Installation | B1.4 |
| AS 1905 | | Components for the protection of openings in fire-resistant walls | |
| Part 1 | 2005 | Fire-resistant doorsets | C3.6, Spec C3.4 |
| Part 2 | 2005 | Fire-resistant roller shutters | Spec C3.4 |
| AS 1926 | | Swimming pool safety | |
| Part 1 | 2012 | Safety barriers for swimming pools | G1.1, G1.3 |

Table 1: SCHEDULE OF REFERENCED DOCUMENTS— continued

| No. | Date | Title | BCA Clause(s) |
|----------------|------|---|--------------------------|
| Part 2 | 2007 | Location of safety barriers for swimming pools Amdt 1 Amdt 2 | G1.1 |
| Part 3 | 2010 | Water recirculation systems Amdt 1 | G1.1 |
| AS 2047 | 1999 | Windows in buildings — Selection and installation Amdt 1 Amdt 2 | B1.4, F1.13, J3.4 |
| AS 2049 | 2002 | Roof tiles Amdt 1 | B1.4, F1.5 |
| AS 2050 | 2002 | Installation of roof tiles Amdt 1 Amdt 2 | B1.4, F1.5 |
| AS 2118 | | Automatic fire sprinkler systems | |
| Part 1 | 1999 | General requirements Amdt 1 | Spec E1.5 |
| Part 4 | 1995 | Residential | Spec E1.5 |
| Part 4 | 2012 | Sprinkler protection for accommodation buildings not exceeding four storeys in height | Spec E1.5 |
| Part 6 | 1995 | Combined sprinkler and hydrant | Spec E1.5 |
| Part 6 | 2012 | Combined sprinkler and hydrant systems in multistorey buildings | Spec E1.5 |
| AS 2159 | 2009 | Piling — Design and installation Amdt 1 | B1.4 |
| AS 2293 | | Emergency escape lighting and exit signs for buildings | |
| Part 1 | 2005 | System design, installation and operation Amdt 1 | E4.4, E4.8 |
| AS 2327 | | Composite structures | |
| Part 1 | 2003 | Simply supported beams | Spec A2.3, B1.4 |
| AS 2419 | | Fire hydrant installations | |

Table 1: SCHEDULE OF REFERENCED DOCUMENTS— continued

| No. | Date | Title | BCA Clause(s) |
|--|------------------|--|----------------------------------|
| Part 1 | 2005 | System design, installation and commissioning Amdt 1 | C2.12, E1.3 |
| AS 2441 | 2005 | Installation of fire hose reels Amdt 1 | E1.4 |
| AS 2444 | 2001 | Portable fire extinguishers and fire blankets — Selection and location | E1.6 |
| AS 2665 | 2001 | Smoke/heat venting systems — Design, installation and commissioning | Spec E2.2c, Spec G3.8 |
| AS 2870 | 2011 | Residential slabs and footings | F1.10 |
| AS/NZS 2890 Part 6 | 2009 | Parking facilities Off-street parking for people with disabilities | D3.5 |
| AS/NZS 2904 | 1995 | Damp-proof courses and flashings Amdt 1 Amdt 2 | F1.9 |
| AS/NZS 2908 Part 1 Part 2 | 2000 2000 | Cellulose cement products Corrugated sheets Flat sheets | B1.4, F1.5 A1.1 |
| AS/NZS 2918 | 2001 | Domestic solid-fuel burning appliances — Installation | G2.2 |
| AS/NZS 3013 | 2005 | Electrical installations — Classification of the fire and mechanical performance of wiring system elements | C2.13 |
| AS/NZS 3500 Part 3 Part 4 | 2003 2003 | National plumbing and drainage Stormwater drainage Amdt 1 Amdt 2 Amdt 3 Heated water services Amdt 1 Amdt 2 | F1.1 J7.2 |
| AS 3600 | 2009 | Concrete structures | Spec A2.3, B1.4 |

Table 1: SCHEDULE OF REFERENCED DOCUMENTS— continued

| No. | Date | Title | BCA Clause(s) |
|------------------------------|------|--|--|
| | | Amdt 1 | |
| AS 3660 Part 1 | 2000 | Termite management New building work | B1.4, F1.9 |
| AS/NZS 3666 Part 1 | 2011 | Air-handling and water systems of buildings — Microbial control Design, installation and commissioning | F2.7, F4.5 |
| Part 2 | 2011 | Operation and maintenance | I1.2 |
| AS 3700 | 2011 | Masonry structures | Spec A2.3, B1.4 |
| AS 3740 | 2010 | Waterproofing of domestic wet areas Amdt 1 | F1.7 |
| AS 3786 | 1993 | Smoke alarms Amdt 1 Amdt 2 Amdt 3 Amdt 4 | Spec E2.2a |
| AS 3823 Part 1.2 | 2001 | Performance of electrical appliances - Airconditioners and heat pumps Test Methods — Ducted airconditioners and air-to-air heat pumps — Testing and rating for performance Amdt 1 Amdt 2 Amdt 3 Amdt 4 | JV3, J5.4 |
| AS/NZS 3837 | 1998 | Method of test for heat and smoke release rates for materials and products using an oxygen consumption calorimeter | A1.1, Spec A2.4, Spec C1.10 |
| AS 3959 | 2009 | Construction of buildings in bushfire-prone areas Amdt 1 Amdt 2 Amdt 3 | G5.2 |

Table 1: SCHEDULE OF REFERENCED DOCUMENTS— continued

| No. | Date | Title | BCA Clause(s) |
|--|--|---|------------------------------|
| AS 4072 Part 1 | 2005 | Components for the protection of openings in fire-resistant separating elements Service penetrations and control joints Amdt 1 [Note: Systems tested to AS 1530.4 prior to 1 January 1995 need not be retested to comply with the provisions in AS 4072.1] | C3.15 |
| AS 4100 | 1998 | Steel Structures Amdt 1 | Spec A2.3, B1.4 |
| AS/NZS 4200 Part 1 Part 2 | 1994 1994 | Pliable building membranes and underlays Materials Amdt 1 Installation requirements | F1.6 |
| AS 4254 Part 1 Part 2 | 2012 2012 | Ductwork for air-handling systems in buildings Flexible duct Rigid duct | Spec C1.10, Spec J5.2 |
| AS/NZS 4256 Part 1 Part 2 Part 3 Part 5 | 1994 1994 1994 1996 | Plastic roof and wall cladding materials General requirements Unplasticized polyvinyl chloride (uPVC) building sheets Glass fibre reinforced polyester (GRP) Polycarbonate | B1.4, F1.5 |
| AS/NZS 4505 | 2012 | Garage doors and other large access doors | B1.4 |
| AS/NZS 4600 | 2005 | Cold-formed steel structures Amdt 1 | B1.4 |
| AS 4654 Part 1 Part 2 | 2012 2012 | Waterproofing membranes for external above-ground use Materials Design and installation | F1.4 |

Table 1: SCHEDULE OF REFERENCED DOCUMENTS— continued

| No. | Date | Title | BCA Clause(s) |
|----------------------------------|------|--|---|
| AS/NZS 4859 Part 1 | 2002 | Materials for the thermal insulation of buildings General criteria and technical provisions Amdt 1 | J1.2, Spec J5.2, Spec J5.4 |
| AS ISO 9239 Part 1 | 2003 | Reaction to fire tests for flooring Determination of the burning behaviour using a radiant heat source | A1.1 |
| AS ISO 9705 | 2003 | Fire tests — Full-scale room test for surface products | Spec A2.4, Spec C1.10 |
| AIRAH-DA09 | 1998 | Air Conditioning Load Estimation | Spec JV |
| AISC | 1987 | Guidelines for assessment of fire resistance of structural steel members | Spec A2.3 |
| ASTM D3018-90 | 1994 | Class A asphalt shingles surfaced with mineral granules | B1.4, F1.5 |
| ASTM E72-80 | 1981 | Standard method of conducting strength tests of panels for building construction | Spec C1.8 |
| ASTM E695-79 | 1985 | Standard method of measuring relative resistance of wall, floor and roof construction to impact loading | Spec C1.8 |
| AHRI 460 | 2005 | Remote mechanical-draft air-cooled refrigerant condensers | J5.4 |
| AHRI 550/590 | 2003 | Water chilling packages using the vapour compression cycle | JV3, J5.4 |
| BS 7190 | 1989 | Assessing thermal performance of low temperature hot water boilers using a test rig | JV3, J5.4 |
| ABCB | 2006 | Protocol for Building Energy Analysis Software Version 2006.1 | JV3 |
| ABCB | 2011 | Protocol for Structural Software, Version 2011.1 | B1.5 |
| ABCB | 2012 | Standard for Construction of Buildings in Flood Hazard Areas, Version 2012.2 | B1.6 |
| CIBSE Guide A | 2006 | Environmental design | Spec JV |

Table 1: SCHEDULE OF REFERENCED DOCUMENTS— continued

| No. | Date | Title | BCA Clause(s) |
|---|-------|---|-------------------|
| Disability Standards for Accessible Public Transport | 2002 | | H2.1 |
| Education and Care Services National Law Act (Vic) | 2010 | | A1.1 |
| ISO 140 Part 6 | 1998E | Acoustics — Measurement of sound insulation in buildings and of building elements Laboratory measurements of impact sound insulation of floors | Spec F5.5 |
| ISO 540 | 2008 | Hard coal and coke — Determination of ash fusibility | Spec C3.15 |
| ISO 717 Part 1 | 1996 | Acoustics — Rating of sound insulation in buildings and of building elements Airborne sound insulation | F5.2 |
| ISO 8336 | 1993E | Fibre cement flat sheets | A1.1 |
| NASH Standard Part 1 | 2005 | Residential and low-rise steel framing Design criteria Amdt A Amdt B Amdt C | B1.4 |

SPECIFICATION **A2.3** FIRE-RESISTANCE OF BUILDING ELEMENTS

1. Scope

This Specification sets out the procedures for determining the FRL of building elements.

2. Rating

A building element meets the requirements of this Specification if—

- (a) it is listed in, and complies with **Table 1** of this Specification; or
- (b) it is identical with a prototype that has been submitted to the *Standard Fire Test*, or an equivalent or more severe test, and the FRL achieved by the prototype is confirmed in a report from a *Registered Testing Authority* which—
 - (i) describes the method and conditions of the test and the form of construction of the tested prototype in full; and
 - (ii) certifies that the application of restraint to the prototype complied with the *Standard Fire Test*; or
- (c) it differs in only a minor degree from a prototype tested under **(b)** and the FRL attributed to the building element is confirmed in a report from a *Registered Testing Authority* which—
 - (i) certifies that the building element is capable of achieving the FRL despite the minor departures from the tested prototype; and
 - (ii) describes the materials, construction and conditions of restraint which are necessary to achieve the FRL; or
- (d) it is designed to achieve the FRL in accordance with—
 - (i) AS 2327.1, AS 4100 and AISC Guidelines for Assessment of Fire Resistance of Structural Steel Members if it is a steel or composite structure; or
 - (ii) AS 3600 if it is a concrete structure; or
 - (iii) AS 1720.4 if it is a solid or glued-laminated timber structure; or
 - (iv) AS 3700 if it is a masonry structure; or
- (e) the FRL is determined by calculation based on the performance of a prototype in the *Standard Fire Test* and confirmed in a report in accordance with **Clause 3**.

3. FRLs determined by calculation

If the FRL of a building element is determined by calculation based on a tested prototype—

- (a) the building element may vary from the prototype in relation to—
 - (i) length and height if it is a wall; and
 - (ii) height if it is a column; and
 - (iii) span if it is a floor, roof or beam; and
 - (iv) conditions of support; and

- (v) to a minor degree, cross-section and components; and
- (b) the report must demonstrate by calculation that the building element would achieve the FRL if it is subjected to the regime of the *Standard Fire Test* in relation to—
 - (i) *structural adequacy* (including deflection); and
 - (ii) *integrity*; and
 - (iii) *insulation*; and
- (c) the calculations must take into account—
 - (i) the temperature reached by the components of the prototype and their effects on strength and modulus of elasticity; and
 - (ii) appropriate features of the building element such as support, restraint, cross-sectional shape, length, height, span, slenderness ratio, reinforcement, ratio of surface area to mass per unit length, and fire protection; and
 - (iii) features of the prototype that influenced its performance in the *Standard Fire Test* although these features may not have been taken into account in the design for dead and live load; and
 - (iv) features of the conditions of test, the manner of support and the position of the prototype during the test, that might not be reproduced in the building element if it is exposed to fire; and
 - (v) the design load of the building element in comparison with the tested prototype.

4. Interchangeable materials

- (a) Concrete and plaster — An FRL achieved with any material of Group A, B, C, D or E as an ingredient in concrete or plaster, applies equally when any other material of the same group is used in the same proportions:
 - Group A: Any portland cement.
 - Group B: Any lime.
 - Group C: Any dense sand.
 - Group D: Any dense calcareous aggregate, including any limestone or any calcareous gravel.
 - Group E: Any dense siliceous aggregate, including any basalt, diorite, dolerite, granite, granodiorite or trachyte.
- (b) Perlite and vermiculite — An FRL achieved with either gypsum-perlite plaster or gypsum-vermiculite plaster applies equally for each plaster.

5. Columns covered with lightweight construction

If the *fire-resisting* covering of a steel column is *lightweight construction*, the construction must comply with **C1.8** and **C3.17**.

6. Non-loadbearing elements

If a non-*loadbearing* element is able to be used for a purpose where the *Deemed-to-Satisfy Provisions* prescribe an FRL for *structural adequacy*, *integrity* and *insulation*, that non-*loadbearing* element need not comply with the *structural adequacy* criteria.

Table 1 FRLs DEEMED TO BE ACHIEVED BY CERTAIN BUILDING ELEMENT

| Building element | Minimum thickness (mm) of principal material for FRL's | | | | | Annexure reference |
|--|--|------------------------------------|-------------|-------------|-------------|--------------------|
| WALL | | | | | | |
| | 60/60/60 | 90/90/90 | 120/120/120 | 180/180/180 | 240/240/240 | Clause |
| Masonry | | | | | | |
| Ashlar | – | – | – | – | 300 | 1, 2, 5, 6 |
| Calcium silicate | | see 2(d)(iv) of this Specification | | | | |
| Concrete | | see 2(d)(iv) of this Specification | | | | |
| Fired clay (inc terracotta) | | see 2(d)(iv) of this Specification | | | | |
| Concrete | | | | | | |
| No-fines | – | – | – | 150 | 170 | 1, 5, 6 |
| Prestressed | | see 2(d)(ii) of this Specification | | | | |
| Reinforced | | see 2(d)(ii) of this Specification | | | | |
| Plain | – | – | – | 150 | 170 | 1, 5, 6 |
| Solid gypsum blocks | 75 | 90 | 100 | 110 | 125 | 1, 5, 6 |
| Gypsum — perlite or Gypsum vermiculite-plaster on metal lath and channel (non-loadbearing walls only) | 50 | 50 | 65 | – | – | 1, 5, 7 |
| CONCRETE COLUMN | | | | | | |
| | 60/60/60 | 90/90/90 | 120/120/120 | 180/180/180 | 240/240/240 | Clause |
| Prestressed | | see 2(d)(ii) of this Specification | | | | |
| Reinforced | | see 2(d)(ii) of this Specification | | | | |
| HOT-ROLLED STEEL COLUMN | | | | | | |
| | 60/60/60 | 90/90/90 | 120/120/120 | 180/180/180 | 240/240/240 | Clause |
| (inc a fabricated column) exposed on no more than 3 sides: | | | | | | 8 |
| Fire protection of | | | | | | |
| Concrete — Cast in-situ— | | | | | | |
| <i>loadbearing</i> | 25 | 30 | 40 | 55 | 75 | 9, 11, 12 |
| non- <i>loadbearing</i> - | | | | | | |
| unplastered | 25 | 30 | 40 | 50 | 65 | 9, 11, 12 |
| plastered 13 mm— | 25 | 25 | 30 | 40 | 50 | 1, 6, 9, 11, 12 |
| Gypsum — Cast in-situ | – | – | – | – | 50 | 9, 11, 12 |
| Gypsum — perlite or Gypsum-vermiculite plaster | | | | | | |
| sprayed to contour | 20 | 25 | 35 | 50 | 55 | 1, 11 |
| sprayed on metal lath | 20 | 20 | 25 | 35 | 45 | 1, 7 |

Table 1 FRLs DEEMED TO BE ACHIEVED BY CERTAIN BUILDING ELEMENT— continued

| Building element | Minimum thickness (mm) of principal material for FRL's | | | | | Annexure reference |
|--|--|----------|-------------|-------------|-------------|----------------------------|
| HOT-ROLLED STEEL COLUMN | | | | | | |
| | 60/60/60 | 90/90/90 | 120/120/120 | 180/180/180 | 240/240/240 | Clause |
| (inc. a fabricated column) exposed on no more than 3 sides and with column spaces filled: | | | | | | 8, 9 |
| Fire protection of— | | | | | | |
| Solid calcium-silicate masonry | 50 | 50 | 50 | 50 | 65 | 1, 3, 11, 12 |
| Solid clay masonry | 50 | 50 | 50 | 65 | 90 | 1, 3, 11, 12 |
| Solid concrete masonry | 50 | 50 | 50 | 65 | 90 | 1, 3, 11, 12 |
| Solid gypsum blocks | 50 | 50 | 50 | 50 | 65 | 1, 3, 11, 12 |
| Hollow terracotta blocks plastered 13 mm | 50 | 50 | 50 | 65 | 90 | 1, 3, 6, 10, 11, 12 |
| HOT-ROLLED STEEL COLUMN | | | | | | |
| | 60/60/60 | 90/90/90 | 120/120/120 | 180/180/180 | 240/240/240 | Clause |
| (inc a fabricated column) exposed on no more than 3 sides and with column spaces unfilled: | | | | | | 8 |
| Fire protection of— | | | | | | |
| Solid calcium- silicate masonry | 50 | 50 | 50 | – | – | 1, 3, 11, 12 |
| Solid clay masonry | 50 | 50 | 65 | – | – | 1, 3, 11, 12 |
| Solid concrete masonry | 50 | 50 | 65 | – | – | 1, 3, 11, 12 |
| Solid gypsum blocks | 50 | 50 | 50 | – | – | 1, 3, 11, 12 |
| Hollow terracotta blocks— plastered 13 mm | 50 | 50 | 65 | – | – | 1, 3, 6, 10, 11, 12 |
| HOT-ROLLED STEEL COLUMN | | | | | | |
| | 60/-/- | 90/-/- | 120/-/- | 180/-/- | 240/-/- | Clause |
| (inc. a fabricated column) exposed on 4 sides: | | | | | | 8 |
| Fire protection of— | | | | | | |
| Concrete — Cast in-situ— <i>loadbearing</i> | 25 | 40 | 45 | 65 | 90 | 9, 11, 12 |
| <i>non-loadbearing-</i> unplastered | 25 | 30 | 40 | 50 | 65 | 9, 11, 12 |
| plastered 13 mm | 25 | 25 | 30 | 40 | 50 | 1, 6, 9, 11, 12 |
| Gypsum — Cast in-situ | – | – | – | – | 50 | 9, 11, 12 |
| Gypsum-perlite or Gypsum-vermiculite plaster sprayed to contour | 25 | 30 | 40 | 55 | 65 | 1, 11 |

Table 1 FRLs DEEMED TO BE ACHIEVED BY CERTAIN BUILDING ELEMENT— continued

| Building element | Minimum thickness (mm) of principal material for FRL's | | | | | Annexure reference | |
|--|--|------------------------------------|--------|--------|--------|---------------------|--|
| | 20 | 20 | 30 | 40 | 50 | | |
| sprayed on metal lath | 20 | 20 | 30 | 40 | 50 | 1, 7 | |
| HOT-ROLLED STEEL COLUMN | | | | | | | |
| | 60/-/ | 90/-/ | 120/-/ | 180/-/ | 240/-/ | Clause | |
| (inc. a fabricated column) exposed on 4 sides and with column spaces filled: | | | | | | 8, 9 | |
| Fire protection of— | | | | | | | |
| Solid calcium- silicate masonry | 50 | 50 | 50 | 65 | 75 | 1, 3, 11, 12, | |
| Solid clay masonry | 50 | 50 | 50 | 75 | 100 | 1, 3, 11, 12 | |
| Solid concrete masonry | 50 | 50 | 50 | 75 | 100 | 1, 3, 11, 12 | |
| Solid gypsum blocks | 50 | 50 | 50 | 65 | 75 | 1, 3, 11, 12 | |
| Hollow terracotta blocks— | | | | | | | |
| plastered 13 mm | 50 | 50 | 50 | 75 | 100 | 1, 3, 6, 10, 11, 12 | |
| HOT-ROLLED STEEL COLUMN | | | | | | | |
| | 60/-/ | 90/-/ | 120/-/ | 180/-/ | 240/-/ | Clause | |
| (inc. a fabricated column) exposed on 4 sides and with column spaces unfilled: | | | | | | 8 | |
| Fire protection of— | | | | | | | |
| Solid calcium-silicate masonry | 50 | 50 | 50 | – | – | 1, 3, 11, 12 | |
| Solid clay masonry | 50 | 50 | 65 | – | – | 1, 3, 11, 12 | |
| Solid concrete masonry | 50 | 50 | 65 | – | – | 1, 3, 11, 12 | |
| Solid gypsum blocks | 50 | 50 | 50 | – | – | 1, 3, 11, 12 | |
| Hollow terracotta blocks— | | | | | | | |
| plastered 13 mm | 50 | 50 | 65 | – | – | 1, 3, 6, 10, 11, 12 | |
| BEAM | | | | | | | |
| | 60/-/ | 90/-/ | 120/-/ | 180/-/ | 240/-/ | Clause | |
| Concrete— | | | | | | | |
| Prestressed | | see 2(d)(ii) of this Specification | | | | | |
| Reinforced | | see 2(d)(ii) of this Specification | | | | | |
| Hot-rolled Steel (inc. an open-web joist girder truss etc) exposed on no more than 3 sides: | | | | | | 8 | |
| Fire protection of— | | | | | | | |
| Concrete — Cast in-situ | 25 | 30 | 40 | 50 | 65 | 11, 12 | |
| Gypsum-perlite or Gypsum-vermiculite plaster | | | | | | | |
| sprayed to contour | 20 | 25 | 35 | 50 | 55 | 1, 11 | |
| sprayed on metal lath | 20 | 20 | 25 | 35 | 45 | 1, 7 | |

Table 1 FRLs DEEMED TO BE ACHIEVED BY CERTAIN BUILDING ELEMENT— continued

| Building element | Minimum thickness (mm) of principal material for FRL's | | | | | Annexure reference |
|---|--|---|-------------|-------------|-------------|--------------------|
| Hot-rolled Steel (inc. an open-web joist girder truss etc) exposed on 4 sides: | | | | | | 8 |
| Fire protection of— | | | | | | |
| Concrete — Cast in-situ | 25 | 40 | 45 | 65 | 90 | 11, 12 |
| Gypsum-perlite or Gypsum-vermiculite plaster — | | | | | | |
| sprayed to contour | 25 | 30 | 40 | 55 | 65 | 1, 11 |
| sprayed on metal lath | 20 | 20 | 30 | 40 | 50 | 1, 7 |
| FLOOR, ROOF OR CEILING | | | | | | |
| | 60/60/60 | 90/90/90 | 120/120/120 | 180/180/180 | 240/240/240 | Clause |
| Concrete — | | | | | | |
| Prestressed | | see 2(d)(ii) of this Specification | | | | |
| Reinforced | | see 2(d)(ii) of this Specification | | | | |

ANNEXURE TO TABLE 1

1. MORTAR, PLASTER AND PLASTER REINFORCEMENT

1.1 Mortar for masonry

Masonry units of ashlar, calcium silicate, concrete or fired clay (including terracotta blocks) must be laid in cement mortar or composition mortar complying with the relevant provisions of AS 3700.

1.2 Gypsum blocks

Gypsum blocks must be laid in gypsum-sand mortar or lime mortar.

1.3 Gypsum-sand mortar and plaster

Gypsum-sand mortar and gypsum-sand plaster must consist of either—

- (a) not more than 3 parts by volume of sand to 1 part by volume of gypsum; or
- (b) if lime putty is added, not more than 2.5 parts by volume of sand to 1 part by volume of gypsum and not more than 5% of lime putty by volume of the mixed ingredients.

1.4 Gypsum-perlite and gypsum-vermiculite plaster

Gypsum-perlite or gypsum-vermiculite plaster must be applied—

- (a) in either one or 2 coats each in the proportions of 1 m³ of perlite or vermiculite to 640 kg of gypsum if the *required* thickness of the plaster is not more than 25 mm; and
- (b) in 2 coats if the *required* thickness is more than 25 mm, the first in the proportions of 1 m³ of perlite or vermiculite to 800 kg of gypsum and the second in the proportions of 1 m³ of perlite or vermiculite to 530 kg of gypsum.

1.5 Plaster of cement and sand or cement, lime and sand

Plaster prescribed in [Table 1](#) must consist of—

- (a) cement and sand or cement, lime and sand; and
- (b) may be finished with gypsum, gypsum-sand, gypsum-perlite or gypsum-vermiculite plaster or with lime putty.

1.6 Plaster reinforcement

If plaster used as fire protection on walls is more than 19 mm thick—

- (a) it must be reinforced with expanded metal lath that—
 - (i) has a mass per unit area of not less than 1.84 kg/m²; and
 - (ii) has not fewer than 98 meshes per metre; and
 - (iii) is protected against corrosion by galvanising or other suitable method; or
- (b) it must be reinforced with 13 mm x 13 mm x 0.7 mm galvanised steel wire mesh, and

with the reinforcement must be securely fixed at a distance from the face of the wall of not less than 1/3 of the total thickness of the plaster.

2. ASHLAR STONE MASONRY

Ashlar masonry must not be used in a part of the building containing more than 2 *storeys*, and must not be of—

- (a) aplite, granite, granodiorite, quartz dacite, quartz diorite, quartz porphyrite or quartz porphyry; or
- (b) conglomerate, quartzite or sandstone; or
- (c) chert or flint; or
- (d) limestone or marble.

3. DIMENSIONS OF MASONRY

The thicknesses of masonry of calcium-silicate, concrete and fired clay are calculated as follows:

3.1 Solid units

For masonry in which the amount of perforation or coring of the units does not exceed 25% by volume (based on the overall rectangular shape of the unit) the thickness of the wall must be calculated from the manufacturing dimensions of the units and the specified thickness of the joints between them as appropriate.

3.2 Hollow units

For masonry in which the amount of perforation or coring of the units exceeds 25% by volume (based on the overall rectangular shape of the unit) the thickness of the wall must be calculated from the equivalent thicknesses of the units and the specified thickness of the joints between them as appropriate.

3.3 Equivalent thickness

The equivalent thickness of a masonry unit is calculated by dividing the net volume by the area of one vertical face.

4. * * * * *

This Clause has deliberately been left blank.

5. HEIGHT-TO-THICKNESS RATIO OF CERTAIN WALLS

The ratio of height between lateral supports to overall thickness of a wall of ashlar, no-fines concrete, unreinforced concrete, solid gypsum blocks, gypsum-perlite or gypsum-vermiculite plaster on metal lath and channel, must not exceed—

- (a) 20 for a *loadbearing* wall; or
- (b) 27 for a non-*loadbearing* wall.

6. INCREASE IN THICKNESS BY PLASTERING

6.1 Walls

If a wall of ashlar, solid gypsum blocks or concrete is plastered on both sides to an equal thickness, the thickness of the wall for the purposes of [Table 1](#) (but not for the purposes of [Annexure Clause 5](#)) may be increased by the thickness of the plaster on one side.

6.2 Columns

Where [Table 1](#) indicates that column-protection is to be plastered, the tabulated thicknesses are those of the principal material. They do not include the thickness of plaster which must be additional to the listed thickness of the material to which it is applied.

7. GYPSUM-PERLITE OR GYPSUM-VERMICULITE PLASTER ON METAL LATH

7.1 Walls

In walls fabricated of gypsum-perlite or gypsum-vermiculite plaster on metal lath and channel—

- (a) the lath must be securely wired to each side of 19 mm x 0.44 kg/m steel channels (used as studs) spaced at not more than 400 mm centres; and
- (b) the gypsum-perlite or gypsum-vermiculite plaster must be applied symmetrically to each exposed side of the lath.

7.2 Columns

For the fire protection of steel columns with gypsum-perlite or gypsum-vermiculite on metal lath—

- (a) the lath must be fixed at not more than 600 mm centres vertically to steel furring channels, and—
 - (i) if the plaster is to be 35 mm thick or more — at least 12 mm clear of the column; or
 - (ii) if the plaster is to be less than 35 mm thick — at least 6 mm clear of the column; or
- (b) the plaster may be applied to self-furring lath with furring dimples to hold it not less than 10 mm clear of the column, and

the thickness of the plaster must be measured from the back of the lath.

7.3 Beams

For the fire protection of steel beams with gypsum-perlite or gypsum-vermiculite on metal lath—

- (a) the lath must be fixed at not more than 600 mm centres to steel furring channels and at least 20 mm clear of the steel; and
- (b) the thickness of the plaster must be measured from the back of the lath.

8. EXPOSURE OF COLUMNS AND BEAMS

8.1 Columns

A column incorporated in or in contact on one or more sides with a wall of solid masonry or concrete at least 100 mm thick may be considered to be exposed to fire on no more than 3 sides.

8.2 Beams

A beam, open-web joist, girder or truss in direct and continuous contact with a concrete slab or a hollow block floor or roof may be considered to be exposed to fire on no more than 3 sides.

9. FILLING OF COLUMN SPACES

- (a) The spaces between the fire-protective material and the steel (and any re-entrant parts of the column itself) must be filled solid with a fire-protective material like concrete, gypsum or grout.
- (b) The insides of hollow sections, including pipes, need not be filled.

10. HOLLOW TERRACOTTA BLOCKS

The proportion of cored holes or perforations in a hollow terracotta block (based on the overall rectangular volume of the unit) must not exceed the following:

- | | | |
|-----|---|-----|
| (a) | For blocks up to 75 mm thick | 35% |
| (b) | For blocks more than 75 mm but not more than 100 mm thick | 40% |
| (c) | For blocks more than 100 mm | 50% |

11. REINFORCEMENT FOR COLUMN AND BEAM PROTECTION

11.1 Masonry

Masonry of calcium-silicate, fired clay and concrete for the protection of steel columns must have steel-wire or mesh reinforcement in every second course and lapped at the corners.

11.2 Gypsum blocks and hollow terracotta blocks

Gypsum blocks and hollow terracotta blocks for the protection of steel columns must have steel-wire or mesh reinforcement in every course and lapped at corners.

11.3 Structural concrete and poured gypsum

If a steel column or a steel beam is to be protected with structural concrete or poured gypsum—

- (a) the concrete or gypsum must be reinforced with steel-wire mesh or steel-wire binding placed about 20 mm from its outer surface, and—
 - (i) for concrete or gypsum less than 50 mm thick, the steel wire must be—
 - (A) at least 3.15 mm in diameter; and

- (B) spaced at not more than 100 mm vertically; or
- (ii) for concrete or gypsum not less than 50 mm thick, the steel wire must be either—
 - (A) of a diameter and spacing in accordance with (i); or
 - (B) at least 5 mm in diameter and spaced at not more than 150 mm vertically.

11.4 Gypsum-perlite or gypsum-vermiculite plaster sprayed to contour

- (a) If a steel column or steel beam is protected with either gypsum-perlite or gypsum-vermiculite plaster sprayed to contour and the construction falls within the limits of [Table 11.4](#), the plaster must be reinforced with—
 - (i) expanded metal lath complying with [Clause 1.6 of this Annexure](#); or
 - (ii) galvanised steel wire mesh complying with [Clause 1.6 of this Annexure](#).
- (b) The reinforcement must be placed at a distance from the face of the plaster of at least 1/3 of the thickness of the plaster and must be securely fixed to the column or beam at intervals of not more than the relevant listing in [Table 11.4](#).
- (c) For the purposes of [Table 11.4](#)—
 - (i) “vertical” includes a surface at not more than 10° to the vertical; and
 - (ii) “horizontal” includes a surface at not more than 10° to the horizontal; and
 - (iii) “underside” means the underside of any horizontal or non-vertical surface.

Table 11.4 REINFORCEMENT OF GYPSUM-PERLITE OR GYPSUM-VERMICULITE PLASTER SPRAYED TO CONTOUR

| Surface to be protected | Reinforcement required if smaller dimension of surface exceeds (mm) | Max spacing of fixings of the mesh to surface (mm) |
|---|---|--|
| Members with H or I cross-section: | | |
| Vertical— | 450 | 450 |
| Non-vertical— | 300 | 300 |
| Underside— | 300 | 300 |
| Upper side of a horizontal surface— | Not required | |
| Members with other shapes: | | |
| Vertical— | Any size | 450 |
| Non-vertical— | Any size | 300 |
| Underside— | Any size | 300 |
| Upper side of a horizontal surface— | Not required | |

12. THICKNESS OF COLUMN AND BEAM PROTECTION

12.1 Measurement of thickness

The thickness of the fire protection to steel columns and steel beams (other than fire protection of gypsum-perlite or gypsum-vermiculite plaster sprayed on metal lath or sprayed to contour) is to be measured from the face or edge of the steel, from the face of a splice plate or from the outer part of a rivet or bolt, whichever is the closest to the outside of the fire-protective construction, except that—

- (a) if the thickness of the fire protection is 40 mm or more, rivet heads may be disregarded; and
- (b) if the thickness of the fire protection is 50 mm or more—
 - (i) any part of a bolt (other than a high-tensile bolt) may be disregarded; and
 - (ii) a column splice plate within 900 mm of the floor may encroach upon the fire protection by up to a 1/4 of the thickness of the fire protection; and
- (c) the flange of a column or beam may encroach by up to 12 mm upon the thickness of the fire protection at right angles to the web if—
 - (i) the column or beam is intended to have an FRL of 240/240/240 or 240/-/-; and
 - (ii) the flange projects 65 mm or more from the web; and
 - (iii) the thickness of the edge of the flange (inclusive of any splice plate) is not more than 40 mm.

SPECIFICATION **A2.4** FIRE HAZARD PROPERTIES

1. Scope

This Specification sets out the procedures for—

- (a) determining the *fire hazard properties* of assemblies tested to AS/NZS 1530.3; and
- (b) predicting a material's *group number* and *smoke growth rate index* (SMOGR_{RC}) for the purposes of **Specification C1.10**.

2. Assemblies

2.1 General requirement

The *fire hazard properties* of assemblies and their ability to screen their core materials as *required* under **Specification C1.10** must be determined by testing in accordance with this Clause.

2.2 Form of test

Tests must be carried out in accordance with—

- (a) for the determination of the *Spread-of-Flame Index* and *Smoke-Developed Index* — AS/NZS 1530.3; and
- (b) for the determination of the ability to prevent ignition and to screen its core material from free air — AS 1530.4.

2.3 Test specimens

Test specimens must incorporate—

- (a) all types of joints; and
- (b) all types of perforations, recesses or the like for pipes, light switches or other fittings, which are proposed to be used for the member or assembly of members in the building.

2.4 Concession

Clause 2.3 does not apply to joints, perforations, recesses or the like that are larger than those in the proposed application and have already been tested in the particular form of construction concerned and found to comply with the conditions of the test.

2.5 Smaller specimen permitted

A testing laboratory may carry out the test specified in **Clause 2.2(b)** at pilot scale if a specimen (which must be not less than 900 mm x 900 mm) will adequately represent the proposed construction in the building, but the results of that test do not apply to construction larger than limits defined by the laboratory conducting the pilot examination.

3. Predicting a material's group number

For a material tested to AS/NZS 3837, the material's *group number* must be determined in accordance with the following:

- (a) Data must be in the form of time and rate of heat release pairs for the duration of the test. The time interval between pairs should not be more than 5 seconds. The end of the test (t_f) is determined as defined in AS/NZS 3837.
- (b) At least three replicate specimens must be tested. The following procedure must be applied separately to each specimen:
 - (i) Determine time to ignition (t_{ig}). Time to ignition is defined as the time (in seconds) when the rate of heat release reaches or first exceeds a value of 50 kW/m².
 - (ii) Calculate the Ignitability Index (I_{ig}) expressed in reciprocal minutes.

$$I_{ig} = \frac{60}{t_{ig}}$$

- (iii) Calculate the following two rates of heat release indices.

$$I_{Q1} = \int_{t_{ig}}^{t_f} \left[\frac{q''(t)}{(t - t_{ig})^{0.34}} \right] \quad I_{Q2} = \int_{t_{ig}}^{t_f} \left[\frac{q''(t)}{(t - t_{ig})^{0.93}} \right]$$

t = time (seconds),

$q''(t)$ = rate of heat release (kW/m²) at time t

These definite integral expressions represent the area under a curve from the ignition time until the end of the test, where the parameter $q''(t)/(t - t_{ig})^m$ is plotted on the vertical axis and time (t) is plotted on the horizontal axis.

- (iv) Calculate the following three integral limits:

$$I_{Q,10min} = 6800 - 540I_{ig}$$

$$I_{Q,2min} = 2475 - 165I_{ig}$$

$$I_{Q,12min} = 1650 - 165I_{ig}$$

- (v) Classify the material in accordance with **Table 3**:

Table 3 CLASSIFICATION OF MATERIALS

| | |
|--|------------------------------------|
| If $I_{Q1} > I_{Q,10 min}$ and $I_{Q2} > I_{Q,2 min}$ | the material is a Group 4 material |
| If $I_{Q1} > I_{Q,10 min}$ and $I_{Q2} \leq I_{Q,2 min}$ | the material is a Group 3 material |
| If $I_{Q1} \leq I_{Q,10 min}$ and $I_{Q2} > I_{Q,12 min}$ | the material is a Group 2 material |
| If $I_{Q1} \leq I_{Q,10 min}$ and $I_{Q2} \leq I_{Q,12 min}$ | the material is a Group 1 material |

- (vi) Repeat steps 1 to 5 above for each replicate specimen tested. Where a different classification group is obtained for different specimens tested, then the highest (worst) classification for any specimen must be taken as the final classification for that material.

4. Predicting a material's smoke growth rate index (SMOGR_{RC})

- (a) Measure the instantaneous rate of light-obscuring smoke R_{inst} expressed in square metres per second (m^2/s) in the exhaust duct at not more than 6 second intervals in the AS ISO 9705 room test.
- (b) Determine the 60 second running average (R_{60}) at time t . The result is the average rate of light-obscuring smoke over the period $t-30$ to $t+30$ seconds (in m^2/s). This may also be expressed mathematically as:

$$R_{60} = \frac{1}{60} \int_{t-30}^{t+30} R_{inst} dt$$

- (c) Find the time (in seconds) at which the maximum value of the 60 second running average occurs (t_{60}).
- (d) Calculate the SMOGR_{RC} index (in $m^2/s^2 \times 1000$)

$$SMOGR_{RC} = \frac{1000R_{60}}{t_{60}}$$

The SMOGR_{RC} index is based on the results of a single test.

SECTION **B**

STRUCTURE

B1 Structural Provisions

SECTION B CONTENTS

SECTION B STRUCTURE

B1 STRUCTURAL PROVISIONS

Objective BO1

Functional Statement BF1.1 - BF1.2

Performance Requirement BP1.1 - BP1.4

B1.0 Deemed-to-Satisfy Provisions

B1.1 Resistance to actions

B1.2 Determination of individual actions

B1.3 * * * * *

B1.4 Determination of structural resistance of materials and forms of construction

B1.5 Structural software

B1.6 Construction of buildings in flood hazard areas.

Specifications

Specification B1.2 Design of Buildings in Cyclonic Areas

PART B1 STRUCTURAL PROVISIONS

OBJECTIVE

BO1

The *Objective* of this Part is to—

- (a) safeguard people from injury caused by structural failure; and
- (b) safeguard people from loss of amenity caused by structural behaviour; and
- (c) protect *other property* from physical damage caused by structural failure; and
- (d) safeguard people from injury that may be caused by failure of, or impact with, glazing.

FUNCTIONAL STATEMENT

BF1.1

A building or structure is to withstand the combination of loads and other actions to which it may be reasonably subjected.

BF1.2

Glazing is to be installed in a building to avoid undue risk of injury to people.

PERFORMANCE REQUIREMENT

BP1.1

- (a) A building or structure, during construction and use, with appropriate degrees of reliability, must—
 - (i) perform adequately under all reasonably expected design actions; and
 - (ii) withstand extreme or frequently repeated design actions; and
 - (iii) be designed to sustain local damage, with the structural system as a whole remaining stable and not being damaged to an extent disproportionate to the original local damage; and
 - (iv) avoid causing damage to *other properties*,
by resisting the actions to which it may reasonably expect to be subjected.
- (b) The actions to be considered to satisfy (a) include but are not limited to—

- (i) permanent actions (dead loads); and
- (ii) imposed actions (live loads arising from occupancy and use); and
- (iii) wind action; and
- (iv) earthquake action; and
- (v) snow action; and
- (vi) liquid pressure action; and
- (vii) ground water action; and
- (viii) rainwater action (including ponding action); and
- (ix) earth pressure action; and
- (x) differential movement; and
- (xi) time dependent effects (including creep and shrinkage); and
- (xii) thermal effects; and
- (xiii) ground movement caused by—
 - (A) swelling, shrinkage or freezing of the subsoil; and
 - (B) landslip or subsidence; and
 - (C) siteworks associated with the building or structure; and
- (xiv) *construction activity actions*; and
- (xv) termite actions.

BP1.2

The structural resistance of materials and forms of construction must be determined using five percentile characteristic material properties with appropriate allowance for—

- (a) known construction activities; and
- (b) type of material; and
- (c) characteristics of the site; and
- (d) the degree of accuracy inherent in the methods used to assess the structural behaviour; and
- (e) action effects arising from the differential settlement of foundations, and from restrained dimensional changes due to temperature, moisture, shrinkage, creep and similar effects.

BP1.3

Glass installations that are at risk of being subjected to human impact must have glazing that—

- (a) if broken on impact, will break in a way that is not likely to cause injury to people; and
- (b) resists a reasonably foreseeable human impact without breaking; and
- (c) is protected or marked in a way that will reduce the likelihood of human impact.

BP1.4

- (a) A building in a *flood hazard area*, must be designed and constructed, to the degree necessary, to resist flotation, collapse or significant permanent movement resulting from the action of hydrostatic, hydrodynamic, erosion and scour, wind and other actions during the *defined flood event*.
- (b) The actions and requirements to be considered to satisfy (a) include but are not limited to—
- (i) flood actions; and
 - (ii) elevation requirements; and
 - (iii) foundation and footing requirements; and
 - (iv) requirements for enclosures below the *flood hazard level*; and
 - (v) requirements for structural connections; and
 - (vi) material requirements; and
 - (vii) requirements for utilities; and
 - (viii) requirements for occupant egress; and
 - (ix) impacts to other structures and properties.

Application:

BP1.4 only applies to—

- (a) a Class 2 or 3 building or Class 4 part of a building; and
- (b) a Class 9a *health-care building*; and
- (c) a Class 9c *aged-care building*.

PART B1 STRUCTURAL PROVISIONS

Deemed-to-Satisfy Provisions

B1.0 Deemed-to-Satisfy Provisions

- (a) Where a *Building Solution* is proposed to comply with the *Deemed-to-Satisfy Provisions*, *Performance Requirement BP1.1* to *BP1.4* are satisfied by complying with **B1.1**, **B1.2**, **B1.4**, **B1.5** and **B1.6**.
- (b) Where a *Building Solution* is proposed as an *Alternative Solution* to the *Deemed-to-Satisfy Provisions* of **B1.1**, **B1.2**, **B1.4**, **B1.5** and **B1.6**, the relevant *Performance Requirements* must be determined in accordance with **A0.10**.

B1.1 Resistance to actions

The resistance of a building or structure must be greater than the most critical action effect resulting from different combinations of actions, where—

- (a) the most critical action effect on a building or structure is determined in accordance with **B1.2** and the general design procedures contained in AS/NZS 1170.0; and
- (b) the resistance of a building or structure is determined in accordance with **B1.4**.

B1.2 Determination of individual actions

The magnitude of individual actions must be determined in accordance with the following:

- (a) Permanent actions:
 - (i) the design or known dimensions of the building or structure; and
 - (ii) the unit weight of the construction; and
 - (iii) AS/NZS 1170.1.
- (b) Imposed actions:
 - (i) the known loads that will be imposed during the occupation or use of the building or structure; and
 - (ii) *construction activity actions*; and
 - (iii) AS/NZS 1170.1.
- (c) Wind, snow and ice and earthquake actions:
 - (i) the applicable annual probability of design event for safety, determined by—
 - (A) assigning the building or structure an Importance Level in accordance with **Table B1.2a**; and
 - (B) determining the corresponding annual probability of exceedance in accordance with **Table B1.2b**; and
 - (ii) AS/NZS 1170.2; and
 - (iii) AS/NZS 1170.3 and AS 1170.4 as appropriate; and

Deemed-to-Satisfy Provisions

- (iv) in cyclonic areas, metal roof cladding, its connections and immediate supporting members must comply with **Specification B1.2**; and
- (v) for the purposes of (iv), cyclonic areas are those determined as being located in wind regions C and D in accordance with AS/NZS 1170.2.
- (d) Actions not covered in (a), (b) and (c) above:
 - (i) the nature of the action; and
 - (ii) the nature of the building or structure; and
 - (iii) the Importance Level of the building or structure determined in accordance with **Table B1.2a**; and
 - (iv) AS/NZS 1170.1.
- (e) For the purposes of (d) the actions include but are not limited to—
 - (i) liquid pressure action; and
 - (ii) ground water action; and
 - (iii) rainwater action (including ponding action); and
 - (iv) earth pressure action; and
 - (v) differential movement; and
 - (vi) time dependent effects (including creep and shrinkage); and
 - (vii) thermal effects; and
 - (viii) ground movement caused by—
 - (A) swelling, shrinkage or freezing of the subsoil; and
 - (B) landslip or subsidence; and
 - (C) *siteworks* associated with the building or structure; and
 - (ix) *construction activity actions*.

Table B1.2a IMPORTANCE LEVELS OF BUILDINGS AND STRUCTURES

| Importance Level | Building Types |
|------------------|---|
| 1 | Buildings or structures presenting a low degree of hazard to life and <i>other property</i> in the case of failure. |
| 2 | Buildings or structures not included in Importance Levels 1, 3 and 4. |
| 3 | Buildings or structures that are designed to contain a large number of people. |
| 4 | Buildings or structures that are essential to post-disaster recovery or associated with hazardous facilities. |

Deemed-to-Satisfy Provisions

Table B1.2b DESIGN EVENTS FOR SAFETY

| Importance Level | Annual probability of exceedance | | | |
|------------------|----------------------------------|----------|-------|------------|
| | Wind | | Snow | Earthquake |
| | Non-cyclonic | Cyclonic | | |
| 1 | 1:100 | 1:200 | 1:100 | 1:250 |
| 2 | 1:500 | 1:500 | 1:150 | 1:500 |
| 3 | 1:1000 | 1:1000 | 1:200 | 1:1000 |
| 4 | 1:2000 | 1:2000 | 1:250 | 1:1500 |

B1.3 * * * * *

This clause has deliberately been left blank

B1.4 Determination of structural resistance of materials and forms of construction

The structural resistance of materials and forms of construction must be determined in accordance with the following, as appropriate:

- (a) Masonry (including masonry-veneer, unreinforced masonry and reinforced masonry): AS 3700.
- (b) Concrete construction (including reinforced and prestressed concrete): AS 3600.
- (c) Steel construction—
 - (i) Steel structures: AS 4100.
 - (ii) Cold-formed steel structures: AS/NZS 4600.
 - (iii) Residential and low-rise steel framing: NASH Standard.
- (d) Composite steel and concrete: AS 2327.1.
- (e) Aluminium construction: AS/NZS 1664.1 or AS/NZS 1664.2.
- (f) Timber construction:
 - (i) Design of timber structures: AS 1720.1.
 - (ii) * * * * *
 - (iii) Timber structures: AS 1684 Part 2, Part 3 or Part 4.

Qld B1.4(f)(iv)

- (g) Piling: AS 2159.
- (h) Glazed assemblies:
 - (i) The following glazed assemblies in an *external wall* must comply with AS 2047:
 - (A) Windows excluding those listed in (ii).
 - (B) Sliding doors with a frame.
 - (C) Adjustable louvres.

Deemed-to-Satisfy Provisions

- (D) Shopfronts.
- (E) Window walls with one piece framing.
- (ii) All glazed assemblies not covered by (i) and the following glazed assemblies must comply with AS 1288:
 - (A) All glazed assemblies not in an *external wall*.
 - (B) Hinged doors, including French doors and bi-fold doors.
 - (C) Revolving doors.
 - (D) Fixed louvres.
 - (E) Skylights, roof lights and windows in other than the vertical plane.
 - (F) Sliding doors without a frame.
 - (G) Shopfront doors.
 - (H) Windows constructed on site and architectural one-off windows, which are not design tested in accordance with AS 2047.
 - (I) Second-hand windows, re-used windows, recycled windows and replacement windows.
 - (J) Heritage windows.
 - (K) Glazing used in balustrades and sloping overhead glazing.

NT B1.4(i)

- (i) Termite Risk Management: Where a *primary building element* is subject to attack by subterranean termites: AS 3660.1, and—
 - (i) for the purposes of this provision, a *primary building element* consisting entirely of, or a combination of, any of the following materials is considered not subject to termite attack:
 - (A) Steel, aluminium or other metals.
 - (B) Concrete.
 - (C) Masonry.
 - (D) Fibre-reinforced cement.
 - (E) Timber — naturally termite resistant in accordance with Appendix C of AS 3660.1.
 - (F) Timber — preservative treated in accordance with Appendix D of AS 3660.1; and
 - (ii) a durable notice must be permanently fixed to the building in a prominent location, such as a meter box or the like, indicating—
 - (A) the method of termite risk management; and
 - (B) the date of installation of the system; and
 - (C) where a chemical barrier is used, its life expectancy as listed on the National Registration Authority label; and
 - (D) the installer's or manufacturer's recommendations for the scope and frequency of future inspections for termite activity.

Deemed-to-Satisfy Provisions

- (j) Roof construction (except in cyclone areas):
 - (i) Plastic sheeting: AS/NZS 1562.3, AS/NZS 4256 Parts 1, 2, 3 and 5.
 - (ii) Roofing tiles: AS 2049, AS 2050.
 - (iii) Cellulose cement corrugated sheets: AS/NZS 2908.1 with safety mesh installed in accordance with AS/NZS 1562.3 clause 2.4.3.2 except for sub clause (g) for plastic sheeting.
 - (iv) Metal roofing: AS 1562.1.
 - (v) Asphalt shingles: ASTM D3018-90, Class A.
- (k) Particleboard structural flooring: AS 1860.2.
- (l) Garage doors and other large access doors in openings not more than 3 m in height in *external walls* of buildings determined as being located in wind region C or D in accordance with AS/NZS 1170.2: AS/NZS 4505.
- (m) Lift *shafts* which are not *required* to have an FRL, must—
 - (i) except as required by (ii), be completely enclosed with non-perforated material between the bottom of the pit and the ceiling of the lift *shaft*, other than—
 - (A) at landing doors, emergency doors and pit access doors; and
 - (B) *low-rise, low-speed constant pressure lifts*; and
 - (C) *small-sized, low-rise automatic lifts*; and
 - (ii) in *atrium* and observation areas, be protected with non-perforated material not less than 2.5 m in height—
 - (A) above any places on which a person can stand, which are within 800 mm horizontal reach of any vertical moving lift component including ropes and counterweights; and
 - (B) at the lowest level of the *atrium* area that the lift serves, on all sides except the door opening, for not less than 2.5 m in height, by enclosure with non-perforated material; and
 - (iii) be of non-brittle material; and
 - (iv) where glazing is used—
 - (A) comply with **Table B1.4**; or
 - (B) not fail the deflection criteria *required* by **Clause 6(c)(iii) of Specification C1.8**.

Table B1.4 MATERIAL AND THICKNESS OF GLAZING

| Application | Minimum thickness | |
|---------------------|--|--|
| | Lift <i>shaft</i> vision panels more than 65 000 mm ² , door panels, and lift <i>shafts</i> | Lift <i>shaft</i> vision panels less than or equal to 65 000 mm ² |
| Laminated glass | 10 mm (0.76 mm interlayer) | 6 mm (0.76 mm interlayer) |
| Toughened/Laminated | 10 mm (0.76 mm interlayer) | 6 mm (0.76 mm interlayer) |

Deemed-to-Satisfy Provisions

Table B1.4 MATERIAL AND THICKNESS OF GLAZING— continued

| Application | Minimum thickness | |
|--|--|--|
| | Lift <i>shaft</i> vision panels more than 65 000 mm ² , door panels, and lift <i>shafts</i> | Lift <i>shaft</i> vision panels less than or equal to 65 000 mm ² |
| Annealed, with security polyester film coating | 10 mm | 6 mm |
| Safety wire | Not applicable | Subject to fire test |
| Polycarbonate | 13 mm | 6 mm |

B1.5 Structural software

- (a) Structural software used in computer aided design of a building or structure, that uses design criteria based on the *Deemed-to-Satisfy Provisions* of the BCA, including its referenced documents, must comply with the ABCB Protocol for Structural Software.
- (b) The requirements of (a) only apply to structural software used to design steel or timber trussed roof and floor systems and framed building systems for buildings within the following geometrical limits:
 - (i) The distance from ground level to the underside of eaves must not exceed 6 m.
 - (ii) The distance from ground level to the highest point of the roof, neglecting chimneys must not exceed 8.5 m.
 - (iii) The building width including roofed verandahs, excluding eaves, must not exceed 16 m.
 - (iv) The building length must not exceed five times the building width.
 - (v) The roof pitch must not exceed 35 degrees.
- (c) The requirements of (a) do not apply to design software for individual frame members such as electronic tables similar to those provided in AS 1684.

B1.6 Construction of buildings in flood hazard areas

A Class 2 or 3 building, Class 9a *health-care building*, Class 9c *aged-care building* or Class 4 part of a building, in a *flood hazard area* must comply with the ABCB Standard for Construction of Buildings in Flood Hazard Areas.

SPECIFICATION **B1.2** DESIGN OF BUILDINGS IN CYCLONIC AREAS

Deemed-to-Satisfy Provisions

1. Scope

This specification contains requirements for the design of buildings in cyclonic areas in addition to the requirements of AS/NZS 1170.2.

For the purposes of **Specification B1.2**, cyclonic areas are those determined as being located in wind regions C and D in accordance with AS/NZS 1170.2.

2. Roof Cladding

Test for strength - Metal roof cladding, its connections and immediate supporting members must be capable of remaining in position notwithstanding any permanent distortion, fracture or damage that might occur in the sheet or fastenings under the pressure sequences A to G defined in **Table 1**.

TABLE 1 LOW-HIGH-LOW PRESSURE SEQUENCE

| Sequence | Number of cycles | Load |
|----------|------------------|--------------|
| A | 4500 | 0 to 0.45 Pt |
| B | 600 | 0 to 0.6 Pt |
| C | 80 | 0 to 0.8 Pt |
| D | 1 | 0 to 1.0 Pt |
| E | 80 | 0 to 0.8 Pt |
| F | 600 | 0 to 0.6 Pt |
| G | 4500 | 0 to 0.45 Pt |

Notes:

1. Pt is the ultimate limit state wind pressure on internal and external surfaces as determined in accordance with AS/NZS 1170.2, modified by an appropriate factor for variability, as determined in accordance with Table B1 of AS/NZS 1170.0.
2. The rate of load cycling must be less than 3Hz.
3. The single load cycle (sequence D) must be held for a minimum of 10 seconds.

NT Specification B1.2 Clause NT3 — NT4.

FIRE RESISTANCE

- C1** **Fire Resistance and Stability**
- C2** **Compartmentation and Separation**
- C3** **Protection of Openings**

SECTION C CONTENTS

SECTION C FIRE RESISTANCE

C Fire Resistance

Objective CO1
Functional Statements CF1 - CF2
Performance Requirements CP1 - CP9
Verification Methods CV1 - CV2

Part C1 Fire Resistance and Stability

C1.0 Deemed-to-Satisfy Provisions
C1.1 Type of construction required
C1.2 Calculation of rise in storeys
C1.3 Buildings of multiple classification
C1.4 Mixed types of construction
C1.5 Two storey Class 2, 3 or 9c buildings
C1.6 Class 4 parts of buildings
C1.7 Open spectator stands and indoor sports stadiums
C1.8 Lightweight construction
C1.9 * * * * *
C1.10 Fire hazard properties
C1.11 Performance of external walls in fire
C1.12 Non-combustible materials

Part C2 Compartmentation and Separation

C2.0 Deemed-to-Satisfy Provisions
C2.1 Application of Part
C2.2 General floor area and volume limitations
C2.3 Large isolated buildings
C2.4 Requirements for open spaces and vehicular access
C2.5 Class 9a and 9c buildings
C2.6 Vertical separation of openings in external walls
C2.7 Separation by fire walls
C2.8 Separation of classifications in the same storey
C2.9 Separation of classifications in different storeys
C2.10 Separation of lift shafts
C2.11 Stairways and lifts in one shaft
C2.12 Separation of equipment
C2.13 Electricity supply system
C2.14 Public corridors in Class 2 and 3 buildings

Part C3 Protection of Openings

C3.0 Deemed-to-Satisfy Provisions
C3.1 Application of Part
C3.2 Protection of openings in external walls

- C3.3 Separation of external walls and associated openings in different fire compartments
- C3.4 Acceptable methods of protection
- C3.5 Doorways in fire walls
- C3.6 Sliding fire doors
- C3.7 Protection of doorways in horizontal exits
- C3.8 Openings in fire-isolated exits
- C3.9 Service penetrations in fire-isolated exits
- C3.10 Openings in fire-isolated lift shafts
- C3.11 Bounding construction: Class 2, 3 and 4 buildings
- C3.12 Openings in floors and ceilings for services
- C3.13 Openings in shafts
- C3.14 * * * * *
- C3.15 Openings for service installations
- C3.16 Construction joints
- C3.17 Columns protected with lightweight construction to achieve an FRL

Specifications

- Specification C1.1 Fire-Resisting Construction
- Specification C1.8 Structural Tests for Lightweight Construction
- Specification C1.10 Fire Hazard Properties
- Specification C1.11 Performance of External Walls in Fire
- Specification C2.5 Smoke-Proof Walls in Health-Care and Aged Care Buildings
- Specification C3.4 Fire Doors, Smoke Doors, Fire Windows and Shutters
- Specification C3.15 Penetration of Walls, Floors and Ceilings by Services

SECTION C FIRE RESISTANCE

OBJECTIVE

CO1

The *Objective* of this Section is to—

- (a) safeguard people from illness or injury due to a fire in a building; and
- (b) safeguard occupants from illness or injury while evacuating a building during a fire; and
- (c) facilitate the activities of emergency services personnel; and
- (d) avoid the spread of fire between buildings; and
- (e) protect *other property* from physical damage caused by structural failure of a building as a result of fire.

FUNCTIONAL STATEMENTS

CF1

A building is to be constructed to maintain structural stability during fire to—

- (a) allow occupants time to evacuate safely; and
- (b) allow for *fire brigade* intervention; and
- (c) avoid damage to *other property*.

CF2

A building is to be provided with safeguards to prevent fire spread—

- (a) so that occupants have time to evacuate safely without being overcome by the effects of fire; and
- (b) to allow for *fire brigade* intervention; and
- (c) to *sole-occupancy* units providing sleeping accommodation; and

Application:

CF2(c) only applies to a Class 2 or 3 building or Class 4 part of a building.

- (d) to adjoining *fire compartments*; and
- (e) between buildings.

PERFORMANCE REQUIREMENTS

CP1

A building must have elements which will, to the degree necessary, maintain structural stability during a fire appropriate to—

- (a) the function or use of the building; and
- (b) the *fire load*; and
- (c) the potential *fire intensity*; and
- (d) the *fire hazard*; and
- (e) the height of the building; and
- (f) its proximity to *other property*; and
- (g) any active *fire safety systems* installed in the building; and
- (h) the size of any *fire compartment*; and
- (i) *fire brigade* intervention; and
- (j) other elements they support; and
- (k) the *evacuation time*.

CP2

- (a) A building must have elements which will, to the degree necessary, avoid the spread of fire—
 - (i) to *exits*; and
 - (ii) to *sole-occupancy units* and *public corridors*; and

Application:

CP2(a)(ii) only applies to a Class 2 or 3 building or Class 4 part of a building.

- (iii) between buildings; and
 - (iv) in a building.
- (b) Avoidance of the spread of fire referred to in (a) must be appropriate to—
 - (i) the function or use of the building; and
 - (ii) the *fire load*; and
 - (iii) the potential *fire intensity*; and
 - (iv) the *fire hazard*; and
 - (v) the number of *storeys* in the building; and
 - (vi) its proximity to *other property*; and
 - (vii) any active *fire safety systems* installed in the building; and
 - (viii) the size of any *fire compartment*; and
 - (ix) *fire brigade* intervention; and

- (x) other elements they support; and
- (xi) the *evacuation time*.

CP3

A building must be protected from the spread of fire and smoke to allow sufficient time for the orderly evacuation of the building in an emergency.

Application:

CP3 only applies to—

- (a) a *patient care area* of a Class 9a *health-care building*; and
- (b) a Class 9c *aged care building*.

CP4

To maintain tenable conditions during occupant evacuation, a material and an assembly must, to the degree necessary, resist the spread of fire and limit the generation of smoke and heat, and any toxic gases likely to be produced, appropriate to—

- (a) the *evacuation time*; and
- (b) the number, mobility and other characteristics of occupants; and
- (c) the function or use of the building; and
- (d) any active *fire safety systems* installed in the building.

Application:

CP4 applies to linings, materials and assemblies in a Class 2 to 9 building.

CP5

A concrete *external wall* that could collapse as a complete panel (e.g. tilt-up and pre-cast concrete) must be designed so that in the event of fire within the building the likelihood of outward collapse is avoided.

Limitation:

CP5 does not apply to a building having more than two *storeys* above ground level.

CP6

A building must have elements, which will, to the degree necessary, avoid the spread of fire from service equipment having—

- (a) a high *fire hazard*; or
- (b) a potential for explosion resulting from a high *fire hazard*.

CP7

A building must have elements, which will, to the degree necessary, avoid the spread of fire so that emergency equipment provided in a building will continue to operate for a period of time necessary to ensure that the intended function of the equipment is maintained during a fire.

CP8

Any building element provided to resist the spread of fire must be protected, to the degree necessary, so that an adequate level of performance is maintained—

- (a) where openings, construction joints and the like occur; and
- (b) where penetrations occur for building services.

CP9

Access must be provided to and around a building, to the degree necessary, for *fire brigade* vehicles and personnel to facilitate *fire brigade* intervention appropriate to—

- (a) the function or use of the building; and
- (b) the *fire load*; and
- (c) the potential *fire intensity*; and
- (d) the *fire hazard*; and
- (e) any active *fire safety systems* installed in the building; and
- (f) the size of any *fire compartment*.

VERIFICATION METHODS

CV1

Compliance with **CP2(a)(iii)** to avoid the spread of fire between buildings on adjoining allotments is verified when it is calculated that—

- (a) a building will not cause heat flux in excess of those set out in column 2 of **Table CV1** at locations within the boundaries of an adjoining property set out in column 1 of **Table CV1** where another building may be constructed; and
- (b) when located at the distances from the allotment boundary set out in column 1 of **Table CV1**, a building is capable of withstanding the heat flux set out in column 2 of **Table CV1** without ignition.

Table CV1

| Column 1 | Column 2 |
|-------------------|--------------------------------|
| Location | Heat Flux (kW/m ²) |
| On boundary | 80 |
| 1 m from boundary | 40 |
| 3 m from boundary | 20 |
| 6 m from boundary | 10 |

CV2

Compliance with **CP2(a)(iii)** to avoid the spread of fire between buildings on the same allotment is verified when it is calculated that a building—

- (a) is capable of withstanding the heat flux set out in column 2 of **Table CV2** without ignition; and
- (b) will not cause heat flux in excess of those set out in column 2 of **Table CV2**, when the distance between the buildings is as set out in column 1 of **Table CV2**.

Table CV2

| Column 1 | Column 2 |
|----------------------------|--------------------------------|
| Distance between buildings | Heat Flux (kW/m ²) |
| 0 m | 80 |
| 2 m | 40 |
| 6 m | 20 |
| 12 m | 10 |

PART C1 FIRE RESISTANCE AND STABILITY

Deemed-to-Satisfy Provisions

C1.0 Deemed-to-Satisfy Provisions

- (a) Where a *Building Solution* is proposed to comply with the *Deemed-to-Satisfy Provisions*, *Performance Requirements CP1 to CP9* are satisfied by complying with—
- (i) **C1.1 to C1.12, C2.1 to C2.14 and C3.1 to C3.17**; and
 - (ii) in a building containing an *atrium*, **Part G3**; and
 - (iii) for theatres, *stages* and public halls, **Part H1**.
- (b) Where a *Building Solution* is proposed as an *Alternative Solution* to the *Deemed-to-Satisfy Provisions* of—
- (i) **C1.1 to C1.12, C2.1 to C2.14 and C3.1 to C3.17**; and
 - (ii) in a building containing an *atrium*, **Part G3**; and
 - (iii) for theatres, *stages* and public halls, **Part H1**,
- the relevant *Performance Requirements* must be determined in accordance with **A0.10**.

C1.1 Type of construction required

- (a) The minimum Type of *fire-resisting construction* of a building must be that specified in **Table C1.1** and **Specification C1.1**, except as allowed for—
- (i) certain Class 2, 3 or 9c buildings in **C1.5**; and
 - (ii) a Class 4 part of a building located on the top *storey* in **C1.3(b)**; and
 - (iii) *open spectator stands* and indoor sports stadiums in **C1.7**.
 - (iv) * * * * *

SA C1.1(a)(v)

- (b) Type A construction is the most fire-resistant and Type C the least fire-resistant of the Types of construction.

Table C1.1 TYPE OF CONSTRUCTION REQUIRED

| Rise in storeys | Class of building | |
|-----------------|-------------------|------------|
| | 2, 3, 9 | 5, 6, 7, 8 |
| 4 OR MORE | A | A |
| 3 | A | B |
| 2 | B | C |
| 1 | C | C |

SA C1.1(c) and (d)

Deemed-to-Satisfy Provisions

C1.2 Calculation of rise in storeys

- (a) The *rise in storeys* is the sum of the greatest number of *storeys* at any part of the *external walls* of the building and any *storeys* within the roof space—
- (i) above the finished ground next to that part; or
 - (ii) if part of the *external wall* is on the boundary of the allotment, above the natural ground level at the relevant part of the boundary.
- (b) A *storey* is not counted if—
- (i) it is situated at the top of the building and contains only heating, ventilating or lift equipment, water tanks, or similar service units or equipment; or
 - (ii) it is situated partly below the finished ground and the underside of the ceiling is not more than 1 m above the average finished level of the ground at the *external wall*, or if the *external wall* is more than 12 m long, the average for the 12 m part where the ground is lowest.
- (c) In a Class 7 or 8 building, a *storey* that has an average internal height of more than 6 m is counted as—
- (i) one *storey* if it is the only *storey* above the ground; or
 - (ii) 2 *storeys* in any other case.
- (d) For the purposes of calculating the *rise in storeys* of a building—
- (i) a *mezzanine* is regarded as a *storey* in that part of the building in which it is situated if its *floor area* is more than 200 m² or more than 1/3 of the *floor area* of the room, whichever is the lesser; and
 - (ii) two or more *mezzanines* are regarded as a *storey* in that part of the building in which they are situated if they are at or near the same level and have an aggregate *floor area* more than 200 m² or more than 1/3 of the *floor area* of the room, whichever is the lesser.

C1.3 Buildings of multiple classification

- (a) In a building of multiple classifications, the Type of construction *required* for the building is the most *fire-resisting* Type resulting from the application of **Table C1.1** on the basis that the classification applying to the top *storey* applies to all *storeys*.
- (b) In a building containing a Class 4 part on the top *storey*, for the purpose of (a), the classification applying to the top *storey* must be—
- (i) when the Class 4 part occupies the whole of the top *storey*, the classification applicable to the next highest *storey*; or
 - (ii) when the Class 4 part occupies part of the top *storey*, the classification applicable to the adjacent part.

C1.4 Mixed types of construction

A building may be of mixed Types of construction where it is separated in accordance with **C2.7** and the Type of construction is determined in accordance with **C1.1** or **C1.3**.

Deemed-to-Satisfy Provisions

C1.5 Two storey Class 2, 3 or 9c buildings

A building having a *rise in storeys* of 2 may be of Type C construction if—

- (a) it is a Class 2 or 3 building or a mixture of these classes and each *sole-occupancy unit* has—
 - (i) access to at least 2 *exits*; or
 - (ii) its own direct access to a road or *open space*.
- (b) it is a Class 9c *aged care building* protected throughout with a sprinkler system complying with **Specification E1.5** and complies with the maximum compartment size specified in **Table C2.2** for Type C construction.

C1.6 Class 4 parts of buildings

For the Type of construction *required* by **C1.3**, a Class 4 part of a building requires the same FRL for building elements and the same construction separating the Class 4 part from the remainder of the building as a Class 2 part in the same Type of construction.

C1.7 Open spectator stands and indoor sports stadiums

- (a) An *open spectator stand* or indoor sports stadium may be of Type C construction and need not comply with the other provisions of this Part if it contains not more than 1 tier of seating, is of *non-combustible* construction, and has only changing rooms, sanitary facilities or the like below the tiered seating.
- (b) In (a), one tier of seating means numerous rows of tiered seating incorporating cross-overs but within one viewing level.

C1.8 Lightweight construction

- (a) *Lightweight construction* must comply with **Specification C1.8** if it is used in a wall system—
 - (i) that is *required* to have an FRL; or
 - (ii) for a lift *shaft*, stair *shaft* or service *shaft* or an *external wall* bounding a *public corridor* including a non *fire-isolated passageway* or non *fire-isolated ramp*, in a spectator stand, sports stadium, cinema or theatre, railway station, bus station or airport terminal.
- (b) If *lightweight construction* is used for the *fire-resisting* covering of a steel column or the like, and if—
 - (i) the covering is not in continuous contact with the column, then the void must be filled solid, to a height of not less than 1.2 m above the floor to prevent indenting; and
 - (ii) the column is liable to be damaged from the movement of vehicles, materials or equipment, then the covering must be protected by steel or other suitable material.

C1.9 * * * * *

This clause has deliberately been left blank.

Deemed-to-Satisfy Provisions

C1.10 Fire hazard properties

- (a) The *fire hazard properties* of the following linings, materials and assemblies in a Class 2 to 9 building must comply with **Specification C1.10**:
- (i) Floor linings and floor coverings.
 - (ii) Wall linings and ceiling linings.
 - (iii) Air-handling ductwork.
 - (iv) Lift cars.

NSW C1.10(a)(v)

- (v) In Class 9b buildings used as a theatre, public hall or the like—
 - (A) fixed seating in the audience area or auditorium; and
 - (B) a proscenium curtain *required* by **Specification H1.3**.
- (vi) Escalators, moving walkways and non-*required* non *fire-isolated stairways* or pedestrian ramps subject to **Specification D1.12**.
- (vii) *Sarking-type materials*.
- (viii) Attachments to floors, ceilings, internal walls and the internal linings of external walls.
- (ix) Other materials including insulation materials other than *sarking-type materials*.

NSW C1.10(b)

- (b) Paint or fire-retardant coatings must not be used to make a substrate comply with the *required fire hazard properties*.
- (c) The requirements of **(a)** do not apply to a material or assembly if it is—
- (i) plaster, cement render, concrete, terrazzo, ceramic tile or the like; or
 - (ii) a *fire-protective covering*; or
 - (iii) a timber-framed *window*; or
 - (iv) a solid timber handrail or skirting; or
 - (v) a timber-faced solid-core door or timber-faced fire door; or
 - (vi) an electrical switch, socket-outlet, cover plate or the like; or
 - (vii) a material used for—
 - (A) a roof insulating material applied in continuous contact with a substrate; or
 - (B) an adhesive; or
 - (C) a damp-proof course, flashing, caulking, sealing, ground moisture barrier, or the like; or
 - (viii) a paint, varnish, lacquer or similar finish, other than nitro-cellulose lacquer; or
 - (ix) a clear or translucent roof light of glass fibre-reinforced polyester if—
 - (A) the roof in which it is installed forms part of a single *storey* building *required* to be Type C construction; and
 - (B) the material is used as part of the roof covering; and

Deemed-to-Satisfy Provisions

- (C) it is not closer than 1.5 m from another roof light of the same type; and
- (D) each roof light is not more than 14 m² in area; and
- (E) the area of the roof lights per 70 m² of roof surface is not more than 14 m²; or
- (x) a face plate or neck adaptor of supply and return air outlets of an air handling system; or
- (xi) a face plate or diffuser plate of light fitting and emergency *exit* signs and associated electrical wiring and electrical components; or
- (xii) a joinery unit, cupboard, shelving, or the like; or

NSW C1.10(c)(xiii)

- (xiii) an attached non-building fixture and fitting such as—
 - (A) a curtain, blind, or similar decor, other than a proscenium curtain *required* by **Specification H1.3**; and
 - (B) a whiteboard, *window* treatment or the like; or
- (xiv) any other material that does not significantly increase the hazards of fire.

C1.11 Performance of external walls in fire

Concrete *external walls* that could collapse as complete panels (e.g. tilt-up and pre-cast concrete), in a building having a *rise in storeys* of not more than 2, must comply with **Specification C1.11**.

C1.12 Non-combustible materials

The following materials, though *combustible* or containing *combustible* fibres, may be used wherever a *non-combustible* material is *required*:

- (a) Plasterboard.
- (b) Perforated gypsum lath with a normal paper finish.
- (c) Fibrous-plaster sheet.
- (d) Fibre-reinforced cement sheeting.
- (e) Pre-finished metal sheeting having a *combustible* surface finish not exceeding 1 mm thickness and where the *Spread-of-Flame Index* of the product is not greater than 0.
- (f) Bonded laminated materials where—
 - (i) each laminate is *non-combustible*; and
 - (ii) each adhesive layer does not exceed 1 mm in thickness; and
 - (iii) the total thickness of the adhesive layers does not exceed 2 mm; and
 - (iv) the *Spread-of-Flame Index* and the *Smoke-Developed Index* of the laminated material as a whole does not exceed 0 and 3 respectively.

PART C2

COMPARTMENTATION AND SEPARATION

Deemed-to-Satisfy Provisions

C2.0 Deemed-to-Satisfy Provisions

- (a) Where a *Building Solution* is proposed to comply with the *Deemed-to-Satisfy Provisions*, *Performance Requirements CP1* to *CP9* are satisfied by complying with—
- (i) **C1.1** to **C1.12**, **C2.1** to **C2.14** and **C3.1** to **C3.17**; and
 - (ii) in a building containing an *atrium*, **Part G3**; and
 - (iii) for theatres, *stages* and public halls, **Part H1**.
- (b) Where a *Building Solution* is proposed as an *Alternative Solution* to the *Deemed-to-Satisfy Provisions* of—
- (i) **C1.1** to **C1.12**, **C2.1** to **C2.14** and **C3.1** to **C3.17**; and
 - (ii) in a building containing an *atrium*, **Part G3**; and
 - (iii) for theatres, *stages* and public halls, **Part H1**,
- the relevant *Performance Requirements* must be determined in accordance with **A0.10**.

C2.1 Application of Part

- (a) **C2.2**, **C2.3** and **C2.4** do not apply to a *carpark* provided with a sprinkler system complying with **Specification E1.5**, an *open-deck carpark* or an *open spectator stand*.
- (b) **C2.12(a)(v)** does not apply to a Class 8 *electricity network substation*.

C2.2 General floor area and volume limitations

- (a) The size of any *fire compartment* or *atrium* in a Class 5, 6, 7, 8 or 9 building must not exceed the relevant maximum *floor area* nor the relevant maximum volume set out in **Table C2.2** and **C2.5** except as permitted in **C2.3**.
- (b) A part of a building which contains only heating, ventilating, or lift equipment, water tanks, or similar service units is not counted in the *floor area* or volume of a *fire compartment* or *atrium* if it is situated at the top of the building.
- (c) In a building containing an *atrium*, the part of the *atrium well* bounded by the perimeter of the openings in the floors and extending from the level of the first floor above the *atrium* floor to the roof covering is not counted in the volume of the *atrium* for the purposes of this clause.

Table C2.2 MAXIMUM SIZE OF FIRE COMPARTMENTS OR ATRIA

| Classification | | Type of construction of building | | |
|---------------------------------------|-------------------------|----------------------------------|-----------------------|-----------------------|
| | | Type A | Type B | Type C |
| 5, 9b or 9c <i>aged care building</i> | max <i>floor area</i> — | 8 000 m ² | 5 500 m ² | 3 000 m ² |
| | max volume— | 48 000 m ³ | 33 000 m ³ | 18 000 m ³ |

Deemed-to-Satisfy Provisions

Table C2.2 MAXIMUM SIZE OF FIRE COMPARTMENTS OR ATRIA — *continued*

| Classification | Type of construction of building | | |
|---|---|-----------------------|-----------------------|
| | Type A | Type B | Type C |
| 6, 7, 8 or 9a (except for <i>patient care areas</i>) | max <i>floor area</i> — 5 000 m ² | 3 500 m ² | 2 000 m ² |
| | max volume— 30 000 m ³ | 21 000 m ³ | 12 000 m ³ |

Note: See **C2.5** for maximum size of compartments in *patient care areas* in Class 9a *health care buildings*.

C2.3 Large isolated buildings

The size of a *fire compartment* in a building may exceed that specified in **Table C2.2** where—

- (a) the building does not exceed 18 000 m² in *floor area* nor exceed 108 000 m³ in volume, if—
 - (i) the building is Class 7 or 8 and—
 - (A) contains not more than 2 *storeys*; and
 - (B) is provided with open space complying with **C2.4(a)** not less than 18 m wide around the building; or
 - (ii) the building is Class 5, 6, 7, 8 or 9 and is—
 - (A) protected throughout with a sprinkler system complying with **Specification E1.5**; and
 - (B) provided with a perimeter vehicular access complying with **C2.4(b)**; or
- (b) the building is Class 5, 6, 7, 8 or 9 and exceeds 18 000 m² in *floor area* or 108 000 m³ in volume, if it is—
 - (i) protected throughout with a sprinkler system complying with **Specification E1.5**; and
 - (ii) provided with a perimeter vehicular access complying with **C2.4(b)**; or
- (c) there is more than one building on the allotment and—
 - (i) each building complies with (a) or (b); or
 - (ii) if the buildings are closer than 6 m to each other they are regarded as one building and collectively comply with (a) or (b).

C2.4 Requirements for open spaces and vehicular access

- (a) An open space *required* by **C2.3** must—
 - (i) be wholly within the allotment except that any road, river, or public place adjoining the allotment, but not the farthest 6 m of it may be included; and
 - (ii) include vehicular access in accordance with (b); and
 - (iii) not be used for the storage or processing of materials; and
 - (iv) not be built upon, except for guard houses and service structures (such as electricity substations and pump houses) which may encroach upon the width of the space if they do not unduly impede fire-fighting at any part of the perimeter of

Deemed-to-Satisfy Provisions

the allotment or unduly add to the risk of spread of fire to any building on an adjoining allotment.

- (b) Vehicular access *required* by this Part—
- (i) must be capable of providing continuous access for emergency vehicles to enable travel in a forward direction from a public road around the entire building; and
 - (ii) must have a minimum unobstructed width of 6 m with no part of its furthest boundary more than 18 m from the building and in no part of the 6 m width be built upon or used for any purpose other than vehicular or pedestrian movement; and
 - (iii) must provide reasonable pedestrian access from the vehicular access to the building; and
 - (iv) must have a load bearing capacity and unobstructed height to permit the operation and passage of *fire brigade* vehicles; and
 - (v) must be wholly within the allotment except that a public road complying with (i), (ii), (iii) and (iv) may serve as the vehicular access or part thereof.

C2.5 Class 9a and 9c buildings

- (a) A Class 9a *health care building* must comply with the following:
- (i) *Patient care areas* must be divided into *fire compartments* not exceeding 2000 m².
 - (ii) A *fire compartment* must be separated from the remainder of the building by *fire walls* and—
 - (A) in Type A construction—floors and roof or ceiling as *required* in **Specification C1.1**; and
 - (B) in Type B construction—floors with an FRL of not less than 120/120/120 and with the openings in *external walls* bounding *patient care areas* being vertically separated in accordance with the requirements of **C2.6** as if the building were of Type A construction.
 - (iii) *Ward areas*—
 - (A) where the *floor area* exceeds 1000 m², must be divided into *floor areas* not more than 1000 m² by walls with an FRL of not less than 60/60/60; and
 - (B) where the *floor area* exceeds 500 m², must be divided into *floor areas* not more than 500 m² by smoke-proof walls complying with **Specification C2.5**; and
 - (C) where the *floor area* is not more than 500 m², must be separated from the remainder of the *patient care area* by smoke-proof walls complying with **Specification C2.5**; and
 - (D) where division of *ward areas* by *fire-resisting* walls under (i) or (iii)(A) is not *required*, any smoke-proof wall *required* under (iii)(B) or (C) must have an FRL of not less than 60/60/60.
 - (iv) *Treatment areas*—
 - (A) where the *floor area* exceeds 1000 m², must be divided into *floor areas* not more than 1000 m² by smoke-proof walls complying with **Specification C2.5**; and

Deemed-to-Satisfy Provisions

- (B) where the *floor area* is not more than 1000 m², must be separated from the remainder of the *patient care area* by smoke-proof walls complying with **Specification C2.5**.
- (v) Ancillary use areas located within a *patient care area* and containing equipment or materials that are a high potential *fire hazard*, must be separated from the remainder of the *patient care area* by walls with an FRL of not less than 60/60/60.
- (vi) The ancillary use areas referred to in (v) include, but are not limited to, the following:
 - (A) A kitchen and related food preparation areas having a combined *floor area* of more than 30 m².
 - (B) A room containing a hyperbaric facility (pressure chamber).
 - (C) A room used predominantly for the storage of medical records having a *floor area* of more than 10 m².
 - (D) A laundry, where items of equipment are of the type that are potential fire sources (e.g. gas fire dryers).
- (vii) A wall *required* by (v) to separate ancillary use areas from the remainder of the building must extend to the underside of—
 - (A) the floor above; or
 - (B) a *non-combustible* roof covering; or
 - (C) a ceiling having a *resistance to the incipient spread of fire* to the space above itself of not less than 60 minutes.
- (viii) Openings in walls *required* by (ii) and (v) to have an FRL must be protected as follows:
 - (A) Doorways—*self-closing* or *automatic* closing –/60/30 fire doors.
 - (B) Windows—*automatic* or permanently fixed closed –/60/– fire windows or –/60/– *automatic* fire shutters.
 - (C) Other openings—construction having an FRL not less than –/60/–.

NSW C2.5(b)

- (b) A Class 9c *aged care building* must comply with the following:
 - (i) A building must be divided into areas not more than 500 m² by smoke-proof walls complying with **Specification C2.5**.
 - (ii) A *fire compartment* must be separated from the remainder of the building by *fire walls* and, notwithstanding **C2.7** and **Specification C1.1**, floors with an FRL of not less than 60/60/60.
 - (iii) Internal walls (other than those bounding lift and stair shafts) supported by floors provided in accordance with **C2.5(b)(ii)** need not comply with **Specification C1.1** if they have an FRL not less than 60/–/–.
 - (iv) Ancillary use areas containing equipment or materials that are a high potential *fire hazard*, must be separated from the *sole-occupancy units* by smoke-proof walls complying with **Specification C2.5**.
 - (v) The ancillary use areas referred to in (iv) include, but are not limited to, the following:

Deemed-to-Satisfy Provisions

- (A) A kitchen and related food preparation areas having a combined *floor area* of more than 30 m².
- (B) A laundry, where items of equipment are of the type that are potential fire sources (e.g. gas fire dryers).
- (C) Storage rooms greater than 10 m² used predominantly for the storage of administrative records.
- (vi) Openings in *fire walls* must be protected as follows:
 - (A) Doorways — *self-closing* or *automatic* closing –/60/30 fire doors.
 - (B) Windows — *automatic* or permanently fixed closed –/60/– fire windows or –/60/– *automatic* fire shutters.
 - (C) Other openings — construction having an FRL not less than –/60/–.

C2.6 Vertical separation of openings in external walls

- (a) If in a building of Type A construction, any part of a *window* or other opening in an *external wall* is above another opening in the *storey* next below and its vertical projection falls no further than 450 mm outside the lower opening (measured horizontally), the openings must be separated by—
 - (i) a spandrel which—
 - (A) is not less than 900 mm in height; and
 - (B) extends not less than 600 mm above the upper surface of the intervening floor; and
 - (C) is of *non-combustible* material having an FRL of not less than 60/60/60; or
 - (ii) part of a *curtain wall* or *panel wall* that complies with (i); or
 - (iii) construction that complies with (i) behind a *curtain wall* or *panel wall* and has any gaps packed with a *non-combustible* material that will withstand thermal expansion and structural movement of the walling without the loss of seal against fire and smoke; or
 - (iv) a slab or other horizontal construction that—
 - (A) projects outwards from the external face of the wall not less than 1100 mm; and
 - (B) extends along the wall not less than 450 mm beyond the openings concerned; and
 - (C) is *non-combustible* and has an FRL of not less than 60/60/60.
- (b) The requirements of (a) do not apply to—
 - (i) an *open-deck carpark*; or
 - (ii) an *open spectator stand*; or
 - (iii) a building which has a sprinkler system complying with **Specification E1.5** installed throughout; or
 - (iv) openings within the same stairway; or

Deemed-to-Satisfy Provisions

- (v) openings in *external walls* where the floor separating the *storeys* does not require an FRL with respect to *integrity* and *insulation*.
- (c) For the purposes of **C2.6**, *window* or other opening means that part of the *external wall* of a building that does not have an FRL of 60/60/60 or greater.

C2.7 Separation by fire walls

- (a) **Construction** — A *fire wall* must be constructed in accordance with the following:
 - (i) The *fire wall* has the relevant FRL prescribed by **Specification C1.1** for each of the adjoining parts, and if these are different, the greater FRL, except where **Tables 3.9, 4.2 and 5.2 of Specification C1.1** permit a lower FRL on the *carpark* side.
 - (ii) Any openings in a *fire wall* must not reduce the FRL *required* by **Specification C1.1** for the *fire wall*, except where permitted by the *Deemed-to-Satisfy Provisions* of **Part C3**.
 - (iii) Building elements, other than roof battens with dimensions of 75 mm x 50 mm or less or *sarking-type material*, must not pass through or cross the *fire wall* unless the *required fire resisting* performance of the *fire wall* is maintained.
- (b) **Separation of buildings** — A part of a building separated from the remainder of the building by a *fire wall* may be treated as a separate building for the purposes of the *Deemed-to-Satisfy Provisions* of **Sections C, D and E** if it is constructed in accordance with **(a)** and the following:
 - (i) The *fire wall* extends through all *storeys* and spaces in the nature of *storeys* that are common to that part and any adjoining part of the building.
 - (ii) The *fire wall* is carried through to the underside of the roof covering.
 - (iii) Where the roof of one of the adjoining parts is lower than the roof of the other part, the *fire wall* extends to the underside of—
 - (A) the covering of the higher roof, or not less than 6 m above the covering of the lower roof; or
 - (B) the lower roof if it has an FRL not less than that of the *fire wall* and no openings closer than 3 m to any wall above the lower roof; or
 - (C) the lower roof if its covering is *non-combustible* and the lower part has a sprinkler system complying with **Specification E1.5**.
- (c) **Separation of fire compartments** — A part of a building separated from the remainder of the building by a *fire wall* may be treated as a separate *fire compartment* if it is constructed in accordance with **(a)** and the *fire wall* extends to the underside of—
 - (i) a floor having an FRL *required* for a *fire wall*; or
 - (ii) the roof covering.

C2.8 Separation of classifications in the same storey

If a building has parts of different classifications located alongside one another in the same *storey*—

- (a) each building element in that *storey* must have the higher FRL prescribed in **Specification C1.1** for that element for the classifications concerned; or
- (b) the parts must be separated in that *storey* by a *fire wall* having—

Deemed-to-Satisfy Provisions

- (i) the higher FRL prescribed in **Table 3** or **4**; or
- (ii) the FRL prescribed in **Table 5**,
of **Specification C1.1** as applicable, for that element for the Type of construction and the classifications concerned; or
- (c) where one part is a carpark complying with **Table 3.9, 4.2** or **5.2 of Specification C1.1**, the parts may be separated by a *fire wall* complying with the appropriate Table.

C2.9 Separation of classifications in different storeys

If parts of different classification are situated one above the other in adjoining *storeys* they must be separated as follows:

- (a) Type A construction — The floor between the adjoining parts must have an FRL of not less than that prescribed in **Specification C1.1** for the classification of the lower *storey*.
- (b) Type B or C construction — If one of the adjoining parts is of Class 2, 3 or 4, the floor separating the part from the *storey* below must—
 - (i) be a floor/ceiling system incorporating a ceiling which has a *resistance to the incipient spread of fire* to the space above itself of not less than 60 minutes; or
 - (ii) have an FRL of at least 30/30/30; or
 - (iii) have a *fire-protective covering* on the underside of the floor, including beams incorporated in it, if the floor is *combustible* or of metal.

C2.10 Separation of lift shafts

- (a) Any lift connecting more than 2 *storeys*, or more than 3 *storeys* if the building is sprinklered, (other than lifts which are wholly within an *atrium*) must be separated from the remainder of the building by enclosure in a *shaft* in which—
 - (i) in a building *required* to be of Type A construction—the walls have the relevant FRL prescribed by **Specification C1.1**; and
 - (ii) in a building *required* to be of Type B construction — the walls—
 - (A) if *loadbearing*, have the relevant FRL prescribed by **Table 4 of Specification C1.1**; or
 - (B) if *non-loadbearing*, be of *non-combustible* construction.
- (b) Any lift in a *patient care area* in a Class 9a *health-care building* or a *resident use area* in Class 9c *aged care building* must be separated from the remainder of the building by a *shaft* having an FRL of not less than—
 - (i) in a building of Type A or B construction — 120/120/120; or
 - (ii) in a building of Type C construction — 60/60/60.
- (c) An emergency lift must be contained within a *fire-resisting shaft* having an FRL of not less than 120/120/120.
- (d) Openings for lift landing doors and services must be protected in accordance with the *Deemed-to-Satisfy Provisions* of **Part C3**.

Deemed-to-Satisfy Provisions

C2.11 Stairways and lifts in one shaft

A stairway and lift must not be in the same *shaft* if either the stairway or the lift is *required* to be in a *fire-resisting shaft*.

C2.12 Separation of equipment

- (a) Equipment other than that described in (b) and (c) must be separated from the remainder of the building with construction complying with (d), if that equipment comprises—
 - (i) lift motors and lift control panels; or
 - (ii) emergency generators used to sustain emergency equipment operating in the emergency mode; or
 - (iii) central smoke control plant; or
 - (iv) boilers; or
 - (v) a battery or batteries installed in the building that have a voltage exceeding 24 volts and a capacity exceeding 10 ampere hours.
- (b) Equipment need not be separated in accordance with (a) if the equipment comprises—
 - (i) smoke control exhaust fans located in the air stream which are constructed for high temperature operation in accordance with **Specification E2.2b**; or
 - (ii) stair pressurising equipment installed in compliance with the relevant provisions of AS/NZS 1668.1; or
 - (iii) a lift installation without a machine-room; or
 - (iv) equipment otherwise adequately separated from the remainder of the building.
- (c) Separation of on-site fire pumps must comply with the requirements of AS 2419.1.
- (d) Separating construction must have—
 - (i) except as provided by (ii)—
 - (A) an FRL as *required* by **Specification C1.1**, but not less than 120/120/120; and
 - (B) any doorway protected with a *self-closing* fire door having an FRL of not less than –/120/30; or
 - (ii) when separating a lift *shaft* and lift motor room, an FRL not less than 120/–/–.

C2.13 Electricity supply system

- (a) An electricity substation located within a building must—
 - (i) be separated from any other part of the building by construction having an FRL of not less than 120/120/120; and
 - (ii) have any doorway in that construction protected with a *self-closing* fire door having an FRL of not less than –/120/30.
- (b) A main switchboard located within the building which sustains emergency equipment operating in the emergency mode must—
 - (i) be separated from any other part of the building by construction having an FRL of not less than 120/120/120; and

Deemed-to-Satisfy Provisions

- (ii) have any doorway in that construction protected with a *self-closing* fire door having an FRL of not less than –/120/30.
- (c) Electrical conductors located within a building that supply—
 - (i) a substation located within the building which supplies a main switchboard covered by (b); or
 - (ii) a main switchboard covered by (b),
must—
 - (iii) have a classification in accordance with AS/NZS 3013 of not less than—
 - (A) if located in a position that could be subject to damage by motor vehicles — WS53W; or
 - (B) otherwise — WS52W; or
 - (iv) be enclosed or otherwise protected by construction having an FRL of not less than 120/120/120.
- (d) Where emergency equipment is *required* in a building, all switchboards in the electrical installation, which sustain the electricity supply to the emergency equipment, must be constructed so that emergency equipment switchgear is separated from non-emergency equipment switchgear by metal partitions designed to minimise the spread of a fault from the non-emergency equipment switchgear.
- (e) For the purposes of (d), emergency equipment includes but is not limited to the following:
 - (i) Fire hydrant booster pumps.
 - (ii) Pumps for *automatic* sprinkler systems, water spray, chemical fluid suppression systems or the like.
 - (iii) Pumps for fire hose reels where such pumps and fire hose reels form the sole means of fire protection in the building.
 - (iv) Air handling systems designed to exhaust and control the spread of fire and smoke.
 - (v) Emergency lifts.
 - (vi) Control and indicating equipment.
 - (vii) Sound systems and intercom systems for emergency purposes.

C2.14 Public corridors in Class 2 and 3 buildings

In a Class 2 or 3 building, a *public corridor*, if more than 40 m in length, must be divided at intervals of not more than 40 m with smoke-proof walls complying with **Clause 2 of Specification C2.5**.

SA C2.15

PART C3

PROTECTION OF OPENINGS

Deemed-to-Satisfy Provisions

C3.0 Deemed-to-Satisfy Provisions

- (a) Where a *Building Solution* is proposed to comply with the *Deemed-to-Satisfy Provisions*, *Performance Requirements CP1 to CP9* are satisfied by complying with—
- (i) **C1.1 to C1.12, C2.1 to C2.14 and C3.1 to C3.17**; and
 - (ii) in a building containing an *atrium*, **Part G3**; and
 - (iii) for theatres, *stages* and public halls, **Part H1**.
- (b) Where a *Building Solution* is proposed as an *Alternative Solution* to the *Deemed-to-Satisfy Provisions* of—
- (i) **C1.1 to C1.12, C2.1 to C2.14 and C3.1 to C3.17**; and
 - (ii) in a building containing an *atrium*, **Part G3**; and
 - (iii) for theatres, *stages* and public halls, **Part H1**,
- the relevant *Performance Requirements* must be determined in accordance with **A0.10**.

C3.1 Application of Part

- (a) The *Deemed-to-Satisfy Provisions* of this Part do not apply to—
- (i) control joints, weep holes and the like in *external walls* of masonry construction and joints between panels in *external walls* of pre-cast concrete panel construction if, in all cases they are not larger than necessary for the purpose; and
 - (ii) *non-combustible* ventilators for sub-floor or cavity ventilation, if each does not exceed 45 000 mm² in face area and is spaced not less than 2 m from any other ventilator in the same wall; and
 - (iii) openings in the vertical plane formed between building elements at the construction edge or perimeter of a balcony or verandah, colonnade, terrace, or the like; and
 - (iv) in a *carpark*—
 - (A) service penetrations through; and
 - (B) openings formed by a vehicle ramp in,
a floor other than a floor that separates a part not used as a *carpark*.
- (b) For the purposes of the *Deemed-to-Satisfy Provisions* of this Part, openings in building elements *required* to be *fire-resisting* include doorways, *windows* (including any associated fanlight), infill panels and fixed or openable glazed areas that do not have the *required* FRL.
- (c) For the purposes of the *Deemed-to-Satisfy Provisions* of this Part, openings, other than those covered under (a)(iii), between building elements such as columns, beams and the like, in the plane formed at the construction edge or perimeter of the building, are deemed to be openings in an *external wall*.

Deemed-to-Satisfy Provisions

C3.2 Protection of openings in external walls

Openings in an *external wall* that is *required* to have an FRL must—

- (a) if the distance between the opening and the *fire-source feature* to which it is exposed is less than—
 - (i) 3 m from a side or rear boundary of the allotment; or
 - (ii) 6 m from the far boundary of a road, river, lake or the like adjoining the allotment, if not located in a *storey* at or near ground level; or
 - (iii) 6 m from another building on the allotment that is not Class 10,
be protected in accordance with **C3.4** and if wall-wetting sprinklers are used, they are located externally; and
- (b) if *required* to be protected under (a), not occupy more than 1/3 of the area of the *external wall* of the *storey* in which it is located unless they are in a Class 9b building used as an *open spectator stand*.

C3.3 Separation of external walls and associated openings in different fire compartments

The distance between parts of *external walls* and any openings within them in different *fire compartments* separated by a *fire wall* must not be less than that set out in **Table C3.3**, unless—

- (a) those parts of each wall have an FRL not less than 60/60/60; and
- (b) any openings protected in accordance with **C3.4**.

Table C3.3 DISTANCE BETWEEN EXTERNAL WALLS AND ASSOCIATED OPENINGS IN DIFFERENT FIRE COMPARTMENTS

| Angle between walls | Min. Distance |
|----------------------------------|---------------|
| 0° (walls opposite) | 6 m |
| more than 0° to 45° | 5 m |
| more than 45° to 90° | 4 m |
| more than 90° to 135° | 3 m |
| more than 135° to less than 180° | 2 m |
| 180° or more | Nil |

C3.4 Acceptable methods of protection

- (a) Where protection is *required*, doorways, *windows* and other openings must be protected as follows:
 - (i) Doorways—
 - (A) internal or external wall-wetting sprinklers as appropriate used with doors that are *self-closing* or *automatic* closing; or
 - (B) –/60/30 fire doors that are *self-closing* or *automatic* closing.
 - (ii) *Windows*—

Deemed-to-Satisfy Provisions

- (A) internal or external wall-wetting sprinklers as appropriate used with *windows* that are *automatic* closing or permanently fixed in the closed position; or
 - (B) –/60/– fire *windows* that are *automatic* closing or permanently fixed in the closed position; or
 - (C) –/60/– *automatic* closing fire shutters.
- (iii) Other openings—
- (A) excluding voids — internal or external wall-wetting sprinklers, as appropriate; or
 - (B) construction having an FRL not less than –/60/–.
- (b) Fire doors, fire *windows* and fire shutters must comply with **Specification C3.4**.

C3.5 Doorways in fire walls

- (a) The aggregate width of openings for doorways in a *fire wall*, which are not part of a *horizontal exit*, must not exceed $\frac{1}{2}$ of the length of the *fire wall*, and each doorway must be protected by—
- (i) 2 fire doors or fire shutters, one on each side of the doorway, each of which has an FRL of not less than $\frac{1}{2}$ that *required* by **Specification C1.1** for the *fire wall* except that each door or shutter must have an *insulation* level of at least 30; or
 - (ii) a fire door on one side and a fire shutter on the other side of the doorway, each of which complies with (i); or
 - (iii) a single fire door or fire shutter which has an FRL of not less than that *required* by **Specification C1.1** for the *fire wall* except that each door or shutter must have an *insulation* level of at least 30.
- (b)
- (i) A fire door or fire shutter *required* by (a)(i), (a)(ii) or (a)(iii) must be *self-closing*, or *automatic* closing in accordance with (ii) and (iii).
 - (ii) The *automatic* closing operation must be initiated by the activation of a smoke detector, or any other detector deemed suitable in accordance with AS 1670.1 if smoke detectors are unsuitable in the atmosphere, installed in accordance with the relevant provisions of AS 1670.1 and located on each side of the *fire wall* not more than 1.5 m horizontal distance from the opening.
 - (iii) Where any other *required* suitable fire alarm system, including a sprinkler system complying with **Specification E1.5**, is installed in the building, activation of the system in either *fire compartment* separated by the *fire wall* must also initiate the *automatic* closing operation.

C3.6 Sliding fire doors

- (a) If a doorway in a *fire wall* is fitted with a sliding fire door which is open when the building is in use—
- (i) it must be held open with an electromagnetic device, which when de-activated in accordance with (b), allows the door to be fully closed in not less than 20 seconds and not more than 30 seconds after release; and

Deemed-to-Satisfy Provisions

- (ii) in the event of power failure to the door — the door must fail safe in the closed position in accordance with (i); and
- (iii) an audible warning device must be located near the doorway and a red flashing warning light of adequate intensity on each side of the doorway must be activated in accordance with (b); and
- (iv) signs must be installed on each side of the doorway located directly over the opening stating—

WARNING — SLIDING FIRE DOOR

in capital letters not less than 50 mm high in a colour contrasting with the background.

- (b)
 - (i) The electromagnetic device must be de-activated and the warning system activated by heat or smoke detectors, as appropriate, installed in accordance with AS 1905.1 and the relevant provisions of AS 1670.1.
 - (ii) Where any other *required* suitable fire alarm system, including a sprinkler system complying with **Specification E1.5**, is installed in the building, activation in either *fire compartment* separated by the *fire wall* must also de-activate the electromagnetic device and activate the warning system.

C3.7 Protection of doorways in horizontal exits

- (a) A doorway that is part of a *horizontal exit* must be protected by either—
 - (i) a single fire door that has an FRL of not less than that *required* by **Specification C1.1** for the *fire wall* except that the door must have an *insulation* level of at least 30; or
 - (ii) in a Class 7 or 8 building — 2 fire doors, one on each side of the doorway, each with an FRL of not less than ½ that *required* by **Specification C1.1** for the *fire wall* except that each door must have an *insulation* level of at least 30.
- (b)
 - (i) Each door *required* by (a) must be *self-closing*, or *automatic-closing* in accordance with (ii) and (iii).
 - (ii) The *automatic-closing* operation must be initiated by the activation of a smoke detector, or any other detector deemed suitable in accordance with AS 1670.1 if smoke detectors are unsuitable in the atmosphere, installed in accordance with the relevant provisions of AS 1670.1 and located on each side of the *fire wall* not more than 1.5 m horizontal distance from the opening.
 - (iii) Where any other *required* suitable fire alarm system, including a sprinkler system complying with **Specification E1.5**, is installed in the building, activation of the system in either *fire compartment* separated by the *fire wall* must also initiate the *automatic-closing* operation.

Deemed-to-Satisfy Provisions

C3.8 Openings in fire-isolated exits

- (a)
 - (i) Doorways that open to *fire-isolated stairways*, *fire-isolated passageways* or *fire-isolated ramps*, and are not doorways opening to a road or *open space*, must be protected by –/60/30 fire doors that are *self-closing*, or *automatic-closing* in accordance with (ii) and (iii).
 - (ii) The *automatic-closing* operation must be initiated by the activation of a smoke detector, or any other detector deemed suitable in accordance with AS 1670 if smoke detectors are unsuitable in the atmosphere, installed in accordance with the relevant provisions of AS 1670.1 and located not more than 1.5 m horizontal distance from the approach side of the doorway.
 - (iii) Where any other *required* suitable fire alarm system, including a sprinkler system complying with **Specification E1.5**, is installed in the building, activation of the system must also initiate the *automatic-closing* operation.
- (b) A *window* in an *external wall* of a *fire-isolated stairway*, *fire-isolated passageway* or *fire-isolated ramp* must be protected in accordance with **C3.4** if it is within 6 m of, and exposed to, a *window* or other opening in a wall of the same building, other than in the same fire-isolated enclosure.

C3.9 Service penetrations in fire-isolated exits

Fire-isolated *exits* must not be penetrated by any services other than—

- (a) electrical wiring permitted by **D2.7(e)** to be installed within the *exit*; or
- (b) ducting associated with a pressurisation system if it—
 - (i) is constructed of material having an FRL of not less than –/120/60 where it passes through any other part of the building; and
 - (ii) does not open into any other part of the building; or
- (c) water supply pipes for fire services.

C3.10 Openings in fire-isolated lift shafts

- (a) **Doorways** — If a lift *shaft* is *required* to be fire-isolated, an entrance doorway to that *shaft* must be protected by –/60/– fire doors that—
 - (i) comply with AS 1735.11; and
 - (ii) are set to remain closed except when discharging or receiving passengers, goods or vehicles.
- (b) **Lift indicator panels** — A lift call panel, indicator panel or other panel in the wall of a fire-isolated lift *shaft* must be backed by construction having an FRL of not less than –/60/60 if it exceeds 35 000 mm² in area.

C3.11 Bounding construction: Class 2, 3 and 4 buildings

- (a) A doorway in a Class 2 or 3 building must be protected if it provides access from a *sole-occupancy unit* to—
 - (i) a *public corridor*, public lobby, or the like; or

Deemed-to-Satisfy Provisions

- (ii) a room not within a *sole-occupancy unit*; or
 - (iii) the landing of an internal non *fire-isolated stairway* that serves as a *required exit*; or
 - (iv) another *sole-occupancy unit*.
- (b) A doorway in a Class 2 or 3 building must be protected if it provides access from a room not within a *sole-occupancy unit* to—
- (i) a *public corridor*, public lobby, or the like; or
 - (ii) the landing of an internal non *fire-isolated stairway* that serves as a *required exit*.
- (c) A doorway in a Class 4 part of a building must be protected if it provides access to any other internal part of the building.

NSW C3.11(d)

- (d) Protection for a doorway must be at least—
- (i) in a building of Type A construction — a *self-closing* –/60/30 fire door; and
 - (ii) in a building of Type B or C construction — a *self-closing*, tight fitting, solid core door, not less than 35 mm thick,
- except—
- (iii) in a Class 3 building used as a *residential aged care building* protected with a sprinkler system complying with **Specification E1.5**—
 - (A) a tight fitting, solid core door not less than 35 mm thick if the building is divided into *floor areas* not exceeding 500 m² with smoke proof walls complying with **Clause 2 of Specification C2.5**; or
 - (B) a tight fitting, solid core door not less than 35 mm thick fitted with a *self-closing* device, a delayed closing device or an *automatic* closing device.
- (e) Other openings in *internal walls* which are *required* to have an FRL with respect to *integrity* and *insulation* must not reduce the *fire-resisting* performance of the wall.
- (f)
- (i) A door *required* by (d) may be *automatic*-closing in accordance with (ii) and (iii).
 - (ii) The *automatic*-closing operation must be initiated by the activation of a smoke detector, or any other detector deemed suitable in accordance with AS 1670.1 if smoke detectors are unsuitable in the atmosphere, installed in accordance with the relevant provisions of AS 1670.1 and located not more than 1.5 m horizontal distance from the approach side of the doorway.
 - (iii) Where any other *required* suitable fire alarm system, including a sprinkler system complying with **Specification E1.5**, is installed in the building, activation of the system must also initiate the *automatic*-closing operation.
- (g) In a Class 2 or 3 building where a path of travel to an *exit* does not provide a person seeking egress with a choice of travel in different directions to alternative *exits* and is along an open balcony, landing or the like and passes an *external wall* of—
- (i) another *sole-occupancy unit*; or
 - (ii) a room not within a *sole-occupancy unit*,
- then that *external wall* must—

Deemed-to-Satisfy Provisions

- (iii) be constructed of concrete or masonry, or be lined internally with a *fire-protective covering*; and
- (iv) have any doorway fitted with a *self-closing*, tight-fitting solid core door not less than 35 mm thick; and
- (v) have any *windows* or other openings—
 - (A) protected internally in accordance with **C3.4**; or
 - (B) located at least 1.5 m above the floor of the balcony, landing or the like.

NSW C3.11(h)

C3.12 Openings in floors and ceilings for services

- (a) Where a service passes through—
 - (i) a floor that is *required* to have an FRL with respect to *integrity* and *insulation*; or
 - (ii) a ceiling *required* to have a *resistance to the incipient spread of fire*, the service must be installed in accordance with **(b)**.
- (b) A service must be protected—
 - (i) in a building of Type A construction, by a *shaft* complying with **Specification C1.1**; or
 - (ii) in a building of Type B or C construction, by a *shaft* that will not reduce the fire performance of the building elements it penetrates; or
 - (iii) in accordance with **C3.15**.
- (c) Where a service passes through a floor which is *required* to be protected by a *fire-protective covering*, the penetration must not reduce the fire performance of the covering.

C3.13 Openings in shafts

In a building of Type A construction, an opening in a wall providing access to a ventilating, pipe, garbage or other service *shaft* must be protected by—

- (a) if it is in a *sanitary compartment* — a door or panel which, together with its frame, is *non-combustible* or has an FRL of not less than –/30/30; or
- (b) a *self-closing* –/60/30 fire door or hopper; or
- (c) an access panel having an FRL of not less than –/60/30; or
- (d) if the *shaft* is a garbage *shaft* — a door or hopper of *non-combustible* construction.

C3.14 * * * * *

This clause has deliberately been left blank.

C3.15 Openings for service installations

Where an electrical, electronic, plumbing, mechanical ventilation, air-conditioning or other service penetrates a building element (other than an *external wall* or roof) that is *required* to

Deemed-to-Satisfy Provisions

have an FRL with respect to *integrity* or *insulation* or a *resistance to the incipient spread of fire*, that installation must comply with any one of the following:

(a) **Tested systems**

- (i) The service, building element and any protection method at the penetration are identical with a prototype assembly of the service, building element and protection method which has been tested in accordance with AS 4072.1 and AS 1530.4 and has achieved the *required* FRL or *resistance to the incipient spread of fire*.
- (ii) It complies with (i) except for the *insulation* criteria relating to the service if—
 - (A) the service is a pipe system comprised entirely of metal (excluding pipe seals or the like); and
 - (B) any *combustible* building element is not located within 100 mm of the service for a distance of 2 m from the penetration; and
 - (C) *combustible* material is not able to be located within 100 mm of the service for a distance of 2 m from the penetration; and
 - (D) it is not located in a *required exit*.

(b) **Ventilation and air-conditioning** — In the case of ventilating or air-conditioning ducts or equipment, the installation is in accordance with AS/NZS 1668.1.

(c) **Compliance with Specification C3.15**

- (i) The service is a pipe system comprised entirely of metal (excluding pipe seals or the like) and is installed in accordance with **Specification C3.15** and it—
 - (A) penetrates a wall, floor or ceiling, but not a ceiling *required* to have a *resistance to the incipient spread of fire*; and
 - (B) connects not more than 2 *fire compartments* in addition to any *fire-resisting* service *shafts*; and
 - (C) does not contain a flammable or combustible liquid or gas.
- (ii) The service is sanitary plumbing installed in accordance with **Specification C3.15** and it—
 - (A) is of metal or UPVC pipe; and
 - (B) penetrates the floors of a Class 5, 6, 7, 8 or 9b building; and
 - (C) is in a *sanitary compartment* separated from other parts of the building by walls with the FRL *required* by **Specification C1.1** for a stair *shaft* in the building and a *self-closing* –/60/30 fire door.
- (iii) The service is a wire or cable, or a cluster of wires or cables installed in accordance with **Specification C3.15** and it—
 - (A) penetrates a wall, floor or ceiling, but not a ceiling *required* to have a *resistance to the incipient spread of fire*; and
 - (B) connects not more than 2 *fire compartments* in addition to any *fire-resisting* service *shafts*.
- (iv) The service is an electrical switch, outlet, or the like, and it is installed in accordance with **Specification C3.15**.

Deemed-to-Satisfy Provisions

C3.16 Construction joints

Construction joints, spaces and the like in and between building elements *required* to be *fire-resisting* with respect to *integrity* and *insulation* must be protected in a manner identical with a prototype tested in accordance with AS 1530.4 to achieve the *required* FRL.

C3.17 Columns protected with lightweight construction to achieve an FRL

A column protected by *lightweight construction* to achieve an FRL which passes through a building element that is *required* to have an FRL or a *resistance to the incipient spread of fire*, must be installed using a method and materials identical with a prototype assembly of the construction which has achieved the *required* FRL or *resistance to the incipient spread of fire*.

SPECIFICATION **C1.1** FIRE-RESISTING CONSTRUCTION

Deemed-to-Satisfy Provisions

1. SCOPE

This Specification contains requirements for the *fire-resisting construction* of building elements.

2. GENERAL REQUIREMENTS

2.1 Exposure to fire-source features

- (a) A part of a building element is exposed to a *fire-source feature* if any of the horizontal straight lines between that part and the *fire-source feature*, or vertical projection of the feature, is not obstructed by another part of the building that—
 - (i) has an FRL of not less than 30/—/—; and
 - (ii) is neither transparent nor translucent.
- (b) A part of a building element is not exposed to a *fire-source feature* if the *fire-source feature* is—
 - (i) an *external wall* of another building that stands on the allotment and the part concerned is more than 15 m above the highest part of that *external wall*; or
 - (ii) a side or rear boundary of the allotment and the part concerned is below the level of the finished ground at every relevant part of the boundary concerned.
- (c) If various distances apply for different parts of a building element—
 - (i) the entire element must have the FRL applicable to that part having the least distance between itself and the relevant *fire-source feature*; or
 - (ii) each part of the element must have the FRL applicable according to its individual distance from the relevant *fire-source feature*,but this provision does not override or permit any exemption from **Clause 2.2**.

2.2 Fire protection for a support of another part

- (a) Where a part of a building *required* to have an FRL depends upon direct vertical or lateral support from another part to maintain its FRL, that supporting part, subject to **(b)**, must—
 - (i) have an FRL not less than that *required* by other provisions of this Specification; and
 - (ii) if located within the same *fire compartment* as the part it supports have an FRL in respect of *structural adequacy* the greater of that *required*—
 - (A) for the supporting part itself; and
 - (B) for the part it supports; and
 - (iii) be *non-combustible*—
 - (A) if *required* by other provisions of this Specification; or
 - (B) if the part it supports is *required* to be *non-combustible*.

Deemed-to-Satisfy Provisions

- (b) The following building elements need not comply with (a)(ii) and (a)(iii)(B):
- (i) An element providing lateral support to an *external wall* complying with **Clause 5.1(b)** or **C1.11**.
 - (ii) An element providing support within a *carpark* and complying with **Clause 3.9, 4.2** or **5.2**.
 - (iii) A roof providing lateral support in a building—
 - (A) of Type A construction if it complies with **Clause 3.5(a), (b)** or **(d)**; and
 - (B) of Type B and C construction.
 - (iv) A column providing lateral support to a wall where the column complies with **Clause 2.5(a)** and **(b)**.
 - (v) An element providing lateral support to a *fire wall* or *fire-resisting wall*, provided the wall is supported on both sides and failure of the element on one side does not affect the fire performance of the wall.

2.3 Lintels

A lintel must have the FRL *required* for the part of the building in which it is situated, unless it does not contribute to the support of a fire door, fire *window* or fire shutter, and—

- (a) it spans an opening in—
 - (i) a wall of a building containing only one *storey*; or
 - (ii) a non-*loadbearing* wall of a Class 2 or 3 building; or
- (b) it spans an opening in masonry which is not more than 150 mm thick and—
 - (i) not more than 3 m wide if the masonry is non-*loadbearing*; or
 - (ii) not more than 1.8 m wide if the masonry is *loadbearing* and part of a solid wall or one of the leaves of a cavity wall.

2.4 Attachments not to impair fire-resistance

- (a) A *combustible* material may be used as a finish or lining to a wall or roof, or in a sign, sunscreen or blind, awning, or other attachment to a building element which has the *required* FRL if—
 - (i) the material is exempted under **C1.10** or complies with the *fire hazard properties* prescribed in **Specification C1.10**; and
 - (ii) it is not located near or directly above a *required exit* so as to make the *exit* unusable in a fire; and
 - (iii) it does not otherwise constitute an undue risk of fire spread via the facade of the building.
- (b) The attachment of a facing or finish, or the installation of ducting or any other service, to a part of a building *required* to have an FRL must not impair the *required* FRL of that part.

2.5 General concessions

- (a) **Steel columns** — A steel column, other than one in a *fire wall* or *common wall*, need not have an FRL in a building that contains—

Deemed-to-Satisfy Provisions

- (i) only 1 *storey*; or
 - (ii) 2 *storeys* in some of its parts and 1 *storey* only in its remaining parts if the sum of the *floor areas* of the upper *storeys* of its 2 *storey* parts does not exceed the lesser of—
 - (A) 1/8 of the sum of the *floor areas* of the 1 *storey* parts; or
 - (B) in the case of a building to which one of the maximum *floor areas* specified in **Table C2.2** is applicable — 1/10 of that area; or
 - (C) in the case of a building to which two or more of the maximum *floor areas* specified in **Table C2.2** is applicable — 1/10 of the lesser of those areas.
- (b) **Timber columns** — A timber column may be used in a single *storey* building if—
- (i) in a *fire wall* or *common wall* the column has an FRL not less than that listed in the appropriate **Table 3, 4 or 5**; and
 - (ii) in any other case where the column is *required* to have an FRL in accordance with **Table 3, 4 or 5**, it has an FRL of not less than 30/–/–.
- (c) **Structures on roofs** — A *non-combustible* structure situated on a roof need not comply with the other provisions of this Specification if it only contains—
- (i) lift motor equipment; or
 - (ii) one or more of the following:
 - (A) Hot water or other water tanks.
 - (B) Ventilating ductwork, ventilating fans and their motors.
 - (C) Air-conditioning chillers.
 - (D) *Window* cleaning equipment.
 - (E) Other service units that are *non-combustible* and do not contain flammable or combustible liquids or gases.
- (d) **Curtain walls and panel walls** — A requirement for an *external wall* to have an FRL does not apply to a *curtain wall* or *panel wall* which is of *non-combustible* construction and fully protected by *automatic* external wall-wetting sprinklers.
- (e) * * * * *
- This clause has deliberately been left blank.
- (f) **Balconies and verandahs** — A balcony, verandah or the like and any incorporated supporting part, which is attached to or forms part of a building, need not comply with **Tables 3, 4 and 5** if—
- (i) it does not form part of the only path of travel to a *required exit* from the building; and
 - (ii) in Type A construction—
 - (A) it is situated not more than 2 *storeys* above the lowest *storey* providing direct egress to a road or *open space*; and
 - (B) any supporting columns are of *non-combustible* construction.

Deemed-to-Satisfy Provisions

2.6 Mezzanine floors: Concession

- (a) This Clause does not apply to a Class 9b building that is a spectator stand or audience viewing area accommodating more than 100 persons as calculated according to **D1.13**.
- (b) A *mezzanine* and its supports need not have an FRL or be *non-combustible* provided—
 - (i) the total *floor area* of all the *mezzanines* in the same room does not exceed 1/3 of the *floor area* of the room or 200 m², whichever is the lesser; and
 - (ii) the FRL of each wall and column that supports any other part of the building within 6 m of the *mezzanine* is increased by the amount listed in **Table 2.6**.

Table 2.6 INCREASED FRLs — CONSTRUCTION SURROUNDING MEZZANINES

| Level otherwise required for any FRL criterion (mins) | Increase in level to (not less than): |
|---|---------------------------------------|
| 30 | 60 |
| 60 | 90 |
| 90 | 120 |
| 120 | 180 |
| 180 | 240 |

Note: The increase in level applies to each FRL criterion (*structural adequacy*, *integrity* or *insulation*) relevant to the building element concerned.

2.7 Enclosure of shafts

Shafts required to have an FRL must be enclosed at the top and bottom by construction having an FRL not less than that *required* for the walls of a *non-loadbearing shaft* in the same building, except that these provisions need not apply to—

- (a) the top of a *shaft* extending beyond the roof covering, other than one enclosing a *fire-isolated stairway* or *ramp*; or
- (b) the bottom of a *shaft* if it is *non-combustible* and laid directly on the ground.

2.8 Carparks in Class 2 and 3 buildings

- (a) If a Class 2 building contains not more than 4 *storeys* of which—
 - (i) one *storey* is Class 7 used solely for the purpose of parking motor vehicles or for some other purpose that is ancillary to a Class 2; and
 - (ii) the remaining *storeys* are of Class 2,
 the *carpark storey* is regarded as Class 2 only for the purpose of determining the relevant *fire-resisting* requirements of this Specification.
- (b) If a Class 3 building or a building of Class 2 and 3 contains not more than 3 *storeys* of which—
 - (i) one *storey* is Class 7 used solely for the purpose of parking motor vehicles or for some other purpose that is ancillary to the other *storeys*; and
 - (ii) the remaining *storeys* are of Class 2 or 3,

Deemed-to-Satisfy Provisions

the *carpark storey* is regarded as Class 2 or 3 only for the purpose of determining the relevant *fire-resisting* requirements of this Specification.

2.9 Residential aged care building: Concession

In a Class 3 building protected with a sprinkler system complying with **Specification E1.5** and used as a *residential aged care building*, any FRL criterion prescribed in **Tables 3, 4** or **5**—

- (a) for any floor and any *loadbearing* wall, may be reduced to 60, except any FRL criterion of 90 for an *external wall* must be maintained when tested from the outside; and
- (b) for any non-*loadbearing internal wall*, need not apply if—
 - (i) it is lined on each side with standard grade plasterboard not less than 13 mm thick or similar *non-combustible* material; and
 - (ii) it extends—
 - (A) to the underside of the floor next above; or
 - (B) to the underside of a ceiling lined with standard grade plasterboard not less than 13 mm thick or a material with at least an equivalent level of fire protection; or
 - (C) to the underside of a *non-combustible* roof covering; and
 - (iii) any insulation installed in the cavity of the wall is *non-combustible*; and
 - (iv) any construction joint, space or the like between the top of the wall and the floor, ceiling or roof is smoke sealed with intumescent putty or other suitable material.

3. TYPE A FIRE-RESISTING CONSTRUCTION

3.1 Fire-resistance of building elements

In a building *required* to be of Type A construction—

- (a) each building element listed in **Table 3** and any beam or column incorporated in it, must have an FRL not less than that listed in the Table for the particular Class of building concerned; and
- (b) *external walls, common walls* and the flooring and floor framing of lift pits must be *non-combustible*; and
- (c) any *internal wall required* to have an FRL with respect to *integrity* and *insulation* must extend to—
 - (i) the underside of the floor next above; or
 - (ii) the underside of a roof complying with **Table 3**; or
 - (iii) if under **Clause 3.5** the roof is not *required* to comply with **Table 3**, the underside of the *non-combustible* roof covering and, except for roof battens with dimensions of 75 mm x 50 mm or less or *sarking-type material*, must not be crossed by timber or other *combustible* building elements; or
 - (iv) a ceiling that is immediately below the roof and has a *resistance to the incipient spread of fire* to the roof space between the ceiling and the roof of not less than 60 minutes; and

Deemed-to-Satisfy Provisions

- (d) a *loadbearing internal wall* and a *loadbearing fire wall* (including those that are part of a *loadbearing shaft*) must be of concrete or masonry; and
- (e) a non-*loadbearing*—
 - (i) *internal wall required* to be *fire-resisting*; and
 - (ii) lift, ventilating, pipe, garbage, or similar *shaft* that is not for the discharge of hot products of combustion, must be of *non-combustible* construction; and
- (f) the FRLs specified in **Table 3** for an external column apply also to those parts of an internal column that face and are within 1.5 m of a *window* and are exposed through that *window* to a *fire-source feature*.

Table 3 TYPE A CONSTRUCTION: FRL OF BUILDING ELEMENTS

| Building element | Class of building — FRL: (in minutes) | | | |
|---|---|-------------|-------------|-------------|
| | <i>Structural adequacy/Integrity/Insulation</i> | | | |
| | 2, 3 or 4 part | 5, 7a or 9 | 6 | 7b or 8 |
| EXTERNAL WALL (including any column and other building element incorporated therein) or other external building element, where the distance from any <i>fire-source feature</i> to which it is exposed is— | | | | |
| For <i>loadbearing</i> parts— | | | | |
| less than 1.5 m | 90/ 90/ 90 | 120/120/120 | 180/180/180 | 240/240/240 |
| 1.5 to less than 3 m | 90/ 60/ 60 | 120/ 90/ 90 | 180/180/120 | 240/240/180 |
| 3 m or more | 90/ 60/ 30 | 120/ 60/ 30 | 180/120/ 90 | 240/180/ 90 |
| For non- <i>loadbearing</i> parts— | | | | |
| less than 1.5 m | –/ 90/ 90 | –/120/120 | –/180/180 | –/240/240 |
| 1.5 to less than 3 m | –/ 60/ 60 | –/ 90/ 90 | –/180/120 | –/240/180 |
| 3 m or more | –/–/– | –/–/– | –/–/– | –/–/– |
| EXTERNAL COLUMN not incorporated in an <i>external wall</i> — | | | | |
| For <i>loadbearing</i> columns— | | | | |
| | 90/–/– | 120/–/– | 180/–/– | 240/–/– |
| For non- <i>loadbearing</i> columns— | | | | |
| | –/–/– | –/–/– | –/–/– | –/–/– |
| COMMON WALLS and FIRE WALLS— | 90/ 90/ 90 | 120/120/120 | 180/180/180 | 240/240/240 |

Deemed-to-Satisfy Provisions

Table 3 TYPE A CONSTRUCTION: FRL OF BUILDING ELEMENTS— continued

| Building element | Class of building — FRL: (in minutes) | | | |
|--|---|-------------|-------------|-------------|
| | <i>Structural adequacy/Integrity/Insulation</i> | | | |
| | 2, 3 or 4 part | 5, 7a or 9 | 6 | 7b or 8 |
| INTERNAL WALLS— | | | | |
| <i>Fire-resisting</i> lift and stair <i>shafts</i> — | | | | |
| <i>Loadbearing</i> | 90/ 90/ 90 | 120/120/120 | 180/120/120 | 240/120/120 |
| Non- <i>loadbearing</i> | –/ 90/ 90 | –/120/120 | –/120/120 | –/120/120 |
| Bounding <i>public corridors</i> , public lobbies and the like— | | | | |
| <i>Loadbearing</i> | 90/ 90/ 90 | 120/–/– | 180/–/– | 240/–/– |
| Non- <i>loadbearing</i> | –/ 60/ 60 | –/–/– | –/–/– | –/–/– |
| Between or bounding <i>sole-occupancy units</i> — | | | | |
| <i>Loadbearing</i> | 90/ 90/ 90 | 120/–/– | 180/–/– | 240/–/– |
| Non- <i>loadbearing</i> | –/ 60/ 60 | –/–/– | –/–/– | –/–/– |
| Ventilating, pipe, garbage, and like <i>shafts</i> not used for the discharge of hot products of combustion— | | | | |
| <i>Loadbearing</i> | 90/ 90/ 90 | 120/ 90/ 90 | 180/120/120 | 240/120/120 |
| Non- <i>loadbearing</i> | –/ 90/ 90 | –/ 90/ 90 | –/120/120 | –/120/120 |
| OTHER LOADBEARING INTERNAL WALLS, INTERNAL BEAMS, TRUSSES and COLUMNS— | | | | |
| | 90/–/– | 120/–/– | 180/–/– | 240/–/– |
| FLOORS | 90/ 90/ 90 | 120/120/120 | 180/180/180 | 240/240/240 |
| ROOFS | 90/ 60/ 30 | 120/ 60/ 30 | 180/ 60/ 30 | 240/ 90/ 60 |

3.2 Concessions for floors

A floor need not comply with **Table 3** if—

- (a) it is laid directly on the ground; or
- (b) in a Class 2, 3, 5 or 9 building, the space below is not a *storey*, does not accommodate motor vehicles, is not a storage or work area, and is not used for any other ancillary purpose; or
- (c) it is a timber *stage* floor in a Class 9b building laid over a floor having the *required* FRL and the space below the *stage* is not used as a dressing room, store room, or the like; or
- (d) it is within a *sole-occupancy unit* in a Class 2 or 3 building or Class 4 part of a building; or
- (e) it is an open-access floor (for the accommodation of electrical and electronic services and the like) above a floor with the *required* FRL.

3.3 Floor loading of Class 5 and 9b buildings: Concession

If a floor in a Class 5 or 9b building is designed for a live load not exceeding 3 kPa—

Deemed-to-Satisfy Provisions

- (a) the floor next above (including floor beams) may have an FRL of 90/90/90; or
- (b) the roof, if that is next above (including roof beams) may have an FRL of 90/60/30.

3.4 Roof superimposed on concrete slab: Concession

A roof superimposed on a concrete slab roof need not comply with **Clause 3.1** as to *fire-resisting construction* if—

- (a) the superimposed roof and any construction between it and the concrete slab roof are *non-combustible* throughout; and
- (b) the concrete slab roof complies with **Table 3**.

3.5 Roof: Concession

A roof need not comply with **Table 3** if its covering is *non-combustible* and the building—

- (a) has a sprinkler system complying with **Specification E1.5** installed throughout; or
- (b) has a *rise in storeys* of 3 or less; or
- (c) is of Class 2 or 3; or
- (d) has an *effective height* of not more than 25 m and the ceiling immediately below the roof has a *resistance to the incipient spread of fire* to the roof space of not less than 60 minutes.

3.6 Rooflights

If a roof is *required* to have an FRL or its covering is *required* to be *non-combustible*, rooflights or the like installed in that roof must—

- (a) have an aggregate area of not more than 20% of the roof surface; and
- (b) be not less than 3 m from—
 - (i) any boundary of the allotment other than the boundary with a road or public place; and
 - (ii) any part of the building which projects above the roof unless that part has the FRL *required* of a *fire wall* and any openings in that part of the wall for 6 m vertically above the rooflight or the like are protected in accordance with **C3.4**; and
 - (iii) any rooflight or the like in an adjoining *sole-occupancy unit* if the walls bounding the unit are *required* to have an FRL; and
 - (iv) any rooflight or the like in an adjoining fire-separated section of the building; and
- (c) if a ceiling with a *resistance to the incipient spread of fire* is *required*, be installed in a way that will maintain the level of protection provided by the ceiling to the roof space.

3.7 Internal columns and walls: Concession

For a building with an *effective height* of not more than 25 m and having a roof without an FRL in accordance with **Clause 3.5**, in the *storey* immediately below that roof, internal columns other than those referred to in **Clause 3.1(f)** and *internal walls* other than *fire walls* and *shaft walls* may have—

- (a) in a Class 2 or 3 building: FRL 60/60/60; or

Deemed-to-Satisfy Provisions

- (b) in a Class 5, 6, 7, 8 or 9 building—
 - (i) with *rise in storeys* exceeding 3: FRL 60/60/60
 - (ii) with *rise in storeys* not exceeding 3: no FRL.

3.8 Open spectator stands and indoor sports stadiums: Concession

In an *open spectator stand* or indoor sports stadium, the following building elements need not have the FRL specified in **Table 3**:

- (a) The roof if it is *non-combustible*.
- (b) Columns and *loadbearing* walls supporting only the roof if they are *non-combustible*.
- (c) Any non-*loadbearing* part of an *external wall* less than 3 m—
 - (i) from any *fire-source feature* to which it is exposed if it has an FRL of not less than –/60/60 and is *non-combustible*; or
 - (ii) from an *external wall* of another *open spectator stand* if it is *non-combustible*.

3.9 Carparks

- (a) Notwithstanding **Clause 3.1**, a *carpark* may comply with **Table 3.9** if it is an *open-deck carpark* or is protected with a sprinkler system complying with **Specification E1.5** and is—
 - (i) a separate building; or
 - (ii) a part of a building—
 - (A) which only occupies part of a *storey*, and is separated from the remaining part by a *fire wall*; or
 - (B) which is located above or below another classification, and the floor separating the classifications complies with **C2.9**; or
 - (C) which is located above another Class 7 part of the building not used for carparking, and the floor separating the parts complies with **Table 3** for a Class 7 part other than a *carpark*; or
 - (D) which is located below another Class 7 part of the building not used for carparking, and the floor separating the parts complies with **Table 3.9**.
- (b) For the purposes of this Clause, a *carpark*—
 - (i) includes—
 - (A) an administration area associated with the functioning of the *carpark*; and
 - (B) where the *carpark* is sprinklered, is associated with a Class 2 or 3 building and provides carparking for separate *sole-occupancy units*, each carparking area with an area not greater than 10% of its *floor area* for purposes ancillary to the *sole-occupancy units*; but
 - (ii) excludes—
 - (A) except for **(b)(i)**, any area of another classification, or other part of a Class 7 building not used for carparking; and

Deemed-to-Satisfy Provisions

- (B) a building or part of a building specifically intended for the parking of trucks, buses, vans and the like.

Table 3.9 REQUIREMENTS FOR CARPARKS

| Building element | FRL (not less than) <i>Structural adequacy/Integrity/Insulation</i> ESA/M (not greater than) |
|---|---|
| Wall | |
| (a) <i>external wall</i> | |
| (i) less than 3 m from a <i>fire-source feature</i> to which it is exposed: | |
| <i>Loadbearing</i> | 60/60/60 |
| <i>Non-loadbearing</i> | –/60/60 |
| (ii) 3 m or more from a <i>fire-source feature</i> to which it is exposed | –/–/– |
| (b) <i>internal wall</i> | |
| (i) <i>loadbearing</i> , other than one supporting only the roof (not used for carparking) | 60/–/– |
| (ii) supporting only the roof (not used for carparking) | –/–/– |
| (iii) <i>non-loadbearing</i> | –/–/– |
| (c) <i>fire wall</i> | |
| (i) from the direction used as a <i>carpark</i> | 60/60/60 |
| (ii) from the direction not used as a <i>carpark</i> | as <i>required</i> by Table 3 |
| Column | |
| (a) supporting only the roof (not used for carparking) and 3 m or more from a <i>fire-source feature</i> to which it is exposed | –/–/– |
| (b) steel column, other than one covered by (a) and one that does not support a part of a building that is not used as a <i>carpark</i> | 60/–/– or 26 m ² /tonne |
| (c) any other column not covered by (a) or (b) | 60/–/– |
| Beam | |
| (a) steel floor beam in continuous contact with a concrete floor slab | 60/–/– or 30 m ² /tonne |
| (b) any other beam | 60/–/– |

Deemed-to-Satisfy Provisions

Table 3.9 REQUIREMENTS FOR CARPARKS— continued

| Building element | FRL (not less than) <i>Structural adequacy/Integrity/Insulation</i> ESA/M (not greater than) |
|--|---|
| Fire-resisting lift and stair shaft (within the <i>carpark</i> only) | 60/60/60 |
| Floor slab and vehicle ramp | 60/60/60 |
| Roof (not used for carparking) | –/–/– |
| Notes: 1. ESA/M means the ratio of exposed surface area to mass per unit length. 2. Refer to Specification E1.5 for special requirements for a sprinkler system in a <i>carpark</i> complying with Table 3.9 and located within a multi-classified building. | |

3.10 Class 2 buildings: Concession

- (a) A Class 2 building having a *rise in storeys* of not more than 3 need not comply with **Clauses 3.1(b), (d) and (e)** of **Specification C1.1** and the requirement of **C2.6** for *non-combustible* material, if it is constructed using—
 - (i) timber framing throughout; or
 - (ii) *non-combustible* material throughout; or
 - (iii) a combination of (i) and (ii),
provided—
 - (iv) * * * * *
 - (v) any insulation installed in the cavity of a wall *required* to have an FRL is *non-combustible*; and
 - (vi) the building is fitted with an *automatic* smoke alarm system complying with **Specification E2.2a**.
- (b) A Class 2 building having a *rise in storeys* of not more than 4 may have the top three *storeys* constructed in accordance with (a) provided—
 - (i) the lowest *storey* is used solely for the purpose of parking motor vehicles or for some other ancillary purpose; and
 - (ii) the lowest *storey* is constructed of concrete or masonry including the floor between it and the Class 2 part of the building above; and
 - (iii) the lowest *storey* and the *storey* above are separated by construction having an FRL of not less than 90/90/90 with no openings or penetrations that would reduce the *fire-resisting* performance of that construction except that a doorway in that construction may be protected by a –/60/30 *self-closing* fire door.
- (c) In a Class 2 building complying with (a) or (b) and fitted with a sprinkler system complying with **Specification E1.5**, any FRL criterion prescribed in **Table 3**—
 - (i) for any floor and any *loadbearing* wall, may be reduced to 60, except any FRL criterion of 90 for an *external wall* must be maintained when tested from the outside; and

Deemed-to-Satisfy Provisions

- (ii) for any non-*loadbearing internal wall*, need not apply if—
 - (A) it is lined on each side with 13 mm standard grade plasterboard or similar *non-combustible* material; and
 - (B) it extends—
 - (aa) to the underside of the floor next above; or
 - (bb) to the underside of a ceiling with a *resistance to the incipient spread of fire* of 60 minutes; or
 - (cc) to the underside of a *non-combustible* roof covering; and
 - (C) any insulation installed in the cavity of the wall is *non-combustible*; and
 - (D) any construction joint, space or the like between the top of the wall and the floor, ceiling or roof is smoke sealed with intumescent putty or other suitable material; and
 - (E) any doorway in the wall is protected by a *self-closing*, tight fitting, solid core door not less than 35 mm thick.

4. TYPE B FIRE-RESISTING CONSTRUCTION

4.1 Fire-resistance of building elements

In a building *required* to be of Type B construction—

- (a) each building element listed in **Table 4**, and any beam or column incorporated in it, must have an FRL not less than that listed in the Table for the particular Class of building concerned; and
- (b) the *external walls*, *common walls*, and the flooring and floor framing in any lift pit, must be *non-combustible*; and
- (c) if a stair *shaft* supports any floor or a structural part of it—
 - (i) the floor or part must have an FRL of 60/—/— or more; or
 - (ii) the junction of the stair *shaft* must be constructed so that the floor or part will be free to sag or fall in a fire without causing structural damage to the *shaft*; and
- (d) any *internal wall* which is *required* to have an FRL with respect to *integrity* and *insulation*, except a wall that bounds a *sole-occupancy unit* in the topmost (or only) *storey* and there is only one unit in that *storey*, must extend to—
 - (i) the underside of the floor next above if that floor has an FRL of at least 30/30/30; or
 - (ii) the underside of a ceiling having a *resistance to the incipient spread of fire* to the space above itself of not less than 60 minutes; or
 - (iii) the underside of the roof covering if it is *non-combustible* and, except for roof battens with dimensions of 75 mm x 50 mm or less or *sarking-type material*, must not be crossed by timber or other *combustible* building elements; or
 - (iv) 450 mm above the roof covering if it is *combustible*; and
- (e) a *loadbearing internal wall* and a *loadbearing fire wall* (including those that are part of a *loadbearing shaft*) must be of concrete or masonry; and

Deemed-to-Satisfy Provisions

- (f) a non-*loadbearing internal wall required* to be *fire-resisting* must be of *non-combustible* construction; and
- (g) in a Class 5, 6, 7, 8 or 9 building, in the *storey* immediately below the roof, internal columns and *internal walls* other than *fire walls* and *shaft* walls, need not comply with **Table 4**; and
- (h) lift, subject to **C2.10**, ventilating, pipe, garbage, and similar *shafts* which are not for the discharge of hot products of combustion and not *loadbearing*, must be of *non-combustible* construction in—
 - (i) a Class 2, 3 or 9 building; and
 - (ii) a Class 5, 6, 7 or 8 building if the *shaft* connects more than 2 *storeys*; and
- (i) in a Class 2 or 3 building, except where within the one *sole-occupancy unit*, or a Class 9a *health-care building* or a Class 9b building, a floor separating *storeys* or above a space for the accommodation of motor vehicles or used for storage or any other ancillary purpose, must—
 - (i) be constructed so that it is at least of the standard achieved by a floor/ceiling system incorporating a ceiling which has a *resistance to the incipient spread of fire* to the space above itself of not less than 60 minutes; or
 - (ii) have an FRL of at least 30/30/30; or
 - (iii) have a *fire-protective covering* on the underside of the floor, including beams incorporated in it, if the floor is *combustible* or of metal; and
- (j) in a Class 9c *aged care building* a floor above a space for the accommodation of motor vehicles or used for storage or any other ancillary purpose, and any column supporting the floor must—
 - (i) be constructed so that it is at least of the standard achieved by a floor/ceiling system incorporating a ceiling which has a *resistance to the incipient spread of fire* to the space above itself of not less than 60 minutes; or
 - (ii) have an FRL of at least 30/30/30; or
 - (iii) have a *fire-protective covering* on the underside of the floor, including beams incorporated in it, if the floor is *combustible* or of metal.

Deemed-to-Satisfy Provisions

Table 4 TYPE B CONSTRUCTION: FRL OF BUILDING ELEMENTS

| Building element | Class of building—FRL: (in minutes) | | | |
|---|---|-------------|-------------|-------------|
| | <i>Structural adequacy/Integrity/Insulation</i> | | | |
| | 2, 3 or 4 part | 5, 7a or 9 | 6 | 7b or 8 |
| EXTERNAL WALL (including any column and other building element incorporated therein) or other external building element, where the distance from any <i>fire-source feature</i> to which it is exposed is— | | | | |
| For <i>loadbearing</i> parts— | | | | |
| less than 1.5 m | 90/ 90/ 90 | 120/120/120 | 180/180/180 | 240/240/240 |
| 1.5 to less than 3 m | 90/ 60/ 30 | 120/ 90/ 60 | 180/120/ 90 | 240/180/120 |
| 3 to less than 9 m | 90/ 30/ 30 | 120/ 30/ 30 | 180/ 90/ 60 | 240/ 90/ 60 |
| 9 to less than 18 m | 90/ 30/– | 120/ 30/– | 180/ 60/– | 240/ 60/– |
| 18 m or more | –/–/– | –/–/– | –/–/– | –/–/– |
| For non- <i>loadbearing</i> parts— | | | | |
| less than 1.5 m | –/ 90/ 90 | –/120/120 | –/180/180 | –/240/240 |
| 1.5 to less than 3 m | –/ 60/ 30 | –/ 90/ 60 | –/120/ 90 | –/180/120 |
| 3 m or more | –/–/– | –/–/– | –/–/– | –/–/– |
| EXTERNAL COLUMN not incorporated in an <i>external wall</i> — | | | | |
| For <i>loadbearing</i> columns— | | | | |
| | 90/–/– | 120/–/– | 180/–/– | 240/–/– |
| For non- <i>loadbearing</i> columns— | | | | |
| | –/–/– | –/–/– | –/–/– | –/–/– |
| COMMON WALLS and FIRE WALLS— | 90/ 90 / 90 | 120/120/120 | 180/180/180 | 240/240/240 |
| INTERNAL WALLS— | | | | |
| <i>Fire-resisting</i> lift and stair <i>shafts</i> — | | | | |
| <i>Loadbearing</i> | 90/ 90/ 90 | 120/120/120 | 180/120/120 | 240/120/120 |
| <i>Fire-resisting</i> stair <i>shafts</i> — | | | | |
| Non- <i>loadbearing</i> | –/ 90/ 90 | –/120/120 | –/120/120 | –/120/120 |
| Bounding <i>public corridors</i> , public lobbies and the like— | | | | |
| <i>Loadbearing</i> | 60/ 60/ 60 | 120/–/– | 180/–/– | 240/–/– |
| Non- <i>loadbearing</i> | –/ 60/ 60 | –/–/– | –/–/– | –/–/– |
| Between or bounding <i>sole-occupancy units</i> — | | | | |
| <i>Loadbearing</i> | 60/ 60/ 60 | 120/–/– | 180/–/– | 240/–/– |
| Non- <i>loadbearing</i> | –/ 60/ 60 | –/–/– | –/–/– | –/–/– |

Deemed-to-Satisfy Provisions

Table 4 TYPE B CONSTRUCTION: FRL OF BUILDING ELEMENTS— continued

| Building element | Class of building—FRL: (in minutes) | | | |
|---|---|------------|--------|---------|
| | <i>Structural adequacy/Integrity/Insulation</i> | | | |
| | 2, 3 or 4 part | 5, 7a or 9 | 6 | 7b or 8 |
| OTHER LOADBEARING INTERNAL WALLS | | | | |
| and COLUMNS— | 60/-- | 120/-- | 180/-- | 240/-- |
| ROOFS | --/-- | --/-- | --/-- | --/-- |

4.2 Carparks

- (a) Notwithstanding **Clause 4.1**, a *carpark* may comply with **Table 4.2** if it is an *open-deck carpark* or is protected with a sprinkler system complying with **Specification E1.5** and is—
- (i) a separate building; or
 - (ii) a part of a building, and if occupying only part of a *storey*, is separated from the remaining part by a *fire wall*.
- (b) For the purposes of this Clause, a *carpark*—
- (i) includes—
 - (A) an administration area associated with the functioning of the *carpark*; and
 - (B) where the *carpark* is sprinklered, is associated with a Class 2 or 3 building and provides carparking for separate *sole-occupancy units*, each carparking area with an area not greater than 10% of its *floor area* for purposes ancillary to the *sole-occupancy units*; but
 - (ii) excludes—
 - (A) except for **(b)(i)**, any area of another classification, or other part of a Class 7 building not used for carparking; and
 - (B) a building or part of a building specifically intended for the parking of trucks, buses, vans and the like.

Deemed-to-Satisfy Provisions

Table 4.2 REQUIREMENTS FOR CARPARKS

| Building element | FRL (not less than) <i>Structural adequacy/Integrity/Insulation</i> ESA/M (not greater than) |
|---|--|
| Wall | |
| (a) <i>external wall</i> | |
| (i) less than 3 m from a <i>fire-source feature</i> to which it is exposed: | |
| <i>Loadbearing</i> | 60/60/60 |
| <i>Non-loadbearing</i> | –/60/60 |
| (ii) 3 m or more from a <i>fire-source feature</i> to which it is exposed | –/–/– |
| (b) <i>internal wall</i> | |
| (i) <i>loadbearing</i> , other than one supporting only the roof (not used for carparking) | 60/–/– |
| (ii) supporting only the roof (not used for carparking) | –/–/– |
| (iii) <i>non-loadbearing</i> | –/–/– |
| (c) <i>fire wall</i> | |
| (i) from the direction used as a <i>carpark</i> | 60/60/60 |
| (ii) from the direction not used as a <i>carpark</i> | as <i>required</i> by Table 4 |
| Column | |
| (a) supporting only the roof (not used for carparking) and 3 m or more from a <i>fire-source feature</i> to which it is exposed | –/–/– |
| (b) steel column, other than one covered by (a) | 60/–/– or 26 m ² /tonne |
| (c) any other column not covered by (a) or (b) | 60/–/– |
| Beam | |
| (a) less than 3 m from a <i>fire-source feature</i> : | |
| (i) steel floor beam in continuous contact with a concrete floor slab | 60/–/– or 30 m ² /tonne |
| (ii) any other beam | 60/–/– |
| (b) 3 m or more from a <i>fire-source feature</i> | –/–/– |
| Lift shaft | –/–/– |
| Fire-resisting stair shaft (within the <i>carpark</i> only) | 60/60/60 |
| Roof, floor slab and vehicle ramp | –/–/– |
| Note: ESA/M means the ratio of exposed surface area to mass per unit length. | |

Deemed-to-Satisfy Provisions

4.3 Class 2 buildings: Concession

- (a) A Class 2 building having a *rise in storeys* of not more than 2 need not comply with **Clause 4.1(b), (e), (f) and (h)** of **Specification C1.1** if it is constructed using—
 - (i) timber framing throughout; or
 - (ii) *non-combustible* material throughout; or
 - (iii) a combination of **(i)** and **(ii)**,
provided—
 - (iv) * * * * *
 - (v) any insulation installed in the cavity of a wall *required* to have an FRL is *non-combustible*; and
 - (vi) the building is fitted with an *automatic* smoke alarm system complying with **Specification E2.2a**.

- (b) A Class 2 building having a *rise in storeys* of not more than 2 may have the top *storey* constructed in accordance with **(a)** provided—
 - (i) the lowest *storey* is used solely for the purpose of parking motor vehicles or for some other ancillary purpose; and
 - (ii) the lowest *storey* is constructed of concrete or masonry including the floor between it and the Class 2 part of the building above; and
 - (iii) the lowest *storey* and the *storey* above are separated by construction having an FRL of not less than 90/90/90 with no openings or penetrations that would reduce the *fire-resisting* performance of that construction except that a doorway in that construction may be protected by a –/60/30 *self-closing* fire door.

- (c) In a Class 2 building complying with **(a)** or **(b)** and fitted with a sprinkler system complying with **Specification E1.5**, any FRL criterion prescribed in **Table 4**—
 - (i) for any *loadbearing* wall, may be reduced to 60, except any FRL criterion of 90 for an *external wall* must be maintained when tested from the outside; and
 - (ii) for any non-*loadbearing internal wall*, need not apply, if—
 - (A) it is lined on both sides with 13 mm standard grade plasterboard or similar *non-combustible* material; and
 - (B) it extends—
 - (aa) to the underside of the floor next above if that floor has an FRL of at least 30/30/30 or is lined on the underside with a *fire-protective covering*; or
 - (bb) to the underside of a ceiling with a *resistance to the incipient spread of fire* of 60 minutes; or
 - (cc) to the underside of a *non-combustible* roof covering; and
 - (C) any insulation installed in the cavity of the wall is *non-combustible*; and

Deemed-to-Satisfy Provisions

- (D) any construction joints, spaces and the like between the top of the wall and the floor, ceiling or roof is smoke sealed with intumescent putty or other suitable material.

5. TYPE C FIRE-RESISTING CONSTRUCTION

5.1 Fire-resistance of building elements

In a building *required* to be of Type C construction—

- (a) a building element listed in **Table 5** and any beam or column incorporated in it, must have an FRL not less than that listed in the Table for the particular Class of building concerned; and
- (b) an *external wall* that is *required* by **Table 5** to have an FRL need only be tested from the outside to satisfy the requirement; and
- (c) a *fire wall* or an *internal wall* bounding a *sole-occupancy unit* or separating adjoining units must comply with **Specification C1.8** if it is of *lightweight construction* and is *required* to have an FRL; and
- (d) in a Class 2 or 3 building, an *internal wall* which is *required* by **Table 5** to have an FRL must extend—
 - (i) to the underside of the floor next above if that floor has an FRL of at least 30/30/30 or a *fire-protective covering* on the underside of the floor; or
 - (ii) to the underside of a ceiling having a *resistance to the incipient spread of fire* to the space above itself of not less than 60 minutes; or
 - (iii) to the underside of the roof covering if it is *non-combustible*, and except for roof battens with dimensions of 75 mm x 50 mm or less or *sarking-type material*, must not be crossed by timber or other *combustible* building elements; or
 - (iv) 450 mm above the roof covering if it is *combustible*; and
- (e) in a Class 2 or 3 building, except where within the one *sole-occupancy unit*, or a Class 9a *health-care building*, or a Class 9b building, a floor separating *storeys*, or above a space for the accommodation of motor vehicles or used for storage or any other ancillary purpose, and any column supporting the floor, must—
 - (i) have an FRL of at least 30/30/30; or
 - (ii) have a *fire-protective covering* on the underside of the floor including beams incorporated in it and around the column, if the floor or column is *combustible* or of metal; and
- (f) in a Class 9c *aged care building* a floor above a space for the accommodation of motor vehicles or used for storage or any other ancillary purpose, and any column supporting the floor, must—
 - (i) have an FRL of at least 30/30/30; or
 - (ii) have a *fire-protective covering* on the underside of the floor including beams incorporated in it and around the column, if the floor or column is *combustible* or of metal.

Deemed-to-Satisfy Provisions

Table 5 TYPE C CONSTRUCTION: FRL OF BUILDING ELEMENTS

| Building element | Class of building—FRL: (in minutes) | | | |
|---|---|------------|------------|------------|
| | <i>Structural adequacy/Integrity/Insulation</i> | | | |
| | 2, 3 or 4 part | 5, 7a or 9 | 6 | 7b or 8 |
| EXTERNAL WALL (including any column and other building element incorporated therein) or other external building element, where the distance from any <i>fire-source feature</i> to which it is exposed is— | | | | |
| Less than 1.5 m | 90/ 90/ 90 | 90/ 90/ 90 | 90/ 90/ 90 | 90/ 90/ 90 |
| 1.5 to less than 3 m | —/—/— | 60/ 60/ 60 | 60/ 60/ 60 | 60/ 60/ 60 |
| 3 m or more | —/—/— | —/—/— | —/—/— | —/—/— |
| EXTERNAL COLUMN not incorporated in an <i>external wall</i> , where the distance from any <i>fire-source feature</i> to which it is exposed is— | | | | |
| Less than 1.5 m | 90/—/— | 90/—/— | 90/—/— | 90/—/— |
| 1.5 to less than 3 m | —/—/— | 60/—/— | 60/—/— | 60/—/— |
| 3 m or more | —/—/— | —/—/— | —/—/— | —/—/— |
| COMMON WALLS and FIRE WALLS— | 90/ 90/ 90 | 90/ 90/ 90 | 90/ 90/ 90 | 90/ 90/ 90 |
| INTERNAL WALLS— | | | | |
| Bounding <i>public corridors</i> , public lobbies and the like— | 60/ 60/ 60 | —/—/— | —/—/— | —/—/— |
| Between or bounding <i>sole-occupancy units</i> — | 60/ 60/ 60 | —/—/— | —/—/— | —/—/— |
| Bounding a stair if <i>required</i> to be rated— | 60/ 60/ 60 | 60/ 60/ 60 | 60/ 60/ 60 | 60/ 60/ 60 |
| ROOFS | —/—/— | —/—/— | —/—/— | —/—/— |

5.2 Carparks

- (a) Notwithstanding **Clause 5.1**, a *carpark* may comply with **Table 5.2** if it is an *open-deck carpark* or is protected with a sprinkler system complying with **Specification E1.5** and is—
 - (i) a separate building; or
 - (ii) a part of a building, and if occupying only part of a *storey*, is separated from the remaining part by a *fire wall*.
- (b) For the purposes of this Clause, a *carpark*—
 - (i) includes—
 - (A) an administration area associated with the functioning of the *carpark*; and
 - (B) where the *carpark* is sprinklered, is associated with a Class 2 or 3 building and provides carparking for separate *sole-occupancy units*,

Deemed-to-Satisfy Provisions

each carparking area with an area not greater than 10% of its *floor area* for purposes ancillary to the *sole-occupancy units*; but

- (ii) excludes—
 - (A) except for **(b)(i)**, any area of another classification, or other part of a Class 7 building not used for carparking; and
 - (B) a building or part of a building specifically intended for the parking of trucks, buses, vans and the like.

Table 5.2 REQUIREMENTS FOR CARPARKS

| Building element | FRL (not less than) <i>Structural adequacy/Integrity/Insulation</i> ESA/M (not greater than) |
|---|--|
| Wall | |
| (a) <i>external wall</i> | |
| (i) less than 1.5 m from a <i>fire-source feature</i> to which it is exposed: | |
| <i>Loadbearing</i> | 60/60/60 |
| <i>Non-loadbearing</i> | –/60/60 |
| (ii) 1.5 m or more from a <i>fire-source feature</i> to which it is exposed | –/–/– |
| (b) <i>internal wall</i> | –/–/– |
| (c) <i>fire wall</i> | |
| (i) from the direction used as a <i>carpark</i> | 60/60/60 |
| (ii) from the direction not used as a <i>carpark</i> | 90/90/90 |
| Column | |
| (a) steel column less than 1.5 m from a <i>fire-source feature</i> | 60/–/– or 26 m ² /tonne |
| (b) any other column less than 1.5 m from a <i>fire-source feature</i> | 60/–/– |
| (c) any other column not covered by (a) or (b) | –/–/– |
| Beam | |
| (a) less than 1.5 m from a <i>fire-source feature</i> | |
| (i) steel floor beam in continuous contact with a concrete floor slab | 60/–/– or 30 m ² /tonne |
| (ii) any other beam | 60/–/– |
| (b) 1.5 m or more from a <i>fire-source feature</i> | –/–/– |
| Roof, floor slab and vehicle ramp | |
| | –/–/– |

Note: ESA/M means the ratio of exposed surface area to mass per unit length.

SPECIFICATION **C1.8** STRUCTURAL TESTS FOR LIGHTWEIGHT CONSTRUCTION

Deemed-to-Satisfy Provisions

1. **Scope**

This Specification describes tests to be applied to and criteria to be satisfied by a wall system of *lightweight construction*.

2. **Application**

A wall system need not be tested in accordance with this Specification for static pressure or impact if it is designed and constructed in accordance with the *Deemed-to-Satisfy Provisions* of **Section B** to resist the appropriate pressures and impacts defined in this Specification.

3. **Tests**

3.1 **Walls of certain Class 9b buildings**

Lightweight construction forming—

- (a) a wall of a lift *shaft* and stair *shaft*; and
- (b) an *external* and *internal wall* bounding a *public corridor*, public lobby or the like, including a *fire-isolated* and non *fire-isolated passageway* or *ramp*, in a spectator stand, sports stadium, cinema or theatre, railway or bus station or airport terminal, must be subjected to the following tests and must fulfil the following criteria:
 - (i) The materials tests of **Clause 5(a)** and the criteria of **Clause 6(a)**.
 - (ii) A static test by the imposition of a uniformly distributed load of 1.0 kPa (or its equivalent) in accordance with **Clause 5(b)** and the damage and deflection criteria of **Clauses 6(b)** and **(c)** respectively.
 - (iii) A dynamic test by the fall of the impact bag through a height of 350 mm in accordance with **Clause 5(c)** and the damage and deflection criteria of **Clauses 6(b)** and **(d)** respectively.
 - (iv) The surface indentation test of **Clause 5(d)** and the surface indentation criterion of **Clause 6(e)**.

3.2 **Walls of shafts and fire-isolated exits generally**

A wall of *lightweight construction* that is *required* to be *fire-resisting* and which bounds a lift *shaft*, stair *shaft*, or service *shaft*, *fire-isolated passageway* or *fire-isolated ramp* must be subjected to the following tests and must fulfil the following criteria:

- (a) The materials tests of **Clause 5(a)** and the criteria of **Clause 6(a)**.
- (b) A static test by the imposition of a uniformly distributed load of 0.35 kPa (or its equivalent) in accordance with **Clause 5(b)** and the damage and deflection criteria of **Clauses 6(b)** and **(c)** respectively.

Deemed-to-Satisfy Provisions

- (c) A dynamic test by the fall of the impact bag through a height of 150 mm in accordance with **Clause 5(c)** and the damage and deflection criteria of **Clauses 6(b)** and **(d)** respectively.
- (d) The surface indentation test of **Clause 5(d)** and the surface indentation criterion of **Clause 6(e)**.

3.3 Additional requirements for lift shafts

- (a) In addition to the requirements of **Clauses 3.1** and **3.2**, a wall system for use in a lift *shaft* that is *required* to be *fire-resisting* must be subjected to dynamic test by the imposition of—
 - (i) where the lift car speed is 7 m/s or less — 10⁶ cycles of a uniformly distributed load between 0 and 0.2 kPa (or its equivalent); or
 - (ii) where the lift car speed is greater than 7 m/s — 10⁶ cycles of a uniformly distributed load between 0 and 0.35 kPa (or its equivalent) in accordance with **Clause 5(e)** and must fulfil the damage criteria of **Clause 6(b)**.
- (b) The wall system must be subjected to the static test in accordance with **Clause 3.2(b)** after the successful conclusion of the dynamic test specified in **(a)**.

3.4 Walls generally

An *external* and *internal wall* of *lightweight construction* that is *required* to be *fire-resisting*, other than one covered by **Clauses 3.1**, **3.2** or **3.3**, must be subjected to the following tests and must fulfil the following criteria:

- (a) The materials tests of **Clause 5(a)** and the criteria of **Clause 6(a)**.
- (b) A static test by the imposition of a uniformly distributed load of 0.25 kPa (or its equivalent) in accordance with **Clause 5(b)** and the damage and deflection criteria of **Clauses 6(b)** and **(c)** respectively.
- (c) A dynamic test by fall of the impact bag through a height of 100 mm in accordance with **Clause 5(c)** and the damage and deflection criteria of **Clauses 6(b)** and **(d)** respectively.
- (d) The surface indentation test of **Clause 5(d)** and the surface indentation criterion of **Clause 6(e)**.

4. Test specimens

4.1 General

Testing must be carried out on either—

- (a) construction in-situ; or
- (b) a laboratory specimen of the construction.

4.2 Testing in-situ

If testing is carried out in-situ, it must be done on that part of the construction least likely, because of the particular combination of the height of the walls, the support conditions and other aspects of the construction, to resist the loads.

Deemed-to-Satisfy Provisions

4.3 Testing of specimens

If a laboratory specimen is tested, the specimen must span only in the direction corresponding to the height of the wall and testing must be done in accordance with either (a) or (b) below:

- (a)
 - (i) The height of the test specimen (or length, if the specimen is tested horizontally) must be identical with the height between supports in the actual construction; and
 - (ii) the specimen must be supported at the top and bottom (or at each end if tested horizontally) by components identical with, and in a manner identical with, the actual construction.
- (b) If the distance between supports of the actual construction is more than 3 m, then a smaller specimen may be tested but—
 - (i) the distance between supports must be not less than 3 m; and
 - (ii) forces, reactions and support conditions must be modelled so as to reproduce the behaviour of the actual construction if it were tested in-situ.

5. Test methods

Tests must be carried out in accordance with the following:

- (a) **Material tests** — The methods specified for the constituent materials of the construction of the standards adopted by reference in the BCA.
- (b) **For resistance to static pressure** — The provisions for testing walls under transverse load in ASTM E72-80, except that—
 - (i) support conditions must be as specified in **Clause 4.3**; and
 - (ii) equivalent load shall mean the quarter-point load that produces the same deflection or central moment as appropriate.
- (c) **For resistance to impact** — The provisions for testing wall systems in ASTM E695-79, except that—
 - (i) the point of impact must be set 1.5 m above finished floor level or 1.5 m above the part of the specimen that corresponds to finished floor level; and
 - (ii) the impact bag must be not less than 225 mm in diameter and not more than 260 mm in diameter and have a mass of not less than 27.2 or more than 27.3 kg; and
 - (iii) the mass must be achieved by putting loose, dry sand into the bag and must be adjusted before each series of impact tests; and
 - (iv) where the impact bag and suspension cannot be vertical at the instant of impact on a curved surface or an inclined surface, the height of drop is the net height at the point of impact.
- (d) **For resistance to surface indentation** — The test for resistance to surface indentation must be carried out at three points on the surface of an undamaged sample sheet as follows:

Deemed-to-Satisfy Provisions

- (i) A steel ball of 10 mm diameter with a load of 150 N must be placed gently on the surface of the sheet and allowed to remain in position for 5 minutes.
 - (ii) The ball and load must then be removed and the diameter of each impression of the ball on the surface measured.
- (e) **For resistance of lift shaft construction to repetitive load** — As for 5(b) except that—
- (i) it is sufficient to test one specimen with the pressure applied from the side of the construction on which the lift will operate; and
 - (ii) the load must be applied dynamically at a frequency not less than 1 Hz and not more than 3 Hz; and
 - (iii) equivalent load shall mean the quarter-point load that produces the same central moment as the distributed load.

6. Criteria for compliance

The wall system or the specimen of it must fulfil the following criteria:

- (a) **Materials** — Materials must comply with the applicable standard adopted by reference in the BCA.
- (b) **Damage** — There must be no crack, penetration or permanent surface-deformation to a depth of more than 0.5 mm or any other non-elastic deformation or fastener failure.
- (c) **Deflection — Static pressure** — Under static pressure the deflection must not be more than—
 - (i) 1/240th of the height between supports; or
 - (ii) for construction other than a lift *shaft* — 30 mm; or
 - (iii) for a lift *shaft* — 20 mm.
- (d) **Deflection — Impact** — Under impact the instantaneous deflection must not be more than—
 - (i) 1/120th of the height of the wall between supports; or
 - (ii) for construction other than a lift *shaft* — 30 mm; or
 - (iii) for a lift *shaft* — 20 mm.
- (e) **Surface indentation** — No impression must be more than 5 mm in diameter.

SPECIFICATION C1.10 FIRE HAZARD PROPERTIES

Deemed-to-Satisfy Provisions

1. Scope

This Specification sets out requirements in relation to the *fire hazard properties* of linings, materials and assemblies in Class 2 to 9 buildings as set out in **Table 1**.

2. Application

Linings, materials and assemblies in Class 2 to 9 buildings must comply with the appropriate provisions described in **Table 1**.

Table 1 FIRE HAZARD PROPERTY REQUIREMENTS

| Lining, material or assembly | Requirement |
|---|-----------------|
| Floor linings and floor coverings. | Clause 3 |
| Wall linings and ceiling linings. | Clause 4 |
| Air-handling ductwork. | Clause 5 |
| Lift cars. | Clause 6 |
| In fire control rooms subject to Specification E1.8 and fire isolated <i>exits</i> | Clause 7 |
| In Class 9b buildings used as a theatre, public hall or the like— (a) fixed seating in the audience area or auditorium; and (b) a proscenium curtain <i>required</i> by Specification H1.3 . | |
| Escalators, moving walkways and non- <i>required</i> non- <i>fire-isolated stairways</i> or pedestrian ramps subject to Specification D1.12 . | |
| <i>Sarking-type material</i> . | |
| Attachments to internal floors, walls and ceilings. | |
| Other materials including Insulation. | |

3. Floor linings and floor coverings

A floor lining or floor covering must have—

- (a) a *critical radiant flux* not less than that listed in **Table 2**; and
- (b) in a building not protected by a sprinkler system complying with **Specification E1.5**, a maximum *smoke development rate* of 750 percent-minutes; and
- (c) a group number complying with **Clause 6(a)(ii)**, for any portion of the floor covering that is continued more than 150 mm up a wall.

Deemed-to-Satisfy Provisions

Table 2 CRITICAL RADIANT FLUX (CRF in kW/m²) OF FLOOR MATERIALS AND FLOOR COVERINGS

| Class of building | General | | Fire-isolated exits and fire control rooms |
|---|---|---|--|
| | Building not fitted with a sprinkler system complying with Specification E1.5 | Building fitted with a sprinkler system complying with Specification E1.5 | |
| Class 2, 3, 5, 6, 7, 8 or 9b, excluding— (i) Class 3 accommodation for the aged; and (ii) Class 9b as specified below. | 2.2 | 1.2 | 2.2 |
| Class 3 Accommodation for the aged. | 4.5 | 2.2 | 4.5 |
| Class 9a <i>Patient care areas.</i> | 4.5 | 2.2 | 4.5 |
| Areas other than <i>patient care areas.</i> | 2.2 | 1.2 | 4.5 |
| Class 9b auditorium or audience seating area used mainly for— (i) indoor swimming or ice skating; and (ii) other sports or multi-purpose functions. | 1.2 2.2 | 1.2 1.2 | 2.2 2.2 |
| Class 9c <i>Resident use areas.</i> | — | 2.2 | 4.5 |
| Areas other than <i>resident use areas.</i> | — | 1.2 | 4.5 |

4. Wall and ceiling linings

- (a) For the purposes of this Clause, the *group number* of a material is determined by either—
- (i) physical testing in accordance with AS ISO 9705; or
 - (ii) prediction in accordance with **Clause 3 of Specification A2.4** using data obtained by testing the material at 50 kW/m² irradiance in the horizontal orientation with edge frame in accordance with AS/NZS 3837.
- (b) The *group number* of a material is as follows when tested or predicted in accordance with sub-clause (a):
- (i) A Group 1 material is one that does not reach *flashover* when exposed to 100 kW for 600 seconds followed by exposure to 300 kW for 600 seconds.

Deemed-to-Satisfy Provisions

- (ii) A Group 2 material is one that reaches *flashover* following exposure to 300 kW within 600 seconds after not reaching *flashover* when exposed to 100 kW for 600 seconds.
 - (iii) A Group 3 material is one that reaches *flashover* in more than 120 seconds but within 600 seconds when exposed to 100 kW.
 - (iv) A Group 4 material is one that reaches *flashover* within 120 seconds when exposed to 100 kW.
- (c) A material used as a finish, surface, lining or attachment to a wall or ceiling must be a Group 1, Group 2 or Group 3 material used in accordance with **Table 3** and for buildings not fitted with a sprinkler system complying with **Specification E1.5**, have—
- (i) a *smoke growth rate index* not more than 100; or
 - (ii) an *average specific extinction area* less than 250 m²/kg.

Table 3 WALL AND CEILING LINING MATERIALS (Material Groups permitted)

| Class of building | Fire-isolated exits and fire control rooms Wall/ceiling | Public corridors | | Specific areas | | Other areas |
|---|--|------------------|---------|----------------|---------|--------------|
| | | Wall | Ceiling | Wall | Ceiling | Wall/ceiling |
| Class 2 or 3 | | | | | | |
| Excluding accommodation for the aged, people with disabilities, and children | | | | | | |
| Unsprinklered | 1 | 1, 2 | 1, 2 | 1, 2, 3 | 1, 2, 3 | 1, 2, 3 |
| Sprinklered | 1 | 1, 2, 3 | 1, 2, 3 | 1, 2, 3 | 1, 2, 3 | 1, 2, 3 |
| Class 3 or 9a | | | | | | |
| Accommodation for the aged, people with disabilities, children and <i>health-care buildings</i> | | | | | | |
| Unsprinklered | 1 | 1 | 1 | 1, 2 | 1, 2 | 1, 2, 3 |
| Sprinklered | 1 | 1, 2 | 1, 2 | 1, 2, 3 | 1, 2, 3 | 1, 2, 3 |
| Class 5, 6, 7, 8 or 9b <i>schools</i> | | | | | | |
| Unsprinklered | 1 | 1, 2 | 1, 2 | 1, 2, 3 | 1, 2 | 1, 2, 3 |
| Sprinklered | 1 | 1, 2, 3 | 1, 2, 3 | 1, 2, 3 | 1, 2, 3 | 1, 2, 3 |
| Class 9b other than <i>schools</i> | | | | | | |
| Unsprinklered | 1 | 1 | 1 | 1, 2 | 1, 2 | 1, 2, 3 |
| Sprinklered | 1 | 1, 2 | 1, 2 | 1, 2, 3 | 1, 2, 3 | 1, 2, 3 |
| Class 9c | | | | | | |
| Sprinklered | 1 | 1, 2 | 1, 2 | 1, 2, 3 | 1, 2, 3 | 1, 2, 3 |
| For the purpose of this Table— | | | | | | |
| 1. "Sprinklered" means a building fitted with a sprinkler system complying with Specification E1.5 . | | | | | | |
| 2. "Specific areas" means within— | | | | | | |
| (a) for Class 2 and 3 buildings, a <i>sole-occupancy unit</i> ; and | | | | | | |

Deemed-to-Satisfy Provisions

Table 3 WALL AND CEILING LINING MATERIALS (Material Groups permitted)— continued

| Class of building | Fire-isolated exits and fire control rooms | Public corridors | | Specific areas | | Other areas |
|-------------------|--|------------------|---------|----------------|---------|--------------|
| | | Wall | Ceiling | Wall | Ceiling | Wall/ceiling |
| (b) | for Class 5 buildings, open plan offices with a minimum floor dimension/floor to ceiling height ratio > 5; and | | | | | |
| (c) | for Class 6 buildings, shops or other building with a minimum floor dimension/floor to ceiling height ratio > 5; and | | | | | |
| (d) | for Class 9a <i>health-care buildings, patient care areas</i> ; and | | | | | |
| (e) | for Class 9b theatres and halls, etc, an auditorium; and | | | | | |
| (f) | for Class 9b <i>schools</i> , a classroom; and | | | | | |
| (g) | for Class 9c <i>aged care buildings, resident use areas</i> . | | | | | |

5. Air-handling ductwork

Rigid and flexible ductwork in a Class 2 to 9 building must comply with the *fire hazard properties* set out in AS 4254 Parts 1 and 2.

6. Lift cars

Materials used as—

- (a) floor linings and floor coverings must have a *critical radiant flux* not less than 2.2; and
- (b) wall and ceiling linings must be a Group 1 material or a Group 2 material in accordance with **Clause 4(b)**.

7. Other materials

NSW Spec C1.10 NSW 7

Materials and assemblies in a Class 2 to 9 building not included in **Clauses 3, 4, 5** or **6** must not exceed the indices set out in **Table 4**.

Table 4 OTHER MATERIALS

| Material or assembly location | Flammability Index | Spread-of-Flame Index | Smoke-Developed Index |
|---|--------------------|-----------------------|-----------------------|
| Fire control rooms subject to Specification E1.8 and fire-isolated <i>exits</i> , other than a <i>sarking-type material</i> used in a ceiling or used as an attachment or part of an attachment to a building element. <small>Note 1</small> | — | 0 | 2 |
| Class 9b buildings used as a theatre, public hall or the like: | | | |
| (a) Any part of fixed seating in the audience area or auditorium. | — | 0 | 5 |

Deemed-to-Satisfy Provisions

Table 4 OTHER MATERIALS— continued

| Material or assembly location | Flammability Index | Spread-of-Flame Index | Smoke-Developed Index |
|---|--------------------|-----------------------|--|
| (b) A proscenium curtain <i>required</i> by Specification H1.3 . | — | 0 | 3 |
| Escalators, moving walkways or non- <i>required</i> non- <i>fire-isolated stairways</i> or pedestrian ramps subject to Specification D1.12 . | — | 0 | 5 |
| <i>Sarking-type material:</i> | | | |
| (a) In a fire control room subject to Specification E1.8 or a fire-isolated <i>exit</i> or fire control room used in the form of an exposed wall or ceiling. | 0 | — | — |
| (b) In other locations. ^{Note 2} | 5 | — | — |
| Other materials or locations and insulation materials other than <i>sarking-type materials</i> . <small>Notes 2 and 3</small> | — | 9 | 8 if the <i>Spread-of-Flame Index</i> is more than 5 |

Notes:

1. In a fire control room or *fire-isolated stairway*, a material used as an attachment or part of an attachment to a building element must, if *combustible*, be attached directly to a *non-combustible* substrate and not exceed 1 mm finished thickness.
2. A material, other than one located within a fire-isolated *exit* or fire control room, may be covered on all faces by concrete or masonry not less than 50 mm thick, as an alternative to meeting the specified indices.
3. In the case of a composite member or assembly, the member or assembly must be constructed so that when assembled as proposed in a building—
 - (a) any material which does not comply with this Table is protected on all sides and edges from exposure to the air; and
 - (b) the member or assembly, when tested in accordance with **Specification A2.4**, has a *Spread-of-Flame Index* and a *Smoke-Developed Index* not exceeding those prescribed in this Table; and
 - (c) the member or assembly retains the protection in position so that it prevents ignition of the material and continues to screen it from access to free air for a period of not less than 10 minutes.

SPECIFICATION C1.11 PERFORMANCE OF EXTERNAL WALLS IN FIRE

Deemed-to-Satisfy Provisions

1. Scope

This Specification contains measures to minimise, in the event of fire, the likelihood of *external walls* covered by **Clause 2** collapsing outwards as complete panels and the likelihood of panels separating from supporting members.

2. Application

This Specification applies to buildings having a *rise in storeys* of not more than 2 with concrete *external walls* that could collapse as complete panels (e.g. tilt-up and precast concrete) which—

- (a) consist of either single or multiple panels attached by steel connections to lateral supporting members; and
- (b) depend on those connections to resist outward movement of the panels relative to the supporting members; and
- (c) have height to thickness ratio not greater than 50.

3. General requirements for external wall panels

- (a) Cast-in inserts and fixings must be anchored into the panel with welded bars or be fixed to the panel reinforcement.
- (b) Cast-in inserts for top connections and fixings acting together must be able to resist an ultimate load of two times the larger of the forces *required* to develop—
 - (i) the ultimate bending moment capacity of the panel at its base; or
 - (ii) the overturning moment at the base of the panel arising from an outwards lateral displacement at the top of the panel equal to one tenth of the panel height.
- (c) Top connections of the panel exposed to fire, such as clips and drilled-in inserts, acting together must be able to resist an ultimate load of six times the larger of the forces *required* to develop the moment specified in **(b)(i)** or **(ii)**.

Note.

The increased forces specified by use of the multiplier of two or six in **(b)** and **(c)** above are to take account of the lower strength of the connections and members at the higher than ambient temperatures expected in a fire.

- (d) Lateral supporting members and their connections must be designed to resist the connection forces specified in **(b)** and **(c)** and in the case of an eaves tie member the force in the member must be determined assuming that it deforms in a manner compatible with the lateral displacement of the wall panels, and that it acts in tension only.
- (e) *External wall* panels that span vertically must have at least two upper connections per panel to the supporting member, except that where a number of panels are designed to

Deemed-to-Satisfy Provisions

act as one unit, (e.g. tongue and groove hollow-core panels), only two upper connections are *required* for each unit.

- (f) *External wall* panels that span horizontally between columns must have at least two connections at each column.
- (g) Connections providing lateral support to a panel must be designed to remain engaged to the supported panel both before and during a fire.

4. Additional requirements for vertically spanning external wall panels adjacent to columns

- (a) Where vertically spanning *external wall* panels are located adjacent to columns, connections to the panels must be located and/or detailed to minimise forces that may develop between the panels and columns arising from the restraint of differential displacement.
- (b) The requirements of (a) are satisfied by—
 - (i) detailing the connections and/or the supporting member to sustain a relative outward displacement of (d) between the panels and columns at the connection height where d(m) is calculated as—
 - (A) the square of the connection height (m) divided by one hundred and twenty-five, when the connection height is less than 5 m; or
 - (B) the connection height (m) divided by twenty-five, when the connection height (m) is greater than or equal to 5 m; or
 - (ii) in situations where an eaves tie member is used to provide lateral support to *external wall* panels, the tie member is connected to the panels no closer than a distance (s) from the column where s(m) is taken as one quarter of the panel height (m).

| | | |
|---------------|------|--|
| SPECIFICATION | C2.5 | SMOKE-PROOF WALLS IN HEALTH-CARE AND AGED CARE BUILDINGS |
|---------------|------|--|

Deemed-to-Satisfy Provisions

1. SCOPE

This Specification sets out requirements for the construction of smoke-proof walls in Class 9a *health-care buildings* and Class 9c *aged care buildings*. Smoke proof walls *required* to have an FRL are to be in accordance with **Clause A2.3**.

2. Class 9a health-care buildings

Smoke-proof walls *required* by **C2.5** in Class 9a *health-care buildings* must comply with the following:

- (a) Be *non-combustible* and extend to the underside of—
 - (i) the floor above; or
 - (ii) a *non-combustible* roof covering; or
 - (iii) a ceiling having a *resistance to the incipient spread of fire* to the space above itself of not less than 60 minutes.
- (b) Not incorporate any glazed areas unless the glass is safety glass as defined in AS 1288.
- (c) Only have doorways which are fitted with smoke doors complying with **Specification C3.4**.
- (d) Have all openings around penetrations and the junctions of the smoke-proof wall and the remainder of the building stopped with *non-combustible* material to prevent the free passage of smoke.
- (e) Incorporate smoke dampers where air-handling ducts penetrate the wall unless the duct forms part of a smoke hazard management system *required* to continue air movement through the duct during a fire.

3. Class 9c aged care buildings

Smoke-proof walls *required* by **C2.5** in Class 9c *aged care buildings* must comply with the following:

- (a) The wall may be lined on one side only.
- (b) Linings on the wall must be *non-combustible* and extend to the underside of—
 - (i) the floor above; or
 - (ii) a *non-combustible* roof covering; or
 - (iii) a flush plasterboard ceiling lined with 13 mm standard grade plasterboard or a *fire-protective covering* with all penetrations sealed against the free passage of smoke.
- (c) If plasterboard is used in the lining on a wall, it must be a minimum of 13 mm standard grade plasterboard.
- (d) Not incorporate any glazed areas unless the glass is safety glass as defined in AS 1288.

Deemed-to-Satisfy Provisions

- (e) Only have doorways which are fitted with smoke doors complying with **Specification C3.4**.
- (f) Have all openings around penetrations and the junctions of the smoke-proof wall and the remainder of the building stopped with *non-combustible* material to prevent the free passage of smoke.
- (g) Incorporate smoke dampers where air-handling ducts penetrate the wall unless the duct forms part of a smoke hazard management system *required* to continue air movement through the duct during a fire.

4. Doorways in smoke-proof walls

A door *required* by **C2.5** or this Specification to be smoke-proof or have an FRL, other than one that serves a *fire compartment* provided with a zone smoke control system in accordance with AS/NZS 1668.1, must provide a smoke reservoir by not extending within 400 mm of the underside of—

- (a) a roof covering; or
- (b) the floor above; or
- (c) an imperforate false ceiling that will prevent the free passage of smoke.

SPECIFICATION **C3.4** FIRE DOORS, SMOKE DOORS, FIRE
WINDOWS AND SHUTTERS

Deemed-to-Satisfy Provisions

1. SCOPE

This Specification sets out requirements for the construction of fire doors, smoke doors, fire *windows* and fire shutters.

2. FIRE DOORS

A *required* fire door must—

- (a) comply with AS 1905.1; and
- (b) not fail by radiation through any glazed part during the period specified for *integrity* in the *required* FRL.

3. SMOKE DOORS

3.1 General requirements

Smoke doors must be constructed so that smoke will not pass from one side of the doorway to the other and, if they are glazed, there is minimal danger of a person being injured by accidentally walking into them.

3.2 Construction deemed-to-satisfy

A smoke door of one or two leaves satisfies **Clause 3.1** if it is constructed as follows:

- (a) The leaves are side-hung to swing—
 - (i) in the direction of egress; or
 - (ii) in both directions.
- (b)
 - (i) The leaves are capable of resisting smoke at 200°C for 30 minutes.
 - (ii) Solid-core leaves at least 35 mm thick satisfy **(i)**.
- (c) The leaves are fitted with smoke seals.
- (d)
 - (i) The leaves are normally in the closed position; or
 - (ii)
 - (A) The leaves are closed *automatically* with the *automatic* closing operation initiated by smoke detectors, installed in accordance with the relevant provisions of AS 1670.1, located on each side of the doorway not more than 1.5 m horizontal distance from the doorway; and

Deemed-to-Satisfy Provisions

- (B) in the event of power failure to the door, the leaves fail-safe in the closed position.
- (e) The leaves return to the fully closed position after each manual opening.
- (f) Any glazing incorporated in the door complies with AS 1288.
- (g)
 - (i) If a glazed panel is capable of being mistaken for an unobstructed *exit*, the presence of the glass must be identified by opaque construction.
 - (ii) An opaque mid-height band, mid-rail or crash bar satisfies (i).

4. FIRE SHUTTERS

A *required* fire shutter must—

- (a) be a shutter that—
 - (i) is identical with a tested prototype that has achieved the *required* FRL; and
 - (ii) is installed in the same manner and in an opening that is not larger than the tested prototype; and
 - (iii) did not have a rise in average temperature on the side remote from the furnace of more than 140 K during the first 30 minutes of the test; or
- (b) be a steel shutter complying with AS 1905.2 if a metallic fire shutter is not prohibited by **C3.5**.

5. FIRE WINDOWS

A *required* fire *window* must be—

- (a) identical in construction with a prototype that has achieved the *required* FRL; and
- (b) installed in the same manner and in an opening that is not larger than the tested prototype.

SPECIFICATION **C3.15** PENETRATION OF WALLS, FLOORS AND CEILINGS BY SERVICES

Deemed-to-Satisfy Provisions

1. Scope

This Specification prescribes materials and methods of installation for services that penetrate walls, floors and ceilings *required* to have an FRL.

2. Application

- (a) This Specification applies to installations permitted under the *Deemed-to-Satisfy Provisions* of the BCA as alternatives to systems that have been demonstrated by test to fulfil the requirements of **C3.15(a)**.
- (b) This Specification does not apply to installations in ceilings *required* to have a *resistance to the incipient spread of fire* nor to the installation of piping that contains or is intended to contain a flammable liquid or gas.

3. Metal pipe systems

- (a) A pipe system comprised entirely of metal (excluding pipe seals or the like) that is not normally filled with liquid must not be located within 100 mm, for a distance of 2 m from the penetration, of any *combustible* building element or a position where *combustible* material may be located, and must be constructed of—
 - (i) copper alloy or stainless steel with a wall thickness of at least 1 mm; or
 - (ii) cast iron or steel (other than stainless steel) with a wall thickness of at least 2 mm.
- (b) An opening for a pipe system comprised entirely of metal (excluding pipe seals or the like) must—
 - (i) be neatly formed, cut or drilled; and
 - (ii) be no closer than 200 mm to any other service penetration; and
 - (iii) accommodate only one pipe.
- (c) A pipe system comprised entirely of metal (excluding pipe seals or the like) must be wrapped but must not be lagged or enclosed in thermal insulation over the length of its penetration of a wall, floor or ceiling unless the lagging or thermal insulation fulfils the requirements of **Clause 7**.
- (d) The gap between a metal pipe and the wall, floor or ceiling it penetrates must be fire-stopped in accordance with **Clause 7**.

4. Pipes penetrating sanitary compartments

If a pipe of metal or UPVC penetrates the floor of a *sanitary compartment* in accordance with **C3.15(c)(ii)**—

- (a) the opening must be neatly formed and no larger than is necessary to accommodate the pipe or fitting; and

Deemed-to-Satisfy Provisions

- (b) the gap between pipe and floor must be fire-stopped in accordance with **Clause 7**.

5. Wires and cables

If a wire or cable or cluster of wires or cables penetrates a floor, wall or ceiling—

- (a) the opening must be neatly formed, cut or drilled and no closer than 50 mm to any other service; and
- (b) the opening must be no larger in cross-sectional area than—
- (i) 2000 mm² if only a single cable is accommodated and the gap between cable and wall, floor or ceiling is no wider than 15 mm; or
 - (ii) 500 mm² in any other case; and
- (c) the gap between the service and the wall, floor or ceiling must be fire-stopped in accordance with **Clause 7**.

6. Electrical switches and outlets

If an electrical switch, outlet, socket or the like is accommodated in an opening or recess in a wall, floor or ceiling—

- (a) the opening or recess must not—
- (i) be located opposite any point within 300 mm horizontally or 600 mm vertically of any opening or recess on the opposite side of the wall; or
 - (ii) extend beyond half the thickness of the wall; and
- (b) the gap between the service and the wall, floor or ceiling must be fire-stopped in accordance with **Clause 7**.

7. Fire-stopping

- (a) **Material:** The material used for the fire-stopping of service penetrations must be concrete, high-temperature mineral fibre, high-temperature ceramic fibre or other material that does not flow at a temperature below 1120°C when tested in accordance with ISO 540, and must have—
- (i) demonstrated in a system tested in accordance with **C3.15(a)** that it does not impair the *fire-resisting* performance of the building element in which it is installed; or
 - (ii) demonstrated in a test in accordance with **(e)** that it does not impair the *fire-resisting* performance of the test slab.
- (b) **Installation:** Fire-stopping material must be packed into the gap between the service and wall, floor or ceiling in a manner, and compressed to the same degree, as adopted for testing under **Clause 7(a)(i)** or **(ii)**.
- (c) **Hollow construction:** If a pipe penetrates a hollow wall (such as a stud wall, a cavity wall or a wall of hollow blockwork) or a hollow floor/ceiling system, the cavity must be so framed and packed with fire-stopping material that is—
- (i) installed in accordance with **Clause 7(b)** to a thickness of 25 mm all round the service for the full length of the penetration; and

Deemed-to-Satisfy Provisions

- (ii) restrained, independently of the service, from moving or parting from the surfaces of the service and of the wall, floor or ceiling.
- (d) **Recesses:** If an electrical switch, socket, outlet or the like is accommodated in a recess in a hollow wall or hollow floor/ceiling system—
- (i) the cavity immediately behind the service must be framed and packed with fire-stopping material in accordance with **Clause 7(c)**; or
 - (ii) the back and sides of the service must be protected with refractory lining board identical with and to the same thickness as that in which the service is installed.
- (e) **Test:** The test to demonstrate compliance of a fire-stopping material with this Specification must be conducted as follows:
- (i) The test specimen must comprise a concrete slab not less than 1 m square and not more than 100 mm thick, and appropriately reinforced if necessary for *structural adequacy* during manufacture, transport and testing.
 - (ii) The slab must have a hole 50 mm in diameter through the centre and the hole must be packed with the fire-stopping material.
 - (iii) The slab must be conditioned in accordance with AS 1530.4.
 - (iv) Two thermocouples complying with AS 1530.4 must be attached to the upper surface of the packing each about 5 mm from its centre.
 - (v) The slab must be tested on flat generally in accordance with Section 10 of AS 1530.4 and must achieve an FRL of 60/60/60 or as otherwise *required*.

SECTION **D**

ACCESS AND EGRESS

- D1** **Provision for Escape**
- D2** **Construction of Exits**
- D3** **Access for People with Disabilities**

SECTION D CONTENTS

SECTION D ACCESS AND EGRESS

Section D Access and Egress

Objective DO1
Functional Statements DF1 - DF2
Performance Requirements DP1 - DP9
Verification Method DV1

Part D1 Provision for Escape

D1.0 Deemed-to-Satisfy Provisions
D1.1 Application of Part
D1.2 Number of exits required
D1.3 When fire-isolated stairways and ramps are required
D1.4 Exit travel distances
D1.5 Distance between alternative exits
D1.6 Dimensions of exits and paths of travel to exits
D1.7 Travel via fire-isolated exits
D1.8 External stairways or ramps in lieu of fire-isolated exits
D1.9 Travel by non-fire-isolated stairways or ramps
D1.10 Discharge from exits
D1.11 Horizontal exits
D1.12 Non-required stairways, ramps or escalators
D1.13 Number of persons accommodated
D1.14 Measurement of distances
D1.15 Method of measurement
D1.16 Plant rooms, lift machine rooms and electricity network substations:
 Concession
D1.17 Access to lift pits

Part D2 Construction of Exits

D2.0 Deemed-to-Satisfy Provisions
D2.1 Application of Part
D2.2 Fire-isolated stairways and ramps
D2.3 Non-fire-isolated stairways and ramps
D2.4 Separation of rising and descending stair flights
D2.5 Open access ramps and balconies
D2.6 Smoke lobbies
D2.7 Installations in exits and paths of travel
D2.8 Enclosure of space under stairs and ramps
D2.9 Width of required stairways and ramps
D2.10 Pedestrian ramps
D2.11 Fire-isolated passageways
D2.12 Roof as open space
D2.13 Goings and risers
D2.14 Landings

- D2.15 Thresholds
- D2.16 Balustrades or other barriers
- D2.17 Handrails
- D2.18 Fixed platforms, walkways, stairways and ladders
- D2.19 Doorways and doors
- D2.20 Swinging doors
- D2.21 Operation of latch
- D2.22 Re-entry from fire-isolated exits
- D2.23 Signs on doors
- D2.24 Protection of openable windows

Part D3 Access for People with a Disability

- D3.0 Deemed-to-Satisfy Provisions
- D3.1 General building access requirements
- D3.2 Access to buildings
- D3.3 Parts of buildings to be accessible
- D3.4 Exemptions
- D3.5 Accessible carparking
- D3.6 Signage
- D3.7 Hearing augmentation
- D3.8 Tactile indicators
- D3.9 Wheelchair seating spaces in Class 9b assembly buildings
- D3.10 Swimming pools
- D3.11 Ramps
- D3.12 Glazing on an accessway

Specifications

- Specification D1.12 Non-Required Stairways, Ramps and Escalators
- Specification D3.6 Braille and Tactile Signs
- Specification D3.10 Accessible Water Entry/Exit for Swimming Pools

SECTION D ACCESS AND EGRESS

OBJECTIVE

DO1

The *Objective* of this Section is to—

- (a) provide, as far as is reasonable, people with safe, equitable and dignified access to—
 - (i) a building; and
 - (ii) the services and facilities within a building; and
- (b) safeguard occupants from illness or injury while evacuating in an emergency.

FUNCTIONAL STATEMENTS

DF1

A building is to provide, as far as is reasonable—

- (a) safe; and
- (b) equitable and dignified,

access for people to the services and facilities within.

Limitation:

DF1(b) does not apply to a Class 4 part of a building.

DF2

A building is to be provided with means of evacuation which allow occupants time to evacuate safely without being overcome by the effects of an emergency.

Limitation:

DF2 does not apply to the internal parts of a *sole-occupancy unit* in a Class 2 or 3 building or Class 4 part of a building.

PERFORMANCE REQUIREMENTS

DP1

Access must be provided, to the degree necessary, to enable—

- (a) people to—
 - (i) approach the building from the road boundary and from any *accessible* carparking spaces associated with the building; and
 - (ii) approach the building from any *accessible* associated building; and
 - (iii) access work and public spaces, accommodation and facilities for personal hygiene; and
- (b) identification of *accessways* at appropriate locations which are easy to find.

Limitation:

DP1 does not apply to a Class 4 part of a building.

DP2

So that people can move safely to and within a building, it must have—

- (a) walking surfaces with safe gradients; and
- (b) any doors installed to avoid the risk of occupants—
 - (i) having their egress impeded; or
 - (ii) being trapped in the building; and
- (c) any stairways and ramps with—
 - (i) slip-resistant walking surfaces on—
 - (A) ramps; and
 - (B) stairway treads or near the edge of the nosing; and
 - (ii) suitable handrails where necessary to assist and provide stability to people using the stairway or ramp; and
 - (iii) suitable landings to avoid undue fatigue; and
 - (iv) landings where a door opens from or onto the stairway or ramp so that the door does not create an obstruction; and
 - (v) in the case of a stairway, suitable safe passage in relation to the nature, volume and frequency of likely usage.

DP3

Where people could fall—

- (a) 1 m or more—
 - (i) from a floor or roof or through an opening (other than through an openable window) in the *external wall* of a building; or
 - (ii) due to a sudden change of level within or associated with a building; or

- (b) 2 m or more from a floor through an openable window—
 - (i) in a bedroom in a Class 2 or 3 building or a Class 4 part of a building; or
 - (ii) in a Class 9b *early childhood centre*; or
- (c) 4 m or more from a floor through an openable window not covered by (b), a barrier must be provided which must be—
 - (d) continuous and extend for the full extent of the hazard; and
 - (e) of a height to protect people from accidentally falling from the floor or roof or through the opening or openable window; and
 - (f) constructed to prevent people from falling through the barrier; and
 - (g) capable of restricting the passage of children; and
 - (h) of strength and rigidity to withstand—
 - (i) the foreseeable impact of people; and
 - (ii) where appropriate, the static pressure of people pressing against it.

Limitations:

DP3 does not apply where such a barrier would be incompatible with the intended use of an area such as a stage, loading dock or the like.

DP3(g) does not apply to—

- (a) *fire-isolated stairways*, *fire-isolated ramps*, and other areas used primarily for emergency purposes, excluding external stairways and external ramps; and
- (b) Class 7 (other than *carparks*) and Class 8 buildings and parts of buildings containing those classes.

DP4

Exits must be provided from a building to allow occupants to evacuate safely, with their number, location and dimensions being appropriate to—

- (a) the travel distance; and
- (b) the number, mobility and other characteristics of occupants; and
- (c) the function or use of the building; and
- (d) the height of the building; and
- (e) whether the *exit* is from above or below ground level.

DP5

To protect evacuating occupants from a fire in the building *exits* must be fire-isolated, to the degree necessary, appropriate to—

- (a) the number of *storeys* connected by the *exits*; and
- (b) the *fire safety system* installed in the building; and
- (c) the function or use of the building; and
- (d) the number of *storeys* passed through by the *exits*; and

- (e) *fire brigade* intervention.

DP6

So that occupants can safely evacuate the building, paths of travel to exits must have dimensions appropriate to—

- (a) the number, mobility and other characteristics of occupants; and
- (b) the function or use of the building.

Limitation:

DP6 does not apply to the internal parts of a *sole-occupancy unit* in a Class 2 or 3 building or Class 4 part of a building.

DP7

Where a lift is intended to be used in addition to the *required exits* to assist occupants to evacuate a building safely, the type, number, location and fire-isolation must be appropriate to—

- (a) the travel distance to the lift; and
- (b) the number, mobility and other characteristics of occupants; and
- (c) the function or use of the building; and
- (d) the number of *storeys* connected by the lift; and
- (e) the *fire safety system* installed in the building; and
- (f) the waiting time, travel time and capacity of the lift; and
- (g) the reliability and availability of the lift; and
- (h) the emergency procedures for the building.

DP8

Carparking spaces for use by people with a disability must be—

- (a) provided, to the degree necessary, to give equitable access for carparking; and
- (b) designated and easy to find.

Limitation:

DP8 does not apply to a building where—

- (a) a parking service is provided; and
- (b) direct access to any carparking spaces by the general public or occupants is not available.

DP9

An inbuilt communication system for entry, information, entertainment, or for the provision of a service, must be suitable for occupants who are deaf or hearing impaired.

Limitation:

DP9 does not apply to—

- (a) a Class 4 part of a building; or
- (b) an inbuilt communication system used only for emergency warning purposes.

Tas DP10

VERIFICATION METHOD

DV1 Wire balustrades

Compliance with **DP3(e)** and **(f)** for wire balustrades is verified when the wire balustrade passes the test described below:

(a) **Application**

The test must be carried out on either—

- (i) a prototype of a wire balustrade that is identical to that proposed to be installed on-site; or
- (ii) a wire balustrade installed on-site.

(b) **Test equipment**

The test equipment must consist of the following:

- (i) A horizontally suspended 125 mm diameter, 405 mm long cylinder of 1 mm thick steel having a highly polished 105 mm long cone at one end with a 20 mm diameter flat leading edge to which an eye bolt is fixed.
- (ii) A sufficiently flexible horizontal cable with mechanisms capable of applying and measuring a tension of 150 N (or a 15.3 kg weight suspended over a low friction pulley) is to be attached to the eye bolt (see **Figure DV1**).
- (iii) A mechanism capable of measuring the tension force applied to each balustrade wire.

Figure DV1

APPARATUS FOR TESTING WIRE BALUSTRADES

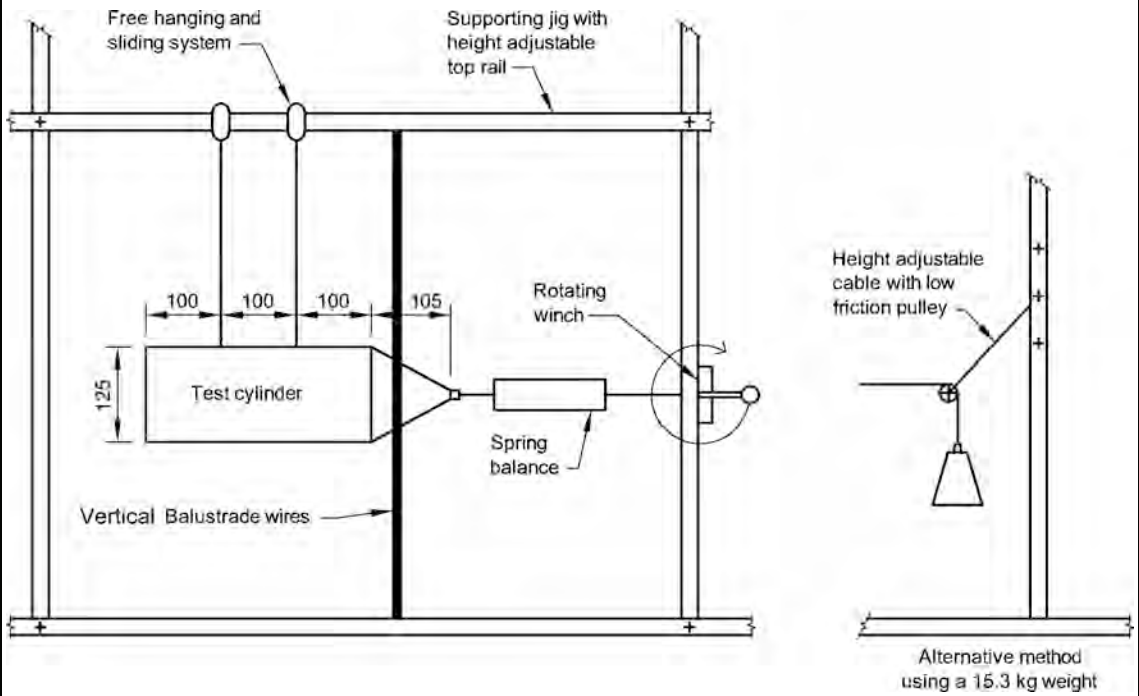

(c) Test procedure

The test procedure must be as follows:

- (i) Tension the wires, within their safe load, to the same tension in all wires and measure the tensions with a strain indicator.
- (ii) For—
 - (A) horizontal or near horizontal wires, position the cone against a pair of wires at the mid-span between supports, then apply the 150 N tension force to the cone; and
 - (B) vertical wires, position the cone against a pair of wires at the mid-span between supporting rails, then apply the 150 N tension force to the cone; and
 - (C) near-vertical wires, position the cone against a pair of wires at the widest opening between the wires, then apply the 150 N tension force to the cone.
- (iii) Attempt to pull the cone through the gap between the wires under the 150 N load, and—
 - (A) increase the tension in the wires and repeat (ii) until such time as the cone will not pull through; or
 - (B) if it does not pull through, reduce the tension in the wires and repeat step (ii); and
- (iv) When the cone is just prevented from pulling through the gap, the wires are at the correct tension in which case the cone is withdrawn and the tension recorded.

- (v) Reduce the tension in the wires and repeat steps (ii) to (iv) twice more, recording the tension in each case after the cone has been removed and then calculate the average of the three tensions as the *required* tension for each wire.
 - (vi) For prototype tests of horizontal or near horizontal wires, record the deflection of each wire at the average tension calculated in accordance with (v) when a 2 kg mass is hung at mid-span between supports.
- (d) **Test report**
- The test report must include the following information:
- (i) The name and address of the person supervising the test.
 - (ii) The test report number.
 - (iii) The date of the test.
 - (iv) The wire manufacturer's name and address, and specifications of the wires used in the test including the safe load limit of the wires.
 - (v) The construction details of the test specimen, including a description and drawings and details of the components including supports, post or railing spacings and wire spacings.
 - (vi) For a prototype test, the *required* tension calculated in accordance with (c)(v).
 - (vii) For prototype tests of horizontal or near horizontal wires, the deflection measured in accordance with (c)(vi).

PART D1 PROVISION FOR ESCAPE

Deemed-to-Satisfy Provisions

D1.0 Deemed-to-Satisfy Provisions

- (a) Where a *Building Solution* is proposed to comply with the *Deemed-to-Satisfy Provisions*, *Performance Requirements DP1 to DP6, DP8 and DP9* are satisfied by complying with—
- (i) **D1.1 to D1.16, D2.1 to D2.24 and D3.1 to D3.12**; and
 - (ii) in a building containing an *atrium*, **Part G3**; and
 - (iii) for theatres, *stages* and public halls, **Part H1**; and
 - (iv) for public transport buildings, **Part H2**.
- (b) Where a *Building Solution* is proposed as an *Alternative Solution* to the *Deemed-to-Satisfy Provisions* of—
- (i) **D1.1 to D1.16, D2.1 to D2.24 and D3.1 to D3.12**; and
 - (ii) in a building containing an *atrium*, **Part G3**; and
 - (iii) for theatres, *stages* and public halls, **Part H1**; and
 - (iv) for public transport buildings, **Part H2**,
- the relevant *Performance Requirements* must be determined in accordance with **A0.10**.
- (c) *Performance Requirement DP7* must be complied with if lifts are to be used to assist occupants to evacuate a building.

There are no *Deemed-to-Satisfy Provisions* for this *Performance Requirement* in respect of using lifts.

D1.1 Application of Part

The *Deemed-to-Satisfy Provisions* of this Part do not apply to the internal parts of a *sole-occupancy unit* in a Class 2 or 3 building or a Class 4 part of a building.

D1.2 Number of exits required

- (a) **All buildings** — Every building must have at least one *exit* from each *storey*.
- (b) **Class 2 to 8 buildings** — In addition to any *horizontal exit*, not less than 2 *exits* must be provided from the following:
- (i) Each *storey* if the building has an *effective height* of more than 25 m.
 - (ii) A Class 2 or 3 building subject to **C1.5**.
- (c) **Basements** — In addition to any *horizontal exit*, not less than 2 *exits* must be provided from any *storey* if egress from that *storey* involves a vertical rise within the building of more than 1.5 m, unless—
- (i) the *floor area* of the *storey* is not more than 50 m²; and
 - (ii) the distance of travel from any point on the floor to a single *exit* is not more than 20 m.

Deemed-to-Satisfy Provisions

- (d) **Class 9 buildings** — In addition to any *horizontal exit*, not less than 2 *exits* must be provided from the following:
- (i) Each *storey* if the building has a *rise in storeys* of more than 6 or an *effective height* of more than 25 m.
 - (ii) Any *storey* which includes a *patient care area* in a Class 9a *health-care building*.
 - (iii) Any *storey* that contains sleeping areas in a Class 9c *aged care building*.
 - (iv) Each *storey* in a Class 9b building used as an *early childhood centre*.
 - (v) Each *storey* in a primary or secondary *school* with a *rise in storeys* of 2 or more.
 - (vi) Any *storey* or *mezzanine* that accommodates more than 50 persons, calculated under **D1.13**.

NSW D1.2(d)(vii)

- (e) **Exits from Class 9c aged care buildings and patient care areas in Class 9a health-care buildings** — In a Class 9a *health-care building* and a Class 9c *aged care building*, at least one *exit* must be provided from every part of a *storey* which has been divided into *fire compartments* in accordance with **C2.2** or **C2.5**.
- (f) **Exits in open spectator stands** — In an *open spectator stand* containing more than one tier of seating, every tier must have not less than 2 stairways or ramps, each forming part of the path of travel to not less than 2 *exits*.
- (g) **Access to exits** — Without passing through another *sole-occupancy unit* every occupant of a *storey* or part of a *storey* must have access to—
- (i) an *exit*; or
 - (ii) at least 2 *exits*, if 2 or more *exits* are *required*.

D1.3 When fire-isolated stairways and ramps are required

- (a) **Class 2 and 3 buildings** — Every stairway or ramp serving as a *required exit* must be fire-isolated unless it connects, passes through or passes by not more than—
- (i) 3 consecutive *storeys* in a Class 2 building; or
 - (ii) 2 consecutive *storeys* in a Class 3 building,
- and one extra *storey* of any classification may be included if—
- (iii) it is only for the accommodation of motor vehicles or for other ancillary purposes; or
 - (iv) the building has a sprinkler system complying with **Specification E1.5** installed throughout; or
 - (v) the *required exit* does not provide access to or egress for, and is separated from, the extra *storey* by construction having—
 - (A) an FRL of –/60/60, if non-*loadbearing*; and
 - (B) an FRL of 90/90/90, if *loadbearing*; and
 - (C) no opening that could permit the passage of fire or smoke.
- (b) **Class 5, 6, 7, 8 or 9 buildings** — Every stairway or ramp serving as a *required exit* must be fire-isolated unless—

Deemed-to-Satisfy Provisions

- (i) in a Class 9a *health-care building* — it connects, or passes through or passes by not more than 2 consecutive *storeys* in areas other than *patient care areas*; or
- (ii) it is part of an *open spectator stand*; or
- (iii) in any other case except in a Class 9c *aged care building*, it connects, passes through or passes by not more than 2 consecutive *storeys* and one extra *storey* of any classification may be included if—
 - (A) the building has a sprinkler system complying with **Specification E1.5** installed throughout; or
 - (B) the *required exit* does not provide access to or egress for, and is separated from, the extra *storey* by construction having—
 - (aa) an FRL of –/60/60, if non-*loadbearing*; and
 - (bb) an FRL of 90/90/90 for Type A construction or 60/60/60 for Type B construction, if *loadbearing*; and
 - (cc) no opening that could permit the passage of fire or smoke.

D1.4 Exit travel distances

- (a) **Class 2 and 3 buildings**—
 - (i) The entrance doorway of any *sole-occupancy unit* must be not more than—
 - (A) 6 m from an *exit* or from a point from which travel in different directions to 2 *exits* is available; or
 - (B) 20 m from a single *exit* serving the *storey* at the level of egress to a road or *open space*; and
 - (ii) no point on the floor of a room which is not in a *sole-occupancy unit* must be more than 20 m from an *exit* or from a point at which travel in different directions to 2 *exits* is available.
- (b) **Class 4 parts of a building** — The entrance doorway to any Class 4 part of a building must be not more than 6 m from an *exit* or a point from which travel in different directions to 2 *exits* is available.
- (c) **Class 5, 6, 7, 8 or 9 buildings** — Subject to **(d)**, **(e)** and **(f)**—
 - (i) no point on a floor must be more than 20 m from an *exit*, or a point from which travel in different directions to 2 *exits* is available, in which case the maximum distance to one of those *exits* must not exceed 40 m; and
 - (ii) in a Class 5 or 6 building, the distance to a single *exit* serving a *storey* at the level of access to a road or *open space* may be increased to 30 m.

Vic D1.4(d)

- (d) **Class 9a buildings** — In a *patient care area* in a Class 9a building—
 - (i) no point on the floor must be more than 12 m from a point from which travel in different directions to 2 of the *required exits* is available; and
 - (ii) the maximum distance to one of those *exits* must not be more than 30 m from the starting point.
- (e) **Open spectator stands** — The distance of travel to an *exit* in a Class 9b building used as an *open spectator stand* must be not more than 60 m.

Deemed-to-Satisfy Provisions

- (f) **Assembly buildings** — In a Class 9b building other than a *school* or *early childhood centre*, the distance to one of the *exits* may be 60 m if—
- (i) the path of travel from the room concerned to that *exit* is through another area which is a corridor, hallway, lobby, ramp or other circulation space; and
 - (ii) the room is smoke-separated from the circulation space by construction having an FRL of not less than 60/60/60 with every doorway in that construction protected by a tight fitting, *self-closing*, solid-core door not less than 35 mm thick; and
 - (iii) the maximum distance of travel does not exceed 40 m within the room and 20 m from the doorway to the room through the circulation space to the *exit*.

D1.5 Distance between alternative exits

Exits that are *required* as alternative means of egress must be—

- (a) distributed as uniformly as practicable within or around the *storey* served and in positions where unobstructed access to at least 2 *exits* is readily available from all points on the floor including lift lobby areas; and
- (b) not less than 9 m apart; and
- (c) not more than—
 - (i) in a Class 2 or 3 building — 45 m apart; or
 - (ii) in a Class 9a *health-care building*, if such *required exit* serves a *patient care area* — 45 m apart; or
 - (iii) in all other cases — 60 m apart; and
- (d) located so that alternative paths of travel do not converge such that they become less than 6 m apart.

D1.6 Dimensions of exits and paths of travel to exits

In a *required exit* or path of travel to an *exit*—

- (a) the unobstructed height throughout must be not less than 2 m, except the unobstructed height of any doorway may be reduced to not less than 1980 mm; and
- (b) the unobstructed width of each *exit* or path of travel to an *exit*, except for doorways, must be not less than—
 - (i) 1 m; or
 - (ii) 1.8 m in a passageway, corridor or ramp normally used for the transportation of patients in beds within a *treatment area* or *ward area*; and
 - (iii) in a *public corridor* in a Class 9c *aged care building*, notwithstanding (c) and (d)—
 - (A) 1.5 m; and
 - (B) 1.8 m for the full width of the doorway, providing access into a *sole-occupancy unit* or communal bathroom; and
- (c) if the *storey* or *mezzanine* accommodates more than 100 persons but not more than 200 persons, the aggregate unobstructed width, except for doorways, must be not less than—
 - (i) 1 m plus 250 mm for each 25 persons (or part) in excess of 100; or

Deemed-to-Satisfy Provisions

- (ii) 1.8 m in a passageway, corridor or ramp normally used for the transportation of patients in beds within a *treatment area* or *ward area*; and
- (d) if the *storey* or *mezzanine* accommodates more than 200 persons, the aggregate unobstructed width, except for doorways, must be increased to—
 - (i) 2 m plus 500 mm for every 60 persons (or part) in excess of 200 persons if egress involves a change in floor level by a stairway or ramp with a gradient steeper than 1 in 12; or
 - (ii) in any other case, 2 m plus 500 mm for every 75 persons (or part) in excess of 200; and
- (e) in an *open spectator stand* which accommodates more than 2000 persons, the aggregate unobstructed width, except for doorways, must be increased to 17 m plus a width (in metres) equal to the number in excess of 2000 divided by 600; and
- (f) the unobstructed width of a doorway must be not less than—
 - (i) in *patient care areas* through which patients would normally be transported in beds, if the doorway provides access to, or from, a corridor of width—
 - (A) less than 2.2 m — 1200 mm; or
 - (B) 2.2 m or greater — 1070 mm,
 and where the doorway is fitted with two leaves and one leaf is secured in the closed position in accordance with **D2.21(a)(v)**, the other leaf must permit an unobstructed opening not less than 800 mm wide; or
 - (ii) in *patient care areas* in a *horizontal exit* — 1250 mm; or
 - (iii) the unobstructed width of each *exit* provided to comply with **(b)**, **(c)**, **(d)** or **(e)**, minus 250 mm; or
 - (iv) in a Class 9c *aged care building*—

Vic D1.6(f)(iv)

- (A) 1070 mm where it opens from a *public corridor* to a *sole-occupancy unit*; or
 - (B) 870 mm in other *resident use areas*; or
 - (C) 800 mm in non-*resident use areas*,
- and where the doorway is fitted with two leaves and one leaf is secured in the closed position in accordance with **D2.21(a)(v)**, the other leaf must permit an unobstructed opening not less than 870 mm wide in *resident use areas* and 800 mm wide in non-*resident use areas*; or
- (v) in any other case except where it opens to a *sanitary compartment* or bathroom — 750 mm wide; and

NSW D1.6(f)(vi)

- (g) the unobstructed width of a *required exit* must not diminish in the direction of travel to a road or *open space*, except where the width is increased in accordance with **(b)(ii)** or **(f)(i)**; and
- (h) the *required* width of a stairway or ramp must—
 - (i) be measured clear of all obstructions such as handrails, projecting parts of balustrades or other barriers and the like; and

Deemed-to-Satisfy Provisions

- (ii) extend without interruption, except for ceiling cornices, to a height not less than 2 m vertically above a line along the nosings of the treads or the floor surface of the ramp or landing.

NSW D1.6(i)

D1.7 Travel via fire-isolated exits

- (a) A doorway from a room must not open directly into a stairway, passageway or ramp that is *required* to be fire-isolated unless it is from—
 - (i) a *public corridor*, public lobby or the like; or
 - (ii) a *sole-occupancy unit* occupying all of a *storey*; or
 - (iii) a *sanitary compartment*, airlock or the like.
- (b) Each *fire-isolated stairway* or *fire-isolated ramp* must provide independent egress from each *storey* served and discharge directly, or by way of its own *fire-isolated passageway*—
 - (i) to a road or *open space*; or
 - (ii) to a point—
 - (A) in a *storey* or space, within the confines of the building, that is used only for pedestrian movement, car parking or the like and is open for at least $\frac{2}{3}$ of its perimeter; and
 - (B) from which an unimpeded path of travel, not further than 20 m, is available to a road or *open space*; or
 - (iii) into a covered area that—
 - (A) adjoins a road or *open space*; and
 - (B) is open for at least $\frac{1}{3}$ of its perimeter; and
 - (C) has an unobstructed clear height throughout, including the perimeter openings, of not less than 3 m; and
 - (D) provides an unimpeded path of travel from the point of discharge to the road or *open space* of not more than 6 m.
- (c) Where a path of travel from the point of discharge of a fire-isolated *exit* necessitates passing within 6 m of any part of an *external wall* of the same building, measured horizontally at right angles to the path of travel, that part of the wall must have—
 - (i) an FRL of not less than 60/60/60; and
 - (ii) any openings protected internally in accordance with **C3.4**,
for a distance of 3 m above or below, as appropriate, the level of the path of travel, or for the height of the wall, whichever is the lesser.
- (d) If more than 2 access doorways, not from a *sanitary compartment* or the like, open to a *required* fire-isolated *exit* in the same *storey*—
 - (i) a smoke lobby in accordance with **D2.6** must be provided; or
 - (ii) the *exit* must be pressurised in accordance with AS/NZS 1668.1.
- (e) A ramp must be provided at any change in level less than 600 mm in a *fire-isolated passageway* in a Class 9 building.

Deemed-to-Satisfy Provisions

D1.8 External stairways or ramps in lieu of fire-isolated exits

- (a) An external stairway or ramp may serve as a *required exit* in lieu of a fire-isolated *exit* serving a *storey* below an *effective height* of 25 m, if the stairway or ramp is—
- (i) *non-combustible* throughout; and
 - (ii) protected in accordance with (c) if it is within 6 m of, and exposed to any part of the *external wall* of the building it serves.
- (b) For the purposes of this clause—
- (i) exposure under (a)(ii), is measured in accordance with **Clause 2.1 of Specification C1.1**, as if the *exit* was a building element and the *external wall* of the building was a *fire-source feature* to the *exit*, except that the FRL *required* in **Clause 2.1(a)(i)** must not be less than 60/60/60; and
 - (ii) the plane formed at the construction edge or perimeter of an unenclosed building or part such as an *open-deck carpark*, *open spectator stand* or the like, is deemed to be an *external wall*; and
 - (iii) openings in an *external wall* and openings under (c) and (d), are determined in accordance with **C3.1**.
- (c) The protection referred to in (a)(ii), must adequately protect occupants using the *exit* from exposure to a fire within the building, in accordance with one of the following methods:
- (i) The part of the *external wall* of the building to which the *exit* is exposed must have—
 - (A) an FRL of not less than 60/60/60; and
 - (B) no openings less than 3 m from the *exit* (except a doorway serving the *exit* protected by a –/60/30 fire door in accordance with **C3.8(a)**); and
 - (C) any opening 3 m or more but less than 6 m from the *exit*, protected in accordance with **C3.4** and if wall wetting sprinklers are used, they are located internally.
 - (ii) The *exit* must be protected from—
 - (A) any part of the *external wall* of the building having an FRL of less than 60/60/60; and
 - (B) any openings in the *external wall*,
 by the construction of a wall, roof, floor or other shielding element as appropriate in accordance with (d).
- (d) The wall, roof, floor or other shielding element *required* by (c)(ii) must—
- (i) have an FRL of not less than 60/60/60; and
 - (ii) have no openings less than 3 m from the *external wall* of the building (except a doorway serving the *exit* protected by a –/60/30 fire door in accordance with **C3.8(a)**); and
 - (iii) have any opening 3 m or more but less than 6 m from any part of the *external wall* of the building protected in accordance with **C3.4** and if wall wetting sprinklers are used, they are located on the side exposed to the *external wall*.

Deemed-to-Satisfy Provisions

D1.9 Travel by non-fire-isolated stairways or ramps

- (a) A non-*fire-isolated stairway* or non-*fire-isolated ramp* serving as a *required exit* must provide a continuous means of travel by its own *flights* and landings from every *storey* served to the level at which egress to a road or *open space* is provided.
- (b) In a Class 2, 3 or 4 building, the distance between the doorway of a room or *sole-occupancy unit* and the point of egress to a road or *open space* by way of a stairway or ramp that is not fire-isolated and is *required* to serve that room or *sole-occupancy unit* must not exceed—
 - (i) 30 m in a building of Type C construction; or
 - (ii) 60 m in all other cases.
- (c) In a Class 5, 6, 7, 8 or 9 building, the distance from any point on a floor to a point of egress to a road or *open space* by way of a *required non-fire-isolated stairway* or non-*fire-isolated ramp* must not exceed 80 m.
- (d) In a Class 2, 3 or 9a building, a *required non-fire-isolated stairway* or non-*fire-isolated ramp* must discharge at a point not more than—
 - (i) 15 m from a doorway providing egress to a road or *open space* or from a *fire-isolated passageway* leading to a road or *open space*; or
 - (ii) 30 m from one of 2 such doorways or passageways if travel to each of them from the non-*fire-isolated stairway* or non-*fire-isolated ramp* is in opposite or approximately opposite directions.
- (e) In a Class 5 to 8 or 9b building, a *required non-fire-isolated stairway* or non-*fire-isolated ramp* must discharge at a point not more than—
 - (i) 20 m from a doorway providing egress to a road or *open space* or from a *fire-isolated passageway* leading to a road or *open space*; or
 - (ii) 40 m from one of 2 such doorways or passageways if travel to each of them from the non-*fire-isolated stairway* or non-*fire-isolated ramp* is in opposite or approximately opposite directions.
- (f) In a Class 2 or 3 building, if 2 or more *exits* are *required* and are provided by means of internal non-*fire-isolated stairways* or non-*fire-isolated ramps*, each *exit* must—
 - (i) provide separate egress to a road or *open space*; and
 - (ii) be suitably smoke-separated from each other at the level of discharge.

D1.10 Discharge from exits

- (a) An *exit* must not be blocked at the point of discharge and where necessary, suitable barriers must be provided to prevent vehicles from blocking the *exit*, or access to it.
- (b) If a *required exit* leads to an *open space*, the path of travel to the road must have an unobstructed width throughout of not less than—
 - (i) the minimum width of the *required exit*; or
 - (ii) 1 m,
 whichever is the greater.
- (c) If an *exit* discharges to *open space* that is at a different level than the public road to which it is connected, the path of travel to the road must be by—

Deemed-to-Satisfy Provisions

- (i) a ramp or other incline having a gradient not steeper than 1:8 at any part, or not steeper than 1:14 if *required* by the *Deemed-to-Satisfy Provisions* of **Part D3**; or
 - (ii) except if the *exit* is from a Class 9a building, a stairway complying with the *Deemed-to-Satisfy Provisions* of the BCA.
- (d) The discharge point of alternative *exits* must be located as far apart as practical.
- (e) In a Class 9b building which is an *open spectator stand* that accommodates more than 500 persons, a *required* stairway or *required* ramp must not discharge to the ground in front of the stand.

NSW D1.10(f)

- (f) In a Class 9b building containing an auditorium which accommodates more than 500 persons, not more than $\frac{2}{3}$ of the *required* width of *exits* must be located in the main entrance foyer.

D1.11 Horizontal exits

- (a) *Horizontal exits* must not be counted as *required exits*—
- (i) between *sole-occupancy units*; or
 - (ii) in a Class 9b building used as an *early childhood centre*, primary or secondary *school*.
- (b) In a Class 9a *health-care building* or Class 9c *aged care building*, *horizontal exits* may be counted as *required exits* if the path of travel from a *fire compartment* leads by one or more *horizontal exits* directly into another *fire compartment* which has at least one *required exit* which is not a *horizontal exit*.
- (c) In cases other than in (b), *horizontal exits* must not comprise more than half of the *required exits* from any part of a *storey* divided by a *fire wall*.
- (d) *Horizontal exits* must have a clear area on the side of the *fire wall* to which occupants are evacuating, to accommodate the total number of persons (calculated under **D1.13**) served by the *horizontal exit* of not less than—
- (i) 2.5 m² per patient/resident in a Class 9a *health-care building* or Class 9c *aged care building*; and
 - (ii) 0.5 m² per person in any other case.
- (e) Where a *fire compartment* is provided with only two *exits*, and one of those *exits* is a *horizontal exit*, the clear area *required* by (d) is to be of a size that accommodates all the occupants from the *fire compartment* being evacuated.
- (f) The clear area *required* by (d) must be connected to the *horizontal exit* by an unobstructed path that has at least the dimensions *required* for the *horizontal exit* and may include the area of the unobstructed path.

D1.12 Non-required stairways, ramps or escalators

An escalator, moving walkway or non-*required* non *fire-isolated stairway* or pedestrian ramp—

- (a) must not be used between *storeys* in—
- (i) a *patient care area* in a Class 9a *health-care building*; or
 - (ii) a *resident use area* in a Class 9c *aged care building*; and

Deemed-to-Satisfy Provisions

- (b) may connect any number of *storeys* if it is—
 - (i) in an *open spectator stand* or indoor sports stadium; or
 - (ii) in a *carpark* or an *atrium*; or
 - (iii) outside a building; or
 - (iv) in a Class 5 or 6 building that is sprinklered throughout, where the escalator, walkway, stairway or ramp complies with **Specification D1.12**; and
- (c) except where permitted in (b) must not connect more than—
 - (i) 3 *storeys* if each of those *storeys* is provided with a sprinkler system complying with **Specification E1.5** throughout; or
 - (ii) 2 *storeys*,

provided that in each case, those *storeys* must be consecutive, and one of those *storeys* is situated at a level at which there is direct egress to a road or *open space*; and
- (d) except where permitted in (b) or (c), must not connect, directly or indirectly, more than 2 *storeys* at any level in a Class 5, 6, 7, 8 or 9 building and those *storeys* must be consecutive.

D1.13 Number of persons accommodated

The number of persons accommodated in a *storey*, room or *mezzanine* must be determined with consideration to the purpose for which it is used and the layout of the *floor area* by—

- (a) calculating the sum of the numbers obtained by dividing the *floor area* of each part of the *storey* by the number of square metres per person listed in **Table D1.13** according to the use of that part, excluding spaces set aside for—
 - (i) lifts, stairways, ramps and escalators, corridors, hallways, lobbies and the like; and
 - (ii) service ducts and the like, *sanitary compartments* or other ancillary uses; or
- (b) reference to the seating capacity in an *assembly building* or room; or
- (c) any other suitable means of assessing its capacity.

NSW Table D1.13

Table D1.13 AREA PER PERSON ACCORDING TO USE

| Type of use | m ² per person |
|--------------------------------------|---------------------------|
| Art gallery, exhibition area, museum | 4 |
| Bar | 0.5 |
| —bar standing | 0.5 |
| —other | 1 |
| Board room | 2 |
| Boarding house | 15 |
| Cafe, church, dining room | 1 |
| <i>Carpark</i> | 30 |
| Computer room | 25 |
| Court room | 10 |
| —judicial area | 10 |

Deemed-to-Satisfy Provisions

Table D1.13 AREA PER PERSON ACCORDING TO USE— continued

| Type of use | m ² per person |
|---|---|
| —public seating | 1 |
| Dance floor | 0.5 |
| Dormitory | 5 |
| <i>Early childhood centre</i> | 4 |
| Factory— | |
| (a) machine shop, fitting shop or like place for cutting, for cutting, grading, finishing or fitting of metals or glass, except in the fabrication of structural steelwork or manufacture of vehicles or bulky products | 5 |
| (b) areas used for fabrication and processing other than those in (a) | 50 |
| (c) a space in which the layout and natural use of fixed plant or equipment determines the number of persons who will occupy the space during working hours | Area per person determined by the use of the plant or equipment |
| Gymnasium | 3 |
| Hostel, hotel, motel, guest house | 15 |
| Indoor sports stadium—arena | 10 |
| Kiosk | 1 |
| Kitchen, laboratory, laundry | 10 |
| Library | |
| —reading space | 2 |
| —storage space | 30 |
| Office, including one for typewriting or document copying | 10 |
| <i>Patient care areas</i> | 10 |
| Plant room | |
| —ventilation, electrical or other service units | 30 |
| —boilers or power plant | 50 |
| Reading room | 2 |
| Restaurant | 1 |
| <i>School</i> | |
| —general classroom | 2 |
| —multi-purpose hall | 1 |
| —staff room | 10 |
| —trade and practical area | |
| —primary | 4 |
| —secondary | As for workshop |
| Shop | |
| —space for sale of goods— | |

Deemed-to-Satisfy Provisions

Table D1.13 AREA PER PERSON ACCORDING TO USE— *continued*

| Type of use | m ² per person |
|--|---------------------------|
| (a) at a level entered direct from the open air or any lower level | 3 |
| (b) all other levels | 5 |
| Showroom —display area, covered mall or arcade | 5 |
| Skating rink, based on rink area | 1.5 |
| Spectator stand, audience viewing area: | |
| —standing viewing area | 0.3 |
| —removable seating | 1 |
| —fixed seating (number of seats) | |
| —bench seating (450 mm/person) | |
| Storage space | 30 |
| <i>Swimming pool</i> , based on pool area | 1.5 |
| Switch room, transformer room | 30 |
| Telephone exchange | 30 |
| —private | |
| Theatre and public hall | 1 |
| Theatre dressing room | 4 |
| Transport terminal | 2 |
| Workshop | |
| —for maintenance staff | 30 |
| —for manufacturing processes | As for Factory |

Note: Bar standing is the area used by standing patrons and extends not less than 1.5m wide from the outside edge of the bar top for the length of the serving area of the bar.

D1.14 Measurement of distances

The nearest part of an *exit* means in the case of—

- (a) a *fire-isolated stairway*, *fire-isolated passageway*, or *fire-isolated ramp*, the nearest part of the doorway providing access to them; and
- (b) a non-*fire-isolated stairway*, the nearest part of the nearest riser; and
- (c) a non-*fire-isolated ramp*, the nearest part of the junction of the floor of the ramp and the floor of the *storey*; and
- (d) a doorway opening to a road or *open space*, the nearest part of the doorway; and
- (e) a *horizontal exit*, the nearest part of the doorway.

D1.15 Method of measurement

The following rules apply:

Deemed-to-Satisfy Provisions

- (a) In the case of a room that is not a *sole-occupancy unit* in a Class 2 or 3 building or Class 4 part of a building, the distance includes the straight-line measurement from any point on the floor of the room to the nearest part of a doorway leading from it, together with the distance from that part of the doorway to the single *required exit* or point from which travel in different directions to 2 *required exits* is available.
- (b) Subject to (d), the distance from the doorway of a *sole-occupancy unit* in a Class 2 or 3 building or a Class 4 part of a building is measured in a straight line to the nearest part of the *required* single *exit* or point from which travel in different directions to 2 *required exits* is available.
- (c) Subject to (d), the distance between *exits* is measured in a straight line between the nearest parts of those *exits*.
- (d) Only the shortest distance is taken along a corridor, hallway, external balcony or other path of travel that curves or changes direction.
- (e) If more than one corridor, hallway, or other internal path of travel connects *required exits*, the measurement is along the path of travel through the point at which travel in different directions to those *exits* is available.
- (f) If a wall (including a demountable *internal wall*) that does not bound—
 - (i) a room; or
 - (ii) a corridor, hallway or the like,
 causes a change of direction in proceeding to a *required exit*, the distance is measured along the path of travel past that wall.
- (g) If permanent fixed seating is provided, the distance is measured along the path of travel between the rows of seats.
- (h) In the case of a non-*fire-isolated stairway* or non-*fire-isolated ramp*, the distance is measured along a line connecting the nosings of the treads, or along the slope of the ramp, together with the distance connecting those lines across any intermediate landings.

D1.16 Plant rooms, lift machine rooms and electricity network substations: Concession

- (a) A ladder may be used in lieu of a stairway to provide egress from—
 - (i) a plant room with a *floor area* of not more than 100 m²; or
 - (ii) all but one point of egress from a plant room, a lift machine room or a Class 8 *electricity network substation* with a *floor area* of not more than 200 m².
- (b) A ladder permitted under (a)—
 - (i) may form part of an *exit* provided that in the case of a *fire-isolated stairway* it is contained within the *shaft*; or
 - (ii) may discharge within a *storey* in which case it must be considered as forming part of the path of travel; and
 - (iii) for a plant room or a Class 8 *electricity network substation*, must comply with AS 1657; and
 - (iv) for a lift machine room, where access is provided from within a machine room to a secondary floor, a fixed rung type ladder complying with AS 1657 may be used, provided that—

Deemed-to-Satisfy Provisions

- (A) the height between the floors is not more than 2800 mm; and
- (B) the ladder is inclined at an angle to the horizontal not less than 65 degrees nor more than 75 degrees; and
- (C) the distance between the front face of the ladder and any adjacent obstruction is not less than—
 - (aa) 960 mm, where the ladder is inclined 65 degrees to the horizontal; or
 - (bb) 760 mm, where the ladder is inclined 75 degrees to the horizontal; or
 - (cc) a distance that is determined by interpolating the values in (aa) and (bb), where the ladder is inclined at any angle between 65 degrees and 75 degrees to the horizontal; and
- (D) a clear space not less than 600 mm exists between the foot of the ladder and any equipment.

D1.17 Access to lift pits

Access to lift pits must—

- (a) where the pit depth is not more than 3 m, be through the lowest landing doors; or
- (b) where the pit depth is more than 3 m, be provided through an access doorway complying with the following:
 - (i) In lieu of **D1.6**, the doorway must be level with the pit floor and not be less than 600 mm wide by 1980 mm high clear opening, which may be reduced to 1500 mm where it is necessary to comply with (ii).
 - (ii) No part of the lift car or platform must encroach on the pit doorway entrance when the car is on a fully compressed buffer.
 - (iii) Access to the doorway must be by a stairway complying with AS 1657.
 - (iv) In lieu of **D2.21**, doors fitted to the doorway must be—
 - (A) of the horizontal sliding or outwards opening hinged type; and
 - (B) self-closing and self-locking from the outside; and
 - (C) marked on the landing side with the letters not less than 35 mm high:
“DANGER LIFTWELL – ENTRY OF UNAUTHORIZED PERSONS PROHIBITED – KEEP CLEAR AT ALL TIMES”

ACT D1.101

PART D2

CONSTRUCTION OF EXITS

Deemed-to-Satisfy Provisions

D2.0 Deemed-to-Satisfy Provisions

- (a) Where a *Building Solution* is proposed to comply with the *Deemed-to-Satisfy Provisions*, *Performance Requirements DP1 to DP6, DP8 and DP9* are satisfied by complying with—
- (i) **D1.1 to D1.16, D2.1 to D2.24 and D3.1 to D3.12**; and
 - (ii) in a building containing an *atrium*, **Part G3**; and
 - (iii) for theatres, *stages* and public halls, **Part H1**; and
 - (iv) for public transport buildings, **Part H2**.
- (b) Where a *Building Solution* is proposed as an *Alternative Solution* to the *Deemed-to-Satisfy Provisions* of—
- (i) **D1.1 to D1.16, D2.1 to D2.24 and D3.1 to D3.12**; and
 - (ii) in a building containing an *atrium*, **Part G3**; and
 - (iii) for theatres, *stages* and public halls, **Part H1**; and
 - (iv) for public transport buildings, **Part H2**,
- the relevant *Performance Requirements* must be determined in accordance with **A0.10**.

D2.1 Application of Part

Except for—

- (a) **D2.13, D2.14(a), D2.16, D2.17(d), D2.17(e)** and **D2.21**, the *Deemed-to-Satisfy Provisions* of this Part do not apply to the internal parts of a *sole-occupancy unit* in a Class 3 building; and
- (b) **D2.13, D2.14(a), D2.16, D2.17(d), D2.17(e)** and **D2.18**, the *Deemed-to-Satisfy Provisions* of this Part do not apply to the internal parts of a *sole-occupancy unit* in a Class 2 building or Class 4 part of a building.

NSW D2.1(c)

D2.2 Fire-isolated stairways and ramps

A stairway or ramp (including any landings) that is *required* to be within a *fire-resisting shaft* must be constructed—

- (a) of *non-combustible* materials; and
- (b) so that if there is local failure it will not cause structural damage to, or impair the fire-resistance of, the *shaft*.

D2.3 Non-fire-isolated stairways and ramps

In a building having a *rise in storeys* of more than 2, *required* stairs and ramps (including landings and any supporting building elements) which are not *required* to be within a *fire-resisting shaft*, must be constructed according to **D2.2**, or only of—

Deemed-to-Satisfy Provisions

- (a) reinforced or prestressed concrete; or
- (b) steel in no part less than 6 mm thick; or
- (c) timber that—
 - (i) has a finished thickness of not less than 44 mm; and
 - (ii) has an average density of not less than 800 kg/m³ at a moisture content of 12%; and
 - (iii) has not been joined by means of glue unless it has been laminated and glued with resorcinol formaldehyde or resorcinol phenol formaldehyde glue.

D2.4 Separation of rising and descending stair flights

If a stairway serving as an *exit* is *required* to be fire-isolated—

- (a) there must be no direct connection between—
 - (i) a *flight* rising from a *storey* below the lowest level of access to a road or *open space*; and
 - (ii) a *flight* descending from a *storey* above that level; and
- (b) any construction that separates or is common to the rising and descending *flights* must be—
 - (i) *non-combustible*; and
 - (ii) smoke proof in accordance with **Clause 2 of Specification C2.5**.

D2.5 Open access ramps and balconies

Where an open access ramp or balcony is provided to meet the smoke hazard management requirements of **Table E2.2a**, it must—

- (a) have ventilation openings to the outside air which—
 - (i) have a total unobstructed area not less than the *floor area* of the ramp or balcony; and
 - (ii) are evenly distributed along the open sides of the ramp or balcony; and
- (b) not be enclosed on its open sides above a height of 1 m except by an open grille or the like having a free air space of not less than 75% of its area.

D2.6 Smoke lobbies

A smoke lobby *required* by **D1.7** must—

- (a) have a *floor area* not less than 6 m²; and
- (b) be separated from the occupied areas in the *storey* by walls which are impervious to smoke, and—
 - (i) have an FRL of not less than 60/60/– (which may be fire-protective grade plasterboard, gypsum block with set plaster, face brickwork, glass blocks or glazing); and
 - (ii) extend from slab to slab, or to the underside of a ceiling with a *resistance to the incipient spread of fire* of 60 minutes which covers the lobby; and

Deemed-to-Satisfy Provisions

- (iii) any construction joints between the top of the walls and the floor slab, roof or ceiling must be smoke sealed with intumescent putty or other suitable material; and
- (c) at any opening from the occupied areas, have smoke doors complying with **Clause 3 of Specification C3.4** except that the smoke sensing device need only be located on the approach side of the opening; and
- (d) be pressurised as part of the *exit* if the *exit* is *required* to be pressurised under **E2.2**.

D2.7 Installations in exits and paths of travel

- (a) Access to service *shafts* and services other than to fire-fighting or detection equipment as permitted in the *Deemed-to-Satisfy Provisions* of **Section E**, must not be provided from a *fire-isolated stairway*, *fire-isolated passageway* or *fire-isolated ramp*.
- (b) An opening to any chute or duct intended to convey hot products of combustion from a boiler, incinerator, fireplace or the like, must not be located in any part of a *required exit* or any corridor, hallway, lobby or the like leading to a *required exit*.
- (c) Gas or other fuel services must not be installed in a *required exit*.
- (d) Services or equipment comprising—
 - (i) electricity meters, distribution boards or ducts; or
 - (ii) central telecommunications distribution boards or equipment; or
 - (iii) electrical motors or other motors serving equipment in the building,
 may be installed in—
 - (iv) a *required exit*, except for fire-isolated *exits* specified in (a); or
 - (v) in any corridor, hallway, lobby or the like leading to a *required exit*,
 if the services or equipment are enclosed by *non-combustible* construction or a *fire-protective covering* with doorways or openings suitably sealed against smoke spreading from the enclosure.
- (e) Electrical wiring may be installed in a fire-isolated *exit* if the wiring is associated with—
 - (i) a lighting, detection, or pressurisation system serving the *exit*; or
 - (ii) a security, surveillance or management system serving the *exit*; or
 - (iii) an intercommunication system or an audible or visual alarm system in accordance with **D2.22**; or
 - (iv) the monitoring of hydrant or sprinkler isolating valves.

D2.8 Enclosure of space under stairs and ramps

- (a) **Fire-isolated stairways and ramps** — If the space below a *required fire-isolated stairway* or *fire-isolated ramp* is within the fire-isolated *shaft*, it must not be enclosed to form a cupboard or similar enclosed space.
- (b) **Non fire-isolated stairways and ramps** — The space below a *required non fire-isolated stairway* (including an external stairway) or non *fire-isolated ramp* must not be enclosed to form a cupboard or other enclosed space unless—
 - (i) the enclosing walls and ceilings have an FRL of not less than 60/60/60; and

Deemed-to-Satisfy Provisions

- (ii) any access doorway to the enclosed space is fitted with a *self-closing* –/60/30 fire door.

D2.9 Width of required stairways and ramps

A *required* stairway or ramp that exceeds 2 m in width is counted as having a width of only 2 m unless it is divided by a handrail, balustrade or other barrier continuous between landings and each division has a width of not more than 2 m.

D2.10 Pedestrian ramps

- (a) A *fire-isolated ramp* may be substituted for a *fire-isolated stairway* if the construction enclosing the *ramp* and the width and ceiling height comply with the requirements for a *fire-isolated stairway*.
- (b) A ramp serving as a *required exit* must—
 - (i) where the ramp is also serving as an *accessible* ramp under **Part D3**, be in accordance with AS 1428.1; or
 - (ii) in any other case, have a gradient not steeper than 1:8.
- (c) The floor surface of a ramp must have a non-slip finish.

D2.11 Fire-isolated passageways

- (a) The enclosing construction of a *fire-isolated passageway* must have an FRL when tested for a fire outside the passageway in another part of the building of—
 - (i) if the passageway discharges from a *fire-isolated stairway* or *ramp* — not less than that *required* for the stairway or ramp *shaft*; or
 - (ii) in any other case — not less than 60/60/60.
- (b) Notwithstanding **(a)(ii)**, the top construction of a *fire-isolated passageway* need not have an FRL if the walls of the *fire-isolated passageway* extend to the underside of—
 - (i) a *non-combustible* roof covering; or
 - (ii) a ceiling having a *resistance to the incipient spread of fire* of not less than 60 minutes separating the roof space or ceiling space in all areas surrounding the passageway within the *fire compartment*.

D2.12 Roof as open space

If an *exit* discharges to a roof of a building, the roof must—

- (a) have an FRL of not less than 120/120/120; and
- (b) not have any rooflights or other openings within 3 m of the path of travel of persons using the *exit* to reach a road or *open space*.

D2.13 Goings and risers

- (a) A stairway must have—
 - (i) not more than 18 nor less than 2 risers in each *flight*; and

Deemed-to-Satisfy Provisions

- (ii) except as permitted by (b) and (c), going (G), riser (R) and quantity (2R + G) in accordance with Table D2.13; and
- (iii) except as permitted by (b) and (c), goings and risers that are constant throughout in one *flight*; and
- (iv) risers which do not have any openings that would allow a 125 mm sphere to pass through between the treads; and
- (v) treads which have a non-slip finish or an adequate non-skid strip near the edge of the nosings; and
- (vi) treads of solid construction (not mesh or other perforated material) if the stairway is more than 10 m high or connects more than 3 *storeys*; and
- (vii) in a Class 9b building, not more than 36 risers in consecutive *flights* without a change in direction of at least 30°; and
- (viii) in the case of a *required* stairway, no winders in lieu of a landing.

NSW D2.13(a)(ix),(x),(xi)

- (b) In the case of a non-*required* stairway—
 - (i) the stairway must have—
 - (A) not more than 3 winders in lieu of a quarter landing; and
 - (B) not more than 6 winders in lieu of a half landing; and
 - (ii) the going of all straight treads must be constant throughout the same *flight*; and
 - (iii) the going of all winders in lieu of a quarter or half landing may vary from the going of the straight treads within the same *flight* provided that the going of all such winders is constant.
- (c) Where a stairway discharges to a sloping public walkway or public road—
 - (i) the riser (R) may be reduced to account for the slope of the walkway or road; and
 - (ii) the quantity (2R+G) may vary at that location.

Deemed-to-Satisfy Provisions

Table D2.13 RISER AND GOING DIMENSIONS (mm)

| | Riser (R) | | Going (G) ^(b) | | Quantity (2R+G) | |
|----------------------------------|-----------|-----|--------------------------|-----|-----------------|-----|
| | Max | Min | Max | Min | Max | Min |
| Public stairways | 190 | 115 | 355 | 250 | 700 | 550 |
| Private stairways ^(a) | 190 | 115 | 355 | 240 | 700 | 550 |

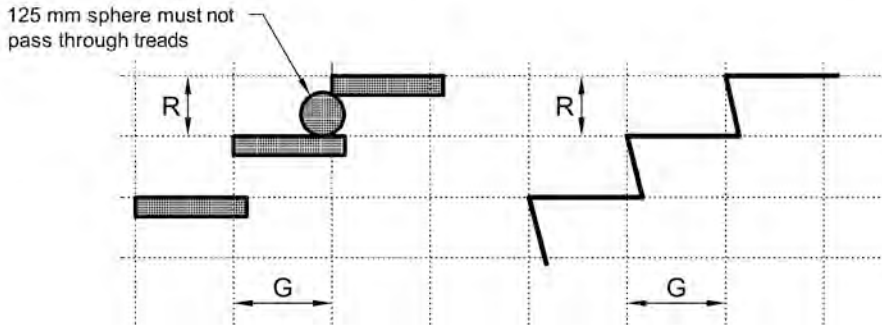

Notes:

1. Private stairways are—
 - (a) stairways in a *sole-occupancy unit* in a Class 2 building or Class 4 part of a building; and
 - (b) in any building, stairways which are not part of a *required exit* and to which the public do not normally have access.
2. The going in tapered treads (except winders in lieu of a quarter or half landing) in a curved or spiral stairway is measured—
 - (a) 270 mm in from the outer side of the unobstructed width of the stairway if the stairway is less than 1 m wide (applicable to a non-*required* stairway only); and
 - (b) 270 mm from each side of the unobstructed width of the stairway if the stairway is 1 m wide or more.

D2.14 Landings

In a stairway—

- (a) landings having a maximum gradient of 1:50 may be used in any building to limit the number of risers in each *flight* and each landing must—
 - (i) be not less than 750 mm long, and where this involves a change in direction, the length is measured 500 mm from the inside edge of the landing; and
 - (ii) have a non-slip finish throughout or an adequate non-skid strip near the edge of the landing where it leads to a *flight* below; and
- (b) in a Class 9a building—
 - (i) the area of any landing must be sufficient to move a stretcher, 2 m long and 600 mm wide, at a gradient not more than the gradient of the stairs, with at least one end of the stretcher on the landing while changing direction between *flights*; or

Deemed-to-Satisfy Provisions

- (ii) the stair must have a change of direction of 180°, and the landing a clear width of not less than 1.6 m and a clear length of not less than 2.7 m.

D2.15 Thresholds

The threshold of a doorway must not incorporate a step or ramp at any point closer to the doorway than the width of the door leaf unless—

- (a) in *patient care areas* in a Class 9a *health-care building*, the door sill is not more than 25 mm above the finished floor level to which the doorway opens; or
- (b) in a Class 9c *aged care building*, a ramp is provided with a maximum gradient of 1:8 for a maximum height of 25 mm over the threshold; or

NSW D2.15(d),(e)

- (c) in a building *required* to be *accessible* by **Part D3**, the doorway—
 - (i) opens to a road or *open space*; and
 - (ii) is provided with a threshold ramp or step ramp in accordance with AS 1428.1; or
- (d) in other cases—
 - (i) the doorway opens to a road or *open space*, external stair landing or external balcony; and
 - (ii) the door sill is not more than 190 mm above the finished surface of the ground, balcony, or the like, to which the doorway opens.

D2.16 Balustrades or other barriers

- (a) A continuous balustrade or other barrier, except for a barrier provided to an openable window covered by **D2.24**, must be provided along the side of any roof to which public access is provided, any stairway or ramp, any floor, corridor, hallway, balcony, deck, verandah, *mezzanine*, access bridge or the like and along the side of any delineated path of access to a building, if—
 - (i) it is not bounded by a wall; and
 - (ii) its level above the surface beneath, is more than 1 m.
- (b) The requirements of (a) do not apply to—
 - (i) the perimeter of a *stage*, rigging loft, loading dock or the like; or
 - (ii) areas referred to in **D2.18**; or
 - (iii) a retaining wall unless the retaining wall forms part of, or is directly associated with a delineated path of access to a building from the road, or a delineated path of access between buildings.
- (c) A balustrade or other barrier in—
 - (i) *fire-isolated stairways*, *fire-isolated ramps* and other areas used primarily for emergency purposes, excluding external stairways and external ramps; and
 - (ii) Class 7 (other than *carparks*) and Class 8 buildings and parts of buildings containing those classes,

must comply with (g) and (h)(i).

Deemed-to-Satisfy Provisions

- (d) A balustrade or other barrier in stairways and ramps, other than those covered in (c), must comply with (g) and (h)(ii).
 - (e) A balustrade or other barrier along the side of a horizontal or near horizontal surface such as a—
 - (i) roof to which public access is provided and any path of access to a building; and
 - (ii) floor, corridor, hallway, balcony, verandah, *mezzanine*, access bridge or the like, must comply with (g) and (h)(ii).
 - (f) A balustrade or other barrier in front of fixed seating on a *mezzanine* or balcony within an auditorium in a Class 9b building must comply with (g)(iv) and (h)(ii).
 - (g) The height of a balustrade or other barrier must be constructed in accordance with the following:
 - (i) The height is not less than 865 mm above the nosings of the stair treads or the floor of a ramp or other path of travel with a gradient not less than 1:20.
 - (ii) The height is not less than—
 - (A) 1 m above the floor of any access path, balcony, landing or the like where the path of travel has a gradient less than 1:20; or
 - (B) 865 mm above the floor of a landing to a stair or ramp where the balustrade or other barrier is provided along the inside edge of the landing and does not exceed a length of 500 mm.
 - (iii) A transition zone may be incorporated where the balustrade or other barrier height changes from 865 mm on the stair *flight* or ramp to 1 m at the landing.
- NSW D2.16(g)(iv) and (v)*
- (iv) For a balustrade or other barrier provided under (f), the height above the floor must be not less than—
 - (A) 1 m; or
 - (B) 700 mm and a horizontal projection extends not less than 1 m outwards from the top of the balustrade.
 - (h) Openings in a balustrade or other barrier must be constructed in accordance with the following:
 - (i) For a balustrade or other barrier provided under (c)—
 - (A) the balustrade openings or the width of any other opening (including any openable window or panel) must not be more than 300 mm; or
 - (B) where rails are used, a rail must be provided which does not permit a 150 mm sphere to pass through the opening between the nosing line of the stair treads and the rail or between the rail and the floor of the landing, balcony or the like and the opening between rails must not be more than 460 mm.
 - (ii) For a balustrade or other barrier other than those provided under (c)—
 - (A) any opening does not permit a 125 mm sphere to pass through it and for stairs, the opening is measured above the nosing line of the stair treads; and

Deemed-to-Satisfy Provisions

- (B) for floors more than 4 m above the surface beneath, any horizontal or near horizontal elements between 150 mm and 760 mm above the floor must not facilitate climbing.
- (i) A wire balustrade must be constructed in accordance with the following and is deemed to meet the requirements of **(h)(ii)(A)**:
 - (i) For horizontal wire systems—
 - (A) when measured with a strain indicator, it must be in accordance with the tension values in **Table D2.16a**; or
 - (B) must not exceed the maximum deflections in **Table D2.16c**.
 - (ii) For non-continuous vertical wire systems, when measured with a strain indicator, must be in accordance with the tension values in **Table D2.16a** (see Note 4).
 - (iii) For continuous vertical or continuous near vertical sloped wire systems—
 - (A) must have wires of no more than 2.5 mm diameter with a lay of 7x7 or 7x19 construction; and
 - (B) changes in direction at support rails must pass around a pulley block without causing permanent deformation to the wire; and
 - (C) must have supporting rails, constructed with a spacing of not more than 900 mm, of a material that does not allow deflection that would decrease the tension of the wire under load; and
 - (D) when the wire tension is measured with a strain indicator, it must be in accordance with the tension values in **Table D2.16b** and measured in the furthest span from the tensioning device.

TABLE D2.16a WIRE BALUSTRADE CONSTRUCTION – REQUIRED TENSION FOR STAINLESS STEEL HORIZONTAL WIRES

| | | | Clear distance between posts (mm) | | | | | | | | |
|----------------|------|-------------------|--|------|------|------|------|------|------|------|------|
| | | | 600 | 800 | 900 | 1000 | 1200 | 1500 | 1800 | 2000 | 2500 |
| Wire dia. (mm) | Lay | Wire spacing (mm) | Minimum <i>required</i> tension in Newtons (N) | | | | | | | | |
| 2.5 | 7x7 | 60 | 55 | 190 | 263 | 415 | 478 | 823 | 1080 | 1139 | X |
| | | 80 | 382 | 630 | 730 | 824 | 1025 | 1288 | X | X | X |
| | | 100 | 869 | 1218 | 1368 | X | X | X | X | X | X |
| 2.5 | 1x19 | 60 | 35 | 218 | 310 | 402 | 585 | 810 | 1125 | 1325 | X |
| | | 80 | 420 | 630 | 735 | 840 | 1050 | 1400 | 1750 | X | X |
| | | 100 | 1140 | 1565 | X | X | X | X | X | X | X |
| 3.0 | 7x7 | 60 | 15 | 178 | 270 | 314 | 506 | 660 | 965 | 1168 | 1491 |
| | | 80 | 250 | 413 | 500 | 741 | 818 | 1083 | 1370 | 1565 | X |
| | | 100 | 865 | 1278 | 1390 | 1639 | X | X | X | X | X |

Deemed-to-Satisfy Provisions

TABLE D2.16a WIRE BALUSTRADE CONSTRUCTION – REQUIRED TENSION FOR STAINLESS STEEL HORIZONTAL WIRES – continued

| | | | | | | | | | | | |
|------------|-------------|------------|------|------|------|------|------|------|------|------|------|
| 3.0 | 1x19 | 60 | 25 | 183 | 261 | 340 | 520 | 790 | 1025 | 1180 | X |
| | | 80 | 325 | 555 | 670 | 785 | 1015 | 1330 | 1725 | 1980 | X |
| | | 100 | 1090 | 1500 | 1705 | 1910 | X | X | X | X | X |
| 4.0 | 7x7 | 60 | 5 | 73 | 97 | 122 | 235 | 440 | 664 | 813 | 1178 |
| | | 80 | 196 | 422 | 480 | 524 | 760 | 1100 | 1358 | 1530 | 2130 |
| | | 100 | 835 | 1182 | 1360 | 1528 | 1837 | 2381 | 2811 | 3098 | X |
| 4.0 | 1x19 | 60 | 5 | 5 | 10 | 15 | 20 | 147 | 593 | 890 | 1280 |
| | | 80 | 30 | 192 | 300 | 415 | 593 | 1105 | 1303 | 1435 | 1844 |
| | | 100 | 853 | 1308 | 1487 | 1610 | 2048 | 2608 | 3094 | 3418 | 3849 |
| 4.0 | 7x19 | 60 | 155 | 290 | 358 | 425 | 599 | 860 | 1080 | 1285 | 1540 |
| | | 80 | 394 | 654 | 785 | 915 | 1143 | 1485 | 1860 | 2105 | 2615 |
| | | 100 | 1038 | 1412 | 1598 | 1785 | 2165 | 2735 | X | X | X |

Notes:

1. Lay = number of strands by the number of individual wires in each strand. For example a lay of 7x19 consists of 7 strands with 19 individual wires in each strand.
2. Where a change of direction is made in a run of wire, the tensioning device is to be placed at the end of the longest span.
3. If a 3.2 mm wire is used the tension figures for 3.0 mm wire are applied.
4. This table may also be used for a set of non-continuous (single) vertical wires forming a balustrade using the appropriate clear distance between posts as the vertical clear distance between the rails.
5. X = Not allowed because the required tension would exceed the safe load of the wire.
6. Tension measured with a strain indicator.

TABLE D2.16b CONTINUOUS WIRE BALUSTRADE CONSTRUCTION – REQUIRED TENSION FOR VERTICAL OR NEAR VERTICAL STAINLESS STEEL WIRES

| Wire dia. (mm) | Lay | Widest spacing between wires (mm) | Maximum clear spacing between rails (mm) |
|-------------------|-------------|--------------------------------------|--|
| | | | 900 |
| | | | <i>Required</i> tension in Newtons (N) |
| 2.5 | 7x19 | 80 | 145 |
| | | 100 | 310 |
| | | 110 | 610 |
| 2.5 | 7x7 | 80 | 130 |
| | | 100 | 280 |
| | | 110 | 500 |

Deemed-to-Satisfy Provisions

TABLE D2.16b CONTINUOUS WIRE BALUSTRADE CONSTRUCTION – REQUIRED TENSION FOR VERTICAL OR NEAR VERTICAL STAINLESS STEEL WIRES— continued

| | |
|---------------|--|
| Notes: | |
| 1. | Lay = number of strands by the number of individual wires in each strand. For example a lay of 7x19 consists of 7 strands with 19 individual wires in each strand. |
| 2. | Vertical wires require two pulley blocks to each 180 ^o change of direction in the wire. |
| 3. | Near vertical wires may only require one pulley block for each change of direction. |
| 4. | Tension measured with a strain indicator. |
| 5. | The table only includes 7x7 and 7x19 wires due to other wires not having sufficient flexibility to make the necessary turns. |

TABLE D2.16c WIRE BALUSTRADE CONSTRUCTION – MAXIMUM PERMISSIBLE DEFLECTION FOR STAINLESS STEEL WIRES

| | | Clear distance between posts (mm) | | | | | |
|----------------|-------------------|---|-----|------|------|------|------|
| | | 600 | 900 | 1200 | 1500 | 1800 | 2000 |
| Wire dia. (mm) | Wire spacing (mm) | Maximum permissible deflection of each wire in mm when a 2 kg mass is suspended at mid span | | | | | |
| 2.5 | 60 | 17 | 11 | 9 | 8 | 8 | 8 |
| | 80 | 7 | 5 | 5 | 5 | X | X |
| 3.0 | 60 | 19 | 13 | 8 | 7 | 7 | 7 |
| | 80 | 8 | 6 | 6 | 5 | 5 | 5 |
| 4.0 | 60 | 18 | 12 | 8 | 8 | 7 | 7 |
| | 80 | 8 | 6 | 4 | 4 | 4 | 4 |

| | |
|---------------|---|
| Notes: | |
| 1. | Where a change of direction is made in a run of wire the 2 kg mass must be placed at the middle of the longest span. |
| 2. | If a 3.2 mm wire is used the deflection figures for 3.0 mm wire are applied. |
| 3. | This table may also be used for a set of non-continuous (single) vertical wires forming a balustrade using the appropriate clear distance between posts as the vertical clear distance between the rails. The deflection (offset) is measured by hooking a standard spring scale to the mid span of each wire and pulling it horizontally until a force of 19.6 N is applied. |
| 4. | X = Not allowed because the required tension would exceed the safe load of the wire. |
| 5. | This table has been limited to 60 mm and 80 mm spaces for 2.5 mm, 3 mm and 4 mm diameter wires because the required wire tensions at greater spacings would require the tension to be beyond the wire safe load limit, or the allowed deflection would be impractical to measure. |

Deemed-to-Satisfy Provisions

D2.17 Handrails

- (a) Except for handrails referred to in **D2.18**, handrails must be—
- (i) located along at least one side of the ramp or *flight*; and
 - (ii) located along each side if the total width of the stairway or ramp is 2 m or more; and
 - (iii) in a Class 9b building used as a primary *school*—
 - (A) have one handrail fixed at a height of not less than 865 mm; and
 - (B) have a second handrail fixed at a height between 665 mm and 750 mm, measured above the nosings of stair treads and the floor surface of the ramp, landing or the like; and
 - (iv) in any other case, fixed at a height of not less than 865 mm measured above the nosings of stair treads and the floor surface of the ramp, landing, or the like; and
 - (v) continuous between stair *flight* landings and have no obstruction on or above them that will tend to break a hand-hold; and
 - (vi) in a *required exit* serving an area *required* to be *accessible*, designed and constructed to comply with clause 12 of AS 1428.1, except that clause 12(d) does not apply to a handrail *required* by **(a)(iii)(B)**.
- (b) Handrails—
- (i) in a Class 9a *health-care building* must be provided along at least one side of every passageway or corridor used by patients, and must be—
 - (A) fixed not less than 50 mm clear of the wall; and
 - (B) where practicable, continuous for their full length.
 - (ii) in a Class 9c *aged care building* must be provided along both sides of every passageway or corridor used by residents, and must be—
 - (A) fixed not less than 50 mm clear of the wall; and
 - (B) where practicable, continuous for their full length.
- (c) Handrails *required* to assist people with a disability must be provided in accordance with **D3.3**.
- (d) Handrails to a stairway or ramp within a *sole-occupancy unit* in a Class 2 or 3 building or Class 4 part of a building must—
- (i) be located along at least one side of the *flight* or ramp; and
 - (ii) be located along the full length of the *flight* or ramp, except in the case where a handrail is associated with a balustrade, the handrail may terminate where the balustrade terminates; and
 - (iii) have the top surface of the handrail not less than 865 mm vertically above the nosings of the stair treads or the floor surface of the ramp; and
 - (iv) have no obstruction on or above them that will tend to break a handhold, except for newel posts, ball type stanchions, or the like.
- (e) The requirements of **(d)** do not apply to—

Deemed-to-Satisfy Provisions

- (i) handrails referred to in **D2.18**; or
- (ii) a stairway or ramp providing a change in elevation of less than 1 m; or
- (iii) a landing; or
- (iv) a winder where a newel post is installed to provide a handhold.

D2.18 Fixed platforms, walkways, stairways and ladders

A fixed platform, walkway, stairway, ladder and any going and riser, landing, handrail, balustrade or other barrier attached thereto may comply with AS 1657 in lieu of **D2.13**, **D2.14**, **D2.16** and **D2.17** if it only serves:

- (a) machinery rooms, boiler houses, lift-machine rooms, plant-rooms, and the like; or
- (b) non-*habitable rooms*, such as attics, storerooms and the like that are not used on a frequent or daily basis in the internal parts of a *sole-occupancy unit* in a Class 2 building or Class 4 part of a building.

D2.19 Doorways and doors

- (a) A doorway in a *resident use area* of a Class 9c *aged care building* must not be fitted with—
 - (i) a sliding fire door; or
 - (ii) a sliding smoke door; or
 - (iii) a revolving door; or
 - (iv) a roller shutter door; or
 - (v) a tilt-up door.
- (b) A doorway serving as a *required exit* or forming part of a *required exit*, or a doorway in a *patient care area* of a Class 9a *health-care building*—
 - (i) must not be fitted with a revolving door; and
 - (ii) must not be fitted with a roller shutter or tilt-up door unless—
 - (A) it serves a Class 6, 7 or 8 building or part with a *floor area* not more than 200 m²; and
 - (B) the doorway is the only *required exit* from the building or part; and
 - (C) it is held in the open position while the building or part is lawfully occupied; and
 - (iii) must not be fitted with a sliding door unless—
 - (A) it leads directly to a road or *open space*; and
 - (B) the door is able to be opened manually under a force of not more than 110 N; and
 - (iv) if fitted with a door which is power-operated—
 - (A) it must be able to be opened manually under a force of not more than 110 N if there is a malfunction or failure of the power source; and

Deemed-to-Satisfy Provisions

- (B) if it leads directly to a road or *open space* it must open automatically if there is a power failure to the door or on the activation of a fire or smoke alarm anywhere in the *fire compartment* served by the door.

NSW D2.19(b)(v)

- (c) A power-operated door in a path of travel to a *required exit*, except for a door in a *patient care area* of a Class 9a *health-care building* as provided in (b), must be able to be opened manually under a force of not more than 110 N if there is a malfunction or failure of the power source.

D2.20 Swinging doors

A swinging door in a *required exit* or forming part of a *required exit*—

- (a) must not encroach—
 - (i) at any part of its swing by more than 500 mm on the *required* width (including any landings) of a *required*—
 - (A) stairway; or
 - (B) ramp; or
 - (C) passageway,
 if it is likely to impede the path of travel of the people already using the *exit*; and
 - (ii) when fully open, by more than 100 mm on the *required* width of the *required exit*, and

the measurement of encroachment in each case is to include door handles or other furniture or attachments to the door; and
- (b) must swing in the direction of egress unless—
 - (i) it serves a building or part with a *floor area* not more than 200 m², it is the only *required exit* from the building or part and it is fitted with a device for holding it in the open position; or
 - (ii) it serves a *sanitary compartment* or airlock (in which case it may swing in either direction); and
- (c) must not otherwise impede the path or direction of egress.

D2.21 Operation of latch

Vic D2.21(a)

- (a) A door in a *required exit*, forming part of a *required exit* or in the path of travel to a *required exit* must be readily openable without a key from the side that faces a person seeking egress, by—
 - (i) a single hand downward action on a single device which is located between 900 mm and 1.1 m from the floor and if serving an area *required* to be *accessible* by **Part D3**—
 - (A) be such that the hand of a person who cannot grip will not slip from the handle during the operation of the latch; and

Deemed-to-Satisfy Provisions

- (B) have a clearance between the handle and the back plate or door face at the centre grip section of the handle of not less than 35 mm and not more than 45 mm; or
 - (ii) a single hand pushing action on a single device which is located between 900 mm and 1.2 m from the floor.
- (b) The requirements of (a) do not apply to a door that—
- (i) serves a vault, strong-room, *sanitary compartment*, or the like; or
 - (ii) serves only, or is within—
 - (A) a *sole-occupancy unit* in a Class 2 building or a Class 4 part of a building; or
 - (B) a *sole-occupancy unit* in a Class 3 building (other than an entry door to a *sole-occupancy unit* of a boarding house, guest house, hostel, lodging house or backpacker accommodation); or
 - (C) a *sole-occupancy unit* with a *floor area* not more than 200 m² in a Class 5, 6, 7 or 8 building; or
 - (D) a space which is otherwise inaccessible to persons at all times when the door is locked; or
 - (iii) serves the secure parts of a bank, *detention centre*, mental health facility, *early childhood centre* or the like and it can be immediately unlocked—
 - (A) by operating a fail-safe control switch, not contained within a protective enclosure, to actuate a device to unlock the door; or
 - (B) by hand by a person or persons, specifically nominated by the owner, properly instructed as to the duties and responsibilities involved and available at all times when the building is lawfully occupied so that persons in the building or part may immediately escape if there is a fire; or
 - (iv) is fitted with a fail-safe device which *automatically* unlocks the door upon the activation of any sprinkler system complying with **Specification E1.5** or smoke, or any other detector system deemed suitable in accordance with AS 1670.1 installed throughout the building; or
 - (v) is in a Class 9a or 9c building and—
 - (A) is one leaf of a two-leaf door complying with **D1.6(f)(i)** or **D1.6(f)(iv)** provided that it is not held closed by a locking mechanism and is readily openable; and
 - (B) the door is not *required* to be a fire door or smoke door.
- (c) The requirements of (a) do not apply in a Class 9b building (other than a *school*, an *early childhood centre* or a building used for religious purposes) to a door in a *required exit*, forming part of a *required exit* or in the path of travel to a *required exit* serving a *storey* or room accommodating more than 100 persons, determined in accordance with **D1.13**, in which case it must be readily openable—
- (i) without a key from the side that faces a person seeking egress; and
 - (ii) by a single hand pushing action on a single device such as a panic bar located between 900 mm and 1.2 m from the floor; and

Deemed-to-Satisfy Provisions

- (iii) where a two-leaf door is fitted, the provisions of (i) and (ii) need only apply to one door leaf if the appropriate requirements of D1.6 are satisfied by the opening of that one leaf.

NSW D2.21(c) and (d)

D2.22 Re-entry from fire-isolated exits

- (a) Doors of a fire-isolated *exit* must not be locked from the inside as follows:
 - (i) In a Class 9a *health-care building*.
 - (ii) In a Class 9c *aged care building*.
 - (iii) In a fire-isolated *exit* serving any storey above an *effective height* of 25 m, throughout the *exit*.
- (b) The requirements of (a) do not apply to a door fitted with a fail-safe device that *automatically* unlocks the door upon the activation of a fire alarm and—
 - (i) on at least every fourth *storey*, the doors are not able to be locked and a sign is fixed on such doors stating that re-entry is available; or
 - (ii) an intercommunication system, or an audible or visual alarm system, operated from within the enclosure is provided near the doors and a sign is fixed adjacent to such doors explaining its purpose and method of operation.

D2.23 Signs on doors

- (a) A sign, to alert persons that the operation of certain doors must not be impaired, must be installed where it can readily be seen on, or adjacent to, a—
 - (i)
 - (A) *required* fire door providing direct access to a fire-isolated *exit*, except a door providing direct egress from a *sole-occupancy unit* in a Class 2 or 3 building or Class 4 part of a building; and
 - (B) *required* smoke door,
on the side of the door that faces a person seeking egress and, if the door is fitted with a device for holding it in the open position, on either the wall adjacent to the doorway or both sides of the door; and
 - (ii)
 - (A) fire door forming part of a *horizontal exit*; and
 - (B) smoke door that swings in both directions; and
 - (C) door leading from a fire isolated *exit* to a road or *open space*,
on each side of the door.
- (b) A sign referred to in (a) must be in capital letters not less than 20 mm high in a colour contrasting with the background and state—
 - (i) for an *automatic* door held open by an *automatic* hold-open device—
“**FIRE SAFETY DOOR—DO NOT OBSTRUCT**”; or
 - (ii) for a *self-closing* door—

Deemed-to-Satisfy Provisions

“FIRE SAFETY DOOR

DO NOT OBSTRUCT

DO NOT KEEP OPEN”; or

- (iii) for a door discharging from a fire-isolated *exit*—
“FIRE SAFETY DOOR—DO NOT OBSTRUCT”.

D2.24 Protection of openable windows

- (a) A window opening must be provided with protection, if the floor below the window is 2 m or more above the surface beneath in—
- (i) a bedroom in a Class 2 or 3 building or Class 4 part of a building; or
 - (ii) a Class 9b *early childhood centre*.
- (b) Where the lowest level of the window opening is less than 1.7 m above the floor, a window opening covered by (a) must comply with the following:
- (i) The openable portion of the window must be protected with—
 - (A) a device to restrict the window opening; or
 - (B) a screen with secure fittings.
 - (ii) A device or screen *required* by (i) must—
 - (A) not permit a 125 mm sphere to pass through the window opening or screen; and
 - (B) resist an outward horizontal action of 250 N against the—
 - (aa) window restrained by a device; or
 - (bb) screen protecting the opening; and
 - (C) have a child resistant release mechanism if the screen or device is able to be removed, unlocked or overridden.
- (c) A barrier with a height not less than 865 mm above the floor is *required* to an openable window—
- (i) in addition to window protection, when a child resistant screen release mechanism is *required* by (b)(ii)(C); and
 - (ii) for openable windows 4 m or more above the surface beneath if the window is not covered by (a).
- (d) A barrier covered by (c) must not—
- (i) permit a 125 mm sphere to pass through it; and
 - (ii) have any horizontal or near horizontal elements between 150 mm and 760 mm above the floor that facilitate climbing.

NSW D2.101

PART D3

ACCESS FOR PEOPLE WITH A DISABILITY

Deemed-to-Satisfy Provisions

D3.0 Deemed-to-Satisfy Provisions

Tas D3.0

- (a) Where a *Building Solution* is proposed to comply with the *Deemed-to-Satisfy Provisions*, *Performance Requirements DP1 to DP6, DP8 and DP9* are satisfied by complying with—
- (i) **D1.1 to D1.16, D2.1 to D2.24 and D3.1 to D3.12**; and
 - (ii) in a building containing an *atrium*, **Part G3**; and
 - (iii) for theatres, *stages* and public halls, **Part H1**; and
 - (iv) for public transport buildings, **Part H2**.
- (b) Where a *Building Solution* is proposed as an *Alternative Solution* to the *Deemed-to-Satisfy Provisions* of—
- (i) **D1.1 to D1.16, D2.1 to D2.24 and D3.1 to D3.12**; and
 - (ii) in a building containing an *atrium*, **Part G3**; and
 - (iii) for theatres, *stages* and public halls, **Part H1**; and
 - (iv) for public transport buildings, **Part H2**,
- the relevant *Performance Requirements* must be determined in accordance with **A0.10**.

D3.1 General building access requirements

SA D3.1

Buildings and parts of buildings must be *accessible* as *required* by **Table D3.1**, unless exempted by **D3.4**.

Table D3.1 REQUIREMENTS FOR ACCESS FOR PEOPLE WITH A DISABILITY

| Class of building | Access requirements |
|---|---|
| Class 1b | |
| (a) Dwellings located on one allotment ⁽¹⁾ and used for short-term holiday accommodation, consisting of— | To and within— |
| (i) 4 to 10 dwellings | 1 dwelling |
| (ii) 11 to 40 dwellings | 2 dwellings |
| (iii) 41 to 60 dwellings | 3 dwellings |
| (iv) 61 to 80 dwellings | 4 dwellings |
| (v) 81 to 100 dwellings | 5 dwellings |
| (vi) more than 100 dwellings | 5 dwellings plus 1 additional dwelling for each additional 30 dwellings or part thereof in excess of 100 dwellings. |

Deemed-to-Satisfy Provisions

Table D3.1 REQUIREMENTS FOR ACCESS FOR PEOPLE WITH A DISABILITY— continued

| Class of building | Access requirements |
|--|--|
| <p>(b) A boarding house, bed and breakfast, guest house, hostel or the like, other than those described in (a)</p> | <p>To and within—</p> <p>1 bedroom and associated sanitary facilities; and</p> <p>not less than 1 of each type of room or space for use in common by the residents or guests, including a cooking facility, sauna, gymnasium, <i>swimming pool</i>, laundry, games room, eating area, or the like; and</p> <p>rooms or spaces for use in common by all residents on a floor to which access by way of a ramp complying with AS 1428.1 or a passenger lift is provided.</p> |
| <p>(1) A community or strata-type subdivision or development is considered to be on a single allotment.</p> | |
| <p>Class 2</p> | |
| <p>Common areas</p> | <p>From a pedestrian entrance <i>required</i> to be <i>accessible</i> to at least 1 floor containing <i>sole-occupancy units</i> and to the entrance doorway of each <i>sole-occupancy unit</i> located on that level.</p> <p>To and within not less than 1 of each type of room or space for use in common by the residents, including a cooking facility, sauna, gymnasium, <i>swimming pool</i>, common laundry, games room, individual shop, eating area, or the like.</p> <p>Where a ramp complying with AS 1428.1 or a passenger lift is installed—</p> <p>(a) to the entrance doorway of each <i>sole-occupancy unit</i>; and</p> <p>(b) to and within rooms or spaces for use in common by the residents,</p> <p>located on the levels served by the lift or ramp.</p> |

Deemed-to-Satisfy Provisions

Table D3.1 REQUIREMENTS FOR ACCESS FOR PEOPLE WITH A DISABILITY— continued

| Class of building | Access requirements |
|--|---|
| <p>If the building or group of buildings contain—</p> <p>1 to 10 <i>sole-occupancy units</i></p> <p>11 to 40 <i>sole-occupancy units</i></p> <p>41 to 60 <i>sole-occupancy units</i></p> <p>61 to 80 <i>sole-occupancy units</i></p> <p>81 to 100 <i>sole-occupancy units</i></p> <p>101 to 200 <i>sole-occupancy units</i></p> <p>201 to 500 <i>sole-occupancy units</i></p> <p>more than 500 <i>sole-occupancy units</i></p> | <p>To and within—</p> <p>1 <i>accessible sole-occupancy unit</i>.</p> <p>2 <i>accessible sole-occupancy units</i>.</p> <p>3 <i>accessible sole-occupancy units</i>.</p> <p>4 <i>accessible sole-occupancy units</i>.</p> <p>5 <i>accessible sole-occupancy units</i>.</p> <p>5 <i>accessible sole-occupancy units</i> plus 1 additional <i>accessible sole-occupancy unit</i> for every 25 units or part thereof in excess of 100.</p> <p>9 <i>accessible sole-occupancy units</i> plus 1 additional <i>accessible sole-occupancy unit</i> for every 30 units or part thereof in excess of 200.</p> <p>19 <i>accessible sole-occupancy units</i> plus 1 additional <i>accessible sole-occupancy unit</i> for every 50 units or part thereof in excess of 500.</p> |
| Class 5 | To and within all areas normally used by the occupants. |
| Class 6 | To and within all areas normally used by the occupants. |
| Class 7a | To and within any level containing <i>accessible</i> carparking spaces. |
| Class 7b | To and within all areas normally used by the occupants. |
| Class 8 | To and within all areas normally used by the occupants. |
| Class 9a | To and within all areas normally used by the occupants. |
| Class 9b | |
| <p><i>Schools</i> and <i>early childhood centres</i></p> <p>An <i>assembly building</i> not being a <i>school</i> or an <i>early childhood centre</i></p> | <p>To and within all areas normally used by the occupants.</p> <p>To wheelchair seating spaces provided in accordance with D3.9.</p> <p>To and within all other areas normally used by the occupants, except that access need not be provided to tiers or platforms of seating areas that do not contain wheelchair seating spaces.</p> |

Deemed-to-Satisfy Provisions

Table D3.1 REQUIREMENTS FOR ACCESS FOR PEOPLE WITH A DISABILITY— continued

| Class of building | Access requirements |
|--|---|
| Class 9c | |
| Common areas | <p>From a pedestrian entrance <i>required</i> to be <i>accessible</i> to at least 1 floor containing <i>sole-occupancy units</i> and to the entrance doorway of each <i>sole-occupancy unit</i> located on that level.</p> <p>To and within not less than 1 of each type of room or space for use in common by the residents, including a cooking facility, sauna, gymnasium, <i>swimming pool</i>, common laundry, games room, TV room, individual shop, dining room, public viewing area, ticket purchasing service, lunch room, lounge room, or the like.</p> <p>Where a ramp complying with AS 1428.1 or a passenger lift is installed—</p> <ul style="list-style-type: none"> (a) to the entrance doorway of each <i>sole-occupancy unit</i>; and (b) to and within rooms or spaces for use in common by the residents, <p>located on the levels served by the lift or ramp.</p> |
| <i>Sole-occupancy units</i> | <p>Where more than 2 <i>accessible sole-occupancy units</i> are <i>required</i>, they must be representative of the range of rooms available.</p> |
| If the building or group of buildings contain— | To and within— |
| 1 to 10 <i>sole-occupancy units</i> | 1 <i>accessible sole-occupancy unit</i> . |
| 11 to 40 <i>sole-occupancy units</i> | 2 <i>accessible sole-occupancy units</i> . |
| 41 to 60 <i>sole-occupancy units</i> | 3 <i>accessible sole-occupancy units</i> . |
| 61 to 80 <i>sole-occupancy units</i> | 4 <i>accessible sole-occupancy units</i> . |
| 81 to 100 <i>sole-occupancy units</i> | 5 <i>accessible sole-occupancy units</i> . |
| 101 to 200 <i>sole-occupancy units</i> | 5 <i>accessible sole-occupancy units</i> plus 1 additional <i>sole-occupancy unit</i> for every 25 units or part thereof in excess of 100. |
| 201 to 500 <i>sole-occupancy units</i> | 9 <i>accessible sole-occupancy units</i> plus 1 additional <i>sole-occupancy unit</i> for every 30 units or part thereof in excess of 200. |
| more than 500 <i>sole-occupancy units</i> | 19 <i>accessible sole-occupancy units</i> plus 1 additional <i>sole-occupancy unit</i> for every 50 units or part thereof in excess of 500. |

Deemed-to-Satisfy Provisions

Table D3.1 REQUIREMENTS FOR ACCESS FOR PEOPLE WITH A DISABILITY— continued

| Class of building | Access requirements |
|---|--|
| <p>Class 10a</p> <p>Non-habitable building located in an <i>accessible</i> area intended for use by the public and containing a sanitary facility, change room facility or shelter</p> | <p>To and within—</p> <p>(a) An <i>accessible</i> sanitary facility; and</p> <p>(b) a change room facility; and</p> <p>(c) a public shelter or the like.</p> |
| <p>Class 10b</p> <p><i>Swimming pool</i></p> | <p>To and into <i>swimming pools</i> with a total perimeter greater than 40 m, associated with a Class 1b, 2, 3, 5, 6, 7, 8 or 9 building that is <i>required</i> to be <i>accessible</i>, but not <i>swimming pools</i> for the exclusive use of occupants of a Class 1b building or a <i>sole-occupancy unit</i> in a Class 2 or Class 3 building.</p> |

SA Table D3.1a

D3.2 Access to buildings

- (a) An *accessway* must be provided to a building *required* to be *accessible*—
 - (i) from the main points of a pedestrian entry at the allotment boundary; and
 - (ii) from another *accessible* building connected by a pedestrian link; and
 - (iii) from any *required accessible* carparking space on the allotment.
- (b) In a building *required* to be *accessible*, an *accessway* must be provided through the principal pedestrian entrance, and—
 - (i) through not less than 50% of all pedestrian entrances including the principal pedestrian entrance; and
 - (ii) in a building with a total *floor area* more than 500 m², a pedestrian entrance which is not *accessible* must not be located more than 50 m from an *accessible* pedestrian entrance,

except for pedestrian entrances serving only areas exempted by **D3.4**.
- (c) Where a pedestrian entrance *required* to be *accessible* has multiple doorways—
 - (i) if the pedestrian entrance consists of not more than 3 doorways — not less than 1 of those doorways must be *accessible*; and
 - (ii) if a pedestrian entrance consists of more than 3 doorways — not less than 50% of those doorways must be *accessible*.
- (d) For the purposes of (c)—
 - (i) an *accessible* pedestrian entrance with multiple doorways is considered to be one pedestrian entrance where—

Deemed-to-Satisfy Provisions

- (A) all doorways serve the same part or parts of the building; and
- (B) the distance between each doorway is not more than the width of the widest doorway at that pedestrian entrance (see **Figure D3.2**); and
- (ii) a doorway is considered to be the clear, unobstructed opening created by the opening of one or more door leaves (see **Figure D3.2**).
- (e) Where a doorway on an *accessway* has multiple leaves, (except an automatic opening door) one of those leaves must have a clear opening width of not less than 850 mm in accordance with AS 1428.1.

Figure D3.2

DOORWAYS AND PEDESTRIAN ENTRANCES FOR ACCESS PURPOSES

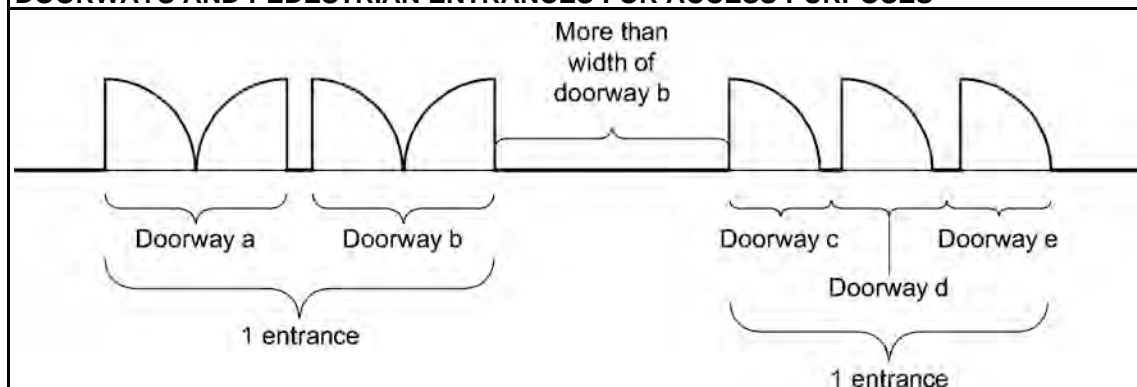

D3.3 Parts of buildings to be accessible

In a building *required* to be *accessible*—

- (a) every ramp and stairway, except for ramps and stairways in areas exempted by **D3.4**, must comply with—
 - (i) for a ramp, except a *fire-isolated ramp*, clause 10 of AS 1428.1; and
 - (ii) for a stairway, except a *fire-isolated stairway*, clause 11 of AS 1428.1; and
 - (iii) for a *fire-isolated stairway*, clause 11.1(f) and (g) of AS 1428.1; and
- (b) every passenger lift must comply with **E3.6**; and
- (c) *accessways* must have—
 - (i) passing spaces complying with AS 1428.1 at maximum 20 m intervals on those parts of an *accessway* where a direct line of sight is not available; and
 - (ii) turning spaces complying with AS 1428.1—
 - (A) within 2 m of the end of *accessways* where it is not possible to continue travelling along the *accessway*; and
 - (B) at maximum 20 m intervals along the *accessway*; and
- (d) an intersection of *accessways* satisfies the spatial requirements for a passing and turning space; and
- (e) a passing space may serve as a turning space; and

Deemed-to-Satisfy Provisions

- (f) a ramp complying with AS 1428.1 or a passenger lift need not be provided to serve a *storey* or level other than the entrance *storey* in a Class 5, 6, 7b or 8 building—
 - (i) containing not more than 3 *storeys*; and
 - (ii) with a *floor area* for each *storey*, excluding the entrance *storey*, of not more than 200 m²; and
- (g) clause 7.4.1(a) of AS 1428.1 does not apply and is replaced with 'the pile height or pile thickness shall not exceed 11 mm and the carpet backing thickness shall not exceed 4 mm'; and
- (h) the carpet pile height or pile thickness dimension, carpet backing thickness dimension and their combined dimension shown in Figure 8 of AS 1428.1 do not apply and are replaced with 11 mm, 4 mm and 15 mm respectively.

D3.4 Exemptions

The following areas are not *required* to be *accessible*:

- (a) An area where access would be inappropriate because of the particular purpose for which the area is used.
- (b) An area that would pose a health or safety risk for people with a disability.
- (c) Any path of travel providing access only to an area exempted by (a) or (b).

D3.5 Accessible carparking

Accessible carparking spaces—

- (a) subject to (b), must be provided in accordance with **Table D3.5** in—
 - (i) a Class 7a building *required* to be *accessible*; and
 - (ii) a carparking area on the same allotment as a building *required* to be *accessible*; and
- (b) need not be provided in a Class 7a building or a carparking area where a parking service is provided and direct access to any of the carparking spaces is not available to the public; and
- (c) subject to (d), must comply with AS/NZS 2890.6; and
- (d) need not be designated where there is a total of not more than 5 carparking spaces, so as to restrict the use of the carparking space only for people with a disability.

Deemed-to-Satisfy Provisions

Table D3.5 CARPARKING SPACES FOR PEOPLE WITH A DISABILITY

| Class of building to which the <i>carpark</i> or carparking area is associated | Number of <i>accessible</i> carparking spaces <i>required</i> |
|--|---|
| Class 1b and 3 | |
| (a) Boarding house, guest house, hostel, lodging house, backpackers accommodation, or the residential part of a hotel or motel. | To be calculated by multiplying the total number of carparking spaces by the percentage of— (i) <i>accessible sole-occupancy units</i> to the total number of <i>sole-occupancy units</i> ; or (ii) <i>accessible</i> bedrooms to the total number of bedrooms; and the calculated number is to be taken to the next whole figure. |
| (b) Residential part of a <i>school</i> , accommodation for the aged, disabled or children, residential part of a <i>health-care building</i> which accommodates members of staff or the residential part of a <i>detention centre</i> . | 1 space for every 100 carparking spaces or part thereof. |
| Class 5, 7, 8 or 9c | 1 space for every 100 carparking spaces or part thereof. |
| Class 6 | |
| (a) Up to 1000 carparking spaces; and | 1 space for every 50 carparking spaces or part thereof. |
| (b) for each additional 100 carparking spaces or part thereof in excess of 1000 carparking spaces. | 1 space. |
| Class 9a | |
| (a) Hospital (non-outpatient area) | 1 space for every 100 carparking spaces or part thereof. |
| (b) Hospital (outpatient area)— | |
| (i) up to 1000 carparking spaces; and | 1 space for every 50 carparking spaces or part thereof. |
| (ii) for each additional 100 carparking spaces or part thereof in excess of 1000 carparking spaces. | 1 space. |
| (c) Nursing home | 1 space for every 100 carparking spaces or part thereof. |
| (d) Clinic or day surgery not forming part of a hospital. | 1 space for every 50 carparking spaces or part thereof. |

Deemed-to-Satisfy Provisions

Table D3.5 CARPARKING SPACES FOR PEOPLE WITH A DISABILITY— continued

| Class of building to which the <i>carpark</i> or <i>carparking area</i> is associated | Number of <i>accessible</i> carparking spaces <i>required</i> |
|---|---|
| Class 9b | |
| (a) <i>School</i> | 1 space for every 100 carparking spaces or part thereof. |
| (b) Other <i>assembly building</i> — | |
| (i) up to 1000 carparking spaces; and | 1 space for every 50 carparking spaces or part thereof. |
| (ii) for each additional 100 carparking spaces or part thereof in excess of 1000 carparking spaces. | 1 space. |

D3.6 Signage

In a building *required* to be *accessible*—

- (a) braille and tactile signage complying with **Specification D3.6** must—
 - (i) incorporate the international symbol of access or deafness, as appropriate, in accordance with AS 1428.1 and identify each—
 - (A) sanitary facility, except a sanitary facility within a *sole-occupancy unit* in a Class 1b or Class 3 building; and
 - (B) space with a hearing augmentation system; and
 - (ii) identify each door *required* by **E4.5** to be provided with an *exit* sign and state—
 - (A) "**Exit**"; and
 - (B) "**Level**" followed by the floor level number; and
- (b) signage including the international symbol for deafness in accordance with AS 1428.1 must be provided within a room containing a hearing augmentation system identifying—
 - (i) the type of hearing augmentation; and
 - (ii) the area covered within the room; and
 - (iii) if receivers are being used and where the receivers can be obtained; and
- (c) signage in accordance with AS 1428.1 must be provided for *accessible* unisex sanitary facilities to identify if the facility is suitable for left or right handed use; and
- (d) signage to identify an ambulant *accessible* sanitary facility in accordance with AS 1428.1 must be located on the door of the facility; and
- (e) where a pedestrian entrance is not *accessible*, directional signage incorporating the international symbol of access, in accordance with AS 1428.1 must be provided to direct a person to the location of the nearest *accessible* pedestrian entrance; and
- (f) where a bank of sanitary facilities is not provided with an *accessible* unisex sanitary facility, directional signage incorporating the international symbol of access in accordance with AS 1428.1 must be placed at the location of the sanitary facilities that are not

Deemed-to-Satisfy Provisions

accessible, to direct a person to the location of the nearest *accessible* unisex sanitary facility.

D3.7 Hearing augmentation

- (a) A hearing augmentation system must be provided where an inbuilt amplification system, other than one used only for emergency warning, is installed—
 - (i) in a room in a Class 9b building; or
 - (ii) in an auditorium, conference room, meeting room or room for judicatory purposes; or
 - (iii) at any ticket office, teller's booth, reception area or the like, where the public is screened from the service provider.
- (b) If a hearing augmentation system *required* by (a) is—
 - (i) an induction loop, it must be provided to not less than 80% of the *floor area* of the room or space served by the inbuilt amplification system; or
 - (ii) a system requiring the use of receivers or the like, it must be available to not less than 95% of the *floor area* of the room or space served by the inbuilt amplification system, and the number of receivers provided must not be less than—
 - (A) if the room or space accommodates up to 500 persons, 1 receiver for every 25 persons or part thereof, or 2 receivers, whichever is the greater; and
 - (B) if the room or space accommodates more than 500 persons but not more than 1000 persons, 20 receivers plus 1 receiver for every 33 persons or part thereof in excess of 500 persons; and
 - (C) if the room or space accommodates more than 1000 persons but not more than 2000 persons, 35 receivers plus 1 receiver for every 50 persons or part thereof in excess of 1000 persons; and
 - (D) if the room or space accommodates more than 2000 persons, 55 receivers plus 1 receiver for every 100 persons or part thereof in excess of 2000 persons.
- (c) The number of persons accommodated in the room or space served by an inbuilt amplification system must be calculated according to **D1.13**.
- (d) Any screen or scoreboard associated with a Class 9b building and capable of displaying public announcements must be capable of supplementing any public address system, other than a public address system used for emergency warning purposes only.

D3.8 Tactile indicators

- (a) For a building *required* to be *accessible*, tactile ground surface indicators must be provided to warn people who are blind or have a vision impairment that they are approaching—
 - (i) a stairway, other than a *fire-isolated stairway*; and
 - (ii) an escalator; and
 - (iii) a passenger conveyor or moving walk; and
 - (iv) a ramp other than a *fire-isolated ramp*, step ramp, kerb ramp or *swimming pool ramp*; and

Deemed-to-Satisfy Provisions

- (v) in the absence of a suitable barrier—
 - (A) an overhead obstruction less than 2 m above floor level, other than a doorway; and
 - (B) an *accessway* meeting a vehicular way adjacent to any pedestrian entrance to a building, excluding a pedestrian entrance serving an area referred to in **D3.4**, if there is no kerb or kerb ramp at that point,

except for areas exempted by **D3.4**.

- (b) Tactile ground surface indicators *required* by (a) must comply with sections 1 and 2 of AS/NZS 1428.4.1.
- (c) A hostel for the aged, nursing home for the aged, a *residential aged care building* Class 3 accommodation for the aged, Class 9a *health-care building* or a Class 9c *aged care building* need not comply with (a)(i) and (iv) if handrails incorporating a raised dome button in accordance with the requirements for stairway handrails in AS 1428.1 are provided to warn people who are blind or have a vision impairment that they are approaching a stairway or ramp.

D3.9 Wheelchair seating spaces in Class 9b assembly buildings

Where fixed seating is provided in a Class 9b *assembly building*, wheelchair seating spaces complying with AS 1428.1 must be provided in accordance with the following:

- (a) The number and grouping of wheelchair seating spaces must be in accordance with **Table D3.9**.
- (b) In a cinema—
 - (i) with not more than 300 seats — wheelchair seating spaces must not be located in the front row of seats; and
 - (ii) with more than 300 seats — not less than 75% of *required* wheelchair seating spaces must be located in rows other than the front row of seats; and
 - (iii) the location of wheelchair seating is to be representative of the range of seating provided.

Table D3.9 WHEELCHAIR SEATING SPACES IN CLASS 9b ASSEMBLY BUILDINGS

| Number of fixed seats in a room or space | Number of wheelchair seating spaces | Grouping and location |
|--|--|---|
| Up to 150 | 3 spaces | 1 single space; and 1 group of 2 spaces. |
| 151 to 800 | 3 spaces; plus 1 additional space for each additional 50 seats or part thereof in excess of 150 seats | Not less than 1 single space; and not less than 1 group of 2 spaces; and not more than 5 spaces in any other group. |
| 801 to 10 000 | 16 spaces; plus | Not less than 2 single spaces; and |

Deemed-to-Satisfy Provisions

Table D3.9 WHEELCHAIR SEATING SPACES IN CLASS 9b ASSEMBLY BUILDINGS— continued

| Number of fixed seats in a room or space | Number of wheelchair seating spaces | Grouping and location |
|--|--|--|
| | 1 additional space for each additional 100 seats or part thereof in excess of 800 seats | not less than 2 groups of 2 spaces; and not more than 5 spaces in any other group; and the location of spaces is to be representative of the range of seating provided. |
| More than 10 000 | 108 spaces; plus 1 additional space for each additional 200 seats or part thereof in excess of 10 000 seats | Not less than 5 single spaces; and not less than 5 groups of 2 spaces; and not more than 10 spaces in any other group; and the location of spaces is to be representative of the range of seating provided. |

D3.10 Swimming pools

- (a) Not less than 1 means of *accessible* water entry/exit in accordance with **Specification D3.10** must be provided for each *swimming pool required* by **Table D3.1** to be *accessible*.
- (b) An *accessible* entry/exit must be by means of—
 - (i) a fixed or movable ramp and an aquatic wheelchair; or
 - (ii) a zero depth entry at a maximum gradient of 1:14 and an aquatic wheelchair; or
 - (iii) a platform *swimming pool* lift and an aquatic wheelchair; or
 - (iv) a sling-style *swimming pool* lift.
- (c) Where a *swimming pool* has a perimeter of more than 70 m in length, at least one *accessible* water entry/exit must be provided by a means specified in **(b)(i), (ii) or (iii)**.
- (d) Latching devices on gates and doors forming part of a *swimming pool* safety barrier need not comply with AS 1428.1.

D3.11 Ramps

On an *accessway*—

- (a) a series of connected ramps must not have a combined vertical rise of more than 3.6 m; and
- (b) a landing for a step ramp must not overlap a landing for another step ramp or ramp.

Deemed-to-Satisfy Provisions

D3.12 Glazing on an accessway

On an *accessway*, where there is no chair rail, handrail or transom, all frameless or fully glazed doors, sidelights and any glazing capable of being mistaken for a doorway or opening, must be clearly marked in accordance with AS 1428.1.

SPECIFICATION **D1.12** NON-REQUIRED STAIRWAYS, RAMPS AND ESCALATORS

Deemed-to-Satisfy Provisions

1. Scope

This Specification contains the requirements to allow non-*required* stairways, ramps or escalators to connect any number of *storeys* in a Class 5 or 6 building. The requirements do not apply in an *atrium* or outside a building.

2. Requirements

An escalator, moving walkway or non-*required* non-*fire-isolated stairway* or pedestrian ramp must comply with the following:

- (a) The escalator, walkway, stairway or ramp must be bounded by a *shaft* of:
 - (i) construction with an FRL of not less than 120/120/120 if *loadbearing* or –/120/120 if non-*loadbearing* and if of *lightweight construction* must comply with **Specification C1.8**; or
 - (ii) glazed construction with an FRL of not less than –/60/30 protected by a wall wetting system in accordance with **Clause 2.4 of Specification G3.8**.
- (b) The void of each non-*required* stairway, ramp or escalator must not connect more than 2 *storeys*.
- (c) Rising and descending escalators, walkways, stairways and ramps within one *shaft* must be separated by construction with an FRL of not less than –/60/30.
- (d) Openings into the *shaft* must be protected by fire doors with an FRL not less than –/60/30.
- (e) When the fire door is in the closed position, the floor or any covering over the floor beneath the fire door must not be *combustible*.
- (f) Fire doors must be fitted with smoke seals and the assembly must be tested in accordance with AS 1530.4.
- (g) Fire doors must be—
 - (i) closed and locked for security reasons; or
 - (ii) held open and be *automatic* closing.
- (h) Smoke detectors must be installed on both sides of the opening, not more than 1.5 m horizontal distance from the opening.
- (i) In the closed position, fire doors must be openable on a single hand downward action or horizontal pushing action on a single device within the *shaft* and by key only from outside the *shaft*.
- (j) A warning sign must be displayed where it can readily be seen outside the *shaft* near all fire doors opening to the *shaft*. The sign must comply with the details and dimensions of **Figure 2**.

Deemed-to-Satisfy Provisions

Figure 2 WARNING SIGN FOR NON-REQUIRED STAIRWAY, RAMP OR ESCALATOR

| | |
|--|--------|
| DO NOT USE THIS STAIRWAY IF THERE IS A FIRE | =20 mm |
|--|--------|

OR

| | |
|--|--------|
| Do not use this stairway if there is a fire | =16 mm |
|--|--------|

- (k) All doors opening into the *shaft* must be within 20 m of a *required exit*.
- (l) Signs showing the direction of the nearest *required exit* must be installed where they can be readily seen.
- (m) Materials attached to any wall, ceiling or floor within the *shaft* must comply with **Specification C1.10**.
- (n) Emergency lighting must be installed in the *shaft* in accordance with **E4.4**.
- (o) No step or ramp may be closer to the threshold of the doorway than the width of the door leaf.

SPECIFICATION **D3.6** BRAILLE AND TACTILE SIGNS

Deemed-to-Satisfy Provisions

1. Scope

This Specification sets out the requirements for the design and installation of braille and tactile signage as *required* by **D3.6**.

2. Location of braille and tactile signs

Signs including symbols, numbering and lettering must be designed and installed as follows:

- (a) Braille and tactile components of a sign must be located not less than 1200 mm and not higher than 1600 mm above the floor or ground surface.
- (b) Signs with single lines of characters must have the line of tactile characters not less than 1250 mm and not higher than 1350 mm above the floor or ground surface.
- (c) Signs identifying rooms containing features or facilities listed in **D3.6** must be located—
 - (i) on the wall on the latch side of the door with the leading edge of the sign located between 50 mm and 300 mm from the architrave; and
 - (ii) where (i) is not possible, the sign may be placed on the door itself.
- (d) Signs identifying a door *required* by **E4.5** to be provided with an *exit* sign must be located—
 - (i) on the side that faces a person seeking egress; and
 - (ii) on the wall on the latch side of the door with the leading edge of the sign located between 50 mm and 300 mm from the architrave; and
 - (iii) where (ii) is not possible, the sign may be placed on the door itself.

3. Braille and tactile sign specification

- (a) Tactile characters must be raised or embossed to a height of not less than 1 mm and not more than 1.5 mm.
- (b) Sentence case (upper case for the first letter of each main word and lower case for all other letters) must be used for all tactile characters, and—
 - (i) upper case tactile characters must have a height of not less than 15 mm and not more than 55 mm, except that the upper case tactile characters on a sign identifying a door *required* by **E4.5** to be provided with an *exit* sign must have a height of not less than 20 mm and not more than 55 mm; and
 - (ii) lower case tactile characters must have a height of 50% of the related upper case characters.
- (c) Tactile characters, symbols, and the like, must have rounded edges.
- (d) The entire sign, including any frame, must have all edges rounded.
- (e) The background, negative space or fill of signs must be of matt or low sheen finish.

Deemed-to-Satisfy Provisions

- (f) The characters, symbols, logos and other features on signs must be matt or low sheen finish.
- (g) The minimum letter spacing of tactile characters on signs must be 2 mm.
- (h) The minimum word spacing of tactile characters on signs must be 10 mm.
- (i) The thickness of letter strokes must be not less than 2 mm and not more than 7 mm.
- (j) Tactile text must be left justified, except that single words may be centre justified.
- (k) Tactile text must be Arial typeface.

4. Luminance contrast

The following applies to *luminance contrast*:

- (a) The background, negative space, fill of a sign or border with a minimum width of 5 mm must have a *luminance contrast* with the surface on which it is mounted of not less than 30%.
- (b) Tactile characters, icons and symbols must have a minimum *luminance contrast* of 30% to the surface on which the characters are mounted.
- (c) *Luminance contrasts* must be met under the lighting conditions in which the sign is to be located.

5. Lighting

Braille and tactile signs must be illuminated to ensure *luminance contrast* requirements are met at all times during which the sign is required to be read.

6. Braille

The following applies to braille:

- (a) Braille must be grade 1 braille (uncontracted) in accordance with the criteria set out by the Australian Braille Authority.
- (b) Braille must be raised and domed.
- (c) Braille must be located 8 mm below the bottom line of text (not including descenders).
- (d) Braille must be left justified.
- (e) Where an arrow is used in the tactile sign, a solid arrow must be provided for braille readers.
- (f) On signs with multiple lines of text and characters, a semicircular braille locator at the left margin must be horizontally aligned with the first line of braille text.

SPECIFICATION **D3.10** ACCESSIBLE WATER ENTRY/EXIT FOR SWIMMING POOLS

Deemed-to-Satisfy Provisions

1. Scope

This Specification sets out the requirements for types of *accessible* water entry/exit for *swimming pools*.

2. Fixed or moveable ramp

A fixed or moveable ramp must—

- (a) have a slip-resistant surface; and
- (b) have a maximum gradient of 1:14; and
- (c) have handrails complying with the requirements for ramps in AS 1428.1, installed on both sides of the ramp; and
- (d) have kerbs in accordance with the requirements for ramps in AS 1428.1; and
- (e) extend to a depth of not less than 900 mm and not more than 1100 mm below the stationary water level; and
- (f) have landings in accordance with the requirements for ramps in AS 1428.1, with a landing located at the bottom and top of each ramp and a landing must be located at a level between 900 mm and 1100 mm below the stationary water level.

3. Zero depth entry

A zero depth entry must have—

- (a) a slip-resistant surface; and
- (b) a maximum gradient of 1:14; and
- (c) a single handrail complying with the requirements for handrails in AS 1428.1, from the top of the entry point continuous to the bottom level area; and
- (d) a level area—
 - (i) 1500 mm long for the width of the zero depth entry at the entry point; and
 - (ii) located at the bottom of the zero depth entry at a level between 900 mm and 1100 mm below the stationary water level.

4. Platform swimming pool lift

A platform *swimming pool* lift must be—

- (a) capable of being operated from the *swimming pool* surround, within the *swimming pool*, and on the platform; and
- (b) located where the water depth is not more than 1300 mm; and

Deemed-to-Satisfy Provisions

- (c) designed to withstand a weight capacity of not less than 160 kg and be capable of sustaining a static load of not less than 1.5 times the rated load.

5. Sling-style swimming pool lift

A sling lift must comply with the following:

- (a) A sling lift must be located where the water depth is not more than 1300 mm.
- (b) When the sling is in the raised position and in the transfer position, the centreline of the sling must be located over the *swimming pool* surround and not less than 450 mm from the *swimming pool* edge.
- (c) The surface of the *swimming pool* surround between the centreline of the sling and the *swimming pool* edge must have a gradient of not more than 1:50 and must be slip-resistant.
- (d) A clear space—
 - (i) not less than 900 mm x 1300 mm; and
 - (ii) with a gradient of not more than 1:50; and
 - (iii) having a slip-resistant surface; and
 - (iv) located so that the centreline of the space is directly below the lifting point for the sling,
must be provided on the *swimming pool* surround parallel with the *swimming pool* edge on the side remote from the water (see **Figure 5**).
- (e) A sling lift must be capable of being operated from the *swimming pool* surround, within the *swimming pool* and from the sling.
- (f) A sling must be designed so that it will submerge to a water depth of not less than 500 mm below the stationary water level.
- (g) A sling lift must be designed to withstand a weight of not less than 136 kg and be capable of sustaining a static load not less than 1.5 times the rated load.

Deemed-to-Satisfy Provisions

**Figure 5
CLEAR SWIMMING POOL SURROUND SPACE FOR SLING LIFT**

Diagram a. Clear pool surround space for sling lift
Plan view

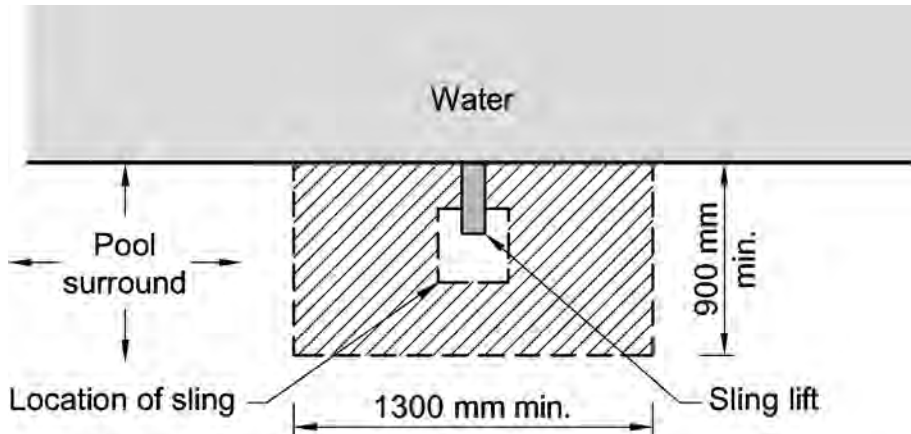
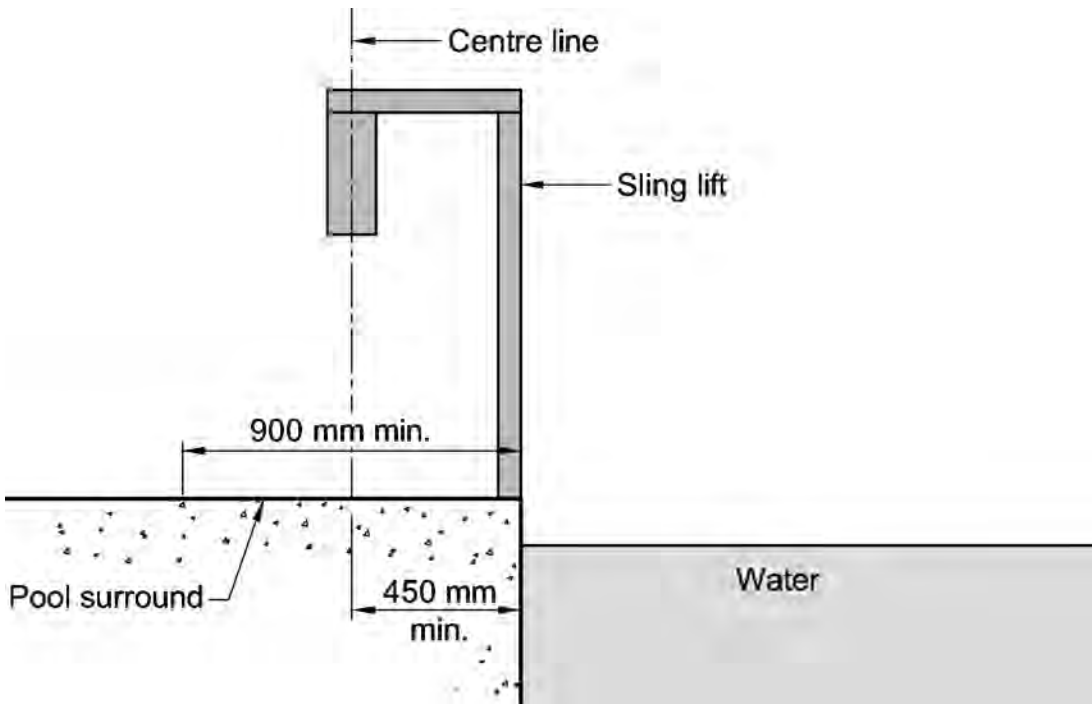

Diagram b. Clear space for sling lift in the transfer position
Sectional elevation



6. Aquatic wheelchair

An aquatic wheelchair must comply with the following:

Deemed-to-Satisfy Provisions

- (a) The height of the top surface of the seat must be not less than 430 mm.
- (b) The seat width must not be not less than 480 mm.
- (c) A footrest must be provided.
- (d) Armrests must be located on both sides of the seat and must be capable of being moved away from the side of the chair to allow a person to transfer on and off the seat.

SECTION **E**

SERVICES AND EQUIPMENT

- E1** **Fire Fighting Equipment**
- E2** **Smoke Hazard Management**
- E3** **Lift Installations**
- E4** **Emergency Lighting, Exit Signs and Warning Systems**

SECTION E CONTENTS

SECTION E SERVICES AND EQUIPMENT

Part E1 Fire Fighting Equipment

Objective EO1
Functional Statement EF1.1
Performance Requirements EP1.1 - EP1.6
E1.0 Deemed-to-Satisfy Provisions
E1.1 * * * * *
E1.2 * * * * *
E1.3 Fire hydrants
E1.4 Fire hose reels
E1.5 Sprinklers
E1.6 Portable fire extinguishers
E1.7 * * * * *
E1.8 Fire control centres
E1.9 Fire precautions during construction
E1.10 Provision for special hazards
Specification E1.5 Fire Sprinkler Systems
Specification E1.8 Fire Control Centres

Part E2 Smoke Hazard Management

Objective EO2
Functional Statement EF2.1
Performance Requirements EP2.1 - EP2.2
E2.0 Deemed-to-Satisfy Provisions
E2.1 Application of Part
E2.2 General requirements
E2.3 Provision for special hazards
Specification E2.2a Smoke Detection and Alarm Systems
Specification E2.2b Smoke Exhaust Systems
Specification E2.2c Smoke-and-Heat Vents

Part E3 Lift Installations

Objective EO3
Functional Statements EF3.1 - EF3.3
Performance Requirements EP3.1 - EP3.4
E3.0 Deemed-to-Satisfy Provisions
E3.1 Lift installations
E3.2 Stretcher facility in lifts
E3.3 Warning against use of lifts in fire
E3.4 Emergency lifts
E3.5 Landings
E3.6 Passenger lifts
E3.7 Fire service controls
E3.8 Aged care buildings

E3.9 Fire service recall operation switch
E3.10 Lift car fire service drive control switch
Specification E3.1 Lift Installations

Part E4 Emergency Lighting, Exit Signs and Warning Systems

Objective EO4
Functional Statement EF4.1
Performance Requirements EP4.1 - EP4.3
Verification Method EV4.1 Emergency Lighting
E4.0 Deemed-to-Satisfy Provisions
E4.1 * * * * *
E4.2 Emergency lighting requirements
E4.3 Measurement of distance
E4.4 Design and operation of emergency lighting
E4.5 Exit signs
E4.6 Direction signs
E4.7 Class 2 and 3 buildings and Class 4 parts: Exemptions
E4.8 Design and operation of exit signs
E4.9 Sound systems and intercom systems for emergency purposes

PART E1 FIRE FIGHTING EQUIPMENT

OBJECTIVE

EO1

The *Objective* of this Part is to—

- (a) safeguard occupants from illness or injury while evacuating during a fire; and
- (b) provide facilities for occupants and the *fire brigade* to undertake fire-fighting operations; and
- (c) prevent the spread of fire between buildings.

TAS EO1(d)

FUNCTIONAL STATEMENT

EF1.1

A building is to be provided with fire-fighting equipment to safeguard against fire spread—

- (a) to allow occupants time to evacuate safely without being overcome by the effects of fire; and
- (b) so that occupants may undertake initial attack on a fire; and
- (c) so that the *fire brigade* have the necessary equipment to undertake search, rescue, and fire-fighting operations; and
- (d) to other parts of the building; and
- (e) between buildings.

TAS EF1.2

PERFORMANCE REQUIREMENTS

EP1.1

A fire hose reel system must be installed to the degree necessary to allow occupants to safely undertake initial attack on a fire appropriate to—

- (a) the size of the *fire compartment*; and
- (b) the function or use of the building; and
- (c) any other *fire safety systems* installed in the building; and

- (d) the *fire hazard*.

EP1.2

Fire extinguishers must be installed to the degree necessary to allow occupants to undertake initial attack on a fire appropriate to—

- (a) the function or use of the building; and
- (b) any other *fire safety systems* installed in the building; and
- (c) the *fire hazard*.

EP1.3

A fire hydrant system must be provided to the degree necessary to facilitate the needs of the *fire brigade* appropriate to—

- (a) fire-fighting operations; and
- (b) the *floor area* of the building; and
- (c) the *fire hazard*.

Application:

EP1.3 only applies to a building where a *fire brigade* is available to attend.

EP1.4

NSW EP1.4

An *automatic* fire suppression system must be installed to the degree necessary to control the development and spread of fire appropriate to—

- (a) the size of the *fire compartment*; and
- (b) the function or use of the building; and
- (c) the *fire hazard*; and
- (d) the height of the building.

EP1.5

Suitable means of fire-fighting must be installed to the degree necessary in a building under construction to allow initial fire attack by construction workers and for the *fire brigade* to undertake attack on the fire appropriate to—

- (a) the *fire hazard*; and
- (b) the height the building has reached during its construction.

EP1.6

Suitable facilities must be provided to the degree necessary in a building to co-ordinate *fire brigade* intervention during an emergency appropriate to—

- (a) the function or use of the building; and
- (b) the *floor area* of the building; and

(c) the height of the building.

TAS EP1.7

PART E1 FIRE FIGHTING EQUIPMENT

Deemed-to-Satisfy Provisions

E1.0 Deemed-to-Satisfy Provisions

Tas E1.0

- (a) Where a *Building Solution* is proposed to comply with the *Deemed-to-Satisfy Provisions, Performance Requirements EP1.1 to EP1.6* are satisfied by complying with **E1.1 to E1.10**.
- (b) Where a *Building Solution* is proposed as an *Alternative Solution* to the *Deemed-to-Satisfy Provisions* of **E1.1 to E1.10**, the relevant *Performance Requirements* must be determined in accordance with **A0.10**.

E1.1 * * * * *

This clause has deliberately been left blank.

E1.2 * * * * *

This clause has deliberately been left blank.

E1.3 Fire hydrants

- (a) A fire hydrant system must be provided to serve a building—
 - (i) having a total *floor area* greater than 500 m²; and
 - (ii) where a *fire brigade* is available to attend a building fire.
- (b) The fire hydrant system—
 - (i) must be installed in accordance with AS 2419.1, except a Class 8 *electricity network substation* need not comply with clause 4.2 of AS 2419.1 if—
 - (A) it cannot be connected to town main supply; and
 - (B) one hour water storage is provided for firefighting; and
 - (ii) where internal fire hydrants are provided, they must serve only the *storey* on which they are located except that a *sole-occupancy unit*—
 - (A) in a Class 2 or 3 building or Class 4 part of a building may be served by a single fire hydrant located at the level of egress from that *sole-occupancy unit*; or
 - (B) of not more than 2 *storeys* in a Class 5, 6, 7, 8 or 9 building may be served by a single fire hydrant located at the level of egress from that *sole-occupancy unit* provided the fire hydrant can provide coverage to the whole of the *sole-occupancy unit*.

Deemed-to-Satisfy Provisions

E1.4 Fire hose reels

- (a) E1.4 does not apply to—
- (i) a Class 8 *electricity network substation*; or
 - (ii) a Class 9c *aged care building*; or
 - (iii) classrooms and associated corridors in a primary or secondary *school*.
- (b) A fire hose reel system must be provided—
- (i) to serve the whole building where one or more internal fire hydrants are installed; or
 - (ii) where internal fire hydrants are not installed, to serve any *fire compartment* with a *floor area* greater than 500 m², and for the purposes of this clause, a *sole-occupancy unit* in a Class 2 or 3 building or Class 4 part of a building is considered to be a *fire compartment*.
- (c) The fire hose reel system must—
- (i) have fire hose reels installed in accordance with AS 2441; and
 - (ii) provide fire hose reels to serve only the *storey* at which they are located, except a *sole-occupancy unit*—
 - (A) in a Class 2 or 3 building or Class 4 part of a building may be served by a single fire hose reel located at the level of egress from that *sole-occupancy unit*; and
 - (B) of not more than 2 *storeys* in a Class 5, 6, 7, 8 or 9 building may be served by a single fire hose reel located at the level of egress from that *sole-occupancy unit* provided the fire hose reel can provide coverage to the whole of the *sole-occupancy unit*.
- (d) Fire hose reels must be located internally, externally or in combination, to achieve the system coverage specified in AS 2441.
- (e) In achieving system coverage, one or a combination of the following criteria for individual internally located fire hose reels must be met in determining the layout of any fire hose reel system:
- (i) Fire hose reels must be located adjacent to an internal fire hydrant (other than one within a fire-isolated *exit*), except that a fire hose reel need not be located adjacent to every fire hydrant, provided system coverage can be achieved.
 - (ii) Fire hose reels must be located within 4 m of an *exit*, except that a fire hose reel need not be located adjacent to every *exit*, provided system coverage can be achieved.
 - (iii) Where system coverage is not achieved by compliance with (i) and (ii), additional fire hose reels may be located in paths of travel to an *exit* to achieve the *required* coverage.
- (f) Fire hose reels must be located so that the fire hose will not need to pass through doorways fitted with fire or smoke doors, except—
- (i) doorways in walls referred to in **C2.5(a)(v)** in a Class 9a building and **C2.5(b)(iv)** in a Class 9c building, separating ancillary use areas of high potential *fire hazard*; and

Deemed-to-Satisfy Provisions

- (ii) doorways in walls referred to in **C2.12** or **C2.13** separating equipment or electrical supply systems; and
 - (iii) doorways in bounding construction in a Class 2 or 3 building or Class 4 part of a building referred to in **C3.11**; and
 - (iv) doorway openings to *shafts* referred to in **C3.13**.
- (g) Where the normal water supply cannot achieve the flow and pressures required by AS 2441, or is unreliable—
- (i) a pump; or
 - (ii) water storage facility; or
 - (iii) both a pump and water storage facility,
- must be installed to provide the minimum flow and pressures required by clause 6.1 of AS 2441.

E1.5 Sprinklers

A sprinkler system must—

- (a) be installed in a building or part of a building when *required* by **Table E1.5**; and
- (b) comply with **Specification E1.5**.

NSW Table E1.5

NT Table E1.5

Vic Table E1.5

Table E1.5 REQUIREMENTS FOR SPRINKLERS

| Occupancy | When sprinklers are required |
|---|--|
| All classes— <ul style="list-style-type: none"> (a) including an <i>open-deck carpark</i> within a multi-classified building; but (b) excluding— <ul style="list-style-type: none"> (i) an <i>open-deck carpark</i> being a separate building; and (ii) a Class 8 <i>electricity network substation</i>, with a <i>floor area</i> not more than 200 m², located within a multi-classified building. | Throughout the whole building if any part of the building has an <i>effective height</i> of more than 25 m. |
| Class 6 | In <i>fire compartments</i> where either of the following apply: <ul style="list-style-type: none"> (a) A <i>floor area</i> of more than 3 500 m². (b) A volume more than 21 000 m³. |
| Class 7a, other than <i>open-deck carparks</i> | In <i>fire compartments</i> where more than 40 vehicles are accommodated. |

Deemed-to-Satisfy Provisions

Table E1.5 REQUIREMENTS FOR SPRINKLERS — *continued*

| Occupancy | When sprinklers are required |
|--|--|
| Class 9c <i>aged care building</i> | Throughout the building and any <i>fire compartment</i> containing a Class 9c part. |
| Class 9b theatres, stages & public halls | see Part H1 |
| Atrium construction | see Part G3 |
| Large isolated buildings | see Clause C2.3 |
| Occupancies of excessive hazard (see Note 3) | In <i>fire compartments</i> where either of the following apply: (a) A <i>floor area</i> of more than 2 000 m ² . (b) A volume of more than 12 000 m ³ . |

Notes:

1. See **Specification C1.1** for use of sprinklers in Class 2 buildings and *carparks* generally.
2. See **Part E2** for use of sprinklers to satisfy Smoke Hazard Management provisions.
3. For the purposes of this Table, occupancies of excessive *fire hazard* comprise buildings which contain—
 - (a) hazardous processes or storage including the following:
 - (i) Aircraft hangars.
 - (ii) Cane furnishing manufacture, processing and storage.
 - (iii) Fire-lighter and fireworks manufacture and warehousing.
 - (iv) Foam plastic and foam plastic goods manufacture, processing and warehousing (e.g. furniture factory).
 - (v) Hydrocarbon based sheet product, manufacture, processing and warehousing (e.g. vinyl floor coverings).
 - (vi) Woodwool and other flammable loose fibrous material manufacture.
 - (b) *Combustible* Goods with an aggregate volume exceeding 1000 m³ and stored to a height greater than 4 m including the following:
 - (i) Aerosol packs with flammable contents.
 - (ii) Carpets and clothing.
 - (iii) Electrical appliances.
 - (iv) *Combustible* compressed fibreboards (low and high density) and plywoods.
 - (v) *Combustible* cartons, irrespective of content
 - (vi) Esparto and other fibrous *combustible* material.
 - (vii) Furniture including timber, cane and composite, where foamed rubber or plastics are incorporated.

Deemed-to-Satisfy Provisions

Table E1.5 REQUIREMENTS FOR SPRINKLERS — *continued*

| Occupancy | When sprinklers are required |
|-----------|--|
| (viii) | Paper storage (all forms of new or waste) (e.g. bales, sheet, horizontal or vertical rolls, waxed coated or processed). |
| (ix) | Textiles raw and finished, eg, rolled cloth, clothing and manchester. |
| (x) | Timber storage including sheets, planks, boards, joists and cut sizes. |
| (xi) | Vinyl, plastic, foamed plastic, rubber and other <i>combustible</i> sheets, offcuts and random pieces and rolled material storage, eg, carpet, tar paper, linoleum, wood veneer and foam mattresses. |
| (xii) | All materials having wrappings or preformed containers of foamed plastics. |

E1.6 Portable fire extinguishers

Portable fire extinguishers must be provided as listed in **Table E1.6** and must be selected, located and distributed in accordance with Sections 1, 2, 3 and 4 of AS 2444.

E1.7 * * * * *

This clause has deliberately been left blank.

E1.8 Fire control centres

A fire control centre facility in accordance with **Specification E1.8** must be provided for—

- (a) a building with an *effective height* of more than 25 m; and
- (b) a Class 6, 7, 8 or 9 building with a total *floor area* of more than 18 000 m².

E1.9 Fire precautions during construction

In a building under construction—

- (a) not less than one fire extinguisher to suit Class A, B and C fires and electrical fires must be provided at all times on each *storey* adjacent to each *required exit* or temporary stairway or *exit*; and
- (b) after the building has reached an *effective height* of 12 m—
 - (i) the *required* fire hydrants and fire hose reels must be operational in at least every *storey* that is covered by the roof or the floor structure above, except the 2 uppermost *storeys*; and
 - (ii) any *required* booster connections must be installed.

Deemed-to-Satisfy Provisions

Table E1.6 REQUIREMENTS FOR EXTINGUISHERS (Note 3)

| Occupancy class | Risk class (as defined in AS 2444) |
|--|---|
| <p>General provisions—Class 2 to 9 (except within <i>sole-occupancy units</i> of a Class 2 or 3 building or Class 4 part of a building or sole-occupancy units in a Class 9c <i>aged care building</i>)</p> | <p>(a) To cover Class AE or E fire risks associated with emergency services switchboards. (Note 1)</p> <p>(b) To cover Class F fire risks involving cooking oils and fats in kitchens.</p> <p>(c) To cover Class B fire risks in locations where flammable liquids in excess of 50 litres are stored or used (not including that held in fuel tanks of vehicles).</p> <p>(d) To cover Class A fire risks in normally occupied <i>fire compartments</i> less than 500 m² not provided with fire hose reels (excluding <i>open deck carparks</i>).</p> <p>(e) To cover Class A fire risks in classrooms and associated corridors in primary and secondary schools not provided with fire hose reels.</p> |
| <p>Specific provisions (in addition to general provisions)—</p> <p>(a) Class 9a <i>health care building</i></p> <p>(b) Class 3 parts of detention and correctional occupancies</p> <p>(c) Class 3 accommodation for children, aged persons and people with disabilities</p> <p>(d) Class 9c <i>aged care buildings</i></p> | <p>To cover Class A and E fire risks. (Note 2)</p> |
| <p>Notes</p> <p>1. For the purposes of this Table, an emergency services switchboard is one which sustains emergency equipment operating in the emergency mode.</p> <p>2. A Class E fire extinguisher need only be located at each nurses, supervisors station or the like.</p> <p>3. Additional extinguishers may be required to cover fire risks in relation to special hazards provided for in E1.10.</p> | |

E1.10 Provision for special hazards

Suitable additional provision must be made if special problems of fighting fire could arise because of—

- (a) the nature or quantity of materials stored, displayed or used in a building or on the allotment; or
- (b) the location of the building in relation to a water supply for fire-fighting purposes.

Deemed-to-Satisfy Provisions

Tas E1.101

SPECIFICATION **E1.5** FIRE SPRINKLER SYSTEMS

Deemed-to-Satisfy Provisions

1. Scope

This Specification sets out requirements for the design and installation of fire sprinkler systems.

2. Adoption of AS 2118

Subject to this Specification, a sprinkler system must comply with—

- (a) AS 2118.1; or

Vic Spec E1.5 2(b)

- (b) for a Class 2 or 3 building: AS 2118.4 as applicable; or
- (c) for a combined sprinkler and fire hydrant system: AS 2118.6; or
- (d) for a Class 9c *aged care building*: AS 2118.4, as applicable.

3. Separation of sprinklered and non-sprinklered areas

Where a part of a building is not protected with sprinklers, the sprinklered and non-sprinklered parts must be fire-separated with a wall or floor which must—

- (a) comply with any specific requirement of the *Deemed-to-Satisfy Provisions* of the BCA; or
- (b) where there is no specific requirement, comply with the relevant part of AS 2118.

4. Protection of openings

Any openings, including those for service penetrations, in construction separating sprinklered and non-sprinklered parts of a building, including the construction separating the areas nominated as permitted exceptions in AS 2118.1, must be protected in accordance with the *Deemed-to-Satisfy Provisions* of **Part C3**.

5. Fast response sprinklers

Fast response sprinklers may be installed only if they are suitable for the type of application proposed and it is demonstrated that the sprinkler system is designed to accommodate their use.

6. Sprinkler valve enclosures

- (a) Sprinkler alarm valves must be located in a secure room or enclosure which has direct egress to a road or *open space*.
- (b) All sprinkler valve rooms and enclosures must be secured with a system suitable for use by the *fire brigade*.

7. Water supply

The Grade of water supply to a *required* sprinkler system must not be less than—

Deemed-to-Satisfy Provisions

- (a) for a building greater than 25 m in *effective height*, Grade 1, except that a secondary water supply storage capacity of 25,000 litres may be used if—
 - (i) the storage tank is located at the topmost *storey* of the building; and
 - (ii) the building occupancy is classified as no more hazardous than Ordinary Hazard 2 (OH2) under AS 2118.1; and
 - (iii) an operational *fire brigade* service is available to attend a building fire; and
- (b) for a building not greater than 25 m in *effective height*, at least Grade 3.

8. Building occupant warning system

A *required* sprinkler system must be connected to and activate a building occupant warning system complying with **Clause 6 of Specification E2.2a**.

9. Connection to other systems

Where a smoke hazard management system is installed and is actuated by smoke detectors, the sprinkler system must, wherever practicable, be arranged to also activate the smoke hazard management system.

10. Anti-tamper devices

Where a sprinkler system is installed in a theatre, public hall or the like, any valves provided to control sprinklers over any *stage* area must be fitted with anti-tamper devices connected to a monitoring panel at the location normally used by the *stage* manager.

11. Sprinkler systems in carparks

The sprinkler system protecting a *carpark* complying with **Table 3.9 of Specification C1.1** in a multi-classified building must—

- (a) be independent of the sprinkler system protecting any part of the building not used as a *carpark*; or
- (b) if forming part of a sprinkler system protecting a part of the building not used as a *carpark*, be designed such that the section protecting the non-*carpark* part can be isolated without interrupting the water supply or otherwise affecting the effective operation of the section protecting the *carpark*.

12. Class 9c aged care buildings

In addition to the provisions of AS 2118.4, a sprinkler system in a Class 9c *aged care building* must—

- (a) be provided with a monitored main stop valve in accordance with AS 2118.1; and
- (b) be permanently connected with a direct data link or other approved monitoring system to a fire station or fire station dispatch centre.

13. Sprinkler systems in lift installations

Where sprinklers are installed in a space housing lift electrical and control equipment, including machine rooms, secondary floors and sheave rooms, they must be of the dry system type in accordance with AS 2118.1.

SPECIFICATION **E1.8** FIRE CONTROL CENTRES

Deemed-to-Satisfy Provisions

1. Scope

This Specification describes the construction and content of *required* fire control centres and rooms. A fire control room is a fire control centre in a dedicated room with additional specific requirements. **Clauses 2 to 5** apply to fire control centres (including fire control rooms). **Clauses 6 to 12** apply additional requirements to fire control rooms.

2. Purpose and content

A fire control centre must—

- (a) provide an area from which fire-fighting operations or other emergency procedures can be directed or controlled; and
- (b) contain controls, panels, telephones, furniture, equipment and the like associated with the *required* fire services in the building; and
- (c) not be used for any purpose other than the control of—
 - (i) fire-fighting activities; and
 - (ii) other measures concerning the occupant safety or security.

3. Location of fire control centre

A fire control centre must be so located in a building that egress from any part of its floor, to a public road or *open space*, does not involve changes in level which in aggregate exceed 300 mm.

4. Equipment not permitted within a fire control centre

An internal combustion engine, pumps, sprinkler control valves, pipes and pipe fittings must not be located in a fire control centre, but may be located in rooms accessed through the fire control centre.

5. Ambient sound level for a fire control centre

- (a) The ambient sound level within the fire control centre measured when all fire safety equipment is operating in the manner in which it operates in an emergency must not exceed 65 dB(A).
- (b) The measurement must be taken for a sufficient time to characterize the effects of all sound sources. Where there is not a great variation in noise level, a measurement time of 60 seconds may be used.

6. Construction of a fire control room

A fire control centre in a building more than 50 m in *effective height* must be in a separate room where—

Deemed-to-Satisfy Provisions

- (a) the enclosing construction is of concrete, masonry or the like, sufficiently impact resistant to withstand the impact of any likely falling debris, and with an FRL of not less than 120/120/120; and
- (b) any material used as a finish, surface, lining or the like within the room complies with the requirements of **Specification C1.10**; and
- (c) services, pipes, ducts and the like that are not directly *required* for the proper functioning of the fire control room do not pass through it; and
- (d) openings in the walls, floors or ceiling which separate the room from the interior of the building are confined to doorways, ventilation and other openings for services necessary for the proper functioning of the facility.

7. Protection of openings in a fire control room

Openings permitted by **Clause 6** must be protected as follows:

- (a) Openings for *windows*, doorways, ventilation, service pipes, conduits and the like, in an *external wall* of the building that faces a public road or *open space*, must be protected in accordance with the *Deemed-to-Satisfy Provisions* of **Part C3**.
- (b) Openings in the floors, ceilings and *internal walls* enclosing a fire control room must, except for doorways, be protected in accordance with the *Deemed-to-Satisfy Provisions* of **Part C3**.
- (c) A door opening in the *internal walls* enclosing a fire-control room, must be fitted with a *self closing* –/120/30 smoke sealed fire door.
- (d) Openings associated with natural or mechanical ventilation must—
 - (i) not be made in any ceiling or floor immediately above or below the fire control room; and
 - (ii) be protected by a –/120/– fire damper if the opening is for a duct through a wall *required* to have an FRL, other than an *external wall*.

8. Doors to a fire control room

- (a) *Required* doors to a fire control room must open into the room, be lockable and located so that persons using escape routes from the building will not obstruct or hinder access to the room.
- (b) The fire control room must be accessible via two paths of travel—
 - (i) one from the front entrance of the building; and
 - (ii) one direct from a public place or *fire-isolated passageway* which leads to a public place and has a door with an FRL of not less than –/120/30.

9. Size and contents of a fire control room

- (a) A fire control room must contain—
 - (i) a Fire Indicator Panel and necessary control switches and visual status indication for all *required* fire pumps, smoke control fans and other *required* fire safety equipment installed in the building; and
 - (ii) a telephone directly connected to an external telephone exchange; and

Deemed-to-Satisfy Provisions

- (iii) a blackboard or whiteboard not less than 1200 mm wide x 1000 mm high; and
 - (iv) a pin-up board not less than 1200 mm wide x 1000 mm high; and
 - (v) a raked plan layout table of a size suitable for laying out the plans provided under (vi); and
 - (vi) colour-coded, durable, tactical fire plans.
- (b) In addition, a fire control room may contain—
- (i) master emergency control panels, lift annunciator panels, remote switching controls for gas or electrical supplies and emergency generator backup; and
 - (ii) building security, surveillance and management systems if they are completely segregated from all other systems.
- (c) A fire control room must—
- (i) have a *floor area* of not less than 10 m² and the length of any internal side must be not less than 2.5 m; and
 - (ii) if only the minimum prescribed equipment is installed — have a net *floor area* of not less than 8 m² with a clear space of not less than 1.5 m² in front of the Fire Indicator Panel; and
 - (iii) if additional equipment is installed — have an additional area of not less than 2 m² net *floor area* for each additional facility and a clear space of not less than 1.5 m² in front of each additional control or indicator panel,

and the area *required* for any path of travel through the room to other areas must be provided in addition to the requirements (ii) and (iii).

10. Ventilation and power supply for a fire control room

A fire control room must be ventilated by—

- (a) natural ventilation from a *window* or doorway in an *external wall* of the building which opens directly into the fire control room from a roadway or *open space*; or
- (b) a pressurisation system that only serves the fire control room, and—
 - (i) is installed in accordance with AS/NZS 1668.1 as though the room is a *fire-isolated stairway*; and
 - (ii) is activated *automatically* by operation of the fire alarm, or sprinkler system complying with **Specification E1.5**, installed in the building and manually by an over-riding control in the room; and
 - (iii) provides a flow of fresh air through the room of not less than 30 air changes per hour when the system is operating and any door to the room is open; and
 - (iv) has fans, motors and ductwork that form part of the system but not contained within the fire control room protected by enclosing construction with an FRL of not less than 120/120/120; and
 - (v) has any electrical supply to the fire control room or equipment necessary for its operation connected to the supply side of the main disconnection switch for the building,

Deemed-to-Satisfy Provisions

and no openable devices other than necessary doorways, pressure controlled relief louvres and *windows* that are openable by a key, must be constructed in the fire control room.

11. Sign for a fire control room

The external face of the door to the fire control room must have a sign with the words—

FIRE CONTROL ROOM

in letters of not less than 50 mm high and of a colour which contrasts with that of the background.

12. Lighting for a fire control room

Emergency lighting in accordance with the *Deemed-to-Satisfy Provisions* of **Part E4** must be provided in a fire control room, except that an illumination level of not less than 400 lux must be maintained at the surface of the plan table.

PART E2 SMOKE HAZARD MANAGEMENT

OBJECTIVE

EO2

The *Objective* of this Part is to—

- (a) safeguard occupants from illness or injury by warning them of a fire so that they may safely evacuate; and
- (b) safeguard occupants from illness or injury while evacuating during a fire.

FUNCTIONAL STATEMENT

EF2.1

A building is to be provided with safeguards so that—

- (a) occupants are warned of a fire in the building so that they may safely evacuate; and
- (b) occupants have time to safely evacuate before the environment in any *evacuation route* becomes untenable from the effects of fire.

PERFORMANCE REQUIREMENTS

EP2.1

In a building providing sleeping accommodation, occupants must be provided with *automatic* warning on the detection of smoke so they may evacuate in the event of a fire to a *safe place*.

Application:

EP2.1 only applies to a Class 2, 3, 9a or 9c building or Class 4 part of a building.

EP2.2

- (a) In the event of a fire in a building the conditions in any *evacuation route* must be maintained for the period of time occupants take to evacuate the part of the building so that—
 - (i) the temperature will not endanger human life; and
 - (ii) the level of visibility will enable the *evacuation route* to be determined; and
 - (iii) the level of toxicity will not endanger human life.

- (b) The period of time occupants take to evacuate referred to in (a) must be appropriate to—
- (i) the number, mobility and other characteristics of the occupants; and
 - (ii) the function or use of the building; and
 - (iii) the travel distance and other characteristics of the building; and
 - (iv) the *fire load*; and
 - (v) the potential *fire intensity*; and
 - (vi) the *fire hazard*; and
 - (vii) any active *fire safety systems* installed in the building; and
 - (viii) *fire brigade* intervention.

Limitation:

EP2.2 does not apply to an *open-deck carpark* or *open spectator stand*.

PART E2

SMOKE HAZARD MANAGEMENT

Deemed-to-Satisfy Provisions

E2.0 Deemed-to-Satisfy Provisions

- (a) Where a *Building Solution* is proposed to comply with the *Deemed-to-Satisfy Provisions*, *Performance Requirements EP2.1* to *EP2.2* are satisfied by complying with—
- (i) **E2.1** to **E2.3**; and
 - (ii) in a building containing an *atrium*, **Part G3**.
- (b) Where a *Building Solution* is proposed as an *Alternative Solution* to the *Deemed-to-Satisfy Provisions* of—
- (i) **E2.1** to **E2.3**; and
 - (ii) in a building containing an *atrium*, **Part G3**,
- the relevant *Performance Requirements* must be determined in accordance with **A0.10**.

E2.1 Application of Part

- (a) The *Deemed-to-Satisfy Provisions* of this Part do not apply to—
- (i) any *open deck carpark*; or
 - (ii) any *open spectator stand*; or
 - (iii) a Class 8 *electricity network substation* with a *floor area* not more than 200 m², located within a multi-classified building.
- (b) The smoke exhaust and *smoke-and-heat vent* provisions of this Part do not apply to any area not used by occupants for an extended period of time such as a storeroom with a *floor area* less than 30 m², *sanitary compartment*, plant room or the like.

E2.2 General requirements

- (a) A building must comply with **(b)**, **(c)**, **(d)** and—
- (i) **Table E2.2a** as applicable to Class 2 to 9 buildings such that each separate part complies with the relevant provisions for the classification; and
 - (ii) **Table E2.2b** as applicable to Class 6 and 9b buildings such that each separate part complies with the relevant provisions for the classification.
- (b) An air-handling system which does not form part of a smoke hazard management system in accordance with **Table E2.2a** or **Table E2.2b** and which recycles air from one *fire compartment* to another *fire compartment* or operates in a manner that may unduly contribute to the spread of smoke from one *fire compartment* to another *fire compartment* must—
- (i) be designed and installed to operate as a smoke control system in accordance with AS/NZS 1668.1; or

Deemed-to-Satisfy Provisions

(ii)

- (A) incorporate smoke dampers where the air-handling ducts penetrate any elements separating the *fire compartments* served; and
- (B) be arranged such that the air-handling system is shut down and the smoke dampers are activated to close *automatically* by smoke detectors complying with clause 4.10 of AS/NZS 1668.1; and

for the purposes of this provision, each *sole-occupancy unit* in a Class 2 or 3 building is treated as a separate *fire compartment*.

- (c) Miscellaneous air-handling systems covered by Sections 5 and 11 of AS/NZS 1668.1 serving more than one *fire compartment* (other than a *carpark* ventilation system) and not forming part of a smoke hazard management system must comply with that Section of the Standard.
- (d) A smoke detection system must be installed in accordance with **Clause 5 of Specification E2.2a** to operate AS/NZS 1668.1 systems that are provided for zone smoke control and *automatic* air pressurisation for fire-isolated *exits*.

E2.3 Provision for special hazards

Additional smoke hazard management measures may be necessary due to the—

- (a) special characteristics of the building; or
- (b) special function or use of the building; or
- (c) special type or quantity of materials stored, displayed or used in a building; or
- (d) special mix of classifications within a building or *fire compartment*,

which are not addressed in **Tables E2.2a** and **E2.2b**.

NSW Table E2.2a

Table E2.2a GENERAL PROVISIONS

| FIRE-ISOLATED EXITS |
|---|
| <p>A <i>required</i>—</p> <ul style="list-style-type: none"> (a) <i>fire-isolated stairway</i>, including any associated <i>fire-isolated passageway</i> or <i>fire-isolated ramp</i> serving— <ul style="list-style-type: none"> (i) any <i>storey</i> above an <i>effective height</i> of 25 m; or (ii) more than 2 below ground <i>storeys</i>, not counted in the <i>rise in storeys</i> in accordance with C1.2; or (iii) an <i>atrium</i>; or (iv) a Class 9a building with a <i>rise in storeys</i> of more than 2; or (v) a Class 9c <i>aged care building</i> with a <i>rise in storeys</i> of more than 2; and (b) <i>fire-isolated passageway</i> or <i>fire-isolated ramp</i> with a length of travel more than 60 m to a road or <i>open space</i>, |

Deemed-to-Satisfy Provisions

Table E2.2a GENERAL PROVISIONS — continued

| |
|---|
| <p>must be provided with—</p> <p>(c) an <i>automatic</i> air pressurisation system for fire-isolated <i>exits</i> in accordance with AS/NZS 1668.1; or</p> <p>(d) open access ramps or balconies in accordance with D2.5.</p> |
| <p>Notes:</p> <ol style="list-style-type: none"> 1. An <i>automatic</i> air pressurisation system for fire-isolated <i>exits</i> applies to the entire <i>exit</i>. 2. Refer D1.7(d) for pressurisation of a fire-isolated <i>exit</i> having more than 2 access doorways from within the same <i>storey</i>. |
| BUILDINGS MORE THAN 25 M IN EFFECTIVE HEIGHT |
| CLASS 2 AND 3 BUILDINGS AND CLASS 4 PART OF A BUILDING |
| <p>A Class 2 and 3 building or part of a building and Class 4 part of a building must be provided with an <i>automatic</i> smoke detection and alarm system complying with Specification E2.2a.</p> |
| <p>Note: Refer C2.14 for division of <i>public corridors</i> greater than 40 m in length.</p> |
| CLASS 5, 6, 7b, 8 or 9b BUILDINGS |
| <p>A Class 5, 6, 7b, 8 or 9b building or part of a building must be provided with a zone smoke control system in accordance with AS/NZS 1668.1</p> |
| <p>Note: Refer Table E2.2b for Specific Provisions applicable to a Class 6 (in a <i>fire compartment</i> having a <i>floor area</i> of more than 2000 m²) and 9b building or part of a building.</p> |
| CLASS 9a BUILDINGS |
| <p>A Class 9a building must be provided with—</p> <p>(a) an <i>automatic</i> smoke detection and alarm system complying with Specification E2.2a; and</p> <p>(b) a zone smoke control system in accordance with AS/NZS 1668.1.</p> |
| <p>Note: A building more than 25 m in <i>effective height</i> requires a sprinkler system under E1.5.</p> |
| BUILDINGS NOT MORE THAN 25 M IN EFFECTIVE HEIGHT |
| CLASS 2 AND 3 BUILDINGS AND CLASS 4 PART OF A BUILDING |
| <p>A Class 2 and 3 building or part of a building and Class 4 part of a building—</p> <p>(a) must be provided with an <i>automatic</i> smoke detection and alarm system complying with Specification E2.2a; and</p> |

Deemed-to-Satisfy Provisions

Table E2.2a GENERAL PROVISIONS — *continued*

- (b) where a *required fire-isolated stairway* serving the Class 2 or 3 parts also serves one or more *storeys* of Class 5, 6, 7 (other than an *open deck carpark*), 8 or 9b parts—
- (i) the *fire-isolated stairway*, including any associated *fire-isolated passageway* or *fire-isolated ramp*, must be provided with an *automatic* air pressurisation system for fire-isolated *exits* in accordance with AS/NZS 1668.1; or
 - (ii) the Class 5, 6, 7 (other than an *open deck carpark*), 8 and 9b parts must be provided with—
 - (A) an *automatic* smoke detection and alarm system complying with **Specification E2.2a**; or
 - (B) a sprinkler system complying with **Specification E1.5**; and
- (c) where a *required fire-isolated stairway* serving the Class 4 part also serves one or more *storeys* of Class 5, 6, 7 (other than an *open deck carpark*), 8 or 9b parts—
- (i) a system complying with (b)(i) or (b)(ii) must be installed; or
 - (ii) a smoke alarm or detector system complying with **Specification E2.2a** must be provided except that alarms or detectors need only be installed adjacent to each doorway into each *fire-isolated stairway* (set back horizontally from the doorway by a distance of not more than 1.5 m) to initiate a building occupant warning system for the Class 4 part.

Notes:

1. Refer **C2.14** for division of *public corridors* greater than 40 m in length.
2. Refer **Table E2.2b** for Specific Provisions applicable to a Class 6 (in a *fire compartment* having a *floor area* of more than 2000 m²) and 9b building or part of a building.

CLASS 5, 6, 7b, 8 and 9b BUILDINGS

In a—

- (a) Class 5 or 9b *school* building or part of a building having a *rise in storeys* of more than 3; or
- (b) Class 6, 7b, 8 or 9b building (other than a *school*) or part of a building having a *rise in storeys* of more than 2; or
- (c) building having a *rise in storeys* of more than 2 and containing—
 - (i) a Class 5 or 9b *school* part; and
 - (ii) a Class 6, 7b, 8 or 9b (other than a *school*) part,

the building must be provided with—

- (d) in each *required fire-isolated stairway*, including any associated *fire-isolated passageway* or *fire-isolated ramp*, an *automatic* air pressurisation system for fire-isolated *exits* in accordance with AS/NZS 1668.1; or
- (e) a zone smoke control system in accordance with AS/NZS 1668.1, if the building has more than one *fire compartment*; or
- (f) an *automatic* smoke detection and alarm system complying with **Specification E2.2a**; or
- (g) a sprinkler system complying with **Specification E1.5**.

Deemed-to-Satisfy Provisions

Table E2.2a GENERAL PROVISIONS — continued

| LARGE ISOLATED BUILDINGS SUBJECT TO C2.3 | |
|--|---|
| (a) | <p>In a Class 7 or 8 building, which does not exceed 18 000 m² in <i>floor area</i> nor exceed 108 000 m³ in volume, the building must be provided with—</p> <ul style="list-style-type: none"> (i) a sprinkler system complying with Specification E1.5, and provided with perimeter vehicular access complying with C2.4(b); or (ii) an <i>automatic</i> fire detection and alarm system complying with AS 1670.1 and monitored in accordance with Clause 7 of Specification E2.2a; or (iii) an <i>automatic</i> smoke exhaust system in accordance with Specification E2.2b; or (iv) <i>automatic smoke-and-heat vents</i> in accordance with Specification E2.2c; or (v) natural smoke venting, with ventilation openings distributed as evenly as practicable and comprising permanent openings at roof level with a free area not less than 1.5% of <i>floor area</i> and low level openings which may be permanent or readily openable with a free area not less than 1.5% of <i>floor area</i>. |
| (b) | <p>In a Class 5, 6, 7, 8 or 9 building, which exceeds 18 000 m² in <i>floor area</i> or 108 000 m³ in volume, the building must be provided with—</p> <ul style="list-style-type: none"> (i) if the ceiling height of the <i>fire compartment</i> is not more than 12 m— <ul style="list-style-type: none"> (A) an <i>automatic</i> smoke exhaust system in accordance with Specification E2.2b; or (B) <i>automatic smoke-and-heat vents</i> in accordance with Specification E2.2c; or (ii) if the ceiling height of the <i>fire compartment</i> is more than 12 m, an <i>automatic</i> smoke exhaust system in accordance with Specification E2.2b. |
| Notes: | |
| <ol style="list-style-type: none"> 1. Refer Table E2.2b for Specific Provisions applicable to a Class 6 (in a <i>fire compartment</i> having a <i>floor area</i> of more than 2000 m²) and 9b building or part of a building. 2. Refer provisions under Class 2 and 3 buildings and Class 4 part of a building in this Table where a Class 5, 6, 7b, 8 and 9b building contains a Class 2, 3 or 4 part. 3. Reference to "the building" being provided with specified measures, means to the nominated classes within the building. For parts of the building of other classes, see other parts of this Table. | |
| CLASS 9a and 9c BUILDINGS | |
| <p>A Class 9a <i>health-care building</i> or a Class 9c <i>aged care building</i>, or a building containing a part thereof, must be provided throughout with—</p> | |
| (a) | <p>an <i>automatic</i> smoke detection and alarm system complying with Specification E2.2a; and</p> |

Deemed-to-Satisfy Provisions

Table E2.2a GENERAL PROVISIONS — *continued*

| |
|--|
| <p>(b) <i>automatic</i> shutdown of any air-handling system which does not form part of a zone smoke control system (other than individual room units with a capacity not more than 1000 L/s, systems serving critical treatment areas and miscellaneous exhaust air systems installed in accordance with Sections 5 and 11 of AS/NZS 1668.1) on the activation of—</p> <ul style="list-style-type: none"> (i) smoke detectors installed in accordance with (a); and (ii) any other installed fire detection and alarm system including a sprinkler system complying with Specification E1.5; and <p>(c) in a building having a <i>rise in storeys</i> of more than 2 and not more than 25 m <i>effective height</i> (not being a Class 9c <i>aged care building</i>)—</p> <ul style="list-style-type: none"> (i) a zone smoke control system in accordance with AS/NZS 1668.1; or (ii) a sprinkler system complying with Specification E1.5 throughout with residential sprinkler heads in <i>patient care areas</i>. |
| <p>Note: Refer to Clause 2 of Specification C2.5 for the provisions for smoke dampers.</p> |
| <p>CLASS 7a BUILDINGS</p> <p>A Class 7a building, including a basement, provided with a mechanical ventilation system in accordance with AS 1668.2 must comply with clause 5.5 of AS/NZS 1668.1 except that—</p> <ul style="list-style-type: none"> (a) fans with metal blades suitable for operation at normal temperature may be used; and (b) the electrical power and control cabling need not be fire rated. |
| <p>BASEMENTS (other than Class 7a buildings)</p> <p>A basement, not counted in the <i>rise in storeys</i> in accordance with C1.2, must—</p> <ul style="list-style-type: none"> (a) comply with measures in accordance with this Table applicable to the building generally; and (b) where the basement has a total <i>floor area</i> of more than 2000 m², be provided with— <ul style="list-style-type: none"> (i) if not more than 2 below ground <i>storeys</i>— <ul style="list-style-type: none"> (A) a zone smoke control system in accordance with AS/NZS 1668.1, if the basement has more than one <i>fire compartment</i>; or (B) an <i>automatic</i> smoke detection and alarm system complying with Specification E2.2a; or (C) a sprinkler system complying with Specification E1.5; or (ii) if more than 2 below ground <i>storeys</i>, a sprinkler system complying with Specification E1.5. |
| <p>Notes:</p> <ol style="list-style-type: none"> 1. Refer Table E2.2b for Specific Provisions applicable to a Class 6 (in a <i>fire compartment</i> having a <i>floor area</i> of more than 2000 m²) and 9b building or part of a building. 2. Basements with more than 3 below ground <i>storeys</i> or containing Class 6 or 9b occupancies with a large number of occupants may require special consideration in accordance with E2.3. |

Deemed-to-Satisfy Provisions

Table E2.2a GENERAL PROVISIONS — continued

| |
|------------------------|
| ATRIUMS |
| Refer Part G3 . |

NSW Table E2.2b

Table E2.2b SPECIFIC PROVISIONS

| |
|--|
| CLASS 6 BUILDINGS IN FIRE COMPARTMENTS MORE THAN 2000 m² |
| CLASS 6 BUILDINGS (not containing an enclosed common walkway or mall serving more than one Class 6 <i>sole-occupancy unit</i>) |
| <p>(a) Where the <i>floor area</i> of a Class 6 part of a <i>fire compartment</i> is more than 2000 m², the <i>fire compartment</i>, must be provided with—</p> <ul style="list-style-type: none"> (i) an <i>automatic</i> smoke exhaust system complying with Specification E2.2b; or (ii) <i>automatic smoke-and-heat vents</i> complying with Specification E2.2c, if the building is single <i>storey</i>; or (iii) if the <i>floor area</i> of the <i>fire compartment</i> is not more than 3500 m² and the building— <ul style="list-style-type: none"> (A) is single <i>storey</i>, an <i>automatic</i> smoke detection and alarm system complying with Specification E2.2a; or (B) has a <i>rise in storeys</i> of not more than 2, a sprinkler system complying with Specification E1.5. <p>(b) The provisions of (a) do not apply to—</p> <ul style="list-style-type: none"> (i) a Class 6 <i>sole-occupancy unit</i> that— <ul style="list-style-type: none"> (A) has a <i>floor area</i> of not more than 2000 m²; and (B) is single <i>storey</i> with a main public entrance opening to a road or <i>open space</i>; and (C) is separated from other parts of the <i>fire compartment</i> by construction, including openings, penetrations and junctions with other building elements, that prevents the free passage of smoke; and (ii) parts of any other classification that are smoke separated from a Class 6 part by construction complying with (i)(C). |
| CLASS 6 BUILDINGS (containing an enclosed common walkway or mall serving more than one Class 6 <i>sole-occupancy unit</i>) |
| <p>(a) Where the <i>floor area</i> of a Class 6 part of a <i>fire compartment</i> is more than 2000 m², the <i>fire compartment</i>, including the enclosed common walkway or mall, must be provided with—</p> <ul style="list-style-type: none"> (i) an <i>automatic</i> smoke exhaust system complying with Specification E2.2b; or (ii) <i>automatic smoke-and-heat vents</i> complying with Specification E2.2c, if the building is single <i>storey</i>; or (iii) if the <i>floor area</i> of the <i>fire compartment</i> is not more than 3500 m² and the building has a <i>rise in storeys</i> of not more than 2, a sprinkler system complying with Specification E1.5. |

Deemed-to-Satisfy Provisions

Table E2.2b SPECIFIC PROVISIONS — *continued*

| |
|--|
| <p>(b) The provisions of (a) do not apply to—</p> <ul style="list-style-type: none"> (i) a Class 6 <i>sole-occupancy unit</i> that— <ul style="list-style-type: none"> (A) opens onto the enclosed common walkway or mall if the Class 6 <i>sole-occupancy unit</i> has a <i>floor area</i> of not more than 1000 m²; or (B) does not open onto the enclosed common walkway or mall if the Class 6 <i>sole-occupancy unit</i>— <ul style="list-style-type: none"> (aa) has a <i>floor area</i> of not more than 2000 m²; and (bb) is single <i>storey</i> with a main entrance opening to a road or <i>open space</i>; and (cc) is separated from other parts of the <i>fire compartment</i> by construction, including openings, penetrations and junctions with other building elements, that prevents the free passage of smoke; and (ii) parts of any other classification that are smoke separated from a Class 6 part by construction complying with (i)(B)(cc). |
| <p>Note: A <i>fire compartment</i> having a <i>floor area</i> of more than 3500 m² in a Class 6 building requires a sprinkler system under E1.5.</p> |
| <p>CLASS 9b ASSEMBLY BUILDINGS</p> |
| <p>NIGHTCLUBS and DISCOTHEQUES AND THE LIKE</p> |
| <p>A building or part of a building used as a nightclub, discotheque or the like must be provided with—</p> <ul style="list-style-type: none"> (a) <i>automatic</i> shutdown of any air-handling system (other than miscellaneous exhaust air systems installed in accordance with Sections 5 and 11 of AS/NZS 1668.1) which does not form part of the smoke hazard management system, on the activation of— <ul style="list-style-type: none"> (i) smoke detectors installed complying with Clause 5 of Specification E2.2a; and (ii) any other installed fire detection and alarm system, including a sprinkler system complying with Specification E1.5; and (b) <ul style="list-style-type: none"> (i) an <i>automatic</i> smoke exhaust system complying with Specification E2.2b; or (ii) <i>automatic smoke-and-heat vents</i> complying with Specification E2.2c, if the building is single <i>storey</i>; or (iii) a sprinkler system complying with Specification E1.5 with fast response sprinkler heads. |
| <p>EXHIBITION HALLS</p> |
| <p>A building or part of a building used as an exhibition hall must be provided with—</p> <ul style="list-style-type: none"> (a) <i>automatic</i> shutdown of any air-handling system (other than miscellaneous exhaust air systems installed in accordance with Sections 5 and 11 of AS/NZS 1668.1) which does not form part of the smoke hazard management system, on the activation of— <ul style="list-style-type: none"> (i) smoke detectors installed complying with Specification E2.2a; and (ii) any other installed fire detection and alarm system, including a sprinkler system complying with Specification E1.5; and |

Deemed-to-Satisfy Provisions

Table E2.2b SPECIFIC PROVISIONS — *continued*

| |
|---|
| <p>(b) where the <i>floor area</i> is more than 2000 m² and not more than 3500 m²—</p> <ul style="list-style-type: none"> (i) an <i>automatic</i> smoke exhaust system complying with Specification E2.2b; or (ii) <i>automatic smoke-and-heat vents</i> complying with Specification E2.2c, if the building is single <i>storey</i>; or (iii) a sprinkler system complying with Specification E1.5; and <p>(c) where the <i>floor area</i> is more than 3500 m², a sprinkler system complying with Specification E1.5 and—</p> <ul style="list-style-type: none"> (i) an <i>automatic</i> smoke exhaust system complying with Specification E2.2b; or (ii) <i>automatic smoke-and-heat vents</i> complying with Specification E2.2c, if the building is single <i>storey</i>. |
| THEATRES and PUBLIC HALLS |
| <p>A building or part of a building used as a theatre or public hall which—</p> <ul style="list-style-type: none"> (a) is a <i>school</i> assembly, church or community hall, and has a <i>stage</i> and any <i>backstage</i> area with a total <i>floor area</i> of more than 300 m²; or (b) is not a <i>school</i> assembly, church or community hall, and has a <i>stage</i> and any <i>backstage</i> area with a total <i>floor area</i> of more than 200 m²; or (c) has a <i>stage</i> with an associated rigging loft— <p>must be provided with—</p> <ul style="list-style-type: none"> (i) an <i>automatic</i> smoke exhaust system complying with Specification E2.2b; or (ii) <i>automatic smoke-and-heat vents</i> complying with Specification E2.2c, if the building is single <i>storey</i>. |
| THEATRES and PUBLIC HALLS (not listed above) INCLUDING LECTURE THEATRES AND CINEMA/AUDITORIUM COMPLEXES |
| <p>A building or part of a building used as a theatre or public hall (not listed above) including a lecture theatre and cinema/auditorium complex—</p> <ul style="list-style-type: none"> (a) must be provided with <i>automatic</i> shutdown of any air-handling system (other than miscellaneous exhaust air systems installed in accordance with Sections 5 and 11 of AS/NZS 1668.1) which does not form part of the smoke hazard management system, on the activation of— <ul style="list-style-type: none"> (i) smoke detectors installed complying with Specification E2.2a; and (ii) any other installed fire detection and alarm system, including a sprinkler system complying with Specification E1.5; and |

Deemed-to-Satisfy Provisions

Table E2.2b SPECIFIC PROVISIONS — *continued*

| |
|---|
| <p>(b) other than in the case of a <i>school</i> lecture theatre, where the <i>floor area</i> of the <i>fire compartment</i> is more than 2000 m²—</p> <ul style="list-style-type: none"> (i) an <i>automatic</i> smoke exhaust system complying with Specification E2.2b; or (ii) <i>automatic smoke-and-heat vents</i> complying with Specification E2.2c, if the building is single <i>storey</i>; or (iii) if the <i>floor area</i> of the <i>fire compartment</i> is not more than 5000 m² and the building has a <i>rise in storeys</i> of not more than 2— <ul style="list-style-type: none"> (A) an <i>automatic</i> smoke detection and alarm system complying with Specification E2.2a; or (B) a sprinkler system complying with Specification E1.5. |
| OTHER ASSEMBLY BUILDINGS (not listed above) and EXCLUDING SCHOOLS |
| <p>(a) Each <i>fire compartment</i>, other than one in a building described in (b), having a <i>floor area</i> of more than 2000 m² must be provided with—</p> <ul style="list-style-type: none"> (i) an <i>automatic</i> smoke exhaust system complying with Specification E2.2b; or (ii) <i>automatic smoke-and-heat vents</i> complying with Specification E2.2c, if the building is single <i>storey</i>; or (iii) if the <i>floor area</i> of the <i>fire compartment</i> is not more than 5000 m² and the building has a <i>rise in storeys</i> of not more than 2— <ul style="list-style-type: none"> (A) an <i>automatic</i> smoke detection and alarm system complying with Specification E2.2a; or (B) a sprinkler system complying with Specification E1.5. <p>(b) The following buildings are exempt from the provisions of (a):</p> <ul style="list-style-type: none"> (i) Sporting complexes (including sports halls, gymnasiums, <i>swimming pools</i>, ice and roller rinks, and the like) other than an indoor sports stadium with a total spectator seating for more than 1000. (ii) Churches and other places used solely for religious worship. |

SPECIFICATION **E2.2a** SMOKE DETECTION AND ALARM SYSTEMS

Deemed-to-Satisfy Provisions

1. Scope

This Specification describes the installation and operation of *automatic* smoke detection and alarm systems.

2. Type of system

A *required automatic* smoke detection and alarm system must comply with the following:

- (a) **Class 2 and 3 buildings and Class 4 parts of a building:**
 - (i) Subject to (ii), a Class 2 and 3 building and Class 4 part of a building must be provided with—
 - (A) a smoke alarm system complying with **Clause 3**; or
 - (B) a smoke detection system complying with **Clause 4**; or
 - (C) a combination of a smoke alarm system complying with **Clause 3** within *sole-occupancy units* and a smoke detection system complying with **Clause 4** in areas not within the *sole-occupancy units*.
 - (ii) A Class 3 building must be provided with a smoke detection system complying with **Clause 4** if it—
 - (A) has a Class 3 part located more than 2 *storeys* above ground level; or
 - (B) accommodates more than 20 residents and is used as a residential part of a *school* or accommodation for the aged, children or people with disabilities.
- (b) **Class 5, 6, 7, 8 and 9b buildings:** A smoke detection system complying with **Clause 4**.
- (c) **Class 9a health-care building:**
 - (i) Where 6 or less bed patients are accommodated—
 - (A) a smoke alarm system complying with **Clause 3**; or
 - (B) a smoke detection system complying with **Clause 4**.
 - (ii) Where more than 6 bed patients are accommodated, a smoke detection system complying with **Clause 4**.
- (d) **Class 9c aged care building:** A smoke detection system complying with **Clause 4**.

3. Smoke alarm system

- (a) A smoke alarm system must—
 - (i) consist of smoke alarms complying with AS 3786; and
 - (ii) be powered from the consumers mains source.
- (b) In kitchens and other areas where the use of the area is likely to result in smoke alarms causing spurious signals—

Deemed-to-Satisfy Provisions

- (i) any other alarm deemed suitable in accordance with AS 1670.1 may be installed provided that smoke alarms are installed elsewhere in the *sole-occupancy unit* in accordance with **Clause 3(c)(i)**; or
- (ii) an alarm acknowledgement facility may be installed,
except where the kitchen or other area is sprinklered, the alarms need not be installed in the kitchen or other areas likely to result in spurious signals.
- (c) In a Class 2 or 3 building or Class 4 part of a building, smoke alarms must be installed—
 - (i) within each *sole-occupancy unit*, located on or near the ceiling in any *storey*—
 - (A) containing bedrooms—
 - (aa) between each part of the *sole-occupancy unit* containing bedrooms and the remainder of the *sole-occupancy unit*; and
 - (bb) where bedrooms are served by a hallway, in that hallway; and
 - (B) not containing any bedrooms, in egress paths; and
 - (ii) in a building not protected with a sprinkler system, in *public corridors* and other internal public spaces, located in accordance with the requirements for smoke detectors in AS 1670.1 and connected to activate a building occupant warning system in accordance with **Clause 6**; and
- (d) In a Class 9a building, smoke alarms must be installed in every room, *public corridor* and other internal public spaces and—
 - (i) be located in accordance with the requirements for smoke detectors in AS 1670.1 and interconnected to provide a common alarm; and
 - (ii) have manual call points installed in *evacuation routes* so that no point on a floor is more than 30 m from a manual call point.

4. Smoke detection system

- (a) A smoke detection system must—
 - (i) subject to **(c)** and **(d)**, comply with AS 1670.1 except for the provisions of—
 - (A) Clause 3.26(f); and
 - (B) * * * * *
 - (C) * * * * *
 - (ii) activate a building occupant warning system in accordance with **Clause 6**.
- (b) In kitchens and other areas where the use of the area is likely to result in smoke detectors causing spurious signals—
 - (i) any other detector deemed suitable in accordance with AS 1670.1 may be installed provided that smoke detectors are installed elsewhere in the *sole-occupancy unit* in accordance with **Clause 3(c)(i)**; or
 - (ii) an alarm acknowledgement facility may be installed,
except where the kitchen or other area is sprinklered, the detectors need not be installed in the kitchen or other areas likely to result in spurious signals.

Deemed-to-Satisfy Provisions

- (c) In a Class 2 or 3 building or Class 4 part of a building smoke detectors must be installed—
 - (i) within each *sole-occupancy unit*, located in accordance with the requirements for smoke alarms in **Clause 3(c)(i)**; and
 - (ii) in a building not protected with a sprinkler system, in *public corridors* and other internal public spaces.
- (d) In a Class 9a *health-care building*—
 - (i)
 - (A) photoelectric type smoke detectors must be installed in *patient care areas* and in paths of travel to *exits* from *patient care areas*; and
 - (B) in areas other than *patient care areas* and paths of travel to *exits* from *patient care areas*, where the use of the area is likely to result in smoke detectors causing spurious signals, any other detector deemed suitable in accordance with AS 1670.1 may be installed in lieu of smoke detectors, except that the detectors need not be installed if the area is sprinklered; and
 - (ii) manual call points must be installed in *evacuation routes* so that no point on a floor is more than 30 m from a manual call point.

Vic Spec E2.2a 4(e)

- (e) In a Class 9c *aged care building*—
 - (i) remote automatic indication of each zone must be given in each smoke compartment by means of—
 - (A) mimic panels with an illuminated display; or
 - (B) annunciator panels with alpha numeric display; and
 - (ii) if the building accommodates more than 20 residents, manual call points must be installed in paths of travel so that no point on a floor is more than 30 m from a manual call point.

5. Smoke detection for smoke control systems

- (a) Smoke detectors *required* to activate air pressurisation systems for fire-isolated *exits* and zone smoke control systems must—
 - (i) be installed in accordance with AS/NZS 1668.1; and
 - (ii) have additional smoke detectors installed adjacent to each bank of lift landing doors set back horizontally from the door openings by a distance of not more than 3 m.
- (b) Smoke detectors *required* to activate—
 - (i) *automatic* shutdown of air-handling systems in accordance with **Table E2.2b**; or
 - (ii) a smoke exhaust system in accordance with **Specification E2.2b**,
must—
 - (iii) be spaced—
 - (A) not more than 20 m apart and not more than 10 m from any wall, bulkhead or smoke curtain; and

Deemed-to-Satisfy Provisions

- (B) in enclosed malls and walkways in a Class 6 building not more than 15 m apart and not more than 7.5 m from any wall, bulkhead or curtain; and
- (iv) have a sensitivity—
 - (A) in accordance with AS/NZS 1668.1 in areas other than a multi-storey walkway and mall in a Class 6 building; and
 - (B) not exceeding 0.5% smoke obscuration per metre with compensation for external airborne contamination as necessary, in a multi-storey walkway and mall in a Class 6 building.
- (c) Smoke detectors provided to activate a smoke control system must—
 - (i)
 - (A) form part of a building fire or smoke detection system complying with AS 1670.1; or
 - (B) be a separate dedicated system incorporating control and indicating equipment complying with AS 1670.1; and
 - (ii) activate a building occupant warning system complying with **Clause 6**, except that smoke detectors provided solely to initiate *automatic* shutdown of air-handling systems in accordance with **(b)(i)** need not activate a building occupant warning system.

6. Building occupant warning system

Subject to **E4.9**, a building occupant warning system provided as part of a smoke hazard management system must comply with clause 3.22 of AS 1670.1 to sound through all occupied areas except—

- (a) in a Class 2 and 3 building or Class 4 part of a building provided with a smoke alarm system in accordance with **Clause 3(c)(ii)**—
 - (i) the sound pressure level need not be measured within a *sole-occupancy unit* if a level of not less than 85 dB(A) is provided at the door providing access to the *sole-occupancy unit*; and
 - (ii) the inbuilt sounders of the smoke alarms may be used to wholly or partially meet the requirements; and
- (b) in a Class 2 and 3 building or Class 4 part of a building provided with a smoke detection system in accordance with **Clause 4(c)**, the sound pressure level from a warning system need not be measured within a *sole-occupancy unit* if a level of not less than 100 dB(A) is provided at the door providing access to the *sole-occupancy unit*; and
- (c) in a Class 3 building used as a *residential aged care building*, the system—
 - (i) must be arranged to provide a warning for occupants; and
 - (ii) in areas used by residents, may have its alarm adjusted in volume and content to minimise trauma consistent with the type and condition of residents; and
- (d) in a Class 9a *health-care building*, in a *patient care area*, the system—
 - (i) must be arranged to provide a warning for occupants; and
 - (ii) in a *ward area*, may have its alarm adjusted in volume and content to minimise trauma consistent with the type and condition of the patients.

Deemed-to-Satisfy Provisions

- (e) in a Class 9c *aged care building*, the system—
 - (i) must be arranged to provide a warning for occupants; and
 - (ii) must notify staff caring for the residents of the building; and
 - (iii) in areas used by residents, may have its alarm adjusted in volume and content to minimise trauma consistent with the type and condition of resident.

7. System monitoring

The following installations must be connected to a fire alarm monitoring system connected to a fire station or fire station dispatch centre in accordance with AS 1670.3:

- (a) A smoke detection system in a Class 3 building provided in accordance with **Clause 2(a)(ii)**.
- (b) A smoke detection system in a Class 9a *health-care building*, if the building accommodates more than 20 patients.

Vic Spec E2.2a 7(b)

- (c) A smoke detection system in a Class 9c *aged care building*.

Vic Spec E2.2a 7(c)

- (d) Smoke detection in accordance with **Clause 5** provided to activate—
 - (i) a smoke exhaust system in accordance with **Specification E2.2b**; or
 - (ii) *smoke-and-heat vents* in accordance with **Specification E2.2c**.

NSW Spec E2.2a 7(e)

- (e) An *automatic* fire detection and alarm system *required* by **Table E2.2a** for large isolated buildings subject to **C2.3**.

SPECIFICATION E2.2b SMOKE EXHAUST SYSTEMS

Deemed-to-Satisfy Provisions

1. Scope

This Specification describes the requirements for mechanical smoke exhaust systems.

2. Smoke exhaust capacity

- (a) Smoke exhaust fans must have a sufficient capacity to contain the smoke layer—
 - (i) within a smoke reservoir formed in accordance with **Clause 4** and not less than 2 m above the highest floor level; and
 - (ii) above the top of any openings interconnecting different smoke reservoirs.
- (b) Exhaust rates must be determined in accordance with **Figure 2**, with the height measurement taken from the lowest floor level to the underside of the smoke layer.

3. Smoke exhaust fans

Each smoke exhaust fan, complete with its drive, flexible connections, control gear and wiring must—

- (a) be constructed and installed so that it is capable of continuous operation (exhausting the *required* volumetric flow rate at the installed system resistance) at a temperature of 200° C for a period of not less than 1 hour; and
- (b) in a building not fitted with a sprinkler system, be capable of continuous operation at a temperature of 300° C for a period of not less than 30 minutes; and
- (c) be rated to handle the *required* volumetric flow rate at ambient temperature to be capable of exhausting cool smoke during the early stages of a fire and to allow routine testing; and
- (d) have any high temperature overload devices installed, *automatically* overridden during the smoke exhaust operation.

Deemed-to-Satisfy Provisions

Figure 2

SMOKE EXHAUST RATE

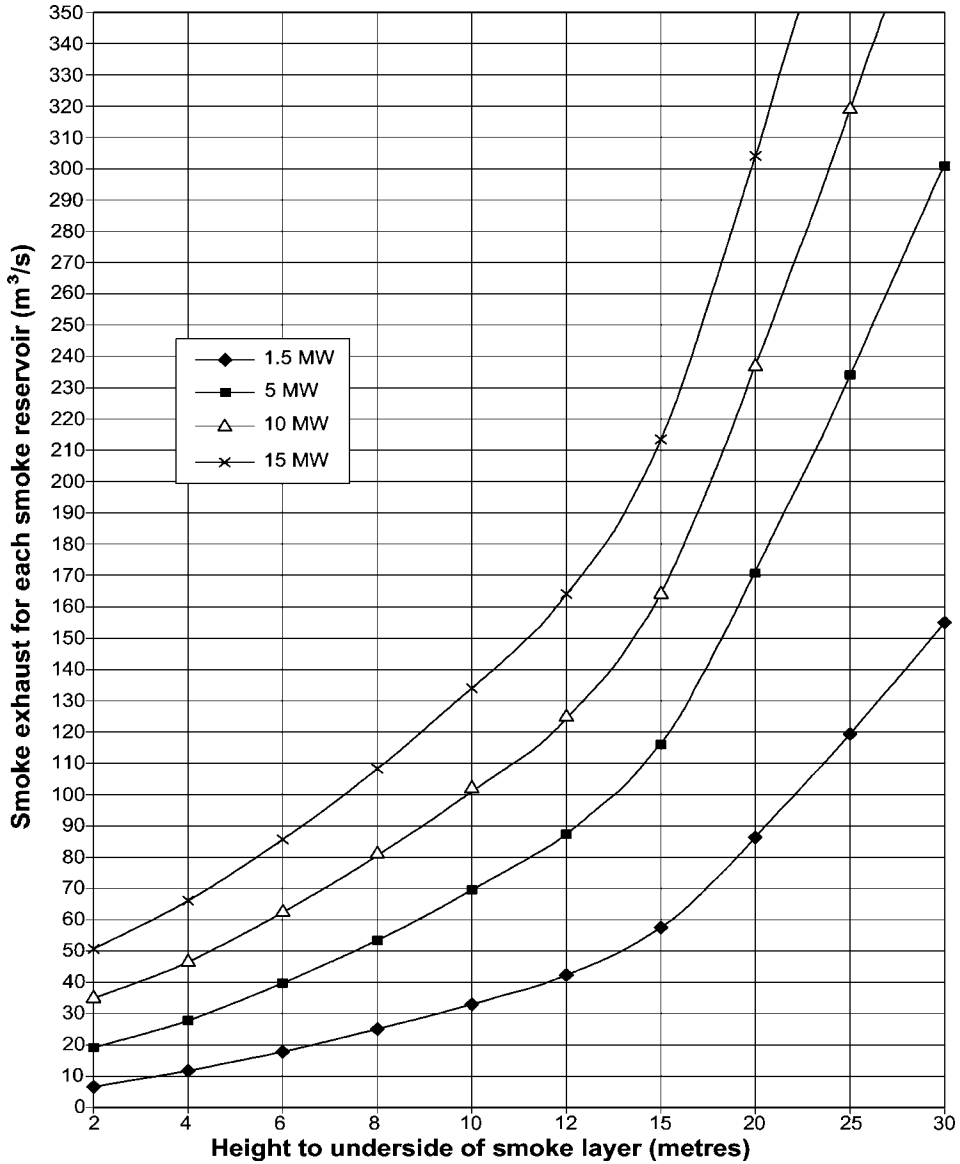

| Classification | Fire Load (MW) | |
|-----------------|----------------|-------------|
| | Unsprinklered | Sprinklered |
| Class 2, 3 or 5 | 5 | 1.5 |
| Class 6 | 10 | 5 |
| Class 7 or 8 | 15 | 5 |
| Class 9— | | |

Deemed-to-Satisfy Provisions

Figure 2

SMOKE EXHAUST RATE

| | | |
|---|----|-----|
| Generally | 5 | 1.5 |
| Theatres, stages, and public halls covered by Part H1 (see Note), or exhibition halls. | 10 | 5 |

Note: If the smoke reservoir above the *stage* is smoke separated from the audience area, the *fire load* specified applies to the *stage* area only and the *fire load* for the audience area is as per Class 9 generally.

4. Smoke reservoirs

- (a) A *fire compartment* must be divided at ceiling level into smoke reservoirs formed by smoke baffles/curtains of *non-combustible* and non-shatterable construction.
- (b) The horizontal area of a smoke reservoir must not exceed 2000 m² and in enclosed walkways and malls of a Class 6 building must not exceed 60 m in length.
- (c) Smoke reservoirs must be of sufficient depth to contain the smoke layer and must not be less than 500 mm below an imperforate ceiling or roof.
- (d)
 - (i) Within a multi-*storey fire compartment*, a *non-combustible* bulkhead or smoke baffle/curtain must be provided around the underside of each opening into a building void to minimise the spread of smoke to other *storeys*.
 - (ii) The depth of the bulkhead or smoke baffle must be not less than the depth of the smoke reservoir provided under (c) plus an additional 400 mm.

5. Smoke exhaust fan and vent location

Smoke exhaust fans and vents must be located—

- (a) such that each smoke reservoir is served by one or more fans with the maximum exhaust rate at any one point limited to avoid extracting air from below the smoke layer; and
- (b) to prevent the formation of stagnant regions resulting in excessive cooling and downward mixing of smoke; and
- (c) at natural collection points for the hot smoky gases within each smoke reservoir having due regard to the ceiling geometry and its effect on the migratory path of the smoke; and
- (d) away from the intersection of walkways or malls; and
- (e) to ensure that any voids containing escalators and/or stairs commonly used by the public are not used as a smoke exhaust path; and
- (f) to discharge directly to outdoor with a velocity of not less than 5 m/s, at a suitable point not less than 6 m from any air intake point or *exit*.

6. Make-up air

- (a) Low level make-up air must be provided either *automatically* or via permanent ventilation openings to replace the air exhausted so as to minimise—

Deemed-to-Satisfy Provisions

- (i) any disturbance of the smoke layer due to turbulence created by the incoming air; and
 - (ii) the risk of smoke migration to areas remote from the fire due to the effect of make-up air on the air balance of the total system.
- (b) The velocity of make-up air through doorways must not exceed 2.5 m/s.
- (c) Within a multi-*storey fire compartment*, make-up air must be provided across each vertical opening from a building void to the fire-affected *storey* at an average velocity of 1 m/s so as to minimise the spread of smoke from the fire-affected *storey* to other *storeys*.

7. Smoke exhaust system control

- (a) Each smoke exhaust fan must be activated sequentially by smoke detectors complying with **Specification E2.2a** and arranged in zones to match the smoke reservoir served by the fan(s).
- (b) Subject to (c) and (d), an air handling system (other than individual room units less than 1000 l/s and miscellaneous exhaust air systems installed in accordance with Sections 5 and 11 of AS/NZS 1668.1) which does not form part of the smoke hazard management system must be *automatically* shut down on the activation of the smoke exhaust system.
- (c) In a single *storey fire compartment*, air handling systems in all non fire-affected zones may operate on 100% *outdoor air* to provide make-up air to the fire-affected zone.
- (d) Within a multi-*storey fire compartment*, air handling systems in all non fire-affected zones and *storeys* must operate at 100% *outdoor air* to provide make-up air to the fire-affected *storey* via building voids connecting *storeys*.
- (e) Manual override control and indication together with operating instructions for use by emergency personnel must be provided adjacent to the fire indicator panel in accordance with the requirements of clauses 4.13 and 4.15 of AS/NZS 1668.1.
- (f) Manual control for the smoke exhaust system must also be provided at a location normally used by the *stage* manager in a theatre.
- (g) Power supply wiring to exhaust fans together with detection, control, and indication circuits (and where necessary to *automatic* make-up air supply arrangements) must comply with AS/NZS 1668.1.

8. Smoke detection

A smoke detection system must be installed in accordance with **Specification E2.2a** to activate the smoke exhaust system.

SPECIFICATION **E2.2c** SMOKE-AND-HEAT VENTS

Deemed-to-Satisfy Provisions

1. Adoption of AS 2665

Automatic smoke-and-heat vents must be installed as a system complying with AS 2665 except that—

- (a) * * * * *
- (b) * * * * *
- (c) permanently open vents may form part of the smoke/heat venting system provided they comply with the relevant criteria for *automatic smoke-and-heat vents* in AS 2665.

2. Controls

Where a *smoke-and-heat vent* system is installed to comply with **Table E2.2b**, the following must apply:

- (a) In addition to thermally released link operation, *smoke-and-heat vents* must also be initiated by smoke detection complying with **Clauses 5 and 7 of Specification E2.2a** and arranged in zones to match the smoke reservoirs.
- (b) * * * * *
- (c) * * * * *

3. * * * * *

PART E3 LIFT INSTALLATIONS

OBJECTIVE

EO3

The *Objective* of this Part is to—

- (a) facilitate the safe movement of occupants; and
- (b) facilitate access for emergency services personnel to carry out emergency procedures and assist in the evacuation of occupants.

FUNCTIONAL STATEMENTS

EF3.1

Where a passenger lift is provided, it is to facilitate safe and easy—

- (a) movement for occupants with a disability; and
- (b) evacuation of occupants, who due to illness or injury need stretcher assistance.

EF3.2

A building is to be provided with one or more passenger lifts to facilitate—

- (a) the safe access for emergency services personnel; and
- (b) safe and easy evacuation of occupants who due to illness, injury or disability cannot use stairways in the event of an emergency.

Application:

EF3.2 only applies to—

- (a) a building with an *effective height* of more than 25 m; and
- (b) a Class 9a building in which *patient care areas* are located above a level with direct access to a road or *open space*.

EF3.3

A building having a passenger lift is to be provided with measures to alert occupants about the use of the lift in an emergency.

| |
|---------------------------------|
| PERFORMANCE REQUIREMENTS |
|---------------------------------|

EP3.1

Stretcher facilities must be provided, to the degree necessary—

- (a) in at least one emergency lift *required* by EP3.2; or
- (b) where an emergency lift is not *required* and a passenger lift is provided, in at least one lift, to serve each floor in the building served by the passenger lift.

EP3.2

One or more passenger lifts fitted as emergency lifts to serve each floor served by the lifts in a building must be installed to facilitate the activities of the *fire brigade* and other emergency services personnel.

Application:

EP3.2 only applies to—

- (a) a building with an *effective height* of more than 25 m; and
- (b) a Class 9a building in which *patient care areas* are located at a level that does not have direct access to a road or *open space*.

EP3.3

Signs or other means must be provided to alert occupants about the use of a lift during an emergency.

EP3.4

When a passenger lift is provided in a building *required* to be *accessible*, it must be suitable for use by people with a disability.

PART E3

LIFT INSTALLATIONS

Deemed-to-Satisfy Provisions

E3.0 Deemed-to-Satisfy Provisions

- (a) Where a *Building Solution* is proposed to comply with the *Deemed-to-Satisfy Provisions*, *Performance Requirements EP3.1* to *EP3.4* are satisfied by complying with—
- (i) **E3.1** to **E3.10**; and
 - (ii) for public transport buildings, **Part H2**.
- (b) Where a *Building Solution* is proposed as an *Alternative Solution* to the *Deemed-to-Satisfy Provisions* of **E3.1** to **E3.10** and **Part H2**, the relevant *Performance Requirements* must be determined in accordance with **A0.10**.

E3.1 Lift installations

An *electric passenger lift* installation and an *electrohydraulic passenger lift* installation must comply with **Specification E3.1**.

E3.2 Stretcher facility in lifts

- (a) A stretcher facility in accordance with **(b)** must be provided—
- (i) in at least one emergency lift *required* by **E3.4**; or
 - (ii) where an emergency lift is not *required*, if passenger lifts are installed to serve any storey above an *effective height* of 12 m, in at least one of those lifts to serve each floor served by the lifts.
- (b) A stretcher facility must accommodate a raised stretcher with a patient lying on it horizontally by providing a clear space not less than 600 mm wide x 2000 mm long x 1400 mm high above the floor level.

E3.3 Warning against use of lifts in fire

A warning sign must—

- (a) be displayed where it can be readily seen—
- (i) near every call button for a passenger lift or group of lifts throughout a building; except
 - (ii) a small lift such as a dumb-waiter or the like that is for the transport of goods only; and
- (b) comply with the details and dimensions of **Figure E3.3** and consist of—
- (i) incised, inlaid or embossed letters on a metal, wood, plastic or similar plate securely and permanently attached to the wall; or
 - (ii) letters incised or inlaid directly into the surface of the material forming the wall.

Deemed-to-Satisfy Provisions

Figure E3.3

WARNING SIGN FOR PASSENGER LIFTS

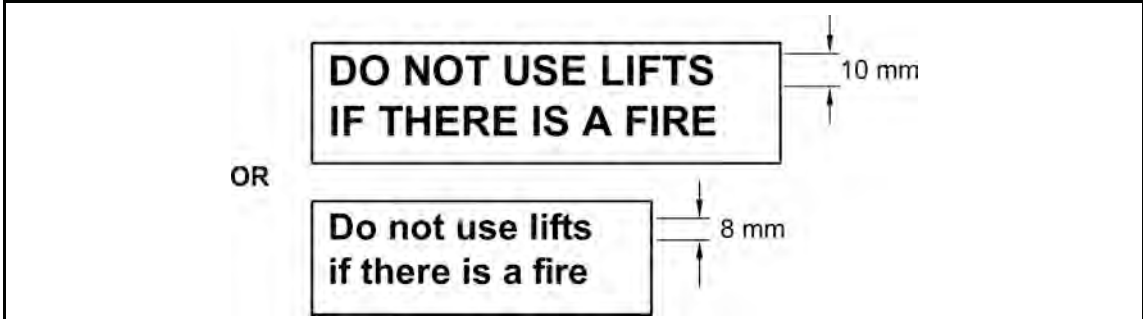

E3.4 Emergency lifts

- (a) At least one emergency lift complying with (e) must be installed in—
 - (i) a building which has an *effective height* of more than 25 m; and
 - (ii) a Class 9a building in which *patient care areas* are located at a level that does not have direct egress to a road or *open space*.
- (b) An emergency lift may be combined with a passenger lift and must serve those *storeys* served by the passenger lift so that all *storeys* of the building served by passenger lifts are served by at least one emergency lift.
- (c) Where two or more passenger lifts are installed and serve the same *storeys*, excluding a lift that is within an *atrium* and not contained wholly within a *shaft*—
 - (i) at least two emergency lifts must be provided to serve those *storeys*; and
 - (ii) if located within different *shafts*, at least one emergency lift must be provided in each *shaft*.
- (d) An emergency lift must—
 - (i) be contained within a *fire-resisting shaft* in accordance with C2.10; and
 - (ii) in a Class 9a building serving a *patient care area*—
 - (A) have minimum dimensions, measured clear of all obstructions, including handrails, etc complying with Table E3.4; and
 - (B) be connected to a standby power supply system where installed; and
 - (iii) if the building has an *effective height* of more than 75 m, have a rating of at least—
 - (A) 600 kg if not provided with a stretcher facility; or
 - (B) 900 kg if provided with a stretcher facility.

Deemed-to-Satisfy Provisions

Table E3.4 MINIMUM EMERGENCY LIFT DIMENSIONS IN CLASS 9a BUILDINGS

| | |
|---------------------------------|---------|
| Minimum depth of car | 2280 mm |
| Minimum width of car | 1600 mm |
| Minimum floor to ceiling height | 2300 mm |
| Minimum door height | 2100 mm |
| Minimum door width | 1300 mm |

E3.5 Landings

Access and egress to and from liftwell landings must comply with the *Deemed-to-Satisfy Provisions* of **Section D**.

E3.6 Passenger lifts

In an *accessible* building, every passenger lift must—

- (a) be one of the types identified in **Table E3.6a**, subject to the limitations on use specified in the Table; and
- (b) have *accessible* features in accordance with **Table E3.6b**; and
- (c) not rely on a constant pressure device for its operation if the lift car is fully enclosed.

Table E3.6a LIMITATIONS ON USE OF TYPES OF PASSENGER LIFTS

| Lift type | Limitations on use |
|---|--|
| <i>Electric passenger lift</i> | No limitation. |
| <i>Electrohydraulic passenger lift</i> | No limitation. |
| <i>Stairway platform lift</i> | Must not— <ul style="list-style-type: none"> (a) be used to serve a space in a building accommodating more than 100 persons calculated according to D1.13; or (b) be used in a high traffic public use area such as a theatre, cinema, auditorium, transport interchange, shopping centre or the like; or (c) be used where it is possible to install another type of passenger lift; or (d) connect more than 2 <i>storeys</i>; or (e) where more than 1 stairway lift is installed, serve more than 2 consecutive <i>storeys</i>; or (f) when in the folded position, encroach on the minimum width of a stairway <i>required</i> by D1.6. |
| <i>Inclined lift</i> | No limitation. |
| <i>Low-rise platform lift</i> | Must not travel more than 1000 mm. |
| <i>Low-rise, low-speed constant pressure lift</i> | Must not— <ul style="list-style-type: none"> (a) for an enclosed type, travel more than 4 m; or |

Deemed-to-Satisfy Provisions

Table E3.6a LIMITATIONS ON USE OF TYPES OF PASSENGER LIFTS— continued

| Lift type | Limitations on use |
|--|---|
| | (b) for an unenclosed type, travel more than 2 m; or (c) be used in high traffic public use areas in buildings such as a theatre, cinema, auditorium, transport interchange, shopping complex or the like. |
| <i>Small sized, low-speed automatic lift</i> | Must not travel more than 12 m. |

Table E3.6b APPLICATION OF FEATURES TO PASSENGER LIFTS

| Feature | Application |
|---|---|
| Handrail complying with the provisions for a mandatory handrail in AS 1735.12 | All lifts except— (a) a <i>stairway platform lift</i> ; and (b) a <i>low-rise platform lift</i> . |
| Lift floor dimension of not less than 1400 mm wide x 1600 mm deep | All lifts which travel more than 12 m. |
| Lift floor dimensions of not less than 1100 mm wide x 1400 mm deep | All lifts which travel not more than 12 m except a <i>stairway platform lift</i> . |
| Lift floor dimensions of not less than 810 mm wide x 1200 mm deep | A <i>stairway platform lift</i> |
| Minimum clear door opening complying with AS 1735.12 | All lifts except a <i>stairway platform lift</i> . |
| Passenger protection system complying with AS 1735.12 | All lifts with a power operated door. |
| Lift landing doors at the upper landing | All lifts except a <i>stairway platform lift</i> . |
| Lift car and landing control buttons complying with AS 1735.12 | All lifts except— (a) a <i>stairway platform lift</i> ; and (b) a <i>low-rise platform lift</i> . |
| Lighting in accordance with AS 1735.12 | All enclosed lift cars. |
| (a) Automatic audible information within the lift car to identify the level each time the car stops; and (b) audible and visual indication at each lift landing to indicate the arrival of the lift car; and (c) audible information and audible indication <i>required</i> by (a) and (b) is to be provided in a range of between 20–80 dB(A) at a maximum frequency of 1 500 Hz | All lifts serving more than 2 levels. |

Deemed-to-Satisfy Provisions

Table E3.6b APPLICATION OF FEATURES TO PASSENGER LIFTS— continued

| Feature | Application |
|---|--|
| Emergency hands-free communication, including a button that alerts a call centre of a problem and a light to signal that the call has been received | All lifts except a <i>stairway platform lift</i> . |

E3.7 Fire service controls

Where lifts serve any *storey* above an *effective height* of 12m, the following must be provided:

- (a) A fire control switch complying with E3.9 for—
 - (i) a group of lifts; or
 - (ii) a single lift not in a group that serves the *storey*.
- (b) A lift car fire service drive control switch complying with E3.10 for every lift.

E3.8 Aged care buildings

Where residents in a Class 9c *aged care building* are on levels which do not have direct access to a road or *open space*, the building must be provided with either—

- (a) at least one lift to accommodate a stretcher in accordance with E3.2(b); or
- (b) a ramp in accordance with AS 1428.1, and

the lift or ramp must discharge at a level providing direct access to a road or *open space*.

E3.9 Fire service recall operation switch

- (a) Each group of lifts must be provided with one fire service recall control switch *required* by E3.7 that activates the fire service recall operation at (e). The switch must—
 - (i) be located at the landing nominated by the *appropriate authority*; and
 - (ii) be labelled "FIRE SERVICE" in indelible white lettering on a red background; and
 - (iii) have two positions with an "OFF" and an "ON" position identified; and
 - (iv) be operable only by the use of a key that is removable in either the "OFF" position or the "ON" position.
- (b) Adhesive labels must not be used for compliance with (a)(ii) and (a)(iii).
- (c) The key in (a)(iv) must be able to turn all fire service recall control switches in the building and must have a different key combination to other keys used for lifts in the building.
- (d) The fire service recall operation must be activated by—
 - (i) switching the fire service recall control switch in (a) to "ON"; or
 - (ii) a signal from a fire management system approved by the *appropriate authority*.
- (e) The activation of the fire service recall operation at (d) must—
 - (i) cancel all registered car and landing calls; and
 - (ii) inactivate all door reopening devices that may be affected by smoke; and

Deemed-to-Satisfy Provisions

- (iii) ensure lift cars travelling toward the nominated floor continue to the nominated floor without stopping; and
 - (iv) ensure lift cars travelling away from the nominated floor stop at or before the next available floor without opening the doors (either automatically or by the door open button), reverse direction and travel without stopping to the nominated floor; and
 - (v) for lifts stopped at a floor other than the nominated floor, close the doors and travel without stopping to the nominated floor; and
 - (vi) ensure that lifts stay at the nominated floor with doors open; and
 - (vii) permit all lifts to return to normal service if the fire service recall control switch at (a) is switched to the "OFF" position during or after the fire service recall operation.
- (f) The requirements of (e) do not apply to lifts on inspection service or when the lift car fire service control switch *required* by E3.10 is in the "ON" position.
- (g) Lifts having manual controls must signal an alert to the lift for the lift to return to the nominated floor containing the recall switch that activated the signal.

E3.10 Lift car fire service drive control switch

- (a) The lift car fire service drive control switch *required* by E3.7 must be activated from within the lift car. The switch must—
- (i) be located between 600 mm and 1500 mm above the lift car floor; and
 - (ii) be labelled "FIRE SERVICE" by indelible white lettering on a red background; and
 - (iii) have two positions with an "OFF" and an "ON" position identified; and
 - (iv) operate only by the use of a key that is removable in either the "OFF" position or the "ON" position.
- (b) Adhesive labels must not be used for compliance with (a)(ii) or (a)(iii).
- (c) When the lift car fire service drive control switch at (a) is turned to the "ON" position, the lift must—
- (i) not respond to the fire service recall control switch; and
 - (ii) cancel all registered lift car and landing calls; and
 - (iii) override all lift car call access control systems; and
 - (iv) inactivate all door reopening devices that may be affected by smoke; and
 - (v) allow the registration of lift car call by lift car call buttons, however the lift doors must not close in response to the registration of lift car calls; and
 - (vi) activate door closing by constant pressure being applied on the "door close" button unless the button is released before the doors are fully closed, in which case the doors must reopen and any registered lift car calls must be cancelled; and
 - (vii) when the doors are closed, move the lift in response to registered lift car calls while allowing additional lift car calls to also be registered; and
 - (viii) travel to the first possible floor in response to registered lift car calls and cancel all registered lift car calls after the lift stops; and

Deemed-to-Satisfy Provisions

- (ix) ensure doors do not open automatically, rather by constant pressure being applied on the "door open" button unless the button is released before the doors are fully open, in which case the doors must re-close; and

the requirements of **(c)(i)** to **(c)(ix)** do not apply to a lift operating on inspection service.

- (d) A multi-deck lift installation must have systems in place that—
 - (i) are able to communicate to the fire officer that the fire service drive control switch will not operate until all decks have been cleared of passengers; and
 - (ii) ensure there is an appropriate method of clearing all deck landings of passengers; and
 - (iii) maintain all doors to deck landings not containing the fire service control switch closed and inoperative while the lift is on fire service drive control.

SPECIFICATION **E3.1** LIFT INSTALLATIONS

Deemed-to-Satisfy Provisions

1. Scope

This Specification contains requirements for *electric passenger lift* installations and *electrohydraulic passenger lift* installations.

2. Lift cars exposed to solar radiation

- (a) A lift car exposed to solar radiation directly, or indirectly by re-radiation, must have—
- (i) mechanical ventilation at a rate of one air change per minute; or
 - (ii) mechanical cooling.
- (b) A 2 hour alternative power source for ventilation or mechanical cooling at (a) must be provided in the event of normal power loss.

3. Lift car emergency lighting

A lift car must have an emergency lighting system designed—

- (a) to come on automatically upon failure of the normal lighting supply; and
- (b) to provide at least 20 lux of lighting for 2 hours on the alarm initiation button.

4. Cooling of lift shaft

While a lift in a lift *shaft* is in service, the cooling of the lift *shaft* must—

- (a) ensure that the dry bulb air temperature in the lift *shaft* does not exceed 40°C; and
- (b) if the cooling is by a ventilation system, be provided with an air change rate determined using a temperature rise of no more than 5 K.

5. Lift foyer access

Where there is a security foyer in a building, access may be via locked security doors provided—

- (a) security doors revert to the unlocked state in the event of—
 - (i) power failure; or
 - (ii) fire alarm; and
- (b) locked foyer areas are monitored by closed circuit television and intercom system to a 24 hour staffed location.

6. Emergency access doors in a single enclosed lift shaft

- (a) Where a lift is installed in a single enclosed lift *shaft* having a distance between normal landing entrances greater than 12.2 m, emergency access doors must be provided and constructed as follows:

Deemed-to-Satisfy Provisions

- (i) The clear opening size of emergency doors must be not less than 600 mm wide x 980 mm high.
 - (ii) Hinged doors must not open towards the interior of the lift *shaft*.
 - (iii) Doors must be *self-closing* and self-locking.
 - (iv) Doors must be marked on the landing side with the letters not less than 35 mm high:
"DANGER LIFTWELL ACCESS"
"KEEP FURNITURE AND FIXTURES CLEAR".
 - (v) Doors from the landing side must only be openable by a tool.
 - (vi) Each emergency door must be provided with a positive breaking electrical contact, wired into the control circuit to prevent movement of the lift until the emergency door is both closed and locked.
- (b) In single enclosed lift *shafts* where—
- (i) ropes are installed; and
 - (ii) the vertical distance between the lift car sill and the landing door head is less than 600 mm; and
 - (iii) the counterweight is resting on its fully compressed buffer,
- emergency egress from the lift car must be provided in the form of an interlocked door with clear opening dimensions not less than 600 mm x 600 mm, accessible from the lift car entrance or the lift car roof (where the door is located in the wall of the lift *shaft*).

PART E4 EMERGENCY LIGHTING, EXIT SIGNS AND WARNING SYSTEMS

OBJECTIVE

EO4

The *Objective* of this Part is, in an emergency, to safeguard occupants from injury by—

- (a) having adequate lighting; and
- (b) having adequate identification of *exits* and paths of travel to *exits*; and
- (c) being made aware of the emergency.

FUNCTIONAL STATEMENT

EF4.1

A building is to be provided with—

- (a) adequate lighting upon failure of normal artificial lighting during an emergency; and
- (b) adequate means—
 - (i) of warning occupants to evacuate; and
 - (ii) to manage the evacuation process; and
 - (iii) to identify *exits* and paths of travel to an *exit*.

PERFORMANCE REQUIREMENTS

EP4.1

A level of illumination for safe evacuation in an emergency must be provided, to the degree necessary, appropriate to—

- (a) the function or use of the building; and
- (b) the *floor area* of the building; and
- (c) the distance of travel to an *exit*.

Limitation:

EP4.1 does not apply to the internal parts of a *sole-occupancy unit* in a Class 2, 3 or 9c building or Class 4 part of a building.

EP4.2

To facilitate evacuation, suitable signs or other means of identification must, to the degree necessary—

- (a) be provided to identify the location of *exits*; and
- (b) guide occupants to *exits*; and
- (c) be clearly visible to occupants; and
- (d) operate in the event of a power failure of the main lighting system for sufficient time for occupants to safely evacuate.

Limitation:

EP4.2 does not apply to the internal parts of a *sole-occupancy unit* in a Class 2 or 3 building or Class 4 part of a building.

EP4.3

To warn occupants of an emergency and assist evacuation of a building, a sound system and intercom system for emergency purposes must be provided, to the degree necessary, appropriate to—

- (a) the *floor area* of the building; and
- (b) the function or use of the building; and
- (c) the height of the building.

VERIFICATION METHOD

EV4.1 Emergency Lighting

Compliance with **EP4.1** is verified for the level of illumination for safe evacuation in an emergency, when the emergency lighting system satisfies the requirements below:

- (a) The calculated horizontal *illuminance* is not less than—
 - (i) 0.2 lux at floor level in the path of travel to an *exit*; and
 - (ii) 1 lux at each floor level or tread in every *required*—
 - (A) *fire-isolated stairway*; or
 - (B) *fire-isolated passageway*; or
 - (C) *fire-isolated ramp*; or
 - (D) *non-fire-isolated stairway*; or
 - (E) *non-fire-isolated ramp*.
- (b) The emergency lighting provides a level of *illuminance* not less than—
 - (i) 10% of that *required* by (a) within 1 second of energization; and

- (ii) 80% of that *required* by (a) within 15 seconds of energization.
- (c) The full level of illumination *required* by (a) must be achieved within 60 seconds of energization.
- (d) An emergency lighting system must operate at not less than the minimum *required* level of *illuminance* for not less than 90 minutes.

PART E4 EMERGENCY LIGHTING, EXIT SIGNS AND WARNING SYSTEMS

Deemed-to-Satisfy Provisions

E4.0 Deemed-to-Satisfy Provisions

- (a) Where a *Building Solution* is proposed to comply with the *Deemed-to-Satisfy Provisions*, *Performance Requirements EP4.1* to *EP4.3* are satisfied by complying with *E4.1* to *E4.9*.
- (b) Where a *Building Solution* is proposed as an *Alternative Solution* to the *Deemed-to-Satisfy Provisions* of *E4.1* to *E4.9*, the relevant *Performance Requirements* must be determined in accordance with *A0.10*.

E4.1 * * * * *

This clause has deliberately been left blank.

E4.2 Emergency lighting requirements

An emergency lighting system must be installed—

- (a) in every *fire-isolated stairway*, *fire-isolated passageway* or *fire-isolated ramp*; and
- (b) in every *storey* of a Class 5, 6, 7, 8 or 9 building where the *storey* has a *floor area* more than 300 m²—
 - (i) in every passageway, corridor, hallway, or the like, that is part of the path of travel to an *exit*; and
 - (ii) in any room having a *floor area* more than 100 m² that does not open to a corridor or space that has emergency lighting or to a road or *open space*; and
 - (iii) in any room having a *floor area* more than 300 m²; and
- (c) in every passageway, corridor, hallway, or the like, having a length of more than 6 m from the entrance doorway of any *sole-occupancy unit* in a Class 2 or 3 building or Class 4 part of a building to the nearest doorway opening directly to—
 - (i) a *fire-isolated stairway*, *fire-isolated passageway* or *fire-isolated ramp*; or
 - (ii) an external stairway serving instead of a *fire-isolated stairway* under **D1.8**; or
 - (iii) an external balcony leading to a *fire-isolated stairway*, *fire-isolated passageway* or *fire-isolated ramp*; or
 - (iv) a road or *open space*; and
- (d) in every *required non-fire-isolated stairway*; and
- (e) in a *sole-occupancy unit* in a Class 5, 6 or 9 building if—
 - (i) the *floor area* of the unit is more than 300 m²; and
 - (ii) an *exit* from the unit does not open to a road or *open space* or to an external stairway, passageway, balcony or ramp, leading directly to a road or *open space*; and

Deemed-to-Satisfy Provisions

- (f) in every room or space to which there is public access in every *storey* in a Class 6 or 9b building if—
 - (i) the *floor area* in that *storey* is more than 300 m²; or
 - (ii) any point on the floor of that *storey* is more than 20 m from the nearest doorway leading directly to a stairway, ramp, passageway, road or *open space*; or
 - (iii) egress from that *storey* involves a vertical rise within the building of more than 1.5 m, or any vertical rise if the *storey* concerned does not admit sufficient light; or
 - (iv) the *storey* provides a path of travel from any other *storey required* by (i), (ii) or (iii) to have emergency lighting; and
- (g) in a Class 9a *health-care building*—
 - (i) in every passageway, corridor, hallway, or the like, serving a *treatment area* or a *ward area*; and
 - (ii) in every room having a *floor area* of more than 120 m² in a *patient care area*; and
- (h) in every Class 9c *aged care building* excluding within *sole-occupancy units*; and
- (i) in every *required* fire control centre.

E4.3 Measurement of distance

Distances, other than vertical rise, must be measured along the shortest path of travel whether by straight lines, curves or a combination of both.

E4.4 Design and operation of emergency lighting

Every *required* emergency lighting system must comply with AS 2293.1.

E4.5 Exit signs

An *exit* sign must be clearly visible to persons approaching the *exit*, and must be installed on, above or adjacent to each—

- (a) door providing direct egress from a *storey* to—
 - (i) an enclosed stairway, passageway or ramp serving as a *required exit*; and
 - (ii) an external stairway, passageway or ramp serving as a *required exit*; and
 - (iii) an external access balcony leading to a *required exit*; and
- (b) door from an enclosed stairway, passageway or ramp at every level of discharge to a road or *open space*; and
- (c) *horizontal exit*; and
- (d) door serving as, or forming part of, a *required exit* in a *storey required* to be provided with emergency lighting in accordance with E4.2.

Deemed-to-Satisfy Provisions

E4.6 Direction signs

NSW E4.6

If an *exit* is not readily apparent to persons occupying or visiting the building then *exit* signs must be installed in appropriate positions in corridors, hallways, lobbies, and the like, indicating the direction to a *required exit*.

E4.7 Class 2 and 3 buildings and Class 4 parts: Exemptions

E4.5 does not apply to—

- (a) a Class 2 building in which every door referred to is clearly and legibly labelled on the side remote from the *exit* or balcony—
 - (i) with the word “EXIT” in capital letters 25 mm high in a colour contrasting with that of the background; or
 - (ii) by some other suitable method; and
- (b) an entrance door of a *sole-occupancy unit* in a Class 2 or 3 building or Class 4 part of a building.

E4.8 Design and operation of exit signs

Every *required exit* sign must—

- (a) comply with AS 2293.1; and
- (b) be clearly visible at all times when the building is occupied by any person having the right of legal entry to the building.

E4.9 Sound systems and intercom systems for emergency purposes

A sound system and intercom system for emergency purposes complying where applicable with AS 1670.4 must be installed—

- (a) in a building with an *effective height* of more than 25 m; and
- (b) in a Class 3 building having a *rise in storeys* of more than 2 and used as—
 - (i) the residential part of a *school*; or
 - (ii) accommodation for the aged, children or people with a disability; and
- (c) in a Class 3 building used as a *residential aged care building*, except that the system—
 - (i) must be arranged to provide a warning for occupants; and
 - (ii) in areas used by the residents, may have its alarm adjusted in volume and content to minimise trauma consistent with the type and condition of residents; and
- (d) in a Class 9a building having a *floor area* of more than 1000 m² or a *rise in storeys* of more than 2, and the system—
 - (i) must be arranged to provide a warning for occupants; and
 - (ii) in a *ward area*, may have its alarm adjusted in volume and content to minimise trauma consistent with the type and condition of patients; and
- (e) in a Class 9b building—

Deemed-to-Satisfy Provisions

- (i) used as a *school* and having a *rise in storeys* of more than 3; or
- (ii) used as a theatre, public hall, or the like, having a *floor area* more than 1000 m² or a *rise in storeys* of more than 2.

HEALTH AND AMENITY

- F1** **Damp and Weatherproofing**
- F2** **Sanitary and Other Facilities**
- F3** **Room Heights**
- F4** **Light and Ventilation**
- F5** **Sound Transmission and Insulation**

SECTION F CONTENTS

SECTION F HEALTH AND AMENITY

Part F1 Damp and Weatherproofing

- Objective FO1
- Functional Statements FF1.1 - FF1.3
- Performance Requirements FP1.1 - FP1.7
- F1.0 Deemed-to-Satisfy Provisions
- F1.1 Stormwater drainage
- F1.2 * * * * *
- F1.3 * * * * *
- F1.4 External above ground membranes
- F1.5 Roof coverings
- F1.6 Sarking
- F1.7 Waterproofing of wet areas in buildings
- F1.8 * * * * *
- F1.9 Damp-proofing
- F1.10 Damp-proofing of floors on the ground
- F1.11 Provision of floor wastes
- F1.12 Sub-floor ventilation
- F1.13 Glazed assemblies

Part F2 Sanitary and Other Facilities

- Objective FO2
- Functional Statements FF2.1 - FF2.4
- Performance Requirements FP2.1 - FP2.6
- F2.0 Deemed-to-Satisfy Provisions
- F2.1 Facilities in residential buildings
- F2.2 Calculation of number of occupants and facilities
- F2.3 Facilities in Class 3 to 9 buildings
- F2.4 Accessible sanitary facilities
- F2.5 Construction of sanitary compartments
- F2.6 Interpretation: Urinals and washbasins
- F2.7 Microbial (legionella) control
- F2.8 Waste management

Part F3 Room Heights

- Objective FO3
- Functional Statement FF3.1
- Performance Requirement FP3.1
- F3.0 Deemed-to-Satisfy Provisions
- F3.1 Height of rooms and other spaces

Part F4 Light and Ventilation

- Objective FO4
- Functional Statements FF4.1 - FF4.3
- Performance Requirements FP4.1 - FP4.5
- F4.0 Deemed-to-Satisfy Provisions
- F4.1 Provision of natural light
- F4.2 Methods and extent of natural lighting
- F4.3 Natural light borrowed from adjoining room
- F4.4 Artificial lighting
- F4.5 Ventilation of rooms
- F4.6 Natural ventilation
- F4.7 Ventilation borrowed from adjoining room
- F4.8 Restriction on position of water closets and urinals
- F4.9 Airlocks
- F4.10 * * * * *
- F4.11 Carparks
- F4.12 Kitchen local exhaust ventilation

Part F5 Sound Transmission and Insulation

- Objective FO5
- Functional Statement FF5.1
- Performance Requirements FP5.1 - FP5.6
- Verification Methods FV5.1 and FV5.2
- F5.0 Deemed-to-Satisfy Provisions
- F5.1 Application of Part
- F5.2 Determination of airborne sound insulation ratings
- F5.3 Determination of impact sound insulation ratings
- F5.4 Sound insulation rating of floors
- F5.5 Sound insulation rating of walls
- F5.6 Sound insulation rating of internal services
- F5.7 Sound isolation of pumps
- Specification F5.2 Sound Insulation for Building Elements
- Specification F5.5 Impact Sound - Test of Equivalence

PART F1 DAMP AND WEATHERPROOFING

OBJECTIVE

FO1

The *Objective* of this Part is to—

- (a) safeguard occupants from illness or injury and protect the building from damage caused by—
 - (i) *surface water*; and
 - (ii) external moisture entering a building; and
 - (iii) the accumulation of internal moisture in a building; and
- (b) protect *other property* from damage caused by redirected *surface water*.

FUNCTIONAL STATEMENTS

FF1.1

A building including any associated *sitework* is to be constructed in a way that protects people and *other property* from the adverse effects of redirected *surface water*.

FF1.2

A building is to be constructed to provide resistance to moisture penetrating from the outside including rising from the ground.

FF1.3

A building is to be constructed to avoid the likelihood of—

- (a) the creation of unhealthy or dangerous conditions; and
- (b) damage to building elements,

caused by dampness or water overflow from bathrooms, laundries and the like.

PERFORMANCE REQUIREMENTS

FP1.1

Surface water, resulting from a storm having an *average recurrence interval* of 20 years and which is collected or concentrated by a building or *sitework*, must be disposed of in a way that avoids the likelihood of damage or nuisance to any *other property*.

FP1.2

Surface water, resulting from a storm having an *average recurrence interval* of 100 years must not enter the building.

Limitation:

FP1.2 does not apply to—

- (a) a Class 7 or 8 building where in the particular case there is no necessity for compliance; or
- (b) a garage, tool shed, *sanitary compartment*, or the like, forming part of a building used for other purposes; or
- (c) an *open spectator stand* or *open-deck carpark*.

FP1.3

A drainage system for the disposal of *surface water* resulting from a storm having an *average recurrence interval* of—

- (a) 20 years must—
 - (i) convey *surface water* to an appropriate *outfall*; and
 - (ii) avoid *surface water* damaging the building; and
- (b) 100 years must avoid the entry of *surface water* into a building.

FP1.4

A roof and *external wall* (including openings around *windows* and doors) must prevent the penetration of water that could cause—

- (a) unhealthy or dangerous conditions, or loss of amenity for occupants; and
- (b) undue dampness or deterioration of building elements.

Limitation:

FP1.4 does not apply to—

- (a) a Class 7 or 8 building where in the particular case there is no necessity for compliance; or
- (b) a garage, tool shed, *sanitary compartment*, or the like, forming part of a building used for other purposes; or
- (c) an *open spectator stand* or *open-deck carpark*.

FP1.5

SA FP1.5

Moisture from the ground must be prevented from causing—

- (a) undue dampness or deterioration of building elements; and
- (b) unhealthy or dangerous conditions, or loss of amenity for occupants.

Limitation:

FP1.5 does not apply to—

- (a) a Class 7 or 8 building where in the particular case there is no necessity for compliance; or
- (b) a garage, tool shed, *sanitary compartment*, or the like, forming part of a building used for other purposes; or
- (c) an *open spectator stand* or *open-deck carpark*.

FP1.6

SA FP1.6

Overflow from a bathroom, laundry facility or the like must be prevented from penetrating to—

- (a) another *sole-occupancy unit* used for sleeping accommodation; and
- (b) a public space,

in a *storey* below in the same building.

FP1.7

To protect the structure of the building and to maintain the amenity of the occupants, water must be prevented from penetrating—

- (a) behind fittings and linings; and
- (b) into concealed spaces,

of *sanitary compartments*, bathrooms, laundries and the like.

SA FP1.8

PART F1 DAMP AND WEATHERPROOFING

Deemed-to-Satisfy Provisions

F1.0 Deemed-to-Satisfy Provisions

- (a) *Performance Requirement FP1.4*, for the prevention of the penetration of water through *external walls*, must be complied with.

There are no *Deemed-to-Satisfy Provisions* for this *Performance Requirement* in respect of *external walls*.

SA F1.0(b)

- (b) Where a *Building Solution* is proposed to comply with the *Deemed-to-Satisfy Provisions*, *Performance Requirements FP1.1* to *FP1.3* and *FP1.5* to *FP1.7* are satisfied by complying with *F1.1* to *F1.13*.
- (c) Where a *Building Solution* is proposed as an *Alternative Solution* to the *Deemed-to-Satisfy Provisions* of *F1.1* to *F1.13*, the relevant *Performance Requirements* must be determined in accordance with *A0.10*.

F1.1 Stormwater drainage

Stormwater drainage must comply with AS/NZS 3500.3.

F1.2 * * * * *

This clause has deliberately been left blank.

F1.3 * * * * *

This clause has deliberately been left blank.

F1.4 External above ground membranes

Waterproofing membranes for external above ground use must comply with AS 4654 Parts 1 and 2.

F1.5 Roof coverings

A roof must be covered with—

- (a) concrete roofing tiles complying with AS 2049 and fixed, except in cyclonic areas, in accordance with AS 2050, as appropriate; or
- (b) terracotta roofing tiles complying with AS 2049 and fixed, except in cyclonic areas, in accordance with AS 2050; or
- (c) cellulose cement corrugated sheeting complying with AS/NZS 2908.1 and installed in accordance with AS/NZS 1562.2; or
- (d) metal sheet roofing complying with AS 1562.1; or

Deemed-to-Satisfy Provisions

- (e) plastic sheet roofing designed and installed in accordance with AS/NZS 4256 Parts 1, 2, 3 and 5 and AS/NZS 1562.3; or
- (f) asphalt shingles complying with ASTM D3018-90, Class A.

F1.6 Sarking

Sarking-type materials used for weatherproofing of roofs and walls must comply with AS/NZS 4200 Parts 1 and 2.

F1.7 Waterproofing of wet areas in buildings

SA F1.7

- (a) In a Class 2 and 3 building and a Class 4 part of a building, building elements in *wet areas* must—
 - (i) be *water resistant* or *waterproof* in accordance with **Table F1.7**; and
 - (ii) comply with AS 3740.
- (b) In a Class 5, 6, 7, 8 or 9 building, building elements in the bathroom or shower room, a slop hopper or sink compartment, a laundry or *sanitary compartment* must—
 - (i) be *water resistant* or *waterproof* in accordance with **Table F1.7**; and
 - (ii) comply with AS 3740,

as if they were in a Class 2 or 3 building or a Class 4 part of a building.
- (c) Where a slab or stall type urinal is installed—
 - (i) the floor surface of the room containing the urinal must—
 - (A) be an impervious material; and
 - (B) where no step is installed—
 - (aa) be graded to the urinal channel for a distance of 1.5 m from the urinal channel; and
 - (bb) the remainder of the floor be graded to a floor waste; and
 - (C) where a step is installed—
 - (aa) the step must have an impervious surface and be graded to the urinal channel; and
 - (bb) the floor behind the step must be graded to a floor waste; and
 - (ii) the junction between the floor surface and the urinal channel must be impervious.
- (d) Where a wall hung urinal is installed—
 - (i) the wall must be surfaced with impervious material extending from the floor to not less than 50 mm above the top of the urinal and not less than 225 mm on each side of the urinal.
 - (ii) the floor must be surfaced with impervious material and graded to a floor waste.
- (e) In a room with timber or steel framed walls and containing a urinal—
 - (i) the wall must be surfaced with an impervious material extending from the floor to not less than 100 mm above the floor surface; and

Deemed-to-Satisfy Provisions

- (ii) the junction of the floor surface and the wall surface must be impervious.

Table F1.7 WATERPROOFING AND WATER-RESISTANCE REQUIREMENTS FOR BUILDING ELEMENTS IN WET AREAS

| Vessels or area where the fixture is installed | Floors and horizontal surfaces | Walls | Wall junctions and joints | Wall / floor junctions | Penetrations |
|--|---|---|--|--|--|
| Shower area (enclosed and unenclosed) | | | | | |
| With hob | <i>Waterproof</i> floor in <i>shower area</i> (including any hob or step-down). | (a) <i>Waterproof</i> all walls in <i>shower area</i> to a height the greater of— (i) not less than 150 mm above floor substrate; or (ii) not less than 25 mm above maximum retained water level; and | <i>Waterproof</i> wall junctions within <i>shower area</i> . | <i>Waterproof</i> wall / floor junctions within <i>shower area</i> . | <i>Waterproof</i> penetrations in <i>shower area</i> . |
| With step-down | | | | | |
| Without hob or step-down | | (b) <i>Water resistant</i> walls in <i>shower area</i> to not less than 1800 mm above finished floor level of the shower. | | | |

SUPERSEDED
Deemed-to-Satisfy Provisions

Table F1.7 WATERPROOFING AND WATER-RESISTANCE REQUIREMENTS FOR BUILDING ELEMENTS IN WET AREAS— continued

| Vessels or area where the fixture is installed | Floors and horizontal surfaces | Walls | Wall junctions and joints | Wall / floor junctions | Penetrations |
|--|---|---|--|--|--|
| With preformed shower base | N/A | <i>Water resistant</i> walls in <i>shower area</i> to not less than 1800 mm above finished floor level of the shower. | <i>Waterproof</i> wall junctions within <i>shower area</i> . | <i>Waterproof</i> wall / floor junctions within <i>shower area</i> . | <i>Waterproof</i> penetrations in <i>shower area</i> . |
| Area outside shower area | | | | | |
| For concrete and compressed fibre-cement sheet flooring | <i>Water resistant</i> floor of the room. | N/A | N/A | <i>Waterproof</i> wall / floor junctions. | N/A |
| For timber floors including particleboard, plywood and other timber based flooring materials | <i>Waterproof</i> floor of the room. | | | | |

SUPERSEDED
Deemed-to-Satisfy Provisions

Table F1.7 WATERPROOFING AND WATER-RESISTANCE REQUIREMENTS FOR BUILDING ELEMENTS IN WET AREAS— continued

| Vessels or area where the fixture is installed | Floors and horizontal surfaces | Walls | Wall junctions and joints | Wall / floor junctions | Penetrations |
|--|---|---|--|---|---|
| Areas adjacent to baths and spas | | | | | |
| For concrete and compressed fibre-cement sheet flooring | <i>Water resistant</i> floor of the room. | (a) <i>Water resistant</i> to a height of not less than 150 mm above the <i>vessel</i> , for the extent of the <i>vessel</i> , where the <i>vessel</i> is within 75 mm of a wall. | <i>Water resistant</i> junctions within 150 mm above a <i>vessel</i> for the extent of the <i>vessel</i> . | <i>Water resistant</i> wall / floor junctions for the extent of the <i>vessel</i> . | <i>Waterproof</i> tap and spout penetrations where they occur in horizontal surfaces. |
| For timber floors including particleboard, plywood and other timber based flooring materials | <i>Waterproof</i> floor of the room. | (b) <i>Water resistant</i> all exposed surfaces below <i>vessel</i> lip. | | | |
| Inserted baths and spas | (a) <i>Waterproof</i> shelf area, incorporating waterstop under the bath lip. | (a) <i>Waterproof</i> to not less than 150 mm above lip of bath or spa; and | (a) <i>Waterproof</i> junctions within 150 mm above bath or spa; and | N/A | <i>Waterproof</i> tap and spout penetrations where they occur in horizontal surfaces. |
| | (b) No requirement under bath. | (b) No requirement under bath. | (b) No requirement under bath. | | |

Deemed-to-Satisfy Provisions **SUPERSEDED**

Table F1.7 WATERPROOFING AND WATER-RESISTANCE REQUIREMENTS FOR BUILDING ELEMENTS IN WET AREAS— continued

| Vessels or area where the fixture is installed | Floors and horizontal surfaces | Walls | Wall junctions and joints | Wall / floor junctions | Penetrations |
|--|---|---|--|---|---|
| Note: Where a shower is above a bath or spa, use requirements for shower. | | | | | |
| Other areas | | | | | |
| Walls adjoining other <i>vessel</i> (e.g. sink, basin or laundry tub) | N/A | <i>Water resistant</i> to a height of not less than 150 mm above the <i>vessel</i> , for the extent of the <i>vessel</i> , where the <i>vessel</i> is within 75 mm of a wall. | <i>Waterproof</i> wall junctions where a <i>vessel</i> is fixed to a wall. | N/A | <i>Waterproof</i> tap and spout penetrations where they occur in surfaces <i>required</i> to be <i>waterproof</i> or <i>water resistant</i> . |
| Laundries and WCs | <i>Water resistant</i> floor of the room. | N/A | N/A | <i>Waterproof</i> wall / floor junctions. | <i>Waterproof</i> penetrations where they occur in surfaces <i>required</i> to be <i>waterproof</i> . |
| Bathrooms and laundries <i>required</i> to provide a floor waste by F1.11 . | <i>Waterproof</i> floor of the room. | N/A | N/A | <i>Waterproof</i> wall / floor junctions. | <i>Waterproof</i> penetrations where they occur through the floor. |
| Note: N/A means not applicable. | | | | | |

Deemed-to-Satisfy Provisions

F1.8 * * * * *

This clause has deliberately been left blank.

F1.9 Damp-proofing

- (a) Except for a building covered by (c), moisture from the ground must be prevented from reaching—
- (i) the lowest floor timbers and the walls above the lowest floor joists; and
 - (ii) the walls above the damp-proof course; and
 - (iii) the underside of a suspended floor constructed of a material other than timber, and the supporting beams or girders.

SA F1.9(b)

- (b) Where a damp-proof course is provided, it must consist of—
- (i) a material that complies with AS/NZS 2904; or
 - (ii) impervious termite shields in accordance with AS 3660.1.
- (c) The following buildings need not comply with (a):
- (i) A Class 7 or 8 building where in the particular case there is no necessity for compliance.
 - (ii) A garage, tool shed, *sanitary compartment*, or the like, forming part of a building used for other purposes.
 - (iii) An *open spectator stand* or *open-deck carpark*.

F1.10 Damp-proofing of floors on the ground

SA F1.10

If a floor of a room is laid on the ground or on fill, moisture from the ground must be prevented from reaching the upper surface of the floor and adjacent walls by the insertion of a vapour barrier in accordance with AS 2870, except damp-proofing need not be provided if—

- (a) weatherproofing is not *required*; or
- (b) the floor is the base of a stair, lift or similar *shaft* which is adequately drained by gravitation or mechanical means.

F1.11 Provision of floor wastes

SA F1.11

In a Class 2 or 3 building or Class 4 part of a building, the floor of each bathroom and laundry located at any level above a *sole-occupancy unit* or public space must be graded to permit drainage to a floor waste.

F1.12 Sub-floor ventilation

The sub-floor space between a suspended floor of a building and the ground must be in accordance with the following:

Deemed-to-Satisfy Provisions

- (a) The sub-floor space must—
 - (i) be cleared of all building debris and vegetation; and
 - (ii) be cross-ventilated by means of openings; and
 - (iii) contain no dead air spaces; and
 - (iv) be graded to prevent *surface water* ponding under the building; and
 - (v) have evenly spaced ventilation openings.
- (b) In double leaf masonry walls, the cross ventilation openings specified in (a) must be provided in both leaves of the masonry, with inner-leaf openings being aligned with outer-leaf openings to allow an unobstructed flow of air.
- (c) Internal walls constructed in sub-floor spaces must be provided with openings—
 - (i) having an unobstructed area equivalent to that *required* for the adjacent external openings; and
 - (ii) which are evenly distributed throughout such internal walls.
- (d) The clearance between the ground surface and the underside of the floor, including any horizontal framing member, must be in accordance with **Table F1.12**.
- (e) The sub-floor ventilation openings in internal and *external walls* must be in accordance with **Table F1.12** for the climatic zones given in **Figure F1.12**.
- (f) Where ventilation is obstructed by patios, paving or the like, additional ventilation must be provided to ensure that the overall level of ventilation is maintained.
- (g) Where the ground or sub-floor space is excessively damp or subject to frequent flooding, in addition to the requirements of (a) to (f)—
 - (i) the area of sub-floor ventilation *required* in (e) must be increased by 50%; or
 - (ii) a sealed impervious membrane must be provided over the ground; or
 - (iii) Durability Class 1 or 2 timbers or H3 preservative treated timbers in accordance with AS 1684.2, AS 1684.3 or AS 1684.4 must be used.

Deemed-to-Satisfy Provisions

Figure F1.12

CLIMATIC ZONES BASED ON RELATIVE HUMIDITY

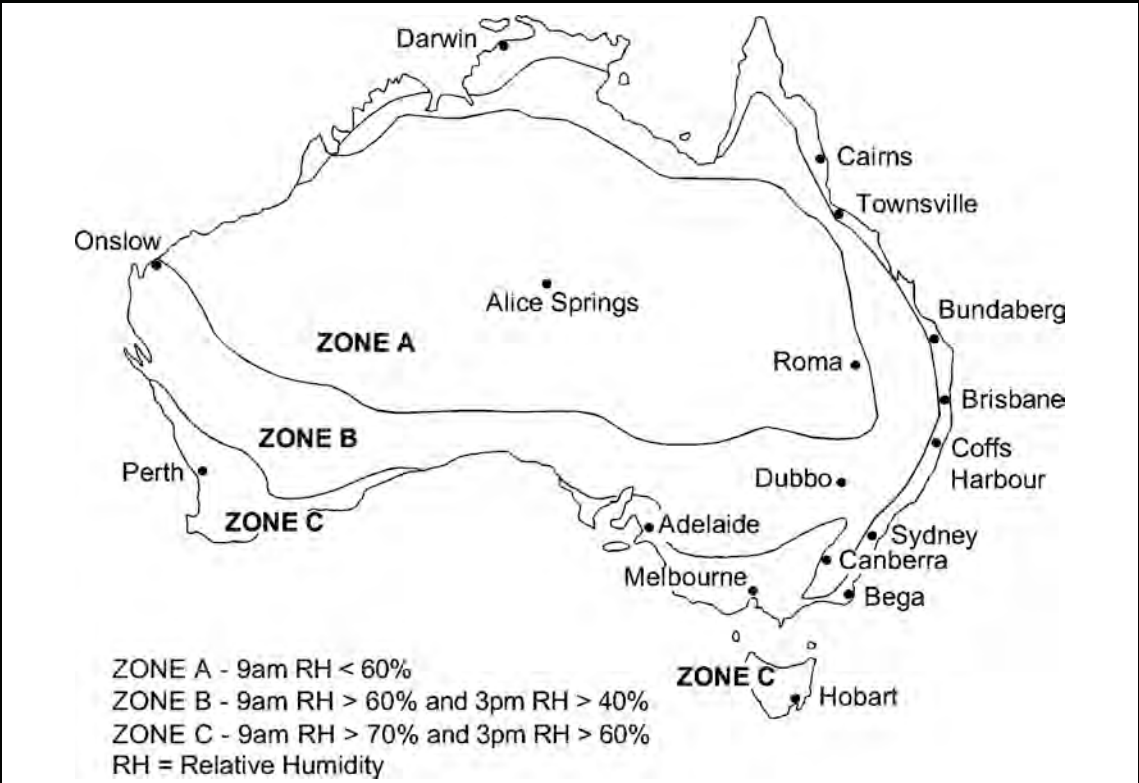

Note: The season with the highest relative humidity is used. Generally this will be July for southern Australia and January for northern Australia.

Table F1.12 SUB-FLOOR VENTILATION AND CLEARANCE

| Climatic zone (see Figure F1.12) | Minimum sub-floor ventilation (mm ² /m of wall) | | Minimum height from ground surface (mm) | |
|--|---|--|--|---|
| | No membrane | Ground sealed with impervious membrane | Termite inspection not required | Termite inspection required (see Note) |
| A | 2000 | 1000 | 150 | 400 |
| B | 4000 | 2000 | 150 | 400 |
| C | 6000 | 3000 | 150 | 400 |

Note: On sloping sites, 400 mm clearance may be reduced to 150 mm within 2 m of *external walls*.

Deemed-to-Satisfy Provisions

F1.13 Glazed assemblies

- (a) Subject to (b) and (c), the following glazed assemblies in an *external wall*, must comply with AS 2047 requirements for resistance to water penetration:
- (i) Windows.
 - (ii) Sliding doors with a frame.
 - (iii) Adjustable louvres.
 - (iv) Shopfronts.
 - (v) Window walls with one piece framing.
- (b) The following buildings need not comply with (a):
- (i) A Class 7 or 8 building where in the particular case there is no necessity for compliance.
 - (ii) A garage, tool shed, *sanitary compartment*, or the like, forming part of a building used for other purposes, except where the construction of the garage, tool shed, *sanitary compartment* or the like contributes to the weatherproofing of the other part of the building.
 - (iii) An *open spectator stand* or *open-deck carpark*.
- (c) The following glazed assemblies need not comply with (a):
- (i) All glazed assemblies not in an *external wall*.
 - (ii) Hinged doors, including French doors and bi-fold doors.
 - (iii) Revolving doors.
 - (iv) Fixed louvres.
 - (v) Skylights, roof lights and windows in other than the vertical plane.
 - (vi) Sliding doors without a frame.
 - (vii) Shopfront doors.
 - (viii) Windows constructed on site and architectural one-off windows, which are not design tested in accordance with AS 2047.
 - (ix) Second-hand windows, re-used windows, recycled windows and replacement windows.
 - (x) Heritage windows.

PART F2 SANITARY AND OTHER FACILITIES

OBJECTIVE

FO2

The *Objective* of this Part is to—

- (a) safeguard occupants from illness caused by infection; and
- (b) safeguard occupants from loss of amenity arising from the absence of adequate personal hygiene facilities; and
- (c) enable occupants to carry out laundering; and
- (d) provide for facilities to enable food preparation; and
- (e) enable unconscious occupants of *sanitary compartments* to be removed from the compartment.

FUNCTIONAL STATEMENTS

FF2.1

A building is to be provided with—

- (a) suitable sanitary facilities and space and facilities for personal hygiene; and
NSW FF2.1(b)
- (b) adequate means for the prevention of contaminants to hot water, warm water and cooling water systems.

FF2.2

A building is to be provided with space and facilities for laundering.

Vic FF2.2 Application

Application:

FF2.2 only applies to—

- (a) a Class 2 building or Class 4 part of a building; and
- (b) a Class 9a *health-care building*; and
- (c) a Class 9c *aged care building*; and
- (d) an *early childhood centre*.

FF2.3

A building is to be provided with space and facilities for the preparation and cooking of food.

Application:

FF2.3 only applies to—

- (a) a Class 2 building or Class 4 part of a building; and
- (b) a Class 9a *health-care building*; and
- (c) a Class 9c *aged care building*; and
- (d) an *early childhood centre*.

FF2.4

A *sanitary compartment* is to have sufficient space or other means to permit an unconscious occupant to be removed from the compartment.

PERFORMANCE REQUIREMENTS

FP2.1

Suitable sanitary facilities for personal hygiene must be provided in a convenient location within or associated with a building, to the degree necessary, appropriate to—

- (a) the function or use of the building; and
- (b) the number and gender of the occupants; and
- (c) the disability or other particular needs of the occupants.

FP2.2

Laundering facilities or space for laundering facilities must be provided in a convenient location within or associated with a building appropriate to the function or use of the building.

Vic FP2.2 Application

Application:

FP2.2 only applies to—

- (a) a Class 2 building or Class 4 part of a building; and
- (b) a Class 9a *health-care building*; and
- (c) a Class 9c *aged care building*; and
- (d) an *early childhood centre*.

FP2.3

A facility must be provided which includes—

- (a) a means for food rinsing, utensil washing and waste water disposal; and

- (b) a means for cooking food; and
- (c) a space for food preparation.

Application:

FP2.3 only applies to—

- (a) a Class 2 building or Class 4 part of a building; and
- (b) a Class 9a *health-care building*; and
- (c) a Class 9c *aged care building*; and
- (d) an *early childhood centre*.

FP2.4

Suitable means must be provided in a building containing wards or bedrooms to facilitate the emptying of sewage or dirty water from containers.

Application:

FP2.4 only applies to a Class 9a or 9c building.

FP2.5

A *sanitary compartment* must be constructed with sufficient space or other means to permit an unconscious occupant to be removed from the compartment.

FP2.6

NSW FP2.6

Hot water, warm water and cooling water systems installed in a building must control the accumulation of harmful levels of micro-organisms.

Limitation:

FP2.6 does not apply to a system serving only a single *sole-occupancy unit* in a Class 2 or 3 building or Class 4 part of a building.

PART F2 SANITARY AND OTHER FACILITIES

Deemed-to-Satisfy Provisions

F2.0 Deemed-to-Satisfy Provisions

Vic F2.0

- (a) Where a *Building Solution* is proposed to comply with the *Deemed-to-Satisfy Provisions, Performance Requirements FP2.1 to FP2.6* are satisfied by complying with—
 - (i) **F2.1 to F2.8**; and
 - (ii) for public transport buildings, **Part H2**.
- (b) Where a *Building Solution* is proposed as an *Alternative Solution* to the *Deemed-to-Satisfy Provisions of F2.1 to F2.8 and Part H2*, the relevant *Performance Requirements* must be determined in accordance with **A0.10**.

F2.1 Facilities in residential buildings

Sanitary and other facilities for Class 2 and 3 buildings and Class 9c *aged care buildings* and for Class 4 parts of buildings must be provided in accordance with **Table F2.1**.

Table F2.1 PROVISION OF SANITARY AND OTHER FACILITIES IN RESIDENTIAL BUILDINGS

| Class 2 |
|--|
| <p>Within each <i>sole-occupancy unit</i>, provide—</p> <ul style="list-style-type: none"> (a) a kitchen sink and facilities for the preparation and cooking of food; and (b) a bath or shower; and (c) a closet pan and washbasin. <p>Laundry facilities, provide either—</p> <ul style="list-style-type: none"> (a) in each <i>sole-occupancy unit</i>— <ul style="list-style-type: none"> (i) clothes washing facilities, comprising at least one washtub and space for a washing machine; and (ii) clothes drying facilities comprising— <ul style="list-style-type: none"> (A) clothes line or hoist with not less than 7.5 m of line; or (B) space for one heat-operated drying cabinet or appliance in the same room as the clothes washing facilities; or <p>Note: A kitchen sink or washbasin must not be counted as a laundry washtub.</p> <ul style="list-style-type: none"> (b) a separate laundry for each 4 <i>sole-occupancy units</i>, or part thereof— <ul style="list-style-type: none"> (i) clothes washing facilities comprising at least one washtub and one washing machine; and (ii) clothes drying facilities comprising— <ul style="list-style-type: none"> (A) clothes line or hoist with not less than 7.5 m of line per <i>sole-occupancy unit</i>; or |

Deemed-to-Satisfy Provisions

Table F2.1 PROVISION OF SANITARY AND OTHER FACILITIES IN RESIDENTIAL BUILDINGS— continued

| |
|--|
| <p>(B) one heat-operated drying cabinet or appliance for each 4 <i>sole-occupancy units</i>.</p> <p>Facilities for employees—</p> <p>If the building contains more than 10 <i>sole-occupancy units</i>, or a group of Class 2 buildings on the one allotment contains, in total, more than 10 <i>sole-occupancy units</i> — provide a closet pan and washbasin in a compartment or room at or near ground level and accessible to employees without entering a <i>sole-occupancy unit</i>.</p> |
| Class 3 (other than Class 3 <i>residential aged care buildings</i>) |
| <p>Facilities for residents—</p> <p>For each building or group of buildings, provide—</p> <p>(a) a bath or shower; and</p> <p>(b) a closet pan and washbasin,</p> <p>for each 10 residents for whom private facilities are not provided, except that—</p> <p>(c) if one urinal is provided for each 25 males up to 50 and one additional urinal for each additional 50 males or part thereof,</p> <p>one closet pan for each 12 males may be provided.</p> <p>Facilities for employees — see F2.3.</p> <p>Note: These facilities need not be situated within the building.</p> |
| Class 3 (<i>residential aged care buildings</i>) |
| <p>Facilities for residents—</p> <p>For each building or group of buildings, provide—</p> <p>(a) a shower, closet pan and wash basin for each 8 residents or part thereof for whom private facilities are not provided; and</p> <p>(b) a suitable bath for each 30 residents or part thereof.</p> <p>Note: Urinals must not be taken into consideration in calculating the number of facilities.</p> |
| Class 4 |
| <p>For each <i>sole-occupancy unit</i>, provide—</p> <p>(a) a kitchen sink and facilities for the preparation and cooking of food; and</p> <p>(b) a bath or shower; and</p> <p>(c) a closet pan and washbasin; and</p> <p>(d) clothes washing facilities, comprising a washtub and space in the same room for a washing machine; and</p> <p>(e) a clothes line or hoist, or space for a heat-operated drying cabinet or similar appliance for the exclusive use of the occupants.</p> <p>Note: A kitchen sink or washbasin must not be counted as a laundry washtub.</p> |

Deemed-to-Satisfy Provisions

Table F2.1 PROVISION OF SANITARY AND OTHER FACILITIES IN RESIDENTIAL BUILDINGS— continued

| Class 9c (aged care buildings) |
|--|
| <p>Facilities for residents—</p> <p>For each building or group of buildings, provide—</p> <ul style="list-style-type: none"> (a) a closet pan and wash basin for each 6 residents or part thereof for whom private facilities are not provided; and (b) a shower for each 7 residents or part thereof for whom private facilities are not provided; and (c) a suitable bath, fixed or mobile. <p>Other facilities, provide—</p> <ul style="list-style-type: none"> (a) one kitchen or other adequate facility for the preparation and cooking or reheating of food including a kitchen sink and washbasin; and (b) laundry facilities for the cleansing and drying of linen and clothing or adequate facilities for holding and dispatch or treatment of soiled linen and clothing and the like and the receipt and storage of clean linen; and (c) one clinical hand washing basin for each 16 residents or part thereof. <p>Note: Urinals must not be taken into consideration in calculating the number of facilities.</p> |

F2.2 Calculation of number of occupants and facilities

- (a) The number of persons accommodated must be calculated according to **D1.13** if it cannot be more accurately determined by other means.
- (b) Unless the premises are used predominantly by one sex, sanitary facilities must be provided on the basis of equal numbers of males and females.
- (c) In calculating the number of sanitary facilities to be provided under **F2.1** and **F2.3**, a unisex facility *required* for people with a disability may be counted once for each sex.
- (d) For the purposes of this Part, a unisex facility comprises one closet pan, one washbasin and means for the disposal of sanitary towels.

F2.3 Facilities in Class 3 to 9 buildings

- (a) Sanitary facilities must be provided for Class 3, 5, 6, 7, 8 or 9 buildings in accordance with **Table F2.3**.
- (b) If not more than 10 people are employed, a unisex facility may be provided instead of separate facilities for each sex.
- (c) If the majority of employees are of one sex, not more than 2 employees of the other sex may share toilet facilities if the facilities are separated by means of walls, partitions and doors to afford privacy.
- (d) Employees and the public may share the same facilities in a Class 6 and 9b building (other than a *school* or *early childhood centre*) provided the number of facilities provided is not less than the total number of facilities *required* for employees plus those *required* for the public.

Deemed-to-Satisfy Provisions

- (e) Adequate means of disposal of sanitary towels must be provided in sanitary facilities for use by females.
- (f) A Class 9a *health-care building* must be provided with—
 - (i) one kitchen or other adequate facility for the preparation and cooking or reheating of food including a kitchen sink and washbasin; and
 - (ii) laundry facilities for the cleansing and drying of linen and clothing or adequate facilities for holding and dispatch or treatment of soiled linen and clothing, sanitary towels and the like and the receipt and storage of clean linen; and
 - (iii) one shower for each 8 patients or part thereof; and
 - (iv) one island-type plunge bath in each *storey* containing a *ward area*.

Vic F2.3(g) and (ga)

- (g) A Class 9b *early childhood centre* must be provided with—
 - (i) a kitchen or food preparation area with a kitchen sink, separate hand washing facilities, space for a refrigerator and space for cooking facilities, with—
 - (A) the facilities protected by a door or gate with child proof latches to prevent unsupervised access to the facilities by children younger than 5 years old; and
 - (B) the ability to facilitate supervision of children from the facilities if the *early childhood centre* accommodates children younger than 2 years old; and
 - (ii) one bath, shower or shower-bath; and
 - (iii) if the centre accommodates children younger than 3 years old—
 - (A) a laundry facility comprising a washtub and space in the same room for a washing machine; and
 - (B) a bench type baby bath, which is within 1 m of the nappy change bench; and
 - (C) a nappy changing bench which—
 - (aa) is within 1 m of separate adult hand washing facilities and bench type baby bath; and
 - (bb) must be not less than 0.9 m² in area and at a height of not less than 850 mm, but not more than 900 mm above the finished floor level; and
 - (cc) must have a space not less than 800 mm high, 500 mm wide and 800 mm deep for the storage of steps; and
 - (dd) is positioned to permit a staff member changing a nappy to have visibility of the play area at all times.
- (h) Class 9b theatres and sporting venues must be provided with one shower for each 10 participants or part thereof.
- (i) Not less than one washbasin must be provided where closet pans or urinals are provided.

Tas Table F2.3

Vic Table F2.3

Table F2.3 SANITARY FACILITIES IN CLASS 3, 5, 6, 7, 8 OR 9 BUILDINGS

| User Group | Closet Pans | | Urinals | | Washbasins | |
|---|------------------|----------------|------------------|----------------|------------------|----------------|
| | Design Occupancy | Number | Design Occupancy | Number | Design Occupancy | Number |
| Class 3, 5, 6 and 9 other than <i>schools</i> | | | | | | |
| Male employees | 1 — 20 | 1 | 1 — 10 | 0 | 1 — 30 | 1 |
| | > 20 | Add 1 per 20 | 11 — 25 | 1 | > 30 | Add 1 per 30 |
| | | | 26 — 50 | 2 | | |
| | | | >50 | Add 1 per 50 | | |
| Female employees | 1 — 15 | 1 | | | 1 — 30 | 1 |
| | > 15 | Add 1 per 15 | | | > 30 | Add 1 per 30 |
| Class 7 and 8 | | | | | | |
| Male employees | 1 — 20 | 1 | 1 — 10 | 0 | 1 — 20 | 1 |
| | > 20 | Add 1 per 20 | 11 — 25 | 1 | > 20 | Add 1 per 20 |
| | | | 26 — 50 | 2 | | |
| | | | >50 | Add 1 per 50 | | |
| Female employees | 1 — 15 | 1 | | | 1 — 20 | 1 |
| | > 15 | Add 1 per 15 | | | > 20 | Add 1 per 20 |
| Note: Sanitary facilities need not be provided for a Class 8 <i>electricity network substation</i> | | | | | | |
| Class 6 — department stores, shopping centres | | | | | | |
| Male patrons | 1 — 1200 | 1 | 1 — 600 | 1 | 1 — 600 | 1 |
| | > 1200 | Add 1 per 1200 | >600 | Add 1 per 1200 | >600 | Add 1 per 1200 |

SUPERSEDED
Deemed-to-Satisfy Provisions

Table F2.3 SANITARY FACILITIES IN CLASS 3, 5, 6, 7, 8 OR 9 BUILDINGS — continued

| User Group | Closet Pans | | Urinals | | Washbasins | |
|--|------------------|----------------|------------------|--------|------------------|----------------|
| | Design Occupancy | Number | Design Occupancy | Number | Design Occupancy | Number |
| Female patrons | 1 — 300 | 1 | | | 1 — 600 | 1 |
| | 301 — 600 | 2 | | | 601 — 1200 | 2 |
| | >600 | Add 1 per 1200 | | | >1200 | Add 1 per 1200 |
| Note: Sanitary facilities need not be provided for patrons if the building accommodates not more than 600 people. | | | | | | |
| Class 6 — restaurants, cafes, bars | | | | | | |
| Male patrons | 1 — 100 | 1 | 1 — 50 | 1 | 1 — 50 | 1 |
| | 101 — 300 | 2 | 51 — 100 | 2 | 51 — 200 | 2 |
| | >300 | Add 1 per 200 | 101 — 150 | 3 | >200 | Add 1 per 200 |
| | | | 151 — 200 | 4 | | |
| | | | 201 — 250 | 5 | | |
| | | >250 | Add 1 per 100 | | | |
| Female patrons | 1 — 25 | 1 | | | 1 — 50 | 1 |
| | 26 — 50 | 2 | | | 51 — 150 | 2 |
| | 51 — 100 | 3 | | | >150 | Add 1 per 200 |
| | 101 — 150 | 4 | | | | |
| | 151 — 200 | 5 | | | | |
| | 201 — 250 | 6 | | | | |
| | >250 | Add 1 per 100 | | | | |
| Note: Sanitary facilities need not be provided for patrons if the building accommodates not more than 20 people. | | | | | | |

Deemed-to-Satisfy Provisions **SUPERSEDED**

Table F2.3 SANITARY FACILITIES IN CLASS 3, 5, 6, 7, 8 OR 9 BUILDINGS — continued

| User Group | Closet Pans | | Urinals | | Washbasins | |
|---|------------------|---------------|------------------|---------------|------------------|--------------|
| | Design Occupancy | Number | Design Occupancy | Number | Design Occupancy | Number |
| Class 9a — health-care buildings | | | | | | |
| Male patients | 1 — 16 | 2 | | | 1 — 8 | 1 |
| | >16 | Add 1 per 8 | | | > 8 | Add 1 per 8 |
| Female patients | 1 — 16 | 2 | | | 1 — 8 | 1 |
| | >16 | Add 1 per 8 | | | > 8 | Add 1 per 8 |
| Class 9b — schools | | | | | | |
| Male employees | 1 — 20 | 1 | 1 — 10 | 0 | 1 — 30 | 1 |
| | > 20 | Add 1 per 20 | 11 — 20 | 1 | > 30 | Add 1 per 30 |
| | | | 21 — 45 | 2 | | |
| | | | >45 | Add 1 per 30 | | |
| Female employees | 1 — 5 | 1 | | | 1 — 30 | 1 |
| | >5 | Add 1 per 15 | | | > 30 | Add 1 per 30 |
| Male students | 1 — 25 | 1 | 1 — 50 | 1 | 1 — 10 | 1 |
| | 26 — 75 | 2 | 51 — 100 | 2 | 11 — 50 | 2 |
| | 76 — 150 | 3 | >100 | Add 1 per 100 | 51 — 100 | 3 |
| | 151 — 200 | 4 | | | > 100 | Add 1 per 75 |
| | > 200 | Add 1 per 100 | | | | |
| Female students | 1 — 10 | 1 | | | 1 — 10 | 1 |
| | 11 — 25 | 2 | | | 11 — 50 | 2 |
| | 26 — 100 | Add 1 per 25 | | | 51 — 100 | 3 |
| | > 100 | Add 1 per 50 | | | > 100 | Add 1 per 75 |

Deemed-to-Satisfy Provisions **SUPERSEDED**

Table F2.3 SANITARY FACILITIES IN CLASS 3, 5, 6, 7, 8 OR 9 BUILDINGS — continued

| User Group | Closet Pans | | Urinals | | Washbasins | |
|--|------------------|---------------|------------------|---------------|------------------|---------------|
| | Design Occupancy | Number | Design Occupancy | Number | Design Occupancy | Number |
| Class 9b — early childhood centres | | | | | | |
| Children | 1 — 30 | 2 | | | 1 — 30 | 2 |
| | > 30 | Add 1 per 15 | | | > 30 | Add 1 per 15 |
| Note: Facilities for use by children must be— (a) junior pans; and (b) washbasins with a rim height not exceeding 600mm; and (c) accessible from both indoor and outdoor play areas. | | | | | | |
| Class 9b — theatres and cinemas with multiple auditoria, art galleries or the like | | | | | | |
| Male participants | 1 — 20 | 1 | 1 — 10 | 1 | 1 — 10 | 1 |
| | > 20 | Add 1 per 20 | > 10 | Add 1 per 10 | > 10 | Add 1 per 10 |
| Female participants | 1 — 10 | 1 | | | 1 — 10 | 1 |
| | > 10 | Add 1 per 10 | | | > 10 | Add 1 per 10 |
| Male spectators or patrons | 1 — 250 | 1 | 1 — 100 | 1 | 1 — 150 | 1 |
| | 251 — 500 | 2 | >100 | Add 1 per 100 | >150 | Add 1 per 150 |
| | >500 | Add 1 per 500 | | | | |
| Female spectators or patrons | 1 — 10 | 1 | | | 1 — 80 | 1 |
| | 11 — 50 | 2 | | | 81 — 250 | 2 |
| | >51 | Add 1 per 60 | | | 251 — 430 | 3 |
| | | | | > 430 | Add 1 per 200 | |

Deemed-to-Satisfy Provisions **SUPERSEDED**

Table F2.3 SANITARY FACILITIES IN CLASS 3, 5, 6, 7, 8 OR 9 BUILDINGS — continued

| User Group | Closet Pans | | Urinals | | Washbasins | |
|--|------------------|---------------|------------------|---------------|------------------|---------------|
| | Design Occupancy | Number | Design Occupancy | Number | Design Occupancy | Number |
| Class 9b — single auditorium theatres and cinemas | | | | | | |
| Male patrons | 1 — 50 | 0 | 1 — 50 | 0 | 1 — 50 | 0 |
| | 51 — 250 | 1 | 51 — 100 | 1 | 51 — 150 | 1 |
| | 251 — 500 | 2 | >100 | Add 1 per 100 | >150 | Add 1 per 150 |
| | >500 | Add 1 per 500 | | | | |
| Female patrons | 1 — 50 | 0 | | | 1 — 50 | 0 |
| | 51 — 110 | 3 | | | 51 — 150 | 1 |
| | 111 — 170 | 4 | | | >150 | Add 1 per 150 |
| | 171 — 230 | 5 | | | | |
| | 231 — 250 | 6 | | | | |
| | >250 | Add 1 per 80 | | | | |
| Class 9b — sports venues or the like | | | | | | |
| Male participants | 1 — 20 | 1 | 1 — 10 | 1 | 1 — 10 | 1 |
| | > 20 | Add 1 per 20 | > 10 | Add 1 per 10 | > 10 | Add 1 per 10 |
| Female participants | 1 — 10 | 1 | | | 1 — 10 | 1 |
| | > 10 | Add 1 per 10 | | | > 10 | Add 1 per 10 |
| Male spectators or patrons | 1 — 250 | 1 | 1 — 100 | 1 | 1 — 150 | 1 |
| | 251 — 500 | 2 | > 100 | Add 1 per 100 | > 150 | Add 1 per 150 |
| | > 500 | Add 1 per 500 | | | | |

SUPERSEDED
Deemed-to-Satisfy Provisions

Table F2.3 SANITARY FACILITIES IN CLASS 3, 5, 6, 7, 8 OR 9 BUILDINGS — continued

| User Group | Closet Pans | | Urinals | | Washbasins | |
|--|------------------|---------------|------------------|---------------|------------------|---------------|
| | Design Occupancy | Number | Design Occupancy | Number | Design Occupancy | Number |
| Female spectators or patrons | 1 — 15 | 1 | | | 1 — 60 | 1 |
| | 16 — 60 | 2 | | | 61 — 200 | 2 |
| | 61 — 120 | 3 | | | 201 — 350 | 3 |
| | > 120 | Add 1 per 70 | | | > 350 | Add 1 per 150 |
| Class 9b — churches, chapels or the like | | | | | | |
| Male patrons | 1 — 300 | 1 | 1 — 200 | 1 | 1 — 250 | 1 |
| | >300 | Add 1 per 500 | > 200 | Add 1 per 200 | > 250 | Add 1 per 250 |
| Female patrons | 1 — 150 | 1 | | | 1 — 250 | 1 |
| | > 150 | Add 1 per 150 | | | > 250 | Add 1 per 250 |
| Class 9b — public halls, function rooms or the like | | | | | | |
| Male patrons | 1 — 100 | 1 | 1 — 50 | 1 | 1 — 50 | 1 |
| | >100 | Add 1 per 200 | 51 — 100 | 2 | 51 — 200 | 2 |
| | | | 101 — 150 | 3 | >200 | Add 1 per 200 |
| | | | 151 — 200 | 4 | | |
| | | | 201 — 250 | 5 | | |
| | | | >250 | Add 1 per 100 | | |

Deemed-to-Satisfy Provisions **SUPERSEDED**

Table F2.3 SANITARY FACILITIES IN CLASS 3, 5, 6, 7, 8 OR 9 BUILDINGS — continued

| User Group | Closet Pans | | Urinals | | Washbasins | |
|----------------|------------------|---------------|------------------|--------|------------------|---------------|
| | Design Occupancy | Number | Design Occupancy | Number | Design Occupancy | Number |
| Female patrons | 1 — 25 | 1 | | | 1 — 50 | 1 |
| | 26 — 50 | 2 | | | 51 — 150 | 2 |
| | 51 — 100 | 3 | | | >150 | Add 1 per 200 |
| | 101 — 150 | 4 | | | | |
| | 151 — 200 | 5 | | | | |
| | 201 — 250 | 6 | | | | |
| | >250 | Add 1 per 100 | | | | |

Note: Sanitary facilities need not be provided for patrons if the building accommodates not more than 20 people.

Notes:

1. Number — means the number of facilities *required*.
2. > — means greater than
3. Employees — a reference to employees includes owners and managers using the building.
4. A reference to "add 1 per 100 or 150, 250, 500" etc. includes any part of that number.

Deemed-to-Satisfy Provisions

F2.4 Accessible sanitary facilities

In a building *required* to be *accessible*—

SA F2.4(a)

- (a) *accessible* unisex *sanitary compartments* must be provided in *accessible* parts of the building in accordance with **Table F2.4(a)**; and

SA F2.4(b)

- (b) *accessible* unisex showers must be provided in accordance with **Table F2.4(b)**; and
- (c) at each bank of toilets where there is one or more toilets in addition to an *accessible* unisex *sanitary compartment* at that bank of toilets, a *sanitary compartment* suitable for a person with an ambulant disability in accordance with AS 1428.1 must be provided for use by males and females; and
- (d) an *accessible* unisex *sanitary compartment* must contain a closet pan, washbasin, shelf or bench top and adequate means of disposal of sanitary towels; and
- (e) the circulation spaces, fixtures and fittings of all *accessible* sanitary facilities provided in accordance with **Table F2.4(a)** and **Table F2.4(b)** must comply with the requirements of AS 1428.1; and
- (f) an *accessible* unisex sanitary facility must be located so that it can be entered without crossing an area reserved for one sex only; and
- (g) where two or more of each type of *accessible* unisex sanitary facility are provided, the number of left and right handed mirror image facilities must be provided as evenly as possible; and
- (h) where male sanitary facilities are provided at a separate location to female sanitary facilities, *accessible* unisex sanitary facilities are only *required* at one of those locations; and
- (i) an *accessible* unisex *sanitary compartment* or an *accessible* unisex shower need not be provided on a *storey* or level that is not *required* by **D3.3(f)** to be provided with a passenger lift or ramp complying with AS 1428.1.

Table F2.4(a) ACCESSIBLE UNISEX SANITARY COMPARTMENTS

| Class of building | Minimum accessible unisex sanitary compartments to be provided |
|-------------------|--|
| Class 1b | <ul style="list-style-type: none"> (a) Not less than 1; and (b) where private <i>accessible</i> unisex <i>sanitary compartments</i> are provided for every <i>accessible</i> bedroom, common <i>accessible</i> unisex <i>sanitary compartments</i> need not be provided. |
| Class 2 | Where <i>sanitary compartments</i> are provided in common areas, not less than 1. |

Deemed-to-Satisfy Provisions

Table F2.4(a) ACCESSIBLE UNISEX SANITARY COMPARTMENTS — *continued*

| Class of building | Minimum accessible unisex sanitary compartments to be provided |
|---|--|
| Class 3 and Class 9c <i>aged care building</i> | (a) In every <i>accessible sole-occupancy unit</i> provided with <i>sanitary compartments</i> within the <i>accessible sole-occupancy unit</i> , not less than 1; and (b) at each bank of <i>sanitary compartments</i> containing male and female <i>sanitary compartments</i> provided in common areas, not less than 1. |
| Class 5, 6, 7, 8 or 9 — except for within a <i>ward area</i> of a Class 9a <i>health-care building</i> | Where F2.3 requires closet pans— (a) 1 on every <i>storey</i> containing <i>sanitary compartments</i> ; and (b) where a <i>storey</i> has more than 1 bank of <i>sanitary compartments</i> containing male and female <i>sanitary compartments</i> , at not less than 50% of those banks. |
| Class 10a except— (a) a Class 10a appurtenant to another Class of building; and (b) a <i>sanitary compartments</i> dedicated to a single caravan/camping site | At each bank of <i>sanitary compartments</i> containing male and female <i>sanitary compartments</i> , not less than 1. |

SA Table F2.4(a)(i)

Table F2.4(b) ACCESSIBLE UNISEX SHOWERS

| Class of building | Minimum accessible unisex showers to be provided |
|--|--|
| Class 1b | (a) Not less than 1; and (b) where private <i>accessible</i> unisex showers are provided for every <i>accessible</i> bedroom, common <i>accessible</i> unisex showers need not be provided. |
| Class 2 | Where showers are provided in common areas, not less than 1 |
| Class 3 and Class 9c <i>aged care building</i> | (a) In every <i>accessible sole-occupancy unit</i> provided with showers within the <i>accessible sole-occupancy unit</i> , not less than 1; and (b) 1 for every 10 showers or part thereof provided in common areas. |
| Class 5, 6, 7, 8 or 9 — except for within a <i>ward area</i> of a Class 9a <i>health-care building</i> | Where F2.3 requires 1 or more showers, not less than 1 for every 10 showers or part thereof. |

Deemed-to-Satisfy Provisions

Table F2.4(b) ACCESSIBLE UNISEX SHOWERS — *continued*

| Class of building | Minimum accessible unisex showers to be provided |
|--|---|
| Class 10a except— (a) a Class 10a appurtenant to another Class of building; and (b) a <i>sanitary compartment</i> dedicated to a single caravan/camping site | Where showers are provided, 1 for every 10 showers or part thereof. |

SA Table F2.4(b)(i)

F2.5 Construction of sanitary compartments

- (a) Other than in an *early childhood centre*, *sanitary compartments* must have doors and partitions that separate adjacent compartments and extend—
 - (i) from floor level to the ceiling in the case of a unisex facility; or
 - (ii) to a height of not less than 1.5 m above the floor if primary *school* children are the principal users; or
 - (iii) 1.8 m above the floor in all other cases.
- (b) The door to a fully enclosed *sanitary compartment* must—
 - (i) open outwards; or
 - (ii) slide; or
 - (iii) be readily removable from the outside of the *sanitary compartment*,
 unless there is a clear space of at least 1.2 m, measured in accordance with **Figure F2.5**, between the closet pan within the *sanitary compartment* and the doorway.

Vic F2.5(c)

- (c) In an *early childhood centre*, facilities for use by children must have each *sanitary compartment* screened by a partition which, except for the doorway, is opaque for a height of at least 900 mm but not more than 1200 mm above the floor level.

Deemed-to-Satisfy Provisions

Figure F2.5

CONSTRUCTION OF SANITARY COMPARTMENTS

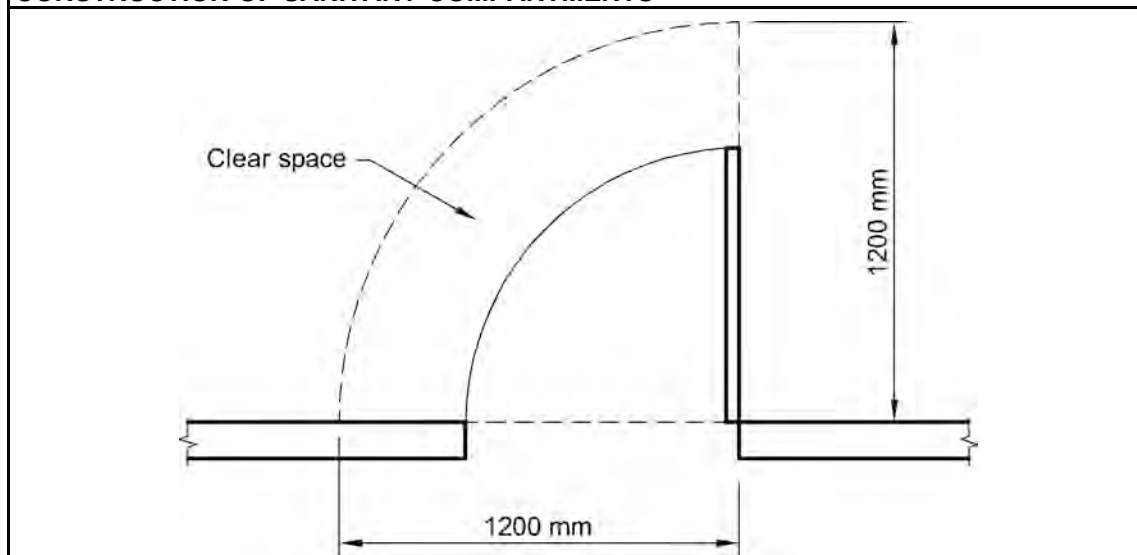

F2.6 Interpretation: Urinals and washbasins

- (a) A urinal may be—
 - (i) an individual stall or wall-hung urinal; or
 - (ii) each 600 mm length of a continuous urinal trough; or
 - (iii) a closet pan used in place of a urinal.
- (b) A washbasin may be—
 - (i) an individual basin; or
 - (ii) a part of a hand washing trough served by a single water tap.

F2.7 Microbial (legionella) control

NSW F2.7

Hot water, warm water and cooling water systems in a building other than a system serving only a single *sole-occupancy unit* in a Class 2 or 3 building or Class 4 part of a building must be installed in accordance with AS/NZS 3666.1.

F2.8 Waste management

- (a) In a Class 9a *health-care building*, at least one slop-hopper or other device, other than a water closet pan or urinal, must be provided—
 - (i) on any *storey* containing *ward areas* or bedrooms to facilitate emptying of containers of sewage or dirty water; and
 - (ii) with a flushing apparatus, tap and grating.

Deemed-to-Satisfy Provisions

- (b) In a Class 9c *aged care building*, the following facilities must be provided for every 60 beds or part thereof on each storey containing *resident use areas*—
- (i) one slop-hopper or other device other than a water closet pan or urinal for the safe handling and disposal of liquid and solid wastes with a flushing apparatus, tap and grating; and
 - (ii) an appliance for the disinfection of pans or an adequate means to dispose of receptacles.

Tas F2.101, F2.102

Vic F2.101

PART F3 ROOM HEIGHTS

OBJECTIVE

FO3

Vic FO3

The *Objective* of this Part is to safeguard occupants from injury or loss of amenity caused by inadequate height of a room or space.

FUNCTIONAL STATEMENT

FF3.1

Vic FF3.1

A building is to be constructed to provide height in a room or space suitable for the intended use.

PERFORMANCE REQUIREMENT

FP3.1

Vic FP3.1

A *habitable room* or space must have sufficient height that does not unduly interfere with its intended function.

PART F3 ROOM HEIGHTS

Deemed-to-Satisfy Provisions

F3.0 Deemed-to-Satisfy Provisions

Vic F3.0

- (a) Where a *Building Solution* is proposed to comply with the *Deemed-to-Satisfy Provisions, Performance Requirements FP3.1* is satisfied by complying with **F3.1**.
- (b) Where a *Building Solution* is proposed as an *Alternative Solution* to the *Deemed-to-Satisfy Provisions of F3.1*, the relevant *Performance Requirements* must be determined in accordance with **A0.10**.

F3.1 Height of rooms and other spaces

The ceiling height must be not less than—

- (a) in a Class 2 or 3 building or Class 4 part of a building—
 - (i) a kitchen, laundry, or the like — 2.1 m; and
 - (ii) a corridor, passageway or the like — 2.1 m; and
 - (iii) a *habitable room* excluding a kitchen — 2.4 m; and
 - (iv) in a room or space with a sloping ceiling or projections below the ceiling line within—
 - (A) a *habitable room*—
 - (aa) in an attic — a height of not less than 2.2 m for not less than two-thirds of the *floor area* of the room or space; and
 - (bb) in other rooms — a height of not less than 2.4 m for not less than two-thirds of the *floor area* of the room or space; and
 - (B) a non-*habitable room* — a height of not less than 2.1 m for not less than two-thirds of the *floor area* of the room or space; andwhen calculating the *floor area* of a room or space, any part that has a ceiling height of less than 1.5 m is not included; and
- (b) in a Class 5, 6, 7 or 8 building—
 - (i) except as allowed in **(ii)** and **(f)** — 2.4 m; and
 - (ii) a corridor, passageway, or the like — 2.1 m; and
- (c) in a Class 9a *health-care building*—
 - (i) a *patient care area* — 2.4 m; and
 - (ii) an operating theatre or delivery room — 3 m; and
 - (iii) a treatment room, clinic, waiting room, passageway, corridor, or the like — 2.4 m; and
- (d) in a Class 9b building—

Deemed-to-Satisfy Provisions

- (i) a *school* classroom or other *assembly building* or part that accommodates not more than 100 persons — 2.4 m; and
- (ii) a theatre, public hall or other *assembly building* or part that accommodates more than 100 persons — 2.7 m; and
- (iii) a corridor—
 - (A) that serves an *assembly building* or part that accommodates not more than 100 persons — 2.4 m; or
 - (B) that serves an *assembly building* or part that accommodates more than 100 persons — 2.7 m; and
- (e) in a Class 9c *aged care building*—
 - (i) a kitchen, laundry, or the like — 2.1 m; and
 - (ii) a corridor, passageway or the like — 2.4 m; and
 - (iii) a *habitable room* excluding a kitchen — 2.4 m; and
- (f) in any building—
 - (i) a bathroom, shower room, *sanitary compartment*, airlock, tea preparation room, pantry, store room, garage, car parking area, or the like — 2.1 m; and
 - (ii) a commercial kitchen — 2.4 m; and
 - (iii) above a stairway, ramp, landing or the like — 2 m measured vertically above the nosing line of stairway treads or the floor surface of the ramp, landing or the like.

Vic F3.101 — F3.103

PART F4 LIGHT AND VENTILATION

OBJECTIVE

FO4

The *Objective* of this Part is to—

- (a) safeguard occupants from injury, illness or loss of amenity due to—
 - (i) isolation from natural light; and
 - (ii) lack of adequate artificial lighting; and
- (b) safeguard occupants from illness or loss of amenity due to lack of air freshness.

FUNCTIONAL STATEMENTS

FF4.1

A space within a building used by occupants is to be provided with openings to admit natural light consistent with its function or use.

FF4.2

A space within a building used by occupants is to be provided with artificial lighting consistent with its function or use which, when activated in the absence of suitable natural light, will enable safe movement.

FF4.3

A space used by occupants within a building is to be provided with adequate ventilation consistent with its function or use.

PERFORMANCE REQUIREMENTS

FP4.1

Sufficient openings must be provided and distributed in a building so that natural light, when available, provides a level of *illuminance* appropriate to the function or use of that part of the building.

FP4.2

Artificial lighting must be installed to provide a level of *illuminance* appropriate to the function or use of the building to enable safe movement by occupants.

FP4.3

A space in a building used by occupants must be provided with means of ventilation with *outdoor air* which will maintain adequate air quality.

FP4.4

A mechanical air-handling system installed in a building must control—

- (a) the circulation of objectionable odours; and
- (b) the accumulation of harmful contamination by micro-organisms, pathogens and toxins.

FP4.5

Contaminated air must be disposed of in a manner which does not unduly create a nuisance or hazard to people in the building or *other property*.

PART F4 LIGHT AND VENTILATION

Deemed-to-Satisfy Provisions

F4.0 Deemed-to-Satisfy Provisions

- (a) Where a *Building Solution* is proposed to comply with the *Deemed-to-Satisfy Provisions, Performance Requirements FP4.1 to FP4.5* are satisfied by complying with **F4.1 to F4.12**.
- (b) Where a *Building Solution* is proposed as an *Alternative Solution* to the *Deemed-to-Satisfy Provisions* of **F4.1 to F4.12**, the relevant *Performance Requirements* must be determined in accordance with **A0.10**.

F4.1 Provision of natural light

Natural lighting must be provided in:

- (a) **Class 2 buildings and Class 4 parts of buildings** — to all *habitable rooms*.
- (b) **Class 3 buildings** — to all bedrooms and dormitories.
- (c) **Class 9a and 9c buildings** — to all rooms used for sleeping purposes.

Vic F4.1(d)

- (d) **Class 9b buildings** — to all general purpose classrooms in primary or secondary *schools* and all playrooms or the like for the use of children in an *early childhood centre*.

F4.2 Methods and extent of natural lighting

- (a) *Required* natural lighting must be provided by—
 - (i) *windows*, excluding *roof lights*, that—
 - (A) have an aggregate light transmitting area measured exclusive of framing members, glazing bars or other obstructions of not less than 10% of the *floor area* of the room; and
 - (B) are open to the sky or face a court or other space open to the sky or an open verandah, carport or the like; or
 - (ii) *roof lights*, that—
 - (A) have an aggregate light transmitting area measured exclusive of framing members, glazing bars or other obstructions of not less than 3% of the *floor area* of the room; and
 - (B) are open to the sky; or
 - (iii) a proportional combination of *windows* and *roof lights required* by (i) and (ii).

Vic F4.2(b)

- (b) Except in a Class 9c *aged care building*, in a Class 2, 3 or 9 building or Class 4 part of a building a *required window* that faces a boundary of an adjoining allotment or a wall of the same building or another building on the allotment must not be less than a horizontal distance from that boundary or wall that is the greater of—
 - (i) generally — 1 m; and

Deemed-to-Satisfy Provisions

- (ii) in a *patient care area* or other room used for sleeping purposes in a Class 9a building — 3 m; and
- (iii) 50% of the square root of the exterior height of the wall in which the *window* is located, measured in metres from its sill.

Vic F4.2(c)

- (c) In a Class 9c *aged care building*, a *required window* must be transparent and located—
 - (i) in an *external wall* with the *window* sill not more than 1 m above the floor level; and
 - (ii) where the *window* faces an adjoining allotment, another building or another wall of the same building, it must not be less than a horizontal distance of 3 m from the adjoining allotment, other building or wall.

Vic F4.2(d)

- (d) In a Class 9b *early childhood centre*, the sills of 50% of *windows* in children's rooms must be located not more than 500 mm above the floor level.

F4.3 Natural light borrowed from adjoining room

- (a) Natural lighting to a room in a Class 2 building or Class 4 part of a building or in a *sole-occupancy unit* of a Class 3 building, may come through a glazed panel or opening from an adjoining room (including an enclosed verandah) if—
 - (i) both rooms are within the same *sole-occupancy unit* or the enclosed verandah is on common property; and
 - (ii) the glazed panel or opening has an area of not less than 10% of the *floor area* of the room to which it provides light; and
 - (iii) the adjoining room has—
 - (A) *windows*, excluding *roof lights*, that—
 - (aa) have an aggregate light transmitting area of not less than 10% of the combined *floor areas* of both rooms; and
 - (bb) are open to the sky or face a court or other space open to the sky or an open verandah, carport or the like; or
 - (B) *roof lights*, that—
 - (aa) have an aggregate light transmitting area of not less than 3% of the combined *floor areas* of both rooms; and
 - (bb) are open to the sky; or
 - (C) a proportional combination of *windows* and *roof lights required* by (A) and (B).
- (b) The areas specified in (a)(ii) and (a)(iii) may be reduced as appropriate if direct natural light is provided from another source.

F4.4 Artificial lighting

- (a) Artificial lighting must be provided—
 - (i) in *required* stairways, passageways, and ramps; and

Deemed-to-Satisfy Provisions

- (ii) if natural lighting of a standard equivalent to that *required* by **F4.2** is not available, and the periods of occupation or use of the room or space will create undue hazard to occupants seeking egress in an emergency, in—
 - (A) Class 4 parts of a building — to *sanitary compartments*, bathrooms, shower rooms, airlocks and laundries; and
 - (B) Class 2 buildings — to *sanitary compartments*, bathrooms, shower rooms, airlocks, laundries, common stairways and other spaces used in common by the occupants of the building; and
 - (C) Class 3, 5, 6, 7, 8 and 9 buildings — to all rooms that are frequently occupied, all spaces *required* to be *accessible*, all corridors, lobbies, internal stairways, other circulation spaces and paths of egress.
- (b) The artificial lighting system must comply with AS/NZS 1680.0.
- (c) The system may provide a lesser level of illumination to the following spaces during times when the level of lighting would be inappropriate for the use:
 - (i) A theatre, cinema or the like, when performances are in progress, with the exception of aisle lighting *required* by **Part H1**.
 - (ii) A museum, gallery or the like, where sensitive displays require low lighting levels.
 - (iii) A discotheque, nightclub or the like, where to create an ambience and character for the space, low lighting levels are used.

F4.5 Ventilation of rooms

A *habitable room*, office, shop, factory, workroom, *sanitary compartment*, bathroom, shower room, laundry and any other room occupied by a person for any purpose must have—

- (a) natural ventilation complying with **F4.6**; or
- (b) a mechanical ventilation or air-conditioning system complying with AS 1668.2 and AS/NZS 3666.1.

NSW F4.5(b)

F4.6 Natural ventilation

- (a) Natural ventilation provided in accordance with **F4.5(a)** must consist of permanent openings, *windows*, doors or other devices which can be opened—
 - (i) with an aggregate opening or openable size not less than 5% of the *floor area* of the room *required* to be ventilated; and
 - (ii) open to—
 - (A) a suitably sized court, or space open to the sky; or
 - (B) an open verandah, carport, or the like; or
 - (C) an adjoining room in accordance with **F4.7**.
- (b) The requirements of **(a)(i)** do not apply to a Class 8 *electricity network substation*.

Deemed-to-Satisfy Provisions

F4.7 Ventilation borrowed from adjoining room

Natural ventilation to a room may come through a *window*, opening, ventilating door or other device from an adjoining room (including an enclosed verandah) if both rooms are within the same *sole-occupancy unit* or the enclosed verandah is common property, and—

- (a) in a Class 2 building, a *sole-occupancy unit* of a Class 3 building or Class 4 part of a building—
 - (i) the room to be ventilated is not a *sanitary compartment*; and
 - (ii) the *window*, opening, door or other device has a ventilating area of not less than 5% of the *floor area* of the room to be ventilated; and
 - (iii) the adjoining room has a *window*, opening, door or other device with a ventilating area of not less than 5% of the combined *floor areas* of both rooms; and
- (b) in a Class 5, 6, 7, 8 (except a Class 8 *electricity network substation*) or 9 building—
 - (i) the *window*, opening, door or other device has a ventilating area of not less than 10% of the *floor area* of the room to be ventilated, measured not more than 3.6 m above the floor; and
 - (ii) the adjoining room has a *window*, opening, door or other device with a ventilating area of not less than 10% of the combined *floor areas* of both rooms; and
- (c) the ventilating areas specified in (a) and (b) may be reduced as appropriate if direct natural ventilation is provided from another source.

F4.8 Restriction on position of water closets and urinals

A room containing a closet pan or urinal must not open directly into—

- (a) a kitchen or pantry; or
- (b) a public dining room or restaurant; or
- (c) a dormitory in a Class 3 building; or
- (d) a room used for public assembly (which is not an *early childhood centre*, primary *school* or *open spectator stand*); or
- (e) a workplace normally occupied by more than one person.

F4.9 Airlocks

If a room containing a closet pan or urinal is prohibited under F4.8 from opening directly to another room—

- (a) in a *sole-occupancy unit* in a Class 2 or 3 building or Class 4 part of a building—
 - (i) access must be by an airlock, hallway or other room; or
 - (ii) the room containing the closet pan or urinal must be provided with mechanical exhaust ventilation; and
- (b) in a Class 5, 6, 7, 8 or 9 building (which is not an *early childhood centre*, primary *school* or *open spectator stand*)—
 - (i) access must be by an airlock, hallway or other room with a *floor area* of not less than 1.1 m² and fitted with *self-closing* doors at all access doorways; or

Deemed-to-Satisfy Provisions

- (ii) the room containing the closet pan or urinal must be provided with mechanical exhaust ventilation and the doorway to the room adequately screened from view.

F4.10 * * * * *

This clause has deliberately been left blank. Its content covering sub-floor ventilation has been relocated to [F1.12](#).

F4.11 Carparks

- (a) Every *storey* of a *carpark*, except an *open-deck carpark*, must have—
 - (i) a system of ventilation complying with AS 1668.2; or
 - (ii) an adequate system of permanent natural ventilation.
- (b) A mechanical ventilation system, serving a *carpark* with more than 40 vehicle spaces and controlled by an atmospheric contaminant monitoring system in accordance with AS 1668.2, may be stopped when the monitored condition is below the determined maximum concentration if—
 - (i) the system operates intermittently to provide a minimum of 0.5 air changes per hour (ACH) during any 24 hour period; or
 - (ii) a supplemental natural ventilation system equivalent to **(i)** is provided.

F4.12 Kitchen local exhaust ventilation

A commercial kitchen must be provided with a kitchen exhaust hood complying with AS/NZS 1668.1 and AS 1668.2 where—

- (a) any cooking apparatus has—
 - (i) a total maximum electrical power input exceeding 8 kW; or
 - (ii) a total gas power input exceeding 29 MJ/h; or
- (b) the total maximum power input to more than one apparatus exceeds—
 - (i) 0.5 kW electrical power; or
 - (ii) 1.8 MJ gas,
per m² of *floor area* of the room or enclosure.

Tas F4.101

PART F5 SOUND TRANSMISSION AND INSULATION

NT Part F5

OBJECTIVE

FO5

The *Objective* of this Part is to safeguard occupants from illness or loss of amenity as a result of undue sound being transmitted—

- (a) between adjoining *sole-occupancy units*; and
- (b) from common spaces to *sole-occupancy units*; and
- (c) from parts of different classifications to *sole-occupancy units*.

Application:

FO5 only applies to a Class 2 or 3 building or a Class 9c *aged care building*.

FUNCTIONAL STATEMENT

FF5.1

A part of a building that separates *sole-occupancy units*, or separates a sole-occupancy unit from a common space or part of another classification within the building is to be constructed to prevent undue sound transmission.

Application:

FF5.1 only applies to a Class 2 or 3 building or a Class 9c *aged care building*.

PERFORMANCE REQUIREMENTS

FP5.1

Floors separating—

- (a) *sole-occupancy units*; or
- (b) a *sole-occupancy unit* from a plant room, lift *shaft*, stairway, *public corridor*, public lobby, or the like, or a part of a different classification,

must provide insulation against the transmission of airborne and impact generated sound sufficient to prevent illness or loss of amenity to the occupants.

Application:

FP5.1 only applies to a Class 2 or 3 building.

FP5.2

Walls separating *sole-occupancy units* or a *sole-occupancy unit* from a plant room, lift *shaft*, stairway, *public corridor*, public lobby, or the like, or parts of a different classification, must provide insulation against the transmission of—

- (a) airborne sound; and
- (b) impact generated sound, if the wall is separating a bathroom, *sanitary compartment*, laundry or kitchen in one *sole-occupancy unit* from a *habitable room* (other than a kitchen) in an adjoining unit,

sufficient to prevent illness or loss of amenity to the occupants.

Application:

FP5.2 only applies to a Class 2 or 3 building.

FP5.3

The *required* sound insulation of a floor or a wall must not be compromised by—

- (a) the incorporation or penetration of a pipe or other service element; or
- (b) a door assembly.

Application:

FP5.3 only applies to a Class 2 or 3 building.

FP5.4

Floors separating *sole-occupancy units* must provide insulation against the transmission of airborne and impact generated sound sufficient to prevent illness or loss of amenity to the occupants.

Application:

FP5.4 only applies to a Class 9c *aged care building*.

FP5.5

Walls separating *sole-occupancy units*, or a *sole-occupancy unit* from a kitchen, bathroom, *sanitary compartment* (not being an associated ensuite), laundry, plant room or utilities room, must provide insulation against the transmission of—

- (a) airborne sound; and
- (b) impact generated sound, if the wall separates a *sole-occupancy unit* from a kitchen or laundry,

sufficient to prevent illness or loss of amenity to the occupants.

Application:

FP5.5 only applies to a Class 9c *aged care building*.

FP5.6

The *required* sound insulation of a floor or a wall must not be compromised by the incorporation or penetration of a pipe or other service element.

Application:

FP5.6 only applies to a Class 9c *aged care building*.

VERIFICATION METHODS

FV5.1

Compliance with **FP5.1** and **FP5.3** to avoid the transmission of airborne and impact generated sound through floors is verified when it is measured in-situ that the separating floor has—

- (a) airborne: a weighted standardised level difference with spectrum adaptation term ($D_{nT,w} + C_{tr}$) not less than 45 when determined under AS/NZS 1276.1 or ISO 717.1; and
- (b) impact: a weighted standardised impact sound pressure level with spectrum adaptation term ($L_{nT,w} + C_i$) not more than 62 when determined under AS/ISO 717.2.

FV5.2

Compliance with **FP5.2(a)** and **FP5.3** to avoid the transmission of airborne sound through walls is verified when it is measured in-situ that—

- (a) a wall separating *sole-occupancy units* has a weighted standardised level difference with spectrum adaptation term ($D_{nT,w} + C_{tr}$) not less than 45 when determined under AS/NZS 1276.1 or ISO 717.1; or
- (b) a wall separating a *sole-occupancy unit* from a plant room, lift *shaft*, stairway, *public corridor*, public lobby, or the like, or parts of a different classification, has a weighted standardised level difference ($D_{nT,w}$) not less than 45 when determined under AS/NZS 1276.1 or ISO 717.1; or
- (c) any door assembly located in a wall that separates a *sole-occupancy unit* from a stairway, public corridor, public lobby, or the like, has a weighted standardised level difference ($D_{nT,w}$) not less than 25 when determined under AS/NZS 1276.1 or ISO 717.1.

PART F5 SOUND TRANSMISSION AND INSULATION

Deemed-to-Satisfy Provisions

NT Part F5

F5.0 Deemed-to-Satisfy Provisions

- (a) Where a *Building Solution* is proposed to comply with the *Deemed-to-Satisfy Provisions, Performance Requirements FP5.1 to FP5.6* are satisfied by complying with **F5.1 to F5.7**.
- (b) Where a *Building Solution* is proposed as an *Alternative Solution* to the *Deemed-to-Satisfy Provisions* of **F5.1 to F5.7**, the relevant *Performance Requirements* must be determined in accordance with **A0.10**.

F5.1 Application of Part

The *Deemed-to-Satisfy Provisions* of this Part apply to Class 2 and 3 buildings and Class 9c *aged care buildings*.

F5.2 Determination of airborne sound insulation ratings

A form of construction *required* to have an airborne sound insulation rating must—

- (a) have the *required* value for weighted sound reduction index (R_w) or weighted sound reduction index with spectrum adaptation term ($R_w + C_{tr}$) determined in accordance with AS/NZS 1276.1 or ISO 717.1 using results from laboratory measurements; or
- (b) comply with **Specification F5.2**.

F5.3 Determination of impact sound insulation ratings

- (a) A floor in a building *required* to have an impact sound insulation rating must—
 - (i) have the *required* value for weighted normalised impact sound pressure level with spectrum adaptation term ($L_{n,w} + C_i$) determined in accordance with AS/ISO 717.2 using results from laboratory measurements; or
 - (ii) comply with **Specification F5.2**.
- (b) A wall in a building *required* to have an impact sound insulation rating must—
 - (i) for a Class 2 or 3 building be of discontinuous construction; and
 - (ii) for a Class 9c *aged care building*, must—
 - (A) for other than masonry, be two or more separate leaves without rigid mechanical connection except at the periphery; or
 - (B) be identical with a prototype that is no less resistant to the transmission of impact sound when tested in accordance with **Specification F5.5** than a wall listed in Table 2 of **Specification F5.2**.
- (c) For the purposes of this Part, discontinuous construction means a wall having a minimum 20 mm cavity between 2 separate leaves, and
 - (i) for masonry, where wall ties are required to connect leaves, the ties are of the resilient type; and

Deemed-to-Satisfy Provisions

- (ii) for other than masonry, there is no mechanical linkage between leaves except at the periphery.

F5.4 Sound insulation rating of floors

- (a) A floor in a Class 2 or 3 building must have an $R_w + C_{tr}$ (airborne) not less than 50 and an $L_{n,w} + C_l$ (impact) not more than 62 if it separates—
 - (i) *sole-occupancy units*; or
 - (ii) a *sole-occupancy unit* from a plant room, lift *shaft*, stairway, *public corridor*, public lobby or the like, or parts of a different classification.
- (b) A floor in a Class 9c *aged care building* separating *sole-occupancy units* must have an R_w not less than 45.

F5.5 Sound insulation rating of walls

- (a) A wall in a Class 2 or 3 building must—
 - (i) have an $R_w + C_{tr}$ (airborne) not less than 50, if it separates *sole-occupancy units*; and
 - (ii) have an R_w (airborne) not less than 50, if it separates a *sole-occupancy unit* from a plant room, lift *shaft*, stairway, *public corridor*, public lobby or the like, or parts of a different classification; and
 - (iii) comply with **F5.3(b)** if it separates—
 - (A) a bathroom, *sanitary compartment*, laundry or kitchen in one *sole-occupancy unit* from a *habitable room* (other than a kitchen) in an adjoining unit; or
 - (B) a *sole-occupancy unit* from a plant room or lift *shaft*.
- (b) A door may be incorporated in a wall in a Class 2 or 3 building that separates a *sole-occupancy unit* from a stairway, *public corridor*, public lobby or the like, provided the door assembly has an R_w not less than 30.
- (c) A wall in a Class 9c *aged care building* must have an R_w not less than 45 if it separates—
 - (i) *sole-occupancy units*; or
 - (ii) a *sole-occupancy unit* from a kitchen, bathroom, *sanitary compartment* (not being an associated ensuite), laundry, plant room or utilities room.
- (d) In addition to (c), a wall separating a *sole-occupancy unit* in a Class 9c *aged care building* from a kitchen or laundry must comply with **F5.3(b)**.
- (e) Where a wall *required* to have sound insulation has a floor above, the wall must continue to—
 - (i) the underside of the floor above; or
 - (ii) a ceiling that provides the sound insulation *required* for the wall.
- (f) Where a wall *required* to have sound insulation has a roof above, the wall must continue to—
 - (i) the underside of the roof above; or
 - (ii) a ceiling that provides the sound insulation *required* for the wall.

Deemed-to-Satisfy Provisions

F5.6 Sound insulation rating of internal services

- (a) If a duct, soil, waste or water supply pipe, including a duct or pipe that is located in a wall or floor cavity, serves or passes through more than one *sole-occupancy unit*, the duct or pipe must be separated from the rooms of any *sole-occupancy unit* by construction with an $R_w + C_{tr}$ (airborne) not less than—
- (i) 40 if the adjacent room is a *habitable room* (other than a kitchen); or
 - (ii) 25 if the adjacent room is a kitchen or non-*habitable room*.
- (b) If a storm water pipe passes through a *sole-occupancy unit* it must be separated in accordance with **(a)(i)** and **(ii)**.

F5.7 Sound isolation of pumps

A flexible coupling must be used at the point of connection between the service pipes in a building and any circulating or other pump.

SPECIFICATION **F5.2** SOUND INSULATION FOR BUILDING ELEMENTS

Deemed-to-Satisfy Provisions

1. Scope

- (a) This Specification lists the weighted sound reduction index R_w for some common forms of construction.
- (b) Wall systems listed in Table 2 having a minimum 20 mm cavity between 2 separate leaves, with—
 - (i) for masonry, where wall ties are required to connect leaves, the ties are of the resilient type; and
 - (ii) for other than masonry, there is no mechanical linkage between leaves except at the periphery,are deemed to be discontinuous construction.

2. Construction Deemed-to-Satisfy



The forms of construction listed in **Table 2** for wall construction and **Table 3** for floor construction, are considered to have the R_w , $R_w + C_{tr}$ and $L_{n,w} + C_I$ stated in that Table. The forms of construction must be installed as follows:

- (a) **Masonry** — Units must be laid with all joints filled solid, including those between the masonry and any adjoining construction.
- (b) **Concrete slabs** — Joints between concrete slabs or panels and any adjoining construction must be filled solid.
- (c) **Sheeting materials**—
 - (i) if one layer is *required* on both sides of a wall, it must be fastened to the studs with joints staggered on opposite sides; and
 - (ii) if two layers are *required*, the second layer must be fastened over the first layer so that the joints do not coincide with those of the first layer; and
 - (iii) joints between sheets or between sheets and any adjoining construction must be taped and filled solid.
- (d) **Timber or steel-framed construction** — perimeter framing members must be securely fixed to the adjoining structure and—
 - (i) bedded in resilient compound; or
 - (ii) the joints must be caulked so that there are no voids between the framing members and the adjoining structure.
- (e) **Services**—
 - (i) Services must not be chased into concrete or masonry elements.
 - (ii) A door or panel *required* to have a certain $R_w + C_{tr}$ that provides access to a duct, pipe or other service must—

Deemed-to-Satisfy Provisions



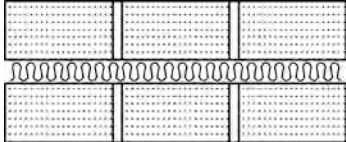

- (A) not open into any *habitable room* (other than a kitchen); and
- (B) be firmly fixed so as to overlap the frame or rebate of the frame by not less than 10 mm, be fitted with a sealing gasket along all edges and be constructed of—
 - (aa) wood, particleboard or blockboard not less than 33 mm thick; or
 - (bb) compressed fibre-reinforced cement sheeting not less than 9 mm thick; or
 - (cc) other suitable material with a mass per unit area not less than 24.4 kg/m².
- (iii) A water supply pipe must—
 - (A) only be installed in the cavity of discontinuous construction; and
 - (B) in the case of a pipe that serves only one *sole-occupancy unit*, not be fixed to the wall leaf on the side adjoining any other *sole-occupancy unit* and have a clearance not less than 10 mm to the other wall leaf.
- (iv) Electrical outlets must be offset from each other—
 - (A) in masonry walling, not less than 100 mm; and
 - (B) in timber or steel framed walling, not less than 300 mm.

Table 2 ACCEPTABLE FORMS OF CONSTRUCTION FOR WALLS

| Description | $R_w + C_{tr}$ (not less than) | R_w (not less than) | Construction |
|--|-----------------------------------|-----------------------|--|
| Wall construction type: Masonry | | | |
| Two leaves of 110 mm clay brick masonry with— <ul style="list-style-type: none"> (a) cavity not less than 50 mm between leaves; and (b) 50 mm thick glass wool insulation with a density of 11 kg/m³ or 50 mm thick polyester insulation with a density of 20 kg/m³ in the cavity. | 50 | 50 |  |
| Two leaves of 110 mm clay brick masonry with— <ul style="list-style-type: none"> (a) cavity not less than 50 mm between leaves and; (b) 13 mm cement render on each outside face. | 50 | 50 |  |

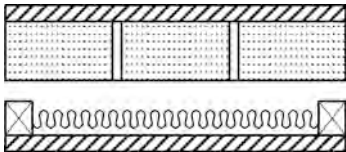
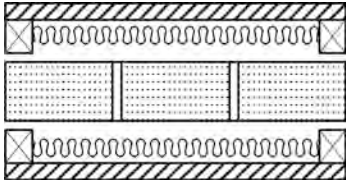
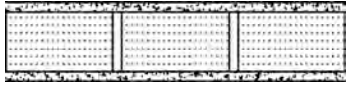
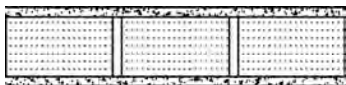



Deemed-to-Satisfy Provisions

Table 2 ACCEPTABLE FORMS OF CONSTRUCTION FOR WALLS— continued

| Description | $R_w + C_{tr}$ (not less than) | R_w (not less than) | Construction |
|---|-----------------------------------|-----------------------|--|
| Single leaf of 110 mm clay brick masonry with— (a) a row of 70 mm×35 mm timber studs or 64 mm steel studs at 600 mm centres, spaced 20 mm from the masonry wall; and (b) 50 mm thick mineral insulation or glass wool insulation with a density of 11 kg/m ³ positioned between studs; and (c) one layer of 13 mm plasterboard fixed to outside face of studs and outside face of masonry. | 50 | 50 |  |
| Single leaf of 90 mm clay brick masonry with— (a) a row of 70 mm×35 mm timber studs or 64 mm steel studs at 600 mm centres, spaced 20 mm from each face of the masonry wall; and (b) 50 mm thick mineral insulation or glass wool insulation with a density of 11 kg/m ³ positioned between studs in each row; and (c) one layer of 13 mm plasterboard fixed to studs on each outside face. | 50 | 50 |  |
| Single leaf of 150 mm brick masonry with 13 mm cement render on each face. | - | 50 |  |
| Single leaf of 220 mm brick masonry with 13 mm cement render on each face. | 50 | 50 |  |
| 110 mm thick brick masonry with 13 mm cement render on each face. | - | 45 |  |
| 110 mm thick concrete brickwork. | - | 45 |  |
| Wall construction type: Concrete | | | |
| 150 mm thick concrete panel. | 50 | 50 |  |

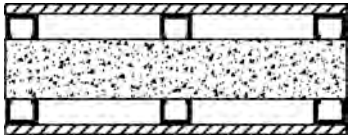
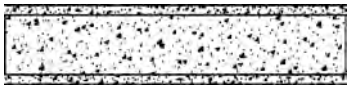
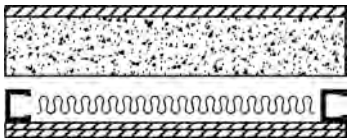
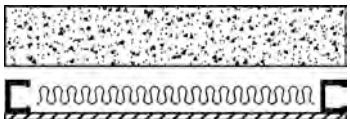

Deemed-to-Satisfy Provisions

Table 2 ACCEPTABLE FORMS OF CONSTRUCTION FOR WALLS— continued

| Description | $R_w + C_{tr}$ (not less than) | R_w (not less than) | Construction |
|--|-----------------------------------|-----------------------|--|
| 150 mm thick concrete panel with one layer of 10 mm plasterboard fixed to 28 mm metal furring channels on each face. | - | 50 |  |
| 200 mm thick concrete panel with one layer of 13 mm plasterboard or 13 mm cement render on each face. | 50 | 50 |  |
| 100 mm thick concrete panel with— (a) a row of 64 mm steel studs at 600 mm centres, spaced 25 mm from the concrete panel; and (b) 80 mm thick polyester insulation or 50 mm thick glass wool insulation with a density of 11 kg/m ³ , positioned between studs; and (c) two layers of 13 mm plasterboard fixed to outside face of studs and one layer of 13 mm plasterboard fixed to outside face of concrete panel. | 50 | 50 |  |
| 125 mm thick concrete panel with— (a) a row of 64 mm steel studs at 600 mm centres, spaced 20 mm from the concrete panel; and (b) 70 mm polyester insulation with a density of 9 kg/m ³ , positioned between studs; and (c) one layer of 13 mm plasterboard fixed to the outside face of the studs. | 50 | 50 |  |
| 125 mm thick concrete panel. | - | 50 |  |
| 100 mm concrete panel with 13 mm cement render or one layer of 13 mm plasterboard on each face. | - | 50 |  |
| 190 mm thick concrete blockwork. | - | 45 |  |
| 140 mm thick concrete blockwork, the face shell thickness of the blocks being not less than 44 mm and with— | | | |

Deemed-to-Satisfy Provisions

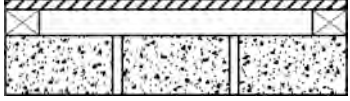
Table 2 ACCEPTABLE FORMS OF CONSTRUCTION FOR WALLS— continued

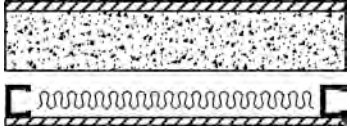
| Description | $R_w + C_{tr}$ (not less than) | R_w (not less than) | Construction |
|--|-----------------------------------|-----------------------|--|
| (a) 50 mm x 50 mm timber battens spaced at not more than 610 mm centres screw-fixed on one face of the blocks into resilient plugs with rubber inserts between battens and the wall; and (b) the face of the battens clad with 13 mm plasterboard. | - | 45 |  |
| Concrete panel - 100 mm thick. | - | 45 |  |
| <p>Note: For the purposes of this table the term "concrete panel" is a reference to a solid in-situ concrete panel or solid precast concrete panel.</p> | | | |
| <p>Wall construction type: Autoclaved aerated concrete</p> | | | |
| 75 mm thick autoclaved aerated concrete wall panel with— (a) a row of 64 mm steel studs at 600 mm centres, spaced 20 mm from the autoclaved aerated concrete wall panel; and (b) 75 mm thick glass wool insulation with a density of 11 kg/m ³ positioned between studs; and (c) one layer of 10 mm moisture resistant plasterboard or 13 mm fire protective grade plasterboard fixed to outside face of studs and outside face of autoclaved aerated concrete wall panel. | 50 | 50 |  |

Deemed-to-Satisfy Provisions

Table 2 ACCEPTABLE FORMS OF CONSTRUCTION FOR WALLS— continued

| Description | $R_w + C_{tr}$ (not less than) | R_w (not less than) | Construction |
|---|-----------------------------------|-----------------------|--------------|
| <p>75 mm thick autoclaved aerated concrete wall panel with—</p> <p>(a) a row of 64 mm steel studs at 600 mm centres, spaced 35 mm from the autoclaved aerated concrete panel wall; and</p> <p>(b) 28 mm metal furring channels fixed to the outside face of the autoclaved aerated concrete wall panel, with 50 mm thick polyester insulation with a density of 9 kg/m³ positioned between furring channels and one layer of 13 mm fire protective grade plasterboard fixed to furring channels; and</p> <p>(c) 105 mm thick glass wool insulation with a density of 7 kg/m³ positioned between studs; and</p> <p>(d) one layer of 13 mm fire protective grade plasterboard fixed to the outside face of the studs.</p> | 50 | 50 | |
| <p>Two leaves of 75 mm autoclaved aerated concrete wall panel with—</p> <p>(a) a cavity not less than 30 mm between panels containing 50 mm glass wool insulation with a density of 11 kg/m³; and</p> <p>(b) one layer of 10 mm plasterboard fixed to outside face of each panel.</p> | 50 | 50 | |
| <p>75 mm thick autoclaved aerated concrete wall panel with—</p> <p>(a) one layer of 10 mm moisture resistant plasterboard on one face; and</p> <p>(b) 28 mm metal furring channels and resilient mounts, 75 mm polyester insulation with a density of 9 kg/m³ and 13 mm fire-protective grade plasterboard fixed to the other face.</p> | - | 50 | |

Deemed-to-Satisfy Provisions

Table 2 ACCEPTABLE FORMS OF CONSTRUCTION FOR WALLS— continued

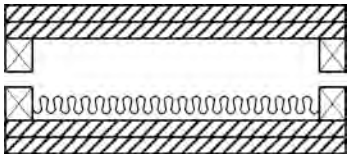
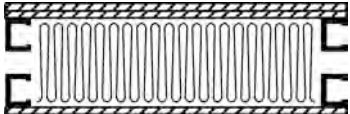
| Description | $R_w + C_{tr}$ (not less than) | R_w (not less than) | Construction |
|--|-----------------------------------|-----------------------|--|
| Wall construction type: Timber and steel framing | | | |
| <p>Two rows of 90x35 mm timber studs or two rows of 64 mm steel studs at 600 mm centres with—</p> <p>(a) an air gap not less than 20 mm between the rows of studs; and</p> <p>(b) 50 mm thick glass wool insulation or 60 mm thick polyester insulation with a density of 11 kg/m³; positioned between one row of studs; and</p> <p>(c) two layers of 13 mm fire-protective grade plasterboard or one layer of 6 mm fibre cement sheet and one layer of 13 mm fire-protective grade plasterboard, fixed to outside face of studs.</p> | 50 | 50 |  |
| <p>Two rows of 64 mm steel studs at 600 mm centres with—</p> <p>(a) an air gap not less than 80 mm between the rows of studs; and</p> <p>(b) 200 mm thick polyester insulation with a density of 14 kg/m³; positioned between studs; and</p> <p>(c) one layer of 13 mm fire-protective grade plasterboard and one layer 13 mm plasterboard on one outside face and one layer of 13 mm fire-protective grade plasterboard on the other outside face.</p> | 50 | 50 |  |

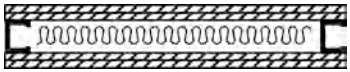
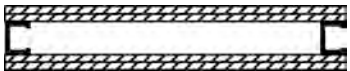
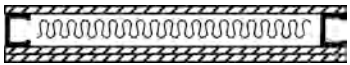
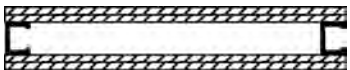

Deemed-to-Satisfy Provisions

Table 2 ACCEPTABLE FORMS OF CONSTRUCTION FOR WALLS— continued

| Description | $R_w + C_{tr}$ (not less than) | R_w (not less than) | Construction |
|---|-----------------------------------|-----------------------|--|
| <p>One row of 92 mm steel studs at 600 mm centres with—</p> <p>(a) 50 mm thick glass wool insulation with a density of 11 kg/m³ or 60 mm thick polyester insulation with a density of 8 kg/m³, positioned between studs; and</p> <p>(b) two layers of 13 mm fire-protective grade plasterboard or one layer of 6 mm fibre-cement sheet and one layer of 13 mm fire-protective grade plasterboard, fixed to each face.</p> | - | 50 |  |
| <p>One row of 64 mm steel studs with 2 layers of 16 mm fire-protective grade plasterboard fixed to each face.</p> | - | 45 |  |
| <p>One row of 64 mm steel studs with—</p> <p>(a) 1 layer of 16 mm fire-protective grade plasterboard fixed to one face; and</p> <p>(b) 50 mm thick mineral insulation or glass wool insulation with a density of 11 kg/m³ positioned between the studs; and</p> <p>(c) 2 layers of fire-protective grade plasterboard fixed to the other face, the inner layer being 16 mm thick and the outer layer being 13 mm.</p> | - | 45 |  |
| <p>One row of 64 mm steel studs with 2 layers of 13 mm plasterboard on each face.</p> | - | 45 |  |

Deemed-to-Satisfy Provisions

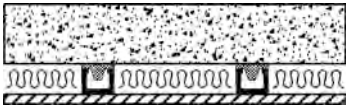
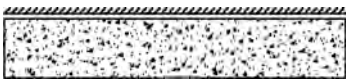
Table 3 ACCEPTABLE FORMS OF CONSTRUCTION FOR FLOORS

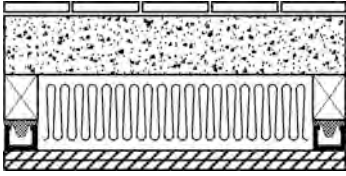
| Description | $R_w + C_{tr}$ (not less than) | $L_{n,w} + C_i$ (not more than) | R_w (not less than) | Construction |
|---|-----------------------------------|---------------------------------|--------------------------|--|
| Floor construction type: Concrete | | | | |
| 150 mm thick concrete slab with— (a) 28 mm metal furring channels and isolation mounts fixed to underside of slab, at 600 mm centres; and (b) 65 mm thick polyester insulation with a density of 8 kg/m ³ , positioned between furring channels; and (c) one layer of 13 mm plasterboard fixed to furring channels. | 50 | 62 | 50 |  |
| 200 mm thick concrete slab with carpet on underlay. | 50 | 62 | 50 |  |
| 100 mm thick concrete slab. | 45 | - | 45 |  |
| Floor construction type: Autoclaved aerated concrete | | | | |
| 75 mm thick autoclaved aerated concrete floor panel with— (a) 8 mm ceramic tiles with flexible adhesive and waterproof membrane, located above the slab; and (b) timber joists at 600 mm centres; and (c) R1.5 glass wool insulation positioned between timber joists; and (d) 28 mm metal furring channels and resilient mounts fixed to underside of joists; and (e) two layers of 13 mm plasterboard fixed to furring channels. | 50 | 62 | 50 |  |

Deemed-to-Satisfy Provisions

Table 3 ACCEPTABLE FORMS OF CONSTRUCTION FOR FLOORS— continued

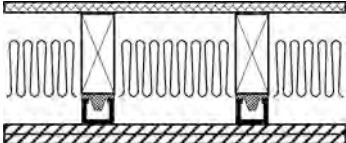
| Description | $R_w + C_{tr}$ (not less than) | $L_{n,w} + C_l$ (not more than) | R_w (not less than) | Construction |
|--|-----------------------------------|---------------------------------|--------------------------|--|
| Floor construction type: Timber | | | | |
| 19 mm thick chipboard floor sheeting with— (a) 190x45 mm timber joists at 450 mm centres; and (b) R2.5 glass wool insulation positioned between timber joists; and (c) 28 mm metal furring channels and isolation mounts fixed to underside of joists, isolation mounts to be of natural rubber with a dynamic factor of not more than 1.1 and static deflection of not less than 3 mm at actual operating load; and (d) two layers of 16 mm fire-protective grade plasterboard fixed to furring channels. | 50 | 62 | 50 |  |

Deemed-to-Satisfy Provisions

Table 3 ACCEPTABLE FORMS OF CONSTRUCTION FOR FLOORS— continued

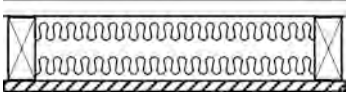
| Description | $R_w + C_{tr}$ (not less than) | $L_{n,w} + C_i$ (not more than) | R_w (not less than) | Construction |
|--|-----------------------------------|---------------------------------|--------------------------|--|
| <p>19 mm thick tongued and grooved boards with—</p> <p>(a) timber joists not less than 175 mm x 50 mm; and</p> <p>(b) 75 mm thick mineral insulation or glass wool insulation with a density of 11 kg/m³ positioned between joists and laid on 10 mm thick plasterboard fixed to underside of joists; and</p> <p>(c) 25 mm thick mineral insulation or glass wool insulation with a density of 11 kg/m³ laid over entire floor, including tops of joists before flooring is laid; and</p> <p>(d) secured to 75 mm x 50 mm battens; and</p> <p>(e) the assembled flooring laid over the joists, but not fixed to them, with the battens lying between the joists.</p> | 45 | - | 45 |  <p>The diagram shows a cross-section of a floor assembly. At the bottom is a concrete slab. Above it are two timber joists supported by a batten. The space between the joists is filled with insulation. A layer of plasterboard is fixed to the underside of the joists. The top surface of the joists is also covered with insulation. The entire assembly is topped with a layer of flooring.</p> |

SPECIFICATION **F5.5** IMPACT SOUND — TEST OF
EQUIVALENCE

Deemed-to-Satisfy Provisions

1. Scope

This Specification describes a method of test to determine the comparative resistance of walls to the transmission of impact sound.

2. Construction to be tested

- (a) The test is conducted on a specimen of prototype wall construction and on a specimen of one or other of the constructions specified in **Table 2 of Specification F5.2**.
- (b) The testing of a construction specified in **Table 2 of Specification F5.2** need not be repeated for subsequent comparisons provided complete records of the results, the test equipment and the technique of testing are kept so that identical equipment can be employed and an identical technique can be adopted in the testing of specimens of prototype wall construction.

3. Method

- (a) The wall constructions to be compared must be tested in accordance with AS 1191.
- (b) A horizontal steel platform 510 mm x 460 mm x 10 mm thick must be placed with one long edge in continuous and direct contact with the wall to be tested on the side of the wall on which the impact sound is to be generated.
- (c) A tapping machine complying with ISO 140/6 — 1998 (E) must be mounted centrally on the steel platform.
- (d) The sound transmission through the wall must be determined in accordance with AS 1191 except that the tapping machine as mounted on the steel platform must be used as the source of sound.
- (e) The impact sound pressure levels measured in the receiving room must be converted into normalised levels using a reference equivalent absorption area of 10 m².

ANCILLARY PROVISIONS

- G1** **Minor Structures and Components**

- G2** **Heating Appliances, Fireplaces, Chimneys and Flues**

- G3** **Atrium Construction**

- G4** **Construction in Alpine Areas**

- G5** **Construction in Bushfire Prone Areas**

SECTION G CONTENTS

SECTION G ANCILLARY PROVISIONS

Part G1 Minor Structures and Components

- Objective GO1
- Functional Statements GF1.1 - GF1.4
- Performance Requirements GP1.1 - GP1.5
- G1.0 Deemed-to-Satisfy Provisions
- G1.1 Swimming pools
- G1.2 Refrigerated chambers, strong-rooms and vaults
- G1.3 Outdoor playspaces

Part G2 Heating Appliances, Fireplaces, Chimneys and Flues

- Objective GO2
- Functional Statements GF2.1 - GF2.2
- Performance Requirements GP2.1 - GP2.2
- G2.0 Deemed-to-Satisfy Provisions
- G2.1 * * * * *
- G2.2 Installation of appliances
- G2.3 Open fireplaces
- G2.4 Incinerator rooms

Part G3 Atrium Construction

- G3.1 Atriums affected by this Part
- G3.2 Dimensions of atrium well
- G3.3 Separation of atrium by bounding walls
- G3.4 Construction of bounding walls
- G3.5 Construction at balconies
- G3.6 Separation at roof
- G3.7 Means of egress
- G3.8 Fire and smoke control systems
- Specification G3.8 Fire and Smoke Control Systems in Buildings Containing Atriums

Part G4 Construction in Alpine Areas

- Objective GO4
- Functional Statement GF4.1
- Performance Requirements GP4.1 - GP4.4
- G4.0 Deemed-to-Satisfy Provisions
- G4.1 Application of Part
- G4.2 * * * * *
- G4.3 External doorways
- G4.4 Emergency lighting
- G4.5 External ramps
- G4.6 Discharge of exits

G4.7 External trafficable structures
G4.8 Fire-fighting services and equipment
G4.9 Fire orders

Part G5 Construction in Bushfire Prone Areas

Objective GO5
Functional Statement GF5.1
Performance Requirement GP5.1
G5.0 Deemed-to-Satisfy Provisions
G5.1 Application of Part
G5.2 Protection

PART G1

MINOR STRUCTURES AND COMPONENTS

OBJECTIVE

GO1

The *Objective* of this Part is to—

NT GO1(a)

- (a) safeguard people from illness caused by the discharge of *swimming pool* waste water; and

NT GO1(b)

- (b) protect *other property* from damage caused by the discharge of *swimming pool* waste water; and

ACT GO1(c)

NSW GO1(c)

NT GO1(c)

Qld GO1(c)

SA GO1(c)

Tas GO1(c)

Vic GO1(c)

WA GO1(c)

- (c) safeguard young children from drowning or injury in a *swimming pool*; and
- (d) safeguard people from drowning or injury due to suction by a *swimming pool* water recirculation system; and

Application

GO1(d) only applies to a *swimming pool* with a depth of water more than 300 mm.

- (e) safeguard occupants from illness or injury resulting from being accidentally locked inside spaces which are designed to be entered for short periods of time only and in which occupation for longer periods may be hazardous; and
- (f) safeguard young children in outdoor play spaces.

Application

GO1(f) only applies to a Class 9b *early childhood centre*.

Tas GO1(g), (h), (i)

| |
|------------------------------|
| FUNCTIONAL STATEMENTS |
|------------------------------|

GF1.1

NT GF1.1

Adequate means for the disposal of *swimming pool* water and drainage is to be provided to a *swimming pool*.

GF1.2

ACT GF1.2(a)

NSW GF1.2(a)

NT GF1.2(a)

Qld GF1.2(a)

SA GF1.2(a)

Tas GF1.2(a)

Vic GF1.2(a)

WA GF1.2(a)

A *swimming pool* is to be provided with—

- (a) means of restricting access by young children to it; and
- (b) means to reduce the possibility of a person being entrapped or injured due to suction by a water recirculation system.

Application

GF1.2(b) only applies to a *swimming pool* with a depth of water more than 300 mm.

GF1.3

Any refrigerated or cooling chamber, strong-room and vault or the like that is capable of accommodating a person is to have safety measures to facilitate escape and for alerting people outside such a space in the event of an emergency.

GF1.4

An outdoor play space is to be provided with a means of restricting the passage of children to outside of the play space.

Application

GF1.4 only applies to a Class 9b *early childhood centre*.

TAS GF1.5–1.7

| |
|---------------------------------|
| PERFORMANCE REQUIREMENTS |
|---------------------------------|

GP1.1

NT GP1.1

A *swimming pool* must have adequate means of draining the pool in a manner which will not—

- (a) cause illness to people; or
- (b) affect *other property*.

GP1.2

ACT GP1.2(a)

NSW GP1.2(a)

NT GP1.2(a)

Qld GP1.2(a)

SA GP1.2(a)

Tas GP1.2(a)

Vic GP1.2(a)

WA GP1.2(a)

- (a) A barrier must be provided to a *swimming pool* and must—
 - (i) be continuous for the full extent of the hazard; and
 - (ii) be of a strength and rigidity to withstand the foreseeable impact of people; and
 - (iii) restrict the access of young children to the pool and the immediate pool surrounds; and
 - (iv) have any gates and doors fitted with latching devices not readily operated by young children, and constructed to automatically close and latch.
- (b) A *swimming pool* water recirculation system must incorporate safety measures to avoid entrapment of, or injury to, a person.

Application

GP1.2(b) only applies to a *swimming pool* with a depth of water more than 300 mm.

GP1.3

Any refrigerated or cooling chamber, or the like which is of sufficient size for a person to enter must—

- (a) have adequate means of communicating with or alerting other occupants in the building in the case of an emergency; and
- (b) have a door which is—
 - (i) of adequate dimensions to allow occupants to readily escape; and
 - (ii) openable from inside without a key at all times.

GP1.4

Any strong-room, vault or the like which is of sufficient size for a person to enter must—

- (a) have adequate means of communicating with or alerting other occupants in the building in the case of an emergency; and
- (b) have internal lighting controllable only from within the room; and
- (c) have an external indicator that the room is occupied.

GP1.5

Fencing or other barriers must be provided around any outdoor play space, in which the design and height of the fencing or other barriers, including the—

- (a) design of gates and fittings; and
- (b) proximity of the barriers to any permanent structure on the property,

must ensure that children cannot go through, over or under the fencing or other barriers.

Application

GP1.5 only applies to a Class 9b *early childhood centre*.

Tas GP1.6–1.10

PART G1

MINOR STRUCTURES AND COMPONENTS

Deemed-to-Satisfy Provisions

G1.0 Deemed-to-Satisfy Provisions

- (a) *Performance Requirement GP1.1* must be complied with.

There is no *Deemed-to-Satisfy Provision* for this *Performance Requirement*.

Tas G1.0(b)

- (b) Where a *Building Solution* is proposed to comply with the *Deemed-to-Satisfy Provisions*, *Performance Requirements GP1.2 to GP1.5* are satisfied by complying with **G1.1 to G1.3**.
- (c) Where a *Building Solution* is proposed as an *Alternative Solution* to the *Deemed-to-Satisfy Provisions* of **G1.1 to G1.3**, the relevant *Performance Requirements* must be determined in accordance with **A0.10**.

G1.1 Swimming pools

NSW G1.1(a)

NT G1.1(a)

Qld G1.1(a)

Vic G1.1(a)

WA G1.1(a)

- (a) * * * * *

WA G1.1(b)

- (b) A *swimming pool* associated with a Class 2 or 3 building or Class 4 part of a building, with a depth of water more than 300 mm must have suitable barriers to restrict access by young children to the immediate pool surrounds in accordance with AS 1926 Parts 1 and 2.
- (c) A water recirculation system in a *swimming pool* with a depth of water more than 300 mm must comply with AS 1926.3.

ACT G1.1(d)–(e)

Tas G1.1(d)–(h)

G1.2 Refrigerated chambers, strong-rooms and vaults

- (a) A refrigerated or cooling chamber, strongroom or vault which is of sufficient size for a person to enter must have—
- (i) a door which is capable of being opened by hand from inside without a key; and
 - (ii) internal lighting controlled only by a switch which is located adjacent to the entrance doorway inside the chamber, strongroom or vault; and
 - (iii) an indicator lamp positioned outside the chamber, strongroom or vault which is illuminated when the interior lights *required* by **(a)(ii)** are switched on; and

Deemed-to-Satisfy Provisions

- (iv) an alarm that is—
 - (A) located outside but controllable only from within the chamber, strongroom or vault; and
 - (B) able to achieve a sound pressure level outside the chamber, strongroom or vault of 90 dB(A) when measured 3 m from the sounding device.
- (b) A door *required* by (a)(i) in a refrigerated or cooling chamber must have a doorway with a clear width of not less than 600 mm and a clear height not less than 1.5 m.

G1.3 Outdoor play spaces

- (a) Any outdoor play space in a Class 9b *early childhood centre* must be enclosed on all sides with a barrier which complies with AS 1926.1.
- (b) For the purposes of (a), AS 1926.1 is applied as if there is a *swimming pool* located outside the outdoor play space, so that the barrier restricts children from exiting the premises without the knowledge of staff in the centre.
- (c) The requirements of (a) do not apply to a wall, including doors and *windows*, which form part of the Class 9b *early childhood centre*.

NSW G1.101

Qld G101

Tas G101.1, G101.2

PART G2

HEATING APPLIANCES, FIREPLACES, CHIMNEYS AND FLUES

OBJECTIVE

GO2

The *Objective* of this Part is to—

- (a) safeguard occupants from illness or injury caused by—
 - (i) fire from combustion appliances installed within a building; and
 - (ii) malfunction of a pressure vessel installed within a building; and
- (b) protect a building from damage caused by the malfunction of a pressure vessel installed within.

Tas GO2(a)

FUNCTIONAL STATEMENTS

GF2.1

Combustion appliances using controlled combustion located in a building are to be installed in a way which reduces the likelihood of fire spreading beyond the appliance.

Tas GF2.1

GF2.2

Pressure vessels located in a building are to be installed in a manner which will provide adequate safety for occupants.

PERFORMANCE REQUIREMENTS

GP2.1

Where provided in a building, a combustion appliance and its associated components, including an open fire-place, chimney, flue, chute, hopper or the like, must be installed—

- (a) to withstand the temperatures likely to be generated by the appliance; and
- (b) so that it does not raise the temperature of any building element to a level that would adversely affect the element's physical or mechanical properties or function; and

- (c) so that hot products of combustion will not—
 - (i) escape through the walls of the associated components; and
 - (ii) discharge in a position that will cause fire to spread to nearby *combustible* materials or allow smoke to penetrate through nearby *windows*, ventilation inlets, or the like.

Tas GP2.1(c)

GP2.2

When located in a building, a pressure vessel must be installed to avoid, during reasonably foreseeable conditions, the likelihood of—

- (a) leakage from the vessel which could cause damage to the building; and
- (b) rupture or other mechanical damage of the vessel which could cause damage to the building or injury to occupants.

PART G2

HEATING APPLIANCES, FIREPLACES, CHIMNEYS AND FLUES

Deemed-to-Satisfy Provisions

G2.0 Deemed-to-Satisfy Provisions

- (a) Where a *Building Solution* is proposed to comply with the *Deemed-to-Satisfy Provisions*, *Performance Requirements GP2.1* and *GP2.2* are satisfied by complying with **G2.1** to **G2.4**.
- (b) Where a *Building Solution* is proposed as an *Alternative Solution* to the *Deemed-to-Satisfy Provisions* of **G2.1** to **G2.4**, the relevant *Performance Requirements* must be determined in accordance with **A0.10**.

G2.1 * * * * *

This clause has deliberately been left blank.

G2.2 Installation of appliances

The installation of a stove, heater or similar appliance in a building must comply with:

- (a) * * * * *
- (b) Domestic solid-fuel burning appliances — Installation: AS/NZS 2918.

Tas G2.2(b)

- (c) Pressure equipment: AS/NZS 1200.

ACT G2.2(d), (e)

G2.3 Open fireplaces

An open fireplace, or solid-fuel burning appliance in which the fuel-burning compartment is not enclosed must have—

- (a) a hearth constructed of stone, concrete, masonry or similar *non-combustible* material so that—
 - (i) it extends not less than 300 mm beyond the front of the fireplace opening and not less than 150 mm beyond each side of that opening; and
 - (ii) it extends beyond the limits of the fireplace or appliance not less than 300 mm if the fireplace or appliance is free-standing from any wall of the room; and
 - (iii) its upper surface does not slope away from the grate or appliance; and
 - (iv) *combustible* material situated below the hearth but not below that part *required* to extend beyond the fireplace opening or the limits of the fireplace is not less than 150 mm from the upper surface of the hearth; and
- (b) walls forming the sides and back of the fireplace up to not less than 300 mm above the underside of the arch or lintel which—

Deemed-to-Satisfy Provisions

- (i) are constructed in 2 separate leaves of solid masonry not less than 180 mm thick, excluding any cavity; and
- (ii) do not consist of concrete block masonry in the construction of the inner leaf; and
- (c) walls of the chimney above the level referred to in (b)—
 - (i) constructed of masonry units with a net volume, excluding cored and similar holes, not less than 75% of their gross volume, measured on the overall rectangular shape of the units, and with an actual thickness of not less than 100 mm; and
 - (ii) lined internally to a thickness of not less than 12 mm with rendering consisting of 1 part cement, 3 parts lime, and 10 parts sand by volume, or other suitable material; and
- (d) suitable damp-proof courses or flashings to maintain weatherproofing.

G2.4 Incinerator rooms

- (a) If an incinerator is installed in a building any hopper giving access to a charging chute must be—
 - (i) *non-combustible*; and
 - (ii) gas-tight when closed; and
 - (iii) designed to return to the closed position after use; and
 - (iv) not attached to a chute that connects directly to a flue unless the hopper is located in the open air; and
 - (v) not located in a *required exit*.
- (b) A room containing an incinerator must be separated from other parts of the building by construction with an FRL of not less than 60/60/60.

PART G3

ATRIUM CONSTRUCTION

Deemed-to-Satisfy Provisions

Note:

Part G3 contains *Deemed-to-Satisfy Provisions* additional to those contained in **Sections C, D and E** for *Atrium* Construction.

G3.1 Atriums affected by this Part

This Part does not apply to an *atrium* which—

- (a) connects only 2 *storeys*; or
- (b) connects only 3 *storeys* if—
 - (i) each *storey* is provided with a sprinkler system complying with **Specification E1.5** throughout; and
 - (ii) one of those *storeys* is situated at a level at which there is direct egress to a road or *open space*.

G3.2 Dimensions of atrium well

An *atrium well* must have a width throughout the well that is able to contain a cylinder having a horizontal diameter of not less than 6 m.

G3.3 Separation of atrium by bounding walls

An *atrium* must be separated from the remainder of the building at each *storey* by bounding walls set back not more than 3.5 m from the perimeter of the *atrium well* except in the case of the walls at no more than 3 consecutive *storeys* if—

- (a) one of those *storeys* is at a level at which direct egress to a road or *open space* is provided; and
- (b) the sum of the *floor areas* of those *storeys* that are contained within the *atrium* is not more than the maximum area that is permitted in **Table C2.2**.

G3.4 Construction of bounding walls

Bounding walls must—

- (a) have an FRL of not less than 60/60/60, and—
 - (i) extend from the floor of the *storey* to the underside of the floor next above or to the underside of the roof; and
 - (ii) have any door openings protected with *self-closing* or *automatic* –/60/30 fire doors; or
- (b) be constructed of fixed toughened safety glass, or wired safety glass in *non-combustible* frames, with—
 - (i) any door openings fitted with a *self-closing* smoke door complying with **Specification C3.4**; and

Deemed-to-Satisfy Provisions

- (ii) the walls and doors protected with wall-wetting systems in accordance with **Specification G3.8**; and
- (iii) a fire barrier with an FRL of not less than $-/60/30$ installed in any ceiling spaces above the wall.

G3.5 Construction at balconies

If a bounding wall separating an *atrium* from the remainder of the building is set back from the perimeter of the *atrium well*, a balustrade or other barrier that is imperforate and *non-combustible*, and not less than 1 m high must be provided.

G3.6 Separation at roof

In an *atrium*—

- (a) the roof must have the FRL prescribed in **Table 3 of Specification C1.1**; or
- (b) the roof structure and membrane must be protected by a sprinkler system complying with **Specification E1.5**.

G3.7 Means of egress

All areas within an *atrium* must have access to at least 2 *exits*.

G3.8 Fire and smoke control systems

Sprinkler systems, smoke control, fire detection and alarm systems, and sound systems and intercom system for emergency purposes must be installed in compliance with **Specification G3.8**.

SPECIFICATION **G3.8** FIRE AND SMOKE CONTROL SYSTEMS IN BUILDINGS CONTAINING ATRIUMS

Deemed-to-Satisfy Provisions

1. SCOPE

This Specification sets out the requirements for the design and operation of systems of fire and smoke control in buildings containing an *atrium*.

2. AUTOMATIC FIRE SPRINKLER SYSTEM

2.1 General requirement

A sprinkler system complying with **Specification E1.5** must be installed in every building containing an *atrium*, except where varied or superseded by this Specification.

2.2 Roof protection

A roof of an *atrium* which does not have the FRL prescribed in **Specification C1.1** or the *Deemed-to-Satisfy Provisions* of **Part C2** must be protected by *automatic* sprinklers arranged to wet both the covering membrane and supporting structure if the roof is—

- (a) less than 12 m above the floor of the *atrium* or the floor of the highest *storey* where the bounding construction is set back more than 3.5 m from the *atrium well* if a Class 2, 3, 5 or 9 part of a building is open to the *atrium*; or
- (b) less than 20 m above the floor of the *atrium* or the floor of the highest *storey* where the bounding construction is set back more than 3.5 m from the *atrium well* if a Class 6, 7 or 8 part of a building is open to the *atrium*,

and the temperature rating of sprinkler heads providing roof protection must be within the range 79°C–100°C.

2.3 Atrium floor protection

The floor of the *atrium* must be protected by sprinklers with—

- (a) the use of sidewall pattern sprinkler heads together with overhead sprinklers where dictated by the dimensions of the *atrium*; and
- (b) sprinkler heads of the fast response type, installed with suitable *non-combustible* heat collector plates of 200 mm minimum diameter to ensure activation by a rising fire plume.

2.4 Sprinkler systems to glazed walls

2.4.1 Location of protection

Where an *atrium* is separated from the remainder of the building by walls or doors incorporating glazing, a wall wetting system with suitable *non-combustible* heat collector plates of 200 mm diameter must be provided to protect the glazing as follows:

Deemed-to-Satisfy Provisions

- (a) On the *atrium* side of the glazing — to all glazed walls which are set back more than 3.5 m from the *atrium well*.
- (b) On the *atrium* side of the glazing — to all glazed walls which are not set back, or are set back 3.5 m or less, from the *atrium well*, for all levels which are less than—
 - (i) 12 m above the floor of an *atrium* or the floor of the highest *storey* where the bounding wall is set back more than 3.5 m from the *atrium well* if a Class 2, 3, 5 or 9 part of the building is open to the *atrium*; or
 - (ii) 20 m above the floor of an *atrium* or the floor of the highest *storey* where the bounding wall is set back more than 3.5 m from the *atrium well* if a Class 6, 7 or 8 part of the building is open to the *atrium*.
- (c) On the side of the glazing away from the *atrium well*—to all glazing forming part of the bounding wall at each *storey*.

2.4.2 Sprinkler head location

Sprinklers must be located in positions allowing full wetting of the glazing surfaces without wetting adjacent sprinkler heads.

2.4.3 Head rating and response time

Sprinkler heads must be of the fast response type and have a maximum temperature rating of 74°C.

2.4.4 Water discharge rate

The rate of water discharge to protect glazing must be not less than—

- (a) on the *atrium* side of the glazing—
 - (i) 0.25 L/s.m² where glazing is not set back from the *atrium well*; or
 - (ii) 0.167 L/s.m² where glazing is set back from the *atrium well*; and
- (b) on the side away from the *atrium well*—0.167 L/s.m².

2.4.5 Water supply

In addition to that of the basic sprinkler protection for the building, the water supply to *required* wall wetting systems must be of adequate capacity to accommodate the following on the *atrium* side of the glazing:

- (a) Where the bounding walls are set back less than 3.5 m from the *atrium well*—wall wetting of a part not less than 6 m long for a height of not less than—
 - (i) 12 m above the floor of an *atrium* or the floor of the highest *storey* where the bounding wall is set back more than 3.5 m from the *atrium well* if a Class 2, 3, 5 or 9 part of the building is open to the *atrium*; or
 - (ii) 20 m above the floor of an *atrium* or the floor of the highest *storey* where the bounding wall is set back more than 3.5 m from the *atrium well* if a Class 6, 7 or 8 part of the building is open to the *atrium*; and
- (b) Where the walls are set back 3.5 m or more from the *atrium well* — wetting of a part not less than 12 m long on one *storey*.

Deemed-to-Satisfy Provisions

2.5 Stop valves

- (a) Basic sprinkler and wall wetting systems protecting a building containing an *atrium* must be provided with easily accessible and identified stop valves.
- (b) Sprinkler and wall wetting systems must be provided with independent stop valves.
- (c) Sprinkler heads protecting the roof of the *atrium* must be provided with a stop valve.
- (d) Stop valve to wall wetting and roof sprinklers may be of the gate type.
- (e) All sprinkler and wall wetting stop valves must be monitored to detect unauthorised closure.

3. SMOKE CONTROL SYSTEM

3.1 General requirements

Except where varied or superseded by this Specification, mechanical air-handling systems in a building containing an *atrium* must comply with AS/NZS 1668.1.

3.2 Operation of atrium mechanical air-handling systems

Mechanical air-handling systems serving an *atrium* must be designed to operate so that during a fire—

- (a) a tenable atmosphere is maintained in all paths of travel along balconies to *required exits* during the period of evacuation; and
- (b) smoke exhaust fans serving the *atrium* are only activated when smoke enters the *atrium*; and
- (c) central plant systems do not use the *atrium* as a return air path; and
- (d) central plant systems which use return air paths remote from the *atrium*—
 - (i) cycle to the full outside air mode; and
 - (ii) stop supply air to the fire affected *storey* or *fire compartment*; and
 - (iii) continue to fully exhaust the fire affected *storey* or *fire compartment* and reduce the exhaust from other *storeys* or *fire compartments* by at least 75%; and
 - (iv) continue to supply air to *fire compartments* or *storeys* other than the fire affected *storey* or *fire compartment*; and
- (e) fans performing relief or exhaust duty from the *atrium* stop normal operation; and
- (f) floor by floor, or unitary, air-handling plant serving a single *fire compartment* or *storey*—
 - (i) ceases normal operation in the fire affected *storey* or *fire compartment*; and
 - (ii) commences full relief or exhaust from that fire affected *storey* or *fire compartment*; and
 - (iii) continue to supply air to *fire compartments* or *storeys* other than the fire affected *storey* or *fire compartment*.

3.3 Activation of smoke control system

- (a) The smoke control system must be activated by—

Deemed-to-Satisfy Provisions

- (i) operation of an *automatic* fire alarm; or
 - (ii) operation of the sprinkler system; or
 - (iii) a manual start switch.
- (b) All controls for the smoke control system must be located—
- (i) in the fire control room; or
 - (ii) in the emergency control centre, (if any); or
 - (iii) adjacent to the sprinkler control valves; or
 - (iv) incorporated in the Fire Indicator Panel.

3.4 Smoke exhaust system

A smoke exhaust system serving an *atrium* must be designed on the basis of—

- (a) the sprinkler system limiting the size of a fire to—
- (i) a heat output of 1.5 MW and perimeter of 7.5 m if a Class 2, 3, 5 or 9 part of the building is open to the *atrium*; or
 - (ii) a heat output of 5 MW and perimeter of 12 m if a Class 6, 7 or 8 part of the building is open to the *atrium*; and
- (b) a smoke plume reaching a level 3 m above the highest *storey* having a path of travel to a *required exit* along a balcony bounding the *atrium well*, and not less than—
- (i) 12 m above the floor of an *atrium* or the floor of the highest *storey* where the bounding wall is set back more than 3.5 m from the *atrium well* if a Class 2, 3, 5 or 9 part of the building is open to the *atrium*; or
 - (ii) 20 m above the floor of an *atrium* or the floor of the highest *storey* where the bounding construction is set back more than 3.5 m from the *atrium well* if a Class 6, 7 or 8 part of the building is open to the *atrium*; and
- (c) the smoke exhaust system discharging smoke at a rate of not less than that shown in **Figure 3.4** for the appropriate height of smoke plume and fire size—
- (i) from the top of the *atrium*; or
 - (ii) horizontally where calculations of wind velocity induced pressure profiles for the building verify that the exhaust system will operate effectively for all wind directions.

Deemed-to-Satisfy Provisions

Figure 3.4

SMOKE EXHAUST RATE

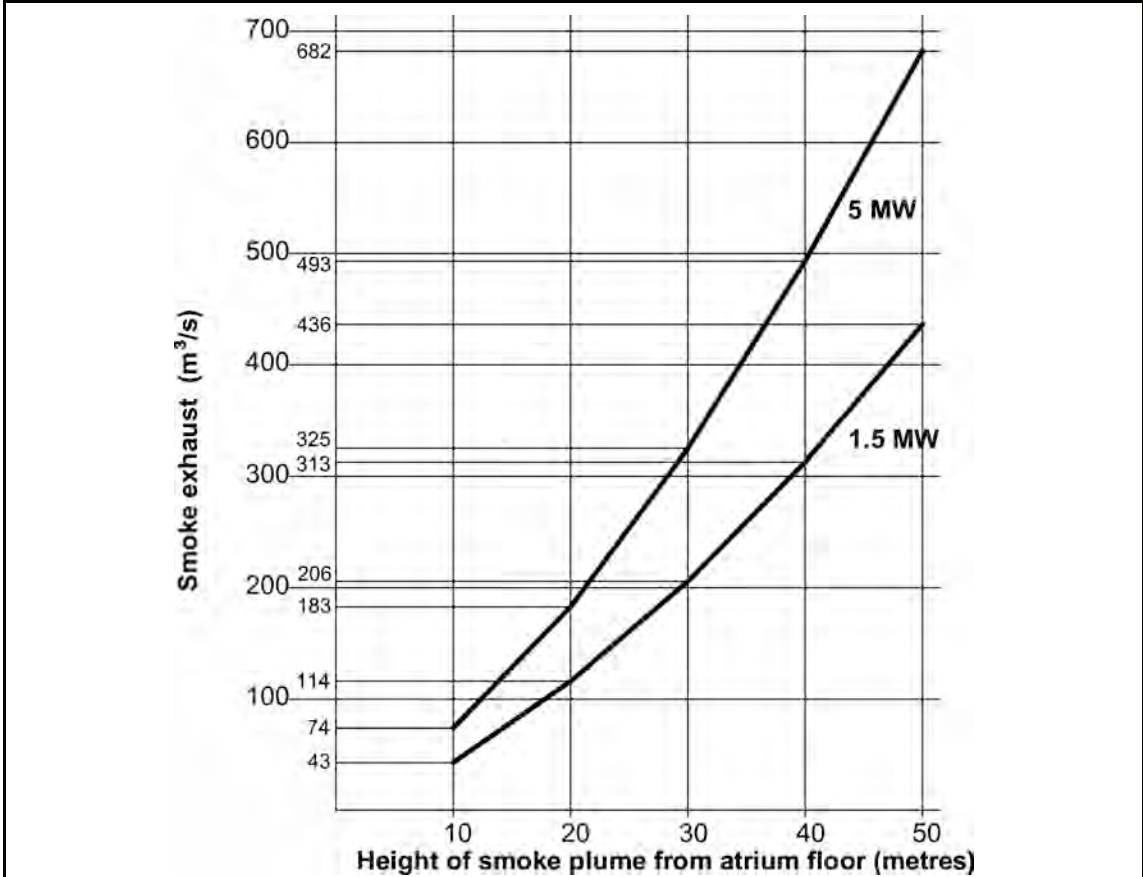

3.5 Upward air velocity

Notwithstanding 3.4(c), the average upward air velocity in the atrium, due to the required smoke exhaust quantity must—

- (a) be not less than 0.2 m/s at any level over an 18 m height above the floor of the atrium; and
- (b) not exceed the following maximum velocities in atriums of constant cross sectional plan area—
 - (i) for occupancy classification qualifying for 1.5 MW fire size — 3.5 m/s.
 - (ii) for occupancy classifications qualifying for 5 MW fire size — 5 m/s.

3.6 Exhaust fans

- (a) Smoke exhaust must be provided by fans capable of continuous and required operation for a period of not less than 1 hour when handling exhaust gases at 200°C.

Deemed-to-Satisfy Provisions

- (b) Where a Class 2, 3 or 9 part of a building adjoins an *atrium*, the *atrium* must be provided with a minimum of 3 fans each capable of 50% of the total *required* smoke exhaust capacity.
- (c) *Atriums* other than those referred to in (b) must be provided with a minimum of 2 fans each capable of 50% of the total *required* smoke exhaust capacity.

3.7 Smoke and heat vents

Notwithstanding **Clause 3.6**, *automatic* vents complying with AS 2665 may be used, except where a Class 6 part of a building adjoins the *atrium*, in lieu of exhaust fans provided that—

- (a) the height from the *atrium* floor to the bottom of the highest vent is not more than 12 m; and
- (b) the vents are fitted with a remote manual operation switch located adjacent to the sprinkler control valves or incorporated in the Fire Indicator Panel.

3.8 Make-up air supply

- (a) Uniformly distributed make-up air must be provided to the *atrium* exhaust system from—
 - (i) outside the *atrium* at or near the lowest *storey* level; and
 - (ii) relief air from non-fire *storeys*.
- (b) A discharge volume sufficient to maintain a velocity of not less than 0.1 m/s towards the *atrium well* must be provided on all *storeys* where the bounding wall is set back from the *atrium well*.
- (c) The requirements of (a)(i) are satisfied if make-up air is provided to the *atrium* exhaust system in such a manner as to prevent, as far as possible, disturbance of the smoke layer due to turbulence created by the incoming air, through—
 - (i) openings directly from the outside air to the *atrium* and located as close as practicable to the lowest level of the *atrium*; or
 - (ii) ducts from the outside air to the *atrium* which deliver air as close as practicable to the lowest level of the *atrium* and, where passing through any other *fire compartment* having an FRL of at least 60/60/60; or
 - (iii) a combination of (i) or (ii).

4. FIRE DETECTION AND ALARM SYSTEM

4.1 General requirements

Except where superseded by this Specification, *automatic* fire detection and alarm systems in a building containing an *atrium* must comply with AS 1670.1.

4.2 Smoke detection system

Smoke detection within an *atrium*—

- (a) must be provided within all outside air intakes and at individual floor return air intakes of all air-handling systems to initiate *automatic* fire mode operation, and where applicable, comply with the restart facilities in AS/NZS 1668.1; and

Deemed-to-Satisfy Provisions

- (b) must operate at an obscuration level not greater than 0.5% per metre with compensation for external airborne contamination as necessary; and
- (c) must sample air within the *atrium* and in *storeys* where the bounding wall is set back more than 3.5 m from the *atrium well*; and
- (d) must be calibrated to compensate for smoke dilution where sampling occurs within return air path common to more than one room; and
- (e) may incorporate beam type detectors to sense smoke in an *atrium* in a Class 5, 6, 7 or 8 building with an *effective height* of not more than 25 m if—
 - (i) the beam detectors are located at intervals of not more than 3 *storeys*; and
 - (ii) arranged to scan at 90 degrees orientation to adjacent beam units.

4.3 Smoke detection in spaces separated from the atrium by bounding walls

Smoke detection systems must be located at all return and relief air openings associated with the building air-handling systems and be—

- (a) of the sampling type system as *required* in 4.2; or
- (b) of the point type photoelectric smoke detector.

4.4 Alarm systems

- (a) A break-glass fire alarm point must be provided at each door to a *fire-isolated stairway*, *fire-isolated ramp*, or *fire-isolated passageway*.
- (b) A staged alarm must be provided where an air sampling type smoke detection system is provided for the *atrium*, and must operate as follows:
 - (i) Alert building management when abnormal smoke levels of 0.03% obscuration per metre are detected.
 - (ii) Initiate a second alarm to management and start all smoke control systems including pressurisation of escape routes when smoke levels of 0.07% obscuration per metre are detected.
 - (iii) Automatically call the *fire brigade*, activate the sound system and intercom system for emergency purposes, and de-activate all plant not necessary for fire safety within the building when smoke levels of 0.09% obscuration per metre are detected.
- (c) Beam and point type smoke detectors *required* must simultaneously operate all functions referred to above and activate at the level set out in AS/NZS 1668.1.

5. SOUND SYSTEMS AND INTERCOM SYSTEMS FOR EMERGENCY PURPOSES

All buildings containing an *atrium* must be provided with a sound system and intercom system for emergency purposes which—

- (a) complies with AS 1670.4; and
- (b) incorporates visual warning devices that—
 - (i) operate upon the evacuation signal; and

Deemed-to-Satisfy Provisions

- (ii) display the words “EVACUATE” in red with letters conforming with the requirements of the *Deemed-to-Satisfy Provisions* of **Part E4** for *exit* signs.

6. STANDBY POWER SYSTEM

- (a) If a *required* path of travel to an *exit* is within an *atrium*, a suitable alternative power supply must be provided to operate *required* safety systems, including sprinkler systems and fire hydrant pumps, air handling systems, alarms, warning and communication systems and emergency lighting circuits.
- (b) The alternative power supply must—
 - (i) be connected *automatically* if the normal power supply fails; and
 - (ii) if located within the building, be separated from the remainder of the building by an enclosure with an FRL of at least 120/120/120; and
 - (iii) be connected to the safety systems by means of cabling complying with **C2.13(c)(iii)** and **(iv)**.
- (c) The requirements of **(a)** are satisfied by—
 - (i) a single medium voltage supply taken from an electricity substation situated within, or adjacent to, the building concerned where the power supply to the substation consists of two or more high voltage cables each taking electricity from separate transformers; or
 - (ii) two or more medium voltage supplies each taking electricity from separate electricity substations situated—
 - (A) outside the building concerned; and
 - (B) at a suitable distance from each other; or
 - (iii) a single medium voltage supply taken from an electricity substation together with an electricity generating plant capable of—
 - (A) generating a medium voltage supply; and
 - (B) starting and taking the *required* electrical load within a period of not more than 30 seconds from the time of normal supply failure.

7. SYSTEM FOR EXCLUDING SMOKE FROM FIRE-ISOLATED EXITS

Required fire-isolated *exits* in a building containing an *atrium* must be protected from the entry of smoke in accordance with **E2.2**.

PART G4 CONSTRUCTION IN ALPINE AREAS

OBJECTIVE

GO4

The *Objective* of this Part is to safeguard occupants in *alpine areas* from illness or injury from an emergency while evacuating a building.

Application

GO4 applies to a building constructed in an *alpine area* and overrules other provisions of the BCA.

FUNCTIONAL STATEMENT

GF4.1

A building in an *alpine area* is to be provided with additional measures in view of the increased difficulties in fire-fighting and maintaining access and means of egress in snow conditions.

Application

GF4.1 applies to a building constructed in an *alpine area* and overrules other provisions of the BCA.

PERFORMANCE REQUIREMENTS

GP4.1

An external doorway from a building in an *alpine area* must be installed so that opening the door is not obstructed by snow or ice.

Application

GP4.1 applies to a building constructed in an *alpine area* overrules other provisions of the BCA.

GP4.2

A building in an *alpine area* containing external trafficable structures forming part of the means of egress must be constructed so that those structures remain, as far as practicable, useable under snow conditions.

Application

GP4.2 applies to a building constructed in an *alpine area* and overrules other provisions of the BCA.

GP4.3

A building in an *alpine area* must be constructed so that snow or ice is not shed from the building onto the allotment, any adjoining allotment, road or public space in a location or manner that will—

- (a) obstruct a means of egress from any building to a road or *open space*; or
- (b) otherwise endanger people.

Application

GP4.3 applies to a building constructed in an *alpine area* and overrules other provisions of the BCA.

GP4.4

A building in an *alpine area* must have a *fire safety system* installed to—

- (a) facilitate fire-fighting operations; and
- (b) alert occupants in the event of an emergency.

Application

GP4.4 applies to a building constructed in an *alpine area* and overrules other provisions of the BCA.

PART G4 CONSTRUCTION IN ALPINE AREAS

Deemed-to-Satisfy Provisions

G4.0 Deemed-to-Satisfy Provisions

- (a) Where a *Building Solution* is proposed to comply with the *Deemed-to-Satisfy Provisions, Performance Requirements GP4.1 to GP4.4* are satisfied by complying with **G4.1 to G4.9**.
- (b) Where a *Building Solution* is proposed as an *Alternative Solution* to the *Deemed-to-Satisfy Provisions* of **G4.1 to G4.9**, the relevant *Performance Requirements* must be determined in accordance with **A0.10**.

G4.1 Application of Part

- (a) The *Deemed-to-Satisfy Provisions* of this Part apply to any building constructed in an *alpine area* in addition to other *Deemed-to-Satisfy Provisions* of the BCA.
- (b) Where any *Deemed-to-Satisfy Provisions* are in conflict, the provisions of this Part take precedence.

G4.2 * * * * *

This clause has deliberately been left blank.

G4.3 External doorways

- (a) A door fitted to an external doorway which may be subject to the build-up of snow must—
 - (i) only be capable of opening inwards; and
 - (ii) be marked “OPEN INWARDS” on the inside face of the door in letters not less than 75 mm high and in a colour contrasting with that of the background; and
 - (iii) if it serves a corridor or stairway, be positioned in an alcove or recess with—
 - (A) no horizontal dimension less than twice the width of the door; and
 - (B) the door positioned to open against a wall such that the distance from any part of its swing to the nearest point of entry of the stairway or corridor is not less than the width of the door.
- (b) Every threshold of a *required exit* doorway must be located so that snow or ice is not deposited in a manner that will obstruct means of egress from that doorway.

G4.4 Emergency lighting

In a Class 2, 3, 5, 6, 7, 8 or 9 building or Class 4 part of a building, a system of emergency lighting must be installed in accordance with the *Deemed-to-Satisfy Provisions* of **Part E4**—

- (a) in every stairway (other than those within a *sole-occupancy unit* in a Class 2 or 3 building or Class 4 part of a building); and
- (b) in every *public corridor* or the like leading to an *exit*; and
- (c) externally above every doorway opening to a road or *open space*; and

Deemed-to-Satisfy Provisions

- (d) in any *storey* of the building if illumination sufficient for safe egress will not be available under conditions of emergency.

G4.5 External ramps

An external ramp serving as an *exit* must—

- (a) where a ramp is also serving as an *accessible* ramp under **Part D3**, be in accordance with AS 1428.1; or
- (b) in any other case, have a gradient not steeper than 1:12.

G4.6 Discharge of exits

A building in an *alpine area* must be so constructed that—

- (a) if any part of an *external wall* is more than 3.6 m above the natural ground level — the distance of that part from a boundary other than a road alignment is not less than 2.5 m plus 100 mm for each 300 mm or part by which that part of the wall exceeds a height of 3.6 m; and
- (b) if an *exit* doorway discharges into a court between wings of a building — the wings are not less than 6 m apart; and
- (c) if an *exit* doorway is opposite a barrier which is more than 900 mm above the threshold of the doorway — the threshold is at a distance from that barrier of not less than twice the height of the barrier or 6 m, whichever is the lesser.

G4.7 External trafficable structures

External stairways, ramps, access bridges or other trafficable structures must have—

- (a) a floor surface that consists of steel mesh or other suitable material if it is used as a means of egress; and
- (b) any *required* balustrade or other barrier constructed so that its sides are not less than 75% open.

G4.8 Fire-fighting services and equipment

Every Class 2, 3, 5, 6, 7, 8 or 9 building must have—

- (a) a manually operated fire alarm system with call-points complying with AS 1670.1; and
- (b) fire hose reels and fire hydrants installed in accordance with the *Deemed-to-Satisfy Provisions* of **Part E1**.

G4.9 Fire orders

Every Class 2, 3 or 9 building must display a notice clearly marked “FIRE ORDERS” in suitable locations near the main entrance and on each *storey*, explaining—

- (a) the method of operation of the fire alarm system and the location of all call-points; and
- (b) the location and methods of operation of all fire-fighting equipment; and
- (c) the location of all *exits*; and
- (d) the procedure for evacuation of the building.

PART G5

CONSTRUCTION IN BUSHFIRE PRONE AREAS

OBJECTIVE

NSW G05

Qld G05

Tas G05

G05

The *Objective* of this Part is to—

- (a) safeguard occupants from injury; and
 - (b) protect buildings,
- from the effects of a bushfire.

Application

G05 only applies to—

- (a) a Class 2 or 3 building; or
- (b) a Class 10a building or deck associated with a Class 2 or 3 building, located in a *designated bushfire prone area*.

FUNCTIONAL STATEMENT

NSW GF5.1

Qld GF5.1

Tas GF5.1

GF5.1

A building constructed in a *designated bushfire prone area* is to provide a resistance to bushfires in order to reduce the danger to life and minimise the risk of the loss of the building.

Application

GF5.1 only applies to—

- (a) a Class 2 or 3 building; or
- (b) a Class 10a building or deck associated with a Class 2 or 3 building,

located in a *designated bushfire prone area*.

PERFORMANCE REQUIREMENT

NSW GP5.1

Qld GP5.1

Tas GP5.1

GP5.1

A building that is constructed in a *designated bushfire prone area* must, to the degree necessary, be designed and constructed to reduce the risk of ignition from a bushfire, appropriate to the—

- (a) potential for ignition caused by burning embers, radiant heat or flame generated by a bushfire; and
- (b) intensity of the bushfire attack on the building.

Application

GP5.1 only applies to—

- (a) a Class 2 or 3 building; or
- (b) a Class 10a building or deck associated with a Class 2 or 3 building,
located in a *designated bushfire prone area*.

PART G5

CONSTRUCTION IN BUSHFIRE PRONE AREAS

Deemed-to-Satisfy Provisions

G5.0 Deemed-to-Satisfy Provisions

- (a) Where a *Building Solution* is proposed to comply with the *Deemed-to-Satisfy Provisions*, *Performance Requirements GP5.1* is satisfied by complying with **G5.1** and **G5.2**.
- (b) Where a *Building Solution* is proposed as an *Alternative Solution* to the *Deemed-to-Satisfy Provisions* of **G5.1** and **G5.2**, the relevant *Performance Requirements* must be determined in accordance with **A0.10**.

G5.1 Application of Part

SA G5.1

Qld G5.1

The *Deemed-to-Satisfy Provisions* of this Part apply to—

- (a) a Class 2 or 3 building; or
- (b) a Class 10a building or deck associated with a Class 2 or 3 building, located in a *designated bushfire prone area*.

G5.2 Protection

NSW G5.2

SA G5.2

In a *designated bushfire prone area*—

- (a) a Class 2 or 3 building; or
- (b) a Class 10a building or deck associated with a Class 2 or 3 building, must comply with AS 3959.

SA G5.3

Tas G5.3 and Tas G5.4

SPECIAL USE BUILDINGS

H1 Theatres, Stages and Public Halls

H2 Public Transport Buildings

SECTION H CONTENTS

SECTION H SPECIAL USE BUILDINGS

Part H1 Theatres, Stages and Public Halls

- H1.1 Application of Part
- H1.2 Separation
- H1.3 Proscenium wall construction
- H1.4 Seating area
- H1.5 Exits from theatre stages
- H1.6 Access to platforms and lofts
- H1.7 Aisle lights in theatres

Part H2 Public Transport Buildings

- H2.1 Application of Part
- H2.2 Accessways
- H2.3 Ramps
- H2.4 Handrails and grabrails
- H2.5 Doorways and doors
- H2.6 Lifts
- H2.7 Stairways
- H2.8 Unisex accessible toilet
- H2.9 Location of accessible toilets
- H2.10 Symbols and signs
- H2.11 Tactile ground surface indicators
- H2.12 Lighting
- H2.13 Hearing augmentation
- H2.14 Emergency warning systems
- H2.15 Controls

Specifications

Specification H1.3 Construction of Theatres with Proscenium Walls

PART H1 THEATRES, STAGES AND PUBLIC HALLS

Deemed-to-Satisfy Provisions

Note.

Part H1 contains *Deemed-to-Satisfy Provisions* additional to those contained in Sections **C**, **D** and **E** for buildings containing theatres, stages and public halls.

H1.1 Application of Part

NSW H1.1

- (a) The *Deemed-to-Satisfy Provisions* of this Part apply to every enclosed Class 9b building or part of a building which—
- (i) is a *school* assembly, church or community hall with a *stage* and any *backstage* area with a total *floor area* of more than 300 m²; or
 - (ii) otherwise, has a *stage* and any *backstage* area with a total *floor area* of more than 200 m²; or
 - (iii) has a *stage* with an associated rigging loft.
- (b) Notwithstanding (a)—
- (i) **H1.4** applies to every open or enclosed Class 9b building; and
 - (ii) **H1.7** applies to every enclosed Class 9b building.

H1.2 Separation

A theatre, public hall or the like must—

- (a) have a sprinkler system complying with **Specification E1.5**; or
- (b) have the *stage*, *backstage* area and accessible under-*stage* area separated from the audience by a proscenium wall in accordance with **H1.3**.

H1.3 Proscenium wall construction

A proscenium wall must comply with **Specification H1.3**.

H1.4 Seating area

In a seating area—

- (a) the gradient of the floor surface must not be steeper than 1 in 8, or the floor must be stepped so that—
 - (i) a line joining the nosings of consecutive steps does not exceed an angle of 30° to the horizontal; and
 - (ii) the height of each step in the stepped floor is not more than 600 mm; and
 - (iii) the height of any opening in such a step is not more than 125 mm; and
- (b) if an aisle divides the stepped floor and the difference in level between any 2 consecutive steps—

Deemed-to-Satisfy Provisions

- (i) exceeds 230 mm but not 400 mm — an intermediate step must be provided in the aisle; and
- (ii) exceeds 400 mm — 2 equally spaced intermediate steps must be provided in the aisle; and
- (iii) the going of intermediate steps must be not less than 270 mm and such as to provide as nearly as practicable equal treads throughout the length of the aisle; and
- (c) the clearance between rows of fixed seats used for viewing performing arts, sport or recreational activities must be not less than—
 - (i) 300 mm if the distance to an aisle is not more than 3.5 m; or
 - (ii) 500 mm if the distance to an aisle is more than 3.5 m.

H1.5 Exits from theatre stages

- (a) The path of travel to an *exit* from a *stage* or performing area must not pass through the proscenium wall if the *stage* area is separated from the audience area with a proscenium wall.
- (b) *Required exits* from *backstage* and under-*stage* areas must be independent of those provided for the audience area.

H1.6 Access to platforms and lofts

A stairway that provides access to a service platform, rigging loft, or the like, must comply with AS 1657.

H1.7 Aisle lights in theatres

In every enclosed Class 9b building, where in any part of the auditorium, the general lighting is dimmed or extinguished during public occupation and the floor is stepped or is inclined at a slope steeper than 1 in 12, aisle lights must be provided to illuminate the full length of the aisle and tread of each step.

PART H2 PUBLIC TRANSPORT BUILDINGS

Note.

Part H2 contains *Deemed-to-Satisfy Provisions* for Class 9b and Class 10 public transport buildings additional to those contained in **Parts D3, E3** and **F2** that apply to public transport buildings.

Deemed-to-Satisfy Provisions

H2.1 Application of Part

- (a) The *Deemed-to-Satisfy Provisions* of this Part apply to the passenger use areas of a Class 9b or Class 10 building used for public transport.
- (b) The *Deemed-to-Satisfy Provisions* of this Part take precedence where there is a difference to the *Deemed-to-Satisfy Provisions* of **Parts D3, E3** and **F2**.
- (c) For an airport that does not accept regular public transport services, as defined in the Disability Standards for Accessible Public Transport 2002, only **H2.8, H2.9, H2.10, H2.11, H2.12** and **H2.13** of this Part apply.
- (d) **A3.3(a)(i)** does not apply to this Part.

H2.2 Accessways

- (a) An *accessway* must comply with AS 1428.2.
- (b) If an *accessway* branches into 2 or more parallel tracks—
 - (i) the ends of each track must be on the main pedestrian traffic routes; and
 - (ii) the parallel tracks must have equal convenience and be located as close as practicable to the main pedestrian branch.
- (c) The minimum unobstructed width of an *accessway* must be 1.2 m, except that—
 - (i) the minimum unobstructed width of a moving walkway forming part of an *accessway* may be not less than 850 mm; and
 - (ii) the minimum unobstructed width of a doorway in an *accessway* may be not less than 850 mm.
- (d) Poles, columns, stanchions, bollards and fixtures must not project into an *accessway*.
- (e) Obstacles that abut an *accessway* must have a *luminance contrast* with a background of not less than 30%.
- (f) Manoeuvring areas that allow a 180 degree wheelchair turn must comply with clause 6.2 of AS 1428.2.
- (g) A passing area must be provided at least every 6 m along any two-way *accessway* that is less than 1 800 mm wide.
- (h) Ground and floor surfaces must comply with clause 9 of AS 1428.2 and AS 1428.1. Supplement 1 provides criteria for the selection of floor surfaces.
- (i) The requirements of **D3.3(c)(ii)** do not apply to Class 9b or Class 10 public transport buildings.

Deemed-to-Satisfy Provisions

H2.3 Ramps

- (a) A ramp forming part of an [accessway](#) must comply with clause 8 of AS 1428.2.
- (b) The requirements of [D3.11\(a\)](#) do not apply to Class 9b or Class 10 public transport buildings.

H2.4 Handrails and grabrails

- (a) A handrail must comply with clause 10.1 of AS 1428.2.
- (b) Handrails must be placed along an [accessway](#) wherever passengers are likely to require additional support or passive guidance.
- (c) A grabrail must comply with clause 10.2 of AS 1428.2.
- (d) A grabrail or handrail must be provided at fixed locations where passengers are required to pay fares.

H2.5 Doorways and doors

Doorways and doors must comply with clause 11 (except clause 11.5.2) of AS 1428.2.

H2.6 Lifts

Lift facilities must comply with AS 1735.12.

H2.7 Stairways

Stairs must comply with—

- (a) clause 9.1 of AS 1428.1, including the notes; and
- (b) clause 9.2 of AS 1428.1; and
- (c) clause 13.2, 13.3 and Figures 8 and 9 of AS 1428.2.

H2.8 Unisex accessible toilet

If toilets are provided, there must be at least one unisex [accessible](#) toilet without an airlock that complies with AS 1428.1 clause 10, sanitary facilities.

H2.9 Location of accessible toilets

[Accessible](#) toilets must be in the same location as other toilets.

H2.10 Symbols and signs

- (a) The international symbols for accessibility and deafness in accordance with clauses 14.2 and 14.3 of AS 1428.1 must be used to identify an [accessway](#) and which facilities and boarding points are [accessible](#).
- (b) Signs must be placed in accordance with clause 17.4 of AS 1428.2.
- (c) The size of accessibility symbols must comply with Table 1 of AS 1428.2.

Deemed-to-Satisfy Provisions

- (d) The symbol for accessibility must incorporate directional arrows and words or, if possible, pictograms, to show passengers the way to *accessible* facilities such as toilets.
- (e) Signs must comply with clause 17.1 and Figure 30 of AS 1428.2.
- (f) If a sign incorporates raised lettering or symbols, they must be at least 0.8 mm above the surface of the sign.
- (g) If an operator or provider supplements a notice with braille characters, they must be placed to the left of the raised characters.

H2.11 Tactile ground surface indicators

Tactile ground surface indicators must be installed in accordance with AS 1428.4 on an *accessway* and must indicate changes of direction in accordance with clause 18.1 of AS 1428.2.

H2.12 Lighting

Any lighting provided must comply with minimum levels of maintenance illumination for various situations shown in the notes to clause 19.1 of AS 1428.2.

H2.13 Hearing augmentation

If a public address system is installed, it must comply with clause 21.1 of AS 1428.2.

H2.14 Emergency warning systems

- (a) If an emergency warning system is installed, it must comply with clause 18.2.1, 18.2.2 and 18.2.3 of AS 1428.2.
- (b) In the event of an emergency, provision must be made for people with vision impairment to locate the *exit* path.

H2.15 Controls

Controls must comply with clause 11 of AS 1428.1.

SPECIFICATION **H1.3** CONSTRUCTION OF THEATRES WITH
PROSCENIUM WALLS

Deemed-to-Satisfy Provisions

1. Scope

This Specification contains the requirements for the construction of proscenium walls for theatres, public halls, or the like.

2. Separation of stage areas, etc

- (a) Dressing rooms, scene docks, property rooms, workshops, associated store rooms and other ancillary areas must be—
 - (i) located on the *stage* side of the proscenium wall; and
 - (ii) separated from corridors and the like by construction having an FRL of not less than 60/60/60, and if of *lightweight construction*, complying with **Specification C1.8**.
- (b) The *stage* and *backstage* must be separated from other parts of the building other than the audience seating area by construction having an FRL of not less than 60/60/60, and if of *lightweight construction*, complying with **Specification C1.8**.
- (c) Any doorway in the construction referred to in paragraphs (a) and (b) must be protected by a *self-closing* - /60/30 fire door.

3. Proscenium wall construction

A proscenium wall must—

- (a) extend to the underside of the roof covering or the underside of the structural floor next above; and
- (b) have an FRL of not less than 60/60/60, and if of *lightweight construction*, comply with **Specification C1.8**.

4. Combustible materials not to cross proscenium wall

Timber purlins or other *combustible* material must not pass through or cross any proscenium wall.

5. Protection of openings in proscenium wall

Every opening in a proscenium wall must be protected—

- (a) at the principal opening, by a curtain in accordance with **Clause 6** which is—
 - (i) capable of closing the proscenium opening within 35 seconds either by gravity slide or motor assisted mechanisms; and
 - (ii) operated by a system of *automatic* heat activated devices, manually operated devices or push button emergency devices; and

Deemed-to-Satisfy Provisions

- (iii) able to be operated from either the *stage* side or the audience side of the curtain; and
- (b) at any doorway in the wall, by a *self-closing* - /60/30 fire door.

6. Proscenium curtains

A curtain *required* by **Clause 5** must be—

- (a) a fire safety curtain—
 - (i) made of *non-combustible* material; and
 - (ii) capable of withstanding a pressure differential of 0.5 kPa over its entire surface area; and
 - (iii) so fitted that when fully lowered it inhibits the penetration of smoke around the perimeter of the opening, from the *stage*; or
- (b) a curtain—
 - (i) having *fire hazard properties* complying with **Specification C1.10**; and
 - (ii) protected by a deluge system of open sprinklers installed along the full width of the curtain.

MAINTENANCE

- I1 **Equipment and Safety Installations**
- I2 **Energy Efficiency Installations**

SECTION I CONTENTS

SECTION I MAINTENANCE

Part I1 Equipment and Safety Installations

Objective IO1

Functional Statement IF1.1

Performance Requirement IP1.1 - IP1.2

I1.0 Deemed-to-Satisfy Provisions

I1.1 Safety measures

I1.2 Mechanical ventilation and hot water, warm water and cooling water systems

Part I2 Energy Efficiency Installations

Objective IO2

Functional Statement IF2.1

Performance Requirement IP2.1

I2.0 Deemed-to-Satisfy Provisions

I2.1 Application of Part

I2.2 Components of services

PART I1 EQUIPMENT AND SAFETY INSTALLATIONS

OBJECTIVE

IO1

The *Objective* of this Part is to ensure that people are protected from illness, injury and loss of amenity throughout the life of the building.

FUNCTIONAL STATEMENT

IF1.1

Equipment and safety installations in a building are to safeguard people from illness or injury and prevent the loss of amenity.

PERFORMANCE REQUIREMENT

IP1.1

Safety measures must be capable of performing to a standard no less than that which they were originally *required* to achieve.

IP1.2

Mechanical ventilation and hot water, warm water and cooling water systems must be adequately maintained to safeguard people from illness or injury.

PART 11

EQUIPMENT AND SAFETY INSTALLATIONS

Deemed-to-Satisfy Provisions

11.0 Deemed-to-Satisfy Provisions

- (a) Where a *Building Solution* is proposed to comply with the *Deemed-to-Satisfy Provisions*—
 - (i) *Performance Requirement IP1.1* is satisfied by complying with **11.1**; and
 - (ii) *Performance Requirement IP1.2* is satisfied by complying with **11.2**.
- (b) Where a *Building Solution* is proposed as an *Alternative Solution* to the *Deemed-to-Satisfy Provisions* of **11.1** to **11.2**, the relevant *Performance Requirements* must be determined in accordance with **A0.10**.

11.1 Safety measures

NSW 11.1

NT 11.1

SA 11.1

Safety measures must—

- (a) perform to a standard not less than they were originally *required* to achieve; and
- (b) for those safety measures listed in **Tables 11.1** to **11.13**, perform to a standard not less than that determined using the corresponding BCA provisions.

Table 11.1 SAFETY MEASURES - BUILDING FIRE INTEGRITY

| Safety measure | BCA provisions for determining standard of performance |
|--|---|
| Building elements <i>required</i> to satisfy prescribed <i>fire-resistance levels</i> | Section C D1.12 |
| Materials and assemblies <i>required</i> to have <i>fire hazard properties</i> | C1.10 |
| Elements <i>required</i> to be <i>non-combustible</i> , provide fire protection, compartmentation or separation | C2.5 to C2.14, C3.3, C3.11 D1.7, D1.8 E1.3 G3.4 |
| Wall-wetting sprinklers (including doors and windows <i>required</i> in conjunction with wall-wetting sprinklers) | C3.4, C3.8, C3.11 D1.7, D1.8 G3.8 |
| Fire doors (including sliding fire doors and their associated warning systems) and associated <i>self-closing</i> , <i>automatic</i> closing and latching mechanisms | C2.12, C2.13, C3.4 to C3.8, C3.10, C3.11 D1.7, D1.8, D1.12 |

Deemed-to-Satisfy Provisions

Table 11.1 SAFETY MEASURES - BUILDING FIRE INTEGRITY— continued

| Safety measure | BCA provisions for determining standard of performance |
|---|--|
| Fire windows (including windows that are <i>automatic</i> or permanently fixed in the closed position) | C3.4, C3.8, C3.11 |
| | D1.7, D1.8 |
| Fire shutters | C3.4, C3.5 |
| | D1.7, D1.8 |
| Solid core doors and associated <i>self-closing, automatic</i> closing and latching mechanisms | C3.11 |
| Fire protection at service penetrations through elements <i>required</i> to be <i>fire-resisting</i> with respect to <i>integrity</i> or <i>insulation</i> , or to have a <i>resistance to the incipient spread of fire</i> | C3.12, C3.13, C3.15 |
| Fire protection associated with construction joints, spaces and the like in and between building elements <i>required</i> to be <i>fire-resisting</i> with respect to <i>integrity</i> and <i>insulation</i> | C3.16 |
| Smoke doors and associated <i>self-closing, automatic</i> closing and latching mechanisms | Specification C2.5 |
| | D2.6 |
| Proscenium walls (including proscenium curtains) | H1.3 |

Table 11.2 SAFETY MEASURES - MEANS OF EGRESS

| Safety measure | BCA provisions for determining standard of performance |
|--|--|
| Paths of travel to <i>exits</i> | D1.6 |
| Discharge from <i>exits</i> (including paths of travel from <i>open spaces</i> to the public roads to which they are connected) | D1.7, D1.9 to D1.11, D2.12 |
| | G4.3, G4.6, G4.7 |
| <i>Exits</i> (including <i>fire-isolated stairways</i> and ramps, non- <i>fire-isolated stairways</i> and ramps, stair treads, balustrades and handrails associated with <i>exits</i> , and <i>fire-isolated passageways</i>) | D2.2, D2.3, D2.8 to D2.11, D2.13, D2.16, D2.17 |
| Smoke lobbies to fire-isolated <i>exits</i> | D1.7, D2.6 |
| Open access ramps or balconies for fire-isolated <i>exits</i> | D2.19 to D2.23 |
| Doors (other than fire or smoke doors) in a <i>required exit</i> , forming part of a <i>required exit</i> or in a path of travel to a <i>required exit</i> , and associated <i>self-closing, automatic</i> closing and latching mechanisms | D1.6, D2.19 to D2.21, D2.23 |

Deemed-to-Satisfy Provisions

Table I1.3 SAFETY MEASURES - SIGNS

| Safety measure | BCA provisions for determining standard of performance |
|--|--|
| <i>Exit</i> signs (including direction signs) | Specification D1.12 |
| | E4.5, E4.6, E4.8 |
| Signs warning against the use of lifts in the event of fire | E3.3 |
| Warning signs on sliding fire doors and doors to non- <i>required</i> stairways, ramps and escalators | C3.6 |
| | Specification D1.12 |
| Signs, intercommunication systems, or alarm systems on doors of fire-isolated <i>exits</i> stating that re-entry to a <i>storey</i> is available | D2.22 |
| Signs alerting persons that operation of doors must not be impaired | D2.23 |
| Signs <i>required</i> on doors, in <i>alpine areas</i> , alerting people that they open inwards | G4.3 |
| Fire order notices <i>required</i> in <i>alpine areas</i> | G4.9 |

Table I1.4 SAFETY MEASURES - LIGHTING

| Safety measure | BCA provisions for determining standard of performance |
|--|--|
| Emergency lighting | E4.2, E4.4 |
| Artificial lighting <i>required</i> to assist occupant movement and egress | F4.4, H1.7 |

Table I1.5 SAFETY MEASURES - FIRE FIGHTING SERVICES AND EQUIPMENT

| Safety measure | BCA provisions for determining standard of performance |
|--|--|
| Fire hydrant system (including on-site pump set and fire-service booster connection) | E1.3 |
| Fire hose reel system | E1.4 |
| Sprinkler system | E1.5 |
| | G3.8 |
| | H1.2 |
| Portable fire extinguishers | E1.6 |
| Fire control centres (or rooms) | E1.8 |

Deemed-to-Satisfy Provisions

Table I1.6 SAFETY MEASURES - AIR HANDLING SYSTEMS

| Safety measure | BCA provisions for determining standard of performance |
|---|--|
| Smoke hazard management systems— | E2.2 |
| <ul style="list-style-type: none"> • <i>automatic</i> air pressurisation systems for fire-isolated <i>exits</i> | |
| <ul style="list-style-type: none"> • zone smoke control system | |
| <ul style="list-style-type: none"> • <i>automatic</i> smoke exhaust system | |
| <ul style="list-style-type: none"> • <i>automatic smoke-and-heat vents</i> | |
| <ul style="list-style-type: none"> • air-handling systems that do not form part of smoke hazard management system and which may unduly contribute to the spread of smoke | |
| <ul style="list-style-type: none"> • miscellaneous air-handling systems covered by Sections 5 and 11 of AS/NZS 1668.1 serving more than one <i>fire compartment</i> | |
| <ul style="list-style-type: none"> • other air-handling systems | |
| <i>Carpark</i> mechanical ventilation system | F4.11 |
| <i>Atrium</i> smoke control system | Specification G3.8 |

Table I1.7 SAFETY MEASURES - AUTOMATIC FIRE DETECTION AND ALARM SYSTEMS

| Safety measure | BCA provisions for determining standard of performance |
|--|--|
| Smoke and heat alarm system | Clause 3 of Specification E2.2a |
| Smoke and heat detection system | Clause 4 of Specification E2.2a |
| <i>Atrium</i> fire detection and alarm systems | Clause 4 of Specification G3.8 |

Table I1.8 SAFETY MEASURES - OCCUPANT WARNING SYSTEMS

| Safety measure | BCA provisions for determining standard of performance |
|---|--|
| Sound system and intercom system for emergency purposes | E4.9 |
| | Clause 5 of Specification G3.8 |
| Building occupant warning system | Clause 8 of Specification E1.5 |
| | Clause 6 of Specification E2.2a |

Table I1.9 SAFETY MEASURES - LIFTS

| Safety measure | BCA provisions for determining standard of performance |
|-------------------------------|--|
| Stretcher facilities in lifts | E3.2 |
| Emergency lifts | E3.4 |

Deemed-to-Satisfy Provisions

Table 11.9 SAFETY MEASURES - LIFTS— continued

| Safety measure | BCA provisions for determining standard of performance |
|--------------------------------------|--|
| Passenger lift fire service controls | E3.7 |

Table 11.10 SAFETY MEASURES - STANDBY POWER SUPPLY SYSTEMS

| Safety measure | BCA provisions for determining standard of performance |
|-----------------------------|--|
| Standby power supply system | E3.4 |
| | Clause 6 of Specification G3.8 |

Table 11.11 SAFETY MEASURES - BUILDING CLEARANCE AND FIRE APPLIANCES

| Safety measure | BCA provisions for determining standard of performance |
|--|--|
| Open space around large isolated buildings | C2.3, C2.4 |
| Vehicular access around large isolated buildings | C2.3, C2.4 |

Table 11.12 SAFETY MEASURES - OTHER MEASURES

| Safety measure | BCA provisions for determining standard of performance |
|--|--|
| Glazed assemblies | B1.4 |
| | F1.13 |
| Balconies | Part B1 |
| Balustrades | Part B1 |
| | D2.16 |
| <i>Swimming pool</i> safety fencing | G1.1 |
| Refrigerated chambers, strong rooms and vaults | G1.2 |
| Bushfire protection measures | G5.2 |

Table 11.13 SAFETY MEASURES - BUILDING USE AND APPLICATION

| Safety measure | BCA provisions for determining standard of performance |
|------------------------------------|--|
| Classification and use of building | A3.2 to A3.4 |
| Occupancy hazard | E1.5, E1.6 |

11.2 Mechanical ventilation and hot water, warm water and cooling water systems

NSW 11.2

Deemed-to-Satisfy Provisions

SA 11.2

Mechanical ventilation and hot water, warm water and cooling water systems in a building other than a system only serving a single *sole-occupancy unit* in a Class 2 or 3 building or Class 4 part of a building must be maintained in accordance with AS/NZS 3666.2.

PART I2

ENERGY EFFICIENCY INSTALLATIONS

NSW Part I2

NT Part I2

Tas Part I2

OBJECTIVE

IO2

The *Objective* of this Part is to reduce greenhouse gas emissions by efficiently using energy throughout the life of the building.

Limitation:

IO2 does not apply to a *sole-occupancy unit* in a Class 2 building, or a Class 4 part of a building.

FUNCTIONAL STATEMENT

IF2.1

A building's *services* are to be continually capable of using energy efficiently.

Limitation:

IF2.1 does not apply to a *sole-occupancy unit* in a Class 2 building, or a Class 4 part of a building.

PERFORMANCE REQUIREMENT

IP2.1

A building's *services* must continue to perform to a standard of energy efficiency no less than that which they were originally *required* to achieve.

Limitation:

IP2.1 does not apply to *services* serving only one *sole-occupancy unit* in a Class 2 building, or serving only a Class 4 part of a building.

PART 12

ENERGY EFFICIENCY INSTALLATIONS

Deemed-to-Satisfy Provisions

NSW Part 12

NT Part 12

Tas Part 12

12.0 Deemed-to-Satisfy Provisions

- (a) Where a *Building Solution* is proposed to comply with the *Deemed-to-Satisfy Provisions*, *Performance Requirement IP2.1* is satisfied by complying with **12.1** to **12.2**.
- (b) Where a *Building Solution* is proposed as an *Alternative Solution* to the *Deemed-to-Satisfy Provisions* of **12.1** to **12.2**, the relevant *Performance Requirements* must be determined in accordance with **A0.10**.

12.1 Application of Part

The *Deemed-to-Satisfy Provisions* of this Part do not apply to *services* serving only one *sole-occupancy unit* of a Class 2 building or serving a Class 4 part of a building.

12.2 Components of services

Components of *services* must be maintained to ensure that they perform to a standard not less than they were originally *required* to achieve, including—

- (a) adjustable or motorised shading devices; and
- (b) time switches and motion detectors; and
- (c) room temperature thermostats; and
- (d) plant thermostats such as on boilers or refrigeration units; and
- (e) motorised air dampers and control valves; and
- (f) reflectors, lenses and diffusers of light fittings; and
- (g) heat transfer equipment; and
- (h) plant that receives a concession under **JV3(b)** for the use of energy obtained from—
 - (i) an on-site *renewable energy* source; or
 - (ii) another process as reclaimed energy.

ENERGY EFFICIENCY

- J0** **Energy Efficiency**
- J1** **Building Fabric**
- J2** **Glazing**
- J3** **Building Sealing**
- J4** * * * * *
- J5** **Air-conditioning and Ventilation Systems**
- J6** **Artificial Lighting and Power**
- J7** **Hot Water Supply and Swimming Pool and Spa
Pool Plant**
- J8** **Access for Maintenance and Facilities for
Monitoring**

SECTION J CONTENTS

SECTION J ENERGY EFFICIENCY

Section J Energy Efficiency

- Objective JO1
- Functional Statement JF1
- Performance Requirements JP1 - JP3
- Verification Methods JV1 - JV3
- Specification JV Annual energy consumption criteria

Part J0 Energy Efficiency

- J0.0 Deemed-to-Satisfy Provisions
- J0.1 Application of Section J
- J0.2 Heating and cooling loads of sole-occupancy units of a Class 2 building or a Class 4 Part
- J0.3 Ceiling fans

Part J1 Building Fabric

- J1.0 Deemed-to-Satisfy Provisions
- J1.1 Application of Part
- J1.2 Thermal construction — general
- J1.3 Roof and ceiling construction
- J1.4 Roof Lights
- J1.5 Walls
- J1.6 Floors

Part J2 Glazing

- J2.0 Deemed-to-Satisfy Provisions
- J2.1 Application of Part
- J2.2 * * * * *
- J2.3 * * * * *
- J2.4 Glazing
- J2.5 Shading

Part J3 Building Sealing

- J3.0 Deemed-to-Satisfy Provisions
- J3.1 Application of Part
- J3.2 Chimneys and flues
- J3.3 Roof lights
- J3.4 Windows and doors
- J3.5 Exhaust fans
- J3.6 Construction of roofs, walls and floors
- J3.7 Evaporative coolers

Part J4 * * * * *

Part J5 Air-Conditioning and Ventilation Systems

J5.0 Deemed-to-Satisfy Provisions

J5.1 * * * * *

J5.2 Air-conditioning and ventilation systems

J5.3 Time switch

J5.4 Heating and cooling systems

J5.5 Miscellaneous exhaust systems

Part J6 Artificial Lighting and Power

J6.0 Deemed-to-Satisfy Provisions

J6.1 Application of Part

J6.2 Artificial lighting

J6.3 Interior artificial lighting and power control

J6.4 Interior decorative and display lighting

J6.5 Artificial lighting around the perimeter of a building

J6.6 Boiling water and chilled water storage units

Part J7 Hot Water Supply and Swimming Pool and Spa Pool Plant

J7.0 Deemed-to-Satisfy Provisions

J7.1 * * * * *

J7.2 Hot water supply

J7.3 Swimming pool heating and pumping

J7.4 Spa pool heating and pumping

Part J8 Access for Maintenance and Facilities for Monitoring

J8.0 Deemed-to-Satisfy Provisions

J8.1 Application of Part

J8.2 Access for maintenance

J8.3 Facilities for energy monitoring

Specifications

Specification J1.2 Material Properties

Specification J1.3 Roof and Ceiling Construction

Specification J1.5 Wall Construction

Specification J1.6 Floor Construction

Specification J5.2 Ductwork Insulation and Sealing

Specification J5.4 Insulating of Piping, Vessels, Heat Exchangers and Tanks

Specification J6 Lighting and Power Control Devices

SECTION J ENERGY EFFICIENCY

NSW Section J

NT Section J

Qld Section J

OBJECTIVE

JO1

The *Objective* of this Section is to reduce greenhouse gas emissions.

FUNCTIONAL STATEMENT

JF1

To reduce greenhouse gas emissions, to the degree necessary—

- (a) a building, including its *services*, is to be capable of efficiently using energy; and
- (b) a building's *services* for heating are to obtain their energy from—
 - (i) a low greenhouse gas intensity source; or
 - (ii) an on-site *renewable energy* source; or
 - (iii) another process as reclaimed energy.

PERFORMANCE REQUIREMENTS

JP1

A building, including its *services*, must have, to the degree necessary, features that facilitate the efficient use of energy appropriate to—

- (a) the function and use of the building and *services*; and
- (b) the internal environment; and
- (c) the geographic location of the building; and
- (d) the effects of nearby permanent features such as topography, structures and buildings; and
- (e) solar radiation being—
 - (i) utilised for heating; and

- (ii) controlled to minimise energy for cooling; and
- (f) the sealing of the building *envelope* against air leakage; and
- (g) the utilisation of air movement to assist heating and cooling; and
- (h) the energy source of the *services*.

JP2

A building, including its *services*, must have, to the degree necessary, features that facilitate the maintenance of systems and components appropriate to the function and use of the building.

Limitation:

JP2 does not apply to *services* serving only one *sole-occupancy unit* in a Class 2 building or serving a Class 4 part of a building.

JP3

Heating such as for a *conditioned space* must, to the degree necessary, obtain energy from—

- (a) a source that has a greenhouse gas intensity that does not exceed 100 g CO₂-e/MJ of thermal energy load; or
- (b) an on-site *renewable energy* source; or
- (c) another process as reclaimed energy.

SA JP4

VERIFICATION METHODS

JV1 * * * * *

This clause has deliberately been left blank.

JV2 * * * * *

This clause has deliberately been left blank.

JV3 Verification using a reference building

- (a) For a Class 3, 5, 6, 7, 8 or 9 building, compliance with **JP1** is verified when it is determined that the *annual energy consumption* of the proposed building with its *services* is not more than the *annual energy consumption* of a *reference building* when—
 - (i) the proposed building is modelled with the proposed *services*; and
 - (ii) the proposed building is modelled with the same *services* as the *reference building*.
- (b) The *annual energy consumption* of the proposed building in (a) may be reduced by the amount of energy obtained from—
 - (i) an on-site *renewable energy* source; or

- (ii) another process as reclaimed energy.
- (c) The *annual energy consumption* calculation method must comply with the ABCB Protocol for Building Energy Analysis Software.
- (d) The *annual energy consumption* in (a) must be calculated—
 - (i) for the *reference building*, using—
 - (A) the *Deemed-to-Satisfy Provisions* for **Parts J1 to J7** but including only the minimum amount of mechanical ventilation *required* by **Part F4**; and
 - (B) a solar absorptance of 0.6 for *external walls* and 0.7 for roofs; and
 - (C) the maximum *illumination power density* without any increase for a control device *illumination power density* adjustment factor; and
 - (D) *air-conditioning* with the *conditioned space* temperature within the range of 18° CDB to 26° CDB for 98% of the plant operation time; and
 - (E) the profiles for occupancy, *air-conditioning*, lighting and internal heat gains from people, hot meals, appliances, equipment and hot water supply systems—
 - (aa) of the actual building—
 - (AA) if the operating hours per year are not less than 2 500; or
 - (BB) if the daily operating profiles are not listed in **Specification JV**;
or
 - (bb) of **Specification JV**; and
 - (F) infiltration values—
 - (aa) for a perimeter zone of depth equal to the floor-to-ceiling height, when pressurising plant is operating, 1.0 air change per hour; and
 - (bb) for the whole building, when pressurising plant is not operating, 1.5 air change per hour; and
 - (ii) for both the proposed building and the *reference building* using the same—
 - (A) *annual energy consumption* calculation method; and
 - (B) location, being either the location where the building is to be constructed if appropriate climatic data is available, or the nearest location with similar climatic conditions, for which climatic data is available; and
 - (C) adjacent structures and features; and
 - (D) environmental conditions such as ground reflectivity, sky and ground form factors, temperature of external bounding surfaces, air velocities across external surfaces and the like; and
 - (E) orientation; and
 - (F) building form, including—
 - (aa) the roof geometry; and
 - (bb) the floor plan; and
 - (cc) the number of *storeys*; and
 - (dd) the ground to lowest floor arrangements; and

- (ee) the size and location of *glazing*; and
- (G) external doors; and
- (H) testing standards including for insulation, *glazing*, water heater and package *air-conditioning* equipment; and
- (I) thermal resistance of air films including any adjustment factors, moisture content of materials and the like; and
- (J) dimensions of external, internal and separating walls; and
- (K) surface density of *envelope* walls over 220 kg/m²; and
- (L) quality of insulation installation; and
- (M) assumptions and means of calculating the temperature difference across *air-conditioning* zone boundaries; and
- (N) floor coverings and furniture and fittings density; and
- (O) internal shading devices, their colour and their criteria for operation; and
- (P) number, sizes and floors served by lifts and escalators; and
- (Q) range and type of *services* and energy sources other than energy generated on-site from sources that do not emit greenhouse gases such as solar and wind power; and
- (R) internal artificial lighting levels; and
- (S) internal heat gains including people, lighting, appliances, meals and other electric power loads; and
- (T) *air-conditioning* system configuration and zones; and
- (U) daily and annual profiles of the—
 - (aa) building occupancy; and
 - (bb) operation of *services*; and
- (V) range of internal temperatures and plant operating times; and
- (W) supply hot water temperature and rate of use; and
- (X) infiltration values unless there are specific additional sealing provisions or pressure testing to be undertaken; and
- (Y) unit capacity and sequencing for water heaters, refrigeration chillers and heat rejection equipment such as cooling towers; and
- (Z) metabolic rate for people; and
- (iii) for the proposed building using a solar absorptance for the roof and walls 0.05 higher than that proposed; and
- (e) Where the *annual energy consumption* of the hot water supply or the lifts and escalators are the same in the proposed building and the *reference building*, they may be omitted from the calculation of both the proposed building and the *reference building*.
- (f) A lift in a building with more than one classification may be proportioned according to the number of *storeys* of the part for which the *annual energy consumption* is being calculated.
- (g) The design must include—

- (i) the ability to achieve all the criteria used in the *annual energy consumption* calculation method such as having an automatic operation controlling device capable of turning lighting, and *air-conditioning* plant on and off in accordance with the occupancy and operating profiles used; and
- (ii) compliance with—
 - (A) **J1.2** for general thermal construction; and
 - (B) **J1.3(c)** for compensation for a loss of ceiling insulation; and
 - (C) **J1.6(a)(ii)**, **J1.6(c)** and **J1.6(d)** for floor edge insulation; and
 - (D) BS 7190 for testing a water heater; and
 - (E) AS/NZS 3823.1.2 at test condition T1 for testing package *air-conditioning* equipment; and
 - (F) AHRI 550/590 for testing a refrigeration chiller.

SA JV4

SPECIFICATION **JV**

ANNUAL ENERGY CONSUMPTION
CRITERIA

1. Scope

This Specification contains the requirements for calculating the *annual energy consumption of services* in a building.

2. Annual energy consumption of services

The *annual energy consumption*—

- (a) for *air-conditioning*, must be calculated on the basis of—
 - (i) the daily occupancy and operation profiles in **Tables 2a to 2g**; and
 - (ii) plant serving public areas of a Class 3 or Class 9c *aged care building* being available on thermostatic control 24 hours per day; and
 - (iii) the internal heat gains in a building—
 - (A) from the occupants—
 - (aa) at a rate of 75 W per person *sensible heat gain* and 55 W per person *latent heat gain*; or
 - (bb) the average adjusted metabolic rate from Table 45 of AIRAH-DA09 (excluding sedentary work); or
 - (cc) the heat emission rate from Table 6.3 of CIBSE Guide A (excluding sedentary work),with the number of people calculated in accordance with **D1.13**; and
 - (B) from hot meals in a dining room, restaurant or cafe—
 - (aa) at a rate of 5 W per person *sensible heat gain* and 25 W per person *latent heat gain*; or
 - (bb) the average adjusted metabolic rate for sedentary work from Table 45 of AIRAH-DA09; or
 - (cc) the heat emission rate for sedentary work from Table 6.3 of CIBSE Guide A,with the number of people calculated in accordance with **D1.13**; and
 - (C) from appliances and equipment, in accordance with **Table 2h**; and
 - (D) from artificial lighting, that is calculated in **(b)**; and
- (b) for artificial lighting, must be calculated on the basis of the proposed level of artificial lighting in the building with the daily profile in **Tables 2a to 2g**.

Table 2a OCCUPANCY AND OPERATION PROFILES OF A CLASS 3 BUILDING OR CLASS 9c AGED CARE BUILDING

| Time period (local standard time) | Occupancy | | Artificial lighting | <i>Air-conditioning</i> | |
|--------------------------------------|---------------------|-------------------------------------|------------------------|-------------------------|-------------------------------------|
| | Monday to Friday | Saturday, Sunday and holidays | | Monday to Friday | Saturday, Sunday and holidays |
| 12:00am to 1:00am | 85% | 85% | 5% | On | On |
| 1:00am to 2:00am | 85% | 85% | 5% | On | On |
| 2:00am to 3:00am | 85% | 85% | 5% | On | On |
| 3:00am to 4:00am | 85% | 85% | 5% | On | On |
| 4:00am to 5:00am | 85% | 85% | 5% | On | On |
| 5:00am to 6:00am | 85% | 85% | 25% | On | On |
| 6:00am to 7:00am | 85% | 85% | 80% | On | On |
| 7:00am to 8:00am | 80% | 85% | 80% | On | On |
| 8:00am to 9:00am | 50% | 50% | 50% | On | On |
| 9:00am to 10:00am | 10% | 50% | 20% | Off | On |
| 10:00am to 11:00am | 10% | 20% | 20% | Off | Off |
| 11:00am to 12:00pm | 10% | 20% | 20% | Off | Off |
| 12:00pm to 1:00pm | 10% | 20% | 20% | Off | Off |
| 1:00pm to 2:00pm | 10% | 20% | 20% | Off | Off |
| 2:00pm to 3:00pm | 10% | 20% | 20% | Off | Off |
| 3:00pm to 4:00pm | 10% | 30% | 20% | Off | Off |
| 4:00pm to 5:00pm | 50% | 50% | 20% | On | On |
| 5:00pm to 6:00pm | 50% | 50% | 50% | On | On |
| 6:00pm to 7:00pm | 70% | 50% | 50% | On | On |
| 7:00pm to 8:00pm | 70% | 70% | 50% | On | On |
| 8:00pm to 9:00pm | 80% | 80% | 50% | On | On |
| 9:00pm to 10:00pm | 85% | 80% | 50% | On | On |
| 10:00pm to 11:00pm | 85% | 85% | 50% | On | On |
| 11:00pm to 12:00am | 85% | 85% | 5% | On | On |

Note: The occupancy profile is expressed as a percentage of the maximum number of people that can be accommodated in the Class 3 building or Class 9c *aged care building*. The artificial lighting profile is expressed as a percentage of the maximum *illumination power density* permitted under **Part J6**.

Table 2b OCCUPANCY AND OPERATION PROFILES OF A CLASS 5 BUILDING, A CLASS 8 LABORATORY OR A CLASS 9a CLINIC, DAY SURGERY OR PROCEDURE UNIT

| Time period (local standard time) | Occupancy (Monday to Friday) | Artificial lighting (Monday to Friday) | Appliances and equipment (Monday to Friday) | <i>Air-conditioning</i> (Monday to Friday) |
|--------------------------------------|---------------------------------|---|--|---|
| 12:00am to 1:00am | 0% | 10% | 10% | Off |
| 1:00am to 2:00am | 0% | 10% | 10% | Off |
| 2:00am to 3:00am | 0% | 10% | 10% | Off |
| 3:00am to 4:00am | 0% | 10% | 10% | Off |
| 4:00am to 5:00am | 0% | 10% | 10% | Off |
| 5:00am to 6:00am | 0% | 10% | 10% | Off |
| 6:00am to 7:00am | 0% | 10% | 10% | Off |
| 7:00am to 8:00am | 15% | 40% | 25% | On |
| 8:00am to 9:00am | 60% | 80% | 70% | On |
| 9:00am to 10:00am | 100% | 100% | 100% | On |
| 10:00am to 11:00am | 100% | 100% | 100% | On |
| 11:00am to 12:00pm | 100% | 100% | 100% | On |
| 12:00pm to 1:00pm | 100% | 100% | 100% | On |
| 1:00pm to 2:00pm | 100% | 100% | 100% | On |
| 2:00pm to 3:00pm | 100% | 100% | 100% | On |
| 3:00pm to 4:00pm | 100% | 100% | 100% | On |
| 4:00pm to 5:00pm | 100% | 100% | 100% | On |
| 5:00pm to 6:00pm | 50% | 80% | 60% | On |
| 6:00pm to 7:00pm | 15% | 60% | 25% | Off |
| 7:00pm to 8:00pm | 5% | 40% | 15% | Off |
| 8:00pm to 9:00pm | 5% | 20% | 15% | Off |
| 9:00pm to 10:00pm | 0% | 10% | 10% | Off |
| 10:00pm to 11:00pm | 0% | 10% | 10% | Off |
| 11:00pm to 12:00am | 0% | 10% | 10% | Off |

Notes:

1. The occupancy profile is expressed as a percentage of the maximum number of people that can be accommodated in the building. The artificial lighting profile is expressed as a percentage of the maximum *illumination power density* permitted under **Part J6**. The appliances and equipment profile is expressed as a percentage of the maximum internal heat gain in **Table 2h**. The *air-conditioning* profile is expressed as the plant status.
2. Saturday and Sunday profiles are 10% continuous artificial lighting and 10% continuous appliances and equipment. There is no occupancy and the *air-conditioning* is "off".

Table 2c OCCUPANCY AND OPERATION PROFILES OF A CLASS 6 SHOP OR SHOPPING CENTRE

| Time period (local standard time) | Occupancy (Daily) | Artificial lighting (Daily) | Appliances and equipment (Daily) | <i>Air- conditioning</i> (Daily) |
|--------------------------------------|----------------------|-----------------------------------|---|---|
| 12:00am to 1:00am | 0% | 10% | 10% | Off |
| 1:00am to 2:00am | 0% | 10% | 10% | Off |
| 2:00am to 3:00am | 0% | 10% | 10% | Off |
| 3:00am to 4:00am | 0% | 10% | 10% | Off |
| 4:00am to 5:00am | 0% | 10% | 10% | Off |
| 5:00am to 6:00am | 0% | 10% | 10% | Off |
| 6:00am to 7:00am | 0% | 10% | 10% | Off |
| 7:00am to 8:00am | 10% | 100% | 70% | On |
| 8:00am to 9:00am | 20% | 100% | 70% | On |
| 9:00am to 10:00am | 20% | 100% | 70% | On |
| 10:00am to 11:00am | 15% | 100% | 70% | On |
| 11:00am to 12:00pm | 25% | 100% | 70% | On |
| 12:00pm to 1:00pm | 25% | 100% | 70% | On |
| 1:00pm to 2:00pm | 15% | 100% | 70% | On |
| 2:00pm to 3:00pm | 15% | 100% | 70% | On |
| 3:00pm to 4:00pm | 15% | 100% | 70% | On |
| 4:00pm to 5:00pm | 15% | 100% | 70% | On |
| 5:00pm to 6:00pm | 5% | 100% | 70% | On |
| 6:00pm to 7:00pm | 5% | 100% | 70% | Off |
| 7:00pm to 8:00pm | 0% | 10% | 10% | Off |
| 8:00pm to 9:00pm | 0% | 10% | 10% | Off |
| 9:00pm to 10:00pm | 0% | 10% | 10% | Off |
| 10:00pm to 11:00pm | 0% | 10% | 10% | Off |
| 11:00pm to 12:00am | 0% | 10% | 10% | Off |

Note: The occupancy profile is expressed as a percentage of the maximum number of people that can be accommodated in the building. The artificial lighting profile is expressed as a percentage of the maximum *illumination power density* permitted under **Part J6**. The appliances and equipment profile is expressed as a percentage of the maximum internal heat gain in **Table 2h**. The *air-conditioning* profile is expressed as the plant status.

Table 2d OCCUPANCY AND OPERATION PROFILES OF A CLASS 6 RESTAURANT OR CAFE

| Time period (local standard time) | Occupancy (Monday to Saturday) | Artificial lighting (Monday to Saturday) | Appliances and equipment (Monday to Saturday) | <i>Air-conditioning</i> (Monday to Saturday) |
|--------------------------------------|-----------------------------------|---|--|---|
| 12:00am to 1:00am | 0% | 5% | 15% | Off |
| 1:00am to 2:00am | 0% | 5% | 15% | Off |
| 2:00am to 3:00am | 0% | 5% | 15% | Off |
| 3:00am to 4:00am | 0% | 5% | 15% | Off |
| 4:00am to 5:00am | 0% | 5% | 15% | Off |
| 5:00am to 6:00am | 0% | 5% | 15% | Off |
| 6:00am to 7:00am | 5% | 40% | 40% | Off |
| 7:00am to 8:00am | 5% | 40% | 40% | On |
| 8:00am to 9:00am | 5% | 60% | 60% | On |
| 9:00am to 10:00am | 5% | 60% | 60% | On |
| 10:00am to 11:00am | 20% | 90% | 90% | On |
| 11:00am to 12:00pm | 50% | 90% | 90% | On |
| 12:00pm to 1:00pm | 80% | 90% | 90% | On |
| 1:00pm to 2:00pm | 70% | 90% | 90% | On |
| 2:00pm to 3:00pm | 40% | 90% | 90% | On |
| 3:00pm to 4:00pm | 20% | 90% | 90% | On |
| 4:00pm to 5:00pm | 25% | 90% | 90% | On |
| 5:00pm to 6:00pm | 50% | 90% | 90% | On |
| 6:00pm to 7:00pm | 80% | 90% | 90% | On |
| 7:00pm to 8:00pm | 80% | 90% | 90% | On |
| 8:00pm to 9:00pm | 80% | 90% | 90% | On |
| 9:00pm to 10:00pm | 50% | 90% | 90% | On |
| 10:00pm to 11:00pm | 35% | 50% | 50% | On |
| 11:00pm to 12:00am | 20% | 30% | 30% | On |

Notes:

- The occupancy profile is expressed as a percentage of the maximum number of people that can be accommodated in the building. The artificial lighting profile is expressed as a percentage of the maximum *illumination power density* permitted under **Part J6**. The appliances and equipment profile is expressed as a percentage of the maximum internal heat gain in **Table 2h**. The *air-conditioning* profile is expressed as the plant status.
- Sunday profiles is 5% continuous artificial lighting and 5% continuous appliances and equipment. There is no occupancy and the *air-conditioning* is "off".

Table 2e OCCUPANCY AND OPERATION PROFILES OF A CLASS 9a WARD AREA

| Time period (local standard time) | Occupancy | | Artificial lighting | <i>Air-conditioning</i> | |
|--------------------------------------|---------------------|---------------------------|------------------------|-------------------------|---------------------------|
| | Monday to Friday | Saturday and Sunday | | Monday to Friday | Saturday and Sunday |
| 12:00am to 1:00am | 85% | 85% | 5% | On | On |
| 1:00am to 2:00am | 85% | 85% | 5% | On | On |
| 2:00am to 3:00am | 85% | 85% | 5% | On | On |
| 3:00am to 4:00am | 85% | 85% | 5% | On | On |
| 4:00am to 5:00am | 85% | 85% | 5% | On | On |
| 5:00am to 6:00am | 85% | 85% | 25% | On | On |
| 6:00am to 7:00am | 85% | 85% | 80% | On | On |
| 7:00am to 8:00am | 85% | 85% | 80% | On | On |
| 8:00am to 9:00am | 85% | 85% | 50% | On | On |
| 9:00am to 10:00am | 85% | 85% | 20% | On | On |
| 10:00am to 11:00am | 85% | 85% | 20% | On | On |
| 11:00am to 12:00pm | 85% | 85% | 20% | On | On |
| 12:00pm to 1:00pm | 85% | 85% | 20% | On | On |
| 1:00pm to 2:00pm | 85% | 85% | 20% | On | On |
| 2:00pm to 3:00pm | 85% | 85% | 20% | On | On |
| 3:00pm to 4:00pm | 85% | 85% | 20% | On | On |
| 4:00pm to 5:00pm | 85% | 85% | 20% | On | On |
| 5:00pm to 6:00pm | 85% | 85% | 50% | On | On |
| 6:00pm to 7:00pm | 85% | 85% | 50% | On | On |
| 7:00pm to 8:00pm | 85% | 85% | 50% | On | On |
| 8:00pm to 9:00pm | 85% | 85% | 50% | On | On |
| 9:00pm to 10:00pm | 85% | 85% | 50% | On | On |
| 10:00pm to 11:00pm | 85% | 85% | 50% | On | On |
| 11:00pm to 12:00am | 85% | 85% | 5% | On | On |

Note: The occupancy profile is expressed as a percentage of the maximum number of people that can be accommodated in the building. The artificial lighting profile is expressed as a percentage of the maximum *illumination power density* permitted under **Part J6**. The *air-conditioning* profile is expressed as the plant status.

Table 2f OCCUPANCY AND OPERATION PROFILES OF A CLASS 9b THEATRE OR CINEMA

| Time period (local standard time) | Occupancy | | Artificial lighting | | <i>Air-conditioning</i> | |
|--------------------------------------|---------------------|----------------|------------------------|----------------|-------------------------|----------------|
| | Monday to Friday | Sat. & Sun. | Monday to Friday | Sat. & Sun. | Monday to Friday | Sat. & Sun. |
| 12:00am to 1:00am | 0% | 0% | 5% | 5% | Off | Off |
| 1:00am to 2:00am | 0% | 0% | 5% | 5% | Off | Off |
| 2:00am to 3:00am | 0% | 0% | 5% | 5% | Off | Off |
| 3:00am to 4:00am | 0% | 0% | 5% | 5% | Off | Off |
| 4:00am to 5:00am | 0% | 0% | 5% | 5% | Off | Off |
| 5:00am to 6:00am | 0% | 0% | 5% | 5% | Off | Off |
| 6:00am to 7:00am | 0% | 0% | 5% | 5% | Off | Off |
| 7:00am to 8:00am | 0% | 0% | 5% | 5% | Off | On |
| 8:00am to 9:00am | 0% | 20% | 100% | 100% | Off | On |
| 9:00am to 10:00am | 0% | 80% | 10% | 10% | Off | On |
| 10:00am to 11:00am | 0% | 80% | 10% | 10% | Off | On |
| 11:00am to 12:00pm | 0% | 80% | 10% | 10% | On | On |
| 12:00pm to 1:00pm | 20% | 20% | 100% | 100% | On | On |
| 1:00pm to 2:00pm | 80% | 80% | 5% | 5% | On | On |
| 2:00pm to 3:00pm | 80% | 80% | 5% | 5% | On | On |
| 3:00pm to 4:00pm | 80% | 80% | 5% | 5% | On | On |
| 4:00pm to 5:00pm | 80% | 80% | 5% | 5% | On | On |
| 5:00pm to 6:00pm | 20% | 20% | 100% | 100% | On | On |
| 6:00pm to 7:00pm | 20% | 20% | 100% | 100% | On | On |
| 7:00pm to 8:00pm | 80% | 80% | 100% | 100% | On | On |
| 8:00pm to 9:00pm | 80% | 80% | 5% | 5% | On | On |
| 9:00pm to 10:00pm | 80% | 80% | 5% | 5% | On | On |
| 10:00pm to 11:00pm | 80% | 80% | 5% | 5% | On | On |
| 11:00pm to 12:00am | 10% | 10% | 100% | 100% | On | On |

Note: The occupancy profile is expressed as a percentage of the maximum number of people that can be accommodated in the building. The artificial lighting profile is expressed as a percentage of the maximum *illumination power density* permitted under **Part J6**. The *air-conditioning* profile is expressed as the plant status.

Table 2g OCCUPANCY AND OPERATION PROFILES OF A CLASS 9b SCHOOL

| Time period (local standard time) | Occupancy (Monday to Friday) | Artificial lighting (Monday to Friday) | Appliances and equipment (Monday to Friday) | <i>Air-conditioning</i> (Monday to Friday) |
|--------------------------------------|---------------------------------|---|--|---|
| 12:00am to 1:00am | 0% | 5% | 5% | Off |
| 1:00am to 2:00am | 0% | 5% | 5% | Off |
| 2:00am to 3:00am | 0% | 5% | 5% | Off |
| 3:00am to 4:00am | 0% | 5% | 5% | Off |
| 4:00am to 5:00am | 0% | 5% | 5% | Off |
| 5:00am to 6:00am | 0% | 5% | 5% | Off |
| 6:00am to 7:00am | 0% | 5% | 5% | Off |
| 7:00am to 8:00am | 5% | 30% | 30% | On |
| 8:00am to 9:00am | 75% | 85% | 85% | On |
| 9:00am to 10:00am | 90% | 95% | 95% | On |
| 10:00am to 11:00am | 90% | 95% | 95% | On |
| 11:00am to 12:00pm | 90% | 95% | 95% | On |
| 12:00pm to 1:00pm | 50% | 80% | 70% | On |
| 1:00pm to 2:00pm | 50% | 80% | 70% | On |
| 2:00pm to 3:00pm | 90% | 95% | 95% | On |
| 3:00pm to 4:00pm | 70% | 90% | 80% | On |
| 4:00pm to 5:00pm | 50% | 70% | 60% | On |
| 5:00pm to 6:00pm | 20% | 20% | 20% | Off |
| 6:00pm to 7:00pm | 20% | 20% | 20% | Off |
| 7:00pm to 8:00pm | 20% | 20% | 20% | Off |
| 8:00pm to 9:00pm | 10% | 10% | 10% | Off |
| 9:00pm to 10:00pm | 5% | 5% | 5% | Off |
| 10:00pm to 11:00pm | 5% | 5% | 5% | Off |
| 11:00pm to 12:00am | 5% | 5% | 5% | Off |

Notes:

- The occupancy profile is expressed as a percentage of the maximum number of people that can be accommodated in the building. The artificial lighting profile is expressed as a percentage of the maximum *illumination power density* permitted under **Part J6**. The appliances and equipment profile is expressed as a percentage of the maximum internal heat gain in **Table 2h**. The *air-conditioning* profile is expressed as the plant status.
- Saturday and Sunday profiles are 5% continuous artificial lighting and 5% continuous appliances and equipment. There is no occupancy and the *air-conditioning* is "off".

Table 2h INTERNAL HEAT GAINS FOR APPLIANCES AND EQUIPMENT

| Application | Internal sensible heat gain rate (W/m ²) |
|--|---|
| <i>Sole-occupancy unit</i> of a Class 3 building, a Class 9a building <i>ward area</i> or Class 9c <i>aged care building</i> | 5 W/m ² averaged for 24 hours per day, 7 days per week, continuous operation |
| Class 5 building, Class 8 laboratory and a Class 9a clinic, day surgery and a procedure unit. | 15 W/m ² |
| Class 6 shop and shopping centre, Class 6 cafe and restaurant and Class 9b <i>school</i> | 5 W/m ² |
| Other applications | No load |

Table 2i HOT WATER SUPPLY CONSUMPTION RATES

| Application | Daily consumption rate |
|---|----------------------------------|
| Residential part of a hotel or motel | 75 L/ <i>sole-occupancy unit</i> |
| Dormitory, boarding house, guest house, hostel, lodging house and backpackers accommodation | 50 L/person |
| Residential part of a <i>school</i> , accommodation for the aged, children or people with disabilities and a <i>detention centre</i> or a <i>health care building</i> which accommodates members of staff | |
| Class 9c <i>aged care building</i> | |
| Office, laboratory, shop and <i>assembly building</i> | 4 L/person |
| Dining room, restaurant and cafe | 9 L/meal |
| <i>Health care building ward area</i> | 70 L/patient |
| <i>School</i> | 7 L/person |
| Other applications | 4 L/person |

PART J0

ENERGY EFFICIENCY

Deemed-to-Satisfy Provisions

J0.0 Deemed-to-Satisfy Provisions

- (a) Where a *Building Solution* is proposed to comply with the *Deemed-to-Satisfy Provisions*, *Performance Requirements JP1* and *JP3* are satisfied by complying with—
- (i) **J0.1** to **J0.3**; and
 - (ii) **J1.1** to **J1.6**; and
 - (iii) **J2.1** to **J2.5**; and
 - (iv) **J3.1** to **J3.7**; and
 - (v) **J5.1** to **J5.5**; and
 - (vi) **J6.1** to **J6.6**; and
 - (vii) **J7.1** to **J7.4**.
- (b) Where a *Building Solution* is proposed as an *Alternative Solution* to the *Deemed-to-Satisfy Provisions* of—
- (i) **J0.1** to **J0.3**; and
 - (ii) **J1.1** to **J1.6**; and
 - (iii) **J2.1** to **J2.5**; and
 - (iv) **J3.1** to **J3.7**; and
 - (v) **J5.1** to **J5.5**; and
 - (vi) **J6.1** to **J6.6**; and
 - (vii) **J7.1** to **J7.4**,

the relevant *Performance Requirements* must be determined in accordance with **A0.10**.

J0.1 Application of Section J

Performance Requirements JP1, *JP2* and *JP3* are satisfied by complying with—

- (a) for reducing the heating or cooling loads—
- (i) of *sole-occupancy units* of a Class 2 building or a Class 4 part of a building, **J0.2** and **J0.3**; and
 - (ii) of a Class 2 to 9 building, other than the *sole-occupancy units* of a Class 2 building or a Class 4 part of a building, **Parts J1**, **J2** and **J3**; and
- (b) for *air-conditioning* and ventilation, **Part J5**; and
- (c) for artificial lighting and power, **Part J6**; and
- (d) for hot water supply and *swimming pool* and spa pool plant, **Part J7**; and
- (e) for facilities for maintenance and monitoring, **Part J8**.

Deemed-to-Satisfy Provisions

J0.2 Heating and cooling loads of sole-occupancy units of a Class 2 building or a Class 4 part

The *sole-occupancy units* of a Class 2 building or a Class 4 part of a building must—

- (a) for reducing the heating or cooling loads—
 - (i) collectively achieve an average energy rating of not less than 6 stars; and
 - (ii) individually achieve an energy rating of not less than 5 stars, using *house energy rating software*; and
- (b) for general thermal construction, comply with **J1.2**; and
- (c) for thermal breaks, comply with **J1.3(d)** and **J1.5(c)**; and
- (d) for compensating for a loss of ceiling insulation, comply with **J1.3(c)**; and
- (e) for floor edge insulation, comply with **J1.6(c)** and **J1.6(d)**; and
- (f) for building sealing, comply with **Part J3**.

J0.3 Ceiling fans

Ceiling fans *required* as part of compliance with **J0.2(a)**, must—

- (a) be permanently installed; and
- (b) have a speed controller; and
- (c) serve the whole room, with the *floor area* that a single fan serves not exceeding—
 - (i) 15 m² if it has a blade rotation diameter of not less than 900 mm; and
 - (ii) 25 m² if it has a blade rotation diameter of not less than 1200 mm.

PART J1 BUILDING FABRIC

Deemed-to-Satisfy Provisions

J1.0 Deemed-to-Satisfy Provisions

- (a) Where a *Building Solution* is proposed to comply with the *Deemed-to-Satisfy Provisions*, *Performance Requirements JP1* and *JP3* are satisfied by complying with—
- (i) **J0.1** to **J0.3**; and
 - (ii) **J1.1** to **J1.6**; and
 - (iii) **J2.1** to **J2.5**; and
 - (iv) **J3.1** to **J3.7**; and
 - (v) **J5.1** to **J5.5**; and
 - (vi) **J6.1** to **J6.6**; and
 - (vii) **J7.1** to **J7.4**.
- (b) Where a *Building Solution* is proposed as an *Alternative Solution* to the *Deemed-to-Satisfy Provisions* of—
- (i) **J0.1** to **J0.3**; and
 - (ii) **J1.1** to **J1.6**; and
 - (iii) **J2.1** to **J2.5**; and
 - (iv) **J3.1** to **J3.7**; and
 - (v) **J5.1** to **J5.5**; and
 - (vi) **J6.1** to **J6.6**; and
 - (vii) **J7.1** to **J7.4**,

the relevant *Performance Requirements* must be determined in accordance with **A0.10**.

J1.1 Application of Part

The *Deemed-to-Satisfy Provisions* of this Part apply to building elements forming the *envelope* of a Class 2 to 9 building.

J1.2 Thermal construction — general

- (a) Where *required*, insulation must comply with AS/NZS 4859.1 and be installed so that it—
- (i) abuts or overlaps adjoining insulation other than at supporting members such as studs, noggings, joists, furring channels and the like where the insulation must be against the member; and
 - (ii) forms a continuous barrier with ceilings, walls, bulkheads, floors or the like that inherently contribute to the thermal barrier; and
 - (iii) does not affect the safe or effective operation of a *service* or fitting.
- (b) Where *required*, *reflective insulation* must be installed with—

Deemed-to-Satisfy Provisions

- (i) the necessary airspace to achieve the *required R-Value* between a reflective side of the *reflective insulation* and a building lining or cladding; and
 - (ii) the *reflective insulation* closely fitted against any penetration, door or *window* opening; and
 - (iii) the *reflective insulation* adequately supported by framing members; and
 - (iv) each adjoining sheet of roll membrane being—
 - (A) overlapped not less than 50 mm; or
 - (B) taped together.
- (c) Where *required*, bulk insulation must be installed so that—
- (i) it maintains its position and thickness, other than where it is compressed between cladding and supporting members, water pipes, electrical cabling or the like; and
 - (ii) in a ceiling, where there is no bulk insulation or *reflective insulation* in the wall beneath, it overlaps the wall by not less than 50 mm.
- (d) Roof, ceiling, wall and floor materials, and associated surfaces are deemed to have the thermal properties listed in **Specification J1.2**.

J1.3 Roof and ceiling construction

- (a) A roof or ceiling that is part of the *envelope*, other than of a *sole-occupancy unit* of a Class 2 building or a Class 4 part of a building, must achieve the *Total R-Value* specified in **Table J1.3a** for the direction of heat flow.

Table J1.3a ROOFS AND CEILINGS - MINIMUM TOTAL R-VALUE FOR EACH CLIMATE ZONE

| <i>Climate zone</i> | 1, 2, 3, 4 and 5 | 6 | 7 | 8 |
|---|------------------------|-----|---------|-----|
| Direction of heat flow | Downwards | | Upwards | |
| Minimum <i>Total R-Value</i> for a roof or ceiling with a roof upper surface solar absorptance value of not more than 0.4 | 3.2 | 3.2 | 3.7 | 4.8 |
| Minimum <i>Total R-Value</i> for a roof or ceiling with a roof upper surface solar absorptance value of more than 0.4 but not more than 0.6 | 3.7 | 3.2 | 3.7 | 4.8 |
| Minimum <i>Total R-Value</i> for a roof or ceiling with a roof upper surface solar absorptance value of more than 0.6 | 4.2 | 3.2 | 3.7 | 4.8 |

- (b) For compliance with **Table J1.3a**, roof and ceiling construction is deemed to have the thermal properties listed in **Specification J1.3**.
- (c) Where, for operational or safety reasons associated with exhaust fans, flues or recessed downlights, the area of *required* ceiling insulation is reduced, the loss of insulation must be compensated for by increasing the *R-Value* of the insulation in the remainder of the ceiling in accordance with **Table J1.3b**.

Deemed-to-Satisfy Provisions

Table J1.3b ADJUSTMENT OF MINIMUM R-VALUE FOR LOSS OF CEILING INSULATION

| Percentage of ceiling area uninsulated | Minimum <i>R-Value</i> of ceiling insulation <i>required</i> to satisfy J1.3(a) | | | | | | | | | | |
|--|---|-----|-----|-----|-----|-----|-----|-----|-----|-----|-----|
| | 1.0 | 1.5 | 2.0 | 2.5 | 3.0 | 3.5 | 4.0 | 4.5 | 5.0 | 5.5 | 6.0 |
| | Adjusted minimum <i>R-Value</i> of ceiling insulation <i>required</i> to compensate for loss of ceiling insulation area | | | | | | | | | | |
| 0.5% to less than 1.0% | 1.0 | 1.6 | 2.2 | 2.8 | 3.4 | 4.0 | 4.7 | 5.4 | 6.2 | 6.9 | |
| 1.0% to less than 1.5% | 1.1 | 1.7 | 2.3 | 2.9 | 3.6 | 4.4 | 5.2 | 6.1 | 7.0 | | |
| 1.5% to less than 2.0% | 1.1 | 1.7 | 2.4 | 3.1 | 3.9 | 4.8 | 5.8 | 6.8 | | | |
| 2.0% to less than 2.5% | 1.1 | 1.8 | 2.5 | 3.3 | 4.2 | 5.3 | 6.5 | | | | |
| 2.5% to less than 3.0% | 1.2 | 1.9 | 2.6 | 3.6 | 4.6 | 5.9 | | | | | |
| 3.0% to less than 4.0% | 1.2 | 2.0 | 3.0 | 4.2 | 5.7 | | | | | | |
| 4.0% to less than 5.0% | 1.3 | 2.2 | 3.4 | 5.0 | | | | | | | |
| 5.0% or more | | | | | | | | | | | |
| Not Permitted | | | | | | | | | | | |

Note: Where the minimum *R-Value* of ceiling insulation *required* to satisfy J1.3(a) is between the values stated, interpolation may be used to determine the adjusted minimum *R-Value*.

- (d) A roof that—
- (i) is *required* to achieve a minimum *Total R-Value*; and
 - (ii) has metal sheet roofing fixed to metal purlins, metal rafters or metal battens; and
 - (iii) does not have a ceiling lining or has a ceiling lining fixed directly to those metal purlins, metal rafters or metal battens (see **Specification J1.3 Figure 2(c) and (f)**),
- must have a thermal break, consisting of a material with an *R-Value* of not less than R0.2, installed between the metal sheet roofing and its supporting metal purlins, metal rafters or metal battens.

SA J1.3(e)

J1.4 Roof lights

Roof lights, including any associated shaft and diffuser, that form part of the *envelope*, other than of a *sole-occupancy unit* of a Class 2 building or a Class 4 part of a building, must—

- (a) if the *roof lights* are not *required* for compliance with **Part F4**, comply with **Table J1.4**; or
- (b) if the *roof lights* are *required* for compliance with **Part F4**—
 - (i) have an area not more than 150% of the minimum area *required* by **F4.6**; and
 - (ii) have transparent and translucent elements, including any imperforate ceiling diffuser, with a combined performance of not more than—

Deemed-to-Satisfy Provisions

- (A) 0.29 *Total System SHGC*; and
- (B) 2.9 *Total System U-Value*.

Table J1.4 ROOF LIGHTS - THERMAL PERFORMANCE OF TRANSPARENT AND TRANSLUCENT ELEMENTS

| <i>Roof light shaft index (see Note 1)</i> | Constant | Total area of <i>roof lights</i> serving the room or space as a percentage of the <i>floor area</i> of the room or space | | | |
|--|-----------------------------|--|------------------------------|---------------------------|---------------------------|
| | | Up to 2% | More than 2% to and up to 3% | More than 3% and up to 4% | More than 4% and up to 5% |
| Less than 0.5 | <i>Total System SHGC</i> | Not more than 0.83 | Not more than 0.57 | Not more than 0.43 | Not more than 0.34 |
| | <i>Total System U-Value</i> | Not more than 8.5 | Not more than 5.7 | Not more than 4.3 | Not more than 3.4 |
| 0.5 to less than 1.0 | <i>Total System SHGC</i> | Not more than 0.83 | Not more than 0.72 | Not more than 0.54 | Not more than 0.43 |
| | <i>Total System U-Value</i> | Not more than 8.5 | Not more than 5.7 | Not more than 4.3 | Not more than 3.4 |
| 1.0 to less than 2.5 | <i>Total System SHGC</i> | Not more than 0.83 | Not more than 0.83 | Not more than 0.69 | Not more than 0.55 |
| | <i>Total System U-Value</i> | Not more than 8.5 | Not more than 5.7 | Not more than 4.3 | Not more than 3.4 |
| 2.5 and more | <i>Total System SHGC</i> | Not more than 0.83 | Not more than 0.83 | Not more than 0.83 | Not more than 0.83 |
| | <i>Total System U-Value</i> | Not more than 8.5 | Not more than 5.7 | Not more than 4.3 | Not more than 3.4 |

Notes:

1. The *roof light shaft index* is determined by measuring the distance from the centre of the shaft at the roof to the centre of the shaft at the ceiling level and dividing it by the average internal dimension of the shaft opening at the ceiling level (or the diameter for a circular shaft) in the same units of measurement.
2. The total area of *roof lights* is the combined area for all *roof lights* serving the room or space.
3. The area of a *roof light* is the area of the roof opening that allows light to enter the building.
4. The thermal performance of an imperforate ceiling diffuser may be included in the *Total System U-Value* and *Total System SHGC* of the *roof light*.
5. The total area of *roof lights* serving the room or space as a percentage of the *floor area* of the room or space must not exceed 5% unless allowed by **J1.4(b)**.

J1.5 Walls

- (a) Each part of an *external wall* that is part of the *envelope*, other than of a *sole-occupancy unit* of a Class 2 building or a Class 4 part of a building, must satisfy one of the options in **Table J1.5a** except for—
 - (i) opaque non-glazed openings in *external walls* such as doors (including garage doors), vents, penetrations, shutters and the like; and
 - (ii) *glazing*; and

Deemed-to-Satisfy Provisions

- (iii) an earth retaining wall or earth-berm, in other than *climate zone* 8.

Table J1.5a OPTIONS FOR EACH PART OF AN EXTERNAL WALL THAT IS PART OF AN ENVELOPE

| <i>Climate zone</i> | Options |
|---------------------|--|
| 1, 2 and 3 | <p>(a) (i) Achieve a minimum <i>Total R-Value</i> of 3.3.</p> <p>(ii) The minimum <i>Total R-Value</i> in (i) is reduced—</p> <p>(A) for a wall with a surface density of not less than 220 kg/m², by 0.5; and</p> <p>(B) for a wall that is—</p> <p>(aa) facing the south orientation as described in Figure J2.3, by 0.5; or</p> <p>(bb) shaded with a projection shade angle in accordance with Figure J1.5 of—</p> <p>(AA) 15 degrees to not more than 45 degrees, by 0.5; or</p> <p>(BB) more than 45 degrees, by 1.0; and</p> <p>(C) if the outer surface solar absorptance value is not more than 0.6, by 0.5.</p> |
| | <p>(b) Where the only space for insulation is provided by a furring channel, top hat section, batten or the like—</p> <p>(i) achieve a minimum <i>Total R-Value</i> of 1.4; and</p> <p>(ii) satisfy <i>glazing</i> energy index Option B of Table J2.4a.</p> |
| 4, 5 and 6 | <p>(a) (i) Achieve a minimum <i>Total R-Value</i> of 2.8.</p> <p>(ii) The minimum <i>Total R-Value</i> in (i) is reduced—</p> <p>(A) for a wall with a surface density of not less than 220 kg/m², by 0.5; and</p> <p>(B) for a wall that is—</p> <p>(aa) facing the south orientation as described in Figure J2.3, by 0.5; or</p> <p>(bb) shaded with a projection shade angle in accordance with Figure J1.5 of—</p> <p>(AA) 30 degrees to not more than 60 degrees, by 0.5; or</p> <p>(BB) more than 60 degrees, by 1.0.</p> |
| | <p>(b) Where the only space for insulation is provided by a furring channel, top hat section, batten or the like—</p> <p>(i) achieve a minimum <i>Total R-Value</i> of 1.4; and</p> <p>(ii) satisfy <i>glazing</i> energy index Option B of Table J2.4a.</p> |

Deemed-to-Satisfy Provisions

Table J1.5a OPTIONS FOR EACH PART OF AN EXTERNAL WALL THAT IS PART OF AN ENVELOPE— continued

| <i>Climate zone</i> | Options |
|---------------------|---|
| 7 | (a) Achieve a minimum <i>Total R-Value</i> of 2.8. (b) Where the only space for insulation is provided by a furring channel, top hat section, batten or the like— (i) achieve a minimum <i>Total R-Value</i> of 1.4; and (ii) satisfy <i>glazing</i> energy index Option B of Table J2.4a . |
| 8 | (a) Achieve a minimum <i>Total R-Value</i> of 3.8. (b) Where the wall is an earth retaining wall or earth-berm, achieve a minimum <i>Total R-Value</i> of 2.0. |

Figure J1.5

MEASUREMENT OF PROJECTION FOR WALL SHADING

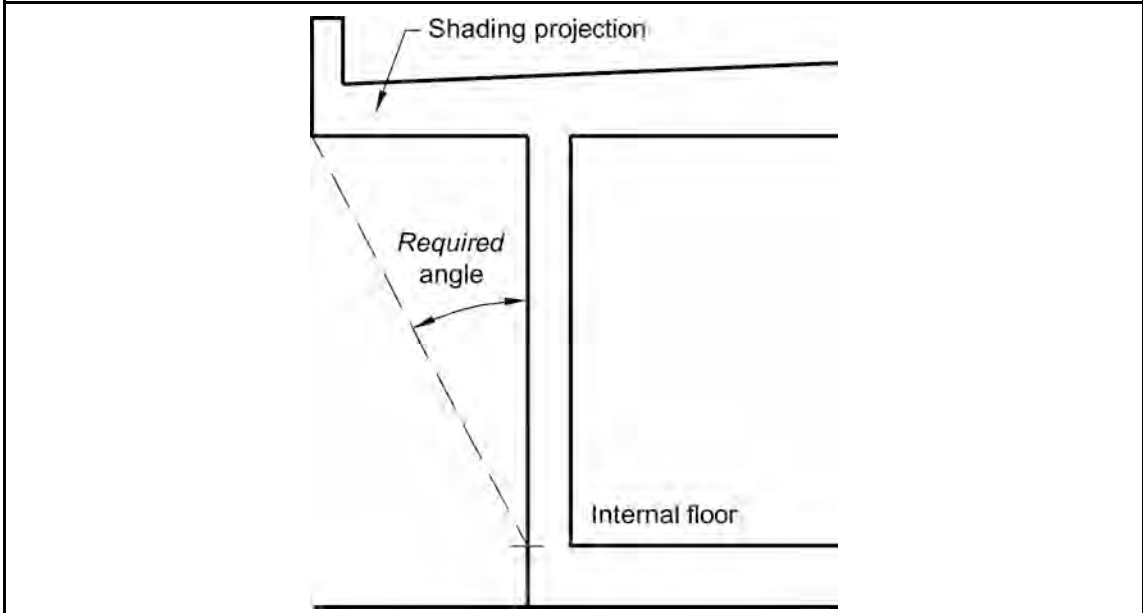

- (b) Any wall, other than an *external wall*, that is part of the *envelope* must achieve the *Total R-Value* in **Table J1.5b**.

Deemed-to-Satisfy Provisions

Table J1.5b AN ENVELOPE WALL OTHER THAN AN EXTERNAL WALL – MINIMUM TOTAL R-VALUE

| Location | <i>Climate zone</i> | | | | | | | |
|---|---------------------|-----|-----|-----|-----|-----|-----|-----|
| | 1 | 2 | 3 | 4 | 5 | 6 | 7 | 8 |
| (a) Where the adjacent enclosed non- <i>conditioned space</i> has— | | | | | | | | |
| (i) ventilation of not more than 1.5 air changes per hour of outside air during occupied hours; and | 1.0 | 1.0 | Nil | Nil | 1.0 | 1.0 | 1.5 | 2.5 |
| (ii) glazing in the external <i>fabric</i> as <i>required</i> by Part J2 ; and | | | | | | | | |
| (iii) <i>roof lights</i> in the external <i>fabric</i> as <i>required</i> by J1.4 . | | | | | | | | |
| (b) For other than (a) | 2.3 | 2.3 | 2.3 | 1.8 | 1.8 | 1.8 | 2.8 | 3.8 |
| Note: When assessing the glazing and <i>roof lights</i> as <i>required</i> by Part J2 and J1.4 , assess the glazing and <i>roof lights</i> as if the non- <i>conditioned space</i> is the same separate <i>conditioned space</i> . | | | | | | | | |

- (c) A wall that—
- (i) is *required* to achieve a minimum *Total R-Value*; and
 - (ii) has lightweight external cladding such as weatherboards, fibre-cement or metal sheeting fixed to a metal frame; and
 - (iii) does not have a wall lining or has a wall lining that is fixed directly to the same metal frame,
- must have a thermal break, consisting of a material with an *R-Value* of not less than R0.2, installed between the external cladding and the metal frame.
- (d) For compliance with **Table J1.5a** and **Table J1.5b**, wall construction is deemed to have the thermal properties listed in **Specification J1.5**.

J1.6 Floors

- (a) A floor that is part of the *envelope* of a building, other than a *sole-occupancy unit* of a Class 2 building or a Class 4 part of a building, including a floor above or below a *carpark* or a plant room—
- (i) must achieve the *Total R-Value* specified in **Table J1.6**; and
 - (ii) with an in-slab heating or cooling system, must be insulated around the vertical edge of its perimeter with insulation having an *R-Value* of not less than 1.0.
- (b) In *climate zones* 1 to 6, the minimum *Total R-Value required* in (a) may be reduced by R0.5 provided R0.75 is added to the *Total R-Value required* for the roof and ceiling construction.
- (c) A concrete slab-on-ground—
- (i) with an in-slab heating or cooling system; or
 - (ii) located in *climate zone* 8,

Deemed-to-Satisfy Provisions

must have insulation installed around the vertical edge of its perimeter.

- (d) Insulation *required* by (c) must—
- (i) have an *R-Value* of not less than 1.0; and
 - (ii) be water resistant; and
 - (iii) be continuous from the adjacent finished ground level—
 - (A) to a depth of not less than 300 mm; or
 - (B) for the full depth of the vertical edge of the concrete slab-on-ground.
- (e) Floor construction is deemed to have the thermal properties listed in **Specification J1.6**.

Table J1.6 FLOORS — MINIMUM TOTAL R-VALUE

| Location | Climate zone | | | | | | | |
|--|--------------|-----------------------|------|-----------|------|------|------|------|
| | 1 | 2 | 3 | 4 | 5 | 6 | 7 | 8 |
| Direction of heat flow | Upwards | Downwards and upwards | | Downwards | | | | |
| (a) A slab on ground: | | | | | | | | |
| (i) Without an in-slab heating or cooling system | Nil | Nil | Nil | Nil | Nil | Nil | 1.0 | 2.0 |
| (ii) With an in-slab heating or cooling system | 1.25 | 1.25 | 1.25 | 1.25 | 1.25 | 1.25 | 1.25 | 2.25 |
| (b) A suspended floor without an in-slab heating or cooling system where the non- <i>conditioned space</i> is— | | | | | | | | |
| (i) enclosed; and | | | | | | | | |
| (ii) where mechanically ventilated by not more than 1.5 air changes per hour. | 1.0 | 1.0 | Nil | Nil | 1.0 | 1.0 | 1.5 | 2.5 |
| (c) A suspended floor with an in-slab heating or cooling system where the non- <i>conditioned space</i> is— | | | | | | | | |
| (i) enclosed; and | | | | | | | | |
| (ii) where mechanically ventilated by not more than 1.5 air changes per hour | 1.25 | 1.25 | 1.25 | 1.25 | 1.25 | 1.25 | 1.75 | 2.75 |

Deemed-to-Satisfy Provisions

Table J1.6 FLOORS — MINIMUM TOTAL R-VALUE — continued

| Location | Climate zone | | | | | | | |
|--|--------------|-----------------------|-----|-----------|-----|-----|-----|-----|
| | 1 | 2 | 3 | 4 | 5 | 6 | 7 | 8 |
| Direction of heat flow | Upwards | Downwards and upwards | | Downwards | | | | |
| (d) For other than (a), (b) or (c) | 2.0 | 2.0 | 2.0 | 2.0 | 2.0 | 2.0 | 2.0 | 3.5 |
| <p>Note: A sub-floor space with not more than 150% of the <i>required</i> sub-floor ventilation is considered enclosed.</p> | | | | | | | | |

PART J2

GLAZING

Deemed-to-Satisfy Provisions

J2.0 Deemed-to-Satisfy Provisions

- (a) Where a *Building Solution* is proposed to comply with the *Deemed-to-Satisfy Provisions*, *Performance Requirements JP1* and *JP3* are satisfied by complying with—
- (i) **J0.1** to **J0.3**; and
 - (ii) **J1.1** to **J1.6**; and
 - (iii) **J2.1** to **J2.5**; and
 - (iv) **J3.1** to **J3.7**; and
 - (v) **J5.1** to **J5.5**; and
 - (vi) **J6.1** to **J6.6**; and
 - (vii) **J7.1** to **J7.4**.
- (b) Where a *Building Solution* is proposed as an *Alternative Solution* to the *Deemed-to-Satisfy Provisions* of—
- (i) **J0.1** to **J0.3**; and
 - (ii) **J1.1** to **J1.6**; and
 - (iii) **J2.1** to **J2.5**; and
 - (iv) **J3.1** to **J3.7**; and
 - (v) **J5.1** to **J5.5**; and
 - (vi) **J6.1** to **J6.6**; and
 - (vii) **J7.1** to **J7.4**,

the relevant *Performance Requirements* must be determined in accordance with **A0.10**.

J2.1 Application of Part

The *Deemed-to-Satisfy Provisions* of this Part apply to elements forming the *envelope* of a building other than a *sole-occupancy unit* of a Class 2 building or a Class 4 part of a building.

J2.2 * * * * *

This clause has deliberately been left blank.

J2.3 * * * * *

This clause has deliberately been left blank.

Deemed-to-Satisfy Provisions

J2.4 Glazing

- (a) The *glazing* in each *storey*, including any *mezzanine*, of a building must be assessed separately in accordance with (b) and (c) for—
- (i) *glazing* in the external *fabric* facing each orientation; and
 - (ii) *glazing* with a P/H value of not less than 2 in the internal *fabric* using the south orientation sector energy constants in Table J2.4b and shading multipliers in Table J2.4c and Table J2.4d; and
 - (iii) *glazing* with a P/H value of less than 2 in the internal *fabric* as for *glazing* in the external *fabric* in accordance with (i).
- (b) The aggregate *air-conditioning* energy value attributable to the *glazing* must not exceed the allowance obtained by multiplying the facade area that is exposed to the *conditioned space* for the orientation by the energy index in Table J2.4a.

Table J2.4a ENERGY INDEX

| Application | Energy index option | Climate zone | | | | | | | |
|--|---------------------|--------------|-------|-------|-------|-------|-------|-------|----------------|
| | | 1 | 2 | 3 | 4 | 5 | 6 | 7 | 8 |
| <i>Glazing</i> in a Class 3 building and a Class 9c <i>aged care building</i> | A | 0.067 | 0.132 | 0.091 | 0.086 | 0.092 | 0.090 | 0.059 | 0.027 |
| | B | 0.060 | 0.124 | 0.078 | 0.063 | 0.071 | 0.061 | 0.037 | Not applicable |
| Display <i>glazing</i> in a shop or showroom | A | 0.180 | 0.217 | 0.221 | 0.227 | 0.257 | 0.220 | 0.170 | 0.046 |
| | B | 0.173 | 0.209 | 0.208 | 0.204 | 0.236 | 0.191 | 0.148 | Not applicable |
| <i>Glazing</i> in other than, a Class 3 building, a Class 9c <i>aged care building</i> or display <i>glazing</i> in a shop or showroom | A | 0.130 | 0.181 | 0.172 | 0.142 | 0.175 | 0.116 | 0.083 | 0.023 |
| | B | 0.123 | 0.173 | 0.159 | 0.113 | 0.145 | 0.082 | 0.058 | Not applicable |

Note:

Option A applies to all *glazing* other than where compliance with Option B is *required* by Table J1.5a.

- (c) The aggregate *air-conditioning* energy value must be calculated by adding the *air-conditioning* energy value through each *glazing* element in accordance with the following formula:

$$A_1[\text{SHGC}_1(\text{C}_A \times \text{S}_{\text{H1}} + \text{C}_B \times \text{S}_{\text{C1}}) + \text{C}_C \times \text{U}_1] + A_2[\text{SHGC}_2(\text{C}_A \times \text{S}_{\text{H2}} + \text{C}_B \times \text{S}_{\text{C2}}) + \text{C}_C \times \text{U}_2] + \dots$$

where—

$A_{1, 2, \text{ etc}}$ = the area of each *glazing* element; and

Deemed-to-Satisfy Provisions

- $C_{A, B \text{ and } C}$ = the energy constants A, B and C for the specific orientation from **Table J2.4b**; and
- $SHGC_{1, 2, \text{ etc}}$ = the *Total System SHGC* of each *glazing* element; and
- $S_{H1, 2, \text{ etc}}$ = the heating shading multiplier for each *glazing* element obtained from **Table J2.4c**; and
- $S_{C1, 2, \text{ etc}}$ = the cooling shading multiplier for each *glazing* element obtained from **Table J2.4d**; and
- $U_{1, 2, \text{ etc}}$ = the *Total System U-Value* of each *glazing* element.

(d) For the purposes of (c), where the *air-conditioning* energy value of a *glazing* element is calculated to be negative, it must be taken to be zero.

Table J2.4b ENERGY CONSTANTS (C_A , C_B AND C_C)

| Climate zone | Energy constants | Orientation Sector (refer Figure J2.3) | | | | | | | |
|--------------|------------------|--|------------|-------|------------|-------|------------|-------|------------|
| | | North | North east | East | South east | South | South west | West | North west |
| 1 | C_A | 0.00 | 0.00 | 0.00 | 0.00 | 0.00 | 0.00 | 0.00 | 0.00 |
| | C_B | 0.80 | 0.92 | 0.91 | 0.67 | 0.48 | 0.67 | 0.88 | 0.91 |
| | C_C | 0.02 | 0.02 | 0.02 | 0.02 | 0.02 | 0.02 | 0.02 | 0.02 |
| 2 | C_A | 0.00 | 0.00 | 0.00 | 0.00 | 0.00 | 0.00 | 0.00 | 0.00 |
| | C_B | 1.20 | 1.40 | 1.31 | 0.84 | 0.48 | 0.70 | 1.03 | 1.17 |
| | C_C | -0.01 | -0.01 | -0.01 | 0.00 | 0.00 | 0.00 | -0.01 | -0.01 |
| 3 | C_A | 0.00 | 0.00 | 0.00 | 0.00 | 0.00 | 0.00 | 0.00 | 0.00 |
| | C_B | 1.01 | 1.16 | 1.08 | 0.69 | 0.41 | 0.67 | 1.01 | 1.09 |
| | C_C | 0.01 | 0.01 | 0.01 | 0.02 | 0.01 | 0.01 | 0.01 | 0.01 |
| 4 | C_A | -0.16 | -0.18 | -0.30 | -0.44 | -0.45 | -0.46 | -0.40 | -0.26 |
| | C_B | 1.25 | 1.37 | 1.18 | 0.68 | 0.35 | 0.60 | 0.98 | 1.20 |
| | C_C | 0.00 | 0.00 | 0.03 | 0.07 | 0.09 | 0.08 | 0.04 | 0.02 |
| 5 | C_A | -0.06 | -0.09 | -0.18 | -0.41 | -0.47 | -0.43 | -0.28 | -0.14 |
| | C_B | 1.46 | 1.55 | 1.32 | 0.75 | 0.41 | 0.68 | 1.13 | 1.38 |
| | C_C | -0.02 | -0.01 | 0.00 | 0.05 | 0.07 | 0.05 | 0.02 | -0.01 |
| 6 | C_A | -0.37 | -0.38 | -0.59 | -0.82 | -0.87 | -0.90 | -0.85 | -0.61 |
| | C_B | 1.53 | 1.66 | 1.39 | 0.80 | 0.38 | 0.66 | 1.07 | 1.34 |
| | C_C | -0.01 | -0.01 | 0.03 | 0.11 | 0.15 | 0.13 | 0.08 | 0.03 |
| 7 | C_A | -0.41 | -0.43 | -0.70 | -0.76 | -0.74 | -0.85 | -0.92 | -0.71 |
| | C_B | 1.32 | 1.39 | 1.09 | 0.59 | 0.25 | 0.47 | 0.81 | 1.09 |
| | C_C | 0.00 | 0.01 | 0.06 | 0.13 | 0.16 | 0.15 | 0.11 | 0.05 |

Deemed-to-Satisfy Provisions

Table J2.4b ENERGY CONSTANTS (C_A , C_B AND C_C)— continued

| Climate zone | Energy constants | Orientation Sector (refer Figure J2.3) | | | | | | | |
|--------------|------------------|--|------------|-------|------------|-------|------------|-------|------------|
| | | North | North east | East | South east | South | South west | West | North west |
| 8 | C_A | -0.87 | -0.81 | -0.75 | -0.61 | -0.73 | -0.75 | -0.87 | -0.92 |
| | C_B | 0.55 | 0.61 | 0.52 | 0.28 | 0.10 | 0.26 | 0.46 | 0.54 |
| | C_C | 0.13 | 0.12 | 0.14 | 0.17 | 0.20 | 0.19 | 0.22 | 0.15 |

Table J2.4c HEATING SHADING MULTIPLIER (S_H)

| G (refer Figure J2.4) | P/H (refer Figure J2.4) | Orientation Sector (refer Figure J2.3) | | | | | | | |
|--|----------------------------|--|------------|------|------------|-------|------------|------|------------|
| | | North | North east | East | South east | South | South west | West | North west |
| CLIMATE ZONES 1, 2 AND 3 | | | | | | | | | |
| In <i>climate zones</i> 1, 2 and 3, the heating shading multiplier is to be taken as 1.0 | | | | | | | | | |
| CLIMATE ZONES 4 AND 5 | | | | | | | | | |
| Not more than 100 mm | 0.0 | 1.00 | 1.00 | 1.00 | 1.00 | 1.00 | 1.00 | 1.00 | 1.00 |
| | 0.2 | 0.96 | 0.95 | 0.92 | 0.90 | 0.94 | 0.92 | 0.92 | 0.95 |
| | 0.4 | 0.86 | 0.83 | 0.79 | 0.78 | 0.87 | 0.83 | 0.80 | 0.85 |
| | 0.6 | 0.66 | 0.65 | 0.63 | 0.69 | 0.81 | 0.74 | 0.66 | 0.70 |
| | 0.8 | 0.30 | 0.41 | 0.43 | 0.62 | 0.77 | 0.66 | 0.50 | 0.47 |
| | 1.0 | 0.00 | 0.08 | 0.22 | 0.56 | 0.74 | 0.60 | 0.35 | 0.15 |
| | 1.2 | 0.00 | 0.00 | 0.08 | 0.52 | 0.71 | 0.54 | 0.21 | 0.00 |
| | 1.4 | 0.00 | 0.00 | 0.04 | 0.48 | 0.69 | 0.50 | 0.12 | 0.00 |
| | 1.6 | 0.00 | 0.00 | 0.02 | 0.45 | 0.67 | 0.46 | 0.08 | 0.00 |
| | 1.8 | 0.00 | 0.00 | 0.01 | 0.42 | 0.66 | 0.43 | 0.04 | 0.00 |
| 2.0 | 0.00 | 0.00 | 0.00 | 0.39 | 0.64 | 0.39 | 0.00 | 0.00 | |
| More than 100 mm but not more than 500 mm | 0.0 | 1.00 | 1.00 | 1.00 | 1.00 | 1.00 | 1.00 | 1.00 | 1.00 |
| | 0.2 | 0.99 | 0.99 | 0.98 | 0.97 | 0.98 | 0.97 | 0.98 | 0.99 |
| | 0.4 | 0.97 | 0.95 | 0.92 | 0.89 | 0.93 | 0.91 | 0.92 | 0.96 |
| | 0.6 | 0.91 | 0.88 | 0.84 | 0.81 | 0.88 | 0.85 | 0.85 | 0.90 |
| | 0.8 | 0.79 | 0.78 | 0.73 | 0.70 | 0.84 | 0.79 | 0.75 | 0.81 |
| | 1.0 | 0.59 | 0.63 | 0.62 | 0.67 | 0.80 | 0.73 | 0.65 | 0.69 |
| | 1.2 | 0.27 | 0.45 | 0.48 | 0.63 | 0.78 | 0.68 | 0.54 | 0.50 |
| | 1.4 | 0.03 | 0.28 | 0.35 | 0.59 | 0.75 | 0.63 | 0.44 | 0.31 |
| | 1.6 | 0.02 | 0.19 | 0.25 | 0.56 | 0.74 | 0.59 | 0.34 | 0.21 |
| | 1.8 | 0.01 | 0.09 | 0.14 | 0.52 | 0.72 | 0.55 | 0.25 | 0.10 |
| 2.0 | 0.00 | 0.00 | 0.03 | 0.49 | 0.70 | 0.51 | 0.15 | 0.00 | |

Deemed-to-Satisfy Provisions

Table J2.4c HEATING SHADING MULTIPLIER (S_H)— continued

| G (refer Figure J2.4) | P/H (refer Figure J2.4) | Orientation Sector (refer Figure J2.3) | | | | | | | |
|--|----------------------------|--|------------|------|------------|-------|------------|------|------------|
| | | North | North east | East | South east | South | South west | West | North west |
| More than 500 mm but not more than 1200 mm | 0.0 | 1.00 | 1.00 | 1.00 | 1.00 | 1.00 | 1.00 | 1.00 | 1.00 |
| | 0.2 | 1.00 | 1.00 | 0.99 | 0.99 | 0.99 | 0.99 | 0.99 | 0.99 |
| | 0.4 | 0.99 | 0.98 | 0.97 | 0.97 | 0.97 | 0.96 | 0.97 | 0.99 |
| | 0.6 | 0.98 | 0.97 | 0.94 | 0.92 | 0.95 | 0.93 | 0.94 | 0.97 |
| | 0.8 | 0.95 | 0.94 | 0.90 | 0.88 | 0.92 | 0.89 | 0.90 | 0.94 |
| | 1.0 | 0.91 | 0.89 | 0.84 | 0.83 | 0.89 | 0.85 | 0.84 | 0.90 |
| | 1.2 | 0.82 | 0.82 | 0.78 | 0.78 | 0.86 | 0.82 | 0.78 | 0.84 |
| | 1.4 | 0.67 | 0.71 | 0.70 | 0.73 | 0.84 | 0.78 | 0.71 | 0.75 |
| | 1.6 | 0.45 | 0.58 | 0.60 | 0.70 | 0.81 | 0.74 | 0.64 | 0.62 |
| | 1.8 | 0.22 | 0.44 | 0.51 | 0.66 | 0.79 | 0.71 | 0.56 | 0.48 |
| | 2.0 | 0.00 | 0.30 | 0.42 | 0.62 | 0.77 | 0.67 | 0.49 | 0.35 |
| More than 1200 mm but less than 1800 mm | 0.0 | 1.00 | 1.00 | 1.00 | 1.00 | 1.00 | 1.00 | 1.00 | 1.00 |
| | 0.2 | 1.00 | 1.00 | 1.00 | 1.00 | 1.00 | 1.00 | 1.00 | 1.00 |
| | 0.4 | 1.00 | 0.99 | 0.99 | 0.98 | 0.99 | 0.98 | 0.98 | 0.99 |
| | 0.6 | 0.99 | 0.98 | 0.97 | 0.96 | 0.97 | 0.96 | 0.97 | 0.98 |
| | 0.8 | 0.98 | 0.97 | 0.95 | 0.93 | 0.95 | 0.93 | 0.94 | 0.97 |
| | 1.0 | 0.97 | 0.95 | 0.92 | 0.90 | 0.93 | 0.91 | 0.91 | 0.95 |
| | 1.2 | 0.94 | 0.92 | 0.88 | 0.87 | 0.91 | 0.88 | 0.87 | 0.93 |
| | 1.4 | 0.88 | 0.87 | 0.83 | 0.83 | 0.89 | 0.85 | 0.83 | 0.88 |
| | 1.6 | 0.77 | 0.80 | 0.77 | 0.80 | 0.87 | 0.82 | 0.77 | 0.83 |
| | 1.8 | 0.66 | 0.73 | 0.71 | 0.77 | 0.86 | 0.79 | 0.72 | 0.77 |
| | 2.0 | 0.56 | 0.66 | 0.66 | 0.73 | 0.84 | 0.77 | 0.67 | 0.71 |

Deemed-to-Satisfy Provisions

Table J2.4c HEATING SHADING MULTIPLIER (S_H)— continued

| G (refer Figure J2.4) | P/H (refer Figure J2.4) | Orientation Sector (refer Figure J2.3) | | | | | | | |
|---|----------------------------|--|------------|------|------------|-------|------------|------|------------|
| | | North | North east | East | South east | South | South west | West | North west |
| CLIMATE ZONES 6 AND 7 | | | | | | | | | |
| Not more than 100 mm | 0.0 | 1.00 | 1.00 | 1.00 | 1.00 | 1.00 | 1.00 | 1.00 | 1.00 |
| | 0.2 | 0.95 | 0.93 | 0.91 | 0.90 | 0.93 | 0.91 | 0.91 | 0.93 |
| | 0.4 | 0.82 | 0.82 | 0.78 | 0.79 | 0.86 | 0.81 | 0.78 | 0.80 |
| | 0.6 | 0.61 | 0.66 | 0.64 | 0.70 | 0.80 | 0.71 | 0.64 | 0.62 |
| | 0.8 | 0.31 | 0.46 | 0.49 | 0.63 | 0.74 | 0.63 | 0.52 | 0.41 |
| | 1.0 | 0.02 | 0.23 | 0.35 | 0.58 | 0.70 | 0.56 | 0.40 | 0.17 |
| | 1.2 | 0.00 | 0.04 | 0.23 | 0.53 | 0.66 | 0.51 | 0.30 | 0.02 |
| | 1.4 | 0.00 | 0.00 | 0.14 | 0.49 | 0.63 | 0.47 | 0.22 | 0.00 |
| | 1.6 | 0.00 | 0.00 | 0.10 | 0.45 | 0.60 | 0.44 | 0.16 | 0.00 |
| | 1.8 | 0.00 | 0.00 | 0.05 | 0.41 | 0.58 | 0.41 | 0.11 | 0.00 |
| | 2.0 | 0.00 | 0.00 | 0.01 | 0.37 | 0.55 | 0.38 | 0.05 | 0.00 |
| More than 100 mm but not more than 500 mm | 0.0 | 1.00 | 1.00 | 1.00 | 1.00 | 1.00 | 1.00 | 1.00 | 1.00 |
| | 0.2 | 0.99 | 0.99 | 0.98 | 0.97 | 0.97 | 0.97 | 0.97 | 0.98 |
| | 0.4 | 0.96 | 0.94 | 0.91 | 0.89 | 0.93 | 0.91 | 0.91 | 0.94 |
| | 0.6 | 0.88 | 0.87 | 0.83 | 0.82 | 0.87 | 0.84 | 0.82 | 0.86 |
| | 0.8 | 0.75 | 0.78 | 0.73 | 0.70 | 0.83 | 0.76 | 0.71 | 0.75 |
| | 1.0 | 0.57 | 0.66 | 0.62 | 0.68 | 0.78 | 0.69 | 0.61 | 0.60 |
| | 1.2 | 0.33 | 0.51 | 0.51 | 0.64 | 0.75 | 0.63 | 0.52 | 0.44 |
| | 1.4 | 0.14 | 0.37 | 0.42 | 0.60 | 0.72 | 0.59 | 0.44 | 0.30 |
| | 1.6 | 0.10 | 0.25 | 0.33 | 0.57 | 0.69 | 0.55 | 0.36 | 0.20 |
| | 1.8 | 0.05 | 0.12 | 0.25 | 0.53 | 0.67 | 0.51 | 0.29 | 0.10 |
| | 2.0 | 0.00 | 0.00 | 0.17 | 0.50 | 0.64 | 0.48 | 0.21 | 0.00 |

SUPERSEDED
ENERGY EFFICIENCY

Deemed-to-Satisfy Provisions

Table J2.4c HEATING SHADING MULTIPLIER (S_H)— continued

| G (refer Figure J2.4) | P/H (refer Figure J2.4) | Orientation Sector (refer Figure J2.3) | | | | | | | |
|--|----------------------------|--|------------|------|------------|-------|------------|------|------------|
| | | North | North east | East | South east | South | South west | West | North west |
| More than 500 mm but not more than 1200 mm | 0.0 | 1.00 | 1.00 | 1.00 | 1.00 | 1.00 | 1.00 | 1.00 | 1.00 |
| | 0.2 | 1.00 | 0.99 | 0.99 | 0.99 | 0.99 | 0.99 | 0.99 | 0.99 |
| | 0.4 | 0.99 | 0.98 | 0.97 | 0.96 | 0.97 | 0.96 | 0.96 | 0.98 |
| | 0.6 | 0.97 | 0.96 | 0.93 | 0.92 | 0.94 | 0.92 | 0.92 | 0.96 |
| | 0.8 | 0.94 | 0.93 | 0.89 | 0.87 | 0.91 | 0.88 | 0.87 | 0.92 |
| | 1.0 | 0.88 | 0.88 | 0.83 | 0.82 | 0.87 | 0.83 | 0.81 | 0.86 |
| | 1.2 | 0.79 | 0.82 | 0.77 | 0.77 | 0.85 | 0.79 | 0.75 | 0.79 |
| | 1.4 | 0.66 | 0.73 | 0.69 | 0.73 | 0.82 | 0.75 | 0.68 | 0.69 |
| | 1.6 | 0.48 | 0.63 | 0.62 | 0.69 | 0.79 | 0.70 | 0.61 | 0.57 |
| | 1.8 | 0.30 | 0.53 | 0.54 | 0.66 | 0.76 | 0.66 | 0.55 | 0.45 |
| | 2.0 | 0.13 | 0.42 | 0.47 | 0.63 | 0.74 | 0.62 | 0.48 | 0.33 |
| More than 1200 mm but less than 1800 mm | 0.0 | 1.00 | 1.00 | 1.00 | 1.00 | 1.00 | 1.00 | 1.00 | 1.00 |
| | 0.2 | 1.00 | 1.00 | 1.00 | 1.00 | 1.00 | 0.99 | 0.99 | 1.00 |
| | 0.4 | 0.99 | 0.99 | 0.98 | 0.98 | 0.98 | 0.98 | 0.98 | 0.99 |
| | 0.6 | 0.99 | 0.98 | 0.97 | 0.96 | 0.96 | 0.95 | 0.96 | 0.98 |
| | 0.8 | 0.98 | 0.96 | 0.94 | 0.93 | 0.94 | 0.93 | 0.93 | 0.96 |
| | 1.0 | 0.96 | 0.94 | 0.91 | 0.89 | 0.92 | 0.90 | 0.89 | 0.93 |
| | 1.2 | 0.92 | 0.91 | 0.87 | 0.86 | 0.90 | 0.86 | 0.84 | 0.89 |
| | 1.4 | 0.85 | 0.87 | 0.82 | 0.82 | 0.87 | 0.83 | 0.80 | 0.84 |
| | 1.6 | 0.76 | 0.81 | 0.77 | 0.79 | 0.85 | 0.80 | 0.74 | 0.77 |
| | 1.8 | 0.67 | 0.75 | 0.72 | 0.75 | 0.83 | 0.77 | 0.69 | 0.69 |
| | 2.0 | 0.57 | 0.69 | 0.67 | 0.72 | 0.81 | 0.74 | 0.64 | 0.62 |

Deemed-to-Satisfy Provisions

Table J2.4c HEATING SHADING MULTIPLIER (S_H)— continued

| G (refer Figure J2.4) | P/H (refer Figure J2.4) | Orientation Sector (refer Figure J2.3) | | | | | | | |
|---|----------------------------|--|------------|------|------------|-------|------------|------|------------|
| | | North | North east | East | South east | South | South west | West | North west |
| CLIMATE ZONE 8 | | | | | | | | | |
| Not more than 100 mm | 0.0 | 1.00 | 1.00 | 1.00 | 1.00 | 1.00 | 1.00 | 1.00 | 1.00 |
| | 0.2 | 0.90 | 0.91 | 0.90 | 0.93 | 0.93 | 0.91 | 0.92 | 0.91 |
| | 0.4 | 0.73 | 0.77 | 0.77 | 0.89 | 0.85 | 0.80 | 0.80 | 0.77 |
| | 0.6 | 0.55 | 0.63 | 0.68 | 0.83 | 0.77 | 0.72 | 0.68 | 0.62 |
| | 0.8 | 0.37 | 0.50 | 0.61 | 0.75 | 0.71 | 0.67 | 0.57 | 0.48 |
| | 1.0 | 0.19 | 0.35 | 0.53 | 0.67 | 0.66 | 0.64 | 0.49 | 0.37 |
| | 1.2 | 0.07 | 0.22 | 0.44 | 0.60 | 0.62 | 0.62 | 0.43 | 0.29 |
| | 1.4 | 0.00 | 0.12 | 0.36 | 0.53 | 0.59 | 0.59 | 0.38 | 0.21 |
| | 1.6 | 0.00 | 0.08 | 0.29 | 0.48 | 0.56 | 0.56 | 0.34 | 0.15 |
| | 1.8 | 0.00 | 0.04 | 0.23 | 0.43 | 0.53 | 0.52 | 0.31 | 0.09 |
| 2.0 | 0.00 | 0.00 | 0.16 | 0.38 | 0.51 | 0.48 | 0.27 | 0.04 | |
| More than 100 mm but not more than 500 mm | 0.0 | 1.00 | 1.00 | 1.00 | 1.00 | 1.00 | 1.00 | 1.00 | 1.00 |
| | 0.2 | 0.96 | 0.96 | 0.95 | 0.95 | 0.96 | 0.95 | 0.96 | 0.96 |
| | 0.4 | 0.87 | 0.89 | 0.87 | 0.91 | 0.90 | 0.87 | 0.89 | 0.88 |
| | 0.6 | 0.73 | 0.79 | 0.78 | 0.87 | 0.85 | 0.81 | 0.81 | 0.78 |
| | 0.8 | 0.57 | 0.67 | 0.70 | 0.81 | 0.79 | 0.73 | 0.72 | 0.66 |
| | 1.0 | 0.42 | 0.56 | 0.64 | 0.79 | 0.75 | 0.69 | 0.63 | 0.54 |
| | 1.2 | 0.27 | 0.45 | 0.59 | 0.74 | 0.71 | 0.66 | 0.55 | 0.43 |
| | 1.4 | 0.17 | 0.32 | 0.52 | 0.67 | 0.67 | 0.63 | 0.49 | 0.35 |
| | 1.6 | 0.10 | 0.22 | 0.46 | 0.62 | 0.64 | 0.62 | 0.44 | 0.28 |
| | 1.8 | 0.03 | 0.13 | 0.39 | 0.57 | 0.62 | 0.61 | 0.40 | 0.22 |
| 2.0 | 0.00 | 0.00 | 0.00 | 0.10 | 0.50 | 0.50 | 0.00 | 0.00 | |

Deemed-to-Satisfy Provisions

Table J2.4c HEATING SHADING MULTIPLIER (S_H)— continued

| G (refer Figure J2.4) | P/H (refer Figure J2.4) | Orientation Sector (refer Figure J2.3) | | | | | | | |
|--|----------------------------|--|------------|------|------------|-------|------------|------|------------|
| | | North | North east | East | South east | South | South west | West | North west |
| More than 500 mm but not more than 1200 mm | 0.0 | 1.00 | 1.00 | 1.00 | 1.00 | 1.00 | 1.00 | 1.00 | 1.00 |
| | 0.2 | 0.99 | 0.99 | 0.99 | 0.98 | 0.99 | 0.99 | 0.99 | 0.99 |
| | 0.4 | 0.97 | 0.97 | 0.96 | 0.95 | 0.96 | 0.95 | 0.96 | 0.97 |
| | 0.6 | 0.93 | 0.94 | 0.92 | 0.92 | 0.93 | 0.91 | 0.93 | 0.92 |
| | 0.8 | 0.85 | 0.89 | 0.87 | 0.88 | 0.90 | 0.86 | 0.88 | 0.87 |
| | 1.0 | 0.75 | 0.82 | 0.79 | 0.86 | 0.86 | 0.82 | 0.83 | 0.80 |
| | 1.2 | 0.65 | 0.73 | 0.74 | 0.86 | 0.82 | 0.78 | 0.77 | 0.72 |
| | 1.4 | 0.54 | 0.65 | 0.69 | 0.85 | 0.79 | 0.73 | 0.71 | 0.64 |
| | 1.6 | 0.42 | 0.56 | 0.66 | 0.81 | 0.76 | 0.70 | 0.65 | 0.55 |
| | 1.8 | 0.31 | 0.48 | 0.62 | 0.76 | 0.73 | 0.66 | 0.60 | 0.47 |
| | 2.0 | 0.20 | 0.39 | 0.58 | 0.72 | 0.70 | 0.63 | 0.54 | 0.39 |
| More than 1200 mm but less than 1800 mm | 0.0 | 1.00 | 1.00 | 1.00 | 1.00 | 1.00 | 1.00 | 1.00 | 1.00 |
| | 0.2 | 1.00 | 1.00 | 0.99 | 0.99 | 1.00 | 0.99 | 0.99 | 0.99 |
| | 0.4 | 0.98 | 0.98 | 0.98 | 0.98 | 0.98 | 0.98 | 0.98 | 0.98 |
| | 0.6 | 0.96 | 0.97 | 0.96 | 0.96 | 0.96 | 0.95 | 0.96 | 0.96 |
| | 0.8 | 0.93 | 0.94 | 0.92 | 0.94 | 0.94 | 0.91 | 0.93 | 0.93 |
| | 1.0 | 0.88 | 0.91 | 0.89 | 0.91 | 0.91 | 0.89 | 0.90 | 0.89 |
| | 1.2 | 0.80 | 0.86 | 0.84 | 0.88 | 0.89 | 0.86 | 0.86 | 0.84 |
| | 1.4 | 0.72 | 0.80 | 0.78 | 0.87 | 0.86 | 0.83 | 0.81 | 0.78 |
| | 1.6 | 0.63 | 0.74 | 0.75 | 0.87 | 0.84 | 0.80 | 0.77 | 0.72 |
| | 1.8 | 0.54 | 0.67 | 0.71 | 0.86 | 0.82 | 0.77 | 0.72 | 0.65 |
| | 2.0 | 0.45 | 0.60 | 0.67 | 0.86 | 0.79 | 0.74 | 0.68 | 0.58 |

Notes:

1. In *climate zones* 4 to 8, where G is 1800 mm or more, the heating shading multiplier is to be taken as 1.0.
2. The heating shading multiplier for P/H values between those shown in **Table J2.4c** can be interpolated.
3. For *glazing* in the internal *fabric* use the appropriate value for the south orientation sector with a P/H value of 2.0.

Deemed-to-Satisfy Provisions

Table J2.4d COOLING SHADING MULTIPLIER (S_c)

| G (refer Figure J2.4) | P/H (refer Figure J2.4) | Orientation Sector (refer Figure J2.3) | | | | | | | | |
|--|----------------------------|--|------------|------|------------|-------|------------|------|------------|------|
| | | North | North east | East | South east | South | South west | West | North west | |
| CLIMATE ZONES 1, 2 AND 3 | | | | | | | | | | |
| Not more than 100 mm | 0.0 | 1.00 | 1.00 | 1.00 | 1.00 | 1.00 | 1.00 | 1.00 | 1.00 | 1.00 |
| | 0.2 | 0.79 | 0.84 | 0.86 | 0.85 | 0.87 | 0.87 | 0.87 | 0.87 | 0.84 |
| | 0.4 | 0.57 | 0.66 | 0.71 | 0.70 | 0.76 | 0.73 | 0.72 | 0.72 | 0.67 |
| | 0.6 | 0.41 | 0.52 | 0.58 | 0.58 | 0.68 | 0.62 | 0.60 | 0.60 | 0.53 |
| | 0.8 | 0.32 | 0.40 | 0.47 | 0.48 | 0.62 | 0.54 | 0.50 | 0.50 | 0.43 |
| | 1.0 | 0.26 | 0.32 | 0.39 | 0.42 | 0.58 | 0.48 | 0.43 | 0.43 | 0.35 |
| | 1.2 | 0.22 | 0.28 | 0.33 | 0.38 | 0.56 | 0.43 | 0.37 | 0.37 | 0.30 |
| | 1.4 | 0.20 | 0.24 | 0.29 | 0.34 | 0.53 | 0.39 | 0.33 | 0.33 | 0.25 |
| | 1.6 | 0.19 | 0.22 | 0.26 | 0.32 | 0.52 | 0.36 | 0.29 | 0.29 | 0.22 |
| | 1.8 | 0.18 | 0.20 | 0.23 | 0.30 | 0.50 | 0.33 | 0.26 | 0.26 | 0.20 |
| | 2.0 | 0.17 | 0.18 | 0.21 | 0.28 | 0.49 | 0.31 | 0.24 | 0.24 | 0.18 |
| More than 100 mm but not more than 500 mm | 0.0 | 1.00 | 1.00 | 1.00 | 1.00 | 1.00 | 1.00 | 1.00 | 1.00 | 1.00 |
| | 0.2 | 0.92 | 0.94 | 0.95 | 0.94 | 0.93 | 0.94 | 0.95 | 0.95 | 0.94 |
| | 0.4 | 0.72 | 0.81 | 0.85 | 0.83 | 0.84 | 0.84 | 0.85 | 0.85 | 0.81 |
| | 0.6 | 0.54 | 0.68 | 0.73 | 0.72 | 0.77 | 0.75 | 0.74 | 0.74 | 0.68 |
| | 0.8 | 0.42 | 0.56 | 0.63 | 0.57 | 0.71 | 0.66 | 0.64 | 0.64 | 0.56 |
| | 1.0 | 0.34 | 0.46 | 0.54 | 0.54 | 0.66 | 0.59 | 0.56 | 0.56 | 0.47 |
| | 1.2 | 0.29 | 0.38 | 0.46 | 0.48 | 0.62 | 0.54 | 0.49 | 0.49 | 0.41 |
| | 1.4 | 0.25 | 0.32 | 0.40 | 0.43 | 0.60 | 0.50 | 0.44 | 0.44 | 0.35 |
| | 1.6 | 0.23 | 0.29 | 0.35 | 0.40 | 0.57 | 0.46 | 0.39 | 0.39 | 0.31 |
| | 1.8 | 0.21 | 0.26 | 0.32 | 0.37 | 0.56 | 0.42 | 0.36 | 0.36 | 0.28 |
| | 2.0 | 0.20 | 0.24 | 0.29 | 0.34 | 0.54 | 0.39 | 0.32 | 0.32 | 0.25 |

Deemed-to-Satisfy Provisions

Table J2.4d COOLING SHADING MULTIPLIER (S_c)— continued

| G (refer Figure J2.4) | P/H (refer Figure J2.4) | Orientation Sector (refer Figure J2.3) | | | | | | | |
|--|----------------------------|--|------------|------|------------|-------|------------|------|------------|
| | | North | North east | East | South east | South | South west | West | North west |
| More than 500 mm but not more than 1200 mm | 0.0 | 1.00 | 1.00 | 1.00 | 1.00 | 1.00 | 1.00 | 1.00 | 1.00 |
| | 0.2 | 0.97 | 0.98 | 0.98 | 0.98 | 0.96 | 0.98 | 0.98 | 0.98 |
| | 0.4 | 0.89 | 0.93 | 0.94 | 0.93 | 0.91 | 0.93 | 0.94 | 0.92 |
| | 0.6 | 0.74 | 0.85 | 0.88 | 0.86 | 0.86 | 0.86 | 0.87 | 0.84 |
| | 0.8 | 0.59 | 0.76 | 0.81 | 0.79 | 0.81 | 0.80 | 0.80 | 0.74 |
| | 1.0 | 0.49 | 0.66 | 0.73 | 0.72 | 0.77 | 0.73 | 0.72 | 0.66 |
| | 1.2 | 0.41 | 0.58 | 0.66 | 0.65 | 0.73 | 0.68 | 0.66 | 0.58 |
| | 1.4 | 0.35 | 0.51 | 0.59 | 0.59 | 0.69 | 0.63 | 0.60 | 0.51 |
| | 1.6 | 0.31 | 0.44 | 0.53 | 0.54 | 0.66 | 0.59 | 0.55 | 0.46 |
| | 1.8 | 0.28 | 0.39 | 0.48 | 0.50 | 0.64 | 0.55 | 0.50 | 0.41 |
| | 2.0 | 0.25 | 0.35 | 0.43 | 0.46 | 0.61 | 0.51 | 0.45 | 0.37 |
| More than 1200 mm but less than 1800 mm | 0.0 | 1.00 | 1.00 | 1.00 | 1.00 | 1.00 | 1.00 | 1.00 | 1.00 |
| | 0.2 | 0.98 | 0.99 | 0.99 | 0.99 | 0.98 | 0.99 | 0.99 | 0.99 |
| | 0.4 | 0.94 | 0.96 | 0.97 | 0.96 | 0.94 | 0.96 | 0.96 | 0.95 |
| | 0.6 | 0.86 | 0.92 | 0.93 | 0.92 | 0.90 | 0.91 | 0.92 | 0.90 |
| | 0.8 | 0.73 | 0.85 | 0.88 | 0.86 | 0.86 | 0.86 | 0.87 | 0.83 |
| | 1.0 | 0.59 | 0.87 | 0.83 | 0.80 | 0.82 | 0.81 | 0.81 | 0.76 |
| | 1.2 | 0.51 | 0.70 | 0.76 | 0.75 | 0.79 | 0.76 | 0.75 | 0.69 |
| | 1.4 | 0.44 | 0.63 | 0.71 | 0.70 | 0.76 | 0.71 | 0.70 | 0.62 |
| | 1.6 | 0.38 | 0.57 | 0.65 | 0.64 | 0.73 | 0.67 | 0.64 | 0.56 |
| | 1.8 | 0.34 | 0.52 | 0.60 | 0.60 | 0.70 | 0.63 | 0.60 | 0.51 |
| | 2.0 | 0.30 | 0.46 | 0.55 | 0.56 | 0.67 | 0.60 | 0.55 | 0.46 |

Deemed-to-Satisfy Provisions

Table J2.4d COOLING SHADING MULTIPLIER (S_c)— continued

| G (refer Figure J2.4) | P/H (refer Figure J2.4) | Orientation Sector (refer Figure J2.3) | | | | | | | |
|--|----------------------------|--|------------|------|------------|-------|------------|------|------------|
| | | North | North east | East | South east | South | South west | West | North west |
| CLIMATE ZONES 4 AND 5 | | | | | | | | | |
| Not more than 100 mm | 0.0 | 1.00 | 1.00 | 1.00 | 1.00 | 1.00 | 1.00 | 1.00 | 1.00 |
| | 0.2 | 0.81 | 0.85 | 0.87 | 0.86 | 0.90 | 0.88 | 0.87 | 0.84 |
| | 0.4 | 0.61 | 0.68 | 0.72 | 0.72 | 0.81 | 0.75 | 0.72 | 0.67 |
| | 0.6 | 0.46 | 0.54 | 0.59 | 0.61 | 0.74 | 0.64 | 0.60 | 0.53 |
| | 0.8 | 0.35 | 0.42 | 0.49 | 0.53 | 0.68 | 0.57 | 0.51 | 0.42 |
| | 1.0 | 0.28 | 0.34 | 0.42 | 0.47 | 0.64 | 0.50 | 0.44 | 0.34 |
| | 1.2 | 0.24 | 0.29 | 0.37 | 0.43 | 0.62 | 0.46 | 0.38 | 0.29 |
| | 1.4 | 0.22 | 0.26 | 0.33 | 0.39 | 0.59 | 0.42 | 0.34 | 0.26 |
| | 1.6 | 0.20 | 0.23 | 0.30 | 0.36 | 0.57 | 0.39 | 0.31 | 0.24 |
| | 1.8 | 0.20 | 0.21 | 0.27 | 0.34 | 0.56 | 0.37 | 0.29 | 0.22 |
| 2.0 | 0.19 | 0.20 | 0.25 | 0.32 | 0.54 | 0.34 | 0.26 | 0.21 | |
| More than 100 mm but not more than 500 mm | 0.0 | 1.00 | 1.00 | 1.00 | 1.00 | 1.00 | 1.00 | 1.00 | 1.00 |
| | 0.2 | 0.93 | 0.95 | 0.96 | 0.95 | 0.96 | 0.95 | 0.95 | 0.95 |
| | 0.4 | 0.77 | 0.83 | 0.86 | 0.85 | 0.89 | 0.86 | 0.85 | 0.82 |
| | 0.6 | 0.62 | 0.70 | 0.74 | 0.74 | 0.82 | 0.77 | 0.74 | 0.68 |
| | 0.8 | 0.48 | 0.58 | 0.64 | 0.60 | 0.76 | 0.68 | 0.64 | 0.56 |
| | 1.0 | 0.37 | 0.48 | 0.55 | 0.58 | 0.72 | 0.61 | 0.56 | 0.46 |
| | 1.2 | 0.32 | 0.40 | 0.48 | 0.52 | 0.68 | 0.56 | 0.50 | 0.39 |
| | 1.4 | 0.28 | 0.35 | 0.43 | 0.48 | 0.66 | 0.52 | 0.44 | 0.34 |
| | 1.6 | 0.25 | 0.30 | 0.39 | 0.45 | 0.64 | 0.48 | 0.40 | 0.30 |
| | 1.8 | 0.23 | 0.27 | 0.35 | 0.42 | 0.62 | 0.45 | 0.37 | 0.27 |
| 2.0 | 0.21 | 0.25 | 0.32 | 0.39 | 0.60 | 0.42 | 0.34 | 0.25 | |

Deemed-to-Satisfy Provisions

Table J2.4d COOLING SHADING MULTIPLIER (S_c)— continued

| G (refer Figure J2.4) | P/H (refer Figure J2.4) | Orientation Sector (refer Figure J2.3) | | | | | | | |
|--|----------------------------|--|------------|------|------------|-------|------------|------|------------|
| | | North | North east | East | South east | South | South west | West | North west |
| More than 500 mm but not more than 1200 mm | 0.0 | 1.00 | 1.00 | 1.00 | 1.00 | 1.00 | 1.00 | 1.00 | 1.00 |
| | 0.2 | 0.97 | 0.98 | 0.98 | 0.98 | 0.98 | 0.98 | 0.98 | 0.98 |
| | 0.4 | 0.90 | 0.94 | 0.94 | 0.94 | 0.95 | 0.94 | 0.94 | 0.93 |
| | 0.6 | 0.81 | 0.86 | 0.88 | 0.87 | 0.91 | 0.88 | 0.88 | 0.85 |
| | 0.8 | 0.70 | 0.77 | 0.81 | 0.81 | 0.87 | 0.81 | 0.80 | 0.75 |
| | 1.0 | 0.58 | 0.68 | 0.74 | 0.74 | 0.82 | 0.76 | 0.73 | 0.66 |
| | 1.2 | 0.47 | 0.60 | 0.67 | 0.68 | 0.79 | 0.70 | 0.66 | 0.58 |
| | 1.4 | 0.40 | 0.52 | 0.61 | 0.62 | 0.75 | 0.65 | 0.60 | 0.50 |
| | 1.6 | 0.35 | 0.46 | 0.55 | 0.58 | 0.73 | 0.61 | 0.55 | 0.44 |
| | 1.8 | 0.31 | 0.41 | 0.50 | 0.54 | 0.70 | 0.57 | 0.50 | 0.39 |
| | 2.0 | 0.27 | 0.36 | 0.45 | 0.50 | 0.68 | 0.54 | 0.46 | 0.35 |
| More than 1200 mm but less than 1800 mm | 0.0 | 1.00 | 1.00 | 1.00 | 1.00 | 1.00 | 1.00 | 1.00 | 1.00 |
| | 0.2 | 0.98 | 0.99 | 0.99 | 0.99 | 0.99 | 0.99 | 0.99 | 0.99 |
| | 0.4 | 0.94 | 0.97 | 0.97 | 0.96 | 0.97 | 0.96 | 0.97 | 0.96 |
| | 0.6 | 0.88 | 0.92 | 0.93 | 0.93 | 0.94 | 0.92 | 0.93 | 0.91 |
| | 0.8 | 0.82 | 0.87 | 0.88 | 0.88 | 0.91 | 0.88 | 0.88 | 0.85 |
| | 1.0 | 0.72 | 0.80 | 0.83 | 0.82 | 0.88 | 0.83 | 0.82 | 0.77 |
| | 1.2 | 0.63 | 0.72 | 0.77 | 0.77 | 0.85 | 0.78 | 0.76 | 0.70 |
| | 1.4 | 0.53 | 0.65 | 0.72 | 0.73 | 0.82 | 0.74 | 0.71 | 0.63 |
| | 1.6 | 0.45 | 0.59 | 0.67 | 0.67 | 0.79 | 0.70 | 0.66 | 0.56 |
| | 1.8 | 0.40 | 0.53 | 0.62 | 0.63 | 0.77 | 0.66 | 0.61 | 0.50 |
| | 2.0 | 0.36 | 0.48 | 0.57 | 0.59 | 0.74 | 0.62 | 0.56 | 0.45 |

Deemed-to-Satisfy Provisions

Table J2.4d COOLING SHADING MULTIPLIER (S_c)— continued

| G (refer Figure J2.4) | P/H (refer Figure J2.4) | Orientation Sector (refer Figure J2.3) | | | | | | | |
|--|----------------------------|--|------------|------|------------|-------|------------|------|------------|
| | | North | North east | East | South east | South | South west | West | North west |
| CLIMATE ZONES 6 AND 7 | | | | | | | | | |
| Not more than 100 mm | 0.0 | 1.00 | 1.00 | 1.00 | 1.00 | 1.00 | 1.00 | 1.00 | 1.00 |
| | 0.2 | 0.82 | 0.86 | 0.87 | 0.87 | 0.90 | 0.88 | 0.87 | 0.84 |
| | 0.4 | 0.63 | 0.69 | 0.72 | 0.74 | 0.80 | 0.74 | 0.72 | 0.67 |
| | 0.6 | 0.49 | 0.56 | 0.60 | 0.64 | 0.73 | 0.64 | 0.61 | 0.54 |
| | 0.8 | 0.40 | 0.46 | 0.51 | 0.56 | 0.68 | 0.57 | 0.52 | 0.44 |
| | 1.0 | 0.35 | 0.38 | 0.44 | 0.51 | 0.64 | 0.51 | 0.45 | 0.38 |
| | 1.2 | 0.32 | 0.34 | 0.39 | 0.48 | 0.61 | 0.47 | 0.41 | 0.35 |
| | 1.4 | 0.31 | 0.32 | 0.36 | 0.45 | 0.59 | 0.44 | 0.37 | 0.32 |
| | 1.6 | 0.30 | 0.30 | 0.33 | 0.42 | 0.57 | 0.42 | 0.34 | 0.31 |
| | 1.8 | 0.30 | 0.29 | 0.31 | 0.41 | 0.56 | 0.40 | 0.32 | 0.30 |
| 2.0 | 0.30 | 0.28 | 0.29 | 0.39 | 0.55 | 0.38 | 0.31 | 0.29 | |
| More than 100 mm but not more than 500 mm | 0.0 | 1.00 | 1.00 | 1.00 | 1.00 | 1.00 | 1.00 | 1.00 | 1.00 |
| | 0.2 | 0.93 | 0.95 | 0.95 | 0.95 | 0.95 | 0.95 | 0.95 | 0.95 |
| | 0.4 | 0.79 | 0.84 | 0.86 | 0.86 | 0.88 | 0.86 | 0.85 | 0.82 |
| | 0.6 | 0.64 | 0.71 | 0.75 | 0.76 | 0.81 | 0.76 | 0.74 | 0.68 |
| | 0.8 | 0.52 | 0.60 | 0.65 | 0.63 | 0.75 | 0.68 | 0.65 | 0.57 |
| | 1.0 | 0.43 | 0.51 | 0.57 | 0.61 | 0.71 | 0.61 | 0.57 | 0.48 |
| | 1.2 | 0.38 | 0.44 | 0.50 | 0.56 | 0.68 | 0.56 | 0.50 | 0.42 |
| | 1.4 | 0.35 | 0.39 | 0.45 | 0.52 | 0.65 | 0.52 | 0.46 | 0.38 |
| | 1.6 | 0.33 | 0.35 | 0.41 | 0.49 | 0.63 | 0.49 | 0.42 | 0.35 |
| | 1.8 | 0.32 | 0.33 | 0.38 | 0.47 | 0.62 | 0.46 | 0.39 | 0.33 |
| 2.0 | 0.31 | 0.31 | 0.36 | 0.45 | 0.60 | 0.44 | 0.36 | 0.32 | |

Deemed-to-Satisfy Provisions

Table J2.4d COOLING SHADING MULTIPLIER (S_c)— continued

| G (refer Figure J2.4) | P/H (refer Figure J2.4) | Orientation Sector (refer Figure J2.3) | | | | | | | |
|--|----------------------------|--|------------|------|------------|-------|------------|------|------------|
| | | North | North east | East | South east | South | South west | West | North west |
| More than 500 mm but not more than 1200 mm | 0.0 | 1.00 | 1.00 | 1.00 | 1.00 | 1.00 | 1.00 | 1.00 | 1.00 |
| | 0.2 | 0.97 | 0.98 | 0.98 | 0.98 | 0.98 | 0.98 | 0.98 | 0.98 |
| | 0.4 | 0.91 | 0.94 | 0.94 | 0.94 | 0.94 | 0.94 | 0.94 | 0.93 |
| | 0.6 | 0.82 | 0.87 | 0.88 | 0.88 | 0.90 | 0.88 | 0.87 | 0.85 |
| | 0.8 | 0.72 | 0.79 | 0.81 | 0.82 | 0.85 | 0.81 | 0.80 | 0.75 |
| | 1.0 | 0.62 | 0.70 | 0.74 | 0.76 | 0.81 | 0.75 | 0.73 | 0.66 |
| | 1.2 | 0.53 | 0.62 | 0.67 | 0.70 | 0.77 | 0.70 | 0.67 | 0.58 |
| | 1.4 | 0.47 | 0.55 | 0.62 | 0.65 | 0.74 | 0.65 | 0.61 | 0.51 |
| | 1.6 | 0.42 | 0.49 | 0.56 | 0.61 | 0.72 | 0.61 | 0.56 | 0.46 |
| | 1.8 | 0.38 | 0.44 | 0.51 | 0.57 | 0.69 | 0.57 | 0.51 | 0.42 |
| | 2.0 | 0.35 | 0.40 | 0.47 | 0.54 | 0.67 | 0.54 | 0.47 | 0.38 |
| More than 1200 mm but less than 1800 mm | 0.0 | 1.00 | 1.00 | 1.00 | 1.00 | 1.00 | 1.00 | 1.00 | 1.00 |
| | 0.2 | 0.99 | 0.99 | 0.99 | 0.99 | 0.99 | 0.99 | 0.99 | 0.99 |
| | 0.4 | 0.95 | 0.97 | 0.97 | 0.96 | 0.97 | 0.96 | 0.97 | 0.96 |
| | 0.6 | 0.89 | 0.93 | 0.93 | 0.93 | 0.94 | 0.92 | 0.93 | 0.91 |
| | 0.8 | 0.82 | 0.87 | 0.88 | 0.88 | 0.90 | 0.88 | 0.87 | 0.85 |
| | 1.0 | 0.75 | 0.81 | 0.83 | 0.83 | 0.87 | 0.83 | 0.82 | 0.78 |
| | 1.2 | 0.67 | 0.74 | 0.78 | 0.79 | 0.83 | 0.78 | 0.76 | 0.70 |
| | 1.4 | 0.59 | 0.68 | 0.72 | 0.74 | 0.80 | 0.74 | 0.71 | 0.63 |
| | 1.6 | 0.52 | 0.61 | 0.67 | 0.70 | 0.77 | 0.70 | 0.66 | 0.57 |
| | 1.8 | 0.47 | 0.56 | 0.63 | 0.66 | 0.75 | 0.66 | 0.61 | 0.52 |
| | 2.0 | 0.43 | 0.51 | 0.58 | 0.62 | 0.73 | 0.63 | 0.57 | 0.47 |

Deemed-to-Satisfy Provisions

Table J2.4d COOLING SHADING MULTIPLIER (S_c)— continued

| G (refer Figure J2.4) | P/H (refer Figure J2.4) | Orientation Sector (refer Figure J2.3) | | | | | | | |
|--|----------------------------|--|------------|------|------------|-------|------------|------|------------|
| | | North | North east | East | South east | South | South west | West | North west |
| CLIMATE ZONE 8 | | | | | | | | | |
| Not more than 100 mm | 0.0 | 1.00 | 1.00 | 1.00 | 1.00 | 1.00 | 1.00 | 1.00 | 1.00 |
| | 0.2 | 0.78 | 0.83 | 0.86 | 0.85 | 0.87 | 0.86 | 0.86 | 0.83 |
| | 0.4 | 0.58 | 0.65 | 0.70 | 0.71 | 0.75 | 0.73 | 0.71 | 0.65 |
| | 0.6 | 0.47 | 0.52 | 0.58 | 0.61 | 0.67 | 0.63 | 0.60 | 0.53 |
| | 0.8 | 0.43 | 0.44 | 0.49 | 0.54 | 0.62 | 0.56 | 0.52 | 0.45 |
| | 1.0 | 0.42 | 0.40 | 0.44 | 0.50 | 0.59 | 0.51 | 0.47 | 0.41 |
| | 1.2 | 0.41 | 0.39 | 0.41 | 0.48 | 0.57 | 0.48 | 0.43 | 0.39 |
| | 1.4 | 0.41 | 0.38 | 0.39 | 0.46 | 0.56 | 0.46 | 0.40 | 0.38 |
| | 1.6 | 0.40 | 0.37 | 0.37 | 0.45 | 0.55 | 0.45 | 0.39 | 0.37 |
| | 1.8 | 0.40 | 0.37 | 0.36 | 0.44 | 0.54 | 0.44 | 0.38 | 0.37 |
| 2.0 | 0.40 | 0.36 | 0.36 | 0.43 | 0.53 | 0.44 | 0.37 | 0.37 | |
| More than 100 mm but not more than 500 mm | 0.0 | 1.00 | 1.00 | 1.00 | 1.00 | 1.00 | 1.00 | 1.00 | 1.00 |
| | 0.2 | 0.91 | 0.94 | 0.95 | 0.94 | 0.94 | 0.95 | 0.95 | 0.94 |
| | 0.4 | 0.74 | 0.81 | 0.84 | 0.83 | 0.85 | 0.84 | 0.85 | 0.80 |
| | 0.6 | 0.58 | 0.66 | 0.73 | 0.73 | 0.77 | 0.75 | 0.74 | 0.67 |
| | 0.8 | 0.48 | 0.55 | 0.62 | 0.60 | 0.70 | 0.66 | 0.65 | 0.56 |
| | 1.0 | 0.44 | 0.47 | 0.54 | 0.58 | 0.65 | 0.60 | 0.57 | 0.48 |
| | 1.2 | 0.43 | 0.42 | 0.49 | 0.54 | 0.62 | 0.55 | 0.51 | 0.44 |
| | 1.4 | 0.42 | 0.40 | 0.45 | 0.51 | 0.60 | 0.52 | 0.47 | 0.41 |
| | 1.6 | 0.41 | 0.39 | 0.42 | 0.49 | 0.58 | 0.49 | 0.44 | 0.39 |
| | 1.8 | 0.41 | 0.38 | 0.40 | 0.47 | 0.57 | 0.48 | 0.42 | 0.38 |
| 2.0 | 0.41 | 0.37 | 0.38 | 0.46 | 0.56 | 0.46 | 0.40 | 0.38 | |

Deemed-to-Satisfy Provisions

Table J2.4d COOLING SHADING MULTIPLIER (S_c)— continued

| G (refer Figure J2.4) | P/H (refer Figure J2.4) | Orientation Sector (refer Figure J2.3) | | | | | | | |
|--|----------------------------|--|------------|------|------------|-------|------------|------|------------|
| | | North | North east | East | South east | South | South west | West | North west |
| More than 500 mm but not more than 1200 mm | 0.0 | 1.00 | 1.00 | 1.00 | 1.00 | 1.00 | 1.00 | 1.00 | 1.00 |
| | 0.2 | 0.97 | 0.98 | 0.98 | 0.98 | 0.97 | 0.98 | 0.98 | 0.97 |
| | 0.4 | 0.88 | 0.93 | 0.94 | 0.93 | 0.93 | 0.93 | 0.93 | 0.92 |
| | 0.6 | 0.78 | 0.84 | 0.87 | 0.86 | 0.87 | 0.86 | 0.87 | 0.83 |
| | 0.8 | 0.66 | 0.74 | 0.79 | 0.79 | 0.81 | 0.80 | 0.80 | 0.74 |
| | 1.0 | 0.56 | 0.64 | 0.71 | 0.72 | 0.75 | 0.73 | 0.73 | 0.64 |
| | 1.2 | 0.49 | 0.56 | 0.65 | 0.66 | 0.71 | 0.68 | 0.66 | 0.57 |
| | 1.4 | 0.46 | 0.50 | 0.59 | 0.61 | 0.68 | 0.64 | 0.61 | 0.51 |
| | 1.6 | 0.44 | 0.45 | 0.54 | 0.57 | 0.66 | 0.60 | 0.56 | 0.47 |
| | 1.8 | 0.43 | 0.42 | 0.49 | 0.54 | 0.63 | 0.57 | 0.52 | 0.44 |
| | 2.0 | 0.42 | 0.40 | 0.46 | 0.52 | 0.61 | 0.53 | 0.49 | 0.42 |
| More than 1200 mm but less than 1800 mm | 0.0 | 1.00 | 1.00 | 1.00 | 1.00 | 1.00 | 1.00 | 1.00 | 1.00 |
| | 0.2 | 0.98 | 0.99 | 0.99 | 0.99 | 0.99 | 0.99 | 0.99 | 0.99 |
| | 0.4 | 0.93 | 0.96 | 0.96 | 0.96 | 0.95 | 0.96 | 0.96 | 0.95 |
| | 0.6 | 0.86 | 0.91 | 0.93 | 0.91 | 0.91 | 0.91 | 0.92 | 0.90 |
| | 0.8 | 0.78 | 0.84 | 0.87 | 0.86 | 0.87 | 0.86 | 0.87 | 0.83 |
| | 1.0 | 0.69 | 0.77 | 0.82 | 0.80 | 0.82 | 0.81 | 0.81 | 0.76 |
| | 1.2 | 0.60 | 0.69 | 0.75 | 0.75 | 0.78 | 0.76 | 0.76 | 0.68 |
| | 1.4 | 0.54 | 0.62 | 0.69 | 0.70 | 0.74 | 0.72 | 0.70 | 0.62 |
| | 1.6 | 0.49 | 0.55 | 0.65 | 0.65 | 0.71 | 0.68 | 0.66 | 0.56 |
| | 1.8 | 0.47 | 0.50 | 0.60 | 0.62 | 0.69 | 0.64 | 0.61 | 0.52 |
| | 2.0 | 0.45 | 0.46 | 0.55 | 0.58 | 0.67 | 0.61 | 0.57 | 0.48 |

Notes:

1. Where G is 1800 mm or more, the cooling shading multiplier is to be taken as 1.0.
2. The cooling shading multiplier for P/H values between those shown in **Table J2.4d** can be interpolated.
3. For *glazing* in the internal *fabric* use the appropriate value for the south orientation sector with a P/H value of 2.0.

Deemed-to-Satisfy Provisions

Figure J2.3

ORIENTATION SECTORS

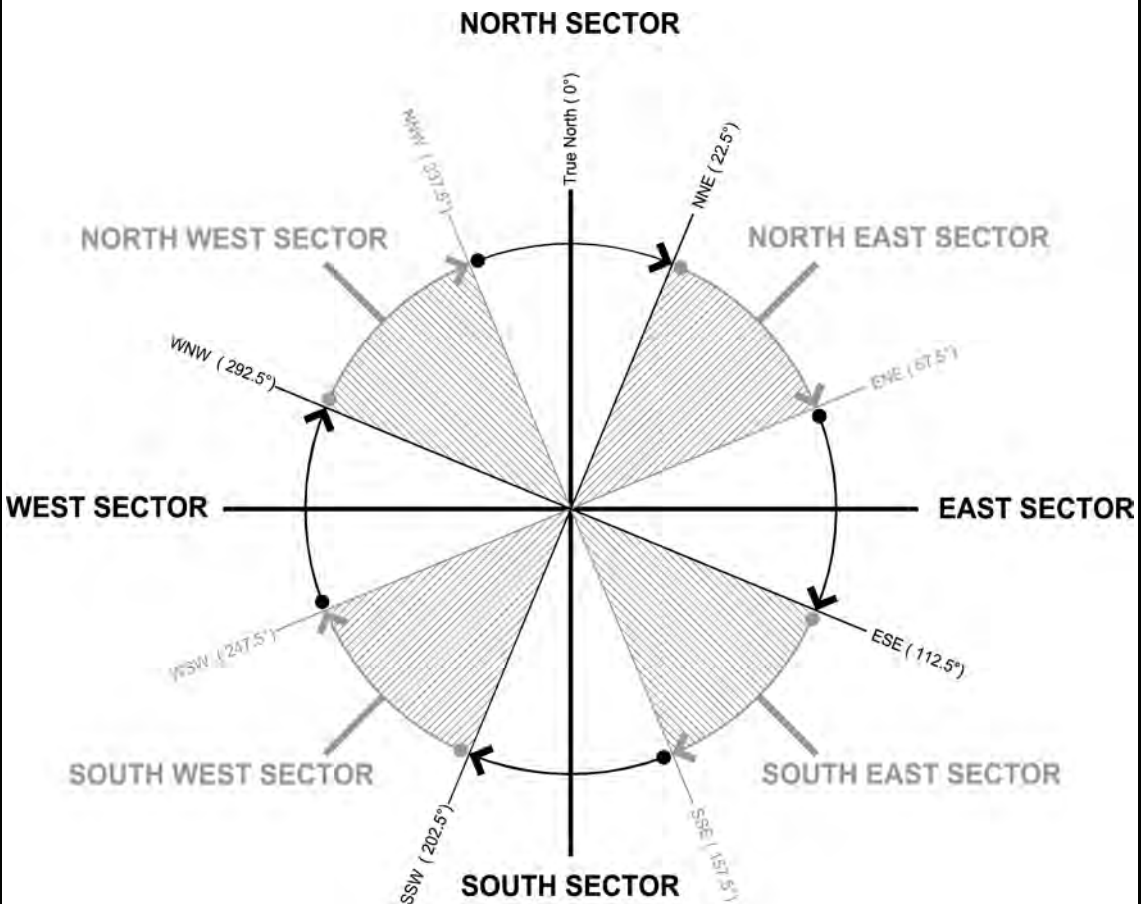

Note:

The orientation sector for a wall or *glazing* element is the sector that contains a line drawn perpendicular to the face of the wall or *glazing* element.

Deemed-to-Satisfy Provisions

Figure J2.4

METHOD OF MEASURING P AND H

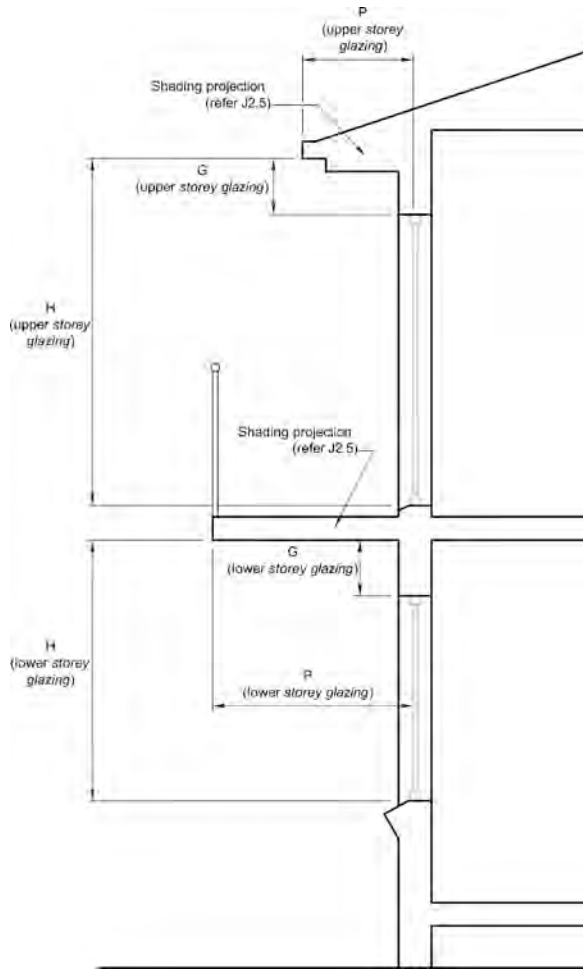

Notes:

An external shading device that complies with **J2.5(b)** is considered to achieve a P/H value of 2.

J2.5 Shading

Where shading is *required* to comply with **J2.4**, it must—

- (a) be provided by an external permanent projection, such as a verandah, balcony, fixed canopy, eaves or shading hood, which—
 - (i) extends horizontally on both sides of the *glazing* for the same projection distance P in **Figure J2.4**; or
 - (ii) provides the equivalent shading to (i) with a reveal or the like; or

Deemed-to-Satisfy Provisions

- (b) be provided by an external shading device, such as a shutter, blind, vertical or horizontal building screen with blades, battens or slats, which—
 - (i) is capable of restricting at least 80% of summer solar radiation; and
 - (ii) if adjustable, is operated automatically in response to the level of solar radiation.

PART J3 BUILDING SEALING

Deemed-to-Satisfy Provisions

J3.0 Deemed-to-Satisfy Provisions

- (a) Where a *Building Solution* is proposed to comply with the *Deemed-to-Satisfy Provisions*, *Performance Requirements JP1* and *JP3* are satisfied by complying with—
- (i) **J0.1** to **J0.3**; and
 - (ii) **J1.1** to **J1.6**; and
 - (iii) **J2.1** to **J2.5**; and
 - (iv) **J3.1** to **J3.7**; and
 - (v) **J5.1** to **J5.5**; and
 - (vi) **J6.1** to **J6.6**; and
 - (vii) **J7.1** to **J7.4**.
- (b) Where a *Building Solution* is proposed as an *Alternative Solution* to the *Deemed-to-Satisfy Provisions* of—
- (i) **J0.1** to **J0.3**; and
 - (ii) **J1.1** to **J1.6**; and
 - (iii) **J2.1** to **J2.5**; and
 - (iv) **J3.1** to **J3.7**; and
 - (v) **J5.1** to **J5.5**; and
 - (vi) **J6.1** to **J6.6**; and
 - (vii) **J7.1** to **J7.4**,

the relevant *Performance Requirements* must be determined in accordance with **A0.10**.

J3.1 Application of Part

The *Deemed-to-Satisfy Provisions* of this Part apply to elements forming the *envelope* of a Class 2 to 9 building, other than—

- (a) a building in *climate zones* 1, 2, 3 and 5 where the only means of *air-conditioning* is by using an evaporative cooler; or
- (b) a permanent building opening, in a space where a gas appliance is located, that is necessary for the safe operation of a gas appliance; or
- (c) a building or space where the mechanical ventilation *required* by **Part F4** provides sufficient pressurisation to prevent infiltration.

NSW J3.1(d)

J3.2 Chimneys and flues

The chimney or flue of an open solid-fuel burning appliance must be provided with a damper or flap that can be closed to seal the chimney or flue.

Deemed-to-Satisfy Provisions

J3.3 Roof lights

- (a) A *roof light* must be sealed, or capable of being sealed, when serving—
 - (i) a *conditioned space*; or
 - (ii) a *habitable room* in *climate zones* 4, 5, 6, 7 or 8.
- (b) A *roof light required* by (a) to be sealed, or capable of being sealed, must be constructed with—
 - (i) an imperforate ceiling diffuser or the like installed at the ceiling or internal lining level; or
 - (ii) a weatherproof seal; or
 - (iii) a shutter system readily operated either manually, mechanically or electronically by the occupant.

J3.4 Windows and doors

- (a) A seal to restrict air infiltration must be fitted to each edge of a door, openable *window* or the like forming part of—
 - (i) the *envelope* of a *conditioned space*; or
 - (ii) the external fabric of a *habitable room* or public area in *climate zones* 4, 5, 6, 7 or 8.
- (b) The requirements of (a) do not apply to—
 - (i) a *window* complying with AS 2047; or
 - (ii) a fire door or smoke door; or
 - (iii) a roller shutter door, roller shutter grille or other security door or device installed only for out-of-hours security.
- (c) A seal *required* by (a)—
 - (i) for the bottom edge of an external swing door, must be a draft protection device; and
 - (ii) for the other edges of an external door or the edges of an openable *window* or other such opening, may be a foam or rubber compression strip, fibrous seal or the like.
- (d) An entrance to a building, if leading to a *conditioned space* must have an airlock, *self-closing* door, revolving door or the like, other than—
 - (i) where the *conditioned space* has a *floor area* of not more than 50 m²; or
 - (ii) where a café, restaurant, open front shop or the like has—
 - (A) a 3 m deep un-conditioned zone between the main entrance, including an open front, and the *conditioned space*; and
 - (B) at all other entrances to the café, restaurant, open front shop or the like, *self-closing* doors.

Deemed-to-Satisfy Provisions

J3.5 Exhaust fans

A miscellaneous exhaust fan, such as a bathroom or domestic kitchen exhaust fan, must be fitted with a sealing device such as a self-closing damper or the like when serving—

- (a) a *conditioned space*; or
- (b) a *habitable room* in *climate zones* 4, 5, 6, 7 or 8.

J3.6 Construction of roofs, walls and floors

- (a) Roofs, ceilings, walls, floors and any opening such as a *window* frame, door frame, *roof light* frame or the like must be constructed to minimise air leakage in accordance with (b) when forming part of—
 - (i) the *envelope*; or
 - (ii) the external *fabric* of a *habitable room* or a public area in *climate zones* 4, 5, 6, 7 or 8.
- (b) Construction *required* by (a) must be—
 - (i) enclosed by internal lining systems that are close fitting at ceiling, wall and floor junctions; or
 - (ii) sealed by caulking, skirting, architraves, cornices or the like.
- (c) The requirements of (a) do not apply to openings, grilles or the like *required* for smoke hazard management.

J3.7 Evaporative coolers

An evaporative cooler must be fitted with a self-closing damper or the like when serving—

- (a) a heated space; or
- (b) a *habitable room* or a public area of a building in *climate zones* 4, 5, 6, 7 or 8.

PART J4

* * * * *

This Part has deliberately been left blank.

PART J5

AIR-CONDITIONING AND VENTILATION SYSTEMS

Deemed-to-Satisfy Provisions

J5.0 Deemed-to-Satisfy Provisions

- (a) Where a *Building Solution* is proposed to comply with the *Deemed-to-Satisfy Provisions*, *Performance Requirements JP1* and *JP3* are satisfied by complying with—
- (i) **J0.1** to **J0.3**; and
 - (ii) **J1.1** to **J1.6**; and
 - (iii) **J2.1** to **J2.5**; and
 - (iv) **J3.1** to **J3.7**; and
 - (v) **J5.1** to **J5.5**; and
 - (vi) **J6.1** to **J6.6**; and
 - (vii) **J7.1** to **J7.4**.
- (b) Where a *Building Solution* is proposed as an *Alternative Solution* to the *Deemed-to-Satisfy Provisions* of—
- (i) **J0.1** to **J0.3**; and
 - (ii) **J1.1** to **J1.6**; and
 - (iii) **J2.1** to **J2.5**; and
 - (iv) **J3.1** to **J3.7**; and
 - (v) **J5.1** to **J5.5**; and
 - (vi) **J6.1** to **J6.6**; and
 - (vii) **J7.1** to **J7.4**,
- the relevant *Performance Requirements* must be determined in accordance with **A0.10**.

J5.1 * * * * *

This clause has deliberately been left blank.

J5.2 Air-conditioning and ventilation systems

- (a) An *air-conditioning* unit or system must—
- (i) be capable of being deactivated when the *sole-occupancy unit*, building or part of the building served is not occupied; and
 - (ii) where the *air-conditioning* unit or system has motorised outside air and return dampers, close the dampers when the *air-conditioning* unit or system is deactivated; and

Deemed-to-Satisfy Provisions

- (iii) when serving a *sole-occupancy unit* of a Class 3 building, not operate when any external door including a door opening to a balcony, patio, courtyard or the like is open for more than 1 minute; and
- (iv) have any supply and return ductwork sealed and insulated in accordance with **Specification J5.2**; and
- (v) when serving more than one *air-conditioning* zone or area with different heating and cooling needs—
 - (A) thermostatically control the temperature of each zone or area; and
 - (B) not control the temperature by mixing actively heated air and actively cooled air; and
 - (C) limit reheating to not more than—
 - (aa) for a fixed supply air rate, a 7.5 K rise in temperature; and
 - (bb) for a variable supply air rate, a 7.5 K rise in temperature at the nominal supply air rate but increased or decreased at the same rate that the supply air rate is respectively decreased or increased; and
- (vi) other than where a packaged *air-conditioning* unit is used, have a variable speed fan when its supply air quantity is varied; and
- (vii) where the *air-conditioning* system provides the *required* mechanical ventilation, in other than process related applications where humidity control is needed, have an *outdoor air economy cycle*—
 - (A) in *climate zone* 2 and 3, when the *air-conditioning* unit capacity is over 50 kW_r; and
 - (B) in *climate zones* 4, 5, 6, 7 and 8, when the *air-conditioning* unit capacity is over 35 kW_r; and
- (viii) in a Class 3 building, be capable of controlling the temperature of a *sole-occupancy unit* at a different temperature during sleeping periods than during other periods; and
- (ix) be designed so that the total *fan motor power* of the *air-conditioning* supply air and return air fans in the building, divided by the *floor area* served by those fans is, in accordance with **Table J5.2**, except the following need not comply with this requirement:
 - (A) fans in unducted *air-conditioning* units with a supply air capacity of less than 1000 L/s,
 - (B) The power for a fan in an energy reclaiming system that preconditions outdoor air.
 - (C) The power for process related components such as high efficiency particulate air filters.

Deemed-to-Satisfy Provisions

Table J5.2 MAXIMUM FAN MOTOR POWER

| <i>Air-conditioning</i> sensible heat load (W/m ² of the <i>floor area</i> of the <i>conditioned space</i>) | Maximum <i>fan motor power</i> (W/m ² of the <i>floor area</i> of the <i>conditioned space</i>) | |
|--|---|--|
| | For an <i>air-conditioning</i> system serving not more than 500 m ² | For an <i>air-conditioning</i> system serving more than 500 m ² |
| Up to 100 | 5.3 | 8.3 |
| 101 to 150 | 9.5 | 13.5 |
| 151 to 200 | 13.7 | 18.3 |
| 201 to 300 | 22.2 | 28.0 |
| 301 to 400 | 30.7 | 37.0 |

Note: For more than 400 W/m² *air-conditioning* sensible heat load—

- (a) in a building of not more than 500 m² *floor area*, use 0.09 W of *fan motor power* for each Watt of *air-conditioning* sensible heat load; and
- (b) in a building of more than 500 m² *floor area*, use 0.12 W of *fan motor power* for each Watt of *air-conditioning* sensible heat load.

- (b) A system that provides mechanical ventilation to other than a *sole-occupancy unit* in a Class 2 building or a Class 4 part of a building, either as part of an *air-conditioning* system or as a separate ventilation system, must—
 - (i) be capable of being deactivated when the building or part of the building served by that system is not occupied; and
 - (ii) when serving a *conditioned space*—
 - (A) not provide mechanical ventilation in excess of the minimum *outdoor air* quantity *required* by **Part F4** for a mechanical ventilation system, where relevant, by more than 20% other than where there is—
 - (aa) additional unconditioned outside air supplied to provide free cooling or to balance process exhaust such as from a *health-care building* or laboratory; or
 - (bb) additional exhaust ventilation needed to balance the *required* mechanical ventilation; or
 - (cc) an energy reclaiming system that preconditions all the outside air; and
 - (B) in other than *climate zone* 2, where the number of square metres per person is 1 or less as specified in **D1.13** and the air flow rate is more than 1000 L/s, have—
 - (aa) an energy reclaiming system that preconditions outside air; or
 - (bb) the ability to automatically modulate the mechanical ventilation *required* by **Part F4** in proportion to the number of occupants; and
 - (iii) when the mechanical ventilation is provided by means other than an *air-conditioning* system and the air flow rate is more than 1000 L/s—
 - (A) have a *fan motor power* to air flow rate ratio of 0.65 W/(L/s) without filters or 0.98 W/(L/s) with filters for a general mechanical ventilation system; and

Deemed-to-Satisfy Provisions

- (B) for *carpark* exhaust, when serving a *carpark* with more than 40 vehicle spaces, be controlled by an atmospheric contaminant monitoring system in accordance with AS 1668.2.
- (c) The requirements of (a) and (b) must not inhibit—
 - (i) the smoke hazard management operation of *air-conditioning* and mechanical ventilation systems; and
 - (ii) essential ventilation such as for a garbage room, lift motor room, gas meter enclosure or gas regulator enclosure or the like.
- (d) The provisions of (b)(iii) do not apply to the following:
 - (i) The power for an energy reclaiming system that preconditions outside air.
 - (ii) The power for process related components such as high efficiency particulate air filters.
 - (iii) The power for a miscellaneous exhaust system complying with J5.5.
 - (iv) The power for a mechanical ventilation system for a Class 8 *electricity network substation*.

J5.3 Time switch

- (a) A time switch in accordance with **Specification J6** must be provided to control each of the following:
 - (i) An *air-conditioning* system of more than 10 kW_r.
 - (ii) A ventilation system with an air flow rate of more than 1000 L/s.
 - (iii) A heating system of more than 10 kW_{heating}.
- (b) The requirements of (a) do not apply to—
 - (i) an *air-conditioning* system or ventilation system that serves only one *sole-occupancy unit* of—
 - (A) a Class 2 or 3 building; or
 - (B) a Class 4 part of a building; or
 - (C) a Class 9c *aged care building*; or
 - (ii) a building where *air-conditioning* or ventilation is needed for 24 hour occupancy such as a manufacturing process or emergency services; or
 - (iii) a Class 8 *electricity network substation*.

J5.4 Heating and cooling systems

- (a) Systems that provide heating or cooling for *air-conditioning* systems must—
 - (i) have any *pipng*, vessels, heat exchangers or tanks containing heated or chilled fluid, other than those with insulation levels covered by Minimum Energy Performance Standards (MEPS), insulated in accordance with **Specification J5.4**; and
 - (ii) where water is circulated by pumping at greater than 2 L/s—

Deemed-to-Satisfy Provisions

- (A) be designed so that the total of the *pump power* to the pump is in accordance with **Table J5.4a**; and

Table J5.4a MAXIMUM PUMP POWER

| Cooling or heating load (W/m ² of the <i>floor area</i> of the <i>conditioned space</i>) | Maximum <i>pump power</i> (W/m ² of the <i>floor area</i> of the <i>conditioned space</i>) | | |
|---|--|-----------------|---------------|
| | Chilled water | Condenser water | Heating water |
| Up to 100 | 1.3 | 0.9 | 1.0 |
| 101 to 150 | 1.9 | 1.2 | 1.3 |
| 151 to 200 | 2.2 | 2.2 | 1.7 |
| 201 to 300 | 4.3 | 3.0 | 2.5 |
| 301 to 400 | 5.0 | 3.6 | 3.2 |
| More than 400 | 5.6 | 5.6 | 3.6 |

- (B) have the pump capable of varying its speed in response to varying load when it is rated at more than 3 kW of *pump power*, except where the pump is needed to run at full speed for safe or efficient operation; and
- (iii) if the system contains more than one water heater used for heating a building, chiller or coil, be capable of stopping the flow of water to those not operating.
- (b) A heater—
- (i) for heating a space via water, such as a boiler, that is part of an *air-conditioning* system, must—
- (A) achieve a thermal efficiency complying with **Table J5.4b** when tested in accordance with BS 7190; and
- (B) use reticulated gas where it is available at the allotment boundary; and

Table J5.4b MINIMUM THERMAL EFFICIENCY OF A WATER HEATER

| Fuel type | Rated capacity (kW _{heating}) | Minimum gross thermal efficiency (%) |
|------------|---|--------------------------------------|
| Gas | Not more than 750 | 80 |
| | More than 750 | 83 |
| Oil | All capacities | 80 |

- (ii) for heating a space other than via water, must be—
- (A) a solar heater; or
- (B) a gas heater; or
- (C) an oil heater, but only if reticulated gas is not available at the allotment boundary; or
- (D) a heat pump heater; or
- (E) a solid-fuel burning heater; or

Deemed-to-Satisfy Provisions

- (F) a heater using reclaimed heat from another process such as reject heat from a refrigeration plant; or
- (G) an electric heater if—
 - (aa) the heating capacity is not more than—
 - (AA) 10 W/m² of the *floor area* of the *conditioned space* in *climate zone 1*; or
 - (BB) 40 W/m² of the *floor area* of the *conditioned space* in *climate zone 2*; or
 - (CC) the value specified in **Table J5.4c** where reticulated gas is not available at the allotment boundary; or
 - (bb) the annual energy consumption for heating is not more than 15 kWh/m² of the *floor area* of the *conditioned space* in *climate zones 1 to 5*; or
 - (cc) the in-duct heater complies with **J5.2(a)(v)(C)**; or
- (H) a combination of **(A)** to **(G)**; and

Table J5.4c MAXIMUM ELECTRIC HEATING CAPACITY IF RETICULATED GAS IS NOT AVAILABLE AT THE ALLOTMENT BOUNDARY

| <i>Floor area of the conditioned space</i> | <i>Climate zone</i> | | | | |
|--|--------------------------------------|----|----|----|----|
| | 3 | 4 | 5 | 6 | 7 |
| | <i>W/m² of floor area</i> | | | | |
| Not more than 500 m ² | 50 | 60 | 55 | 65 | 70 |
| More than 500 m ² | 40 | 50 | 45 | 55 | 60 |

- (iii) for heating a bathroom in a Class 3 or Class 9c *aged care building*, may be electric if the heating capacity is not more than 1.2 kW; and
 - (iv) that is a fixed space heating appliance installed outdoors, must be controlled to automatically turn off when not needed by an outdoor air temperature sensor, timer, motion detector, or the like.
- (c) Package *air-conditioning* equipment with a capacity of not less than 65 kW_r, including a split unit and a heat pump, must have an energy efficiency ratio when cooling complying with **Table J5.4d** when tested in accordance with AS/NZS 3823.1.2 at test condition T1.

Table J5.4d MINIMUM ENERGY EFFICIENCY RATIO FOR PACKAGED AIR-CONDITIONING EQUIPMENT

| Equipment | Minimum energy efficiency ratio ($W_r/W_{input\ power}$) | |
|---------------------------|--|---------------------------------------|
| | 65 kW _r to 95 kW _r capacity | More than 95 kW _r capacity |
| Air-conditioner — cooling | 2.70 | 2.80 |
| Heat pump — cooling | 2.60 | 2.70 |

- (d) A refrigerant chiller up to 350 kW_r capacity that is part of an *air-conditioning* system, must have an energy efficiency ratio complying with **Table J5.4e** when determined in accordance with AHRI 550/590.

Deemed-to-Satisfy Provisions

Table J5.4e MINIMUM ENERGY EFFICIENCY RATIO FOR REFRIGERANT CHILLERS

| Equipment | Minimum energy efficiency ratio (W_r/W_{input} power) | |
|--|--|--------------------------|
| | For full load operation | For integrated part load |
| Water cooled chiller | 4.2 | 5.2 |
| Air cooled or evaporatively cooled chiller | 2.5 | 3.4 |

- (e) The fan motor of an air cooled condenser that is part of an *air-conditioning* system, other than one that is part of package *air-conditioning* equipment in (c) or that is part of a Liquid Chilling Package, using the vapour compression cycle in (d), must not use more than 42 W of *fan motor power*, for each kW of heat rejected from the refrigerant when determined in accordance with AHRI 460.
- (f) The fan of a cooling tower that is part of an *air-conditioning* system must not use more than—
 - (i) if a propeller or axial fan, 310 W of *fan motor power* for each L/s of cooling water circulated; or
 - (ii) if a centrifugal fan, 590 W of *fan motor power* for each L/s of cooling water circulated.
- (g) The fan of a closed circuit cooler that is part of an *air-conditioning* system must not use more than—
 - (i) if a propeller or axial fan, 500 W of *fan motor power* for each L/s of cooled fluid circulated; and
 - (ii) if a centrifugal fan, 670 W of *fan motor power* for each L/s of cooled fluid circulated.
- (h) The fan of an evaporative condenser that is part of an *air-conditioning* system must not use more than—
 - (i) if a propeller or axial fan, 18 W of *fan motor power* for each kW of heat rejected; and
 - (ii) if a centrifugal fan, 22 W of *fan motor power* for each kW of heat rejected.
- (i) The spray water pump of a closed circuit cooler or evaporative condenser that is part of an *air-conditioning* system must not use more than 150 W of *pump power* for each L/s of spray water circulated.

J5.5 Miscellaneous exhaust systems

- (a) A miscellaneous exhaust system with an air flow rate of more than 1000 L/s, that is associated with equipment having a variable demand such as a stove in a commercial kitchen or a chemical bath in a factory, must—
 - (i) have the means for the operator to—
 - (A) reduce the energy used, such as by a variable speed fan, and
 - (B) stop the motor when the system is not needed; and
 - (ii) be designed to minimise the exhausting of conditioned air.
- (b) The requirements of (a) do not apply—

Deemed-to-Satisfy Provisions

- (i) within a *sole-occupancy unit* of a Class 2 or 3 building, Class 4 part of a building or Class 9c *aged care building*; or
- (ii) where additional exhaust ventilation is needed to balance the *required* outside air for ventilation; or
- (iii) where air flow must be maintained for safe operation; or
- (iv) to a Class 8 *electricity network substation*.

PART J6

ARTIFICIAL LIGHTING AND POWER

Deemed-to-Satisfy Provisions

J6.0 Deemed-to-Satisfy Provisions

- (a) Where a *Building Solution* is proposed to comply with the *Deemed-to-Satisfy Provisions*, *Performance Requirements JP1* and *JP3* are satisfied by complying with—
- (i) **J0.1** to **J0.3**; and
 - (ii) **J1.1** to **J1.6**; and
 - (iii) **J2.1** to **J2.5**; and
 - (iv) **J3.1** to **J3.7**; and
 - (v) **J5.1** to **J5.5**; and
 - (vi) **J6.1** to **J6.6**; and
 - (vii) **J7.1** to **J7.4**.
- (b) Where a *Building Solution* is proposed as an *Alternative Solution* to the *Deemed-to-Satisfy Provisions* of—
- (i) **J0.1** to **J0.3**; and
 - (ii) **J1.1** to **J1.6**; and
 - (iii) **J2.1** to **J2.5**; and
 - (iv) **J3.1** to **J3.7**; and
 - (v) **J5.1** to **J5.5**; and
 - (vi) **J6.1** to **J6.6**; and
 - (vii) **J7.1** to **J7.4**,

the relevant *Performance Requirements* must be determined in accordance with **A0.10**.

J6.1 Application of Part

J6.2, **J6.3** and **J6.5(a)(ii)** do not apply to a Class 8 *electricity network substation*.

J6.2 Artificial lighting

- (a) In a *sole-occupancy unit* of a Class 2 building or a Class 4 part of a building—
- (i) the *lamp power density* or *illumination power density* of artificial lighting must not exceed—
 - (A) within the building, 5 W/m²; and
 - (B) on a verandah or balcony of the building, 4 W/m²; and
 - (ii) the *illumination power density* in (i) may be increased by dividing it by the *illumination power density* adjustment factor for a control device in **Table J6.2b**; and

Deemed-to-Satisfy Provisions

- (iii) when designing the *lamp power density* or *illumination power density*, the power of the proposed installation must be used rather than nominal allowances for exposed batten holders or luminaires; and
 - (iv) halogen lamps must be separately switched from fluorescent lamps.
- (b) In a building other than a *sole-occupancy unit* of a Class 2 building or a Class 4 part of a building—
- (i) for artificial lighting, the aggregate design illumination power load must not exceed the sum of the allowances obtained by multiplying the area of each space by the maximum *illumination power density* in **Table J6.2a**; and
 - (ii) the aggregate design illumination power load in (i) is the sum of the design illumination power loads in each of the spaces served; and
 - (iii) in determining the design illumination power load for (ii) the following must be used:
 - (A) Where there are multiple lighting systems serving the same space—
 - (aa) the total illumination power load of all systems; or
 - (bb) for a control system that permits only one system to operate at a time, the design illumination power load is—
 - (AA) based on the highest illumination power load; or
 - (BB) determined by the formula—

$$[H \times T/2 + P \times (100 - T/2)] / 100$$

Where:

 - H = the highest illumination power load; and
 - T = the time for which the maximum illumination power load will occur, expressed as a percentage; and
 - P = the predominant illumination power load.
 - (B) Where there is adjustable position lighting such as trapeze lighting or track lighting other than trunking systems that accept fluorescent lamps—
 - (aa) the rating of the circuit breaker protecting the track; or
 - (bb) of extra low voltage, 80% of the power rating of the transformer; or
 - (cc) of mains voltage, 100 W per metre of track.
- (c) The requirements of (a) and (b) do not apply to the following:
- (i) Emergency lighting in accordance with **Part E4**.
 - (ii) Signage and display lighting within cabinets and display cases that are fixed in place.
 - (iii) Lighting for accommodation within the residential part of a *detention centre*.
 - (iv) A heater where the heater also emits light, such as in bathrooms.
 - (v) Lighting of a specialist process nature such as in an operating theatre, fume cupboard or clean workstation.
 - (vi) Lighting of performances such as theatrical or sporting.

Deemed-to-Satisfy Provisions

- (vii) Lighting for the permanent display and preservation of works of art or objects in a museum or gallery other than for retail sale, purchase or auction.

Table J6.2a MAXIMUM ILLUMINATION POWER DENSITY

| Space | Maximum <i>illumination power density</i> (W/m ²) |
|---|---|
| Auditorium, church and public hall | 10 |
| Board room and conference room | 10 |
| <i>Carpark</i> - general | 6 |
| <i>Carpark</i> - entry zone (first 20 m of travel) | 25 |
| Common rooms, spaces and corridors in a Class 2 building | 8 |
| Control room, switch room, and the like | 9 |
| Corridors | 8 |
| Courtroom | 12 |
| Dormitory of a Class 3 building used for sleeping only | 6 |
| Dormitory of a Class 3 building used for sleeping and study | 9 |
| Entry lobby from outside the building | 15 |
| Health-care - children's ward | 10 |
| Health-care - examination room | 10 |
| Health-care - patient ward | 7 |
| Health-care - all patient care areas including corridors where cyanosis lamps are used | 13 |
| Kitchen and food preparation area | 8 |
| Laboratory - artificially lit to an ambient level of 400 lx or more | 12 |
| Library - stack and shelving area | 12 |
| Library - reading room and general areas | 10 |
| Lounge area for communal use in a Class 3 building or Class 9c <i>aged care building</i> | 10 |
| Museum and gallery - circulation, cleaning and service lighting | 8 |
| Office - artificially lit to an ambient level of 200 lx or more | 9 |
| Office - artificially lit to an ambient level of less than 200 lx | 7 |
| Plant room | 5 |
| Restaurant, café, bar, hotel lounge and a space for the serving and consumption of food or drinks | 18 |
| Retail space including a museum and gallery whose purpose is the sale of objects | 22 |

Deemed-to-Satisfy Provisions

Table J6.2a MAXIMUM ILLUMINATION POWER DENSITY— continued

| Space | Maximum <i>illumination power density</i> (W/m ²) |
|--|---|
| <i>School</i> - general purpose learning areas and tutorial rooms | 8 |
| <i>Sole-occupancy unit</i> of a Class 3 building | 5 |
| <i>Sole-occupancy unit</i> of a Class 9c <i>aged care building</i> | 7 |
| Storage with shelving no higher than 75% of the height of the aisle lighting | 8 |
| Storage with shelving higher than 75% of the height of the aisle lighting | 10 |
| Service area, cleaner's room and the like | 5 |
| Toilet, locker room, staff room, rest room and the like | 6 |
| Wholesale storage and display area | 10 |

Notes:

1. In areas not listed above, the maximum *illumination power density* is—
 - (a) for an illuminance of not more than 80 lx, 7.5 W/m²; and
 - (b) for an illuminance of more than 80 lx and not more than 160 lx, 9 W/m²; and
 - (c) for an illuminance of more than 160 lx and not more than 240 lx, 10 W/m²; and
 - (d) for an illuminance of more than 240 lx and not more than 320 lx, 11 W/m²; and
 - (e) for an illuminance of more than 320 lx and not more than 400 lx, 12 W/m²; and
 - (f) for an illuminance of more than 400 lx and not more than 480 lx, 13 W/m²; and
 - (g) for an illuminance of more than 480 lx and not more than 540 lx, 14 W/m²; and
 - (h) for an illuminance of more than 540 lx and not more than 620 lx, 15 W/m².
2. For illuminance levels greater than 620 lx, the average *light source efficacy* must not be less than 80 Lumens/W.
3. For enclosed spaces with a Room Aspect Ratio of less than 1.5, the maximum *illumination power density* may be increased by dividing it by an adjustment factor for room aspect which is:

$$0.5 + (\text{Room Aspect Ratio}/3)$$

The Room Aspect Ratio of the enclosed space is determined by the formula:

$$A/(H \times C)$$

Where:
 A is the area of the enclosed space
 H is the height of the space measured from the floor to the highest part of the ceiling
 C is the perimeter of the enclosed space at floor level

Deemed-to-Satisfy Provisions

Table J6.2a MAXIMUM ILLUMINATION POWER DENSITY— continued

| Space | Maximum <i>illumination power density</i> (W/m ²) |
|---|---|
| 4. In addition to 3, the maximum <i>illumination power density</i> may be increased by dividing it by the <i>illumination power density</i> adjustment factor in Table J6.2b where applicable and where the control device is not installed to comply with J6.3 . | |
| 5. Circulation spaces are included in the allowances listed in the Table. | |

Table J6.2b ILLUMINATION POWER DENSITY ADJUSTMENT FACTOR FOR A CONTROL DEVICE

| Item | Description | <i>Illumination power density</i> adjustment factor |
|--|---|--|
| Lighting timer in accordance with Specification J6 | For corridor lighting | 0.7 |
| Motion detector in accordance with Specification J6 | (a) Where— (i) at least 75% of the area of a space is controlled by one or more motion detectors; or (iii) an area of less than 200 m ² is switched as a block by one or more detectors. | 0.9 |
| | (b) Where up to 6 lights are switched as a block by one or more detectors. | 0.7 |
| | (c) Where up to 2 lights are switched as a block by one or more detectors. | 0.55 |
| Manual dimming system ^{Note 1} | (a) Where at least 75% of the area of a space, in other than a <i>sole-occupancy unit</i> of a Class 2 building or a Class 4 part of a building, is controlled by manually operated dimmers. | 0.95 |
| | (b) Where at least 75% of the area of a space, in a <i>sole-occupancy unit</i> of a Class 2 building or a Class 4 part of a building, is controlled by manually operated dimmers. | 0.85 |
| Programmable dimming system ^{Note 2} | Where at least 75% of the area of a space is controlled by programmable dimmers. | 0.85 |

Deemed-to-Satisfy Provisions

Table J6.2b ILLUMINATION POWER DENSITY ADJUSTMENT FACTOR FOR A CONTROL DEVICE— continued

| Item | Description | <i>Illumination power density adjustment factor</i> |
|--|---|--|
| Dynamic dimming system ^{Note 3} | Automatic compensation for lumen depreciation. | The design lumen depreciation factor of not less than— (i) for fluorescent lights, 0.9; or (ii) for high pressure discharge lights, 0.8. |
| Fixed dimming ^{Note 4} | Where at least 75% of the area is controlled by fixed dimmers that reduce the overall lighting level and the power consumption of the lighting. | % of full power to which the dimmer is set divided by 0.95. |
| Daylight sensor and dynamic lighting control device in accordance with Specification J6 – dimmed or stepped switching of lights adjacent <i>windows</i> | (a) Lights within the space adjacent to <i>windows</i> other than <i>roof lights</i> for a distance from the <i>window</i> equal to the depth of the floor to window head height. | 0.5 ^{Note 5} |
| | (b) Lights within the space adjacent to <i>roof lights</i> . | 0.6 ^{Note 5} |

Notes:

1. Manual dimming is where lights are controlled by a knob, slider or other mechanism or where there are pre-selected scenes that are manually selected.
2. Programmed dimming is where pre-selected scenes or levels are automatically selected by the time of day, photoelectric cell or occupancy sensor.
3. Dynamic dimming is where the lighting level is varied automatically by a photoelectric cell to either proportionally compensate for the availability of daylight or the lumen depreciation of the lamps.
4. Fixed dimming is where lights are controlled to a level and that level cannot be adjusted by the user.
5. The *illumination power density* adjustment factor is only applied to lights controlled by that item. This adjustment factor does not apply to tungsten halogen or other incandescent sources.

Deemed-to-Satisfy Provisions

Table J6.2b ILLUMINATION POWER DENSITY ADJUSTMENT FACTOR FOR A CONTROL DEVICE— continued

| Item | Description | <i>Illumination power density adjustment factor</i> |
|------|--|---|
| 6. | <p>A maximum of two other <i>illumination power density</i> adjustment factors for a control device can be applied to an area. Where more than one <i>illumination power density</i> adjustment factor (other than for room aspect) apply to an area, they are to be combined using the following formula:</p> $A \times (B + [(1 - B) / 2])$ <p>Where:</p> <p>A is the lowest applicable <i>illumination power density</i> adjustment factor; and</p> <p>B is the second lowest applicable <i>illumination power density</i> adjustment factor.</p> | |

J6.3 Interior artificial lighting and power control

- (a) Artificial lighting of a room or space must be individually operated by a switch or other control device.
- (b) An occupant activated device, such as a room security device, a motion detector in accordance with **Specification J6**, or the like, must be provided in the *sole-occupancy unit* of a Class 3 building, other than where providing accommodation for people with a disability or the aged, to cut power to the artificial lighting, air-conditioner, local exhaust fans and bathroom heater when the *sole-occupancy unit* is unoccupied.
- (c) An artificial lighting switch or other control device in (a) must—
 - (i) if an artificial lighting switch, be located in a visible position—
 - (A) in the room or space being switched; or
 - (B) in an adjacent room or space from where the lighting being switched is visible; and
 - (ii) for other than a single functional space such as an auditorium, theatre, *swimming pool*, sporting stadium or warehouse—
 - (A) not operate lighting for an area of more than 250 m² if in a Class 5 building or a Class 8 laboratory; or
 - (B) not operate lighting for an area of more than—
 - (aa) 250 m² for a space of not more than 2000 m²; or
 - (bb) 1000 m² for a space of more than 2000 m²,
 if in a Class 3, 6, 7, 8 (other than a laboratory) or 9 building.
- (d) 95% of the light fittings in a building or *storey* of a building, other than a Class 2 or 3 building or a Class 4 part of a building, of more than 250 m² must be controlled by—
 - (i) a time switch in accordance with **Specification J6**; or
 - (ii) an occupant sensing device such as—
 - (A) a security key card reader that registers a person entering and leaving the building; or

Deemed-to-Satisfy Provisions

- (B) a motion detector in accordance with **Specification J6**.
- (e) In a Class 5, 6 or 8 building of more than 250 m², artificial lighting in a natural lighting zone adjacent to *windows* must be separately controlled from artificial lighting not in a natural lighting zone in the same *storey* except where—
 - (i) the room containing the natural lighting zone is less than 20 m²; or
 - (ii) the room's natural lighting zone contains less than 4 luminaires; or
 - (iii) 70% or more of the luminaires in the room are in the natural lighting zone.
- (f) The requirements of (a), (b), (c), (d) and (e) do not apply to the following:
 - (i) Emergency lighting in accordance with **Part E4**.
 - (ii) Where artificial lighting is needed for 24 hour occupancy such as for a manufacturing process, parts of a hospital, an airport control tower or within a *detention centre*.
- (g) The requirements of (d) do not apply to the following:
 - (i) Artificial lighting in a space where the sudden loss of artificial lighting would cause an unsafe situation such as in a *patient care area* in a Class 9a building or in a Class 9c *aged care building*.
 - (ii) A heater where the heater also emits light, such as in bathrooms.

J6.4 Interior decorative and display lighting

- (a) Interior decorative and display lighting, such as for a foyer mural or art display, must be controlled—
 - (i) separately from other artificial lighting; and
 - (ii) by a manual switch for each area other than when the operating times of the displays are the same in a number of areas such as in a museum, art gallery or the like, in which case they may be combined; and
 - (iii) by a time switch in accordance with **Specification J6** where the display lighting exceeds 1 kW.
- (b) Window display lighting must be controlled separately from other display lighting.

J6.5 Artificial lighting around the perimeter of a building

- (a) Artificial lighting around the perimeter of a building, must—
 - (i) be controlled by—
 - (A) a daylight sensor; or
 - (B) a time switch that is capable of switching on and off electric power to the system at variable pre-programmed times and on variable pre-programmed days; and
 - (ii) when the total perimeter lighting load exceeds 100 W—
 - (A) have an average *light source efficacy* of not less than 60 Lumens/W; or
 - (B) be controlled by a motion detector in accordance with **Specification J6**; and

Deemed-to-Satisfy Provisions

- (iii) when used for decorative purposes, such as facade lighting or signage lighting, have a separate time switch in accordance with **Specification J6**.
- (b) The requirements of **(a)(ii)** do not apply to the following:
 - (i) Emergency lighting in accordance with **Part E4**.
 - (ii) Lighting around a *detention centre*.

J6.6 Boiling water and chilled water storage units

Power supply to a boiling water or chilled water storage unit must be controlled by a time switch in accordance with **Specification J6**.

PART J7

HOT WATER SUPPLY AND SWIMMING POOL AND SPA POOL PLANT

Deemed-to-Satisfy Provisions

J7.0 Deemed-to-Satisfy Provisions

- (a) Where a *Building Solution* is proposed to comply with the *Deemed-to-Satisfy Provisions*, *Performance Requirements JP1* and *JP3* are satisfied by complying with—
- (i) **J0.1** to **J0.3**; and
 - (ii) **J1.1** to **J1.6**; and
 - (iii) **J2.1** to **J2.5**; and
 - (iv) **J3.1** to **J3.7**; and
 - (v) **J5.1** to **J5.5**; and
 - (vi) **J6.1** to **J6.6**; and
 - (vii) **J7.1** to **J7.4**.
- (b) Where a *Building Solution* is proposed as an *Alternative Solution* to the *Deemed-to-Satisfy Provisions* of—
- (i) **J0.1** to **J0.3**; and
 - (ii) **J1.1** to **J1.6**; and
 - (iii) **J2.1** to **J2.5**; and
 - (iv) **J3.1** to **J3.7**; and
 - (v) **J5.1** to **J5.5**; and
 - (vi) **J6.1** to **J6.6**; and
 - (vii) **J7.1** to **J7.4**,

the relevant *Performance Requirements* must be determined in accordance with **A0.10**.

SA J7.0(c)

J7.1 * * * * *

This clause has deliberately been left blank.

J7.2 Hot water supply

SA J7.2

Vic J7.2

A hot water supply system for food preparation and sanitary purposes, other than a solar hot water supply system in *climate zones* 1, 2 and 3, must be designed and installed in accordance with Section 8 of AS/NZS 3500.4.

Deemed-to-Satisfy Provisions

J7.3 Swimming pool heating and pumping

- (a) Heating for a *swimming pool* must be by—
 - (i) a solar heater not boosted by electric resistance heating; or
 - (ii) a heater using reclaimed energy; or
 - (iii) a gas heater; or
 - (iv) a heat pump; or
 - (v) a combination of 2 or more of (i), (ii), (iii) and (iv).
- (b) Where some or all of the heating *required* by (a) is by a gas heater or a heat pump, the *swimming pool* must have—
 - (i) a cover other than when located in a *conditioned space*; and
 - (ii) a time switch in accordance with **Specification J6** to control the operation of the heater.
- (c) A time switch must be provided in accordance with **Specification J6** to control the operation of a circulation pump for a *swimming pool*.
- (d) For the purpose of **J7.3**, a *swimming pool* does not include a spa pool.

J7.4 Spa pool heating and pumping

- (a) Heating for a spa pool that shares a water recirculation system with a *swimming pool* must be by—
 - (i) a solar heater; or
 - (ii) a heater using reclaimed energy; or
 - (iii) a gas heater; or
 - (iv) a heat pump; or
 - (v) a combination of 2 or more of (i), (ii), (iii) and (iv).
- (b) Where some or all of the heating *required* by (a) is by a gas heater or a heat pump, the spa pool must have—
 - (i) a cover; and
 - (ii) a push button and a time switch in accordance with **Specification J6** to control the operation of the heater.
- (c) A time switch must be provided in accordance with **Specification J6** to control the operation of a circulation pump for a spa pool having a capacity of 680 L or more.

SA J7.5

PART J8

ACCESS FOR MAINTENANCE AND FACILITIES FOR MONITORING

Deemed-to-Satisfy Provisions

J8.0 Deemed-to-Satisfy Provisions

- (a) Where a *Building Solution* is proposed to comply with the *Deemed-to-Satisfy Provisions, Performance Requirement JP2* is satisfied by complying with **J8.1** to **J8.3**.
- (b) Where a *Building Solution* is proposed as an *Alternative Solution* to the *Deemed-to-Satisfy Provisions* of **J8.1** to **J8.3**, the relevant *Performance Requirements* must be determined in accordance with **A0.10**.

J8.1 Application of Part

The *Deemed-to-Satisfy Provisions* of this Part do not apply—

- (a) within a *sole-occupancy unit* of a Class 2 building or a Class 4 part of a building; or
- (b) to a Class 8 *electricity network substation*.

J8.2 Access for maintenance

NSW J8.2

Access must be provided to all plant, equipment and components that *require* maintenance in accordance with **Part I2**.

J8.3 Facilities for energy monitoring

- (a) A building or *sole-occupancy unit* with a *floor area* of more than 500 m² must have the facility to record the consumption of gas and electricity.
- (b) A building with a *floor area* of more than 2,500 m² must have the facility to record individually the energy consumption of—
 - (i) *air-conditioning* plant including, where appropriate, heating plant, cooling plant and air handling fans; and
 - (ii) artificial lighting; and
 - (iii) appliance power; and
 - (iv) central hot water supply; and
 - (v) internal transport devices including lifts, escalators and travelators where there is more than one serving the building; and
 - (vi) other ancillary plant.
- (c) The provisions of (b) do not apply to a Class 2 building with a *floor area* of more than 2,500 m² where the total area of the common areas is less than 500 m².

SPECIFICATION J1.2 MATERIAL PROPERTIES

Deemed-to-Satisfy Provisions

1. Scope

This Specification lists the thermal properties of some common construction materials.

2. Construction Deemed-to-Satisfy

- (a) **Table 2a** lists the thermal conductivity considered to be achieved by some common construction materials.

Table 2a THERMAL CONDUCTIVITY OF TYPICAL WALL, ROOF/CEILING AND FLOOR MATERIALS

| Material description | Material density kg/m ³ | Thermal conductivity W/m.K |
|---|------------------------------------|----------------------------|
| 1. Framing | | |
| (a) Steel | 7850 | 47.5 |
| (b) Timber – kiln dried hardwood (across the grain) | 677 | 0.16 |
| (c) Timber – Radiata pine (across the grain) | 506 | 0.10 |
| 2. Roof Cladding | | |
| (a) Aluminium sheeting | 2680 | 210 |
| (b) Concrete or terra cotta tiles | 1922 | 0.81 |
| (c) Steel sheeting | 7850 | 47.5 |
| 3. Wall Cladding | | |
| (a) Aluminium sheeting | 2680 | 210 |
| (b) Autoclaved aerated concrete | 350 | 0.10 |
| | 900 | 0.27 |
| (c) Cement render (1 cement : 4 sand) | 1570 | 0.53 |
| (d) Clay bricks | | |
| (i) Clay brick – 2.75 kg | 1430 | 0.55 |
| (ii) Clay brick – 3.25 kg | 1690 | 0.65 |
| (iii) Clay brick – 3.75 kg | 1950 | 0.78 |
| (e) Concrete blocks | | |
| (i) 190 mm dense or 90 mm dense solid | 1100/2200 | 1.1 |
| (ii) 140 mm dense or 190 mm lightweight | 1250/910 | 0.85 |
| (iii) 90 mm dense hollow or 90 mm lightweight solid | 1650/1800 | 0.75 |

Deemed-to-Satisfy Provisions

Table 2a THERMAL CONDUCTIVITY OF TYPICAL WALL, ROOF/CEILING AND FLOOR MATERIALS— continued

| Material description | Material density kg/m ³ | Thermal conductivity W/m.K |
|--|------------------------------------|----------------------------|
| (iv) 140 mm lightweight | 1050 | 0.67 |
| (v) 90 mm lightweight | 1360 | 0.55 |
| (f) Fibre-cement | 1360 | 0.25 |
| (g) Gypsum plasterboard | 880 | 0.17 |
| (h) Pine weatherboards | 506 | 0.10 |
| (i) Plywood | 530 | 0.14 |
| (j) Solid concrete | 2400 | 1.44 |
| (k) Steel sheeting | 7850 | 47.5 |
| (l) Prestressed hollow core concrete panel | 1680 | 0.80 |
| 4. Flooring Materials | | |
| (a) Carpet underlay | - | 0.04 |
| (b) Carpet | - | 0.05 |
| (c) Prestressed hollow core concrete planks | 1680 | 0.80 |
| (d) Particleboard | 640 | 0.12 |
| (e) Plywood | 530 | 0.14 |
| (f) Timber – kiln dried hardwood (across the grain) | 677 | 0.16 |
| (g) Timber – Radiata pine (across the grain) | 506 | 0.10 |
| (h) Solid concrete | 2400 | 1.44 |
| (i) Vinyl floor tiles | 2050 | 0.79 |
| 5. Other Materials | | |
| (a) Clay soil (10% moisture content) | 1300 | 0.6 |
| (b) PMMA (polymethylmethacrylate) | 1180 | 1.00 |
| (c) Polycarbonates | 1200 | 0.2 |
| (d) Sand (6% moisture content) | 1800 | 1.64 |
| (e) Soda lime glass | 2500 | 1.0 |
| Notes: | | |
| <ol style="list-style-type: none"> For materials which incorporate cores or hollows in regular patterns (such as cored brickwork, hollow blockwork and cored floor or wall panels), the tabulated material densities and thermal conductivities are based on the gross density (mass divided by external dimensions). The <i>R-Value</i> of a material is determined by dividing the thickness of the material in metres by the thermal conductivity in W/m.K. | | |

(b) **Table 2b** lists the *R-Values* considered to be achieved by air films and airspaces.

Deemed-to-Satisfy Provisions

Table 2b TYPICAL R-VALUES FOR AIRSPACES AND AIR FILMS

| Position of airspace | Direction of heat flow | <i>R-Value</i> |
|--|------------------------|----------------|
| 1. Airspaces non-reflective unventilated | | |
| In a roof with a pitch of not more than 5° | Up | 0.15 |
| | Down | 0.22 |
| In a roof with a ceiling that is parallel with a roof with a pitch more than 5° and not more than 15° | Up | 0.15 |
| | Down | 0.21 |
| In a roof with a ceiling that is parallel with a roof with a pitch more than 22° and not more than 45° | Up | 0.15 |
| | Down | 0.18 |
| In any roof space with a horizontal ceiling, with a pitch more than 5° | Up | 0.18 |
| | Down | 0.28 |
| In a wall | Horizontal | 0.17 |
| 2. Airspaces non-reflective ventilated | | |
| In any roof with a pitch not more than 5° and 100 mm deep airspace | Up | Nil |
| | Down | 0.19 |
| In any roof space with a horizontal ceiling, with a pitch more than 5° | Up | Nil |
| | Down | 0.46 |
| In a wall | Horizontal | 0.14 |
| 3. Air films – Still air | | |
| On a surface with a pitch of not more than 5° | Up | 0.11 |
| | Down | 0.16 |
| On a surface with a pitch of more than 5° and not more than 30° | Up | 0.11 |
| | Down | 0.15 |
| On a surface with a pitch of more than 30° and not more than 45° | Up | 0.11 |
| | Down | 0.13 |
| On a wall | Horizontal | 0.12 |
| 4. Air films – Moving air | | |
| Not more than 3 m/s wind | Any direction | 0.04 |
| More than 3 m/s wind speed and not more than 7 m/s wind speed | Any direction | 0.03 |
| Note: <i>R-Values</i> are for a temperature of 10°C and temperature difference of 15K. | | |

- (c) The thermal properties considered to be achieved by reflective surfaces are—
- (i) within a wall—
 - (A) with an inner reflective surface of 0.05 emittance and a 20 mm airspace to the wall lining, an added *R-Value* of 0.48; and

Deemed-to-Satisfy Provisions

- (B) with an inner reflective surface of 0.05 emittance and a 70 mm airspace to the wall lining, an added *R-Value* of 0.43; and
 - (C) with an inner reflective surface of 0.05 emittance and a 70 mm airspace to the wall lining and an outer anti-glare reflective surface of 0.20 emittance and a 25 mm airspace to the wall cladding, an added *R-Value* of 0.95; and
 - (D) with an outer anti-glare reflective surface of 0.20 emittance and a 35 mm airspace to the wall cladding, an added *R-Value* of 0.50; and
- (ii) within a roof where the *reflective insulation* is laid directly under the roof, those in **Table 2c**.

Table 2c TYPICAL THERMAL PROPERTIES FOR REFLECTIVE SURFACES WITH AIRSPACES IN ROOFS

| Emittance of added <i>reflective insulation</i> | Direction of heat flow | <i>R-Value</i> added by a reflective surface | | | | | |
|---|------------------------|--|---------------------------|---|-------------------------------------|--|----------------------------|
| | | Pitched roof (>10°) with horizontal ceiling | | Flat, skillion or pitched roof (≤10°) with horizontal ceiling | Pitched roof with cathedral ceiling | | |
| | | Ventilated roof space | Non-ventilated roof space | | 15° to not more than 25° pitch | more than 25° to not more than 35° pitch | more than 35° to 45° pitch |
| 0.2 outer 0.05 inner | Downwards | 1.21 | 1.12 | 1.28 | 0.96 | 0.86 | 0.66 |
| 0.2 outer 0.05 inner | Upwards | 0.59 | 0.75 | 0.68 | 0.72 | 0.74 | 0.77 |
| 0.9 outer 0.05 inner | Downwards | 1.01 | 0.92 | 1.06 | 0.74 | 0.64 | 0.44 |
| 0.9 outer 0.05 inner | Upward | 0.40 | 0.55 | 0.49 | 0.51 | 0.52 | 0.53 |

- (d) A ventilated roof space is a roof space with—
- (i) gable vents, ridge vents, eave vents, roof vents or the like that—
 - (A) are evenly distributed to allow an unobstructed flow of air; and
 - (B) are located to ensure, where practicable, there are no dead airspaces; and
 - (C) have an aggregate fixed open area of not less than 1.0% of the ceiling area; or
 - (ii) not less than 2 wind-driven roof ventilators having an aggregate opening area of not less than 0.14 m² in conjunction with gable vents, ridge vents, eave vents, roof vents or the like having an aggregate fixed open area of not less than 0.2% of the ceiling area; or
 - (iii) a tiled roof without *sarking-type material* at roof level.

SPECIFICATION **J1.3** ROOF AND CEILING CONSTRUCTION

Deemed-to-Satisfy Provisions

1. Scope

This Specification describes the thermal performance of some common forms of roof and ceiling construction.

2. Construction Deemed-to-Satisfy

Figure 2 details the *R-Values* considered to be achieved by some common forms of roof and ceiling construction.

Figure 2 TYPICAL R-VALUES FOR ROOF AND CEILING CONSTRUCTION

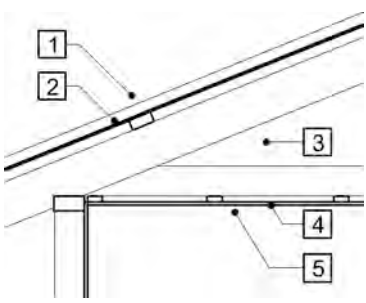
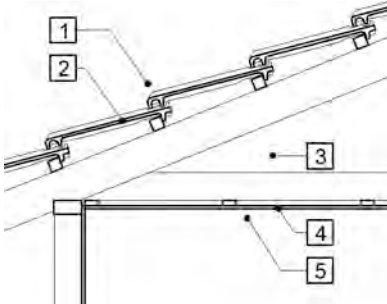
| Roof construction description | Item | Item description | <i>R-Value</i> Unventilated | | <i>R-Value</i> Ventilated | |
|---|----------------------|---|--------------------------------|------|------------------------------|------|
| | | | Up | Down | Up | Down |
| | | | | | | |
| (a) Roof 15° to 45° pitch – Horizontal ceiling – Metal cladding  | 1. | Outdoor air film (7 m/s) | 0.04 | 0.04 | 0.04 | 0.04 |
| | 2. | Metal cladding | 0.00 | 0.00 | 0.00 | 0.00 |
| | 3. | Roof airspace (non-reflective) | 0.18 | 0.28 | 0.00 | 0.46 |
| | 4. | Plasterboard, gypsum (10 mm, 880 kg/m ³) | 0.06 | 0.06 | 0.06 | 0.06 |
| | 5. | Indoor air film (still air) | 0.11 | 0.16 | 0.11 | 0.16 |
| | <i>Total R-Value</i> | | | 0.39 | 0.54 | 0.21 |
| (b) Roof 15° to 45° pitch – Horizontal ceiling – Clay tiles 19 mm  | 1. | Outdoor air film (7 m/s) | 0.04 | 0.04 | 0.04 | 0.04 |
| | 2. | Roof tile, clay or concrete (1922 kg/m ³) | 0.02 | 0.02 | 0.02 | 0.02 |
| | 3. | Roof airspace (non-reflective) | 0.18 | 0.28 | 0.00 | 0.46 |
| | 4. | Plasterboard, gypsum (10 mm, 880 kg/m ³) | 0.06 | 0.06 | 0.06 | 0.06 |
| | 5. | Indoor air film (still air) | 0.11 | 0.16 | 0.11 | 0.16 |
| | <i>Total R-Value</i> | | | 0.41 | 0.56 | 0.23 |

Deemed-to-Satisfy Provisions

Figure 2 TYPICAL R-VALUES FOR ROOF AND CEILING CONSTRUCTION

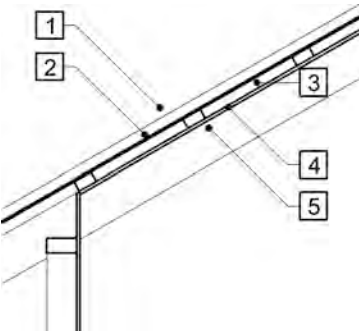
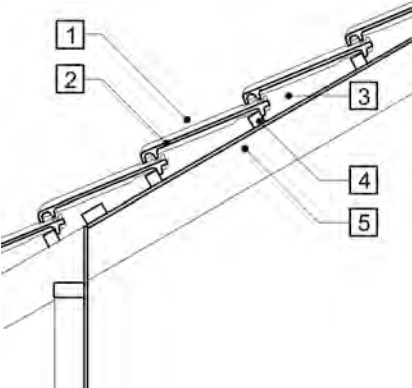
| Roof construction description | Item | Item description | <i>R-Value</i> Unventilated | |
|---|----------------------|---|--------------------------------|------|
| | | | Up | Down |
| (c) Cathedral ceiling 15° to 45° pitch – 10 mm plaster on top of rafters – Metal external cladding  | 1. | Outdoor air film (7 m/s) | 0.04 | 0.04 |
| | 2. | Metal cladding | 0.00 | 0.00 |
| | 3. | Roof airspace (30 mm to 100 mm, non-reflective) | 0.15 | 0.18 |
| | 4. | Plasterboard, gypsum (10 mm, 880 kg/m ³) | 0.06 | 0.06 |
| | 5. | Indoor air film (still air) | 0.11 | 0.14 |
| | <i>Total R-Value</i> | | | 0.36 |
| (d) Cathedral ceiling 15° to 45° pitch – 10 mm plaster on top of rafters – Tiles external cladding  | 1. | Outdoor air film (7 m/s) | 0.04 | 0.04 |
| | 2. | Roof tile, clay or concrete (1922 kg/m ³) | 0.02 | 0.02 |
| | 3. | Roof airspace (30 mm to 100 mm, non-reflective) | 0.15 | 0.18 |
| | 4. | Plasterboard, gypsum (10 mm, 880 kg/m ³) | 0.06 | 0.06 |
| | 5. | Indoor air film (still air) | 0.11 | 0.14 |
| | <i>Total R-Value</i> | | | 0.38 |

Deemed-to-Satisfy Provisions

Figure 2 TYPICAL R-VALUES FOR ROOF AND CEILING CONSTRUCTION— continued

| Roof construction description | Item | Item description | R-Value Unventilated | |
|---|----------------------|--|----------------------|------|
| | | | Up | Down |
| (e) Skillion roof less than 5° pitch – 10 mm plaster below rafters – Metal external cladding | 1. | Outdoor air film (7 m/s) | 0.04 | 0.04 |
| | 2. | Metal cladding | 0.00 | 0.00 |
| | 3. | Roof airspace (100 mm to 300 mm, non-reflective) | 0.15 | 0.22 |
| | 4. | Plasterboard, gypsum (10 mm, 880 kg/m ³) | 0.06 | 0.06 |
| | 5. | Indoor air film (still air) | 0.11 | 0.16 |
| | <i>Total R-Value</i> | | | 0.36 |
| (f) Skillion roof 5° to 15° pitch – 10 mm plaster on top of rafters – Metal external cladding | 1. | Outdoor air film (7 m/s) | 0.04 | 0.04 |
| | 2. | Metal cladding | 0.00 | 0.00 |
| | 3. | Roof airspace (30 mm to 100 mm non-reflective) | 0.15 | 0.21 |
| | 4. | Plasterboard, gypsum (10 mm, 880 kg/m ³) | 0.06 | 0.06 |
| | 5. | Indoor air film (still air) | 0.11 | 0.16 |
| | <i>Total R-Value</i> | | | 0.36 |

Deemed-to-Satisfy Provisions

Figure 2 TYPICAL R-VALUES FOR ROOF AND CEILING CONSTRUCTION— continued

| Roof construction description | Item | Item description | <i>R-Value</i> Unventilated | |
|--|----------------------|--|--------------------------------|------|
| | | | Up | Down |
| (g) 100 mm solid concrete roof to 5° – 10 mm plaster, suspended ceiling – Applied external waterproof membrane | 1. | Outdoor air film (7 m/s) | 0.04 | 0.04 |
| | 2. | Waterproof membrane, rubber synthetic (4 mm, 961 kg/m ³) | 0.03 | 0.03 |
| | 3. | Solid concrete, (100 mm, 2400 kg/m ³) | 0.07 | 0.07 |
| | 4. | Ceiling airspace (100 mm to 300 mm, non-reflective) | 0.15 | 0.22 |
| | 5. | Plasterboard, gypsum (10 mm, 880 kg/m ³) | 0.06 | 0.06 |
| | 6. | Indoor air film (still air) | 0.11 | 0.16 |
| | <i>Total R-Value</i> | | | 0.46 |

Notes:

1. The *R-Value* of an item, other than an airspace, air film or air cavity, may be increased in proportion to the increased thickness of the item.
2. The *Total R-Value* of a form of construction may be increased by the amount that the *R-Value* of an individual item is increased.
3. Where an airspace is filled, the *R-Value* listed for the airspace must be deducted from the *Total R-Value* of the roof construction.
4. For information on a roof space that is considered to be ventilated, see **Specification J1.2, Clause 2(d)**.

SPECIFICATION **J1.5** WALL CONSTRUCTION

Deemed-to-Satisfy Provisions

1. Scope

This Specification describes the thermal performance of some common forms of external wall construction.

2. Construction Deemed-to-Satisfy

Figure 2 details the *R-Values* considered to be achieved by some common forms of wall construction.

Figure 2 TYPICAL R-VALUES FOR WALL CONSTRUCTION

| External wall construction description | Item | Item description | <i>R-Value</i> |
|---|----------------------|--|----------------|
| (a) Masonry veneer – 25 mm to 50 mm cavity, 10 mm internal plaster on 90 mm stud frame | 1. | Outdoor air film (7 m/s) | 0.04 |
| | 2. | Masonry (See Notes 3 and 4) | 0.09 |
| | 3. | Cavity and airspace (115 to 140 mm, made up of 90 mm stud + 25 mm to 50 mm airspace non-reflective and unventilated) | 0.17 |
| | 4. | Plasterboard, gypsum (10 mm, 880 kg/m ³) | 0.06 |
| | 5. | Indoor air film (still air) | 0.12 |
| | <i>Total R-Value</i> | | |
| (b) Cavity masonry – 20 mm to 50 mm cavity, 10 mm internal plaster on battens or furring channels | 1. | Outdoor air film (7 m/s) | 0.04 |
| | 2. | Masonry (See Notes 3 and 4) | 0.09 |
| | 3. | Masonry cavity (20 mm to 50 mm, non-reflective and unventilated) | 0.17 |
| | 4. | Masonry (See Note 4) | 0.09 |
| | 5. | Airspace (20 mm to 35 mm, non-reflective and unventilated) | 0.17 |
| | 6. | Plasterboard, gypsum (10 mm, 880 kg/m ³) | 0.06 |
| | 7. | Indoor air film (still air) | 0.12 |
| <i>Total R-Value</i> | | | 0.74 |

Deemed-to-Satisfy Provisions

Figure 2 TYPICAL R-VALUES FOR WALL CONSTRUCTION— continued

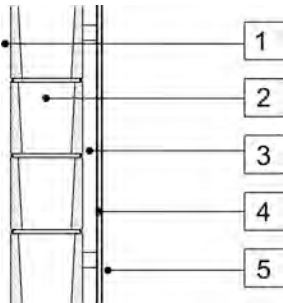
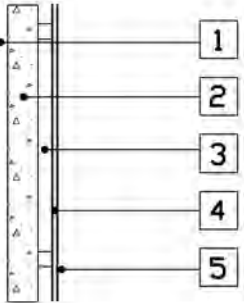
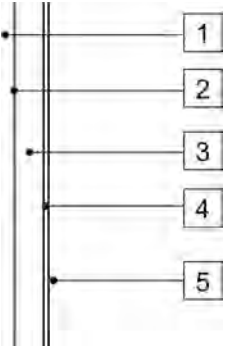
| External wall construction description | Item | Item description | R-Value |
|---|----------------------|---|---------|
| (c) Dense weight hollow concrete block with internal plaster on battens or furring channels  | 1. | Outdoor air film (7 m/s) | 0.04 |
| | 2. | Dense weight hollow concrete block (See Notes 3 and 4) | 0.15 |
| | 3. | Airspace (20 mm to 40 mm non-reflective and unventilated) | 0.17 |
| | 4. | Plasterboard, gypsum (10 mm, 880 kg/m ³) | 0.06 |
| | 5. | Indoor air film (still air) | 0.12 |
| | <i>Total R-Value</i> | | |
| (d) 125 mm solid reinforced concrete (dense weight) – 10 mm internal plaster on battens or furring channels  | 1. | Outdoor air film (7 m/s) | 0.04 |
| | 2. | 125 mm minimum solid reinforced concrete (See Note 3) | 0.09 |
| | 3. | Airspace (20 mm to 40 mm non-reflective and unventilated) | 0.17 |
| | 4. | Plasterboard, gypsum (10 mm, 880 kg/m ³) | 0.06 |
| | 5. | Indoor air film (still air) | 0.12 |
| | <i>Total R-Value</i> | | |
| (e) Timber wall – external 6 mm cement sheet cladding, 90 mm stud frame, 10 mm plaster  | 1. | Outdoor air film (7 m/s) | 0.04 |
| | 2. | Fibre-cement (6 mm, 1360 kg/m ³) | 0.03 |
| | 3. | Airspace (90 mm nonreflective and unventilated) | 0.17 |
| | 4. | Plasterboard, gypsum (10 mm, 880 kg/m ³) | 0.06 |
| | 5. | Indoor air film (still air) | 0.12 |
| | <i>Total R-Value</i> | | |

Deemed-to-Satisfy Provisions

Figure 2 TYPICAL R-VALUES FOR WALL CONSTRUCTION— continued

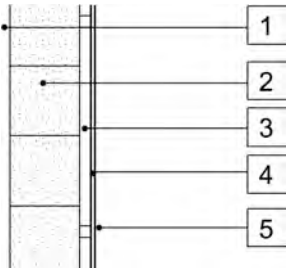
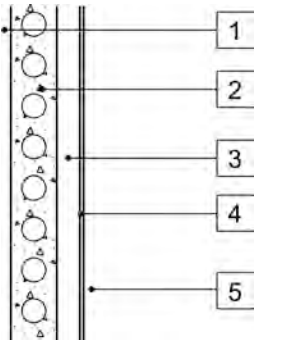
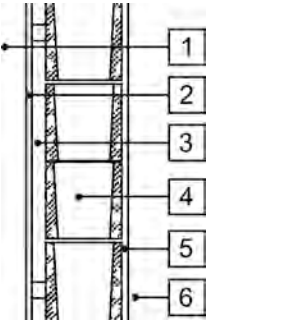
| External wall construction description | Item | Item description | R-Value | |
|---|--|---|--------------------------|------|
| (f) 200 mm autoclaved aerated concrete block – 10 mm internal plaster on battens or furring channels  | 1. | Outdoor air film (7 m/s) | 0.04 | |
| | 2. | Autoclaved aerated concrete block (200 mm, 350 kg/m ³) | 2.00 | |
| | 3. | Airspace (20 mm to 40 mm non-reflective and unventilated) | 0.17 | |
| | 4. | Plasterboard, gypsum (10 mm, 880 kg/m ³) | 0.06 | |
| | 5. | Indoor air film (still air) | 0.12 | |
| | <i>Total R-Value</i> | | | 2.39 |
| | (g) 150 mm hollow-core concrete panels – 10 mm internal plaster on battens or furring channels  | 1. | Outdoor air film (7 m/s) | 0.04 |
| 2. | | Prestressed hollow-core concrete panels (150 mm, 1,680 kg/m ³ , 30% cores) | 0.14 | |
| 3. | | Airspace (20 mm to 40 mm non-reflective and unventilated) | 0.17 | |
| 4. | | Plasterboard, gypsum (10 mm, 880 kg/m ³) | 0.06 | |
| 5. | | Indoor air film (still air) | 0.12 | |
| <i>Total R-Value</i> | | | 0.53 | |
| (h) Dense weight hollow concrete block with external 6 mm cement sheet cladding on battens or furring channels  | | 1. | Outdoor air film (7 m/s) | 0.04 |
| | 2. | Fibre-cement (6 mm, 1360 kg/m ³) | 0.03 | |
| | 3. | Airspace (20 mm to 40 mm non-reflective and unventilated) | 0.17 | |
| | 4. | Dense weight hollow concrete block (See Note 4) | 0.15 | |
| | 5. | 10 mm render | 0.02 | |
| | 6. | Indoor air film (still air) | 0.12 | |
| | <i>Total R-Value</i> | | | 0.53 |

Deemed-to-Satisfy Provisions

Figure 2 TYPICAL R-VALUES FOR WALL CONSTRUCTION— continued

| External wall construction description | Item | Item description | R-Value |
|--|------|--|---------|
| Notes: | | | |
| 1. The <i>R-Value</i> of an item, other than an airspace, air film or air cavity, may be increased in proportion to the increased thickness of the item. | | | |
| 2. The <i>Total R-Value</i> of a form of construction may be increased by the amount that an individual item is increased. | | | |
| 3. The addition of 10 mm of render to a concrete or masonry wall will increase the <i>Total R-Value</i> by 0.02. | | | |
| 4. (a) The typical <i>R-Value</i> in Figure 2(a) and (b) is for 90 mm dense weight concrete block. | | | |
| (b) The typical <i>R-Value</i> in Figure 2(c) and (h) is for 140 mm dense weight hollow concrete block. | | | |
| (c) The typical <i>R-Value</i> in Figure 2(d) is for 125 mm solid reinforced concrete (2400 kg/m ³). | | | |
| (d) Other typical <i>R-Values</i> for masonry and concrete are as follows and may be substituted for those above: | | | |
| 90 mm clay brick: | | | |
| | | (density 1430 kg/m ³) | 0.16 |
| | | (density 1690 kg/m ³) | 0.14 |
| | | (density 1950 kg/m ³) | 0.12 |
| 110 mm clay brick: | | | |
| | | (density 1430 kg/m ³ , 2.75 kg/brick) | 0.20 |
| | | (density 1690 kg/m ³ , 3.25 kg/brick) | 0.17 |
| | | (density 1950 kg/m ³ , 3.75 kg/brick) | 0.14 |
| Dense weight hollow concrete block: | | | |
| | | 110 mm | 0.12 |
| | | 190 mm | 0.20 |
| 5. The <i>Total R-Values</i> in this Figure are for <i>external walls</i> . The <i>Total R-Value</i> for an internal wall of the same construction would be 0.08 greater because the <i>R-Value</i> for an outdoor air film would be replaced by that of an indoor air film. | | | |
| 6. Where a cavity or airspace is filled, the <i>R-Value</i> listed for the cavity must be deducted from the <i>Total R-Value</i> of the wall. | | | |

SPECIFICATION **J1.6** FLOOR CONSTRUCTION

Deemed-to-Satisfy Provisions

1. Scope

This Specification describes the thermal performance of some common forms of floor construction.

2. Construction Deemed-to-Satisfy

Figure 2 details the *R-Values* considered to be achieved by some common forms of floor construction, other than a concrete floor with an embedded floor heating or cooling system.

Figure 2 TYPICAL R-VALUES FOR FLOOR CONSTRUCTION (for a floor without a floor heating or cooling system)

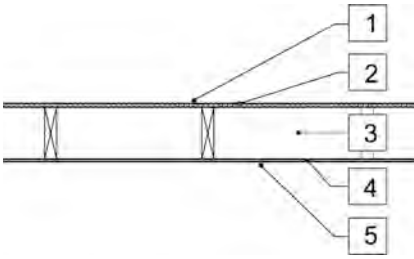
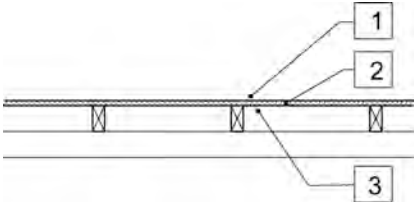
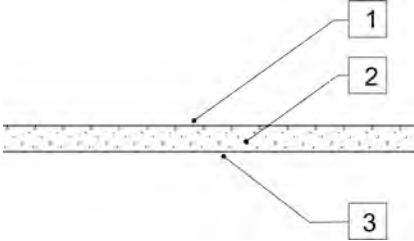
| Floor construction description | Item | Item description | <i>R-Value</i> | |
|---|----------------------|--|----------------|------|
| | | | Up | Down |
| (a) Timber internal floor, 10 mm internal plaster  | 1. | Indoor air film (still air) | 0.11 | 0.16 |
| | 2. | Particleboard flooring (19 mm, 640 kg/m ³) | 0.15 | 0.15 |
| | 3. | Floor airspace, 100 mm to 300 mm (non reflective) | 0.15 | 0.22 |
| | 4. | Plasterboard, gypsum (10 mm, 880 kg/m ³) | 0.06 | 0.06 |
| | 5. | Indoor air film (still air) | 0.11 | 0.16 |
| | <i>Total R-Value</i> | | | 0.58 |
| (b) Timber, suspended ground floor, open sub-floor  | 1. | Indoor air film (still air) | 0.11 | 0.16 |
| | 2. | Particleboard flooring (19 mm, 640 kg/m ³) | 0.15 | 0.15 |
| | 3. | Outdoor air film (7 m/s) | 0.04 | 0.04 |
| | <i>Total R-Value</i> | | | 0.30 |
| (c) Solid concrete suspended slab  | 1. | Indoor air film (still air) | 0.11 | 0.16 |
| | 2. | Solid concrete (150 mm, 2400 kg/m ³) | 0.10 | 0.10 |
| | 3. | Outdoor air film (7 m/s) | 0.04 | 0.04 |
| | <i>Total R-Value</i> | | | 0.25 |

Deemed-to-Satisfy Provisions

Figure 2 TYPICAL R-VALUES FOR FLOOR CONSTRUCTION (for a floor without a floor heating or cooling system)— continued

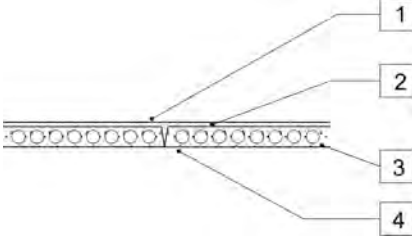
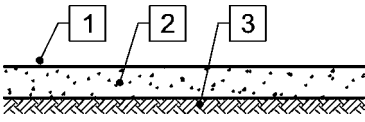
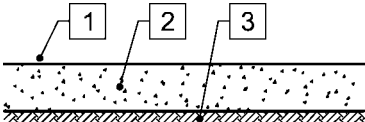
| Floor construction description | Item | Item description | R-Value | |
|--|----------------------|---|---------|------|
| | | | Up | Down |
| (d) 150 mm hollow-core concrete planks  | 1. | Indoor air film (still air) | 0.11 | 0.16 |
| | 2. | Concrete topping (60 mm, 2,400 kg/m ³) | 0.04 | 0.04 |
| | 3. | Hollow-core concrete planks (150 mm, 1,680 kg/m ³ , 30% cores) | 0.14 | 0.14 |
| | 4. | Outdoor air film (7 m/s) | 0.04 | 0.04 |
| | <i>Total R-Value</i> | | | 0.33 |
| (e) 100 mm solid concrete slab-on-ground  | 1. | Indoor air film (still air) | 0.11 | 0.16 |
| | 2. | Solid concrete (100 mm, 2400 kg/m ³) | 0.07 | 0.07 |
| | 3. | Ground thermal resistance | - | - |
| | <i>Total R-Value</i> | | | 0.18 |
| (f) 150 mm solid concrete slab-on-ground  | 1. | Indoor air film (still air) | 0.11 | 0.16 |
| | 2. | Solid concrete (150 mm, 2400 kg/m ³) | 0.10 | 0.10 |
| | 3. | Ground thermal resistance | - | - |
| | <i>Total R-Value</i> | | | 0.21 |

Notes:

1. The *R-Value* of an item, other than an airspace, air film or air cavity, may be increased in proportion to the increased thickness of the item.
2. The *Total R-Value* of a form of construction may be increased by the amount that an individual item is increased.
3. For floor types (c) and (d) that are located over an internal space, the *Total R-Value* can be calculated by replacing the value for outdoor air film (R0.04) on the underside of the floor with the value for indoor air film (R0.11 for heat flow up or R0.16 for heat flow down).
4. For floor types (b), (c) and (d) located over ground with an enclosed perimeter, the *Total R-Value* can be calculated by replacing the value for outdoor air film (R0.04) on the underside of the floor with the value for indoor air film plus ground thermal resistance (i.e. R0.11+R0.56=R0.67 for heat flow up, or R0.16+R0.58=R0.74 for heat flow down).
5. Where reflective building membrane is attached beneath the floor with a 100 mm reflective airspace, add R0.38 for heat flow up and R1.14 for heat flow down.
6. Where ground floor construction with an enclosed perimeter makes the airspace adjacent to the ground reflective, the face down sub-floor air films will be R0.23 instead of R0.11 for heat flow up, and R0.80 instead of R0.16 for heat flow down.
7. The addition of 10 mm of render to the ceiling of a suspended internal concrete floor will increase the *Total R-Value* by 0.02.
8. Solid concrete slab includes concrete beam and infill floors and concrete precast permanent formwork panels.

Deemed-to-Satisfy Provisions

Figure 2 TYPICAL R-VALUES FOR FLOOR CONSTRUCTION (for a floor without a floor heating or cooling system)— continued

| Floor construction description | Item | Item description | <i>R-Value</i> | |
|--|------|------------------|----------------|------|
| | | | Up | Down |
| 9. Where an airspace is filled, the <i>R-Value</i> listed for the airspace must be deducted from the <i>Total R-Value</i> of the floor construction. | | | | |

SPECIFICATION **J5.2** DUCTWORK INSULATION AND SEALING

Deemed-to-Satisfy Provisions

1. **Scope**

This Specification contains the requirements for the sealing and the insulating of supply and return ductwork used in a system that heats or cools a building.

2. **Ductwork sealing**

- (a) Heating or cooling ductwork and fittings must be sealed against air loss—
 - (i) by closing all openings in the surface, joints and seams of ductwork with adhesives, mastics, sealants or gaskets in accordance with the duct sealing requirements of AS 4254 Parts 1 and 2 for the static pressure in the system; or
 - (ii) for flexible ductwork at an operating static pressure of less than 500 Pa, with a draw band in conjunction with a sealant or adhesive tape.
- (b) The requirements of (a) do not apply to ductwork and fittings located within the only or last room that is served by the system.

3. **Ductwork insulation**

- (a) Insulation must be provided on ductwork and fittings, used for heating or cooling, including evaporative cooling, with insulation complying with AS/NZS 4859.1 and—
 - (i) achieve the material *R-Value* specified in **Table 3**; or
 - (ii) for flexible ductwork of no more than 3 m in length to an outlet or from an inlet, achieve a minimum material *R-Value* of 1.0.
- (b) Insulation on ductwork conveying cold air must be protected by—
 - (i) a vapour barrier on the outside of the insulation; and
 - (ii) where the vapour barrier is a membrane, overlapping adjoining sheets of the membrane by 50 mm and bonding or taping the sheets together.
- (c) Ductwork insulation must—
 - (i) be protected against the effects of weather and sunlight; and
 - (ii) abut adjoining insulation to form a continuous barrier; and
 - (iii) be installed so that it maintains its position and thickness, other than at flanges and supports.
- (d) The requirements of (a) do not apply to—
 - (i) heating and cooling ductwork and fittings located within the only or last room that is served by the system; and
 - (ii) air registers, diffusers, outlets, grilles and flexible fan connections; and
 - (iii) return air ductwork in, or passing through, a *conditioned space*; and

Deemed-to-Satisfy Provisions

- (iv) ductwork for outside air and exhaust air associated with a heating or cooling system; and
- (v) the floor of an in-situ air-handling unit; and
- (vi) packaged air-conditioning equipment complying with Minimum Energy Performance Standard (MEPS).

Table 3 DUCTWORK AND FITTINGS - MINIMUM MATERIAL R-VALUE

| Location of ductwork and fittings | Minimum material <i>R-Value</i> for ductwork and fittings in each <i>climate zone</i> | | |
|-----------------------------------|---|------------|-----|
| | 1, 2, 3 and 5 | 4, 6 and 7 | 8 |
| Within a <i>conditioned space</i> | 1.2 | 1.2 | 1.6 |
| Where exposed to direct sunlight | 3.0 | 3.0 | 3.4 |
| All other locations | 2.0 | 2.0 | 2.4 |

SPECIFICATION **J5.4** INSULATING OF PIPING, VESSELS, HEAT EXCHANGERS AND TANKS

Deemed-to-Satisfy Provisions

1. **Scope**

- (a) This Specification contains the requirements for the insulating of *piping*, vessels, heat exchangers and tanks containing heating fluids or cooling fluids.
- (b) For the purposes of this Specification—
 - (i) heating fluids include hot water, steam and condensate; and
 - (ii) cooling fluids include refrigerant, chilled water and brines and glycol mixtures, but not condenser cooling water to or from a cooling tower.

2. **Insulation**

- (a) Insulation provided on *piping*, vessels, heat exchangers and tanks must comply with AS/NZS 4859.1 and—
 - (i) be protected against the effects of weather and sunlight; and
 - (ii) be able to withstand the temperatures within the *piping*, vessel, heat exchanger or tank; and
 - (iii) for—
 - (A) heating water and cooling water *piping*, achieve the material *R-Value* in **Table 2a**; and
 - (B) refrigerant, steam and condensate *piping*, achieve the material *R-Value* in **Table 2b**; and
 - (iv) for vessels, heat exchangers and tanks, achieve a minimum material *R-Value* of—
 - (A) 2.7 if the content is refrigerant, low temperature brine or glycol that is not more than 2°C; or
 - (B) 1.8 if the content is refrigerant cooling water that is more than 2°C but not more than 20°C; or
 - (C) 1.4 if the content is heating water; or
 - (D) 2.5 if the content is steam.
- (b) Insulation on *piping*, vessels, heat exchangers and tanks containing chilled fluid must be protected by a vapour barrier on the outside of the insulation.
- (c) The requirements of **(a)** do not apply to *piping*—
 - (i) located within the *conditioned space* where the *piping*, and fittings which provide heating and cooling to that space are located within the last or only room that is served by the system; or
 - (ii) encased within a concrete slab or panel which is part of a heating or cooling system; or
 - (iii) supplied as an integral part of a piece of plant; or

Deemed-to-Satisfy Provisions

- (iv) inside an air-handling unit, fan-coil unit or the like.

Table 2a WATER PIPING - MINIMUM MATERIAL R-VALUE

| Location | Minimum material <i>R-Value</i> for each <i>climate zone</i> | | |
|---|--|------------|-----|
| | 1, 2, 3 and 5 | 4, 6 and 7 | 8 |
| 1. Heating water <i>pip</i>ing for systems of not more than 65 kW_{heating} capacity | | | |
| (a) Located internally | 1.0 | 1.0 | 1.3 |
| (b) Located within a wall space, an enclosed sub-floor area or an enclosed roof space | 1.1 | 1.1 | 1.4 |
| (c) Located outside the building, an unenclosed sub-floor area or an unenclosed roof space | 1.2 | 1.2 | 1.5 |
| 2. Heating water <i>pip</i>ing for systems of more than 65 kW_{heating} capacity | | | |
| (a) Located internally | 1.0 | 1.0 | 1.7 |
| (b) Located within a wall space, an enclosed sub-floor area or an enclosed roof space | 1.1 | 1.1 | 1.8 |
| (c) Located outside the building or in an unenclosed sub-floor area or an unenclosed roof space | 1.2 | 1.5 | 1.9 |
| 3. Cooling water <i>pip</i>ing for systems of not more than 65 kW_r capacity | | | |
| (a) Located internally | 1.0 | 0.6 | 0.6 |
| (b) Located within a wall space, an enclosed sub-floor area or an enclosed roof space | 1.1 | 0.7 | 0.7 |
| (c) Located outside the building or in an unenclosed sub-floor area or an unenclosed roof space | 1.2 | 0.8 | 0.8 |
| 4. Cooling water <i>pip</i>ing for systems of more than 65 kW_r capacity but not more than 250 kW_r capacity | | | |
| (a) Located internally | 1.7 | 1.3 | 1.0 |
| (b) Located within a wall space, an enclosed sub-floor area or an enclosed roof space | 1.8 | 1.4 | 1.1 |
| (c) Located outside the building or in an unenclosed sub-floor area or an unenclosed roof space | 1.9 | 1.5 | 1.2 |

Deemed-to-Satisfy Provisions

Table 2a WATER PIPING - MINIMUM MATERIAL R-VALUE— continued

| Location | Minimum material <i>R-Value</i> for each <i>climate zone</i> | | |
|---|--|------------|-----|
| | 1, 2, 3 and 5 | 4, 6 and 7 | 8 |
| 5. Cooling water <i>pip</i>ing for systems of more than 250 kW, capacity | | | |
| (a) Located internally | 2.0 | 1.7 | 1.3 |
| (b) Located within a wall space, an enclosed sub-floor area or an enclosed roof space | 2.1 | 1.8 | 1.4 |
| (c) Located outside the building or in an unenclosed sub-floor area or an unenclosed roof space | 2.2 | 1.9 | 1.5 |
| Notes: | | | |
| 1. <i>Pip</i> ing to be insulated includes all flow and return <i>pip</i> ing, cold water supply <i>pip</i> ing within 500 mm of the connection to the heating or cooling system and pressure relief <i>pip</i> ing within 500 mm of the connection to the heating or cooling system. | | | |
| 2. For <i>pip</i> ing diameters of not more than 32 mm, for the last 750 mm adjoining items of plant, the insulation material <i>R-Value</i> may be— | | | |
| (a) halved; or | | | |
| (b) reduced to R0.6 where local clearances do not allow insulation to be installed in accordance with (a). | | | |
| 3. For <i>pip</i> ing penetrating a structural member, the insulation material <i>R-Value</i> may be halved. | | | |

Table 2b REFRIGERANT, STEAM AND CONDENSATE PIPING— MINIMUM MATERIAL R-VALUE

| Temperature range | Nominal pipe size | | | | |
|--|---|----------------|------------------|--------|--------|
| | 15 mm to 40 mm | 50 mm to 80 mm | 100 mm to 125 mm | 150 mm | 200 mm |
| Refrigerant not more than 2°C | 1.3 | 1.7 | 2.0 | 2.0 | 2.7 |
| Refrigerant more than 2°C but not more than 20°C | As for cooling water in Table 2a | | | | |
| Steam and condensate not more than 120°C | 1.0 | 1.0 | 1.3 | 1.3 | 1.3 |
| Steam more than 120°C | 1.5 | 1.5 | 1.5 | 1.8 | 2.1 |

SPECIFICATION **J6**

**LIGHTING AND POWER CONTROL
DEVICES**

Deemed-to-Satisfy Provisions

1. Scope

This Specification contains the requirements for lighting and power control devices including timers, time switches, motion detectors and daylight control devices.

2. Lighting timers

A lighting timer must—

- (a) be located within 2 m of every entry door to the space; and
- (b) have an indicator light that is illuminated when the artificial lighting is off; and
- (c) not control more than—
 - (i) an area of 100 m² with a single push button timer; and
 - (ii) 95% of the lights in spaces of area more than 25 m²; and
- (d) be capable of maintaining the artificial lighting—
 - (i) for not less than 5 minutes and not more than 15 minutes unless it is reset; and
 - (ii) without interruption if the timer is reset.

3. Time switch

- (a) A time switch must be capable of switching on and off electric power at variable pre-programmed times and on variable pre-programmed days.
- (b) A time switch for internal lighting must be capable of being overridden by—
 - (i) a means of turning the lights on, either by—
 - (A) a manual switch or an occupant sensing device that on sensing a person's presence, overrides the time switch for a period of up to 2 hours, after which there is no further presence detected, the time switch must resume control; or
 - (B) an occupant sensing device that overrides the time switch upon a person's entry and returns control to the time switch upon the person's exiting, such as a security card reader; and
 - (ii) a manual "off" switch.
- (c) A time switch for external lighting must be capable of—
 - (i) limiting the period the system is switched on to between 30 minutes before sunset and 30 minutes after sunrise is determined or detected including any pre-programmed period between these times; and
 - (ii) being overridden by a manual switch or a security access system for a period of up to 30 minutes, after which the time switch must resume control.

Deemed-to-Satisfy Provisions

- (d) A time switch for boiling water and chilled water storage units must be capable of being overridden by a manual switch or a security access system that senses a person's presence, overrides for a period of up to 2 hours, after which if there is no further presence detected, the time switch must resume control.

4. Motion detectors

- (a) In a Class 2, 3 or 9c *aged care building* other than within a *sole-occupancy unit*, a motion detector must—
- (i) be capable of sensing movement such as by infra-red, ultrasonic or microwave detection or by a combination of these means; and
 - (ii) be capable of detecting a person before they are 1 m into the space; and
 - (iii) other than within a *sole-occupancy unit* of a Class 3 building, not control more than—
 - (A) an area of 100 m²; and
 - (B) 95% of the lights in spaces of area more than 25 m²; and
 - (iv) be capable of maintaining the artificial lighting when activated—
 - (A) for not less than 5 minutes and not more than 15 minutes unless it is reset; and
 - (B) without interruption if the motion detector is reset by movement.
- (b) In a Class 5, 6, 7, 8, 9a or 9b building, a motion detector must—
- (i) be capable of sensing movement such as by infra-red, ultrasonic or microwave detection or by a combination of these means; and
 - (ii) be capable of detecting—
 - (A) a person before they have entered 1 m into the space; and
 - (B) movement of 500 mm within the useable part of the space; and
 - (iii) not control more than—
 - (A) in other than a *carpark*, an area of 500 m² with a single sensor or group of parallel sensors; and
 - (B) 75% of the lights in spaces using high intensity discharge; and
 - (iv) be capable of maintaining the artificial lighting when activated—
 - (A) for a maximum of 30 minutes unless it is reset; and
 - (B) without interruption if the motion detector is reset by movement; and
 - (v) not be overridden by a manual switch to permanently leave the lights on.
- (c) When outside a building, a motion detector must—
- (i) be capable of sensing movement such as by infra-red, ultrasonic or microwave detection or by a combination of these means; and
 - (ii) be capable of detecting a person within a distance from the light equal to—
 - (A) twice the mounting height; or
 - (B) 80% of the ground area covered by the light's beam; and

Deemed-to-Satisfy Provisions

- (iii) not control more than five lights; and
- (iv) be operated in series with a photoelectric cell or astronomical time switch so that the light will not operate in daylight hours; and
- (v) be capable of maintaining the artificial lighting when the switch is on for a maximum of 10 minutes unless it is reset; and
- (vi) have a manual override switch which is reset after a maximum period of 4 hours.

5. Daylight sensor and dynamic lighting control device

- (a) A daylight sensor and dynamic control device for artificial lighting must—
 - (i) for switching on and off—
 - (A) be capable of having the switching level set point adjusted between 50 and 1000 Lux; and
 - (B) have—
 - (aa) a delay of more than 2 minutes; and
 - (bb) a differential of more than 100 Lux for a sensor controlling high pressure discharge lighting, and 50 Lux for a sensor controlling other than high pressure discharge lighting; and
 - (ii) for dimmed or stepped switching, be capable of reducing the power consumed by the controlled lighting in proportion to the incident daylight on the working plane either—
 - (A) continuously down to a power consumption that is less than 50% of full power; or
 - (B) in no less than 4 steps down to a power consumption that is less than 50% of full power.
- (b) Where a daylight sensor and dynamic control device has a manual override switch, the manual override switch must not be able to switch the lights permanently on or bypass the lighting controls.

COMMONWEALTH OF AUSTRALIA

APPENDIX CONTENTS

APPENDIX COMMONWEALTH OF AUSTRALIA

Commonwealth of Australia

Footnote: Other Legislation and Policies Affecting Buildings

Footnote: OTHER LEGISLATION AND POLICIES AFFECTING BUILDINGS

In addition to any applicable provisions of this Code, there are a number of other legislative technical requirements and policies affecting the design, construction and/or performance of buildings that practitioners may need to be aware of, including, but not necessarily limited to, the following list. Additional legislative instruments such as regulations, codes and standards may exist under the legislation listed.

1. Aged Care Buildings

1.1 Administering Agency:

Department of Health and Ageing

Relevant Legislation:

Aged Care Act 1997

1999 Certification Assessment Instrument

2. Australian Capital Territory

2.1 Administering Agency:

Department of Regional Australia, Regional Development and Local Government

Relevant Legislation:

Australian Capital Territory (Planning and Land Management) Act 1988

Parliament Act 1974

3. Child Care

3.1 Administering Agency:

Department of Education, Employment and Workplace Relations

Relevant Legislation:

Child Care Act 1972

4. Christmas Island

4.1 Administering Agency:

Department of Regional Australia, Regional Development and Local Government

Relevant Legislation:

Casino Control Ordinance 1988

Casino Control Regulations 1988

Christmas Island Space Centre (APSC Proposal) Ordinance 2001

Christmas Island Space Centre (APSC Proposal) Regulations 2001

Gambling (Clubs) Ordinance 1978

Christmas Island Act 1958

5. Communications and Information Technology

5.1 Administering Agency:

Department of Broadband, Communications and the Digital Economy

Relevant Legislation:

Australian Postal Corporation Act 1989

National Transmission Network Sale Act 1998

Telecommunications Act 1997

Telstra Corporation Act 1991

6. Defence Buildings

6.1 Administering Agency:

Department of Defence

Relevant Legislation:

Defence Act 1903

Defence (Areas Control) Regulations 1989

Infrastructure Management

Defence Safety Manual

Contamination Manual

Defence Energy, Water and Waste Strategy

Manual of Fire Protection Engineering

Requirements for the Provision of Disabled Access and other Facilities for Disabled Persons in Defence Facilities

Defence Green Building Requirements

7. Disability Discrimination

7.1 Administering Agency:

Attorney-General's Department

Relevant Legislation:

Disability Discrimination Act 1992

8. Environment

8.1 Administering Agency:

Department of Sustainability, Environment, Water, Population and Communities

Relevant Legislation:

Environmental Protection and Biodiversity Conservation Act 1999

8.2 Administering Agency:

Department of Climate Change and Energy Efficiency

Relevant Policy:

Energy Efficiency in Government Operations (2006)

9. Federal Airports

9.1 Administering Agency:

Department of Infrastructure and Transport

Relevant Legislation:

Airports Act 1996

Airports Regulations 1997

Airports (Building Control) Regulations 1996

Airports (Control of On-Airport Activities) Regulations 1997

Airports (Environmental Protection) Regulations 1997

10. Jervis Bay Territory

10.1 Administering Agency

Department of Regional Australia, Regional Development and Local Government

Relevant Legislation

Jervis Bay Territory Acceptance Act 1915

11. Occupational Health and Safety

11.1 Administering Agency:

Department of Education, Employment and Workplace Relations

Relevant Legislation:

Occupational Health and Safety Act 1991

Occupational Health and Safety (Safety Standards) Regulations 1994

AUSTRALIAN CAPITAL TERRITORY

INTRODUCTION

The Australian Capital Territory BCA Appendix forms part of the ACT Building Code published in accordance with the provisions of the ACT Building Act 2004. This Appendix contains variations and additions to the Building Code of Australia which are necessary for the effective application of the Code in the Australian Capital Territory.

APPENDIX CONTENTS

APPENDIX AUSTRALIAN CAPITAL TERRITORY

Australian Capital Territory

A GENERAL PROVISIONS

ACT Specification A1.3 Documents Adopted by Reference
ACT AO2 Objective
ACT AF2.1 - AF2.2 Functional Statements
ACT AP2.1 - ACT AP2.2 Performance Requirements
ACT A2.0 Deemed-to-Satisfy Provisions
ACT A2.101 Control of litter on building sites
ACT A2.102 Waste management

D ACCESS AND EGRESS

ACT D1.101 Notices on fire-isolated stairs
ACT D1.102 Access for people with disabilities

G ANCILLARY PROVISIONS

ACT GO1 Objective
ACT GF1.2 Functional Statements
ACT GP1.2 Performance Requirements
ACT G1.1 Swimming pools
ACT G2.2 Installation of appliances

J ENERGY EFFICIENCY

ACT J1.1 Sustainability

Footnote: Other Legislation Affecting Buildings

SECTION A GENERAL PROVISIONS

PART A1 INTERPRETATION

ACT Specification A1.3 DOCUMENTS ADOPTED BY REFERENCE

Insert in Table 1 of Specification A1.3 the following:

ACT Table 1: SCHEDULE OF REFERENCED DOCUMENTS

| No. | Date | Title | BCA Clause(s) |
|--|------|---|---------------|
| AS 1375 | 1985 | Industrial fuel-fired appliances | ACT G2.2 |
| AS 1692 | 2006 | Tanks for flammable and combustible liquids | ACT G2.2 |
| Development Control Code for Best Practice Waste Management in the ACT | | | ACT A2.102 |

PART A2 ACCEPTANCE OF DESIGN AND CONSTRUCTION

Add ACT AO2 as follows:

| |
|------------------|
| OBJECTIVE |
|------------------|

ACT AO2

The *Objective* of this Part is to—

- (a) prevent wind blown litter from building sites fouling roads and public land; and
- (b) safeguard people from injury caused by infection or contamination from solid waste.

Add ACT AF2.1 to ACT AF2.2 as follows:

| |
|------------------------------|
| FUNCTIONAL STATEMENTS |
|------------------------------|

ACT AF2.1

Building litter must be prevented from spreading around and beyond the allotment boundary.

ACT AF2.2

Buildings must be provided with space and facilities for the collection, and safe, hygienic holding prior to disposal of solid waste arising from the intended use of the building.

Add ACT AP2.1 to ACT AP2.2 as follows:

PERFORMANCE REQUIREMENTS

ACT AP2.1

Sufficient containers must be provided on building sites to store building waste that is likely to become windblown.

ACT AP2.2

Provision must be made within buildings for the collection and temporary holding of solid waste. The design must accommodate screening, volume of waste, disposal, logistics and access.

Add ACT A2.0 as follows:

ACT A2.0 Deemed-to-Satisfy Provisions

Performance Requirements **ACT AP2.1** to **ACT AP2.2** are satisfied by complying with **ACT A2.101** to **ACT A2.102**.

Add ACT A2.101 to ACT A2.103 as follows:

ACT A2.101 Control of litter on building sites

- (a) On-site building waste must be stored in suitable size plastic or metal bins and removed from the allotment at regular intervals.
- (b) For the purpose of this clause, building waste includes plastic containers, plastic and paper wrappings, or any waste that can be carried by wind.

ACT A2.102 Waste management

Garbage facilities must be designed and constructed in accordance with the Development Control Code for Best Practice Waste Management in the ACT.

SECTION D ACCESS AND EGRESS

PART D1 PROVISION FOR ESCAPE

Add ACT D1.101 and ACT D1.102 as follows:

ACT D1.101 Notices on fire-isolated stairs

- (a) Every *fire-isolated stairway* must have a notice displayed in a conspicuous position at the landing on each *storey* level to the effect of the following:

OFFENCES RELATING TO FIRE STAIRS

Under the Emergencies Act 2004 it is an offence to:

1. Place anything in this stairway or any associated passageway leading to the exterior of the building which may impede the free passage of persons; or
2. Interfere with or cause obstruction or impediment to the normal operation of fire doors providing access to this stairway; or

3. Remove, damage or otherwise interfere with this notice.

- (b) In any notice displayed in accordance with (a)—
 - (i) the words “OFFENCES RELATING TO FIRE STAIRS” must be in letters not less than 20 mm in height; and
 - (ii) all other letters and figures in the remainder of the notice must be not less than 3 mm in height; and
 - (iii) the notice must be clearly legible with lettering of a colour contrasting with the background embossed or cast into a permanent plate securely and permanently fixed to the wall.

ACT D1.102 Access for people with disabilities

- (a) Other requirements must be considered in respect of requirements for people with disabilities, including the ACT Territory Plan under the Planning and Development Act 2008 (ACT) and the Disability Discrimination Act 2004 (Commonwealth), and any further applicable amendments to this Appendix. Where additional provisions of the ACT Appendix to NCC Volume One have been made by instrument under the Building Act 2004 (ACT), relevant building work or buildings may comply with the applicable provisions, as permitted by the provisions.
- (b) At the time of publishing NCC 2013 additional NCC Volume One provisions about access for people with disabilities, and to make certain buildings more readily adaptable to the needs of people with disabilities, were under consideration for adding to the ACT Appendix to NCC Volume One. NCC Volume One users should check if the provisions have commenced, and if so their requirements and date of effect—see the latest ACT BCA appendices made under the Building Act 2004 (ACT) at: <http://www.legislation.act.gov.au/a/2004-11/di.asp>.

SECTION G ANCILLARY PROVISIONS

PART G1 MINOR STRUCTURES AND COMPONENTS

Delete GO1(c) and insert ACT GO1(c) as follows:

OBJECTIVE

ACT GO1

- (c) safeguard young children from drowning or injury in a *swimming pool*; and

Application:

ACT GO1(c) only applies to a *swimming pool* associated with a Class 2 or 3 building or Class 4 part of a building, with a depth of water more than 300 mm.

Delete GF1.2(a) and insert ACT GF1.2(a) as follows:

FUNCTIONAL STATEMENTS

ACT GF1.2

A *swimming pool* is to be provided with—

- (a) means of restricting access by young children to it; and

Application:

ACT GF1.2(a) only applies to a *swimming pool* associated with a Class 2 or 3 building or Class 4 part of a building, with a depth of water more than 300 mm.

Delete GP1.2(a) and insert ACT GP1.2(a) as follows:

PERFORMANCE REQUIREMENTS

ACT GP1.2

- (a) A barrier must be provided to a *swimming pool* and must—
- (i) be continuous for the full extent of the hazard; and
 - (ii) be of a strength and rigidity to withstand the foreseeable impact of people; and
 - (iii) restrict the access of young children to the pool and the immediate pool surrounds; and
 - (iv) have any gates and doors fitted with latching devices not readily operated by young children, and constructed to automatically close and latch.

Application:

ACT GP1.2(a) only applies to a *swimming pool* associated with a Class 2 or 3 building or Class 4 part of a building, with a depth of water more than 300 mm.

Add ACT G1.1(d) and (e) as follows:

ACT G1.1 Swimming pools

- (d) Indoor or outdoor permanent bathing, wading and *swimming pools* must—
- (i) where the capacity of the pool exceeds 10 m³—
 - (A) be of the recirculation type in which the water circulation is maintained through the pool by pumps, the water drawn from the pool being clarified and disinfected before being returned to the pool; and
 - (B) have means of egress provided in the form of ladders, steps in the floor of the pool or a ramp; and
 - (ii) be capable of being completely emptied and any discharge or overflow and pool backwash filter must be connected to the sewer drainage system.
- (e) Pools in or forming part of buildings other than Class 1 buildings—

- (i) where in any part of the pool the depth is less than 1500 mm, the floor grade must not exceed a slope of 1 in 20; and
- (ii) permanent signs must be displayed on the side of the pool (or adjacent concourse for flush concourse waterline pools), showing the depth at 300 mm change intervals for the length of the pool and the depth at the deep and shallow ends.

PART G2 HEATING APPLIANCES, CHIMNEYS AND FLUES

Add ACT G2.2 as follows:

ACT G2.2 Installation of appliances

- (d) An industrial fuel-fired appliance: AS 1375.
- (e) Storage tanks and other associated fittings: AS 1692.

SECTION J ENERGY EFFICIENCY

ACT J1.1 SUSTAINABILITY

Where additional provisions of the ACT Appendix to NCC Volume One have been made by instrument under the Building Act 2004 (ACT) relevant building work or buildings may comply with the applicable provisions of the Act.

Note:

- (a) At the time of publishing NCC 2013 additional NCC Volume One provisions about sustainability were under consideration for the ACT Appendix to NCC Volume One particularly for the energy efficiency of building extensions and alterations. NCC Volume One users should check if the provisions have commenced, and if so their requirements and date of effect—see the latest ACT BCA appendices made under the Building Act 2004 (ACT) at: <http://www.legislation.act.gov.au/a/2004-11/di.asp>.
- (b) Other ACT legislation also regulates for sustainability when constructing or altering buildings, including their services. For example, the Water and Sewerage Act 2000 has relevant provisions in relation to water heaters, water and sanitary plumbing, and sanitary drainage, which are intended to facilitate a reduction in water usage and energy used to heat water, and greenhouse gas emission. The Building (General) Regulation 2004 has provisions about applying certain BCA provisions, and alternatives to those provisions, to pre-existing parts of certain buildings, aimed at increasing the energy efficiency of the pre-existing part, amongst other things, when the pre-existing building is substantially altered or extended.

Practitioners should ensure they check the latest version of relevant legislation, and the latest version of the ACT BCA appendix, available through the ACT legislation register at www.legislation.act.gov.au.

Footnote: OTHER LEGISLATION AFFECTING BUILDINGS

In addition to any applicable provisions of the Building Act 2004 and this Code, there are a number of other legislative technical requirements affecting the design, construction and/or performance of buildings that practitioners may need to be aware of, including, but not

necessarily limited to, the following list. Additional legislative instruments such as regulations, codes and standards may exist under the legislation listed.

1. Construction Occupations

1.1 Administering Agency

Environment and Sustainable Development Directorate

Relevant Legislation

Construction Occupations (Licensing) Act 2004

2. Dangerous Substances

2.1 Administering Agency

Chief Minister and Cabinet Directorate

Justice and Community Safety Directorate

Relevant Legislation

Dangerous Substances Act 2004

3. Electricity and Gas Safety

3.1 Administering Agency

Environment and Sustainable Development Directorate

Relevant Legislation

Electricity Safety Act 1971

Gas Safety Act 2000

4. Environmental Protection and Nature Conservation

4.1 Administering Agency

Territory and Municipal Services Directorate

Relevant Legislation

Environment Protection Act 1997

Nature Conservation Act 1980

5. Fences and Party Walls

5.1 Administering Agency

Environment and Sustainable Development Directorate

Relevant Legislation

Common Boundaries Act 1981

6. Fire Safety

6.1 Administering Agency

Justice and Community Safety Directorate

Territory and Municipal Services Directorate

Relevant Legislation

Emergencies Act 2004

7. Heritage Conservation

7.1 Administering Agency

Territory and Municipal Services Directorate

Relevant Legislation

Heritage Act 2004

8. Land Use and Development Control

8.1 Administering Agency

Environment and Sustainable Development Directorate

Relevant Legislation

Planning and Development Act 2007

Unit Titles Act 2001

9. Liquor Premises

9.1 Administering Agency

Justice and Community Safety Directorate

Relevant Legislation

Liquor Act 2010

10. Machinery, Scaffolding and Lifts

10.1 Administering Agency

Chief Minister and Cabinet Directorate

Justice and Community Safety Directorate

Relevant Legislation

Machinery Act 1949

Scaffolding and Lifts Act 1912

11. Occupational Health and Safety

11.1 Administering Agency

Chief Minister and Cabinet Directorate

Justice and Community Safety Directorate

Relevant Legislation

Work Safety Act 2008

12. Plumbing and Drainage

12.1 Administering Agency

Environment and Sustainable Development Directorate

Relevant Legislation

Water and Sewerage Act 2000

13. Public Health

13.1 Administering Agency

ACT Health

Relevant Legislation

Public Health Act 1997

14. Roads and Public Places

14.1 Administering Agency

Territory and Municipal Services Directorate

Relevant Legislation

Roads and Public Places Act 1937

15. Utilities

15.1 Administering Agency

Environment and Sustainable Development Directorate

Justice and Community Safety Directorate

Territory and Municipal Services Directorate

Treasury Directorate

Relevant Legislation

Utilities Act 2000

16. Waste

16.1 Administering Agency

Territory and Municipal Services Directorate

Relevant Legislation

Waste Minimisation Act 2001

17. Water and Sewerage

17.1 Administering Agency

Environment and Sustainable Development Directorate

Relevant Legislation

Water and Sewerage Act 2000

NEW SOUTH WALES

INTRODUCTION

The NSW Building Code technical package consists of-

- (i) the Building Code of Australia (BCA) Volume One and Volume Two; and
- (ii) the New South Wales BCA Appendix which contains variations to the requirements of the BCA and additional provisions applicable in New South Wales.

The technical package is accompanied by administrative provisions contained within the Environmental Planning and Assessment (EP & A) Act 1979 and the Environmental Planning and Assessment (EP & A) Regulation 2000.

APPENDIX CONTENTS

APPENDIX NEW SOUTH WALES

New South Wales

A GENERAL PROVISIONS

NSW A1.1 Definitions
NSW A3.2 Classifications
NSW Specification A1.3 Standards Adopted by Reference

C FIRE RESISTANCE

NSW C1.10 Fire hazard properties
NSW C2.5 Class 9a and 9c buildings
NSW C3.11 Bounding construction: Class 2, 3, 4 and 9b buildings
NSW Specification C1.10 Fire Hazard Properties

D ACCESS AND EGRESS

NSW D1.2 Number of exits required
NSW D1.6 Dimensions of exits
NSW D1.10 Discharge from exits
NSW Table D1.13 Area per person according to use
NSW D2.1 Application of Part
NSW D2.13 Treads and risers
NSW D2.15 Thresholds
NSW D2.16 Balustrades or other barriers
NSW D2.19 Doorways and doors
NSW D2.21 Operation of latch
NSW D2.101 Doors in path of travel in an entertainment venue

E SERVICES AND EQUIPMENT

NSW EP1.4
NSW Table E1.5
NSW Table E2.2a General Provisions
NSW Table E2.2b Specific Provisions
NSW Specification E2.2a Smoke Detectors and Alarm Systems
NSW E4.6 Direction signs

F HEALTH AND AMENITY

NSW FF2.1 Functional Statements
NSW FP2.6 Performance Requirements
NSW F2.7 Microbial (legionella) control
NSW F4.5 Ventilation of rooms

G ANCILLARY PROVISIONS

NSW GO1 Objective
NSW GF1.2 Functional Statement
NSW GP1.2 Performance Requirements
NSW G1.1 Swimming pools
NSW G1.101 Provision for cleaning windows
NSW GO5 Objective
NSW GF5.1 Functional Statement
NSW GP5.1 Performance Requirements
NSW G5.2 Protection

H SPECIAL USE BUILDINGS

NSW H1.1 Application of Part

**NSW Part H101 ENTERTAINMENT VENUES OTHER THAN TEMPORARY
STRUCTURES AND DRIVE-IN THEATRES**

NSW H101.1 Application of Part
NSW H101.2 Fire separation
NSW H101.3 Foyer space
NSW H101.4 Sprinkler systems for common foyers
NSW H101.5 Conventional stages
NSW H101.6 Non-conventional stages
NSW H101.7 Flying scenery
NSW H101.8 Load notice
NSW H101.9 * * * * *
NSW H101.10 Safety curtains
NSW H101.11 Seating in rows
NSW H101.12 Continental seating
NSW H101.13 Provision of guardrails
NSW H101.14 Guardrails
NSW H101.15 Dressing rooms
NSW H101.16 Storerooms
NSW H101.17 Projection suites
NSW H101.18 Basement storeys
NSW H101.19 Electric mains installation
NSW H101.20 Lighting
NSW H101.21 * * * * *
NSW H101.22 Automatic smoke-and-heat vents for stages
NSW H101.23 Solid fuel burning stoves and open fire places
NSW H101.24 Fuel gas cylinders

NSW Part H102 TEMPORARY STRUCTURES

NSW H102.1 Application of Part
NSW H102.2 Exits — Exclusions
NSW H102.3 Location of exits
NSW H102.4 Exits to be provided
NSW H102.5 Vertical clearances for exits
NSW H102.6 Curtains across exits
NSW H102.7 Curtains and blinds
NSW H102.8 Fabrics
NSW H102.9 Guardrails
NSW H102.10 Seating

NSW H102.11 Sanitary accommodation
NSW H102.12 Projection suites
NSW H102.13 Fireplaces and heating
NSW H102.14 Electrical services
NSW H102.15 Artificial lighting
NSW H102.16 Exit signs
NSW H102.17 Fire-fighting services

NSW Part H103 DRIVE-IN THEATRES

NSW H103.1 Application of Part
NSW H103.2 Speaker standards
NSW H103.3 Electrical services
NSW H103.4 Vehicular entrances
NSW H103.5 Lighting

I MAINTENANCE

NSW I1.1 Essential fire safety measures
NSW I1.2 Mechanical ventilation and hot water, warm water and cooling water systems
NSW I2 Energy Efficiency Installations

J ENERGY EFFICIENCY

NSW SUBSECTION J(A) ENERGY EFFICIENCY - CLASS 2 BUILDINGS AND CLASS 4 PARTS

NSW J(A)O1 Objective
NSW J(A)F1 Functional Statement
NSW J(A)P1 to NSW J(A)P4 Performance Requirements

NSW J(A)1 BUILDING FABRIC

NSW J(A)1.0 Deemed-to-Satisfy Provisions
NSW J(A)1.1 Application of Part
NSW J(A)1.2 Compliance with BCA provisions

NSW J(A)2 BUILDING SEALING

NSW J(A)2.0 Deemed-to-Satisfy Provisions
NSW J(A)2.1 Application of Part
NSW J(A)2.2 Compliance with BCA provisions

NSW J(A)3 AIR-CONDITIONING AND VENTILATING SYSTEMS

NSW J(A)3.0 Deemed-to-Satisfy Provisions
NSW J(A)3.1 Application of Part
NSW J(A)3.2 Compliance with BCA provisions

NSW J(A)4 HOT WATER SUPPLY

NSW J(A)4.0 Deemed-to-Satisfy Provisions
NSW J(A)4.1 Application of Part
NSW J(A)4.2 Compliance with BCA provisions

NSW J(A)5 ACCESS FOR MAINTENANCE AND FACILITIES FOR MONITORING

- NSW J(A)5.0 Deemed-to-Satisfy Provisions
- NSW J(A)5.1 Application of Part
- NSW J(A)5.2 Access for maintenance
- NSW J(A)5.3 Compliance with BCA provisions

NSW SUBSECTION J(B) ENERGY EFFICIENCY - CLASS 3 AND CLASS 5 TO 9 BUILDINGS

- NSW J(B)1 Compliance with BCA provisions
- NSW J3.1 Application of Part
- NSW J8.2 Access for maintenance

Footnote: Other Legislation Affecting Buildings

SECTION A GENERAL PROVISIONS

PART A1 INTERPRETATION

NSW A1.1 Definitions

Insert definition for *aisle* as follows:

Aisle means a walkway at the end of *rows* of seating, not being *continental seating*, leading to a cross-over or to an egress doorway.

Vary definition of *appropriate authority* as follows:

Appropriate authority means the relevant authority with the responsibility to determine the particular matter.

Insert definition of *assembly building* as follows:

Assembly building means a building where people may assemble for—

- (a) civic, theatrical, social, political or religious purposes including a library, theatre, public hall or place of worship; or
- (b) educational purposes in a *school*, *early childhood centre*, preschool, or the like; or
- (c) entertainment, recreational or sporting purposes including—
 - (i) a cinema; or
 - (ii) a sports stadium, sporting or other club; or
- (d) transit purposes including a bus station, railway station, airport or ferry terminal.

Insert definition for *auditorium* as follows:

Auditorium means a part of an *entertainment venue* used or intended to be used for the purposes of accommodating an audience to an entertainment.

Insert definition of *continental seating* as follows:

Continental seating means *rows* of seating in which the *rows* extend the full width of an *auditorium* without intervening *aisles*.

Insert definition of *cross-over* as follows:

Cross-over in relation to an *entertainment venue* or *temporary structure*, means a walkway between *aisles* or between an *aisle* and an egress doorway.

Vary definition for *designated bushfire prone area* as follows:

Designated bushfire prone area means land that:

- (a) has been designated under legislation; or
- (b) has been identified under an environmental planning instrument, development control plan or in the course of processing and determining a development application,

as land that can support a bushfire or is likely to be subject to bushfire attack.

Vary definition for *early childhood centre* as follows:

Early childhood centre means a preschool, kindergarten or child-minding centre for the care or training of more than 5 children.

Insert definition for *entertainment venue* as follows:

Entertainment venue is as defined in the Environmental Planning and Assessment Regulation 2000.

Insert definition of *film* as follows:

Film means a cinematograph *film* of a size of 35 mm or greater.

Insert definition of *flying scenery* as follows:

Flying scenery means scenery of a kind that is lifted above the *stage* floor by means of lines run from a *grid*.

Insert definition of *grid* as follows:

Grid means a framework from which lines are run for the purpose of lifting *flying scenery* above the *stage* floor.

Insert definition of *minimum lateral clearance* as follows:

Minimum lateral clearance means a permanently unobstructed space having a height above floor level of not less than 2000 mm and a width of not less than the specified measurement.

Insert definition of *projection suite* as follows:

Projection suite means such part of an *entertainment venue* as is designed to accommodate apparatus used for projecting *films*.

Insert definition of *row* as follows:

Row means a *row* of seating—

- (a) between a wall or other barrier and an *aisle*; or
- (b) between 2 *aisles*.

Insert definition of *special fire protection purpose* as follows:

Special fire protection purpose (as per Section 100B(6) of the Rural Fires Act 1997) means any of the following purposes:

- (a) a school,
- (b) a child care centre,
- (c) a hospital (including a hospital for the mentally ill or mentally disordered),
- (d) a hotel, motel or other tourist accommodation,
- (e) a building wholly or principally used as a home or other establishment for mentally incapacitated persons,
- (f) housing for older people or people with disabilities within the meaning of State Environmental Planning Policy No 5 - Housing for Older People or People with a Disability (now SEPP (Housing for Seniors or People with a Disability) 2004),
- (g) a group home within the meaning of State Environmental Planning Policy No 9 - Group Homes (now SEPP (Affordable Rental Housing) 2009),
- (h) a retirement village,
- (i) any other purpose prescribed by the regulations (Rural Fires Regulation 2008).

Note: For application of this definition in the BCA, the term "school" does not include a college, university or similar tertiary educational establishment.

Insert definition of *temporary structure* as follows:

Temporary structure means—

- (a) a booth, tent or other temporary enclosure, whether or not a part of the booth, tent or enclosure is permanent; or
- (b) a mobile structure.

NSW A3.2 Classifications

In A3.2 replace the definition of **Class 6** as follows:

Class 6: a shop or other building for the sale of goods by retail or the supply of services direct to the public, including—

- (a) an eating room, cafe, restaurant, milk or soft-drink bar; or
- (b) a dining room, bar, shop or kiosk part of a hotel or motel; or
- (c) a hairdresser's or barber's shop, public laundry, or undertaker's establishment; or
- (d) market or sale room, showroom, or *service station*.

NSW Specification A1.3 DOCUMENTS ADOPTED BY REFERENCE

In Table 1, insert additional reference as follows:

NSW Table 1: SCHEDULE OF REFERENCED DOCUMENTS

| No. | Date | Title | BCA Clause |
|----------------------------|------|--|--|
| AS/NZS 1596 | 2008 | The Storage and Handling of LP Gas | NSW H101.24.1 |
| AS 2001 Part 5.4 | 1987 | Methods of test for textiles Determination of dimensional change in laundering of textile fabrics and garments — Automatic machine method | NSW Specification C1.10 |
| AS/NZS 3000 | 2000 | Electrical installations — Buildings, structures and premises (SAA wiring rules) | NSW H102.14 |
| AS 3002 | 1985 | Electrical installations — Shows and carnivals | NSW H102.14 |
| SSL | | Appraisal Specification FAS102 | NSW H101.17.1 |
| NSW Legislation | 1979 | Environmental Planning and Assessment Act | NSW G5.2, NSW J(A)P1, NSW J(A)1.1 |
| NSW Legislation | 2000 | Environmental Planning and Assessment Regulation | NSW A1.1, NSW H101.1, NSW H101.17.1, NSW I1.1 |
| NSW Legislation | 1997 | Rural Fires Act | NSW A1.1, NSW G5.2 |

NSW Table 1: SCHEDULE OF REFERENCED DOCUMENTS— continued

| No. | Date | Title | BCA Clause |
|-----------------|------|---------------------------|---|
| NSW Legislation | 1992 | Swimming Pools Act | NSW GO1, NSW GF1.2, NSW GP1.2, NSW G1.1 |
| NSW Legislation | 2008 | Swimming Pools Regulation | NSW GO1, NSW GF1.2, NSW GP1.2, NSW G1.1 |

SECTION C FIRE RESISTANCE

PART C1 FIRE RESISTANCE AND STABILITY

Delete C1.10(a)(v), C1.10(b) and C1.10(c)(xiii) and insert NSW C1.10(a)(v), NSW C1.10(b) and NSW C1.10(c)(xiii) as follows:

NSW C1.10 Fire hazard properties

- (a) The *fire hazard properties* of the following linings, materials and assemblies in a Class 2 to 9 building must comply with **Specification C1.10**:
 - (v) In Class 9b buildings used as—
 - (A) an *entertainment venue*, a material used to cover closed back upholstered seats; and
 - (B) a public hall or the like, a proscenium curtain *required* by **Specification H1.3**.
- (b) Paint or fire-retardant coatings must not be used in order to make a material comply with a *required fire hazard property*, except in respect of a material referred to in **NSW Specification C1.10, NSW Table 4** and to which Notes 4 and 5 are applicable.
- (c) The requirements of (a) do not apply to a material or assembly if it is—
 - (xiii) an attached non-building fixture and fitting such as—
 - (A) a curtain, blind, or similar decor, other than—
 - (aa) a proscenium curtain *required* by **Specification H1.3**; or
 - (bb) in a Class 9b building used as an *entertainment venue*, a material that is regulated under **NSW Table 4**; and
 - (B) a whiteboard, *window* treatment or the like; or

PART C2 COMPARTMENTATION AND SEPARATION

Delete C2.5(b) and insert NSW C2.5(b) as follows:

NSW C2.5 Class 9a and 9c buildings

- (b) A Class 9c *aged care building* must comply with the following:

- (i) A building must be divided into areas not more than 500 m² by smoke proof walls complying with **Specification C2.5**.
- (ii) A *fire compartment* must be separated from the remainder of the building by *fire walls* and notwithstanding **Specification C1.1**, floors with an FRL of not less than 60/60/60.
- (iii) Except for walls provided in accordance with **(b)(i)** and **(ii)**, non-loadbearing *internal walls*, and if a building is of Type C construction — all *internal walls*, between and bounding *sole-occupancy-units* and bounding a *public corridor* in a *resident use area* must:
 - (A) be lined on each side with standard grade plasterboard not less than 13 mm thick or a material with at least an equivalent level of fire protection; and
 - (B) if provided with cavity insulation, contain only *non-combustible* insulation; and
 - (C) extend to the underside of—
 - (aa) the floor next above; or
 - (bb) a ceiling lined with standard grade plasterboard not less than 13 mm thick or an equivalent non-combustible material; or
 - (cc) a *non-combustible* roof covering; and
 - (D) not incorporate any penetrations above door head height unless the penetrations are adequately stopped to prevent the free passage of smoke; and
 - (E) be smoke sealed with intumescent putty or other suitable material at any construction joint, space or the like between the top of the wall and the floor, ceiling or roof.
- (iv) *Loadbearing internal walls* must comply with the requirements of **Specification C1.1** and **paragraphs (iii)(B), (C), (D) and (E)** above.
- (v) Ancillary use areas containing equipment or materials that are a high potential *fire hazard*, must be separated from the *sole-occupancy-units* by smoke proof walls complying with **Specification C2.5**.
- (vi) The ancillary use areas referred to in **(v)** include, but are not limited to, the following:
 - (A) A kitchen and related food preparation areas having a combined *floor area* of more than 30 m².
 - (B) A laundry, where items of equipment are of the type that are potential fire sources (eg gas fire dryers).
 - (C) Storage rooms greater than 10 m² used predominantly for the storage of administrative records.
- (vii) Openings in *fire walls* must be protected as follows:
 - (A) Doorways — *self-closing* or *automatic* closing –/60/30 fire doors.
 - (B) Windows — *automatic* or permanently fixed closed –/60/– fire windows or –/60/– *automatic* fire shutters.
 - (C) Other openings — construction having an FRL not less than –/60/–.

PART C3 PROTECTION OF OPENINGS

Delete C3.11(d) and insert NSW C3.11(d) as follows:

NSW C3.11 Bounding construction: Class 2, 3, 4 and 9b buildings

- (d) Protection for a doorway *required* under (a), (b) or (c) must be at least—
- (i) in a building of Type A construction — a *self-closing* –/60/30 fire door; and
 - (ii) in a building of Type B or C construction — a *self-closing*, tight fitting, solid core door not less than 35 mm thick,
except—
 - (iii) in a Class 3 building used as a *residential aged care building*—
 - (A) of Type A construction not protected by a sprinkler system — a –/60/30 fire door; or
 - (B) either—
 - (aa) of Type B or C construction; or
 - (bb) protected with a sprinkler system complying with **Specification E1.5**, a tight fitting, solid core door not less than 35 mm thick.
 - (iv) The doors referred to in (iii) must be—
 - (A) *self-closing*; or
 - (B) fitted with a free-arm action closing device which closes the door or causes the door to remain closed (without preventing manual re-opening), upon the detection of smoke by a detector located—
 - (aa) in a building protected with a sprinkler system complying with **Specification E1.5** — within the room; or
 - (bb) in a building not protected by a sprinkler system — within the room, and adjacent to the door in any common area or corridor to which the door opens.

Insert NSW C3.11(h) as follows:

- (h) In a Class 9b building used as an *entertainment venue*, openings in construction *required* to separate one space from another must be protected in accordance with **C3.4**.

NSW Specification C1.10 FIRE HAZARD PROPERTIES

Delete Clause 7 and Table 4 and insert NSW Clause 7 and NSW Table 4

NSW 7. Other materials

Materials and assemblies in a Class 2 to 9 building not included in **Clauses 3, 4, 5 or 6** must not exceed the indices set out in **NSW Table 4**.

NSW Table 4 OTHER MATERIALS

| Material or assembly location | Flammability Index | Spread-of-Flame Index | Smoke-Developed Index |
|---|--------------------|-----------------------|--|
| Fire control rooms subject to Specification E1.8 and fire-isolated <i>exits</i> , other than a <i>sarking-type material</i> used in a ceiling or used as an attachment or part of an attachment to a building element. ^{Note 1} | — | 0 | 2 |
| Class 9b buildings used as an <i>entertainment venue</i> . ^{Note 4} | | | |
| (a) A material used to cover closed back upholstered seats in any part available to the public where— | | | |
| (i) smoking is permitted; or | — | 6 | 5 |
| (ii) flame is exposed in connection with the preparation of meals. | — | 6 | 5 |
| (b) A material used as a curtain, blind or similar decor in any part available to the public. ^{Note 5} | 6 | — | — |
| (c) A material used to form a cinematograph screen ^{Note 5 and 6} | 12 | 0 | 7 |
| Class 9b buildings used as a public hall or the like, a proscenium curtain <i>required</i> by Specification H1.3 | — | 0 | 3 |
| Escalators, moving walkways or non- <i>required</i> non- <i>fire-isolated stairways</i> or pedestrian ramps subject to Specification D1.12 . | — | 0 | 5 |
| <i>Sarking-type material</i> : | | | |
| (a) In a fire control room subject to Specification E1.8 or a fire-isolated <i>exit</i> used in the form of an exposed wall or ceiling. | 0 | — | — |
| (b) In other locations. ^{Note 2} | 5 | — | — |
| Other materials or locations and insulation materials other than <i>sarking-type materials</i> . ^{Notes 2 and 3} | — | 9 | 8 if the <i>Spread-of-Flame Index</i> is more than 5 |

Notes:

1. In a fire control room or *fire-isolated stairway*, a material used as an attachment or part of an attachment to a building element must, if *combustible*, be attached directly to a *non-combustible* substrate and not exceed 1 mm finished thickness.
2. A material, other than one located within a fire-isolated *exit* or fire control room, may be covered on all faces by concrete or masonry not less than 50 mm thick, as an alternative to meeting the specified indices.

NSW Table 4 OTHER MATERIALS— continued

| Material or assembly location | Flammability Index | Spread-of-Flame Index | Smoke-Developed Index |
|--|--------------------|-----------------------|-----------------------|
| <p>3. In the case of a composite member or assembly, the member or assembly must be constructed so that when assembled as proposed in a building—</p> <ul style="list-style-type: none"> (a) any material which does not comply with this Table is protected on all sides and edges from exposure to the air; and (b) the member or assembly, when tested in accordance with Specification A2.4, has a <i>Spread-of-Flame Index</i> and a <i>Smoke-Developed Index</i> not exceeding those prescribed in this Table; and (c) the member or assembly retains the protection in position so that it prevents ignition of the material and continues to screen it from access to free air for a period of not less than 10 minutes. <p>4. Any fire-retardant coating used in an <i>entertainment venue</i> to make a material subject to (a), (b) or (c) comply with a <i>required Flammability Index</i>, <i>Spread-of-Flame Index</i> or <i>Smoke-Developed Index</i> must be certified by—</p> <ul style="list-style-type: none"> (a) its manufacturer or distributor— <ul style="list-style-type: none"> (i) as approved for use with the fabric to achieve the <i>required</i> indices; and (ii) to retain its retardancy effect after a minimum of 5 commercial dry cleaning or laundering operations carried out in accordance with AS 2001.5.4, Procedure 7A, using ECE reference detergent; and (b) the applicator as having been carried out in accordance with the manufacturer's specification. <p>5. Materials subject to (b) or (c) must have a label affixed to a representative sample of each different material indicating, in legible characters—</p> <ul style="list-style-type: none"> (a) name of manufacturer; and (b) trade name and description of material's composition; and (c) retardant treatment (if any), name of applicator and date of application; and (d) AS 1530 Part 2 and/or AS/NZS 1530 Part 3 test number and its <i>Flammability Index</i>, <i>Spread-of-Flame Index</i> and <i>Smoke-Developed Index</i>; and (e) approved methods of cleaning. <p>6. A cinematograph screen must have a supporting frame of metal construction.</p> | | | |

SECTION D ACCESS AND EGRESS

PART D1 PROVISION FOR ESCAPE

Add D1.2(d)(vii) as follows:

NSW D1.2 Number of exits required

- (d)
- (vii) any *storey* or *mezzanine* within an *auditorium* in an *entertainment venue*.

Insert NSW D1.6(f)(vi), and (i) as follows:

NSW D1.6 Dimensions of exits

- (f)
 - (vi) in a Class 9b building used as an *entertainment venue*—
 - (A) in parts of the building used by the public, the width of the *required exit* or path of travel, and the unobstructed width of each doorway must not be less than 1 m and not more than 3 m; and
 - (B) in other parts of the building, doorways must comply with **D1.6(f)**.
- (i) in a Class 9b building used as an *entertainment venue*—
 - (i) the aggregate width must be not less than 2 m plus 500 mm for every 50 persons or part in excess of 200; and
 - (ii) **D1.6(b), (c)** and **(d)** do not apply; and
 - (iii) where one or more paths of travel merge, the width of the combined path of travel must be not less than the sum of the *required* widths of those paths of travel; and
 - (iv) the *required* widths of the paths of travel connecting the *exits* from the building to a public road or *open space* must comply with **(iii)**.

Delete D1.10(f) and insert NSW D1.10(f) as follows:

NSW D1.10 Discharge from exits

- (f) In a Class 9b building used as an *entertainment venue*, at least half of the *required* number of *exits* from each *storey* or *mezzanine*, and at least half of the aggregate width of such *exits* must discharge otherwise than through the main entrance, or the area immediately adjacent to the main entrance of the building.

Vary Table D1.13 as follows:

NSW Table D1.13 AREA PER PERSON ACCORDING TO USE

| Type of use | m ² per person |
|--|---------------------------|
| Delete "Theatres and public halls" and insert the following: | |
| <i>Entertainment venue</i> — | |
| other than <i>auditorium</i> | 1.2 |
| <i>Auditorium</i> — | |
| standing area | 0.5 |
| removable seating | 1.0 |
| fixed seating | count seats |
| bench seating | 450 mm/person |

PART D2 CONSTRUCTION OF EXITS

Add NSW D2.1(c) as follows:

NSW D2.1 Application of Part

In addition—

- (c) in a Class 9b building used as an *entertainment venue*—
- (i) **Clauses NSW D2.13(a)(ix), (a)(x), and (a)(xi), NSW D2.15(c), NSW D2.16(f)(v), and NSW D2.19(b)(v)** apply to only those parts of the building used by the public; and
 - (ii) the general requirements of **Part D2** apply to all other parts of the building.

Insert NSW D2.13(a)(ix), (a)(x) and (a)(xi) as follows:

NSW D2.13 Treads and risers

- (a)
- (ix) conspicuous edges to the treads of steps in a Class 9b building used as an *entertainment venue*; and
 - (x) in a Class 9b building used as an *entertainment venue*, not more than one helical stairway serving as a *required exit* and that stairway must—
 - (A) have a width of not less than 1500 mm; and
 - (B) be of constant radius; and
 - (C) be constructed so that each tread, when measured 500 mm in from its narrow end, has a width of at least 280 mm; and
 - (xi) in a Class 9b building used as an *entertainment venue*, in a curved stairway serving as a *required exit*— an internal radius of not less than twice the width of the stair.

Renumber D2.15(d) to (e) and insert NSW D2.15(d) as follows:

NSW D2.15 Thresholds

- (d) in a Class 9b building used as an *entertainment venue*, the door sill of a doorway opening to a road, *open space*, external stair landing or external balcony is not more than 50 mm above the finished floor level to which the doorway opens; or
- (e) in other cases—
 - (i) the doorway opens to a road or *open space*, external stair landing or external balcony; and
 - (ii) the door sill is not more than 190 mm above the finished surface of the ground, balcony, or the like, to which the doorway opens.

Delete D2.16(g)(iv) and insert NSW D2.16(g)(iv) and (v) as follows:

NSW D2.16 Balustrades or other barriers

- (g)
- (iv) For a balustrade or other barrier provided under **(f)**, the height above the floor must be not less than—
 - (A) 1 m; or
 - (B) 700 mm and a horizontal projection that extends not less than 1 m outwards from the top of the balustrade; or
 - (C) in a Class 9b building used as an *entertainment venue*, the height prescribed for guardrails in **NSW H101.14.2** and **NSW H102.9**.

- (v) For a balustrade in a Class 9b building used as an *entertainment venue*, the height above the nosings of the stair treads and the floors of ramps, and the floor of any access path, balcony, landing or the like, is not less than—
 - (A) 1 m when provided inside the building; and
 - (B) 1200 mm when provided externally to the building.

Insert NSW D2.19(b)(v) as follows:

NSW D2.19 Doorways and doors

- (b)
 - (v) in a Class 9b building used as an *entertainment venue*—
 - (A) must not be fitted with a collapsible gate, accordion door, turnstile or rigid barrier; and
 - (B) if fitted with a door, must be—
 - (aa) a swing door which opens in the direction of egress; and
 - (bb) doors hung in two folds where the unobstructed width of the doorway is more than 1 m; and
 - (C) a doorway or opening within sight of the audience but not intended for egress must have a notice displayed clearly indicating its purpose and such a notice must not be internally illuminated; and
 - (D) notwithstanding **(b)(iii)**, a sliding door may be fitted where—
 - (aa) it leads directly to a road or *open space* and forms a main entrance; and
 - (bb) it is capable of swinging in the direction of egress when pressure is applied to the inside face of the door; and
 - (cc) the door is provided with signage that clearly indicates to persons seeking egress, the potential for swinging the door open in an emergency.

Delete D2.21(c) and insert NSW D2.21(c) and (d) as follows:

NSW D2.21 Operation of latch

- (c) The requirements of **(a)** do not apply in a Class 9b building (other than a *school*, an *early childhood centre* or a building used for religious purposes) to a door in a *required exit*, forming part of a *required exit* or in the path of travel to a *required exit* serving a *storey* or room accommodating more than 100 persons, determined in accordance with **D1.13**, in which case it must be readily openable—
 - (i) without a key from the side that faces a person seeking egress; and
 - (ii) by a single hand pushing action on a single device such as a panic bar located between 900 mm and 1.2 m from the floor; and
 - (iii) where a two-leaf door is fitted, the provisions of **(i)** and **(ii)** need only apply to one door leaf if the appropriate requirements of **D1.6** are satisfied by the opening of that one leaf; and
 - (iv) where the door is a door in a path of travel providing re-entry to the building from a balcony, terrace or the like, it may be fitted with key-operated fastenings only, the

tongues of which must be locked in the retracted position whenever the building is occupied by the public, so the door can yield to pressure.

- (d) The requirements of (a) and (c) do not apply to a door serving a Class 9b building used as an *entertainment venue* where the following provisions apply to a door or gate used by the public—
- (i) on a door, the single device operating the latch or bolts must be a panic bar if those doors are to be secured; or
 - (ii) an *exit* door or gate used by the public as the main entrance may be fitted with key-operated fastenings only, the tongues of which must be locked in the retracted position whenever the building is occupied by the public so the door or gate can yield to pressure from within; or
 - (iii) a door from a balcony, terrace or the like, being a door in a path of travel providing re-entry to the building, may comply with the locking provision of (ii) above.

Add NSW D2.101 as follows:

NSW D2.101 Doors in path of travel in an entertainment venue

In a Class 9b building used as an *entertainment venue*, a doorway in a path of travel must comply with **NSW D2.19(b)(v)**.

SECTION E SERVICES AND EQUIPMENT

PART E1 FIRE FIGHTING EQUIPMENT

NSW EP1.4

Note:

NSW has requirements for fire sprinkler systems in certain residential aged care facilities. See the Department of Planning & Infrastructure website www.planning.nsw.gov.au.

NSW Table E1.5

Note:

NSW has requirements for fire sprinkler systems in certain residential aged care facilities. See the Department of Planning & Infrastructure website www.planning.nsw.gov.au.

PART E2 SMOKE HAZARD MANAGEMENT

NSW Table E2.2a General Provisions

BCA Table E2.2a is applicable in NSW except for subclause (a) of the "Large isolated buildings" provisions.

Delete Table E2.2b Class 9b Assembly buildings and substitute NSW Table E2.2b Class 9b buildings as follows:

NSW Table E2.2b SPECIFIC PROVISIONS

CLASS 6 BUILDINGS IN FIRE COMPARTMENTS MORE THAN 2000 m²:

The provisions of BCA Table E2.2b for Class 6 buildings are applicable in NSW.

CLASS 9b BUILDINGS

CLASS 9b ASSEMBLY BUILDINGS

The following provisions apply to all Class 9b *assembly buildings*:

(a) Automatic shutdown:

A building or part of a building used as an *assembly building* must be provided with *automatic* shutdown of any air-handling system (other than non-ducted individual room units with a capacity not more than 1000 l/s and miscellaneous exhaust air systems installed in accordance with Sections 5 and 11 of AS/NZS 1668.1) which does not form part of the smoke hazard management system, on the activation of—

- (i) smoke detectors installed complying with **Clause 5 of Specification E2.2a**; and
- (ii) any other installed fire detection and alarm system, including a sprinkler system complying with **Specification E1.5**.

(b) Basements:

A basement not counted in the *rise in storeys* in accordance with **C1.2**, less than 2000 m² used as an *assembly building* or part of an *assembly building* containing an *auditorium* or other public area, must be equipped with—

- (i) an *automatic* smoke detection system in accordance with **Specification E2.2a**; or
- (ii) an *automatic* zone smoke control system in accordance with AS/NZS 1668.1 if the basement has more than one *fire compartment*; or if the basement forms part of a multi *fire compartmented* building served by the zone smoke control system; or
- (iii) a sprinkler system complying with **Specification E1.5**.

NSW Table E2.2b SPECIFIC PROVISIONS— continued

(c) Stages and backstages:

- (i) For the purposes of this Table, where a *stage* is separated from the *auditorium* by a proscenium wall incorporating a proscenium opening, a backstage room or area that is not separated from the *stage* by construction having an FRL of not less than 60/60/60, is taken to form part of the *stage*.
- (ii) A building or part of a building used as an *assembly building* which has a *stage*—
 - (A) with a *floor area* of more than 50 m² and not more than 150 m² must, over the *stage*, be provided with—
 - (aa) an *automatic* smoke exhaust system complying with **Specification E2.2b** (including **Figure 2.1**); or
 - (bb) roof mounted *automatic smoke-and-heat vents* complying with **NSW H101.22**, in a single *storey* building or the top *storey* of a multi *storey* building; or
 - (B) with a *floor area* of more than 150 m² must, over the *stage*, be provided with an *automatic* smoke exhaust system complying with **Specification E2.2b** (including **Figure 2.1**); or
 - (C) equipped with means of *flying scenery* must, over the *stage*, be provided with an *automatic* smoke exhaust system complying with **Specification E2.2b** (including **Figure 2.1**).

NIGHT CLUBS, DISCOTHEQUES, AND THE LIKE

A building or part of a building being a night club, discotheque or the like, must be provided with—

- (a) in an *auditorium*—
 - (i) an *automatic* smoke exhaust system complying with **Specification E2.2b**; or
 - (ii) roof mounted *automatic smoke-and-heat vents* complying with **Specification E2.2c**, in a single *storey* building or the top *storey* of a multi *storey* building; or
 - (iii) a sprinkler system complying with **Specification E1.5** with fast response sprinkler heads; and
- (b) in all other areas—
 - (i) where a building or part of a building has a *floor area* not more than 2000 m²—
 - (A) one of the smoke hazard management measures listed under (a) above; or
 - (B) an *automatic* smoke detection and alarm system complying with **Specification E2.2a**; or
 - (ii) where a building or part of a building has a *floor area* of more than 2000 m², smoke hazard management measures as provided for under 'Other Assembly Buildings' in **NSW Table E2.2b**.

Note: Paragraph (a) applies only to an *auditorium* designed principally to accommodate an audience to an entertainment.

NSW Table E2.2b SPECIFIC PROVISIONS— continued

EXHIBITION HALLS, MUSEUMS AND ART GALLERIES

A building or part of a building used as an exhibition hall, museum, art gallery or the like, must be provided with—

- (a) where the *floor area* is more than 2000 m² and not more than 3500 m²—
 - (i) an *automatic* smoke exhaust system complying with **Specification E2.2b**; or
 - (ii) roof mounted *automatic smoke-and-heat vents* complying with **Specification E2.2c** in a single *storey* building or the top *storey* of a multi *storey* building; or
 - (iii) a sprinkler system complying with **Specification E1.5**; and
- (b) where the *floor area* is more than 3500 m², a sprinkler system complying with **Specification E1.5** and—
 - (i) an *automatic* smoke exhaust system complying with **Specification E2.2b**; or
 - (ii) roof mounted *automatic smoke-and-heat vents* complying with **Specification E2.2c**, in a single *storey* building or the top *storey* of a multi *storey* building.

OTHER ASSEMBLY BUILDINGS

- (a) Unless otherwise described in (b), in a building or part of a building used as an *assembly building* (not being a night club, discotheque or the like; or an exhibition hall, museum or art gallery) where the *floor area* of a *fire compartment* is more than 2000 m², the *fire compartment* must be provided with—
 - (i) an *automatic* smoke exhaust system complying with **Specification E2.2b**; or
 - (ii) roof mounted *automatic smoke-and-heat vents* complying with **Specification E2.2c**, in a single *storey* building or the top *storey* of a multi *storey* building; or
 - (iii) if the *floor area* of the *fire compartment* is not more than 5000 m² and the building has a *rise in storeys* of not more than 2—
 - (A) an *automatic* smoke detection and alarm system complying with **Specification E2.2a**; or
 - (B) a sprinkler system complying with **Specification E1.5**.
- (b) The following buildings are exempt from the provisions of (a):
 - (i) Sporting complexes, (including sports halls, gymnasiums, *swimming pools*, ice and roller rinks, and the like) other than indoor sports stadiums with total spectator seating for more than 1000 persons.
 - (ii) Churches and other places used solely for religious worship.
 - (iii) *School* classrooms.

Note: Smoke hazard management provisions for an *assembly building* used for multiple purposes must comply with all the relevant provisions of **NSW Table E2.2b** according to usage.

NSW Specification E2.2a SMOKE DETECTORS AND ALARM SYSTEMS

Delete Clause 7(e) as follows:

7. System Monitoring

(e) (deleted)

PART E4 EMERGENCY LIGHTING, EXIT SIGNS AND WARNING SYSTEMS

Delete E4.6 and insert NSW E4.6 as follows:

NSW E4.6 Direction signs

If an *exit* is not readily apparent to persons occupying or visiting the building, then *exit* signs must be installed—

- (a) in appropriate positions in corridors, hallways, lobbies, foyers, auditoria, and the like, indicating the direction to a *required exit*, and
- (b) in a Class 9b building used as an *entertainment venue* — in any external egress path to a street where the *exit* does not open directly onto a street.

SECTION F HEALTH AND AMENITY

PART F2 SANITARY AND OTHER FACILITIES

Delete FF2.1(b) and replace with NSW FF2.1(b):

| |
|------------------------------|
| FUNCTIONAL STATEMENTS |
|------------------------------|

NSW FF2.1

(b) (deleted)

Note.

Paragraph (b) of this Functional Statement is deleted from the BCA in NSW, as the installation of hot water, warm water and cooling water systems (and their operation and maintenance) is regulated in the Public Health Regulation, 2012, under the Public Health Act, 2010.

Delete FP2.6 (and Limitation) and replace with NSW FP2.6:

PERFORMANCE REQUIREMENTS

NSW FP2.6

(deleted).

Note.

This Performance Requirement is deleted from the BCA in NSW, as the installation of hot water, warm water and cooling water systems (and their operation and maintenance) is regulated in the Public Health Regulation, 2012, under the Public Health Act, 2010.

Delete F2.7:

NSW F2.7 Microbial (legionella) control

(deleted).

Note.

This clause is deleted from the BCA in NSW, as the installation of hot water, warm water and cooling water systems (and their operation and maintenance) is regulated in the Public Health Regulation, 2012, under the Public Health Act, 2010.

PART F4 LIGHT AND VENTILATION

Delete F4.5(b) and insert NSW F4.5(b) as follows:

NSW F4.5 Ventilation of rooms

(b) a mechanical ventilation or air-conditioning system complying with AS 1668.2.

Note.

The reference to AS/NZS 3666.1 is deleted from the BCA in NSW, as the need to comply with this standard is regulated in the Public Health Regulation, 2012, under the Public Health Act, 2010.

SECTION G ANCILLARY PROVISIONS

PART G1 MINOR STRUCTURES AND COMPONENTS

Delete GO1(c) and insert NSW GO1(c) as follows:

OBJECTIVE

NSW GO1

(c) safeguard young children from drowning or injury in a *swimming pool*; and

Application:

NSW GO1(c) only applies to a *swimming pool* with a depth of water of more than 300 mm, in conjunction with the Swimming Pools Act 1992 and the Swimming Pools Regulation 2008.

Delete GF1.2(a) and insert NSW GF1.2(a) as follows:

FUNCTIONAL STATEMENT**NSW GF1.2**

A *swimming pool* is to be provided with—

- (a) means of restricting access by young children to it; and

Application:

NSW GF1.2(a) only applies to a *swimming pool* with a depth of water of more than 300 mm, in conjunction with the Swimming Pools Act 1992 and the Swimming Pools Regulation 2008.

Delete GP1.2(a) and insert NSW GP1.2(a) as follows:

PERFORMANCE REQUIREMENTS**NSW GP1.2**

- (a) A barrier must be provided to a *swimming pool* and must—
- (i) be continuous for the full extent of the hazard; and
 - (ii) be of a strength and rigidity to withstand the foreseeable impact of people; and
 - (iii) restrict the access of young children to the pool and the immediate pool surrounds; and
 - (iv) have any gates and doors fitted with latching devices not readily operated by young children, and constructed to automatically close and latch.

Application:

NSW GP1.2(a) only applies to a *swimming pool* with a depth of water of more than 300 mm, in conjunction with the Swimming Pools Act 1992 and the Swimming Pools Regulation 2008.

Delete G1.1(a) and insert NSW G1.1(a) as follows:

NSW G1.1 Swimming pools

- (a) **G1.1(b)** applies to technical construction requirements for barriers to restrict access to *swimming pools*, subject to the walls of out-of-ground and above ground pools, including inflatable pools not being considered to be effective barriers.

Note:

The Swimming Pools Act 1992 and the Swimming Pools Regulation 2008 applicable to *swimming pools* with a depth of water of more than 300 mm regulate the circumstances in which a barrier is required and prevail in the case of any inconsistency.

Add NSW G1.101 as follows:

NSW G1.101 Provision for cleaning windows

- (a) A building must provide for a safe manner of cleaning any *windows* located 3 or more *storeys* above ground level.
- (b) A building satisfies (a) where—
- (i) the *windows* can be cleaned wholly from within the building; or
 - (ii) provision is made for the cleaning of the *windows* by a method complying with the Work Health and Safety Act 2011 and regulations made under that Act.

PART G5 CONSTRUCTION IN BUSHFIRE PRONE AREAS

Delete GO5 and insert NSW GO5 as follows:

OBJECTIVE

NSW GO5

The *Objective* of this Part is to—

- (a) safeguard occupants from injury; and
- (b) protect buildings,

from the effects of bushfire.

Application:

NSW GO5 only applies, in a *designated bushfire prone area*, to—

- (a) a Class 2 or 3 building;
- (b) a Class 4 part of a building;
- (c) a Class 9 building that is a *special fire protection purpose*; or
- (d) a Class 10a building or deck associated with a building or part referred to in (a), (b) or (c).

Delete GF5.1 and insert NSW GF5.1 as follows:

FUNCTIONAL STATEMENT

NSW GF5.1

A building constructed in a *designated bushfire prone area* is to provide a resistance to bushfire in order to reduce the danger to life and minimise the risk of the loss of the building.

Application:

NSW GF5.1 only applies, in a *designated bushfire prone area*, to—

- (a) a Class 2 or 3 building;
- (b) a Class 4 part of a building;
- (c) a Class 9 building that is a *special fire protection purpose*; or
- (d) a Class 10a building or deck associated with a building or part referred to in (a), (b) or (c).

Delete GP5.1 and insert NSW GP5.1 as follows:

PERFORMANCE REQUIREMENT

NSW GP5.1

A building that is constructed in a *designated bushfire prone area* must be designed and constructed to reduce the risk of ignition from a bushfire while the fire front passes.

Application:

NSW GP5.1 only applies in a *designated bushfire prone area*, to—

- (a) a Class 2 or 3 building;
- (b) a Class 4 part of a building;
- (c) a Class 9 building that is a *special fire protection purpose*; or
- (d) a Class 10a building or deck associated with a building or part referred to in (a), (b) or (c).

Delete G5.2 and insert NSW G5.2 as follows:

NSW G5.2 Protection

In a *designated bushfire prone area*, a Class 2 building, a Class 3 building, a Class 4 part of a building or a Class 9 building that is a *special fire protection purpose* or a Class 10a building or deck associated with such a building or part, must comply with the following—

- (a) AS 3959 except for Section 9 Construction for Bushfire Attack Level FZ (BAL-FZ). Buildings subject to BAL-FZ must comply with specific conditions of development consent for construction at this level; or
- (b) the requirements of (a) above as modified by the development consent following consultation with the NSW Rural Fire Service under section 79BA of the Environmental Planning and Assessment Act 1979; or

- (c) the requirements of (a) above as modified by development consent with a bushfire safety authority issued under section 100B of the Rural Fires Act 1997 for the purposes of integrated development.

SECTION H SPECIAL USE BUILDINGS

PART H1 THEATRES, STAGES AND PUBLIC HALLS

Delete H1.1 and insert NSW H1.1 as follows:

NSW H1.1 Application of Part

- (a) For a Class 9b building or part of a building that is not an *entertainment venue*—
- (i) The *Deemed-to-Satisfy Provisions* of Part H1 apply to every enclosed Class 9b building or part of a building which—
- (A) is a *school* assembly, church or community hall with a *stage* and any *backstage* area with a total *floor area* of more than 300m²; or
- (B) otherwise, has a *stage* and any *backstage* area with a total *floor area* of more than 200m²; or
- (C) has a *stage* with an associated rigging loft.
- (ii) Notwithstanding (a)(i)—
- (A) **H1.4** applies to every open or enclosed Class 9b building; and
- (B) **H1.7** applies to every enclosed Class 9b building.
- (b) For a Class 9b building that is an *entertainment venue*, **NSW Part H101**, as follows, applies in replacement of Part H1:

NSW PART H101 ENTERTAINMENT VENUES OTHER THAN TEMPORARY STRUCTURES AND DRIVE-IN THEATRES

Note.

NSW Part H101 contains *Deemed-to-Satisfy Provisions* additional to those contained in **Sections C, D, E, F** and **G** for buildings containing or used as *entertainment venues* other than temporary structures and drive-in theatres.

NSW H101.1 Application of Part

This Part applies to every *entertainment venue* as described in the Environmental Planning and Assessment Regulation 2000.

NSW H101.2 Fire separation

If an *entertainment venue* forms part only of a building, then—

- (a) the whole of the *entertainment venue*; or

(b) the part containing the *stage*, *backstage* area and *auditorium*, must be separated from the other parts of the building by construction having an FRL of not less than 60/60/60.

NSW H101.3 Foyer space

Where an *entertainment venue* is used principally for the purpose of—

- (a) exhibiting *films*; or
- (b) conducting live *stage* productions,

foyer space (excluding stairways and concession areas) must be provided on the basis of at least 0.25 m² for each person that the *auditorium* accommodates.

NSW H101.4 Sprinkler systems for common foyers

In an *entertainment venue*, where multiple *auditoriums* have a foyer in common, the following applies—

- (a) If the foyer serves not more than 2 *auditoriums*; that foyer must be separated from any adjoining foyer by construction having an FRL of not less than 60/60/60.
- (b) If the foyer serves more than 2 *auditoriums*, a sprinkler system complying with **Specification E1.5** must be installed—
 - (i) throughout the *storey* containing the foyer; and
 - (ii) throughout each *storey* in the building below that *storey*.

NSW H101.5 Conventional stages

This clause applies to a conventional *stage*, that is, a *stage* which is separated from the *auditorium* by a proscenium wall incorporating a proscenium opening.

NSW H101.5.1 Extent of stage area

If a room or area is not separated from the remainder of a conventional *stage* by construction having an FRL of not less than 60/60/60, the room or area is, for the purposes of this Part, to be taken to form part of the *stage*.

NSW H101.5.2 Small stages

A *stage* which is more than 50 m² but not more than 150 m² in area must have 2 or more means of egress from the *stage* and *backstage* area provided otherwise than through the proscenium wall.

NSW H101.5.3 Large stages

A *stage* which is more than 150 m² in area—

- (a) must have installed directly above the *stage* a suitable sprinkler system complying with **Specification E1.5**; and
- (b) must have the proscenium opening protected by a safety curtain that complies with **NSW H101.10**; and

- (c) must have a line of open drenchers or open sprinklers provided above the proscenium opening on the *stage* side and in such a position as to be able to discharge over the inside face of the safety curtain; and
- (d) must have 2 or more means of egress from the *stage* and *backstage* area provided otherwise than through the proscenium wall.

NSW H101.5.4 Fire separation of stages

A *stage* which is more than 50 m² in area, and all areas below such a *stage*, must (with the exception of the proscenium opening) be separated from the *backstage* and the remainder of the building by construction having an FRL of not less than 60/60/60.

NSW H101.6 Non-conventional stages

This clause applies to a *stage* that is not a conventional *stage* within the meaning of **NSW H101.5**.

NSW H101.6.1 Small stages

A *stage* which is more than 50 m² but not more than 150 m² in area must have at least 2 means of egress from the *backstage* area.

NSW H101.6.2 Large stages

A *stage* which is more than 150 m² in area must have at least 2 means of egress from the *backstage* area.

NSW H101.7 Flying scenery

Where there is a *grid* or other means of *flying scenery* over—

- (a) a conventional *stage* or non-conventional *stage*—
 - (i) the *stage* must be provided with a sprinkler system complying with **Specification E1.5**; and
 - (ii) a fly gallery, bridge *grid*, rigging loft, tie gallery or electric light perch must—
 - (A) comply with AS 1657; and
 - (B) be of *non-combustible* construction;
 - (iii) a fly gallery must be provided with at least 2 means of egress, one on each side of the *stage*;
 - (iv) a *grid* or rigging loft must be provided with at least 2 means of egress;
 - (v) if exposed steel is used in the construction of a roof, fly or tie gallery, the roof, fly or tie gallery must be so designed that, in the event of its structural failure due to fire, the wall structure of the building will not be affected.
 - (vi) structural steel supporting the *stage* tower must be enclosed by masonry or concrete and have an FRL of not less than 120/120/120; and
- (b) in the case of a conventional *stage*, the following additional requirements apply:
 - (i) The proscenium wall must—
 - (A) have an FRL of not less than 120/120/120; and

- (B) have the proscenium opening protected by a rigid safety curtain in accordance with **NSW H101.10.1**;
- (ii) the walls forming the *stage* area, and the area beneath the *stage*, must be constructed of masonry or concrete and have an FRL of not less than 120/120/120.

NSW H101.8 Load notice

A notice indicating the actual distributed and concentrated load for which the *stage* floor has been designed must be conspicuously and permanently displayed in a position adjacent to the *stage* floor.

This notice must be in legible letters and figures—

- (a) at least 50 mm high; and
- (b) on a contrasting background.

NSW H101.9 * * * * *

This clause has been deliberately left blank.

NSW H101.10 Safety curtains

A safety curtain *required* by **NSW H101.5.3** must—

- (a) be made of *non-combustible* material; and
- (b) be so fitted that, when it is closed, it forms an efficient smoke seal between the *stage* and the *auditorium*; and
- (c) be capable of withstanding a pressure differential of 0.5 kPa over its entire surface area; and
- (d) be run on steel guides located on each side of the proscenium opening; and
- (e) remain engaged in its guides if the guides, together with their fittings and attachments and that part of the curtain engaged in the guides, are subjected to a pressure differential of 1 kPa; and
- (f) be of sufficiently robust construction to withstand damage by scenery, *stage* properties and falling debris; and
- (g) be capable of closing the proscenium opening within 30 seconds, either by gravity slide or by motor assisted mechanisms; and
- (h) have manual controls, located on each side of the *stage*, for the closing of the curtains; and
- (i) have a notice displayed adjacent to the operating controls, in clear and legible letters and symbols of adequate size, indicating its use and operation; and
- (j) when operated, actuate a distinctive warning alarm audible to persons on the *stage* and must not be reliant for its operation solely on the primary electricity supply; and
- (k) have the words “Safety Curtain” exhibited on the curtain in clear and legible letters of adequate size to enable them to be read from all parts of the *auditorium*.

NSW H101.10.1 Safety curtains—Additional requirements

A rigid safety curtain *required* by **NSW H101.7** must comply with the requirements of **NSW H101.10** and it must—

- (a) be vertically hung from steel cables;
- (b) be framed with structural steel that complies with AS 4100;
- (c) be sheeted and finished on both faces with sheet steel or other *non-combustible* material of such gauge, and so fastened to its frame, as to ensure that its frame is capable of withstanding distortion arising from heat; and
- (d) when closed, overlap the proscenium opening by not less than 300 mm at each side and by not less than 600 mm at the top.

NSW H101.11 Seating in rows

This clause does not apply to *continental seating* or seating at tables.

NSW H101.11.1 Number of seats

Subject to **NSW H101.11.5**, where seating is arranged in *rows*, the maximum of seats in each *row* must not exceed—

- (a) 8 where there is an *aisle* at one end only of the *row*; or
- (b) 16 where there are *aisles* on both ends of the *row*.

NSW H101.11.2 Chairs used for seating

Chairs used for seating must—

- (a) where they have arms, be at least 500 mm from centre to centre; and
- (b) where they do not have arms, be at least 450 mm from centre to centre; and
- (c) have a *minimum lateral clearance* of at least 300 mm between—
 - (i) the front of each chair and the back of the chair in front; or
 - (ii) if a guardrail is provided in front of the chairs, between the front of each chair and the guardrail; and
- (d) have a distance of at least 950 mm between the back of each chair and the back of the chair in front.

NSW H101.11.3 Chairs in auditoriums—Level floors

Chairs in an *auditorium* that has a level floor must be—

- (a) securely fastened to the floor; or
- (b) secured together in groups of not less than 4 and not more than 16.

NSW H101.11.4 Chairs in auditoriums—Sloping floors

Chairs in an *auditorium* having a sloping floor, or having stepped or inclined platforms, must be securely fastened to the floor or platform.

NSW H101.11.5 Radiating aisles in seating areas

Where seating is securely fastened to the floor and arranged in *rows* of concentric circles, semi-circles or segments of circles, with radiating *aisles*—

- (a) the number of seats in each row between 2 *aisles* must not exceed 24; and
- (b) each seat must—
 - (i) have a *minimum lateral clearance* of at least 325 mm between the front of the seat and the back of the seat in front; and
 - (ii) have a distance of at least 975 mm between the back of the seat and the back of the seat in front; and
- (c) the *rows* may be curved or straight.

NSW H101.11.6 Aisles and cross-overs

Where *aisles* and *cross-overs* are provided—

- (a) each *aisle* must have a width of at least 1000 mm and each *cross-over* must have a width of at least 1500 mm; and
- (b) the floor of each *aisle* must not have a grade of more than 1 in 8 at any part; and
- (c) if there is a step from a *row* to an *aisle* or from a landing to an *aisle*, the step must not project into the *aisle*.

NSW H101.11.7 Platforms and steps

Where an *aisle* contains platforms or steps—

- (a) the platforms and steps must extend for the full width of the *aisle*; and
- (b) if there are no intervening steps between levels of platforms, the height of the platform riser must not be more than 200 mm; and
- (c) if there are one or more intervening steps between levels of platforms—
 - (i) each riser must be at least 100 mm but not more than 200 mm high; and
 - (ii) each going must be at least 250 mm deep; and
 - (iii) risers and goings must be uniform; and
- (d) goings which are more than 450 mm deep at platform level must not have a grade of more than 1 in 50; and
- (e) at the entrance from the *aisle* to each *row* there must be a clear level floor space, extending the full width of the *aisle*, of at least 300 mm, measured from the back of the *row* in front; and
- (f) any going projecting in front of a seat adjacent to an *aisle* must be protected by a guardrail.

NSW H101.11.8 Stepped platforms

Where stepped platforms without chairs or stepped platforms with bench seats, are used for seating—

- (a) each platform must be at least 700 mm deep; and

- (b) each seating space must be at least 450 mm wide, measured along the front of the platform or bench seat; and
- (c) each seating space must be numbered consecutively; and
- (d) at the entrance from the *aisle* to each *row* there must be a clear level floor space, extending the full width of the *aisle*, of at least 300 mm, measured from the back of the *row* in front; and
- (e) any going projecting in front of a seat adjacent to an *aisle* must be protected by a guardrail; and
- (f) in the case of stepped platforms with bench seats, there must be at least 300 mm between the back of each seat and the front of the platform behind, or the front of the bench seat behind, whichever is the closer.

NSW H101.12 Continental seating

This Clause applies to *continental seating*.

NSW H101.12.1 Seating to be fastened

Seating must be securely fastened to the floor.

NSW H101.12.2 Maximum seats per row

The number of seats in a *row* must not exceed 120.

NSW H101.12.3 Depths of seating rows

The depth of each *row* of seating (that is, the distance between the back of the *row* in front or, if there is a guardrail in front, between the back of the *row* and the guardrail) must, in respect of a *row* containing a number of seats specified in Column 1 of **Table H101.12** be not less than the distance specified in Column 2 of that Table in respect of that number of seats.

NSW H101.12.4 Clearance between rows

The *minimum lateral clearance* between each *row* of seating must, in respect of a *row* containing a number of seats specified in Column 1 of **Table H101.12** be not less than the clearance specified in Column 3 of that Table in respect of that number of seats.

NSW H101.12.5 Chairs used for seating

Chairs used for seating must comply with **NSW H101.11.2(a)** and **(b)**.

NSW H101.12.6 Egress Doorways

Egress doorways through the walls of the *auditorium*—

- (a) must have an aggregate width of at least twice the sum of the clearances specified in Column 3 of **Table H101.12** for each *row* of the *auditorium* to be served by those doorways; and
- (b) must be provided at each end of every fifth *row*, excluding the first 2 *rows* and the last 2 *rows* in the *auditorium* if those *rows* each contain no more than 16 seats; and
- (c) must lead—

- (i) directly to a road or *open space*; or
- (ii) into a foyer or other area giving access to a road or *open space*; and
- (d) must be provided with *exit* signs if the egress doorways are not sufficiently conspicuous.

NSW H101.12.7 Clear Areas

A clear area—

- (a) must be provided from each end of each *row* to an egress doorway in the wall of the *auditorium*; and
- (b) must have a width of at least—
 - (i) the sum of the clearances specified in Column 3 of **Table H101.12** for each such *row*; or
 - (ii) 500 mm, whichever is the greater; and
- (c) if it contains platforms or steps, must comply with **NSW H101.11.7(a), (b), (c), (d)** and **(f)**.

NSW H101.12.8 Minimum clear space

At the entrance from a *row* to a clear area, there must be a clear level floor space having a width of at least the clearance specified for the *row* in Column 3 of **Table H101.12**.

NSW H101.12.9 Doors

A door fitted to the egress doorway in the wall of an *auditorium* must comply with **NSW D2.15** and **NSW D2.19**.

Table H101.12 SPACING OF AUDITORIUM SEATING

| Column 1 Number of seats in <i>Rows</i> | Column 2 Depth of <i>Rows</i> (mm) | Column 3 Clearance between <i>Rows</i> (mm) |
|--|---------------------------------------|---|
| Not exceeding 16 | 950 | 300 |
| 17 - 30 | 975 | 325 |
| 31 - 45 | 1000 | 350 |
| 46 - 60 | 1025 | 375 |
| 61 - 75 | 1050 | 400 |
| 76 - 90 | 1075 | 425 |
| 91 - 105 | 1100 | 450 |
| 106 - 120 | 1125 | 475 |

NSW H101.13 Provision of guardrails

NSW H101.13.1 Location

Guardrails must be provided—

- (a) along the fascia of each balcony or box;

- (b) if there is a stepped floor, along the front edge of each *cross-over*; and
- (c) where **NSW H101.13.2** and **NSW H101.13.3** apply.

NSW H101.13.2 Fixed back seats

If seats with fixed backs are provided, guardrails that extend for the full width of the seating, must be provided at least 500 mm above the platform unless—

- (a) fixed seat backs of the next lower level project at least 500 mm above the level of the stepped platform; and
- (b) there is only one riser between the platform and the next lower *cross-over*.

NSW H101.13.3 Steps between platforms

If—

- (a) there is more than one intervening step in an *aisle* between levels of platforms, a guardrail must be provided (at a vertical height of at least 660 mm measured above the nosing of each tread and of the upper platform) to the sides of the *aisle* adjacent to those steps; and
- (b) there is more than one intervening step in an *aisle* between levels of platforms, and that *aisle* is along a wall, a continuous guardrail must be affixed to that wall at a height of at least 865 mm above the nosing of each tread; and
- (c) the end of a platform or the back of the highest platform does not abut a wall that extends at least 660 mm above the floor level of the platform, a guard rail not less than 660 mm high must be provided—
 - (i) at the ends of the platform, extending from the front of the first riser to the back of the highest platform; and
 - (ii) at the back of the highest platform, extending the full width of the platform; and
- (d) there is an inclined floor, the raised section of which is not bounded by walls at least 660 mm high, a guard rail must be provided that extends around the perimeter of the raised section at a height of at least 660 mm above the inclined floor level; and
- (e) seating at tables is provided on a stepped platform, a guardrail at least 500 mm high must be provided along the front edge of the platform.

NSW H101.14 Guardrails

This clause applies to seating areas.

NSW H101.14.1 Continental seating

Where a guardrail is provided in front of a *row* of chairs—

- (a) the distance between the back of each chair in that *row*, and the guardrail must be not less than the distance specified in Column 2 of **Table H101.12** for the number of chairs in that *row*;
- (b) the *minimum lateral clearance* between the front of each chair in that *row* and the guardrail must be not less than the clearance specified in Column 3 of **Table H101.12** for the number of chairs in that *row*.

NSW H101.14.2 Balconies and boxes

A guardrail provided along the fascia of a balcony or box—

- (a) if it is located at the foot of a stepped *aisle*, must have its top surface at least 900 mm above the floor of the balcony or box; and
- (b) if it is not located at the foot of a stepped *aisle*, must have its top surface at least 750 mm above the floor; and
- (c) if it has a ledge more than 70 mm wide, must have the top surface of the ledge sloping downwards towards the floor of the balcony or box at an angle of at least 30 degrees from the horizontal; and
- (d) must have an unperforated kerb or toe guard extending for at least 300 mm above the floor.

NSW H101.14.3 Cross-overs

A guardrail provided along the front edge of a cross-over on a stepped floor—

- (a) must be at least 750 mm high; and
- (b) must extend for the full distance between *aisles*, or between a wall and an *aisle*, or for such other distance as considered necessary.

NSW H101.15 Dressing rooms

A dressing room or 2 or more adjoining dressing rooms, having a total *floor area* of more than 50 m², must—

- (a) be separated from other parts of the building by construction having an FRL of not less than 60/60/60;
- (b) have at least 2 means of egress as remote from each other as possible, one of which must discharge—
 - (i) directly to a road or *open space*; or
 - (ii) through a fire-isolated *exit* to a road or *open space*.

NSW H101.16 Storerooms

A storeroom must be separated from other parts of the building by construction having an FRL of not less than 60/60/60.

NSW H101.17 Projection suites

- (a) This clause applies to *projection suites*.
- (b) A *projection suite* must be provided in an *entertainment venue* intended to be used for the showing of *films*.

NSW H101.17.1 Rooms to be provided

A *projection suite* in accordance with the staffing requirements of Schedule 3A of the Environmental Planning and Assessment Regulation 2000 must contain either—

- (a) a projection room and sanitary accommodation comprising at least 1 closet pan and 1 washbasin, where the *projection suite* is continually staffed; or

- (b) a projection room fitted with the following equipment—
- (i) an *automatic* fire suppression system in accordance with SSL Appraisal Specification FAS 102 or a sprinkler system complying with AS 2118; and
 - (ii) a smoke detection system which will—
 - (A) comply with AS 1670.1 except for the provisions of Clause 3.26(f) - location where detectors not *required*; and
 - (B) be connected to a fire station or other approved monitoring service where arrangements are in place to initiate *fire brigade* response; and
 - (C) close down all shutters fitted to projection or observation ports; and
 - (D) activate sufficient general lighting to provide a minimum of 40 lux measured at floor level in any *auditorium* affected; and
 - (E) operate a public address system to automatically announce a suitable message from the management of the premises; and
 - (F) activate an audible alarm to immediately indicate to management the presence of smoke in the projection room.

NSW H101.17.2 Fire separation

A *projection suite* must be separated from all other internal parts of the building in which it is located by construction having an FRL of not less than 60/60/60.

NSW H101.17.3 Concession for protection of some openings

If a projection or observation port is not more than 0.1 m² in area—

- (a) a metal shutter not less than 1.5 mm thick may be fitted thereto instead of the protection *required* under **NSW C3.11**; and
- (b) any metal shutter or protection system provided must be equipped with a device to permit the closing of the shutter or protection system from easily accessible operating positions adjacent to each egress doorway from the projection room.

NSW H101.18 Basement storeys

Where an *entertainment venue* includes not more than 2 basement *storeys*—

- (a) all *required exits* from the basement must be enclosed in *non-combustible* construction, with the exception of the main entry or *exit*; and
- (b) any *auditorium* and other public areas in the basement must be equipped with an air-handling system that complies with AS 1668.2.

NSW H101.18.1 Basement storeys — More than two

If the *entertainment venue* includes more than 2 basement *storeys*—

- (a) the construction must be of at least Type B; and
- (b) all *required exits* from the basement must be enclosed in a *fire-resisting shaft* having an FRL as *required* by the relevant Type of construction; and
- (c) the building must be equipped with a sprinkler system complying with **Specification E1.5**.

NSW H101.19 Electric mains installation

NSW H101.19.1 Main switchboard

The switchboard containing the main isolation switch must—

- (a) be located in a position that is readily accessible to authorised persons, and to the *Fire Brigade* in the case of an emergency; and
- (b) be enclosed by construction having an FRL not less than 60/60/60.

NSW H101.19.2 Circuit protection

Protection of a final sub-circuit originating at a switchboard or distribution board must be by means of circuit breakers.

NSW H101.19.3 Separate sub-mains

Where an *entertainment venue* has its mains supply in common with that of another building or where it is a part of a building—

- (a) the *entertainment venue* must be served by a separate and independent sub-main from the main switchboard; and
- (b) each such sub-main, the consumer's main and the supply authority's conductors within the building must be protected against fire by means of—
 - (i) mineral-insulated metal-sheathed cables or other cables that provide at least 2 hours' fire protection; or
 - (ii) heavy-duty PVC conduit or metallic pipe, concrete encased in walls or slabs with a minimum of 50 mm cover; or
 - (iii) heavy-duty PVC conduit or metallic pipe, buried at least 500 mm below ground level, for underground cabling.

NSW H101.20 Lighting

NSW H101.20.1 Lighting switches

- (a) Any switch controlling the lighting system must not be accessible.
- (b) Where, during normal use, general lighting may be dimmed or switched off, an override switch to switch on all the general lighting instantaneously must be installed in the *auditorium* in a position accessible to management.

NSW H101.20.2 Lighting levels

Where the lamps utilised in the general lighting are of a type that will not relight immediately after the restoration of the primary electricity supply to those lamps—

- (a) a time delay or other suitable means must be provided to maintain the emergency lighting for a period not less than that necessary to allow the general lighting lamps to restrike; or
- (b) lamps of a type that will provide immediate lighting must be installed and—
 - (i) arranged in such a manner as to ensure visual conditions not inferior to those *required* to be provided by the emergency lighting; and

- (ii) capable of being switched in common with the general lighting and of being controlled also by the override switch *required* by **NSW H101.20.1(b)**.

NSW H101.20.3 Provision of aisle lighting

Where general lighting is to be either dimmed or extinguished when the public is in attendance and where the floor is stepped or at an inclination greater than 1 in 12, *aisle* lights must be provided to illuminate the length of each *aisle* and the tread of each step therein.

NSW H101.20.4 Aisle lighting power supply

Where an *aisle* light is installed in a seat frame, it must be supplied at a voltage of not more than 32 volts AC or 115 volts DC.

NSW H101.20.5 Aisle lighting alternative power supply

Aisle lighting must be provided with an alternative electricity supply that—

- (a) is capable of being *automatically* energised in the event of failure of the primary lighting electricity supply; and
- (b) complies with the provisions applying to emergency lighting.

NSW H101.21 * * * * *

This clause has deliberately been left blank.

NSW H101.22 Automatic smoke-and-heat vents for stages

An automatic *smoke-and-heat vent* system *required* by **NSW Table E2.2b** “*Stages and backstage*” must—

- (a) be capable of *automatic* operation by the inclusion of a heat sensing device designed to activate the system at a temperature of not more than 71°C; and
- (b) be capable of being released manually from positions at each side of the *stage* and of being fully activated from either position; and
- (c) have a notice, prominently displayed at each position referred to in **(b)**, clearly indicating the method of activation; and
- (d) have an openable area of not less than 1/10 of the total area of the *stage*.

NSW H101.23 Solid fuel burning stoves and open fire places.

Solid fuel burning stoves and open fire places must not be installed in premises designed for the purpose of—

- (a) exhibiting *films*; or
- (b) conducting live theatre productions.

NSW H101.24 Fuel gas cylinders

NSW H101.24.1 General

Fuel gas cylinders must—

- (a) be housed in an enclosure that is located outside the building; and
- (b) comply with the ventilation requirements of AS/NZS 1596.

NSW H101.24.2 Fuel gas cylinder enclosures

An enclosure referred to in **NSW H101.24.1**—

- (a) must be located not less than 3 m from any *window*, door, vent or other opening; and
- (b) if located 3 m or more from a building must—
 - (i) have a concrete base; and
 - (ii) be constructed from heavy-gauge chain-wire mesh or other suitable material; and
 - (iii) be at least 1.8 m high; and
 - (iv) be so designed as to securely contain the fuel gas cylinders in a single line; and
 - (v) must be so designed as to allow cross ventilation; and
- (c) if located less than 3 m from a building must—
 - (i) have a concrete base; and
 - (ii) have 3 sides constructed from concrete or masonry; and
 - (iii) have a concrete roof; and
 - (iv) be so designed as to securely contain the fuel gas cylinders in a single line; and
 - (v) have a hinged, heavy-gauge chain-wire door capable of being secured against unauthorised entry; and
 - (vi) have its roof at least 600 mm above the uppermost fitting on any fuel gas cylinder housed therein.

NSW PART H102 TEMPORARY STRUCTURES

NSW H102.1 Application of Part

This Part applies to *temporary structures* used as *entertainment venues*.

NSW H102.2 Exits—Exclusions

In this clause, a reference to an entrance or *exit* does not include a reference to an entrance or *exit* provided for persons or animals performing in a *temporary structure*.

NSW H102.3 Location of exits

Exits must be so provided and arranged as to afford a ready means of egress from all parts of a *temporary structure*.

NSW H102.4 Exits to be provided

Without limiting the generality of **NSW H102.3**—

- (a) the number of *exits* to be provided for a *temporary structure* designed to accommodate a number of persons specified in Column 1 of **Table H102.4** must be not less than the

number of *exits* specified in Column 2 of that Table in respect of that number of persons;
and

- (b) the aggregate width of the *exits* to a *temporary structure* designed to accommodate a number of persons specified in Column 1 of **Table H102.4** must not be less than the width specified in Column 3 of that Table in respect of that number of persons.

NSW H102.5 Vertical clearances for exits

Every part of an entrance or *exit* must provide a minimum unobstructed height of 2000 mm and, where the entrance or *exit* is beneath a stepped seating platform, infilled risers or other approved overhead protection must be provided above the entrance or *exit*.

NSW H102.6 Curtains across exits

A flap or curtain used to cover an *exit* must be so designed that, when it is secured, it will not obstruct or impede egress.

NSW H102.7 Curtains and blinds

Curtains and blinds for use in a *temporary structure* must comply with **Clause 4 of NSW Specification C1.10**.

Table H102.4 NUMBER OF EXITS AND WIDTHS

| Column 1 Accommodation provided | Column 2 Number of <i>exits</i> required | Column 3 Aggregate width of <i>exits</i> |
|---------------------------------------|--|---|
| 1-25 persons | *1-2 | 1 000 |
| 26-50 persons | 2 | 1 500 |
| 51-75 persons | 2 | 2 000 |
| 76-100 persons | 2 | 2 500 |
| 100-200 persons | 2 | 3 000 |
| 201-400 persons | 3 | 4 500 |
| 401-600 persons | 4 | 6 000 |
| 601-800 persons | 5 | 7 500 |
| 801-1000 persons | 5 | 9 000 |
| over 1000 persons | 5 plus one additional <i>exit</i> for each additional 450 persons or part thereof. | 9 000 plus 500 mm for each additional 50 persons or part thereof. |
| *Note: | (a) Where only one <i>exit</i> is provided that <i>exit</i> must be at least 1000 mm wide. | |
| | (b) Where 2 <i>exits</i> are provided each must be at least 500 mm wide. | |

NSW H102.8 Fabrics

Fabric that is used in the construction of a *temporary structure* must have—

- (a) a *Flammability Index* of not more than 6 where used—
 - (i) within a height of 4 m of the base of the *temporary structure*; or
 - (ii) in an air-supported *temporary structure* without other supporting framework; and
- (b) a *Flammability Index* of not more than 25 in every other case.

NSW H102.9 Guardrails

A rigid guardrail must—

- (a) be provided at each end of a stepped or inclined platform, at least 750 mm high above the floor of the platform, and must extend—
 - (i) in the case of a stepped platform, from the front of the first riser; and
 - (ii) in the case of an inclined platform, from the front of the first *row* of seating, to the back of the highest platform and along the rear of that platform for its full width; and
- (b) not obstruct any *aisle*, *cross-over* or *exit*.

NSW H102.10 Seating

Seating must be provided in accordance with [NSW H101.11.1](#), [NSW H101.11.2](#), [NSW H101.11.3\(b\)](#), [NSW H101.11.5\(a\), \(c\)](#), [NSW H101.11.6\(a\)](#) and [NSW H101.11.8\(a\), \(b\), \(c\)](#) and [\(d\)](#).

NSW H102.11 Sanitary accommodation

Suitable sanitary accommodation must be provided at a location convenient to the *temporary structure*.

NSW H102.12 Projection suites

Any *projection suite* must comply with [NSW H101.17.2](#) and [NSW H101.17.3](#).

NSW H102.13 Fireplaces and heating

No fireplace or other form of heating equipment may be installed in a *temporary structure*, without the consent of the approval authority.

NSW H102.14 Electrical services

Electrical services connected to the local supply authority's mains, to a generating plant or to a battery supply must comply with—

- (a) the requirements of the local supply authority; and
- (b) AS 3002; and
- (c) where applicable, AS/NZS 3000; and
- (d) [NSW H101.19.1\(a\)](#) and [NSW H101.19.3\(a\)](#).

NSW H102.15 Artificial lighting

Artificial lighting must be provided, and must comply with [NSW H101.20.1](#) and [NSW H101.20.2](#).

NSW H102.15.1 Emergency lighting levels

Emergency lighting must be provided to the areas provided with artificial lighting under [NSW H102.15](#) and must include a sufficient number of lamps to give a minimum illumination of 0.2 lux at floor level.

NSW H102.15.2 Emergency lighting power supply

Where emergency lighting is provided, the capacity of the battery and charging system must be sufficient to provide the illumination *required* by [NSW H102.15.1](#) for—

- (a) half an hour, in respect of a *temporary structure* designed to accommodate not more than 1000 persons; and
- (b) 1 hour, in respect of a *temporary structure* designed to accommodate more than 1000 persons.

NSW H102.16 Exit signs

Exit signs must be provided above all *exits* and in such other locations as may be *required* by [NSW E4.6](#) and must comply with [E4.5](#) and [E4.8](#).

NSW H102.17 Fire-fighting services

- (a) Fire-fighting services and appliances must be so provided as to afford adequate protection and must be so located as the approving authority, on the advice of the Director-General of New South Wales Fire Brigades, may require.
- (b) Where *required* by the approving authority, the fire-fighting services and appliances must comply with [Part E1](#).

NSW PART H103 DRIVE-IN THEATRES

NSW H103.1 Application of Part

This Part applies to drive-in theatres.

NSW H103.2 Speaker standards

Speaker standards must—

- (a) be placed at a minimum of 5.5 m centres in a line along each parking ramp; and
- (b) be capable of being illuminated throughout any performance so as to be easily distinguishable at all times.

NSW H103.2.1 Lines of speaker standards

Lines of speaker standards along parking ramps must be placed at a distance of not less than 12.2 m apart.

NSW H103.3 Electrical services

The following electrical services must be installed underground—

- (a) the supply authority's conductors within the site and the consumer's mains, unless otherwise approved; and
- (b) electrical wiring external to any building on the site; and
- (c) all wiring to the speaker standards.

NSW H103.4 Vehicular entrances

Each public vehicular entrance to or exit from the drive-in theatre must be capable of being fully illuminated by flood lights that are so placed and so focussed as not to interfere with the vision of the driver of any motor vehicle.

NSW H103.5 Lighting

- (a) Driveways — Entrance and exit driveways, and the perimeter of the holding area, must be capable of being continuously illuminated by lamps capable of producing a minimum illumination of 0.5 lux at ground level.
- (b) Ramp areas — The whole of the ramp area of a drive-in theatre must be capable of being floodlit by means of area flood lights to an illumination of at least 10 lux.

SECTION I MAINTENANCE

PART 11 EQUIPMENT AND SAFETY INSTALLATIONS

Delete I1.1 and insert NSW I1.1 as follows:

NSW I1.1 Essential fire safety measures

Essential fire or other safety measures must be maintained and certified on an ongoing basis, in accordance with the provisions of the Environmental Planning and Assessment Regulation, 2000.

Delete I1.2:

NSW I1.2 Mechanical ventilation and hot water, warm water and cooling water systems

(deleted).

Note.

This clause is deleted from the BCA in NSW, as the maintenance of mechanical ventilation and hot water, warm water and cooling water systems, for the purposes of public health, is regulated in the Public Health Regulation, 2012, under the Public Health Act, 2010.

PART I2 ENERGY EFFICIENCY INSTALLATIONS

Delete BCA PART I2 and insert the following:

NSW PART I2 Energy Efficiency Installations

(deleted)

NSW SECTION J ENERGY EFFICIENCY

Replace Section J with NSW Section J as follows:

Note 1.

NSW Section J consists of two Subsections J(A) and J(B).

NSW Subsection J(A) Energy Efficiency - Class 2 buildings and Class 4 parts

This Subsection contains energy efficiency requirements for Class 2 buildings and Class 4 parts of buildings.

The need for separating these requirements from the requirements for Class 3 buildings arises because, in NSW, Class 2 buildings and Class 4 parts of buildings are subject to BASIX (the Building Sustainability Index), however Class 3 buildings are not.

BASIX is the web-based planning tool designed to assess the potential performance of certain residential buildings against a range of sustainability indices including thermal comfort and energy. Commitments made under BASIX become a condition of the relevant development consent or complying development certificate.

BASIX applies in NSW to all new Class 1 and 2 buildings, and Class 4 parts of buildings; and to alterations and additions to buildings of those classes where the work is subject to BASIX and also where an applicant elects to comply with BASIX.

The provisions of NSW Subsection J(A) are therefore designed to complement requirements that arise under BASIX and which are implemented via the development consent. Where BASIX is not applied to alterations and additions to Class 1 and 2 buildings, and Class 4 parts of buildings, these provisions will also complement council development controls that require energy efficiency measures to be incorporated as part of the alterations and additions.

NSW Subsection J(B) Energy Efficiency - Class 3 and Class 5 to 9 buildings

This subsection contains energy efficiency requirements for Class 3 and Class 5 to 9 buildings.

As Class 3 and Class 5 to 9 buildings are not subject to BASIX, NSW Subsection J(B) applies the provisions of the national Section J relevant to Class 3 and Class 5 to 9 buildings, with minor variations.

Note 2.

All definitions in Part A1 that are applicable to the national Section J are also applicable to NSW Section J.

NSW SUBSECTION J(A) ENERGY EFFICIENCY - CLASS 2 BUILDINGS AND CLASS 4 PARTS

OBJECTIVE

NSW J(A)O1

The *Objective* of this Section is to reduce greenhouse gas emissions.

Application:

NSW J(A)O1 only applies to a Class 2 building and Class 4 part of a building.

FUNCTIONAL STATEMENT

NSW J(A)F1

To reduce greenhouse gas emissions, to the degree necessary, a building, including its *services*, is to be capable of efficiently using energy.

Application:

NSW J(A)F1 only applies to a Class 2 building and Class 4 part of a building.

PERFORMANCE REQUIREMENT

NSW J(A)P1

- (a) Thermal insulation in a building must be installed in a manner and have characteristics, which facilitate the efficient use of energy for artificial heating and cooling.
- (b) A building must have, to the degree necessary, thermal breaks installed between the framing and external cladding, to facilitate efficient thermal performance of the building envelope.

Application:

- (a) NSW J(A)P1(a) only applies to thermal insulation in a Class 2 building or Class 4 part of a building where a development consent specifies that the insulation is to be provided as part of the development.
- (b) In (a), the term development consent has the meaning given by the Environmental Planning and Assessment Act 1979.
- (c) NSW J(A)P1(b) only applies to a metal framed roof and a metal framed wall.

NSW J(A)P2

A building must have, to the degree necessary, a level of building sealing against air leakage to facilitate the efficient use of energy for artificial heating and cooling appropriate to—

- (a) the function and use of the building; and
- (b) the internal environment; and
- (c) the geographic location of the building.

Application:

NSW J(A)P2 only applies to a Class 2 building or Class 4 part of a building, except—

- (a) a building in *climate zones* 2 and 5 where the only means of *air-conditioning* is by using an evaporative cooler; and
- (b) a building *ventilation opening* that is necessary for the safe operation of a gas appliance; and
- (c) parts that cannot be fully enclosed

NSW J(A)P3

A building's *services* must have features that, to the degree necessary, facilitate the efficient use of energy appropriate to—

- (a) the function and use of the *service*; and
- (b) the internal environment; and
- (c) the geographic location of the building; and
- (d) the energy source of the *service*.

Application:

NSW J(A)P3 only applies to a Class 2 building or Class 4 part of a building.

NSW J(A)P4

A building, including its *services*, must have, to the degree necessary, features that facilitate the maintenance of systems and components appropriate to the function and use of the building.

Application:

NSW J(A)P4 only applies to a Class 2 building, except for a *sole-occupancy unit* in that building.

NSW PART J(A)1 BUILDING FABRIC

NSW J(A)1.0 Deemed-to-Satisfy Provisions

- (a) Where a *Building Solution* is proposed to comply with the *Deemed-to-Satisfy Provisions*, Performance Requirement **NSW J(A)P1** is satisfied by complying with **NSW J(A)1.1** and **NSW J(A)1.2**.

- (b) Where a *Building Solution* is proposed as an *Alternative Solution* to the *Deemed-to-Satisfy Provisions* of **NSW J(A)1.1** and **NSW J(A)1.2**, the relevant *Performance Requirements* must be determined in accordance with **A0.10**.

NSW J(A)1.1 Application of Part

- (a) The *Deemed-to-Satisfy Provisions* only apply to thermal insulation in a Class 2 building or Class 4 part of a building where a development consent or complying development certificate specifies that the insulation is to be provided as part of the development.
- (b) In (a), development consent and complying development certificate, have the meaning given to these terms by the Environmental Planning and Assessment Act 1979.
- (c) The *Deemed-to-Satisfy* provisions of this Part for thermal breaks apply to all Class 2 buildings and Class 4 parts.

NSW J(A)1.2 Compliance with BCA provisions

Class 2 buildings and Class 4 parts of buildings must comply with the national BCA provisions of **J0.2(b)** to **(e)** - except that the reference to "Where *required*" in **J1.2** is deemed to refer to "Where a development consent specifies that insulation is to be provided as part of the development."

Note: Compliance is not *required* with the national BCA provisions of **J0.2(a)** as those matters are regulated under BASIX and national BCA provisions of **J0.2(f)** are covered by **NSW J(A)2.2**.

NSW PART J(A)2 BUILDING SEALING

NSW J(A)2.0 Deemed-to-Satisfy Provisions

- (a) Where a *Building Solution* is proposed to comply with the *Deemed-to-Satisfy Provisions, Performance Requirement* **NSW J(A)P2** is satisfied by complying with **NSW J(A)2.1** and **NSW J(A)2.2**.
- (b) Where a *Building Solution* is proposed as an *Alternative Solution* to the *Deemed-to-Satisfy Provisions* of **NSW J(A)2.1** and **NSW J(A)2.2**, the relevant *Performance Requirements* must be determined in accordance with **A0.10**.

NSW J(A)2.1 Application of Part

The *Deemed-to-Satisfy Provisions* of this Part apply to a Class 2 building and a Class 4 part of a building, but exclude—

- (a) a building in *climate zones* 2 and 5 where the only means of *air-conditioning* is by using an evaporative cooler; and
- (b) a building *ventilation opening* that is necessary for the safe operation of a gas appliance; and
- (c) parts of buildings that cannot be fully enclosed.

NSW J(A)2.2 Compliance with BCA provisions

Class 2 buildings and Class 4 parts of buildings must comply with the following national BCA provisions—

- (a) **J3.2** Chimneys and flues; and
- (b) **J3.3** Roof lights; and
- (c) **J3.4** External doors and *windows*; and
- (d) **J3.5** Exhaust fans; and
- (e) **J3.6** Construction of roofs, walls and floors; and
- (f) **J3.7** Evaporative coolers.

NSW PART J(A)3 AIR-CONDITIONING AND VENTILATING SYSTEMS

NSW J(A)3.0 Deemed-to-Satisfy Provisions

- (a) Where a *Building Solution* is proposed to comply with the *Deemed-to-Satisfy Provisions, Performance Requirement NSW J(A)P3* is satisfied by complying with **NSW J(A)3.1** and **NSW J(A)3.2**.
- (b) Where a *Building Solution* is proposed as an *Alternative Solution* to the *Deemed-to-Satisfy Provisions* of **NSW J(A)3.1** and **NSW J(A)3.2**, the relevant *Performance Requirements* must be determined in accordance with **A0.10**.

NSW J(A)3.1 Application of Part

The *Deemed-to-Satisfy Provisions* of this Part apply to a Class 2 building and a Class 4 part of a building.

NSW J(A)3.2 Compliance with BCA provisions

Class 2 buildings and Class 4 parts of buildings must comply with the following national BCA provisions, as applicable—

- (a) **J5.2** Air conditioning and ventilating systems; and
- (b) **J5.3** Time switch; and
- (c) **J5.4(a)** and **(c)** to **(i)** Heating and cooling systems; and
- (d) **J5.5** Ancillary exhaust systems.

Note: Compliance is not *required* with the national BCA provisions of **J5.4(b)** as those matters are regulated under BASIX.

NSW PART J(A)4 HOT WATER SUPPLY

NSW J(A)4.0 Deemed-to-Satisfy Provisions

- (a) Where a *Building Solution* is proposed to comply with the *Deemed-to-Satisfy Provisions, Performance Requirement NSW J(A)P3* is satisfied by complying with **NSW J(A)4.1** and **NSW J(A)4.2**.
- (b) Where a *Building Solution* is proposed as an *Alternative Solution* to the *Deemed-to-Satisfy Provisions* of **NSW J(A)4.1** and **NSW J(A)4.2**, the relevant *Performance Requirements* must be determined in accordance with **A0.10**.

NSW J(A)4.1 Application of Part

The *Deemed-to-Satisfy Provisions* of this Part apply to a Class 2 building and a Class 4 part of a building.

NSW J(A)4.2 Compliance with BCA provisions

Class 2 buildings and Class 4 parts of buildings must comply with the national BCA provisions of **J7.2** Hot water supply.

Note: Compliance is not *required* with the national BCA provisions of **J7.3** and **J7.4** as those matters are regulated under BASIX.

NSW PART J(A)5 ACCESS FOR MAINTENANCE AND FACILITIES FOR MONITORING

NSW J(A)5.0 Deemed-to-Satisfy Provisions

- (a) Where a *Building Solution* is proposed to comply with the *Deemed-to-Satisfy Provisions*, *Performance Requirement NSW J(A)P4* is satisfied by complying with **NSW J(A)5.1** to **NSW J(A)5.3**.
- (b) Where a *Building Solution* is proposed as an *Alternative Solution* to the *Deemed-to-Satisfy Provisions* of **NSW J(A)5.1** to **NSW J(A)5.3**, the relevant *Performance Requirements* must be determined in accordance with **A0.10**.

NSW J(A)5.1 Application of Part

The *Deemed-to-Satisfy Provisions* of this Part apply to a Class 2 building except within a *sole-occupancy unit*.

NSW J(A)5.2 Access for maintenance

Access for maintenance must be provided to—

- (a) adjustable or motorised shading devices; and
- (b) time switches and motion detectors; and
- (c) room temperature thermostats; and
- (d) plant thermostats such as on boilers or refrigeration units; and
- (e) motorised air dampers and control valves; and
- (f) reflectors, lenses and diffusers of light fittings; and
- (g) heat transfer equipment; and
- (h) plant that receives a concession under **JV3(b)** for the use of energy obtained from—
 - (i) an on-site *renewable energy* source; or
 - (ii) another process as reclaimed energy.

NSW J(A)5.3 Compliance with BCA provisions

Class 2 buildings and Class 4 parts of buildings must comply with the national BCA provisions of **J8.3**.

NSW SUBSECTION J(B) ENERGY EFFICIENCY - CLASS 3 AND CLASS 5 TO 9 BUILDINGS

For buildings of Class 3 and Class 5 to 9, the energy efficiency provisions of BCA 2013 as varied by the NSW Appendix, are applicable, as follows—

NSW J(B)1 Compliance with BCA provisions

Class 3 and Class 5 to 9 buildings must comply with all of the provisions of the national **Section J** that are applicable to the relevant classifications, except as varied by **NSW J3.1** Application of Part and **NSW J8.2** Access for maintenance.

Add NSW J3.1(d) as follows:

NSW J3.1 Application of Part

(d) parts of buildings that cannot be fully enclosed.

Delete J8.2 and substitute NSW J8.2 as follows:

NSW J8.2 Access for maintenance

Access for maintenance must be provided to—

- (a) adjustable or motorised shading devices; and
- (b) time switches and motion detectors; and
- (c) room temperature thermostats; and
- (d) plant thermostats such as on boilers or refrigeration units; and
- (e) motorised air dampers and control valves; and
- (f) reflectors, lenses and diffusers of light fittings; and
- (g) heat transfer equipment; and
- (h) plant that receives a concession under **JV3(b)** for the use of energy obtained from—
 - (i) an on-site *renewable energy* source; or
 - (ii) another process as reclaimed energy.

Footnote: OTHER LEGISLATION AFFECTING BUILDINGS

In addition to any applicable provisions of the Environmental Planning and Assessment Act 1979, the Environmental Planning and Assessment Regulation 2000 and this Code, there is a variety of other regulatory provisions, including legislation, regulation and departmental policies that impose requirements affecting the design, construction and/or performance of buildings in NSW.

The following is a non-definitive list of such provisions. It does not include Commonwealth provisions that may apply in NSW, nor planning and environmental standards that may impose building requirements in individual circumstances. It is meant as an indicative guide only and is not to be relied upon in any way as a substitute for further research, investigation and legal advice needed to determine building standards in individual circumstances.

1. Abattoirs, Knackeries and Meat Premises

1.1 Administering Agency

NSW Food Authority

Relevant Legislation

Food Regulation 2010

2. Children's Services

2.1 Administering Agency

Department of Family and Community Services

Relevant Legislation

Children (Education and Care Services) Supplementary Provisions Regulation 2012

2.2 Administering Agency

Department of Education and Communities

Relevant Legislation

Children (Education and Care Services National Law Application) Act 2010

3. Crematoria, Vaults, Mortuary Churches etc.

3.1 Administering Agency

NSW Ministry of Health

Relevant Legislation

Public Health Regulation 2012

4. Crown Land — Construction Approval

4.1 Administering Agency

Department of Primary Industries – Crown Land Division

Relevant Legislation

Crown Lands Act 1989

Crown Lands Regulation 2006

4.2 Administering Agency

Office of Emergency Services

Relevant Legislation

Rural Fires Act 1997

5. Dairies

5.1 Administering Agency

NSW Food Authority

Relevant Legislation

Food Regulation 2010

6. Dangerous Goods (including Gas Installations)

6.1 Administering Agency

Department of Trade and Investment, Regional Infrastructure and Services (Resources and Energy Division)

Relevant Legislation

Gas Supply Act 1996

Gas Supply (Safety and Network Management) Regulation 2008

6.2 Administering Agency

WorkCover Authority

Relevant Legislation

Explosives Regulation 2005

Work Health and Safety Regulation 2011

6.3 Administering Agency

NSW Fair Trading

Relevant Legislation

Gas Supply (Consumer Safety) Regulation 2012

7. Dining Rooms and Bars

7.1 Administering Agency

NSW Food Authority

Relevant Legislation

Food Regulation 2010

8. Electrical Installations

8.1 Administering Agency

NSW Fair Trading

Relevant Legislation

Electricity (Consumer Safety) Regulation 2006

Electricity (Consumer Safety) Act 2004

8.2 Administering Agency

WorkCover Authority

Relevant Legislation

Work Health and Safety Regulation 2011

9. Fire Prevention in Existing Buildings

9.1 Administering Agency

Department of Planning and Infrastructure

Relevant Legislation

Environmental Planning and Assessment Act 1979

Environmental Planning and Assessment Regulation 2000

10. Food Premises

10.1 Administering Agency

NSW Food Authority

Relevant Legislation

Food Regulation 2010

11. Foundries

11.1 Administering Agency

Department of Trade and Investment, Regional Infrastructure and Services (Resources and Energy Division)

Relevant Legislation

Gas Supply Act 1996

12. Historic Buildings

12.1 Administering Agency

Heritage Branch

Office of Environment and Heritage

Relevant Legislation

Heritage Regulation 2005

13. Hospitals, Nursing Homes and Health Care Buildings

13.1 Administering Agency

NSW Ministry of Health

Relevant Legislation

Private Health Facilities Regulation 2010

Poisons and Therapeutic Goods Regulation 2008

14. Hot Water Systems and Air Handling Systems

14.1 Administering Agency

NSW Ministry of Health

Relevant Legislation

Public Health Regulation 2012

15. Lift Installations

15.1 Administering Agency

WorkCover Authority

Relevant Legislation

Work Health and Safety Regulation 2011

16. Moveable Dwellings (in Caravan Parks)

16.1 Administering Agency

Division of Local Government

Relevant Legislation

Local Government Act 1993

16.2 Administering Agency

Division of Local Government

Department of Planning and Infrastructure

Relevant Legislation

Local Government (Manufactured Home Estates, Caravan Parks, Camping Grounds and Moveable Dwellings) Regulation 2005

17. Occupational Health and Safety

17.1 Administering Agency

WorkCover Authority

Relevant Legislation

Work Health and Safety Regulation 2011

18. Pharmacies

18.1 Administering Agency

Pharmacy Council of New South Wales

Relevant Legislation

Health Practitioner Regulation (New South Wales) Regulation 2010

19. Planning Controls

19.1 Administering Agency

Department of Planning and Infrastructure

Relevant Legislation

Environmental Planning and Assessment Act 1979

Environmental Planning and Assessment Regulation 2000

20. Premises for Activities Involving Skin Penetration

20.1 Administering Agency

NSW Ministry of Health

Relevant Legislation

Public Health Regulation 2012

21. Sanitary Plumbing, Water Supply and Sewerage

21.1 Administering Agency

Division of Local Government

Relevant Legislation

Local Government Act 1993

Local Government (General) Regulation 2005

21.2 Administering Agency

NSW Fair Trading

Relevant Legislation

Plumbing and Drainage Act 2011

Plumbing and Drainage Regulation 2012

22. Septic Tank Installations

22.1 Administering Agency

Division of Local Government

Relevant Legislation

Local Government Act 1993

Local Government (General) Regulation 2005

23. Sleeping Accommodation

23.1 Administering Agency

NSW Ministry of Health

Relevant Legislation

Public Health Regulation 2012

24. Smoking Restrictions

24.1 Administering Agency

NSW Ministry of Health

Relevant Legislation

Smoke Free Environment Regulation 2007

Smoke-free Environment Act 2000

Public Health (Tobacco) Act 2008

25. Subdivision of Buildings

25.1 Administering Agency

Department of Finance and Services – Land and Property Information

Relevant Legislation

Conveyancing Act 1919

Strata Schemes (Freehold Development) Act 1973

Strata Schemes (Leasehold Development) Act 1986

26. Swimming Pool Fences

26.1 Administering Agency

Division of Local Government

Relevant Legislation

Swimming Pools Act 1992

Swimming Pools Regulation 2008

27. Temporary Structures

27.1 Administering Agency

Department of Planning and Infrastructure

Relevant Legislation

Environmental Planning and Assessment Act 1979

Environmental Planning and Assessment Regulation 2000

NORTHERN TERRITORY

INTRODUCTION

This Appendix contains variations and additions to the Building Code of Australia (BCA) provisions which are considered necessary for the effective application of the Code in the Northern Territory.

APPENDIX CONTENTS

APPENDIX NORTHERN TERRITORY

Northern Territory

A GENERAL PROVISIONS

NT Specification A1.3 Standards Adopted by Reference

B STRUCTURE

NT B1.4 Determination of structural resistance of materials and forms of construction

NT addition to Specification B1.2

E SERVICES AND EQUIPMENT

NT E1.5 Sprinklers

F HEALTH AND AMENITY

NT FO5 Objective

NT FF5.1 Functional Statement

NT FP5.1 - NT FP5.4 Performance Requirements

NT F5.0 Deemed-to-Satisfy Provisions

NT F5.1 Application of Part

NT F5.2 Weighted sound reduction index: Interpretation

NT F5.3 Sound insulation of floors between units

NT F5.4 Sound insulation of walls between units

NT F5.5 Walls between a bathroom, sanitary compartment, laundry or kitchen and a habitable room in adjoining unit

NT F5.6 Soil and waste pipes to be separated

NT F5.7 Isolation of pumps

NT F5.8 Walls between a bedroom and kitchen or laundry in a Class 9c building

NT Specification F5.2 Sound Insulation for Building Elements

NT Specification F5.5 Impact Sound - Test of Equivalence

G ANCILLIARY PROVISIONS

NT GO1 Objective

NT GF1.1 - GF1.2 Functional Statements

NT GP1.1 - GP1.2 Performance Requirements

NT G1.1 Swimming pools

H SPECIAL USE BUILDINGS

NT Part H101 * * * * *

NT Part H102 Premises to be used for Activities Involving Skin Penetration

NT H102.1 Application of Part

NT H102.2 * * * * *

NT H102.3 Washbasins

NT Part H103 Mortuaries

NT H103.1 Application of Part

NT H103.2 Layout of mortuary

NT H103.3 Construction of body preparation room

NT H103.4 Water supply and sewerage

I MAINTENANCE

NT I1.1 Safety measures

NT Part I2 Energy Efficiency Installations

J ENERGY EFFICIENCY

NT SECTION J Energy Efficiency

Footnote: Other Legislation Affecting Buildings

SECTION A GENERAL PROVISIONS

PART A1 INTERPRETATION

NT Specification A1.3 STANDARDS ADOPTED BY REFERENCE

Insert in Table 1 of Specification A1.3 the following:

NT Table 1 SCHEDULE OF REFERENCED DOCUMENTS

| No | Date | Title | BCA Clause(s) |
|--------------------|------|--|---------------------|
| AS/NZS 1170 | | Structural design actions | |
| Part 2 | 2011 | Wind actions Amdt 1 | NT Spec B1.2 |
| AS 1851 | | Maintenance of fire protection equipment | NT 11.1 |
| Part 1 | 1995 | Portable fire extinguishers and fire blankets | |
| Part 2 | 1995 | Fire hose reels | |
| Part 3 | 1997 | Automatic fire sprinkler systems | |
| Part 4 | 1992 | Fire hydrant installations | |
| Part 5 | 1981 | Automatic smoke/heat venting systems | |
| Part 6 | 1997 | Management procedures for maintaining the fire precaution features of air-handling systems | |
| Part 7 | 1984 | Fire-resistant doorsets | |
| Part 8 | 1987 | Automatic fire detection and alarm systems | |
| Part 10 | 1989 | Emergency warning and intercommunication systems | |
| AS/NZS 2293 | | Emergency evacuation lighting for buildings | |
| Part 2 | 1995 | Inspection and maintenance | NT 11.1 |
| AS 3660 | | Termite management | |

NT Table 1 SCHEDULE OF REFERENCED DOCUMENTS— continued

| No | Date | Title | BCA Clause(s) |
|----------|----------|----------------------------|---------------|
| Part 1 | 2000 | New building work | NT B1.4 |
| BCA 2009 | May 2009 | Building Code of Australia | NT Section J |

SECTION B STRUCTURE

PART B1 STRUCTURAL PROVISIONS

Delete B1.4(i) and insert NT B1.4(i) as follows:

NT B1.4 Determination of structural resistance of materials and forms of construction

- (i) Termite Risk Management: Where a *primary building element* is subject to attack by subterranean termites—
 - (i) AS 3660.1 with additional protection measures to be used in areas where *Mastotermes darwiniensis* are prevalent; and
 - (ii) for the purpose of this provision, a *primary building element* consisting entirely of, or a combination of, any of the following materials is considered not to be subject to termite attack:
 - (A) Steel, aluminium or other metals.
 - (B) Concrete.
 - (C) Masonry.
 - (D) Fibre-reinforced cement.
 - (E) Timber in areas where *Mastotermes darwiniensis* are not prevalent—naturally termite resistant in accordance with Appendix C of AS 3660.1.
 - (F) Timber — preservative treated in accordance with Appendix D of AS 3660.1; and
 - (iii) where a termite risk management system in accordance with AS 3660.1 is used, a durable notice must be permanently fixed to the building in a prominent location, such as a meter box or the like, indicating—
 - (A) the method of termite risk management; and
 - (B) the date of installation of the system; and
 - (C) where a chemical barrier is used, its life expectancy as listed on the National Registration Authority label; and
 - (D) the installer's or manufacturer's recommendations for the scope and frequency of future inspections for termite activity.

NT ADDITION TO SPECIFICATION B1.2

Add clause NT3 and clause NT4 as follows–

NT3 Strengthened area

Where a residential building of Class 2, 3, 9a or 9c, in Region C as defined by AS/NZS 1170.2, is designed to be used by the Aged or Infirm it shall incorporate a “strengthened area” for use as shelter during cyclonic conditions and must comply with the following criteria:

(“strengthened area” is defined as the strengthening of an area to increase its potential to facilitate debris protection)

- (a) The *floor area* of the “strengthened area” is to be calculated at the rate of 1.2 m² per person normally accommodated within the building.
- (b) The minimum standard of debris protection to be achieved is represented by the following construction:
 - (i) 200 mm masonry block walls reinforced in accordance with the Northern Territory Deemed to Comply Standards (DTC) and core filled every core; or
Timber or steel framed walls clad internally and externally with 18 mm structural ply, screw fixed at 150 mm centres to studs, plates and noggins; and
 - (ii) Ceiling battens strapped to truss bottom chords or ceiling joists in accordance with the DTC Standard; and
18 mm structural ply screw fixed to ceiling battens at 150 mm centres; and
 - (iii) All doors serving the strengthened area are to be internal and are to be solid core, inward opening with barrel bolts fitted to the top and bottom; and
 - (iv) All *windows* protected with debris screens in accordance with DTC Standards.

NT4 Masonry veneer construction

Masonry veneer construction must be designed so that the structural framing, to which the masonry veneer is tied, will ensure the stability of the masonry veneer.

SECTION E SERVICES AND EQUIPMENT

PART E1 FIRE-FIGHTING EQUIPMENT

NT E1.5 Sprinklers

Insert provisions for Class 9a buildings in Table E1.5 as follows:

NT Table E1.5 REQUIREMENTS FOR SPRINKLERS

| Occupancy | When sprinklers are required |
|-----------|--------------------------------|
| Class 9a | if more than one <i>storey</i> |

SECTION F HEALTH AND AMENITY

PART F5 SOUND TRANSMISSION AND INSULATION

Delete Part F5 and insert NT Part F5 as follows:

OBJECTIVE

NT FO5

The *Objective* of this Part is to safeguard occupants from illness or loss of amenity as a result of undue sound being transmitted—

- (a) between adjoining *sole-occupancy units*; and
- (b) from common spaces to *sole-occupancy units*.

Application:

NT FO5 only applies to a Class 2 or 3 building or a Class 9c *aged care building*.

FUNCTIONAL STATEMENT

NT FF5.1

A building element which separates *sole-occupancy units*, or separates a *sole-occupancy unit* from a common space within the building, is to be constructed to prevent undue sound transmission.

Application:

NT FF5.1 only applies to a Class 2 or 3 building or a Class 9c *aged care building*.

PERFORMANCE REQUIREMENTS

NT FP5.1

Floors separating *sole-occupancy units* must provide insulation against the transmission of airborne and impact generated sound sufficient to prevent illness or loss of amenity to the occupants.

Application:

NT FP5.1 only applies to a Class 2 or 3 building or a Class 9c *aged care building*.

NT FP5.2

Walls separating—

- (a) *sole-occupancy units*; or
- (b) a *sole-occupancy unit* from a plant room, lift *shaft*, stairway, *public corridor*, public lobby or the like,

must provide insulation against the transmission of airborne and impact generated sound sufficient to prevent illness or loss of amenity to the occupants.

Application:

NT FP5.2 only applies to a Class 2 or 3 building.

NT FP5.3

The *required* sound insulation of floors or walls must not be compromised by the incorporation or penetration of a pipe or other service element.

Application:

NT FP5.3 only applies to a Class 2 or 3 building or a Class 9c *aged care building*.

NT FP5.4

Walls separating—

- (a) *sole-occupancy units*; or
- (b) a *sole-occupancy unit* from a kitchen, bathroom, *sanitary compartment* (not being an associated ensuite), laundry, plant room or utilities room,

must provide insulation against the transmission of airborne sound sufficient to prevent illness or loss of amenity to the occupants; and

- (c) a *sole-occupancy unit* from a kitchen or laundry,

must provide insulation against the transmission of impact generated sound sufficient to prevent illness or loss of amenity to the occupants.

Application:

NT FP5.4 only applies to a Class 9c *aged care building*.

NT F5.0 Deemed-to-Satisfy Provisions

- (a) Where a *Building Solution* is proposed to comply with the *Deemed-to-Satisfy Provisions, Performance Requirements NT FP5.1 to NT FP5.4* are satisfied by complying with **NT F5.1 to NT F5.8**.
- (b) Where a *Building Solution* is proposed as an *Alternative Solution* to the *Deemed-to-Satisfy Provisions of NT F5.1 to NT F5.8*, the relevant *Performance Requirements* must be determined in accordance with **A0.10**.

NT F5.1 Application of Part

The *Deemed-to-Satisfy Provisions* of this Part apply to Class 2 and 3 buildings and Class 9c *aged care buildings*.

NT F5.2 Weighted sound reduction index: Interpretation

A form of construction *required* to have a certain weighted sound reduction index (R_w) must—

- (a) have the *required* value determined under AS/NZS 1276.1, or ISO 717.1; or
- (b) comply with **NT Specification F5.2**.

NT F5.3 Sound insulation of floors between units

A floor separating *sole-occupancy units* must have an R_w not less than 45.

NT F5.4 Sound insulation of walls between units

A wall must have an R_w not less than 45 if it separates—

- (a) *sole-occupancy units*; or
- (b) a *sole-occupancy unit* not within a Class 9c *aged care building* from a plant room, lift *shaft*, stairway, *public corridor*, hallway or the like.
- (c) a *sole-occupancy unit* in a Class 9c *aged care building* from a kitchen, bathroom, *sanitary compartment* (not being an associated ensuite), laundry, plant room or utilities room.

NT F5.5 Walls between a bathroom, sanitary compartment, laundry or kitchen and a habitable room in adjoining unit

- (a) Except for a Class 9c *aged care building*, a wall separating a bathroom, *sanitary compartment*, laundry or kitchen in one *sole-occupancy unit* from a *habitable room* (other than a kitchen) in an adjoining unit must—
 - (i) have an R_w of not less than 50; and
 - (ii) provide a satisfactory level of insulation against impact sound; and
 - (iii) not incorporate a duct which reduces the R_w of the wall to less than 50.
- (b) A wall satisfies **(a)(i)** and **(a)(ii)** if it is—
 - (i) in accordance with **NT Table F5.5**; or
 - (ii) for other than masonry, in 2 or more separate leaves without rigid mechanical connection except at their periphery; or
 - (iii) identical with a prototype that is no less resistant to the transmission of impact sound when tested in accordance with **NT Specification F5.5** than a wall listed in **NT Table F5.5**.

NT Table F5.5 CONSTRUCTION OF WALLS TO REDUCE IMPACT SOUND

| |
|--|
| <p>Cavity brickwork—</p> <p>Two leaves of 90 mm brick masonry with—</p> <ul style="list-style-type: none"> (i) all joints filled solid with mortar; and (ii) an air space not less than 40 mm between the leaves; and |
|--|

NT Table F5.5 CONSTRUCTION OF WALLS TO REDUCE IMPACT SOUND— continued

| |
|--|
| <p>(iii) the leaves connected only by ties in accordance with AS 3700.</p> |
| <p>Single leaf brickwork— 110 mm thick brick masonry with—</p> <ul style="list-style-type: none"> (i) each face rendered 13 mm thick; and (ii) 50 mm x 12 mm thick timber battens at not more than 610 mm centres fixed to each face but not recessed into the render; and (iii) one layer of 12 mm thick softboard nailed to the battens; and (iv) 6 mm thick medium density hardboard adhesive-fixed to the softboard. |
| <p>Concrete blockwork— 190 mm thick concrete block masonry with—</p> <ul style="list-style-type: none"> (i) each face of the blocks fitted with 50 mm x 50 mm timber battens, spaced at not more than 610 mm centres, screw-fixed into resilient plugs with rubber inserts; and (ii) the space between the battens completely filled with mineral or glass wool blanket or batts not less than 50 mm thick; and (iii) the outer face of the battens finished with plasterboard not less than 10 mm thick or other material with a mass per unit area not less than 7.3 kg/m². |

NT F5.6 Soil and waste pipes to be separated

If a soil or waste pipe, including a pipe that is embedded in or passes through a floor, serves or passes through more than one *sole-occupancy unit*—

- (a) the pipe must be separated from the rooms of any *sole-occupancy unit* by construction with an R_w not less than—
 - (i) 45 if the adjacent room is a *habitable room* (other than a kitchen); or
 - (ii) 30 if the adjacent room is a kitchen or any other room; and
- (b) a door or panel providing access to the pipe must not open into any *habitable room* (other than a kitchen); and
- (c) an access door or panel in any other part must be firmly fixed so as to overlap the frame or rebate of the frame by not less than 10 mm, be fitted with a sealing gasket along all edges and constructed of—
 - (i) wood, particleboard or blockboard not less than 38 mm thick; or
 - (ii) compressed fibre reinforced cement sheeting not less than 9 mm thick; or
 - (iii) other suitable material with a mass per unit area not less than 24.4 kg/m².

NT F5.7 Isolation of pumps

A flexible coupling must be used at the point of connection between the service pipes in a building and any circulating or other pump.

NT F5.8 Walls between a bedroom and kitchen or laundry in a Class 9c building

In addition to **NT F5.4**, a wall separating a *sole-occupancy unit* in a Class 9c *aged care building* from a kitchen or laundry must—

- (a) for other than masonry, be two or more separate leaves without rigid mechanical connection except at their periphery; or
- (b) be identical with a prototype that is no less resistant to the transmission of impact sound when tested in accordance with **NT Specification F5.5** than a wall listed in **Table 2 of NT Specification F5.2**.

SPECIFICATION **F5.2** SOUND INSULATION FOR BUILDING
ELEMENTS

Deemed-to-Satisfy Provisions

1. Scope

This Specification lists the weighted sound reduction index (R_w) for some common forms of construction.

2. Construction deemed-to-satisfy

The forms of construction listed in **Table 2** are considered to have the R_w stated in that Table if installed as follows:

- (a) **Masonry**—Units must be laid with all joints filled solid, including those between the masonry and any adjoining construction.
- (b) **Concrete slabs**—Joints between concrete slabs and any adjoining construction must be filled solid.
- (c) **Plasterboard**—
 - (i) if one layer is *required* under this Specification, it must be screw-fixed to the studs with joints staggered on opposite faces; and
 - (ii) if 2 layers are *required*, the first layer must be fixed according to (i) and the second layer must be fixed to the first layer with nails, screws or adhesive so that the joints do not coincide with those of the first layer; and
 - (iii) joints between sheets or between sheets and any adjoining construction must be taped and filled solid; and
 - (iv) fire-protective grade plasterboard must be the special grade manufactured for use in *fire-resisting construction*.
- (d) **Steel studs and perimeter members**—
 - (i) the section of steel must be not less than 0.6 mm thick; and
 - (ii) studs must be not less than 63 mm in depth unless another depth is listed in **Table 2**; and
 - (iii) studs must be fixed to steel top and bottom plates of sufficient depth to permit secure fixing of the plasterboard; and
 - (iv) all steel members at the perimeter of the wall must be securely fixed to the adjoining structure and bedded in resilient compound or the joints must be caulked so that there are no voids between the steel members and the wall.

Deemed-to-Satisfy Provisions

Table 2 R_w APPLICABLE TO CONSTRUCTION

| Construction | R _w (not less than) |
|--|-----------------------------------|
| WALLS | |
| Clay brickwork— | |
| (a) 230 mm thick in one or more leaves and with a mass per unit area of not less than 290 kg/m ² | 45 |
| (b) 110 mm thick rendered 13 mm thick on both sides with a mass per unit area of the unrendered wall being not less than 190 kg/m ² | 45 |
| (c) 110 mm thick, of semi-dry-pressed bricks and rendered 13 mm on one side, the mass per unit area of the unrendered wall being not less than 215 kg/m ² | 45 |
| (d) 110 mm thick, of extruded brick and rendered 13 mm on one side, the mass per unit area of the unrendered wall being not less than 180 kg/m ² | 45 |
| Concrete brickwork — 110 mm thick with a mass per unit area of not less than 195 kg/m ² | 45 |
| Concrete blockwork— | |
| (a) 190 mm thick with a mass per unit area of not less than 215 kg/m ² | 45 |
| (b) (i) 140 mm thick, the wall thickness of the blocks being not less than 44 mm and with— 50 mm x 50 mm timber battens spaced at not more than 610 mm centres screw-fixed on one face of the blocks into resilient plugs with rubber inserts between battens and the wall; | |
| (ii) the face of the battens clad with 13 mm thick standard plasterboard; and | |
| (iii) a mass per unit area of the whole system of not less than 220 kg/m ² | 45 |
| Concrete— | |
| (a) In-situ concrete — 125 mm thick and with a density of not less than 2200 kg/m ³ | 45 |
| (b) In-situ concrete — 100 mm thick and with a density of not less than 2500 kg/m ³ | 45 |
| (c) Precast concrete — 100 mm thick and without joints | 45 |
| Steel stud walling— | |
| (a) with 2 layers of 16 mm thick fire-protective grade plasterboard fixed to each face | 45 |

Deemed-to-Satisfy Provisions

Table 2 R_w APPLICABLE TO CONSTRUCTION— continued

| Construction | R_w (not less than) |
|---|--|
| (b) with— | 45 |
| (i) 1 layer of 13 mm thick fire-protective grade plasterboard fixed to one face, and before fixing, 50 mm thick mineral or glass wool blanket or batts stapled to the back of each sheet so that the sheet is completely covered; and | |
| (ii) 2 layers of 13 mm thick fire-protective grade plasterboard fixed to the other face | |
| (c) with— | 45 |
| (i) 1 layer of 16 mm fire-protective grade plasterboard fixed to one face; and | |
| (ii) 50 mm thick mineral or glass wool blanket or batts wedged firmly between the studs; and | |
| (iii) 2 layers of fire-protective grade plasterboard fixed to the other face, the inner layer being 16 mm thick and the outer layer being 13 mm | |
| (d) with 2 layers of 13 mm plasterboard on both sides of 75 mm studs | 45 |
| FLOORS— | |
| Concrete— | |
| (a) In-situ concrete slab — 125 mm thick and with a density of not less than 2200 kg/m ³ | 45 |
| (b) In-situ concrete slab — 100 mm thick and with a density of not less than 2500 kg/m ³ | 45 |
| (c) Pre-cast concrete slab — 100 mm thick and without joints | 45 |
| Timber — comprising— | |
| (a) timber joists not less than 175 mm x 50 mm; and | 45 |
| (b) 75 mm thick mineral or glass wool blanket or batts cut to fit tightly between joists and laid on 10 mm thick plasterboard fixed to underside of joists; and | |
| (c) 25 mm thick mineral or glass wool blanket or batts laid over entire floor, including tops of joists before flooring is laid; and | |
| (d) tongued-and-grooved boards not less than 19 mm thick, secured to 75 mm x 50 mm battens; and | |
| (e) the assembled flooring laid over the joists, but not fixed to them, with the battens lying between the joists | |

Deemed-to-Satisfy Provisions

Table 2 R_w APPLICABLE TO CONSTRUCTION— continued

| Construction | R _w (not less than) |
|---|-----------------------------------|
| DUCTS OR OTHER CONSTRUCTION SEPARATING SOIL AND WASTE PIPES FROM UNITS | |
| Masonry — not less than 90 mm thick | 30 |
| Plasterboard — 2 layers of plasterboard— | |
| (a) each 10 mm thick, fixed to timber studs not less than 75 mm x 50 mm and spaced at not more than 400 mm centres. | 30 |
| (b) each 13 mm thick, one on each side of steel studs not less than 50 mm deep and spaced at not more than 400 mm centres | 30 |

SPECIFICATION **F5.5** IMPACT SOUND — TEST OF
EQUIVALENCE

Deemed-to-Satisfy Provisions

1. Scope

This Specification describes a method of test to determine the comparative resistance of walls to the transmission of impact sound.

2. Construction to be tested

- (a) The test is conducted on a specimen of prototype wall construction and on a specimen of one or other of the constructions specified in **NT Table F5.5**.
- (b) The testing of a construction specified in **NT Table F5.5** need not be repeated for subsequent comparisons provided complete records of the results, the test equipment and the technique of testing are kept so that identical equipment can be employed and an identical technique can be adopted in the testing of specimens of prototype wall construction.

3. Method

- (a) The wall constructions to be compared must be tested in accordance with AS 1191.
- (b) A horizontal steel platform 510 mm x 460 mm x 10 mm thick must be placed with one long edge in continuous and direct contact with the wall to be tested on the side of the wall on which the impact sound is to be generated.
- (c) A tapping machine complying with *ISO 140/6—1998 (E)* must be mounted centrally on the steel platform.
- (d) The sound transmission through the wall must be determined in accordance with AS 1191 except that the tapping machine as mounted on the steel platform must be used as the source of sound.
- (e) The impact sound pressure levels measured in the receiving room must be converted into normalised levels using a reference equivalent absorption area of 10 m².

SECTION G ANCILLARY PROVISIONS

PART G1 MINOR STRUCTURES AND COMPONENTS

Delete GO1(a) to (c) and insert NT GO1(a) to (c) as follows:

| |
|------------------|
| OBJECTIVE |
|------------------|

NT GO1

- (a) * * * * *
- (b) * * * * *
- (c) * * * * *

Delete GF1.1 and GF1.2 and insert NT GF1.1 and NT GF1.2 as follows:

| |
|------------------------------|
| FUNCTIONAL STATEMENTS |
|------------------------------|

NT GF1.1 * * * * *

NT GF1.2

A *swimming pool* is to be provided with—

- (a) * * * * *
- (b) means to reduce the possibility of a person being entrapped or injured due to suction by a water recirculation system.

Delete GP1.1 and GP1.2 insert NT GP1.1 and NT GP1.2 as follows:

| |
|---------------------------------|
| PERFORMANCE REQUIREMENTS |
|---------------------------------|

NT GP1.1 * * * * *

NT GP1.2

- (a) * * * * *
- (b) A *swimming pool* water recirculation system must incorporate safety measures to avoid entrapment of, or injury to, a person.

Delete G1.1(a) and (b) and insert NT G1.1(a) and (b) as follows:

NT G1.1 Swimming pools

- (a) * * * * *
- (b) * * * * *

Note:

Barriers and fences for *swimming pools* are regulated by the Northern Territory of Australia Swimming Pool Safety Act 2004.

SECTION H SPECIAL USE BUILDINGS

NT PART H101 * * * * *

This clause has deliberately been left blank.

Insert NT Part H102 as follows:

NT PART H102 PREMISES TO BE USED FOR ACTIVITIES INVOLVING SKIN PENETRATION

NT H102.1 Application of Part

This part applies to premises for tattooing, ear-piercing, acupuncture and like activities.

NT H102.2 * * * * *

This clause has deliberately been left blank.

NT H102.3 Washbasins

The area in which skin penetration is done must be provided with—

- (a) one wash basin for each 10, or part of 10 employees; and
- (b) an adequate supply of hot and cold water controlled by foot-operated or elbow-operated taps.

Insert NT Part H103 as follows:

NT PART H103 MORTUARIES

NT H103.1 Application of Part

This Part applies to any premises used for storage or preparation for burial, cremation or disposal by other means, of bodies of deceased persons.

NT H103.2 Layout of mortuary

- (a) A mortuary may be integral with the remainder of a building but must be separated physically from all public areas of that building.
- (b) Each mortuary at which bodies are prepared for burial, cremation or other disposal must be provided with a body preparation room that is capable of being isolated from the remainder of the premises.
- (c) A vehicle reception area or garage must be provided adjacent to and with direct access to the storage room or body preparation room to ensure that the transfer of uncoffined bodies is screened from public view.
- (d) Access to toilet and shower facilities from any other part of the mortuary premises must be only by way of an air lock.

NT H103.3 Construction of body preparation room

- (a) The floor must be—
 - (i) of impervious material with a smooth, unbroken surface; and
 - (ii) uniformly graded to a floor drain.
- (b) All walls and partitions must be of concrete or masonry with a smooth, unbroken finish for ease of cleaning.
- (c) All joints between the floor, walls, partitions, ceiling, ventilation grilles, fittings, pipework, *windows* and light fittings must be sealed with impervious material for ease of cleaning.
- (d) All joints between the floor and walls or partitions must be coved for ease of cleaning.
- (e) The body preparation room must be provided with at least one washbasin, fitted with elbow or foot-operated taps, and an adequate supply of hot and cold water.
- (f) The body preparation room must be provided with refrigerated storage facilities—
 - (i) with sufficient capacity for the storage of at least two adult bodies; and
 - (ii) capable of maintaining an internal temperature between 1°C and 5°C.

NT H103.4 Water supply and sewerage

Each mortuary with a body preparation room must be connected to—

- (a) a permanent water supply with a physical discontinuity between the water supply and all equipment, appliances, fittings and areas in the mortuary; and
- (b) a water carriage sewerage system.

SECTION I MAINTENANCE

PART 11 EQUIPMENT AND SAFETY INSTALLATIONS

Delete I1.1 and insert NT I1.1 as follows:

NT I1.1 Safety Measures

Safety measures in buildings must be maintained in accordance with the requirements of the following Australian Standards as appropriate:

- (a) AS 1851.1 Portable fire extinguishers
- (b) AS 1851.2 Fire hose reels
- (c) AS 1851.3 Automatic fire sprinkler systems
- (d) AS 1851.4 Fire hydrant installations
- (e) AS 1851.5 Automatic smoke/heat venting systems
- (f) AS 1851.6 Management procedures for maintaining the fire precaution features of air-handling systems
- (g) AS 1851.7 Fire-resistant door sets
- (h) AS 1851.8 Automatic fire detection and alarm systems
- (i) AS 1851.10 Emergency warning and intercommunication systems
- (j) AS/NZS 2293.2 Emergency evacuation lighting for buildings, Part 2 Inspection and maintenance

PART I2 ENERGY EFFICIENCY INSTALLATIONS

Delete Part I2 and insert the following:

NT PART I2 Energy Efficiency Installations

(deleted)

SECTION J ENERGY EFFICIENCY

SECTION J ENERGY EFFICIENCY

Delete Section J and insert the following:

NT Section J Energy Efficiency

For a Class 2 building and a Class 4 part of a building, **Section J** is replaced with **Section J** of BCA 2009.

Section J does not apply to Class 3 and 5 - 9 buildings.

Footnote: OTHER LEGISLATION AFFECTING BUILDINGS

In addition to any applicable provisions of the Building Act, Building Regulations and this Code, there are a number of other legislative technical requirements affecting the design, construction and/or performance of buildings that practitioners may need to be aware of, including, but not necessarily limited to, the following list. Additional legislative instruments such as regulations, codes and standards may exist under the legislation listed.

1. Accommodation/Food Premises/Skin Penetration Activities/Mortuaries

1.1 Administering Agency

Department of Health

Relevant Legislation

Public Health Act

2. Child Care

2.1 Administering Agency

Department of Health

Relevant Legislation

Community Welfare Act

Community Welfare (Child Care) Regulations

3. Crown Land

3.1 Administering Agency

Department of Lands, Planning and the Environment

Relevant Legislation

Crown Lands Act

4. Dangerous Goods

4.1 Administering Agency

NT Worksafe

Relevant Legislation

Dangerous Goods Act

5. Electrical Installations

5.1 Administering Agency

Department of Employment, Education and Training

Relevant Legislation

Electrical Workers and Contractors Act

Electricity Reform Act

Electricity Reform (Safety and Technical) Regulations

6. Fences — dividing

6.1 Administering Agency

Department of Justice

Relevant Legislation

Fences Act

7. Fire Prevention

7.1 Administering Agency

Northern Territory Fire and Rescue Service

Relevant Legislation

Fire and Emergency Act

8. Gas Installations

8.1 Administering Agency

NT Worksafe

Relevant Legislation

Work Health Act

Work Health (Occupational Health and Safety) Regulations

9. Historic Building

9.1 Administering Agency

Department of Lands, Planning and the Environment

Relevant Legislation

Heritage Conservation Act

10. Liquor — licensing

10.0 Administering Agency

Department of Justice

Relevant Legislation

Liquor Act

11. Occupational Health and Safety

11.1 Administering Agency

NT Worksafe

Relevant Legislation

Work Health Act

12. Places of Public Entertainment

12.1 Administering Agency

Department of Local Government

Council or Municipality

Relevant Legislation

Places of Public Entertainment Act

13. Planning Controls

13.1 Administering Agency

Department of Lands, Planning and the Environment

Relevant Legislation

Planning Act

Planning Scheme

14. Plumbing Installations

14.1 Administering Agency

Department of Lands, Planning and the Environment

Relevant Legislation

Plumbers and Drainers Licensing Act

Building Act

15. Stormwater Drainage (Municipal Roads)

15.1 Administering Agency

Council or Municipality in which building is located

Relevant Legislation

Local Government Act

16. Stormwater Drainage (Territory Roads)

16.1 Administering Agency

Department of Transport

Relevant Legislation

Control of Roads Act

17. Swimming Pools

17.1 Administering Agency

Department of Sport and Recreation

Relevant Legislation

Swimming Pool Safety Act

18. Water Supply and Sewage Services

18.1 Administering Agency

Power and Water Corporation

Relevant Legislation

Water Supply and Sewerage Services Act

QUEENSLAND

INTRODUCTION

This Appendix contains variations and additions to the Building Code of Australia (BCA) provisions which are considered necessary for the effective application of the Code in Queensland and shall be treated as amendments to the Code.

APPENDIX CONTENTS

APPENDIX QUEENSLAND

Queensland

A GENERAL PROVISIONS

Qld Specification A1.3 Standards Adopted by Reference

B STRUCTURE

Qld B1.4 Determination of structural resistance of materials and forms of construction

G ANCILLARY PROVISIONS

Qld GO1 Objective
Qld GF1.2 Functional Statements
Qld GP1.2 Performance Requirements
Qld G1.1 Swimming pools
Qld GO5 Objective
Qld GF5.1 Functional Statement
Qld GP5.1 Performance Requirements
Qld G5.1 Deemed-to-Satisfy Provisions

Qld Part G101 CERTAIN ATTACHMENTS

Qld G101.1 Prevention of falls from buildings or structures

J ENERGY EFFICIENCY

Footnote: Other Legislation Affecting Buildings

SECTION A GENERAL PROVISIONS

Qld Specification A1.3 STANDARDS ADOPTED BY REFERENCE

Insert in Table 1 of Specification A1.3 additional standards as follows:

Qld Table 1 SCHEDULE OF REFERENCED DOCUMENTS

| No. | Date | Title | BCA clause(s) |
|--|----------|--|---------------|
| AS 2626 | 1983 | Industrial safety belts and harness — Selection, use and maintenance | Qld G101.1 |
| BCA 2009 | May 2009 | Building Code of Australia | Qld Section J |
| Queensland Forest Service of the Department of Primary Industries Construction timbers in Queensland - Properties and specifications for satisfactory performance of construction timbers in Queensland - Class 1 and 10 buildings (Houses, carports, garages, greenhouses and sheds). | | | Qld B1.4 |

SECTION B STRUCTURE

PART B1 STRUCTURAL PROVISIONS

After B1.4(f)(iii) insert Qld B1.4(f)(iv) as follows:

Qld B1.4 Determination of structural resistance of materials and forms of construction

- (f) Timber Construction:
- (iv) Timber used for structural purposes: a species scheduled for the appropriate use in Schedules A, B or C in Queensland Forest Service of the Department of Primary Industries Construction timbers in Queensland - Properties and specifications for satisfactory performance of construction timbers in Queensland - Class 1 and 10 buildings (Houses, carports, garages, greenhouses and sheds).

SECTION G ANCILLARY PROVISIONS

PART G1 MINOR STRUCTURES AND COMPONENTS

Delete GO1(c) and insert Qld GO1(c) as follows:

OBJECTIVE

Qld GO1

(c) * * * * *

Delete GF1.2(a) and insert Qld GF1.2(a) as follows:

FUNCTIONAL STATEMENTS

Qld GF1.2

A *swimming pool* is to be provided with—

(a) * * * * *

Delete GP1.2(a) and insert Qld GP1.2(a) as follows:

PERFORMANCE REQUIREMENTS

Qld GP1.2

(a) * * * * *

Delete G1.1(a) and (b) and insert Qld G1.1(a) and (b) as follows:

Qld G1.1 Swimming pools

(a) * * * * *

(b) * * * * *

Note:
Barriers and fences for *swimming pools* are regulated by the Building Act 1975 and the Building Regulation 2006.

QLD PART G5 CONSTRUCTION IN BUSHFIRE PRONE AREAS

Delete GO5 and insert Qld GO5 as follows:

OBJECTIVE

Qld GO5

The *Objective* of this Part is to—

- (a) safeguard occupants from injury; and
- (b) protect buildings,
from the effects of a bushfire.

Application

Qld GO5 only applies to—

- (a) a Class 2 or 3 building; or
- (b) a Class 10a building or deck associated with a Class 2 or 3 building,

located in a *designated bushfire prone area*, but does not apply when the classified vegetation is Group F rainforest (excluding wet sclerophyll forest types), mangrove communities and grasslands under 300 mm high.

Delete GF5.1 and insert Qld GF5.1 as follows:

FUNCTIONAL STATEMENT

Qld GF5.1

A building constructed in a *designated bushfire prone area* is to provide a resistance to bushfires in order to reduce the danger to life and minimise the risk of the loss of the building.

Application

Qld GF5.1 only applies to—

- (a) a Class 2 or 3 building; or
- (b) a Class 10a building or deck associated with a Class 2 or 3 building,

located in a *designated bushfire prone area*, but does not apply when the classified vegetation is Group F rainforest (excluding wet sclerophyll forest types), mangrove communities and grasslands under 300 mm high.

Delete GP5.1 and insert Qld GP5.1 as follows:

PERFORMANCE REQUIREMENT

Qld GP5.1

A building that is constructed in a *designated bushfire prone area* must be designed and constructed to reduce the risk of ignition from a bushfire while the fire front passes.

Application

Qld GP5.1 only applies to—

- (a) a Class 2 or 3 building; or
- (b) a Class 10a building or deck associated with a Class 2 or 3 building,

located in a *designated bushfire prone area*, but does not apply when the classified vegetation is Group F rainforest (excluding wet sclerophyll forest types), mangrove communities and grasslands under 300 mm high.

Delete G5.1 and insert Qld G5.1 as follows:

DEEMED-TO-SATISFY PROVISIONS

Qld G5.1

The *Deemed-to-Satisfy Provisions* of this Part apply to—

- (a) a Class 2 or 3 building; or
- (b) a Class 10a building or deck associated with a Class 2 or 3 building,

located in a *designated bushfire prone area*, but does not apply when the classified vegetation is Group F rainforest (excluding wet sclerophyll forest types), mangrove communities and grasslands under 300 mm high.

Add Qld Part G101 as follows:

QLD PART G101 CERTAIN ATTACHMENTS

Qld G101.1 Prevention of falls from buildings or structures

Where a person is exposed to the hazard of falling from a building or structure while cleaning or maintenance work is being carried out—

- (a) a work system designed to prevent such falls must be used; and
- (b) where safety belt anchorage points are used they must be positioned on the building or structure so that a lifeline or safety harness may be attached before proceeding to a point where it is possible to fall; and
- (c) anchorage points for the attachment of safety harnesses must comply with AS 2626.

Insert SECTION J ENERGY EFFICIENCY

SECTION J ENERGY EFFICIENCY

Insert the following:

In Queensland, for a Class 2 building, **Section J** is replaced with **Section J** of BCA 2009.

Footnote: OTHER LEGISLATION AFFECTING BUILDINGS

All legislative technical requirements affecting the design, construction and/or performance of buildings are consolidated into the Building Act 1975 and other legislative instruments under that Act, such as regulations, codes (including this Code) and standards.

SOUTH AUSTRALIA

INTRODUCTION

This Appendix contains variations and additions to the BCA provisions which are considered necessary for the effective application of the Code in South Australia.

These variations and additions are to be treated as amendments to the BCA and apply to the construction or alteration of all buildings requiring approval under the Development Act 1993 and Regulations 2008.

APPENDIX CONTENTS

APPENDIX SOUTH AUSTRALIA

INTRODUCTION

A GENERAL PROVISIONS

SA A1.1 Definitions
SA Specification A1.3 Standards Adopted by Reference
SA A2.2 * * * * *

C FIRE RESISTANCE

SA C1.1 Type of construction required
SA C2.15 Class 2 external walls exposed to brush fences

D ACCESS AND EGRESS

SA D3.1 General building access requirements
SA Table D3.1a Additional requirements for access for people with a disability

F HEALTH AND AMENITY

SA FP1.5, SA FP1.6 and SA FP1.8 Performance Requirements
SA F1.0 Deemed-to-Satisfy Provisions
SA F1.7 Waterproofing of wet areas in buildings
SA F1.9 Damp-proofing
SA F1.10 Damp-proofing of floors on the ground
SA F1.11 Provision of floor wastes
SA F2.4 Accessible sanitary facilities
SA Table F2.4(a)(i) Additional accessible unisex sanitary compartments
SA Table F2.4(b)(i) Additional accessible unisex showers

G ANCILLARY PROVISIONS

SA GO1 Objective
SA GF1.2 Functional Statement
SA GP1.2 Performance Requirements
SA G5.1 Application of Part
SA G5.2 Bushfire attack levels
SA G5.3 Construction requirements

SA Part G7 ACCESS FOR MAINTENANCE

SA GO7 Objective
SA GF7.1 and SA GF7.2 Functional Statements
SA GP7.1 and SA GP7.2 Performance Requirements
SA G7.0 Deemed-to-Satisfy Provisions
SA G7.1 Application of Part
SA G7.2 Access for window cleaning

SA G7.3 Access for inspection and maintenance between buildings

SA Part G8 MISCELLANEOUS PROVISIONS

SA G08 Objective
SA GF8.1 Functional Statement
SA GP8.1 Performance Requirement
SA G8.0 Deemed-to-Satisfy Provisions
SA G8.1 Application of Part
SA G8.2 Attachments to buildings

H SPECIAL USE BUILDINGS

SA Part H2 BULK GRAIN STORAGE FACILITIES

SA H2.1 Application of Part
SA H2.2 Concessions for bulk grain storage facilities

SA Part H3 FARM BUILDINGS

SA H3.1 Application of Part
SA H3.2 Concessions and additions for farm buildings

I MAINTENANCE

SA I1.1 Safety installations
SA I1.2 Mechanical ventilation and hot water, warm water and cooling water systems

J ENERGY EFFICIENCY

SA JP4 Performance Requirement
SA JV4 Verification Method

SA PART J1 BUILDING FABRIC

SA J1.3 Roof and ceiling construction

SA PART J7 HOT WATER SUPPLY AND SWIMMING POOL AND SPA POOL PLANT

SA J7.0 Deemed-to-Satisfy Provisions
SA J7.2 Hot water supply
SA J7.5 Complying heated water services

Footnote: Other Legislation Affecting Buildings

SECTION A GENERAL PROVISIONS

PART A1 INTERPRETATION

SA A1.1 Definitions

Insert definition for *brush fence* as follows:

Brush fence means a fence or gate that is primarily constructed of Broombrush (*Melaluca Uncinata*).

Insert definition for *rated hot water delivery* as follows:

Rated hot water delivery means rated hot water delivery as specified in AS 1056.

Insert definition for *Small-scale Technology Certificate* as follows:

Small-scale Technology Certificate means a certificate issued under the Commonwealth Government's Small-scale Renewable Energy Scheme.

Insert in Table 1 of Specification A1.3 additional standards as follows:

SA Specification A1.3 STANDARDS ADOPTED BY REFERENCE

SA Table 1 SCHEDULE OF REFERENCED DOCUMENTS

| No | Date | Title | BCA clause(s) |
|----------------------------------|------|---|----------------|
| AS 1056 | | Storage water heaters | |
| Part 1 | 1991 | General requirements | SA A1.1 |
| AS 1530.8 | | Test on elements of construction for buildings exposed to simulated bushfire attack | |
| Part 1 | 2007 | Radiant heat and small flaming sources | SA G5.3 |
| Part 2 | 2007 | Large flaming sources | SA G5.3 |
| AS/NZS 1891 | | Industrial fall-arrest systems and devices | |
| Part 4 | 2000 | Selection, use and maintenance | SA G7.2 |
| AS/NZS 4234 | 2008 | Heated water systems — Calculation of energy consumption | SA JV4 |
| AS 4552 | 2005 | Gas fired heaters for hot water supply and/or central heating | SA J7.5 |
| Minister's Specifications | | | |
| SA F1.7 | 2012 | Waterproofing in buildings — Additional requirements | SA F1.7 |
| SA H2.2 | 1997 | Construction of bulk grain storage facilities | SA H2.2 |
| SA H3.2 | 2004 | Concessions and additional requirements for farm buildings | SA H3.2 |

SA Table 1 SCHEDULE OF REFERENCED DOCUMENTS— continued

| No | Date | Title | BCA clause(s) |
|------------------------|------|--|------------------|
| SA 76 | 2000 | Maintenance and testing of safety installations. Schedule of essential safety provisions | SA I1.1, SA I1.2 |
| Waterworks Regulations | 1996 | | SA J7.2 |

PART A2 ACCEPTANCE OF DESIGN AND CONSTRUCTION

SA A2.2 * * * * *

This clause has been deliberately left blank.

SECTION C FIRE RESISTANCE

PART C1 FIRE RESISTANCE AND STABILITY

After C1.1(a)(iv) add SA C1.1(a)(v), and after C1.1(b) add SA C1.1(c) and (d) as follows:

SA C1.1 Type of construction required

- (a) The minimum Type of *fire-resisting construction* of a building must be that specified in **Table C1.1** and **Specification C1.1**, except as allowed for—
 - (v) Class 2 buildings located within 3 m of a *brush fence* and Class 10b *brush fences* located within 3 m of a Class 2 building in **C1.1(c)** and **(d)**.
- (c) In addition to the minimum *fire-resisting construction* requirements of **Table C1.1** and **Specification C1.1** a Class 2 buildings must not be constructed within 3 m of a Class 10b *brush fence* unless any part of the building within 3 m of the *brush fence* complies with the *fire resisting* requirements of **SA C2.15**.
- (d) A Class 10b *brush fence* must not be constructed within 3 m of a Class 2 building unless any part of the building within 3 m of the *brush fence* complies with the *fire resisting* requirements of **SA C2.15**.

PART C2 COMPARTMENTATION AND SEPARATION

After C2.14 add SA C2.15 as follows:

SA C2.15 Class 2 external walls exposed to brush fences

Where the distance between the *external wall* of a Class 2 building and a *brush fence* is less than 3 m, the Class 2 building must comply with the following:

- (a) An *external wall* or part of an *external wall* exposed to the *brush fence* must be *fire resisting* and extend to the underside of a *non-combustible* roof covering or a *non-combustible* eaves lining or to a point at which exposure to the *brush fence* no longer exists and must—
 - (i) have a FRL of at least 60/60/60 when tested from the outside; or

- (ii) be of masonry veneer construction in which the external masonry veneer is not less than 90 mm thick; or
 - (iii) be of masonry construction not less than 90 mm thick; and
 - (iv) have any exposed openings protected in accordance with **C3.4**.
- (b) Where an *external wall* is *required* by (a) to be *fire resisting*, only that part of the wall, including openings within the specified distance, need to be constructed in that manner.
- (c) The requirements of (a) do not apply to sub-floor vents, roof vents, weepholes, control joints, construction joints and penetrations for pipes, conduits and the like.
- (d) The following are permitted to encroach within 3 m of a *brush fence*—
- (i) *non-combustible* fascias, gutters, downpipes; and
 - (ii) eaves with *non-combustible* roof cladding and *non-combustible* lining; and
 - (iii) flues, chimneys, pipes, domestic fuel tanks, cooling or heating appliances or other services; and
 - (iv) light fittings, electricity or gas meters, aerials or antennas; and
 - (v) pergolas, sun blinds or water tanks; and
 - (vi) unroofed terraces, landings, steps and ramps, not more than 1 m in height.
- (e) The distance from any point on an *external wall* of a building to a *brush fence* is measured in any direction from the *external wall*.

SECTION D ACCESS AND EGRESS

PART D3 ACCESS FOR PEOPLE WITH A DISABILITY

Delete D3.1 and substitute:

SA D3.1 General building access requirements

Buildings and parts of buildings must be *accessible* as *required* by **Table D3.1** and **SA Table D3.1a**, unless exempt by **D3.4**.

SA Table D3.1a ADDITIONAL REQUIREMENTS FOR ACCESS FOR PEOPLE WITH A DISABILITY

| Class of building | Access requirements |
|--|--|
| Class 2 | |
| In developments consisting of 20 or more residential <i>sole-occupancy units</i> | To and within one residential <i>sole-occupancy unit</i> or 5% of the total number of residential <i>sole-occupancy units</i> provided, whichever is the greater |

SECTION F HEALTH AND AMENITY

PART F1 DAMP AND WEATHERPROOFING

Delete FP1.5 and add SA FP1.5 as follows:

| |
|---------------------------------|
| PERFORMANCE REQUIREMENTS |
|---------------------------------|

SA FP1.5

- (a) Moisture from the ground must be prevented from causing—
 - (i) undue dampness or deterioration of building elements; and
 - (ii) unhealthy or dangerous conditions, or loss of amenity for occupants.
- (b) Barriers installed to prevent transfer of moisture from the ground must have—
 - (i) high resistance to moisture penetration; and
 - (ii) high resistance to damage during construction; and
 - (iii) high resistance to degradation by dissolved salts.

Delete FP1.6 add SA FP1.6 as follows:

SA FP1.6

Accidental water overflow from a bathroom, laundry facility or the like must be prevented from penetrating to adjoining rooms or spaces.

After FP1.7 add SA FP1.8 as follows:

SA FP1.8

In laundries, bathrooms or rooms containing shower facilities the floors must be installed in a manner that will prevent accumulation of surface water which could create unhealthy or hazardous conditions.

Delete F1.0(b) and add SA F1.0(b) as follows:

SA F1.0 Deemed-to-Satisfy Provisions

- (b) With the exception of (a), *Performance Requirements* **FP1.1** to **FP1.4**, **SA FP1.5**, **SA FP1.6**, **FP1.7** and **SA FP1.8** are satisfied by complying with **F1.1** to **F1.6**, **SA F1.7**, **SA F1.9** to **SA F1.11**, **F1.12** and **F1.13**.

Delete F1.7 and insert SA F1.7 as follows:

SA F1.7 Waterproofing of wet areas in buildings

- (a) In a Class 2 and 3 building and a Class 4 part of building, building elements in *wet areas* must—
 - (i) be *water resistant* or *waterproof* in accordance with **Table F1.7**; and
 - (ii) comply with AS 3740; and
 - (iii) comply with the additional requirements of Minister's Specification SA F1.7.
- (b) In a Class 5, 6, 7, 8 or 9 building, building elements in the bathroom or shower room, a slop hopper or sink compartment, a laundry or *sanitary compartment* must—
 - (i) be *water resistant* or *waterproof* in accordance with **Table F1.7**; and
 - (ii) comply with AS 3740; and

- (iii) comply with the additional requirements of Minister's Specification SA F1.7.

Delete F1.9(b) and insert SA F1.9(b) as follows:

SA F1.9 Damp-proofing

- (b) Damp-proof courses must exhibit long term resistance to degradation by dissolved salts in groundwater and consist of—
- (i) embossed black polyethylene film meeting the requirements of clause 7.6 of AS/NZS 2904; or
 - (ii) polyethylene coated aluminium meeting the requirements of clause 7.4 of AS/NZS 2904; or
 - (iii) bitumen impregnated materials of not less than 2.5 mm thickness, meeting the requirements of clause 7.5 of AS/NZS 2904, when used in walls not higher than 7.8 m above the level of the damp-proof course.

Delete F1.10 and insert SA F1.10 as follows:

SA F1.10 Damp-proofing of floors on the ground

- (a) If a floor of a room is laid on the ground or on fill, a damp-proofing membrane complying with Section 5.3.3 of AS 2870 must be installed.
- (b) A damp-proofing membrane need not be provided if—
- (i) weatherproofing is not *required*; or
 - (ii) the floor is the base of a stair, lift or similar *shaft* which is adequately drained by gravitation or mechanical means.

Delete F1.11 and insert SA F1.11 as follows:

SA F1.11 Provision of floor wastes

- (a) Floors in the following rooms or areas must be graded to a floor waste:
- (i) A bathroom.
 - (ii) Areas adjacent to baths and spas (including the floor area under a free standing bath).
 - (iii) A room containing a *vessel*.
- (b) Floors need not be graded to a floor waste in accordance with (a) if all *vessels*—
- (i) are provided with in-built overflow protection; or
 - (ii) have permanent open trapped connection to the waste system.
- (c) The fall of the floor surface to a floor waste *required* by (a) must be—
- (i) between 1:60 and 1:80 in the *shower area*; and
 - (ii) between 1:80 and 1:100 in other areas.

PART F2 SANITARY AND OTHER FACILITIES

Delete F2.4(a) to F2.4(b) and insert SA F2.4(a) to SA F2.4(b) as follows:

SA F2.4 Accessible sanitary facilities

- (a) *accessible* unisex *sanitary compartments* must be provided in *accessible* parts of the building in accordance with **Table F2.4(a)** and **SA Table F2.4(a)(i)**; and

SA Table F2.4(a)(i) ADDITIONAL ACCESSIBLE UNISEX SANITARY COMPARTMENTS

| Class of building | Minimum facility for use by people with a disability |
|---|--|
| Class 2 In every <i>sole-occupancy unit required</i> by SA Table D3.1a to be <i>accessible</i> | Not less than 1 |

- (b) *accessible* unisex showers must be provided in accordance with **Table F2.4(b)** and **SA Table F2.4(b)(i)**; and

SA Table F2.4(b)(i) ADDITIONAL ACCESSIBLE UNISEX SHOWERS

| Class of building | Minimum facility for use by people with a disability |
|---|--|
| Class 2 In every <i>sole-occupancy unit required</i> by SA Table D3.1a to be <i>accessible</i> | Not less than 1 |

SECTION G ANCILLARY PROVISIONS

PART G1 MINOR STRUCTURES AND COMPONENTS

Delete GO1(c) and insert SA GO1(c) as follows:

OBJECTIVE

SA GO1

- (c) safeguard young children from drowning or injury in a *swimming pool*; and

Application:

SA GO1(c) only applies to a *swimming pool* associated with a Class 2 or 3 building or Class 4 part of a building, with a depth of water more than 300 mm.

Delete GF1.2(a) and insert SA GF1.2(a) as follows:

FUNCTIONAL STATEMENT

SA GF1.2

A *swimming pool* is to be provided with—

- (a) means of restricting access by young children to it; and

Application:

SA GF1.2(a) only applies to a *swimming pool* associated with a Class 2 or 3 building or Class 4 part of a building, with a depth of water more than 300 mm.

Delete GP1.2(a) and insert SA GP1.2(a) as follows:

PERFORMANCE REQUIREMENTS

SA GP1.2

- (a) A barrier must be provided to a *swimming pool* and must—
- (i) be continuous for the full extent of the hazard; and
 - (ii) be of a strength and rigidity to withstand the foreseeable impact of people; and
 - (iii) restrict the access of young children to the pool and the immediate pool surrounds; and
 - (iv) have any gates and doors fitted with latching devices not readily operated by young children, and constructed to automatically close and latch.

Application:

SA GP1.2(a) only applies to a *swimming pool* associated with a Class 2 or 3 building or Class 4 part of a building, with a depth of water more than 300 mm.

SA PART G5 CONSTRUCTION IN BUSHFIRE PRONE AREAS

Delete G5.1 and insert SA G5.1:

SA G5.1 Application of Part

The *Deemed-to-Satisfy Provisions* of this Part apply to—

- (a) a Class 2 or 3 building; or
- (b) a Class 10a building or deck located within 6 m of an associated Class 2 or 3 building that is *required* to comply with this Part,

located in a *designated bushfire prone area*.

Delete G5.2 and insert SA G5.2

SA G5.2 Bushfire attack levels

Where a *site* is located in a *designated bushfire prone area*, the bushfire attack level that applies to the *site* is—

- (a) for areas identified as General Bushfire Risk areas in South Australian Development Plans, the BAL — Low bushfire attack level; and
- (b) for areas identified as Medium Bushfire Risk areas in South Australian Development Plans, the BAL — 12.5 bushfire attack level; and
- (c) for areas identified as High Bushfire Risk areas in South Australian Development Plans, the bushfire attack level assessed for the *site* in accordance with AS 3959; and
- (d) for Excluded Areas within 500 m of a High Bushfire Risk area, as identified in South Australian Development Plans, the BAL — Low bushfire attack level; and
- (e) for Excluded Areas within 100 m of a High Bushfire Risk area, as identified in South Australian Development Plans, the bushfire attack level assessed for the site in accordance with AS 3959.

Add SA G5.3 as follows:

SA G5.3 Construction requirements

- (a) A Class 2 or 3 building, or a Class 10a building or deck *required* to comply with this Part, must be constructed in accordance with **SA Table G5.1** for the bushfire attack level for the *site*.
- (b) A Class 10a building or deck is not *required* to comply with **SA G5.3(a)** if it is separated from a Class 2 or 3 building by—
 - (i) for a Class 10a building or deck attached to or sharing a common roof space with a Class 2 or 3 building, a wall that extends from the footings or concrete slab to the underside of a *non-combustible* roof covering and complies with one of the following:
 - (A) The wall has an FRL of not less than 60/60/60 for *loadbearing* walls, and -/60/60 for non-*loadbearing* walls when tested from the Class 10 side; or
 - (B) The wall is of masonry, earth wall or masonry-veneer construction where the masonry leaf is not less than 90 mm in thickness.
 - (ii) for a Class 10a building or deck located below a Class 2 or 3 building, separating floor and/or wall construction that complies with one of the following:
 - (A) The floor and/or wall has an FRL of not less than 60/60/60 for *loadbearing* construction, and -/60/60 for non-*loadbearing* construction when tested from the Class 10 side; or
 - (B) Where part or all of the separating construction is a wall, the wall need not comply with **(A)** if it complies with **SA G5.3(b)(i)(B)**.
 - (iii) for a Class 10a building or deck located within 6 m of a Class 2 or 3 building, comply with **SA G5.3(b)(i)**.
- (c) Openings in separating construction referred to in **SA G5.3(b)(i)** and **(ii)** must comply with the following:
 - (i) Doorways must be protected by -/60/30 *self-closing* fire doors.

- (ii) *Windows* must be protected by -/60/- fire *windows* permanently fixed in the closed position.
- (iii) Other openings (excluding control and construction joints, sub-floor vents, weepholes and penetrations for pipes and conduits) must be protected by construction with an FRL of not less than -/60/-.
- (d) For the purposes of **SA Table G5.1** bushfire-resisting timber is timber that is in solid, laminated or reconstituted form that meets the criteria specified in Appendix F of AS 3959.
- (e) Where any material, element of construction or system satisfies the test criteria of either AS 1530.8.1, for BAL — 12.5, BAL — 19, BAL — 29 and BAL — 40 and AS 1530.8.2 for BAL — FZ it satisfies the requirements of that BAL.
- (f) If any material, element of construction or system satisfies the test criteria without screening for ember protection, the requirements for screening of openable parts of *windows* must still apply.
- (g) Polycarbonate may be used as roof sheeting for Class 10a buildings located within 6 m of a Class 2 or 3 building for BAL – Low, BAL – 12.5, BAL – 19 and BAL – 29 *sites*.

SA TABLE G5.1 CONSTRUCTION REQUIREMENTS FOR BAL — LOW, BAL — 12.5, BAL — 19, BAL — 29, BAL — 40 and BAL – FZ SITES

| FLOOR SYSTEMS | |
|---|---|
| 1. | BAL — Low |
| A flooring system must comply with one or a combination of the following: | |
| (a) | A concrete slab-on-ground. |
| (b) | A suspended concrete floor. |
| (c) | A framed floor where, if the underside is greater than 600 mm above finished ground or paving level, the sub-floor space is enclosed with— |
| (i) | a <i>non-combustible</i> sheet material. If fibre reinforced cement sheets are used for this purpose, the sheets must have a minimum thickness of 6 mm; or |
| (ii) | a wall that extends around the perimeter of the floor from the underside of the lowest framing member to finished ground or paving level and is constructed in accordance with clauses 7.4.1 and 7.4.2 of the BAL — 29 requirements of AS 3959. <i>Sarking-type material</i> must have a <i>Flammability Index</i> of not more than 5; or |
| (iii) | a vertical <i>non-combustible</i> sheet material that extends around the perimeter of the floor from the underside of the lowest framing member to finished ground or paving level. If fibre reinforced cement sheets are used for this purpose, the sheets must have a minimum thickness of 6 mm. |
| (d) | A framed floor where, if any joist and/or bearer is less than 600 mm above finished ground or paving level, the sub-floor space is— |
| (i) | if unenclosed, constructed from flooring materials, including bearers, joists and flooring that comply with clause 7.3.2.2 (a) and (b) of the BAL — 29 requirements of AS 3959; or |
| (ii) | enclosed with a wall complying with (c)(ii); or |

SA TABLE G5.1 CONSTRUCTION REQUIREMENTS FOR BAL — LOW, BAL — 12.5, BAL — 19, BAL — 29, BAL — 40 and BAL — FZ SITES— continued

| | |
|--|---|
| | <p>(iii) enclosed with <i>non-combustible</i> sheet material that extends not less than 400 mm above finished ground or paving level and to the bottom of the wall sheeting material. If fibre reinforced cement sheets are used for this purpose, the sheets must have a minimum thickness of 6 mm.</p> <p>A flooring system complying with (c) or (d)(ii) or (iii) must have all of the joints in the external surface of walls covered, sealed, overlapped, backed or butt-jointed to prevent gaps greater than 3 mm. Alternatively, <i>sarking-type material</i> can be applied over the frame prior to fixing any external sheeting.</p> |
| 2. | BAL — 12.5 |
| | <p>As per BAL — Low requirements of this table, with the following variation—</p> <p>(a) Aluminium mesh or aluminium perforated sheet must not be used to enclose a subfloor space.</p> |
| 3. | BAL — 19 |
| | <p>As per BAL — Low requirements of this table, with the following variation—</p> <p>(a) Aluminium mesh or aluminium perforated sheet must not be used to enclose a subfloor space.</p> |
| 4. | BAL — 29 |
| | <p>As per BAL — Low requirements of this table, with the following variation—</p> <p>(a) Aluminium mesh or aluminium perforated sheet must not be used to enclose a subfloor space.</p> |
| 5. | BAL — 40 |
| | <p>A flooring system must comply with clause 8.3 of the BAL — 40 requirements of AS 3959 with the following variation—</p> <p>(a) Where a wall is used to enclose the sub-floor space, any <i>required sarking-type material</i> must have a <i>Flammability Index</i> of not more than 5.</p> <p>(b) The sub-floor space of a framed floor must not be enclosed with mesh or perforated sheet made from corrosion-resistant steel, bronze or aluminium.</p> |
| 6. | BAL — FZ |
| | <p>A flooring system must comply with clause 9.3 of the BAL — FZ requirements of AS 3959 with the following variation—</p> <p>(a) Where a wall is used to enclose the sub-floor space, any <i>required sarking-type material</i> must have a <i>Flammability Index</i> of not more than 5.</p> <p>(b) The sub-floor space of a framed floor must not be enclosed with mesh or perforated sheet made from corrosion-resistant steel, bronze or aluminium.</p> |
| SUPPORTING POSTS, COLUMNS, STUMPS, PIERS AND POLES (except in sub-floor spaces enclosed by aluminium mesh or aluminium perforated sheet as described in FLOORING SYSTEMS 1 BAL Low (d)) | |
| 1. | BAL — Low |
| | <p>Supporting posts, columns, stumps piers and poles must comply with one or a combination of the following:</p> |

SA TABLE G5.1 CONSTRUCTION REQUIREMENTS FOR BAL — LOW, BAL — 12.5, BAL — 19, BAL — 29, BAL — 40 and BAL — FZ SITES— continued

| | |
|---|---|
| (a) | A <i>non-combustible</i> material. |
| (b) | Bushfire-resisting timber for not less than 400 mm above finished ground or paving level. |
| (c) | Timber mounted on metal stirrups with a clearance of not less than 75 mm above finished ground or paving level. |
| 2. BAL — 12.5 | |
| As per BAL — Low requirements in this table. | |
| 3. BAL — 19 | |
| As per BAL — Low requirements in this table. | |
| 4. BAL — 29 | |
| Supporting posts, columns, stumps, piers and poles must comply with clause 7.2 of the BAL — 29 requirements of AS 3959. | |
| 5. BAL — 40 | |
| Supporting posts, columns, stumps, piers and poles must comply with clause 8.2 of the BAL — 40 requirements of AS 3959. | |
| 6. BAL — FZ | |
| Supporting posts, columns, stumps, piers and poles must comply with clause 9.2 of the BAL — FZ requirements of AS 3959. | |
| EXTERNAL WALLS | |
| 1. BAL — Low | |
| No requirements. | |
| 2. BAL — 12.5 | |
| The exposed components of <i>external walls</i> must comply with one or a combination of the following: | |
| (a) | Clauses 7.4.1(a) and 7.4.2 of the BAL — 29 requirements of AS 3959 and any <i>sarking-type material</i> must have a <i>Flammability Index</i> of not more than 5. |
| (b) | A timber or steel-framed wall that— |
| (i) | is sarked on the outside of the frame with <i>sarking-type material</i> having a <i>Flammability Index</i> of not more than 5; and |
| (ii) | complies with clauses 5.4.1 and 5.4.2 of the BAL — 12.5 requirements of AS 3959. |
| 3. BAL — 19 | |
| The exposed components of <i>external walls</i> must comply with one or a combination of the following: | |
| (a) | Clauses 7.4.1(a) and 7.4.2 of the BAL — 29 requirements of AS 3959 and any <i>sarking-type material</i> must have a <i>Flammability Index</i> of not more than 5. |
| (b) | A timber or steel-framed wall that— |

SA TABLE G5.1 CONSTRUCTION REQUIREMENTS FOR BAL — LOW, BAL — 12.5, BAL — 19, BAL — 29, BAL — 40 and BAL — FZ SITES— continued

| | |
|----------------|--|
| | <ul style="list-style-type: none"> (i) is sarked on the outside of the frame with <i>sarking-type material</i> having a <i>Flammability Index</i> of not more than 5; and (ii) complies with clauses 6.4.1 and 6.4.2 of the BAL — 19 requirements of AS 3959. |
| 4. | BAL — 29 |
| | The exposed components of <i>external walls</i> must comply with clauses 7.4.1 and 7.4.2 of the BAL — 29 requirements of AS 3959 and any <i>sarking-type material</i> must have a <i>Flammability Index</i> of not more than 5. |
| 5. | BAL — 40 |
| | The exposed components of <i>external walls</i> must comply with clauses 8.4.1 and 8.4.2 of the BAL — 40 requirements of AS 3959 and any <i>sarking-type material</i> must have a <i>Flammability Index</i> of not more than 5. |
| 6. | BAL — FZ |
| | The exposed components of <i>external walls</i> must comply with clauses 9.4.1 and 9.4.2 of the BAL — FZ requirements of AS 3959 and any <i>sarking-type material</i> must have a <i>Flammability Index</i> of not more than 5. |
| WINDOWS | |
| 1. | BAL — Low |
| | No requirements. |
| 2. | BAL — 12.5 |
| | <i>Window</i> assemblies, and shutters and screens where fitted, must comply with clauses 5.5.1, 5.5.1A and 5.5.2 of the BAL — 12.5 requirements of AS 3959. |
| 3. | BAL — 19 |
| | <i>Window</i> assemblies, and shutters and screens where fitted, must comply with clauses 6.5.1, 6.5.1A and 6.5.2 of the BAL — 19 requirements of AS 3959 with the following variations: |
| | <ul style="list-style-type: none"> (a) Aluminium mesh must not be used in the <i>window</i> screens. (b) Where leadlight <i>windows</i> are installed they must be protected by <i>non-combustible</i> shutters or toughened glass. (c) Where timber is used, it must be bushfire-resisting timber. |
| 4. | BAL — 29 |
| | <i>Window</i> assemblies, and shutters and screens where fitted, must comply with clauses 7.5.1, 7.5.1A and 7.5.2(a) or (b)(i), (ii), (iii) and (v) of the BAL — 29 requirements of AS 3959 with the following variation: |
| | <ul style="list-style-type: none"> (a) Aluminium mesh must not be used in the <i>window</i> screens. |
| 5. | BAL — 40 |
| | <i>Window</i> assemblies, and shutters and screens where fitted, must comply with clauses 8.5.1, 8.5.1A and 8.5.2 of the BAL — 40 requirements of AS 3959. |
| 6. | BAL — FZ |

SA TABLE G5.1 CONSTRUCTION REQUIREMENTS FOR BAL — LOW, BAL — 12.5, BAL — 19, BAL — 29, BAL — 40 and BAL — FZ SITES— continued

Window assemblies, and shutters and screens where fitted, must comply with clauses 9.5.1, 9.5.1A and 9.5.2 of the BAL — FZ requirements of AS 3959.

EXTERNAL DOORS

(including side-hung external doors such as French doors, panel fold and bi-fold doors, sliding doors and garage doors)

1. BAL — Low

No requirements.

2. BAL — 12.5

Doors and door frames, and shutters and screens, where fitted must comply with clauses 5.5.1, 5.5.1A and 5.5.3, 5.5.4 and 5.5.5 of the BAL — 12.5 requirements of AS 3959.

3. BAL — 19

Doors and door frames, and shutters and screens where fitted, must comply with clauses 6.5.1, 6.5.1A and 6.5.3, 6.5.4 and 6.5.5 of the BAL — 19 requirements of AS 3959, with the following variation:

(a) Aluminium mesh must not be used in the door screens.

4. BAL — 29

Doors and door frames, and shutters and screens where fitted, must comply with clauses 7.5.1, 7.5.1A and 7.5.3(a) or (b) or (c)(i)(A), (C) or (D), (ii), (iii), (iv), (v), (vi) and (vii), 7.5.4 and 7.5.5 of the BAL — 29 requirements of AS 3959, with the following variations:

(a) Aluminium mesh must not be used in the door screens.

(b) If shutters are used for side-hung or sliding doors, they must be *non-combustible*.

(c) Side-hung doors must be solid-core with a minimum thickness of 35 mm.

5. BAL — 40

Doors and door frames, and shutters and screens where fitted, must comply with clauses 8.5.1, 8.5.1A and 8.5.3(a) or (b)(i)(A), (ii), (iii), (v), (vii) and (viii), 8.5.4 and 8.5.5 of the BAL — 40 requirements of AS 3959.

6. BAL — FZ

Doors and door frames, and shutters and screens where fitted, must comply with clauses 9.5.1, 9.5.1A and 9.5.3, 9.5.4 and 9.5.5 of the BAL — FZ requirements of AS 3959.

VENTS AND WEEPHOLES

(including vents and weepholes located in *external walls* and sub-floor spaces)

1. BAL — Low

Vents to sub-floor spaces and weepholes must be fitted with ember guards made from corrosion-resistant steel, bronze or aluminium mesh or perforated sheet with a maximum aperture size of 2 mm.

2. BAL — 12.5

As per the BAL — Low requirements of this table.

3. BAL — 19

SA TABLE G5.1 CONSTRUCTION REQUIREMENTS FOR BAL — LOW, BAL — 12.5, BAL — 19, BAL — 29, BAL — 40 and BAL — FZ SITES— continued

| |
|--|
| As per the BAL — Low requirements of this table with the following variation: (a) Aluminium mesh or aluminium perforated sheet must not be used for the ember guards. |
| 4. BAL — 29 |
| As per the BAL — 19 requirements of this table. |
| 5. BAL — 40 |
| As per the BAL — 19 requirements of this table. |
| 6. BAL — FZ |
| As per the BAL — 19 requirements of this table. |
| ROOFS (including verandahs and attached carport roofs, eaves linings, fascias, gables) |
| 1. BAL — Low |
| No requirements. |
| 2. BAL — 12.5 |
| Roofs must comply with clauses 5.6.1, 5.6.2, 5.6.3, 5.6.4 and 5.6.6 of the BAL — 12.5 requirements of AS 3959 with the following variations: (a) Aluminium mesh or aluminium perforated sheet must not be used for screening purposes. (b) Any <i>sarking-type material</i> must have a <i>Flammability Index</i> of not more than 5. |
| 3. BAL — 19 |
| Roofs must comply with clauses 6.6.1, 6.6.2, 6.6.3, 6.6.4 and 6.6.6 of the BAL — 19 requirements of AS 3959 with the following variations: (a) Aluminium mesh or aluminium perforated sheet must not be used for screening purposes. (b) Any <i>sarking-type material</i> must have a <i>Flammability Index</i> of not more than 5. (c) Fascias and bargeboards must be— (i) <i>non-combustible</i> ; or (ii) bushfire-resisting timber; or (iii) a combination of (i) and (ii). (d) Timber eaves linings and joining strips in linings, fascias and gables must be of bushfire-resisting timber. |
| 4. BAL — 29 |
| Roofs must comply with clauses 7.6.1, 7.6.2, 7.6.3, 7.6.4 and 7.6.6 of the BAL — 29 requirements of AS 3959 with the following variations: (a) Aluminium mesh or aluminium perforated sheet must not be used for screening purposes. (b) Any <i>sarking-type material</i> must have a <i>Flammability Index</i> of not more than 5. |

SA TABLE G5.1 CONSTRUCTION REQUIREMENTS FOR BAL — LOW, BAL — 12.5, BAL — 19, BAL — 29, BAL — 40 and BAL — FZ SITES— continued

| |
|--|
| <p>(c) Fascias and bargeboards must be—</p> <ul style="list-style-type: none"> (i) <i>non-combustible</i>; or (ii) bushfire-resisting timber; or (iii) a combination of (i) and (ii). <p>(d) Joining strips in linings, fascias and gables must be of bushfire-resisting timber.</p> <p>(e) Fibre-reinforced cement or aluminium must not be used for roof sheeting or fascias.</p> <p>(f) Aluminium must not be used for eaves linings.</p> |
| 5. BAL — 40 |
| <p>Roofs must comply with clauses 8.6.1, 8.6.2, 8.6.3, 8.6.4 and 8.6.6 of the BAL — 40 requirements of AS 3959 with the following variations:</p> <ul style="list-style-type: none"> (a) Sheet roofs (metal or fibre-cement sheet) must be fully sarked with a <i>sarking-type material</i> having a <i>Flammability Index</i> of not more than 5. (b) Joining strips in eaves linings, fascias and gables must be of bushfire-resisting timber. (c) Fibre-reinforced cement or aluminium must not be used for roof sheeting or fascias. (d) Aluminium must not be used for eaves linings. |
| 6. BAL — FZ |
| <p>Roofs must comply with clauses 9.6.1, 9.6.2, 9.6.3 and 9.6.4 of the BAL — FZ requirements of AS 3959 with the following variation:</p> <ul style="list-style-type: none"> (a) Joining strips in eaves linings, fascias and gables must be of bushfire-resisting timber. |
| ROOF LIGHTS |
| (including vented Roof lights and skylights) |
| 1. BAL — Low |
| No Requirements. |
| 2. BAL — 12.5 |
| <p>Roof lights must comply with clause 5.6.5 of the BAL — 12.5 requirements of AS 3959 with the following variations:</p> <ul style="list-style-type: none"> (a) Aluminium mesh or perforated sheet must not be used for screening purposes. (b) Roof lights and associated shafts through the roof space must be sealed with a <i>non-combustible</i> sleeve or lining. |
| 3. BAL — 19 |
| <p>Roof lights must comply with clause 6.6.5 of the BAL — 19 requirements of AS 3959 with the following variations:</p> <ul style="list-style-type: none"> (a) Aluminium mesh or perforated sheet must not be used for screening purposes. (b) Roof lights and associated shafts through the roof space must be sealed with a <i>non-combustible</i> sleeve or lining. |

SA TABLE G5.1 CONSTRUCTION REQUIREMENTS FOR BAL — LOW, BAL — 12.5, BAL — 19, BAL — 29, BAL — 40 and BAL — FZ SITES— continued

| |
|---|
| 4. BAL — 29 |
| Roof lights must comply with clause 7.6.5 of the BAL — 29 requirements of AS 3959 with the following variations: |
| (a) Aluminium mesh or perforated sheet must not be used for screening purposes. |
| (b) Roof lights and associated shafts through the roof space must be sealed with a <i>non-combustible</i> sleeve or lining. |
| 5. BAL — 40 |
| Roof lights must comply with clause 8.6.5 of the BAL — 40 requirements of AS 3959 with the following variation: |
| (a) Roof lights and associated shafts through the roof space must be sealed with a <i>non-combustible</i> sleeve or lining. |
| 6. BAL — FZ |
| Roof lights must comply with clause 9.6.3 of the BAL — FZ requirements of AS 3959. |
| ROOF-MOUNTED EVAPORATIVE COOLING UNITS |
| 1. BAL — Low |
| No requirements. |
| 2. BAL — 12.5 |
| Evaporative coolers must comply with clause 5.6.5 of the BAL — 12.5 requirements of AS 3959 with the following variation: |
| (a) Aluminium mesh or aluminium perforated sheet must not be used for screening purposes. |
| 3. BAL — 19 |
| Evaporative coolers must comply with clause 6.6.5 of the BAL — 19 requirements of AS 3959 with the following variation: |
| (a) Aluminium mesh or aluminium perforated sheet must not be used for screening purposes. |
| 4. BAL — 29 |
| Evaporative coolers must comply with clause 7.6.5 of the BAL — 29 requirements of AS 3959 with the following variation: |
| (a) Aluminium mesh or aluminium perforated sheet must not be used for screening purposes. |
| 5. BAL — 40 |
| Evaporative coolers must not be installed where the <i>site</i> has been classified as BAL — 40. |
| 6. BAL — FZ |
| Evaporative coolers must not be installed where the <i>site</i> has been classified as BAL — FZ. |
| OTHER ROOF PENETRATIONS |
| (including roof ventilators, aerials, vent pipes and supports for solar collectors) |
| 1. BAL — Low |

SA TABLE G5.1 CONSTRUCTION REQUIREMENTS FOR BAL — LOW, BAL — 12.5, BAL — 19, BAL — 29, BAL — 40 and BAL — FZ SITES— continued

| | |
|--|--|
| No requirements. | |
| 2. | BAL — 12.5 |
| Roof penetrations must comply with clause 5.6.5 of the BAL — 12.5 requirements of AS 3959 with the following variations: | |
| (a) | Aluminium mesh or aluminium perforated sheet must not be used for screening purposes. |
| (b) | All components of roof ventilators (including rotary ventilators), aerials, vent pipes and supports for solar collectors must be of <i>non-combustible</i> material. |
| 3. | BAL — 19 |
| Roof penetrations must comply with clause 6.6.5 of the BAL — 19 requirements of AS 3959 with the following variations: | |
| (a) | Aluminium mesh or aluminium perforated sheet must not be used for screening purposes. |
| (b) | All components of roof ventilators (including rotary ventilators), aerials, vent pipes and supports for solar collectors must be of <i>non-combustible</i> material. |
| 4. | BAL — 29 |
| Roof penetrations must comply with clause 7.6.5 of the BAL — 29 requirements of AS 3959 with the following variations: | |
| (a) | Aluminium mesh or aluminium perforated sheet must not be used for screening purposes. |
| (b) | All components of roof ventilators (including rotary ventilators), aerials, vent pipes and supports for solar collectors must be of <i>non-combustible</i> material. |
| 5. | BAL — 40 |
| Roof penetrations must comply with clause 8.6.5 of the BAL — 40 requirements of AS 3959 with the following variation: | |
| (a) | All components of roof ventilators (including rotary ventilators), aerials, vent pipes and supports for solar collectors must be of <i>non-combustible</i> material. |
| 6. | BAL — FZ |
| Roof penetrations must comply with clause 9.6.3 of the BAL — FZ requirements of AS 3959 with the following variation: | |
| (a) | All components of roof ventilators (including rotary ventilators), aerials, vent pipes and supports for solar collectors must be of <i>non-combustible</i> material. |
| GUTTERS AND DOWNPIPES | |
| 1. | BAL — Low |
| No requirements. | |
| 2. | BAL — 12.5 |
| Gutters and downpipes must comply with clause 5.6.7 of the BAL — 12.5 requirements of AS 3959. | |

SA TABLE G5.1 CONSTRUCTION REQUIREMENTS FOR BAL — LOW, BAL — 12.5, BAL — 19, BAL — 29, BAL — 40 and BAL — FZ SITES— continued

| |
|--|
| 3. BAL — 19 |
| Gutters and downpipes must comply with clause 6.6.7 of the BAL — 19 requirements of AS 3959. |
| 4. BAL — 29 |
| Gutters and downpipes must comply with clause 7.6.7 of the BAL — 29 requirements of AS 3959. |
| 5. BAL — 40 |
| Gutters and downpipes must comply with clause 8.6.7 of the BAL — 40 requirements of AS 3959. |
| 6. BAL — FZ |
| Gutters and downpipes must comply with clause 9.6.5 of the BAL — FZ requirements of AS 3959. |
| WATER AND GAS SUPPLY PIPES |
| 1. BAL — Low |
| No requirements. |
| 2. BAL — 12.5 |
| Water and gas supply pipes must comply with clause 5.8 of the BAL — 12.5 requirements of AS 3959. |
| 3. BAL — 19 |
| Water and gas supply pipes must comply with clause 6.8 of the BAL — 19 requirements of AS 3959. |
| 4. BAL — 29 |
| Water and gas supply pipes must comply with clause 7.8 of the BAL — 29 requirements of AS 3959. |
| 5. BAL — 40 |
| Water and gas supply pipes must comply with clause 8.8 of the BAL — 40 requirements of AS 3959. |
| 6. BAL — FZ |
| Water and gas supply pipes must comply with clause 9.8 of the BAL — FZ requirements of AS 3959. |
| VERANDAHS, DECKS, STEPS, RAMPS AND LANDINGS |
| (including balustrades, handrails or other barriers) |
| 1. BAL — Low |
| Verandahs, decks, steps and trafficable surfaces of ramps and landings must comply with one or a combination of the following: |
| (a) A concrete slab-on-ground. |
| (b) A suspended concrete slab. |

SA TABLE G5.1 CONSTRUCTION REQUIREMENTS FOR BAL — LOW, BAL — 12.5, BAL — 19, BAL — 29, BAL — 40 and BAL — FZ SITES— continued

| | |
|---|---|
| (c) | Any supporting posts or columns must comply with the BAL — Low requirements of this table for supporting posts, column stumps, piers and poles. |
| (d) | Any supporting walls must comply with the BAL — 12.5 requirements of this table for <i>external walls</i> . |
| (e) | Where sheeted or tongued and grooved solid flooring is used, the flooring system must comply with the BAL — Low requirements of this table for flooring systems. |
| (f) | Where a timber deck is used— |
| (i) | the gap between the timber decking must not be less than 5 mm; and |
| (ii) | to facilitate access for extinguishment, the perimeter of the deck must not be enclosed or access to the space beneath the deck impeded; and |
| (iii) | The timber decking and flooring must be separated from the remainder of the building in a manner that will not spread the fire into the building. |
| 2. BAL — 12.5 | |
| Verandahs, decks, steps and trafficable surfaces of ramps and landings must comply with the BAL — Low requirements of this table with the following variations: | |
| (a) | Any supporting posts or columns must comply with the BAL — 12.5 requirements of this table for supporting posts, columns, stumps, piers and poles. |
| (b) | Where sheeted or tongued and grooved solid flooring is used, the flooring system must comply with the BAL — 12.5 requirements of this table for flooring systems. |
| 3. BAL — 19 | |
| Verandahs, decks, steps and trafficable surfaces of ramps and landings must comply with the BAL — Low requirements of this table with the following variations: | |
| (a) | Any supporting posts or columns must comply with the BAL — 19 requirements of this table for supporting posts, column stumps, piers and poles. |
| (b) | Any supporting walls must comply with the BAL — 19 requirements of this table for <i>external walls</i> . |
| (c) | Where sheeted or tongued and grooved solid flooring is used, the flooring system must comply with the BAL — 19 requirements of this table for flooring systems. |
| (d) | Where spaced timber deck flooring is used, bushfire-resisting timber must be used for the decking material. |
| 4. BAL — 29 | |
| Verandahs, decks, steps and trafficable surfaces of ramps and landings must comply with the BAL — Low requirements of this table with the following variations: | |
| (a) | Any supporting posts or columns must comply with the BAL — 29 requirements of this table for supporting posts, column stumps, piers and poles. |
| (b) | Any supporting walls must comply with the BAL — 29 requirements of this table for <i>external walls</i> . |
| (c) | Where sheeted or tongued and grooved solid flooring is used, the flooring system must comply with the BAL — 29 requirements of this table for flooring system. |

SA TABLE G5.1 CONSTRUCTION REQUIREMENTS FOR BAL — LOW, BAL — 12.5, BAL — 19, BAL — 29, BAL — 40 and BAL — FZ SITES— continued

| | |
|--|--|
| (d) | Where spaced timber deck flooring is used, bushfire-resisting timber must be used for the decking material. |
| (e) | Balustrades and handrails must be <i>non-combustible</i> , or if timber is used, it must be bushfire-resisting timber. |
| 5. BAL — 40 | |
| Verandahs, decks, steps and trafficable surfaces of ramps and landings must comply with the BAL — 40 requirements of AS 3959 with the following variation: | |
| (a) | Balustrades and handrails must be <i>non-combustible</i> . |
| 6. BAL — FZ | |
| Verandahs, decks, steps and trafficable surfaces of ramps and landings must comply with BAL — FZ requirements of AS 3959 with the following variations: | |
| (a) | Balustrades and handrails must be <i>non-combustible</i> . |

Add SA Part G7 as follows:

SA PART G7 ACCESS FOR MAINTENANCE

OBJECTIVE

SA G07

The *Objectives* of this Part are—

- (a) to safeguard people from injury while cleaning *windows*; and
- (b) to safeguard people from injury or illness resulting from the creation of hazardous spaces between buildings.

FUNCTIONAL STATEMENTS

SA GF7.1

A building is to provide people with safe conditions for carrying out *window* cleaning operations.

SA GF7.2

The space between buildings must not allow hazardous conditions to arise due to accumulation of rubbish that cannot readily be removed.

| |
|---------------------------------|
| PERFORMANCE REQUIREMENTS |
|---------------------------------|

SA GP7.1

Where any part of a *window* in a building is more than 5.5 m above ground level, provision must be made for safe access to the external surface of the *window* for minor maintenance and cleaning.

SA GP7.2

The space between buildings must be sufficient to allow access for inspection and maintenance, to avoid hazardous conditions arising due to accumulation of rubbish that could—

- (a) bridge termite barriers; or
- (b) harbour vermin; or
- (c) create a *fire hazard*.

SA G7.0 Deemed-to-Satisfy Provisions

Performance Requirements SA GP7.1 and *SA GP7.2* are satisfied by complying with *SA G7.1* to *SA G7.3*.

SA G7.1 Application of Part

The following provisions apply to Class 2 to 9 buildings.

SA G7.2 Access for window cleaning

Where any part of a *window* in a building is more than 5.5 m above ground level, access to the external surface of the *window* for minor maintenance and cleaning must be provided. Any of the following methods are acceptable—

- (a) by means of a moveable gantry; or
- (b) by means of reversible pivoting sashes, each of which has catches that secure the sash in either the normal or reversed position and give visual indication that the *window* is secure, provided that where a *window* sill is less than 900 mm above floor level, safety anchorages are provided; or
- (c) by means of safety harness, having all anchorages—
 - (i) designed and installed in accordance with AS/NZS 1891.4; and
 - (ii) constructed of approved corrosion resistant metal; or
- (d) by means of opening sashes, in which case the maximum reach to the farthest part of the *window* must not exceed 500 mm upwards or 1 m sideways or downwards and provided that where the *window* sill is less than 900 mm above floor level, safety anchorages are provided.

SA G7.3 Access for inspection and maintenance between buildings

Every part of an *external wall* of a building must be not less than 600 mm from—

- (a) the *external wall* of any other building on the same allotment, unless the two buildings are abutting; or

(b) any boundary of the allotment, unless that wall is on or abutting that boundary, unless the space between external columns is not infilled.

Add SA Part G8 as follows:

SA PART G8 MISCELLANEOUS PROVISIONS

OBJECTIVE

SA G08

The *Objective* of this Part is to safeguard people from injury resulting from hazardous conditions being created by building attachments.

FUNCTIONAL STATEMENT

SA GF8.1

A building is to be provided with safeguards to prevent a building attachment—

- (a) collapsing; and
- (b) creating hazardous conditions by its water run-off; and
- (c) affecting adjacent road safety conditions by its projection; and
- (d) creating a *fire hazard* above a street.

PERFORMANCE REQUIREMENT

SA GP8.1

An attachment to a building must incorporate features that will—

- (a) protect it against corrosion; and
- (b) collect and discharge its rainwater run-off safely; and
- (c) prevent its projection affecting adjacent road safety conditions or pedestrian traffic; and
- (d) provide resistance to the spread of fire if it overhangs a street boundary,

to a degree necessary to avoid creating hazardous conditions that may cause injury to people passing below or driving past.

SA G8.0 Deemed-to-Satisfy Provisions

Performance Requirement SA GP8.1 is satisfied by complying with **SA G8.1** and **SA G8.2**.

SA G8.1 Application of Part

The following provisions apply to Class 2 to 9 buildings.

SA G8.2 Attachments to buildings

- (a) An attachment to a building that is in the nature of a balcony or awning, bridge, gangway, hoarding or trade sign, sky sign, mast, flagpole, tower, aerial or antenna, lantern, cathead, crane, chimney, flue or duct, or an installation for cleaning and maintenance access must—
 - (i) have all metal parts of corrosion resistant metal, or other metal suitably protected;
 - (ii) not overhang any street boundary at a height less than 2.5 m above the footpath, or 4 m above the roadway; and
 - (iii) be provided with drainage to prevent rainwater or condensate falling onto or running across the footpath, unless either it is a retractable awning in the nature of a sun blind, or unless the total catchment area for run-off is less than 1.5 m².
- (b) A balcony or awning that overhangs a street boundary—
 - (i) must not extend closer than 450 mm to the kerb of the roadway; and
 - (ii) must be constructed of *non-combustible* or fire-retardant materials throughout, except that timber battens may be used to support the soffit lining.

SECTION H SPECIAL USE BUILDINGS

SA PART H2 BULK GRAIN STORAGE FACILITIES

SA H2.1 Application of Part

This Part applies to certain Class 7 buildings erected for commercial bulk handling and storage of granular materials such as grain, ore, or the like, where only a small number of occupants are present at one time.

SA H2.2 Concessions for bulk grain storage facilities

Compliance with Minister's Specification SA H2.2 — “Construction of bulk grain storage facilities” is deemed-to-satisfy the *Performance Requirements* of **Sections C, D, E and F**, as applicable, for cell type silos and large grain storage and handling sheds.

SA PART H3 FARM BUILDINGS

SA H3.1 Application of Part

This Part applies to Class 7 or 8 buildings used for certain farming purposes.

SA H3.2 Concessions and additions for farm buildings

Class 7 and 8 farm buildings complying with Minister's Specification SA H3.2 — ‘Concessions and additional requirements for farm buildings’ and all other relevant BCA *Deemed-to-Satisfy*

Provisions not varied by the Minister's Specification are deemed to satisfy the *Performance Requirements* of the BCA.

SECTION I MAINTENANCE

PART I1 EQUIPMENT AND SAFETY INSTALLATIONS

Delete I1.1 and insert SA I1.1 as follows:

SA I1.1 Safety installations

Safety measures must—

- (a) perform to a standard not less than the standard they were originally required to achieve; and
- (b) for those safety measures listed in **Tables I1.1 to I1.13**, perform to a standard not less than that determined using the corresponding BCA provisions as required at installation; and
- (c) safety measures listed in **Tables I1.1 to I1.11** and **I1.13** are 'essential safety provisions' that must be maintained in accordance with regulation 76 of the Development Regulations 1993; and
- (d) Compliance with Minister's Specification SA 76 is deemed-to-satisfy (a), (b) and (c).

Delete I1.2 and insert SA I1.2 as follows:

SA I1.2 Mechanical ventilation and hot water, warm water and cooling water systems

Mechanical ventilation and hot water, warm water and cooling water systems in a building other than a system only serving a single *sole-occupancy unit* in a Class 2 or 3 building or Class 4 part must be maintained in accordance with item 3.6(f) of Minister's Specification SA 76.

SECTION J ENERGY EFFICIENCY

Insert SA JP4 as follows:

Performance Requirement

SA JP4

Heating for a hot water supply system that only serves a single *sole-occupancy unit* in a Class 2 building must, to the degree necessary, obtain energy from a source that has a greenhouse gas emission profile not exceeding 300 kilograms of carbon dioxide equivalent per gigajoule of heated water (300 kgCO₂-e/GJ).

Insert SA JV4 after SA JP4 as follows:

| |
|----------------------------|
| Verification Method |
|----------------------------|

SA JV4

- (a) Compliance with Performance Requirement **SA JP4** for a heater in a hot water supply system is verified when the annual greenhouse gas intensity of the water heater does not exceed 300 g CO₂-e/MJ of thermal energy load determined in accordance with AS/NZS 4234.
- (b) The greenhouse gas intensity of the water heater in **(a)** is the sum of the annual greenhouse gas emissions from each energy source in g CO₂-e divided by the annual thermal energy load of the water heater.
- (c) The annual greenhouse gas emission from each energy source in **(b)** is the product of—
 - (i) the annual amount of energy consumed from that energy source; and
 - (ii) the emission factor of—
 - (A) if the energy source is electricity, 272 g CO₂-e/MJ; or
 - (B) if the energy source is liquefied petroleum gas, 65 g CO₂-e/MJ; or
 - (C) if the energy source is natural gas, 61 g CO₂-e/MJ; or
 - (D) if the energy source is wood or biomass, 4 g CO₂-e/MJ.

SA PART J1 BUILDING FABRIC

After J1.3(d) insert SA J1.3(e) as follows:

SA J1.3 Roof and ceiling construction

- (e) If a Class 5, 6, 7, 8 or 9 building, or part of a building—
 - (i) is constructed in *climate zone* 4 or 5; and
 - (ii) has a roof pitch of not more than 5 degrees; and
 - (iii) has a *conditioned space*,the roofing material must have an upper surface solar absorptance value of not more than 0.4.

SA PART J7 HOT WATER SUPPLY AND SWIMMING POOL AND SPA POOL PLANT

After J7.0(b) insert SA J7.0(c) as follows:

SA J7.0 Deemed-to-Satisfy Provisions

- (c) *Performance Requirement SA JP4* is satisfied by complying with **SA J7.5**.

Delete J7.2 and insert SA J7.2 as follows:

SA J7.2 Hot water supply

The design and installation of heated water services in South Australia is regulated by Directions issued by the South Australian Water Corporation pursuant to Regulation 17 of the Waterworks Regulations 1996.

After J7.4 insert SA J7.5 as follows:

SA J7.5 Complying heated water services

A water heater in a hot water supply system that only serves a single Class 2 *sole-occupancy unit* must be one of the following:

- (a) An electric heated water service with a **rated hot water delivery**, if applicable, of 700 litres or less.
- (b) A natural gas or LPG heated water service (instantaneous, continuous flow or storage) that is rated at not less than 2.5 stars in accordance with AS 4552, and a tank volume, if applicable, of 700 litres or less.
- (c) A solar heated water service (electric, natural gas or LPG boosted) or heat pump heated water service (air source or solar boosted), with a total tank volume of 700 litres or less, that is eligible for any number of *Small-scale Technology Certificates*.
- (d) A wood combustion heated water service, with no additional heating mechanisms, with a total tank volume of 700 litres or less.
- (e) A wood combustion boosted solar heated water service, with no additional heating mechanisms, with a total tank volume of 700 litres or less.

Footnote: OTHER LEGISLATION AFFECTING BUILDINGS

In addition to any applicable provisions of the Development Act 1993, the Development Regulations 2008 and this Code, there are a number of other legislative technical requirements affecting the design, construction and/or performance of buildings that practitioners may need to be aware of, including, but not necessarily limited to, the following list. Additional legislative instruments such as regulations, codes and standards may exist under the legislation listed.

1. Abattoirs

1.1 Administering agency:

Department for Health and Ageing

Relevant legislation:

Food Act 2001

Food Regulations 2002

2. Accommodation

2.1 Administering agency:

Department for Communities and Social Inclusion

Relevant legislation:

Supported Residential Facilities Act 1992

Supported Residential Facilities Regulations 2009

3. Asbestos Removal

3.1 Administering agency:

SafeWork SA, Department of the Premier and Cabinet

Relevant legislation:

Occupational Health, Safety and Welfare Act 1986

Occupational Health, Safety and Welfare Regulations 2011

4. Children's Services

4.1 Administering agency:

Department of Further Education and Child Development

Relevant legislation:

Children's Services Act 1985

5. Crown Land

5.1 Administering agency:

Department of Environment, Water and Natural Resources

Relevant legislation:

Crown Land Management Act 2009

Crown Land Management Regulations 2010

6. Dangerous Goods

6.1 Administering agency:

Department for Health and Ageing

Relevant legislation:

Controlled Substances Act 1984

Controlled Substances (Pesticides) Regulations 2003

Controlled Substances (Poisons) Regulations 2011

6.2 Administering agency:

Safework SA, Department of the Premier and Cabinet

Relevant legislation:

Dangerous Substances Act 1979

Dangerous Substances Regulations 2002

Explosives Act 1936

Explosives Regulations 2011

Explosives (Fireworks) Regulations 2001

Explosives (Security Sensitive Substances) Regulations 2006

7. Electrical Installations

7.1 Administering agency:

Office of the Technical Regulator, Department for Manufacturing, Innovation, Trade, Resources and Energy

Relevant legislation:

Electricity Act 1996

Electricity (General) Regulations 1997

8. Encroachments

8.1 Administering agency:

Attorney-General's Department

Relevant legislation:

Encroachments Act 1944

9. Fences

9.1 Administering agency:

Attorney-General's Department

Relevant legislation:

Fences Act 1975

Fences Regulations 2003

10. Fire Prevention in Existing Buildings

10.1 Administering agency:

Department of Planning, Transport and Infrastructure

Relevant legislation:

Development Act 1993

Development Regulations 2008

10.2 Administering agency:

SA Fire and Emergency Services Commission

Relevant legislation:

Fire and Emergency Services Act 2005

Fire and Emergency Services Regulations 2005

11. Food Premises

11.1 Administering agency:

Department for Health and Ageing

Relevant legislation:

Food Act 2001

Food Regulations 2002

12. Gas Installations

12.1 Administering agency:

Office of the Technical Regulator, Department for Manufacturing, Innovation, Trade, Resources and Energy

Relevant legislation:

Gas Act 1997

Gas Regulations 1997

13. Historic Buildings

13.1 Administering agency:

Department of Environment, Water and Natural Resources

Relevant legislation:

Heritage Places Act 1993

Heritage Places Regulations 2005

14. Hospitals, Nursing Homes and Health Care Buildings

14.1 Administering agency:

Department for Health and Ageing

Relevant legislation:

Health Care Act 2008

Health Care Regulations 2008

15. Housing

15.1 Administering agency:

Department for Communities and Social Inclusion

Relevant legislation:

Housing Improvement Act 1940

Housing Improvement (Standards) Regulations 2007

16. Licensed Premises

16.1 Administering agency:

Office of Liquor and Gambling Commissioner, Attorney-General's Department

Relevant legislation:

Liquor Licensing Act 1997

Liquor Licensing (General) Regulations 1997

17. Lift Installations

17.1 Administering agency:

Safework SA, Department of the Premier and Cabinet

Relevant legislation:

Occupational Health, Safety and Welfare Act 1986

Occupational Health, Safety and Welfare Regulations 2011

18. Occupational Health and Safety

18.1 Administering agency:

SafeWork SA, Department of the Premier and Cabinet

Relevant legislation:

Occupational Health, Safety and Welfare Act 1986

Occupational Health, Safety and Welfare Regulations 2011

19. Pharmacies

19.1 Administering agency:

Department for Health and Ageing

Relevant legislation:

Health Practitioner Regulation National Law (South Australia) Act 2010

Health Practitioner Regulation National Law (South Australia) Regulations 2010

20. Radiation Safety

20.1 Administering agency:

Environment Protection Authority

Relevant legislation:

Radiation Protection and Control Act 1982

Radiation Protection and Control (Ionising Radiation) Regulations 2000

21. Sanitary Plumbing, Water Supply and Sewerage

21.1 Administering agency:

South Australian Water Corporation

Relevant legislation:

Sewerage Act 1929

Sewerage Regulations 2011

Waterworks Act 1932

Waterworks Regulations 2011

22. School (non-government)

22.1 Administering agency:

Department of Further Education and Child Development

Relevant legislation:

Education Act 1972

Education Regulations 1997

23. Septic Tank and Grey Water Installations

23.1 Administering agency:

Department for Health and Ageing

Relevant legislation:

Public and Environmental Health Act 1987

Public and Environmental Health (Waste Control) Regulations 2010

24. Smoking Restrictions

24.1 Administering agency:

Department for Health and Ageing

Relevant legislation:

Tobacco Products Regulation Act 1997

Tobacco Products Regulations 2004

25. Subdivision of Property

25.1 Administering agency:

Land Services Group, Department of Planning, Transport and Infrastructure

Relevant legislation:

Community Titles Act 1996

Community Titles Regulations 2011

Real Property Act 1886

Real Property Regulations 2009

Strata Titles Act 1988

Strata Titles Regulations 2003

26. Waste Management and Environment Protection

26.1 Administering agency:

Environment Protection Authority

Relevant legislation:

Environment Protection Act 1993

Environment Protection Regulations 2009

26.2 **Administering agency:**

South Australian Water Corporation

Relevant legislation:

Sewerage Act 1929

Sewerage Regulations 2011

TASMANIA

INTRODUCTION

The Tasmania BCA Appendix includes variations from the requirements of the 2013 edition of the Building Code of Australia (BCA) and additional requirements resulting from the consolidation in Tasmania of all building-related regulations into the BCA.

The variations from the requirements of the BCA apply to the construction or alteration of all buildings in Tasmania and the extra requirements apply to all workplaces and special-use buildings.

APPENDIX CONTENTS

APPENDIX TASMANIA

Tasmania

A GENERAL PROVISIONS

Tas A1.1 Definitions
Tas Specification A1.3 Standards Adopted By Reference

D ACCESS AND EGRESS

Tas DP10 Performance Requirements
Tas D3.0 Deemed-to-Satisfy Provisions
Tas D3.13 Compliance with Premises Standards

E SERVICES AND EQUIPMENT

Tas EO1 Objectives
Tas EF1.2 Functional Statements
Tas EP1.7 Performance Requirements
Tas E1.0 Deemed-to-Satisfy Provisions
Tas E1.101 Fire detection and alarm system

F HEALTH AND AMENITY

Tas Table F2.3 Sanitary Facilities in Class 3, 5, 6, 7, 8 and 9 buildings
Tas F2.101 Non-flushed Urinals
Tas F2.102 Installation of Closet Fixtures
Tas F4.101 Fixed Natural Ventilation

G ANCILLARY PROVISIONS

TAS PART G1 MINOR STRUCTURES AND COMPONENTS

Tas GO1 Objectives
Tas GF1.2 and GF1.5 to GF1.7 Functional Statements
Tas GP1.2 and GP1.6 to GP1.10 Performance Requirements
Tas G1.0 Deemed-to-Satisfy Provisions
Tas G1.1 Swimming pools

TAS PART G2 HEATING APPLIANCES, FIREPLACES, CHIMNEYS AND FLUES

Tas G02 Objective
Tas GF2.1 Functional Statement
Tas GP2.1 Performance Requirement
Tas G2.2 Installation of appliances

TAS PART G5 CONSTRUCTION IN BUSHFIRE PRONE AREAS

- Tas G05 Objective
- Tas GF5.1 Functional Statement
- Tas GP5.1 Performance Requirement
- Tas G5.3 Vehicular access
- Tas G5.4 Water supply

TAS PART G101 PROJECTIONS OVER WAYS

- Tas G101.1 Construction and location of projections over ways
- Tas G101.2 Protection of Ways

H SPECIAL USE BUILDINGS

- Tas Part H101 - Tas Part H121 Objectives

TAS PART H101 WORKPLACES

- Tas H101.1 Application of Part
- Tas H101.2 Floor area
- Tas H101.3 Floor surfaces
- Tas H101.4 Floor drainage
- Tas H101.5 Floor covering
- Tas H101.6 Overhead clearance
- Tas H101.7 Lighting
- Tas H101.8 Ventilation
- Tas H101.9 Toilet facilities
- Tas H101.10 Hand washing facilities
- Tas H101.11 Shower facilities
- Tas H101.12 Change rooms
- Tas H101.13 Dining rooms
- Tas H101.14 Rest rooms
- Tas H101.15 First aid rooms and health centres
- Tas H101.16 Doors

TAS PART H102 FOOD PREMISES

- Tas H102 O1 Objective
- Tas H102 F1 Functional Statement
- Tas H102 P1 to H102 P12 Performance Requirements
- Tas H102.0 Application of Part
- Tas H102.1 Deemed-to-Satisfy Provisions
- Tas H102.2 General Requirements
- Tas H102.3 Pests and contaminants
- Tas H102.4 Drains and Pipes
- Tas H102.5 Offensive material and trade waste
- Tas H102.6 Ventilation
- Tas H102.7 Lighting
- Tas H102.8 Floors, walls and ceilings
- Tas H102.9 Separation of work place
- Tas H102.10 Washbasins
- Tas H102.11 Sinks
- Tas H102.12 Design, construction and installation of fixtures, fittings and equipment
- Tas H102.13 Storage of materials and equipment
- Tas H102.14 Food store

Tas H102.15 Meat Premises
Tas H102.16 Dairy produce
Tas H102.17 Refrigerated and cooling chambers

TAS PART H103 DINING ROOMS AND BAR ROOMS

Tas H103.1 Application of Part
Tas H103.2 Sanitary facilities
Tas H103.3 Separation from other areas

TAS PART H104 * * * * *

TAS PART H105 * * * * *

TAS PART H106 MEAT PREMISES

Tas H106.1 Application of Part
Tas H106.2 Premises Processing Animals and Meat

TAS PART H107 FARM DAIRY PREMISES

Tas H107.1 Application of this Part
Tas H107.2 Milking Sheds and Holding Yards
Tas H107.3 Milk Receiving Area and Milk Storage Room
Tas H107.4 Water supply

TAS PART H108 PHARMACIES

Tas H108.1 Application of Part
Tas H108.2 Definition
Tas H108.3 Pharmacy premises
Tas H108.4 Dispensary
Tas H108.5 Security of dispensary

TAS PART H109 HEALTH SERVICES ESTABLISHMENTS

Tas H109.1 Application of Part
Tas H109.2 Design and construction of health services establishments

TAS PART H110 PREMISES USED FOR ACTIVITIES INVOLVING SKIN PENETRATION

Tas H110.1 Application of Part
Tas H110.2 Sanitary facilities
Tas H110.3 Washbasins

TAS PART H111 DENTAL SURGERIES AND CHIROPRACTORS' PREMISES

Tas H111.1 Application of Part
Tas H111.2 Waiting room
Tas H111.3 Floor, walls and ceiling
Tas H111.4 Disposal of liquid wastes

TAS PART H112 MORTUARIES

Tas H112.1 Application of Part
Tas H112.2 Layout of mortuary
Tas H112.3 Construction of body preparation room
Tas H112.4 Water supply and sewerage

TAS PART H113 FOUNDRIES

- Tas H113.1 Application of Part
- Tas H113.2 General
- Tas H113.3 Cupola charging platform
- Tas H113.4 Deep moulds and pits
- Tas H113.5 Pot furnaces

TAS PART H114 PREMISES FOR MANUFACTURE OR PROCESSING OF GLASS REINFORCED PLASTICS

- Tas H114.1 Application of Part
- Tas H114.2 Separation from other buildings
- Tas H114.3 Rise in storeys
- Tas H114.4 Maximum floor areas
- Tas H114.5 Required exits
- Tas H114.6 Hand laminating and spray depositing
- Tas H114.7 Ventilation
- Tas H114.8 Smoke and heat roof vents

TAS PART H115 PREMISES FOR PRODUCTION OR PROCESSING OF ISOCYANATES

- Tas H115.1 Application of Part
- Tas H115.2 Areas of work places
- Tas H115.3 Separation from other areas and buildings
- Tas H115.4 Rise in storeys
- Tas H115.5 Maximum floor areas
- Tas H115.6 Required exits
- Tas H115.7 Bulk stores for polyols and isocyanates
- Tas H115.8 Curing room

TAS PART H116 PREMISES FOR ELECTRO-PLATING ELECTRO-POLISHING, ANODISING OR ETCHING

- Tas H116.1 Application of Part
- Tas H116.2 Floors
- Tas H116.3 Height of plating area
- Tas H116.4 Air space
- Tas H116.5 Ceiling construction

TAS PART H117 PREMISES FOR LEAD PROCESSING

- Tas H117.1 Application of Part
- Tas H117.2 Floors
- Tas H117.3 Height of lead processing areas
- Tas H117.4 Air space and floor space
- Tas H117.5 Interior of lead processing areas
- Tas H117.6 Dust collection
- Tas H117.7 Isolation of certain processes
- Tas H117.8 Drying room shelves
- Tas H117.9 Washing facilities
- Tas H117.10 Change rooms

TAS PART H118 BOOTHS FOR SPRAY PAINTING OR SPRAY COATING

- Tas H118.1 Application of Part
- Tas H118.2 Design and construction of booths

TAS PART H119 ELECTRICITY DISTRIBUTION SUBSTATIONS

- Tas H119.1 Application of Part
- Tas H119.2 Building-type substations

TAS PART H120 PREMISES FOR STORAGE OF DANGEROUS GOODS

- Tas H120.1 Application of Part
- Tas H120.2 Interpretation
- Tas H120.3 Class of dangerous goods
- Tas H120.4 Premises for storage of dangerous goods
- Tas H120.5 Workrooms
- Tas H120.6 Exits
- Tas H120.7 Explosion vents
- Tas H120.8 Spill Collection Bunds
- Tas H120.9 Electrical equipment

TAS PART H121 HAIRDRESSERS' PREMISES

- Tas H121.1 Application of Part
- Tas H121.2 Size of operating section
- Tas H121.3 Premises in a residence
- Tas H121.4 Sanitary facilities

TAS PART H122 EARLY CHILDHOOD CENTRES AND SCHOOL AGE CARE FACILITIES

- Tas H122 O1 Objective
- Tas H122 F1 Functional Statement
- Tas H122 P1 to H122 P3 Performance Requirements
- Tas H122.0 Application of Part
- Tas H122.1 Deemed-to-Satisfy Provisions

TAS PART H123 TEMPORARY STRUCTURES

- Tas H123 O1 Objective
- Tas H123 F1 Functional Statement
- Tas H123 P1 to H123 P14 Performance Requirements
- Tas H123.0 Application of Part
- Tas H123.1 Deemed-to-Satisfy Provisions
- Tas H123.2 Structure
- Tas H123.3 Fire resisting material
- Tas H123.4 Access
- Tas H123.5 Exits and entrances
- Tas H123.6 Barriers
- Tas H123.7 Emergency lighting
- Tas H123.8 Exit signs
- Tas H123.9 Fire fighting equipment
- Tas H123.10 Sanitary facilities
- Tas H123.11 Lighting
- Tas H123.12 Ventilation
- Tas H123.13 Electrical
- Tas H123.14 Heating appliances
- Tas H123.15 Seating

**TAS PART H124 PREMISES WHERE WORK IS UNDERTAKEN ON GAS-FUELLED
VEHICLES**

Tas H124.1 Application of Part
Tas H124.2 Working Areas

Footnote: Other Legislation Affecting Buildings

SECTION A GENERAL PROVISIONS

PART A1 INTERPRETATION

Tas A1.1 Definitions

Insert definition for *centre-based care class 4 facility* as follows:

Centre-based care class 4 facility is a facility as defined in Centre Based Care Class 4 Standards.

Insert definition for *centre-based care class 5 facility* as follows:

Centre-based care class 5 facility is a facility as defined in Centre Based Care Class 5 Standards.

Vary the definition for *early childhood centre* as follows:

Early childhood centre means any premises or part thereof providing or intending to provide a centre-based education and care service within the meaning of the Education and Care Services National Law Act 2010 (Vic), the Education and Care Services National Regulations and centre-based services that are licensed or approved under State and Territory children's services law, but excludes—

- (a) education and care primarily provided to school aged children in outside school hours settings; and
- (b) services licensed as *centre based care class 4* under the Child Care Act 2001.

Insert definition for *public* as follows:

Public includes any person working in an enclosed public place.

Insert definition for *School age care facility* as follows:

School age care facility is a facility providing care for children (primarily) 5 years or older in an outside of school hours setting, either approved or licenced under Education and Care Services National Law (Application) Act 2011 or the Child Care Act 2001.

Insert definition for *temporary structure* as follows:

Temporary structure includes any—

- (a) booth, tent or other temporary enclosure, whether or not part of the booth, tent or enclosure is permanent; or
- (b) temporary seating structure; or
- (c) other structure prescribed under the *Building Act 2000*.

Tas Specification A1.3 STANDARDS ADOPTED BY REFERENCE

Insert in Table 1 the following:

TAS Table 1 SCHEDULE OF REFERENCED DOCUMENTS

| No. | Date | Title | BCA Clause(s) |
|-------------|------|---------------------------------------|---------------|
| AS 1187 | 1996 | Farm milk cooling and storage systems | Tas H107.3 |
| AS/NZS 1596 | 2008 | The storage and handling of LP Gas | Tas H120.4 |

TAS Table 1 SCHEDULE OF REFERENCED DOCUMENTS— continued

| No. | Date | Title | BCA Clause(s) |
|--------------------|------|--|----------------------------------|
| AS 1657 | 1992 | Fixed platforms, walkways, stairways and ladders — Design, construction and installation | Tas H113.3 |
| AS/NZS 1668 | | The use of ventilation and air-conditioning in buildings | |
| Part 1 | 1998 | Fire and smoke control in multi-compartment buildings | Tas H102.6 |
| AS 1668 | | The use of mechanical ventilation and air-conditioning in buildings | |
| Part 2 | 1991 | Mechanical ventilation for acceptable indoor-air quality | Tas H102.6 |
| AS/NZS 1680 | | Interior lighting | Tas H101.7 Tas H102.7 |
| Part 1 | 2006 | General principles and recommendations | |
| Part 2.1 | 2008 | Circulation spaces and other general areas | |
| Part 2.2 | 2008 | Office and screen based tasks | |
| Part 2.3 | 2008 | Education and training facilities | |
| Part 2.4 | 1997 | Industrial tasks and processes Amdt 1 | |
| Part 2.5 | 1997 | Hospitals and medical tasks | |
| AS 1940 | 2004 | The storage and handling of flammable and combustible liquids Amdt 1 Amdt 2 | Tas H120.4 |
| AS/NZS 2022 | 2003 | Anhydrous ammonia — storage and handling. Amdt 1 | Tas H120.4 |
| AS/NZS 2381 | | Electrical equipment for explosive atmospheres — Selection, installation and maintenance | Tas H120.9 |
| Part 1 | 2005 | General requirements Amdt 1 Amdt 2 Amdt 3 | |
| Part 2 | 2006 | Flameproof enclosure Amdt 1 | |
| Part 6 | 1993 | Increased safety | |

TAS Table 1 SCHEDULE OF REFERENCED DOCUMENTS— continued

| No. | Date | Title | BCA Clause(s) |
|--------------------------|-------------|--|----------------------------------|
| Part 7 | 1989 | Intrinsic safety | |
| AS/NZS 60079.10.1 | 2009 | Classification of hazardous areas- Explosive gas atmospheres | Tas H120.5 |
| AS 2507 | 1998 | The storage and handling of agricultural and veterinary chemicals | Tas H120.4 |
| AS 2658 | 2011 | LP Gas - Portable and mobile appliances Amdt 2 | Tas H123.14 |
| AS 2714 | 2008 | The storage and handling of organic peroxides | Tas H120.4 |
| AS 2746 | 2008 | Working areas for gas fuelled vehicles | Tas 124.2 |
| AS/NZS 2927 | 2001 | The storage and handling of liquefied chlorine gas Amdt 1 | Tas H120.4 |
| AS/NZS 3002 | 2008 | Electrical installations — shows and carnivals | Tas H123.13 |
| AS/NZS 3760 | 2010 | In-service safety inspection and testing of electrical equipment | Tas H123.13 |
| AS 3780 | 2008 | Storage and handling of corrosive substances Amdt 1 | Tas H120.4 |
| AS/NZS 4013 | 1999 | Domestic solid fuel burning appliances — Method for determination of flue gas emission | Tas G2.2, Tas H123.14 |
| AS/NZS 4114 | | Spray painting booths, designated spray painting areas, and paint mixing rooms | |
| Part 1 | 2003 | Design, construction and testing | Tas H118.2 |
| AS 4464 | 2007 | Hygienic production of game meat for human consumption | Tas H106.2 |
| AS 4465 | 2006 | Construction of premises and hygienic production of poultry meat for human consumption | Tas H106.2 |
| AS 4466 | 1998 | Hygienic production of rabbit meat for human consumption | Tas H106.2 |
| AS 4674 | 2004 | Design, construction and fit-out of food premises (Clauses 4.2 and 4.3) | Tas H102.12 |

TAS Table 1 SCHEDULE OF REFERENCED DOCUMENTS— continued

| No. | Date | Title | BCA Clause(s) |
|--|-------------|--|-----------------------------------|
| AS 4696 | 2007 | Hygienic production and transportation of meat and meat products for human consumption | Tas H106.2 |
| AS 5008 | 2007 | Hygienic rendering of animal products | Tas H106.2 |
| AS 5010 | 2001 | Hygienic production of ratite (emu/ostrich) meat for human consumption | Tas H106.2 |
| AS 5011 | 2001 | Hygienic production of natural casings for human consumption | Tas H106.2 |
| AS 5601 Set | 2010 | Gas Installations | Tas H120.4 |
| | | Aurora Energy's Distribution Substation Design and Construction Standard | Tas H119.1, Tas H119.2 |
| ADG7 Code | 2011 | Australian Dangerous Goods Code | Tas H120.1 |
| Child Care Act (Tas) | 2001 | | Tas A1.1, Tas H122.0 |
| Education and Care Services National Law (Application) Act | 2011 | | Tas A1.1, Tas H122.0 |
| Health Service Establishment Act | 2006 | | Tas H109.1 |
| Early Childhood Centre and School Age Care Facilities Code | 2012 | | Tas H122.0, Tas H122.1 |
| GHS | | Globally Harmonised System of Classification and Labelling | Tas H120.1 |
| Health Service Establishments Code | 2012 | | Tas H109.2 |
| Centre Based Care Class 4 Standards | 2012 | Tasmanian Licencing Standards for Centre Based Child Care Class 4 | Tas A1.1 |
| Centre Based Care Class 5 Standards | 2011 | Tasmanian Licencing Standards for Centre Based Child Care Class 5 (0-12 years) | Tas A1.1 |
| Export Control (Dairy Eggs and Fish) Orders | 2005 | | Tas H102.16 |
| Tasmania Code of Practice Hygienic Production of Pet Food | | | Tas H106.2 |

TAS Table 1 SCHEDULE OF REFERENCED DOCUMENTS— continued

| No. | Date | Title | BCA Clause(s) |
|--|------|---|---------------|
| Australian Road Research Board | 2009 | Unsealed Road Manual - Guidelines to good practice 3 rd Edition | Tas G5.3 |
| Disability Discrimination Act (Cwth) | 1992 | | Tas DP10 |
| Disability (Access to Premises – Buildings) Standards (Cwth) | 2010 | | Tas D3.13 |

SECTION D ACCESS AND EGRESS

After DP9 add Tas DP10

PERFORMANCE REQUIREMENTS

Tas DP10

A building or part of a building must be *accessible* in accordance with the requirements of a Standard made under the *Disability Discrimination Act 1992*.

PART D3 ACCESS FOR PEOPLE WITH A DISABILITY

Delete D3.0 Deemed-to-Satisfy Provisions and substitute:

Tas D3.0 Deemed-to-Satisfy Provisions

- (a) Where a *Building Solution* is proposed to comply with the *Deemed-to-Satisfy Provisions*, *Performance Requirements DP1 to DP9* and **Tas DP10** are satisfied by complying with—
- (i) **D1.1 to D1.16, D2.1 to D2.23, D3.1 to D3.12**, and **Tas D3.13**; and
 - (ii) in a building containing an *atrium*, **Part G3**; and
 - (iii) for theatres, *stages* and public halls, **Part H1**; and
 - (iv) for public transport buildings, **Part H2**.
- (b) Where a *Building Solution* is proposed as an *Alternative Solution* to the *Deemed-to-Satisfy Provisions* of—
- (i) **D1.1 to D1.16, D2.1 to D2.23, D3.1 to D3.12**, and **Tas D3.13**; and
 - (ii) in a building containing an *atrium*, **Part G3**; and
 - (iii) for theatres, *stages* and public halls, **Part H1**; and
 - (iv) for public transport buildings, **Part H2**,
- the relevant *Performance Requirements* must be determined in accordance with **A0.10**.

After D3.12 add Tas D3.13

Tas D3.13 Compliance with Premises Standards

- (a) A *Building Solution* must comply with the Disability (Access to Premises – Buildings) Standards 2010.
- (b) A *Building Solution* complies with **Tas D3.0(a)** if it complies with the applications, exceptions and concessions in the Disability (Access to Premises – Buildings) Standards 2010.

SECTION E SERVICES AND EQUIPMENT

PART E1 FIRE FIGHTING EQUIPMENT

After EO1(c) insert *Objective* Tas EO1(d) as follows:

| |
|-------------------|
| OBJECTIVES |
|-------------------|

Tas EO1

- (d) limit property and environmental damage caused by a fire.

After EF1.1 insert *Functional Statement* Tas EF1.2 as follows:

| |
|------------------------------|
| FUNCTIONAL STATEMENTS |
|------------------------------|

Tas EF1.2

A building is to be provided with a system to alert the *fire brigade* of a fire in the building.

After EP1.6 insert *Performance Requirement* Tas EP1.7 as follows:

| |
|---------------------------------|
| PERFORMANCE REQUIREMENTS |
|---------------------------------|

Tas EP1.7

An *automatic* fire detection system must be installed to the degree necessary to alert the *fire brigade* of fire so that fire fighting operations may be undertaken at the earliest possible time appropriate to—

- (a) the building functions and use; and
- (b) the *fire hazard*; and

- (c) the height of the building; and
- (d) the building *floor area*.

Limitation:

Tas E01(d), Tas EF1.2 and Tas EP1.7 only applies to:

- (a) a Class 5 building or Class 6 building having an aggregate *floor area* of more than 1000 m²; and
- (b) a Class 7 building having a *floor area* of more than 1000 m² in which furniture is stored; and
- (c) a Class 8 building which is a special *fire hazard* building and in which more than 25 persons are employed; and
- (d) a Class 9b building which is a *school* or *early childhood centre* or a creche which-
 - (A) is of more than 1 *storey*; or
 - (B) has a storey with a *floor area* more than 500 m²; and
- (e) a Class 9b building which is a theatre.

Delete E1.0 and insert Tas E1.0 as follows:

Tas E1.0 Deemed-to-Satisfy Provisions

Performance Requirements EP1.1 to EP 1.6 and **Tas EP1.7** are satisfied by complying with **E1.1 to E1.10** and **Tas E1.101**.

After E1.10 insert Tas E1.101 as follows:

Tas E1.101 Fire detection and alarm system

An *automatic* fire detection and alarm system must comply with **Clauses 4 and 7 of Specification E2.2a**.

SECTION F HEALTH AND AMENITY

PART F2 SANITARY FACILITIES

Tas Table F2.3 Sanitary Facilities in Class 3, 5, 6, 7, 8 and 9 Buildings

Delete the Note in Table F2.3 alongside *early childhood centres* and replace it with the following:

- Note: If the centre accommodates children under 4 years of age the facilities for use by those children must be—
- (a) junior pans; and
 - (b) wash basins with a rim height not exceeding 600 mm.

After F2.8 insert Tas F2.101 as follows:

Tas F2.101 Non-flushed Urinals

Non-flushed urinals not connected to a sewerage system must comply with **Tas F2.102**.

After Tas F2.101 insert Tas F2.102 as follows:

Tas F2.102 Installation of Closet Fixtures

- (a) If a sufficient sewerage system is not available, an authorised alternative means of disposal of sewage, may be installed.
- (b) If sanitary facilities are not water-flushed, the following provisions apply:
 - (i) A pit latrine, an incinerating toilet, a chemical toilet, a removable pan or a non-flushing urinal must not be within 2 m of a building containing habitable rooms.
 - (ii) The floor on which a removable pan is placed must be impervious.
 - (iii) A room containing a composting toilet must be separated from habitable rooms by way of a permanently ventilated air lock (which may be a circulation space).
 - (iv) The minimum ventilation *required* under **(iii)** shall be the greater of—
 - (A) 8000 mm²; or
 - (B) 1/500th of the *floor area* of the circulation space.
 - (v) Access for maintenance or removal of waste from a composting toilet must be by way of an access door which opens directly to the outside of the building.

PART F4 LIGHT AND VENTILATION

After F4.12 insert Tas F4.101 as follows:

Tas F4.101 Fixed Natural Ventilation

- (a) Except if mechanical ventilation or air-conditioning is provided, in rooms and areas listed in **Tas Table F4.101**, a fixed opening, of aggregate size not less than that shown in the Table, must be provided in addition to any adjustable opening.

TAS TABLE F4.101 FIXED NATURAL VENTILATION

| Building Class | Room to be ventilated | Size of fixed opening/floor area |
|-----------------------|--|---|
| 2, 3 and 4 | (i) Common stairways | 1/500 |
| | (ii) Communal laundries | 1/500 |
| 7 | Rooms for storage of polluting or noxious substances | 1/350 |
| 8 | All rooms | 1/500* |
| 9a | Store rooms | 1/500 |
| 9b | (i) Assembly halls in schools | 1/250 |
| | (ii) Workshops in schools | 1/250 |

TAS TABLE F4.101 FIXED NATURAL VENTILATION— *continued*

| Building Class | Room to be ventilated | Size of fixed opening/floor area |
|--|---|----------------------------------|
| Other than Class 2, 4 | (i) Pantries for food preparation rooms | 1/500 |
| | (ii) Washrooms | 1/500* |
| | (iii) Sanitary compartments | 1/350* |
| | (iv) Locker, meal and change rooms | 1/500* |
| | (v) Boiler rooms | 1/500* |
| | (vi) Plant, machinery rooms | 1/250* |
| | (vii) Electrical switchboard rooms | 1/250* |
| | (viii) Battery rooms (other than lead acid) | 1/500* |
| <p>Note: Not less than half of the fixed natural ventilation must be provided as high in the room as possible but not less than 2 m above the floor.</p> | | |

- (b) Fixed natural ventilation may be provided by means of—
 - (i) openings in walls, clear of obstructions other than louvres or grilles; or
 - (ii) ceiling ventilators, including skylights and roof ventilators.
- (c) Where a fixed ventilation opening is associated with a duct, that duct must have a clear open way at least twice the *required* area of the opening.
- (d) Openings for fixed natural ventilation must be placed so as to let air out and, if the air entering by or around doors or by other openings is insufficient for adequate ventilation, additional openings for the entry of air must be provided.

SECTION G ANCILLARY PROVISIONS

PART G1 MINOR STRUCTURES AND COMPONENTS

After GO1(b) insert *Objective* Tas GO1(c) to (i) as follows:

OBJECTIVES

Tas GO1(c)

- (c) safeguard young children from drowning or injury in a *swimming pool*; and

Application:

Tas GO1(c) only applies to a *swimming pool* associated with a Class 2 or 3 building or Class 4 part of a building, with a depth of water more than 300 mm.

Tas GO1(g)

safeguard people from illness or injury arising from the use of a *swimming pool*; and

Tas GO1(h)

safeguard people from illness or injury when using a way; and

Tas GO1(i)

protect a way.

Delete GF1.2(a) and insert *Functional Statements* Tas GF1.2(a) as follows:

FUNCTIONAL STATEMENTS**Tas GF1.2**

A *swimming pool* is to be provided with—

- (a) means of restricting access by young children to it; and

Application:

Tas GF1.2(a) only applies to a *swimming pool* associated with a Class 2 or 3 building or Class 4 part of a building, with a depth of water more than 300 mm.

After GF1.4 insert *Functional Statements* Tas GF1.5, Tas GF1.6 and Tas GF1.7 as follows:

Tas GF1.5

Swimming pools must provide for the health and safety of swimmers and others.

Tas GF1.6

Projections over ways must not pose a danger to persons using the way nor to adjoining buildings.

Tas GF1.7

Buildings located adjacent to a way must not unduly affect the integrity of the way.

Delete GP1.2(a) and insert Tas GP1.2(a) as follows:

PERFORMANCE REQUIREMENTS**Tas GP1.2**

- (a) A barrier must be provided to a *swimming pool* and must—
- (i) be continuous for the full extent of the hazard; and
 - (ii) be of a strength and rigidity to withstand the foreseeable impact of people; and

- (iii) restrict the access of young children to the pool and the immediate pool surrounds; and
- (iv) have any gates and doors fitted with latching devices not readily operated by young children, and constructed to automatically close and latch.

Application:

Tas GP1.2(a) only applies to a *swimming pool* associated with a Class 2 or 3 building or Class 4 part of a building, with a depth of water more than 300 mm.

After GP1.5 insert *Performance Requirements* Tas GP1.6 to Tas GP1.10 as follows:

Tas GP1.6

Swimming pools must be suitable and safe to use and be provided with appropriate facilities.

Limitation:

Tas GP1.6 does not apply to a *swimming pool* associated with a Class 2 building.

Tas GP1.7

Projections over ways must be constructed and located to provide safe passage along the way and reduce the spread of fire and the potential for collapse.

Tas GP1.8

Roofs of buildings and attachments to buildings must not allow stormwater to reach the way except by way of a drain.

Tas GP1.9

Excavations must be protected to prevent any part of a way from subsiding into them.

Tas GP1.10

Footings of a building must not project on to a way except if they are at sufficient depth.

Delete G1.0(b) and insert Tas G1.0(b) as follows:

Tas G1.0(b) Deemed-to-Satisfy Provisions

Performance Requirements **GP1.2** to **GP1.5** and **Tas GP1.6** to **Tas GP1.10** are satisfied by complying with **G1.1** and **G1.2**.

After G1.1(c) insert Tas G1.1(d) to (i) as follows:

Tas G1.1 Swimming Pools

- (d) *Swimming pools* for the use of the public, a club, or an association, or in connection with Class 3, 5, 6, 7, 8 or 9 buildings must—
 - (i) be constructed of durable materials with smooth finishes; and
 - (ii) have sides vertical; and

- (iii) in that part of the pool where the water depth is not more than 1.5 m, have the bottom or floor slope not steeper than 1 vertical to 15 horizontal; and
 - (iv) have the depth of water marked clearly and conspicuously on each side of the pool (at the shallow end and at the deep end); and
 - (v) not have diving boards installed where the water depth is less than 3.5 m; and
 - (vi) have scum-gutters with opening not less than 150 mm if they are to provide hand-holds; and
 - (vii) have the floor or bottom of the pool, except for the guide lines, of such colours that the light reflectance is not less than 60%.
- (e) For a public *swimming pool* or pool in which competitions are held—
- (i) all steps into the pool must be recessed; and
 - (ii) fittings must not project into the water area; and
 - (iii) piping must not be bracketed to the sides to provide hand-holds; and
 - (iv) surrounding concourses must be provided not less than 2 m wide, with a suitable non-slip surface, graded away from the pool and drained to waste; and
 - (v) dressing rooms with sanitary accommodation must be so located that bathers pass through that accommodation enroute to the *swimming pool*.
- (f) If the volume of a *swimming pool* exceeds 15 m³—
- (i) an adequate water recirculation, disinfection and filtration system must be installed; and
 - (ii) the inlet and outlet openings in a *swimming pool* for the purpose of water recirculation must be so located that water movement is continuous from inlet to outlet; and
 - (iii) * * * * *
 - (iv) recirculation of water in a *swimming pool* must be so designed that the pool contents are recirculated not less than once in the period shown in **Tas Table G1.1(f)**; and
 - (v) water filtration rates must not exceed 12 250 L/m² of sand filter bed per hour, or an equivalent rate in other filter media.

Tas TABLE G1.1(f) RECIRCULATION OF WATER IN SWIMMING POOLS

| Pool Type | Period |
|------------------------------|---------|
| Outdoor <i>Swimming pool</i> | 6 hours |
| Indoor <i>Swimming pool</i> | 4 hours |
| Wading Pool | 2 hours |

- (g) Where no other suitable sanitary accommodation is provided, sanitary facilities must be provided in accordance with **Tas Table G1.1(g)**.

TAS TABLE G1.1(g) SANITARY FACILITIES AT SWIMMING POOLS

| | Maximum Number Served by— | | | | | |
|---------|---------------------------|------------|---------|------------|-------------|------------|
| | Closet Fixtures | | Urinals | | Wash Basins | |
| | 1 | Each Extra | 1 | Each Extra | 1 | Each Extra |
| Males | 60 | 60 | 60 | 60 | 60 | 60 |
| Females | 40 | 40 | - | - | 60 | 60 |

(h) Where no other suitable shower facilities are provided, showers must be provided so that each shower serves up to 40 persons.

PART G2 HEATING APPLIANCES, FIREPLACES, CHIMNEYS AND FLUES

Delete *Objective* GO2(a) and insert Tas GO2(a) as follows:

Objective

Tas GO2

- (a) safeguard people from illness or injury caused by—
- (i) fire and emissions from combustion appliances installed within a building; and
 - (ii) malfunction of a pressure vessel installed within a building; and

Delete *Functional Statement* GF2.1 and insert Tas GF2.1 as follows:

FUNCTIONAL STATEMENT

Tas GF2.1

Combustion appliances using controlled combustion located in a building are to be installed in a way which reduces the likelihood of fire and harmful emissions spreading beyond the appliance.

Delete *Performance Requirement* GP2.1(c) and insert Tas GP2.1(c) as follows:

PERFORMANCE REQUIREMENT

Tas GP2.1

- (c) so that hot products of combustion will not—
- (i) escape through the walls of the associated components; and

- (ii) discharge in a position that will cause fire to spread to nearby *combustible* materials or allow smoke to penetrate through nearby *windows*, ventilation inlets, or the like; and
- (iii) in the case of solid-fuel burning appliances, be discharged above appropriate emission limits.

Delete G2.2(b) and insert Tas G2.2(b) as follows:

Tas G2.2 Installation of Appliances

- (b) Domestic solid-fuel burning appliances — Emissions: AS/NZS 4013
Installations: AS/NZS 2918.

G5 CONSTRUCTION IN BUSHFIRE PRONE AREAS

Delete *Objective* GO5 and insert Tas GO5 as follows:

Objective

Tas GO5

The *Objective* of this Part is to—

- (a) safeguard occupants from injury; and
- (b) protect buildings, from the effects of a bushfire; and
- (c) assist fire fighting access and occupant evacuation; and
- (d) ensure the availability of water for fire fighting purposes.

Application

Tas GO5 only applies to—

- (a) a Class 2 or 3 building; or
- (b) a Class 10a building or deck associated with a Class 2 or 3 building, located in a *designated bushfire prone area*.

Delete *Functional Statement* GF5.1 and insert Tas GF5.1 as follows:

FUNCTIONAL STATEMENT

Tas GF5.1

A building constructed in a *designated bushfire prone area* is to—

- (a) provide a resistance to bushfires in order to reduce the danger to life and minimise the risk of the loss of the building; and
- (b) be accessible for fire fighting and occupant evacuation; and
- (c) have access on the site to a water supply for fire fighting purposes.

Application

Tas FF5.1 only applies to—

- (a) a Class 2 or 3 building; or
- (b) a Class 10a building or deck associated with a Class 2 or 3 building, located in a *designated bushfire prone area*.

Delete *Performance Requirement* GP5.1 and insert Tas GP5.1 as follows:

PERFORMANCE REQUIREMENT**Tas GP5.1**

A building that is constructed in a *designated bushfire prone area* must, to the degree necessary, be designed and constructed to reduce the risk of ignition from a bushfire, appropriate to the—

- (a) potential for ignition caused by burning embers, radiant heat or flame generated by a bushfire; and
- (b) intensity of the bushfire attack on the building; and
- (c) be provided with vehicle access to the site to assist fire fighting and emergency personnel defend the building or evacuate occupants; and
- (d) provide access at all times to a sufficient supply of water for fire fighting purposes on the building site.

Application

Tas GP5.1 only applies to—

- (a) a Class 2 or 3 building; or
- (b) a Class 10a building or deck associated with a Class 2 or 3 building, located in a *designated bushfire prone area*.

Add *Deemed-to-Satisfy Provisions* Tas G5.3 and Tas G5.4 as follows:

Deemed-to-Satisfy Provisions

Tas G5.3 Vehicular access

- (a) A Class 2 or 3 building in a *designated bushfire prone area* and the fire fighting water supply access point must be accessible by a private access road which is designed, constructed and maintained to a standard not less than a Modified 4C Access Road.
- (b) **A Modified 4C Access Road** is an all weather road which complies with the Australian Road Research Board "Unsealed Road Manual - Guidelines to good practice", 3rd Edition, March 2009 as a classification 4C Access Road and the following modified requirements:
- (i) Single lane private access roads less than 6 m carriageway width must have 20 m long passing bays of 6 m carriageway width, not more than 100 m apart;
 - (ii) A private access road longer than 100 m, must be provided with a driveway encircling the building or a hammerhead "T" or "Y" turning head 4 m wide and 8 m long, or a trafficable circular turning area of 10 m radius;
 - (iii) Culverts and bridges must be designed for a minimum vehicle load of 20 tonnes; and
 - (iv) Vegetation must be cleared for a height of 4 m, above the carriageway, and 2 m each side of the carriageway.

Tas G5.4 Water Supply

- (a) The external elements of a Class 2 or 3 building in a *designated bushfire prone area* must be within reach of a 120 m long hose connected to:
- (i) a fire hydrant with a minimum flow rate of 600 L per minute and minimum pressure of 200 kPa; or
 - (ii) a stored water supply in a water tank, *swimming pool*, dam or lake available for fire fighting at all times which has a capacity of at least 10,000 L for each separate building.
- (b) A water tank and above ground pipes and fittings used for a stored water supply must be made of non-rusting, *non-combustible*, non-heat-deforming materials and must be situated more than 6 m from a building.
- (c) The water tank must have an opening in the top of not less than 250 mm diameter or be fitted with a male 64 mm 5v thread coupling capable of delivering 270 L per minute.

After Part G5 insert Tas Part G101 as follows:

TAS PART G101 PROJECTIONS OVER WAYS

Tas G101.1 Construction and location of projections over ways

- (a) In this Part the following meanings apply:

Awning means a cover projecting from a building to provide shelter or shade for people outside the building.

Balcony means a permanent projection from a building, designed to be walked, stood or sat on, and which is not roofed.

Kerb-line means the line of the carriageway edge of the kerb or, where there is no kerb, the line of the carriageway edge of the kerb if there was one.

Verandah means a permanent, roofed projection from a building, designed to be walked, stood or sat on.

Way includes a public road, street, alley or footpath.

- (b) Every bridge connecting buildings over a *way* must be of *non-combustible* material.
- (c) Every *awning* and *balcony* which projects over a *way* must be supported entirely from the building to which it is attached.
- (d) A *verandah* must not project over a *way*.
- (e) Every part of a building which projects over a *way* must comply with **Tas Table G101.1**.

Tas TABLE G101.1 PROJECTIONS OVER WAYS

| | |
|---|--|
| Heights above ground or footpath level: | |
| <i>Awnings</i> | 2.7 m |
| Shades or sunblinds (when not in use), signs, lamps or the like. | 2.4 m |
| Other projections | 3.0 m |
| Maximum Distance of projection over a way: | |
| <i>Awnings</i> — | |
| (i) <i>non-combustible</i> | not beyond a line 450 mm from the plumb of the kerb-line |
| (ii) <i>combustible</i> | 1.0 m |
| <i>Balconies</i> — | |
| | 1.0 m |
| Other projections— | |
| (i) in streets more than 15 m wide | 900 mm |
| (ii) in streets not more than 15 m wide | 600 mm |
| Note: | |
| (i) A door, gate, <i>window</i> , sash, or shutter is not deemed to open outwards unless, when open to its utmost extent, some part of it projects beyond the boundary line of the <i>way</i> . | |
| (ii) The total width of all the oriel <i>windows</i> and turrets projecting onto a <i>way</i> in any wall of any <i>storey</i> of a building, taken together, must not exceed 3/5 of the length of that wall on the level of that <i>storey</i> . | |

- (f) Any *combustible awning* which projects over a *way* must not extend to within 1.5 m of an adjoining building.

After Tas G101.1 insert Tas G101.2 as follows:

Tas G101.2 Protection of Ways

- (a) Every roof of a building, and every *verandah*, *balcony*, or other similar projection or projecting *window* must be so designed and built as to prevent stormwater from it from dropping on, running over, or seeping under any *way*.

- (b) The roof of any *awning* that extends more than 1.0 m over a *way* must be drained to a down pipe.
- (c) Down pipes from *awnings*—
 - (i) must not project beyond the boundary of a *way*; and
 - (ii) must be of steel or provided with a protective cover to a height of 2 m from the path.
- (d) Any excavation must be protected, by shoring or otherwise, as necessary to prevent subsidence into the excavation of any part of a *way* adjoining it.
- (e) Footings must not extend beyond the boundary of a *way* other than as shown in **Tas Table G101.2**.

Tas TABLE G101.2 PROJECTION OF FOOTINGS

| Depth of top of footing below ground level | Maximum permissible projection |
|--|--------------------------------|
| Less than 1.3 m | Nil |
| 1.3 m to 3.0 m | 450 mm |
| Exceeding 3.0 m | 750 mm |

SECTION H SPECIAL USE BUILDINGS

Insert *Objectives* for Tas Part H101 as follows:

OBJECTIVES

Tas Part H101 Workplaces

Every workplace must be constructed in a manner that will provide for the safety, health and welfare of workers using that workplace.

Tas Part H102 * * * * *

This clause has deliberately been left blank.

Insert *Objectives* for Tas Part H103 as follows:

Tas Part H103 Dining Rooms and Bar Rooms

Dining rooms and bar rooms must provide for the comfort, convenience and health of customers.

Tas Part H104 * * * * *

This clause has deliberately been left blank.

Tas Part H105 * * * * *

This clause has deliberately been left blank.

Insert *Objectives* for Tas Part H106 as follows:

Tas Part H106 Meat Premises

Meat premises must be constructed in such a manner that—

- (a) does not jeopardise animal welfare; and
- (b) provides for hygienic processing of animals; and
- (c) ensures the wholesomeness of meat and meat products.

Insert *Objectives* for Tas Part H107 as follows:

Tas Part H107 Farm Dairy Premises

Dairies must be constructed in such a manner that contamination of milk can be avoided.

Insert *Objectives* for Tas Part H108 as follows:

Tas Part H108 Pharmacies

Pharmacies must be able to be secured against entry and the interior must be able to be supervised by a pharmacist.

Insert *Objectives* for Tas Part H109 as follows:

Tas Part H109 Health Service Establishments

Health service establishments must be able to be easily cleaned and must have adequate space for patients.

Insert *Objectives* for Tas Part H110 as follows:

Tas Part H110 Premises Used for Activities Involving Skin Penetration

Premises used for activities involving skin penetration must provide for cleanliness of staff and comfort of customers.

Insert *Objectives* for Tas Part H111 as follows:

Tas Part H111 Dental Surgeries and Chiropractors' Premises

Dental surgeries and chiropractors' premises must be able to be easily cleaned and must have a waiting room for patients.

Insert *Objectives* for Tas Part H112 as follows:

Tas Part H112 Mortuaries

Mortuaries must be constructed in a manner that will ensure the health of staff and the general public.

Insert *Objectives* for Tas Part H113 as follows:

Tas Part H113 Foundries

Foundries must provide for the comfort and safety of workers on the premises.

Insert *Objectives* for Tas Part H114 as follows:

Tas Part H114 Premises for Manufacture or Processing of Glass Reinforced Plastic

Premises for manufacture or processing of glass reinforced plastic must—

- (a) provide for the safety and comfort of workers; and
- (b) be constructed in a manner that will avoid the spread of fire within the building and to other buildings.

Insert *Objectives* for Tas Part H115 as follows:

Tas Part H115 Premises for the Production or Processing of Isocyanates

Premises for the production or processing of isocyanates must—

- (a) provide for the safety and comfort of workers; and
- (b) be constructed in a manner that will avoid the spread of fire within the building and to other buildings.

Insert *Objectives* for Tas Part H116 as follows:

Tas Part H116 Premises for Electro-plating, Electro-polishing, Anodising or Etching

Premises for electro-plating, electro-polishing, anodising or etching must—

- (a) provide for the safety and comfort of workers; and
- (b) be constructed in a manner that will prevent the escape of liquids and atmospheric contaminants to other areas of the building.

Insert *Objectives* for Tas Part H117 as follows:

Tas Part H117 Premises for Lead Processing

Premises for lead processing must—

- (a) provide for the safety and comfort of workers; and
- (b) be constructed in a manner that will minimise the lodgement of dust and must be capable of being flushed with water.

Insert *Objectives* for Tas Part H118 as follows:

Tas Part H118 Booths for Spray-painting or Spray-coating

Booths for spray-painting or spray-coating must—

- (a) be constructed of *non-combustible* materials; and
- (b) have adequate means of escape; and

- (c) have suitable means of extracting harmful fumes from the booth.

Insert *Objectives* for Tas Part H119 as follows:

Tas Part H119 Electricity Distribution Substations

Building-type electricity distribution substations must be housed in buildings that are tamper-proof, vermin-proof and weatherproof, and have adequate means of escape.

Insert *Objectives* for Tas Part H120 as follows:

Tas Part H120 Premises for Storage of Dangerous Goods

Premises for storage of dangerous goods must—

- (a) provide for the safety and comfort of workers in the premises; and
- (b) be constructed so as not to be a danger to other people or buildings.

Insert *Objectives* for Tas Part H121 as follows:

Tas Part H121 Hairdressers' Premises

Hairdressers' premises must be of adequate size and amenity.

After Part H1 insert Tas Part H101 as follows:

TAS PART H101 WORKPLACES

Tas H101.1 Application of Part

This Part is applicable to every building or part of a building used as a workplace.

Tas H101.2 Floor area

- (a) The *floor area* of each office must be 7 m² or sufficient to provide 4 m² for each occupant, whichever is the greater.
- (b) Each floor plan dimension of any room which is a workplace must be greater than 2.5 m.

Tas H101.3 Floor surfaces

- (a) Every floor in a work place must have an even, unbroken slip-resistant surface, free from holes, indentations, projections or other obstructions that might create tripping or stumbling hazards.
- (b) Where the nature of the process is such that spillage of liquids is likely to occur, or where it is necessary for the floors to be cleansed with water or other liquids—
 - (i) the floors must be surfaced with materials that are impervious to the penetration of liquids likely to be spilt or used in the process of cleaning; and
 - (ii) the joints between the floors and the walls must be sealed with an impervious material and finished in such a manner that the joint is concavely rounded.

Tas H101.4 Floor drainage

- (a) Floors in a workplace must be graded to drain off liquids which must be carried away and disposed of by means of open paved channels, covered drains or pipes.
- (b) Floors graded as shown in **Tas Table H101.4** satisfy (a).

Tas TABLE H101.4 SLOPES OF FLOORS FOR DRAINAGE

| | |
|---------------------------|-------|
| Wash (or hose-down) areas | 1:25 |
| Wet (or mop-down) areas | 1:50 |
| Dry areas | 1:100 |

- (c) Where the effluent from drains is likely to be offensive it must be intercepted by suitable deodorising tanks.
- (d) Wherever practicable, drains to carry off spilt liquids should be planned so that the liquids are intercepted close to the point of spillage and not allowed to spread over the working surface of the floor.

Tas H101.5 Floor covering

- (a) Where workers stand in substantially the one location while working on a floor of brick, metal, stone or other similar material, those floors or sections thereof, must be covered with—
 - (i) wood, rubber, linoleum, resilient types of plastic tiles; or
 - (ii) suitable compositions containing asphalt, rubber, cork, magnesite; or
 - (iii) other semi-resilient, thermally non-conductive materials on which the workers may stand.
- (b) Fixed coverings for local sections of floors must be inset flush with the main floor.

Tas H101.6 Overhead clearance

Pipes, fixtures and similar objects running above a passage or walkway must be fixed at a height to provide a clear distance not less than 2.1 m measured from the floor to the lowest part of the object.

Tas H101.7 Lighting

Interior lighting in a workplace must comply with the relevant requirements of AS 1680 Parts 1, 2.1, 2.2, 2.3, 2.4 and 2.5.

Tas H101.8 Ventilation

Every workplace must be ventilated to remove offensive gases, vapours, fumes, dust or other airborne impurities.

Tas H101.9 Toilet facilities

- (a) Where practicable, toilet facilities must be located in the same building as the workplace or change room that they serve.

- (b) Toilet facilities which are not located in the same building as the workplace they serve must—
 - (i) be sited within the boundary of the premises; and
 - (ii) be housed in a fully roofed and clad building; and
 - (iii) be located at a distance not greater than 100 m from any workplace they serve; and
 - (iv) have provided, at every entrance doorway giving direct access to the interior of the building, a full length door fitted with a suitable locking device.
- (c) Every closet must be fitted with a door capable of being fastened on the inside.

Tas H101.10 Hand washing facilities

- (a) Hand washing facilities must be located in change rooms or in wash rooms accessible to change rooms and must be placed where they can be conveniently used by persons before eating meals and after using toilet facilities.
- (b) Where hand washing facilities are located in a change room, the *floor area* allowed for the change room must be increased by the area *required* for the washing equipment and its use.
- (c) Hand washing facilities include wash basins, wash troughs and circular ablution fountains.

Tas H101.11 Shower facilities

- (a) Where the work engaged upon is such that a change of clothing is necessary, showers with hot and cold running water must be provided at the rate of not less than shown in **Tas Table H101.11**.

Tas TABLE H101.11 SHOWERS IN WORK PLACES

| | |
|-----------------------------------|--------------------------|
| Hot, arduous or dirty industries: | 1 for every 10 employees |
| Light, clean industries: | 1 for every 25 employees |

- (b) Shower rooms must be located immediately adjacent to change rooms and urinal facilities, but urinal facilities may be provided in male shower rooms.
- (c) Separate and distinct shower accommodation must be provided for male and female employees.
- (d) Showers must have—
 - (i) a *floor area* of not less than 1.8 m²; and
 - (ii) a slip-resistant surface that is capable of being sanitised; and
 - (iii) partitions between each shower that are at least 1650 mm high and no more than 300 mm above the floor; and
 - (iv) an adjacent dressing area for each shower containing a seat and hooks; and
 - (v) a lockable door enclosing the shower and dressing cubicle.

Tas H101.12 Change rooms

Where workers have to change in and out of clothing due to the nature of the work, change rooms must be provided in compliance with **Tas Table H101.12**.

Tas TABLE H101.12 CHANGE ROOMS

| | |
|--|--------------------|
| Minimum clear space- | |
| for each person requiring to change clothes: | 0.5 m ² |
| Minimum free floor space- | |
| between lockers facing one another: | 1.8 m |
| between locker face and a wall or seat: | 1.0 m |

Tas H101.13 Dining rooms

- (a) In any work place which is a factory or shop a dining area or dining room must be provided as set out in [Tas Table H101.13](#).

Tas TABLE H101.13 DINING AREAS AND DINING ROOMS

| |
|---|
| For 10 or less employees: a suitable dining area separate from any working area: Dining areas must be provided with adequate and hygienic facilities for the washing of eating utensils and for the storage of utensils where they will be protected from dust or vermin. |
| For more than 10 employees: a conveniently located dining room separate from any work room or work area: Dining rooms must be equipped with a dish washing sink supplied with hot and cold water, draining board and cupboards in which foodstuffs and crockery can be stored free from dust and vermin, except that the provision of running water shall not apply where a reticulated water service cannot be made available. |
| NOTE: Where up to 15 persons of the same sex are employed, a combined change room/dining room may be provided. |

- (b) Dining rooms must have 1 m² clear space (free of furniture, fittings or obstructions) for each person likely to use the dining room at any one time.
- (c) In buildings to be used as offices, there must be provided on each *storey*, in a location accessible to all tenants, an area containing a dish washing sink supplied with hot and cold water, cupboard storage for food stuffs and utensils, and facilities for boiling water. Such areas must not be located in toilets, wash-rooms, or change rooms.

Tas H101.14 Rest rooms

Where 20 or more females are employed, a separate rest room, with convenient access to sanitary accommodation, must be provided in accordance with [Tas Table H101.14](#).

Tas TABLE H101.14 FLOOR AREAS OF REST ROOMS

| | | | | | |
|---------------------------------------|--|-----|-----|-----|-----------------|
| m ² of <i>floor area</i> : | 6 | 9 | 12 | 15 | Each extra 3 |
| Max. number of females served: | 100 | 200 | 300 | 400 | 200 |
| NOTE: | Where a first aid room or health centre is provided the rest room may be adjacent to it or part of it. | | | | |

Tas H101.15 First aid rooms and health centres

- (a) In every workplace, other than a shop or office, where the number of employees working on the premises exceeds 300 at any time, a self-contained health centre must be provided, at ground level if practicable, with *floor area* not less than 45 m², which includes—
- (i) treatment room with a *floor area* of at least 14 m²; and
 - (ii) separate waiting room; and
 - (iii) separate recovery room; and
 - (iv) separate combined office and consulting room; and
 - (v) toilet with air lock and washbasin with clean, hot and cold, running water; and
 - (vi) store room or adequate storage cupboards; and
 - (vii) walls, floors and ceilings impervious to moisture, easy to clean, free from cracks, ledges and sharp angles and finished in a light colour.
- (b) In every workplace where the number of employees exceeds 100 at any time and where a health centre has not been provided, a first aid room must be provided, suitably located with convenient access, readily accessible to sanitary accommodation, having a *floor area* not less than 14 m² and clearly marked “FIRST AID”.
- (c) A first aid room must be well lit and ventilated, have an entry door width not less than 1 m, an examination couch, a table or desk and a chair, a cupboard for storage, power points and a telephone or emergency call system.

Tas H101.16 Doors

- (a) **Roller-shutter door:** Every power operated, roller-shutter door must be fitted with a continuous-pressure, manual switch for control of downward movement.
- (b) **Automatic-closing doors:** A suitable switch, controlled by a photoelectric device, must be fitted to stop or reverse the closing travel if a person or object should obtrude into the line of travel of the closing door.
- (c) **Sliding-door:** Every sliding door must be installed in such a manner that it will not derail or over-run its normal travel.

After Tas Part H101 insert Tas Part H102 as follows:

TAS PART H102 FOOD PREMISES

OBJECTIVE

Tas H102 O1

The *Objective* of this Part is to facilitate the safe manufacture, preparation, storage or packing of food for sale for human consumption.

Application:

- (a) **Tas H102 O1** applies to any premises where food intended for human consumption is manufactured, processed or sold and to which the following apply—
- (i) *Food Act 2003*; or
 - (ii) *Liquor and Accommodation Act 1990*.
- (b) **Tas H102 O1** includes, but is not limited to—
- (i) bakehouses; and
 - (ii) bar service areas; and
 - (iii) premises for boning, curing, canning, mincing, pre-packing or other similar processes of preparation of meat for sale; and
 - (iv) retail meat premises; and
 - (v) eating houses and tea shops; and
 - (vi) fish shops; and
 - (vii) kitchens in eating houses, restaurants, guest houses, motels and hotels; and
 - (viii) rooms for processing, manufacturing, packing, etc of fruit and vegetables, dairy products, ice blocks, ices, meat-for-sale, or other fish; and
 - (ix) shellfish processing premises; and
 - (x) take-away-food stores; and
 - (xi) breweries and wineries.
- (c) In **Tas H102 O1**, words and meanings as defined in the *Food Act 2003*, *Food Standards Code* and *Liquor and Accommodation Act 1990* apply.

Limitations:

Tas H102 O1 does not apply to—

- (a) domestic dwellings classified as Class 1 buildings; or
- (b) boarding houses or the like classified as Class 1 buildings; or
- (c) tents, buildings or other structures used temporarily for serving meals to the public at any fair, show, race meeting or other public sports, games or amusements; or
- (d) dairies covered by **Tas H107**; or
- (e) live shellfish premises where live shellfish are being packed or handled for transport or transferral to shellfish processing premises; or
- (f) premises that only sell pre-packaged food that is not potentially hazardous.

FUNCTIONAL STATEMENT**Tas H102 F1**

Each building or part of a building constructed as a food premise must be able to be used in such a manner that minimises opportunities for food contamination.

Application:

- (a) **Tas H102 F1** applies to any premises where food intended for human consumption is manufactured, processed or sold and to which the following apply—
- (i) *Food Act 2003*; or
 - (ii) *Liquor and Accommodation Act 1990*.
- (b) **Tas H102 F1** includes, but is not limited to—
- (i) bakehouses; and
 - (ii) bar service areas; and
 - (iii) premises for boning, curing, canning, mincing, pre-packing or other similar processes of preparation of meat for sale; and
 - (iv) retail meat premises; and
 - (v) eating houses and tea shops; and
 - (vi) fish shops; and
 - (vii) kitchens in eating houses, restaurants, guest houses, motels and hotels; and
 - (viii) rooms for processing, manufacturing, packing, etc of fruit and vegetables, dairy products, ice blocks, ices, meat-for-sale, or other fish; and
 - (ix) shellfish processing premises; and
 - (x) take-away-food stores; and
 - (xi) breweries and wineries.
- (c) In **Tas H102 F1**, words and meanings as defined in the *Food Act 2003*, *Food Standards Code* and *Liquor and Accommodation Act 1990* apply.

Limitations:

Tas H102 F1 does not apply to—

- (a) domestic dwellings classified as Class 1 buildings; or
- (b) boarding houses or the like classified as Class 1 buildings; or
- (c) tents, buildings or other structures used temporarily for serving meals to the public at any fair, show, race meeting or other public sports, games or amusements; or
- (d) dairies covered by **Tas H107**; or
- (e) live shellfish premises where live shellfish are being packed or handled for transport or transferral to shellfish processing premises; or
- (f) premises that only sell pre-packaged food that is not potentially hazardous.

PERFORMANCE REQUIREMENTS**Tas H102 P1**

The design and construction of food premises must—

- (a) be appropriate for the activities for which the premises are used; and
- (b) provide adequate space for the activities to be conducted on the food premises and for the fixtures, fittings and equipment used for those activities; and

- (c) permit the food premises to be effectively cleaned and, if necessary, sanitized; and
- (d) to the extent that is practicable:
 - (i) exclude dirt, dust, odours, fumes, smoke and other contaminants; and
 - (ii) not permit the entry of pests; and
 - (iii) not provide harbourage for pests.

Tas H102 P2

- (a) Food premises must have an adequate supply of water if water is to be used at the food premises for any of the activities conducted on the food premises.
- (b) A food business must use potable water for all activities that use water that are conducted on the food premises.

Limitation:

If a food business demonstrates that the use of non-potable water for a purpose will not adversely affect the safety of the food handled by the food business, subclause (b) does not apply.

Tas H102 P3

Food premises must have a sewage and waste water disposal system that—

- (a) will effectively dispose of all sewage and waste water; and
- (b) is constructed and located so that there is no likelihood of the sewage and waste water polluting the water supply or contaminating food.

Tas H102 P4

Food premises must have facilities for the storage of garbage and recyclable matter that—

- (a) adequately contain the volume and type of garbage and recyclable matter on the food premises; and
- (b) enclose the garbage or recyclable matter, if this is necessary to keep pests and animals away from it; and
- (c) are designed and constructed so that they may be easily and effectively cleaned.

Tas H102 P5

Food premises must have sufficient natural or mechanical ventilation to remove fumes, smoke and vapours from the food premises.

Tas H102 P6

Food premises must have lighting systems that provide sufficient natural or artificial light for the activities conducted on the food premises.

Tas H102 P7

- (a) Floors must be designed and constructed in a way that is appropriate for the activities conducted on the food premises.

- (b) Floor must—
- (i) be able to be effectively cleaned; and
 - (ii) be unable to absorb grease, food particles or water; and
 - (iii) be laid so that there is no ponding of water; and
 - (iv) to the extent that is practicable, be unable to provide harbourage for pests.

Application:

The requirements for floors apply to the floors of all areas used for food handling, cleaning, sanitizing and personal hygiene except the following areas—

- (a) dining areas; and
- (b) drinking areas; and
- (c) other areas to which members of the public usually have access.

Limitation:

The following floors do not have to comply with sub-clause (b)—

- (i) floors of temporary food premises, including ground surfaces, that are unlikely to pose any risk of contamination of food handled on the food premises; and
- (ii) floors of food premises that are unlikely to pose any risk of contamination of food handled on the food premises provided the food business has obtained approval for their use.

Tas H102 P8

Walls and ceilings—

- (a) must be designed and constructed in a way that is appropriate for the activities conducted on the food premises; and
- (b) must be provided where they are necessary to protect food from contamination; and
- (c) provided in accordance with sub-clause (b) must be—
 - (i) sealed to prevent the entry of dirt, dust and pests; and
 - (ii) unable to absorb grease, food particles or water; and
 - (iii) be able to be easily and effectively cleaned; and
- (d) must—
 - (i) be able to be effectively cleaned; and
 - (ii) to the extent that is practicable, be unable to provide harbourage for pests.

Application:

The requirements for walls and ceilings apply to the walls and ceilings of all areas used for food handling, cleaning, sanitizing and personal hygiene except the following areas—

- (a) dining areas; and
- (b) drinking areas; and
- (c) other areas to which members of the public usually have access.

Tas H102 P9

- (a) Food premises must have hand washing facilities that are located where they can be easily accessed by food handlers—
 - (i) within areas where food handlers work if their hands are likely to be a source of contamination of food; and
 - (ii) if there are toilets on the food premises—immediately adjacent to the toilets or toilet cubicles.
- (b) Hand washing facilities must be—
 - (i) permanent fixtures; and
 - (ii) provided with a supply of warm running potable water; and
 - (iii) of a size that allows easy and effective hand washing; and
 - (iv) clearly designated for the sole purpose of washing hands, arms and face.

Tas H102 P10

Fixtures, fittings and equipment must—

- (a) be adequate for the production of wholesome food; and
- (b) be fit for their intended use; and
- (c) be designed, constructed, located and installed, and equipment must be located and, if necessary, installed, so that—
 - (i) there is no likelihood that they will cause food contamination; and
 - (ii) they are able to be easily and effectively cleaned; and
 - (iii) adjacent floors, walls, ceilings and other surfaces are able to be easily and effectively cleaned; and
 - (iv) to the extent that is practicable, they do not provide harbourage for pests; and
- (d) have food contact surfaces—
 - (i) able to be easily and effectively cleaned and, if necessary, sanitized if there is a likelihood that they will cause food contamination; and
 - (ii) unable to absorb grease, food particles and water if there is a likelihood that they will cause food contamination; and
 - (iii) made of a material that will not contaminate food.

Tas H102 P11

Food premises must have adequate storage facilities—

- (a) for the storage of items that are likely to be the source of contamination of food, including chemicals, clothing and personal belongings; and
- (b) located where there is no likelihood of stored items contaminating food or food contact surfaces.

Tas H102 P12

All refrigerated or cooling chambers must be constructed so that stored products will not be contaminated.

Application:

- (a) **Tas H102 P1 to P12** applies to any premises where food intended for human consumption is manufactured, processed or sold and to which the following apply—
- (i) *Food Act 2003*; or
 - (ii) *Liquor and Accommodation Act 1990*.
- (b) **Tas H102 P1 to P12** includes, but is not limited to—
- (i) bakehouses; and
 - (ii) bar service areas; and
 - (iii) premises for boning, curing, canning, mincing, pre-packing or other similar processes of preparation of meat for sale; and
 - (iv) retail meat premises; and
 - (v) eating houses and tea shops; and
 - (vi) fish shops; and
 - (vii) kitchens in eating houses, restaurants, guest houses, motels and hotels; and
 - (viii) rooms for processing, manufacturing, packing, etc of fruit and vegetables, dairy products, ice blocks, ices, meat-for-sale, or other fish; and
 - (ix) shellfish processing premises; and
 - (x) take-away-food stores; and
 - (xi) breweries and wineries.
- (c) In **Tas H102 P1 to P12**, words and meaning as defined in the *Food Act 2003*, *Food Standards Code* and *Liquor and Accommodation Act 1990* apply.

Limitations:

Tas H102 P1 to P12 do not apply to—

- (a) domestic dwellings classified as Class 1 buildings; or
- (b) boarding houses or the like classified as Class 1 buildings; or
- (c) tents, buildings or other structures used temporarily for serving meals to the public at any fair, show, race meeting or other public sports, games or amusements; or
- (d) dairies covered by **Tas H107**; or
- (e) live shellfish premises where live shellfish are being packed or handled for transport or transferral to shellfish processing premises; or
- (f) premises that only sell pre-packaged food that is not potentially hazardous.

| |
|-------------------------------------|
| DEEMED-TO-SATISFY PROVISIONS |
|-------------------------------------|

Tas H102.0 Application of Part

- (a) This Part applies to any premises where food intended for human consumption is manufactured, processed or sold and to which the following apply—
- (i) *Food Act 2003*; or
 - (ii) *Liquor and Accommodation Act 1990*.
- (b) This Part includes, but is not limited to—
- (i) bakehouses; and
 - (ii) bar service areas; and
 - (iii) premises for boning, curing, canning, mincing, pre-packing or other similar processes of preparation of meat for sale; and
 - (iv) retail meat premises; and
 - (v) eating houses and tea shops; and
 - (vi) fish shops; and
 - (vii) kitchens in eating houses, restaurants, guest-houses, motels and hotels; and
 - (viii) rooms for processing, manufacturing, packing, etc of fruit and vegetables, dairy products, ice blocks, ices, meat-for-sale or other fish; and
 - (ix) shellfish processing premises; and
 - (x) take-away-food stores; and
 - (xi) breweries and wineries.
- (c) This Part does not apply to—
- (i) boarding houses or the like classified as Class 1 buildings; or
 - (ii) tents, buildings or other structures used temporarily for serving meals to the public at any fair, show, race meeting or other public sports, games or amusements; or
 - (iii) dairies covered by **Tas Part H107**; or
 - (iv) live shellfish premises where live shellfish are being packed or handled for transport or transferral to shellfish processing premises; or
 - (v) premises that only sell pre-packaged food that is not potentially hazardous.
- (d) In this Part, words and meanings as defined in the *Food Act 2003*, *Food Standards Code* and *Liquor and Accommodation Act 1990* apply.

Tas H102.1 Deemed-to-Satisfy Provisions

Performance Requirements Tas H102 P1 to *Tas H102 P12* are satisfied by complying with the relevant provisions of **Tas H102.0** to **Tas H102.17**.

Tas H102.2 General Requirements

- (a) The provision of—
- (i) close-fitting windows and doors; and

- (ii) air intakes that do not draw in contaminated air; and
 - (iii) air locks and self-closing doors to separate toilet areas, laundries and living areas from food handling areas; or
 - (iv) mechanical ventilation that removes sources of contamination, satisfies **Tas H102 P1(d)(i)**.
- (b) The provision of—
- (i) self-closing or pest-screened external doors; and
 - (ii) mesh screens at opening windows or other ventilation openings; and
 - (iii) sealing to drains, grease traps and ventilation pipes; and
 - (iv) sealing to openings where pipes pass through external walls; and
 - (v) the installation of pest-proof flashings to doors, satisfies **Tas H102 P1(d)(ii)**.
- (c) The provision of—
- (i) vermin-proof sealing; or
 - (ii) filling; or
 - (iii) access for inspection and cleaning of boxed-in areas, satisfies **Tas H102 P1(d)(iii)**.
- (d) The provision of a reticulated water supply from—
- (i) a regulated entity; or
 - (ii) a private water supply with on-site treatment, which meets the Australian Drinking Water Guidelines, satisfies **Tas H102 P2(b)**.

Note: 'Regulated entity' has the same meaning as the Plumbing Regulations 2004.

Tas H102.3 Pests and contaminants

Premises where customers are served outside the premises through an opening, that has an appliance for the elimination of flies and mechanical ventilation adequate to exhaust air through the opening at a rate of not less than 5 litres per second for each square metre of opening, satisfies **Tas H102 P1(d)**.

Tas H102.4 Drains and Pipes

Premises satisfy **Tas H102 P3** where—

- (a) A grease trap, a gully trap or an untrapped opening connected directly with a drain or sewer, is not installed in a room used for preparation, processing, packing or storing of food for sale; and
- (b) as far as is practicable, service pipes are concealed beneath the surface of walls, floors or ceilings, or are fixed clear of the wall, floor or ceiling, at such distance as to facilitate cleaning.

Tas H102.5 Offensive material and trade waste

Where offensive material or trade waste is stored, a separate area or room which—

- (a) is paved and easily cleanable; and
 - (b) is graded to drain to a suitable drainage system; and
 - (c) has available a supply of water under pressure,
- satisfies [Tas H102 P4](#).

Tas H102.6 Ventilation

A mechanical ventilating exhaust system complying with the requirements of AS/NZS 1668.1 and AS 1668.2 satisfies [Tas H102 P5](#).

Tas H102.7 Lighting

- (a) A lighting system that complies with AS 1680.1 and AS/NZS 1680.2.4 satisfies [Tas H102 P6](#).
- (b) In areas where open food is handled or stored, light fittings which are—
 - (i) designed and constructed to prevent contamination of food should the globe or tube shatter; and
 - (ii) free from any features that would harbour dirt, dust, or insects or make the fitting difficult to clean,satisfies [Tas H102 P6\(b\)\(i\)](#).

Tas H102.8 Floors, walls and ceilings

- (a) Floors, walls and ceilings constructed in accordance with Section 3 of AS 4674 (2004), satisfy [Tas H102 P7](#) and [Tas H102 P8](#).
- (b) The wall and ceiling provisions of (a) do not apply to areas in which all food for sale is completely enclosed and otherwise protected from contamination by processing plants, other appliances or other means.

Tas H102.9 Separation of work place

- (a) A room where food for sale is processed, manufactured, prepared, deposited, treated, stored or packed, that does not have direct communication with a room containing sanitary facilities, living quarters, laundry, bathroom or garage or a room where animals are housed, satisfies [Tas H102 P8\(b\)](#).
- (b) 'Direct communication' means a doorway, a window or other opening in a wall between a food preparation or storage area opening directly onto a room described in (a). Access between those areas via another room, a hallway, or an airlock, satisfies [Tas H102 P8\(b\)](#).

Tas H102.10 Washbasins

- (a) Premises or places for preparation or storage of food for sale provided with not less than one washbasin complying with (b) within five metres of any activity where hands are likely to be a source of contamination of food, satisfies [Tas H102 P9](#).
- (b) Each washbasin must—
 - (i) have hot and cold water through a common outlet; and
 - (ii) have a capacity of at least 11 litres; and
 - (iii) provide not less than 250 mm between the spout and the bottom of the basin; and

- (iv) be in a position that is not obstructed.

Tas H102.11 Sinks

- (a) Where equipment and utensils are required to be manually cleaned and sanitized, or food preparation requires a sink, premises that are provided with a suitably sized double bowl sink for equipment washing and a separate suitably sized sink for food preparation of stainless steel supplied with—
- (i) hot and cold water; and
 - (ii) an integral drainer on at least one side or a third bowl,
- satisfies **Tas H102 P10**.
- (b) A sink installed adjacent to a wall or other vertical surface, that is fitted with an integral flashing to that wall or vertical surface to a height of not less than 150 mm, satisfies **Tas H102 P10**.
- (c) A sink provided with an integral surround not less than 150 mm wide except on sides with an integral flashing as in (b), satisfies **Tas H102 P10**.
- (d) A cleaner's sink separated from food storage and handling areas provided for the emptying of cleaning water, satisfies **Tas H102 P10**.

Tas H102.12 Design, construction and installation of fixtures, fittings and equipment

- (a) The provision of fixtures, fittings and equipment designed, constructed and installed in accordance with clause 4.2 and clause 4.3 of AS 4674 satisfies **Tas H102 P10**.
- (b) The provision of—
- (i) automatic equipment that uses water to sanitize utensils or other equipment and only operate for the purposes of sanitation when the water is at a temperature that will sanitize the utensils or equipment; or
 - (ii) a sink that meets **Tas H102.11**,
- satisfies **Tas H102 P10**.

Tas H102.13 Storage of materials and equipment

- (a) Separate areas for the storage of fuel, cleaning compounds and general maintenance equipment provided so as to prevent the contamination of the product in the event of a spillage or any other form of breakdown, satisfies **Tas H102 P11**.
- (b) A separate area for the storage of staff clothing and personal effects, satisfies **Tas H102 P11**.

Tas H102.14 Food store

An eating house provided with a dry-food store, satisfies **Tas H102 P11**.

Tas H102.15 Meat Premises

- (a) Premises used for the preparation or sale of red meat, other than those licensed under the *Meat Hygiene Act 1985*, that comply with—
- (i) **Tas Part H106**; or

- (ii) the provisions of [Tas H102.2](#) to [Tas H102.13](#) and [Tas H102.17](#), satisfy in relation to building construction, the requirements of [Tas H102 P1](#) to [P12](#).

Tas H102.16 Dairy produce

Definition:

- (a) **Dairy produce** means milk, cream, butter, cheese, condensed milk, ice-cream, yoghurt and any other product of milk and includes margarine and dairy blend.
- (b) Premises designed and constructed in compliance with the Export Control (Dairy Eggs and Fish) Orders satisfy the special requirements of this code for premises to be used for the manufacture of *dairy produce*.

Tas H102.17 Refrigerated and cooling chambers

The construction of a refrigerated chamber or cooling chamber installed in premises for storage of food complying with the requirements for that premises, satisfies [Tas H102 P12](#) where they have—

- (a) internal and external panels adhered directly to the insulating core material to form an integral wall section with tight fitting edges resistant to penetration by liquids; and
- (b) every joint caulked with a water-resistant, flexible sealer and finished in such a manner as to prevent migration of liquids into the core; and
- (c) every intersection of walls with floors and walls with walls covered with a radius not less than 25 mm; and
- (d) exposed slot-head screws or open-headed pop rivets filled with sealer; and
- (e) service pipes and conduits concealed in floors, walls or ceilings, if practicable, or fixed on brackets to provide clearances of not less than 25 mm between the pipe and a wall and 100 mm between the pipe and a floor; and
- (f) fittings not fixed over exposed pipes nor in a position to make difficult the cleaning of the pipe and surrounding area; and
- (g) rat proof construction, and any inaccessible spaces between the low temperature room and surrounding walls, ceilings and fixtures proof against rats and vermin; and
- (h) floors graded, as shown in [Tas Table H102.17\(h\)](#), to drains located outside the chamber as near as practicable to the door opening; and
- (i) drainage from cooling units within the chamber constructed in accordance with [Tas Table H102.17\(i\)](#), draining to a trapped outlet located outside the chamber.

Tas TABLE H102.17(h) FLOOR DRAINAGE OF REFRIGERATED OR COOLING CHAMBERS

| | FLOOR SLOPE |
|-----------------|---------------------|
| Active chillers | not less than 1:50 |
| Other chambers | not less than 1:100 |

Tas TABLE H102.17(i) DRAINAGE FROM COOLING UNITS WITHIN REFRIGERATED CHAMBERS OR COOLING CHAMBERS

| |
|-------------------------------------|
| Wall-mounted cooling units - |
|-------------------------------------|

Tas TABLE H102.17(i) DRAINAGE FROM COOLING UNITS WITHIN REFRIGERATED CHAMBERS OR COOLING CHAMBERS—
continued

| |
|--|
| drain water must be contained and removed by either a wall-mounted channel or a spoon drain located under the coil. |
| Floor-mounted cooling units - drain water must be confined by kerbs, of a height not less than 150 mm, and directed to a trapped drain outlet. |
| Ceiling-mounted cooling units - drain water must be confined by suitable insulated drip trays directly connected to the drainage system. |

After Tas Part H102 insert Tas Part H103 as follows:

TAS PART H103 DINING ROOMS AND BAR ROOMS

Tas H103.1 Application of Part

This Part applies to all dining rooms and bar rooms (excluding bar service areas) in licensed premises covered by the *Liquor and Accommodation Act 1990*.

Tas H103.2 Sanitary facilities

- (a) Separate sanitary facilities for males and females must be provided in close proximity to each dining room and bar room in licensed premises.
- (b) Where the sanitary facilities are not accessed from within the dining room or bar area, reasonable fixed protection from the elements must be provided.

Tas H103.3 Separation from other areas

A dining room must not have direct opening to living quarters, a laundry, bathroom or garage or a room where animals are housed.

TAS PART H104 * * * * *

This Part has been deliberately left blank.

TAS PART H105 * * * * *

This Part has been deliberately left blank.

After Tas Part H105 insert Tas Part H106 as follows:

TAS PART H106 MEAT PREMISES

Tas H106.1 Application of Part

This Part is applicable to—

- (a) meat premises processing animals, including game and poultry, and producing meat and meat products for human consumption; and
- (b) pet food works licensed under *Meat Hygiene Act 1985*.

Tas H106.2 Premises Processing Animals and Meat

Premises used for the processing of animals and meat for human consumption must comply with the relevant Parts and Sections of the Australian Standards listed below:

- (a) Hygienic Production and Transportation of Meat and Meat Products for Human Consumption, AS 4696 - Part 7, Sections 19 to 21.
- (b) Hygienic Production of Game Meat for Human Consumption, AS 4464 - Sections 6 and 8.
- (c) Construction of Premises and Hygienic Production of Poultry Meat for Human Consumption, AS 4465 - Part A, Sections 3 to 12.
- (d) Hygienic Production of Rabbit Meat for Human Consumption, AS 4466 - Section 5.
- (e) Hygienic Rendering of Animal Products, AS 5008 - Section 4.
- (f) Hygienic Production of Ratite (Emu/Ostrich) Meat for Human Consumption, AS 5010 - Section 5.
- (g) Hygienic Production of Natural Casings for Human Consumption, AS 5011 - Section 4.
- (h) Tasmania Code of Practice for Hygienic Production of Pet Food - Section 5.

After Tas Part H106 insert Tas Part H107 as follows:

TAS PART H107 FARM DAIRY PREMISES

Tas H107.1 Application of this Part

This part is applicable to every farm dairy as covered by the *Tasmanian Dairy Industry Act 1994*.

Tas H107.2 Milking Sheds and Holding Yards

- (a) The walls (including the walls of the pit of a herringbone design milking shed) must be non absorbent and easy to clean.
- (b) The floor of a holding yard and a milking shed must be non absorbent, easy to clean and free-draining.
- (c) The lighting of a holding yard and a milking shed must be adequate for proper milking.
- (d) The working space in a milking shed is to be sufficient to minimise the risk of contamination of milk during milking.
- (e) Effluent from a holding yard and a milking shed is to be drained to a suitable point for disposal.
- (f) The requirements of (a), (b) and (c) are satisfied if—
 - (i) the walls are constructed of well-compacted smooth finish concrete or other material sealed to be impervious to moisture; and
 - (ii) the floors are constructed of well-compacted smooth finish concrete and graded to a drain; and

- (iii) joints between wall sections and walls and floors are sealed to prevent entry of water and pests; and
- (iv) artificial lighting is designed to comply with AS 1680.

Tas H107.3 Milk Receiving Area and Milk Storage Room

- (a) A Milk Receiving Area and Milk Storage Room must—
 - (i) have internal surfaces that are smooth, non-absorbent, free-draining and easy to clean; and
 - (ii) be constructed so as to prevent the entry of dust, insects, pests, birds and animals; and
 - (iii) have adequate artificial lighting that—
 - (A) is located to provide a clear view of the milk for grading and measuring purposes; and
 - (B) the lights over a bulk vat are to be protected to prevent glass entering the vat if the light is broken; and
 - (C) have switches appropriately located at the milk collection areas; and
 - (iv) have adequate ventilation to aid the drying of floors and walls between milkings.
- (b) The requirements of (a) are satisfied if—
 - (i) the floors are constructed of well-compacted smooth finish concrete and graded to a drain; and
 - (ii) the internal surfaces are smooth, sealed and washable; and
 - (iii) joints between wall sections and walls and floors are sealed to prevent entry of water and pests; and
 - (iv) artificial lighting is designed to comply with AS 1680; and
 - (v) all openings are fitted with doors, *windows* or screens; and
 - (vi) the milk is stored in a bulk storage tank which complies with AS 1187; and
 - (vii) ventilation is provided in accordance with [F4.5](#).

Tas H107.4 Water supply

An adequate and suitable supply of water must be available for plant sanitation, teat washing, milk cooling and vat rinsing.

After Tas Part H107 insert Tas Part H108 as follows:

TAS PART H108 PHARMACIES

Tas H108.1 Application of Part

This Part applies to all pharmacy business premises registered under the *Pharmacy Control Act 2001*.

Tas H108.2 Definition

In this Part the following meaning applies—

Dispensary means the room or area within a pharmacy or other premises which a registered pharmaceutical chemist uses for the compounding or dispensing of prescriptions, medicines or drugs.

Tas H108.3 Pharmacy premises

- (a) Each premises used as a pharmacy must have—
 - (i) a *dispensary* for the compounding or dispensing of drugs and for the storage of material used in dispensing; and
 - (ii) space for the storage of narcotic substances and poisons as *required* by the *Poisons Regulations 1975*; and
 - (iii) a place for unpacking containers or cases and goods; and
 - (iv) a room for storing merchandise not used in dispensing.
- (b) A pharmacy may have an area set aside for retailing merchandise that is not compounded or dispensed.

Tas H108.4 Dispensary

- (a) A *dispensary* must be located—
 - (i) within a pharmacy in a position to enable a person in the *dispensary* to supervise the *dispensary*, storage areas for narcotic substances and poisons, the entrances to unpacking areas and areas for storing other substances, and the retail area; and
 - (ii) separate from any place where goods are unpacked or where general merchandise, not used in dispensing, is stored.
- (b) Each *dispensary* must be provided with—
 - (i) a sink and drainage board of impervious material moulded or manufactured in one piece; and
 - (ii) a reticulated supply of hot and a cold water capable of providing to the sink adequate quantities of water for dispensing purposes; and
 - (iii) space for a dispensing bench with a working area not less than 1.4 m².

Tas H108.5 Security of dispensary

- (a) Every *dispensary* and enclosure set aside for the storage of narcotic substances and poisons must be able to be secured against entry.
- (b) If a *dispensary* is located in a pharmacy that is capable of being secured against entry at all times while the *dispensary* is not in use, then the *dispensary* is deemed to be secured against entry.

After Tas Part H108 insert Tas Part H109 as follows:

TAS PART H109 HEALTH SERVICE ESTABLISHMENTS

Tas H109.1 Application of Part

This Part applies to health service establishments as defined in the Health Service Establishment Act 2006 including—

- (a) a day procedure centre; or
- (b) a private hospital; or
- (c) a residential care service building.

Tas H109.2 Design and construction of health service establishments

Every health service establishment must be constructed and maintained in accordance with the Health Service Establishments Code.

After Tas Part H109 insert Tas Part H110 as follows:

TAS PART H110 PREMISES USED FOR ACTIVITIES INVOLVING SKIN PENETRATION

Tas H110.1 Application of Part

This Part applies to premises for tattooing, ear-piercing, acupuncture and like activities, which require a "public health risk activity" licence under the *Public Health Act 1997*.

Tas H110.2 Sanitary facilities

Sanitary facilities for customers must be provided and must include not less than—

- (a) one water closet; and
- (b) one washbasin.

Tas H110.3 Washbasins

The area in which skin penetration is done must be provided with—

- (a) one wash basin for each 10, or part of 10 employees; and
- (b) an adequate supply of hot and cold water controlled by foot-operated or other suitable means which allows the use of a tap without hand contact.

After Tas Part H110 insert Tas Part H111 as follows:

TAS PART H111 DENTAL SURGERIES AND CHIROPRACTORS' PREMISES

Tas H111.1 Application of Part

This Part applies to premises to be used—

- (a) as a dental surgery.

- (b) in the practice of chiropractic.

Tas H111.2 Waiting room

Each dental surgery and chiropractor's premises must have a separate waiting room.

Tas H111.3 Floor, walls and ceiling

The floor, walls and ceiling of a dentist's surgery and each room used in conjunction with that surgery or in a chiropractor's premises must be finished with materials which enable easy cleaning and disinfecting.

Tas H111.4 Disposal of liquid wastes

The operating section of a dental surgery must have adequate means for the disposal of waste water, other liquids and infected matter.

After Tas Part H111 insert Tas Part H112 as follows:

TAS PART H112 MORTUARIES

Tas H112.1 Application of Part

This Part applies to any premises used for the storage or preparation for burial, cremation or disposal by other means, of bodies of deceased persons.

Tas H112.2 Layout of mortuary

- (a) A mortuary may be integral with the remainder of a building but must be separated physically from all public areas of that building.
- (b) Each mortuary at which bodies are prepared for burial, cremation or other disposal must be provided with a body preparation room—
- (i) capable of being isolated from the remainder of the premises; and
 - (ii) having a *floor area* not less than 10 m².
- (c) A vehicle reception area or garage must be provided adjacent to and with direct access to the storage room or body preparation room to ensure that the transfer of uncoffined bodies is screened from public view.
- (d) Access to toilet and shower facilities from any other part of the mortuary premises must be only by way of an air lock.

Tas H112.3 Construction of body preparation room

- (a) The floor must be—
- (i) of impervious material with a smooth, unbroken surface; and
 - (ii) uniformly graded to a floor drain.
- (b) All walls and partitions must be of concrete or masonry with a smooth, unbroken finish for ease of cleaning.
- (c) All joints between the floor, walls, partitions, ceiling, ventilation grilles, fittings, pipework, *windows* and light fittings must be sealed with impervious material for ease of cleaning.

- (d) All joints between the floor and walls or partitions must be covered for ease of cleaning.
- (e) The body preparation room must be provided with at least one washbasin, fitted with elbow or foot-operated taps, and an adequate supply of hot and cold water.
- (f) The body preparation room must be provided with refrigerated storage facilities—
 - (i) with sufficient capacity for the storage of at least two adult bodies; and
 - (ii) capable of maintaining an internal temperature between 1° and 5°C.

Tas H112.4 Water supply and sewerage

Each mortuary with a body preparation room must be connected to—

- (a) a permanent water supply with a physical discontinuity, provided by a registered break tank or reduced pressure zone device, between the water supply and all equipment, appliances, fittings and areas in the mortuary; and
- (b) a water carriage sewerage system.

After Tas Part H112 insert Tas Part H113 as follows:

TAS PART H113 FOUNDRIES

Tas H113.1 Application of Part

This Part is applicable to every building or premises in which foundry operations are undertaken.

Tas H113.2 General

- (a) Every floor in a foundry must be level and, in places other than where molten metal is poured, must be composed of concrete or similar material or wooden blocks.
- (b) Every part of a foundry must be not less than 4.2 m high—
 - (i) where a ceiling is provided, measured from the floor to the ceiling; or
 - (ii) where a ceiling is not provided, measured from the floor to the lowest part of the roof.

Tas H113.3 Cupola charging platform

- (a) The floors of cupola charging platforms must be—
 - (i) of heavy timber or non-slip steel plate; and
 - (ii) securely fixed in position; and
 - (iii) level.
- (b) All parts of the cupola charging platform must be covered by a roof not less than 3 m above the platform.
- (c) A cupola charging platform must have—
 - (i) a wall, not less than 1 m high, measured from the floor of the platform, constructed to surround the platform; and
 - (ii) the sides between the top of the wall and the roof suitably waterproofed and ventilated.

- (d) A properly constructed access stair or ramp must be provided to give access to every cupola charging platform and must comply with AS 1657.

Tas H113.4 Deep moulds and pits

Deep moulds or pits, for permanent use—

- (a) must be lined with bricks, concrete, or other suitable material in such a manner as to provide adequate reinforcement and to keep the pit or mould in a dry condition; and
- (b) must be securely fenced by means of a wall of adequate construction, railings or chains and stanchions raised, in each case, to a height not less than 1 m above the surface of the surrounding floor.

Tas H113.5 Pot furnaces

Where pot furnaces are below ground level, the pit must be covered by a substantial grating at the point at which metal is removed from the furnace, and must at all other points be securely fenced as in [Tas H113.4\(b\)](#).

After Tas Part H113 insert Tas Part H114 as follows:

TAS PART H114 PREMISES FOR MANUFACTURE OR PROCESSING OF GLASS REINFORCED PLASTICS

Tas H114.1 Application of Part

This Part is applicable to every building in which glass reinforced plastics are manufactured or processed.

Tas H114.2 Separation from other buildings

A building for manufacture or processing of glass fibre plastics must be—

- (a) separated from other buildings or parts of an occupancy by means of impervious walls with FRL at least 120/120/120; or
- (b) separated from all other buildings by a clear space of not less than 6 m.

Tas H114.3 Rise in storeys

The building must be of single *storey* construction.

Tas H114.4 Maximum floor areas

The *floor area* of any building or fire-separated section must not exceed the relevant maximum *floor area* set out in [Tas Table H114.4](#).

Tas TABLE H114.4 MAXIMUM FLOOR AREA (m²) OF BUILDINGS FOR MANUFACTURE OR PROCESSING OF GLASS REINFORCED PLASTICS OR ISOCYANATES

| | Type of construction of building— | | |
|-----------------|-----------------------------------|--------|--------|
| | Type A | Type B | Type C |
| Not Sprinklered | 1500 | 1200 | 1000 |
| Sprinklered | 6000 | 5000 | 3000 |

Tas H114.5 Required exits

- (a) Each fire-separated section of a building which is a work place must have at least two *exits* for escape purposes and the number and location of the *exits* must be such that any point on the floor is not further than 20 m from one of the *exits*.
- (b) Only *exits* with vertically hinged swinging doors may be considered as *exits* for the purposes of this clause.

Tas H114.6 Hand laminating and spray depositing

The walls and floors of areas to be used for hand laminating and spray depositing must be constructed of *non-combustible* materials.

Tas H114.7 Ventilation

- (a) Mechanical or natural ventilation must be via low-level, exhaust ducting in a wall and a fixed, open, floor-level, fresh-air inlet ducting in the opposite wall such as to ensure a cross flow of the ventilation air over the complete working area.
- (b) Mechanical ventilation must provide not less than 6 air changes per hour.
- (c) The ventilation fan and exhaust ducting must be arranged in such a manner as to—
 - (i) produce a negative pressure within any exhaust ducting within the work place so that a leak in the ducting will not vent exhaust air back to the work place; and
 - (ii) vent the exhaust air to the atmosphere so as to prevent recirculation of that exhaust air.

Tas H114.8 Smoke and heat roof vents

Each fire-separated section must be provided with *automatic* smoke and heat roof vents.

After Tas Part H114 insert Tas Part H115 as follows:

TAS PART H115 PREMISES FOR PRODUCTION OR PROCESSING OF ISOCYANATES

Tas H115.1 Application of Part

This Part is applicable to every building in which isocyanate production or processing is undertaken.

Tas H115.2 Areas of work places

Work places in which an isocyanate industry is carried on must be divided into the following divisional areas:

- (a) Administration and staff amenities.
- (b) Workshop.
- (c) Bulk stores.
- (d) Curing room.
- (e) Processing plant.
- (f) Raw materials plant.
- (g) Manufacture.

Tas H115.3 Separation from other areas and buildings

- (a) Each of the divisional areas *required* by **Tas H115.2** other than the administration and staff amenities building, must be—
 - (i) separated from each of the other divisional areas by means of an impervious wall with an FRL not less than 120/120/120; or
 - (ii) separated from all other buildings by a clear space of not less than 6 m.
- (b) Notwithstanding the distance requirements of **(a)**, bulk stores of polyols and bulk stores of isocyanates must comply with the requirements of the *Work Health and Safety Act 2012*.

Tas H115.4 Rise in storeys

The building must be of single *storey* construction.

Tas H115.5 Maximum floor areas

The *floor area* of any building or fire-separated section must not exceed the area shown in **Tas Table H114.4**.

Tas H115.6 Required exits

- (a) Every building or divisional area of a work place must have not less than 2 *exits* for escape purposes.
- (b) The number and location of the *exits* must be such that any point on the floor is not more than 20 m from one of the *exits*.
- (c) Only *exits* with vertically hinged swinging doors may be considered as *exits* for the purposes of this clause.

Tas H115.7 Bulk stores for polyols and isocyanates

- (a) A bulk store for polyols must be constructed from *non-combustible* materials and have a smooth impervious concrete floor and it must protect the polyols from direct exposure to the sun's radiation.
- (b) A bulk store for isocyanates must—

- (i) be constructed from *non-combustible* materials, have a smooth impervious concrete floor, and must protect the isocyanate containers from direct exposure to the sun; and
 - (ii) if it is used for storage of either TDI or HDI and is not an open sided building, be fitted with mechanical ventilation so that the TLV is not exceeded at any time provided that the ventilation must provide not less than 6 air changes per hour.
- (c) The area around both a polyol bulk store and an isocyanate bulk store must be bunded, the bund or bunds must ensure separation of the polyol and isocyanate areas and each bund must have a capacity of 10% more than the storage capacity of the largest tank it protects.

Tas H115.8 Curing room

The curing room for the storage of newly produced flexible polyurethane foam must be constructed of *non-combustible* materials with a smooth impervious concrete floor and fitted *automatic* fire vents in the roof.

After Tas Part H115 insert Tas Part H116 as follows:

TAS PART H116 PREMISES FOR ELECTRO-PLATING ELECTRO-POLISHING, ANODISING OR ETCHING

Tas H116.1 Application of Part

This Part is applicable to every building where any of the processes of electro-plating, electro-polishing, anodising or etching are undertaken.

Tas H116.2 Floors

The floor of every plating area must be—

- (a) so graded as to—
 - (i) permit easy flushing with water; and
 - (ii) prevent liquids from flowing from the area into other parts of the work place; and
- (b) chemically resistant to the solutions used in the process.

Tas H116.3 Height of plating area

Every part of a plating area must be not less than 2.7 m in height—

- (a) measured from the floor to the ceiling if a ceiling is provided; or
- (b) measured from the floor to the lowest part of the roof if a ceiling is not provided.

Tas H116.4 Air space

In every plating area there must be not less than 14 m³ of air space for each person employed and, in the calculation of such space, the height taken into account must not exceed 4.2 m.

Tas H116.5 Ceiling construction

The ceiling of a plating area must be so constructed as to prevent, so far as is practicable, atmospheric contaminants from escaping into rooms or work places, situated above the level of the ceiling.

After Tas Part H116 insert Tas Part H117 as follows:

TAS PART H117 PREMISES FOR LEAD PROCESSING

Tas H117.1 Application of Part

This Part is applicable to every building in which lead processes are used.

Tas H117.2 Floors

- (a) The floor of every work place where a lead process is used must be—
 - (i) so constructed of concrete or other suitable material as to be smooth and impervious to fluids; and
 - (ii) graded and properly drained to permit flushing with water.
- (b) The material of which the floor is constructed must be applied to the walls to a height of not less than 75 mm in such a fashion that the angle between the walls and the floor is coved for easy cleaning.

Tas H117.3 Height of lead processing areas

Every part of a lead processing area must be not less than 2.7 m in height—

- (a) where a ceiling is provided, measured from the floor to the ceiling; or
- (b) where a ceiling is not provided, measured from the floor to the lowest part of the roof.

Tas H117.4 Air space and floor space

- (a) In every lead processing area there must be not less than 14 m³ of air space for each person employed therein, and in the calculation of such space the maximum height taken must be not greater than 4.2 m; and
- (b) total floor space for the persons employed in such area, exclusive of space used for storage, must be not less than 3.3 m² for each person so employed.

Tas H117.5 Interior of lead processing areas

- (a) The inner surfaces of the walls of every lead processing area must be of a smooth material impervious to fluids and must not contain any projections on which dust may lodge; and
- (b) the interior construction of the ceiling or roof must, so far as is practicable, be such that dust will not settle on it.

Tas H117.6 Dust collection

Any areas in which dust-forming lead materials are manipulated, moved or treated must be served by a mechanical exhaust ventilation system capable of safely and effectively collecting all dust.

Tas H117.7 Isolation of certain processes

Where any process of pasting of electric accumulator plates or drying of paste plates, or melting down of pasted plates or of formation with tacking in the electric accumulator industry or of manipulation of dry oxide of lead, is to be carried on in the same room as any other lead process, the processes of pasting, drying, melting, formation or manipulation must be isolated from one another and from any other lead process—

- (a) by a partition extending from the floor to the ceiling in the case of a room having a ceiling not more than 3.6 m in height, or to a height of 2.7 m in any other case; or
- (b) by some other suitable method.

Tas H117.8 Drying room shelves

The racks or shelves provided in any drying room must not be more than 2.6 m from the floor nor more than 650 mm in width except that, in the case of racks or shelves set or drawn from both sides, the total width must not exceed 1.3 m.

Tas H117.9 Washing facilities

Washing facilities served with running hot and cold water for the use of all employees engaged in a lead process must be provided consisting of—

- (a) one washbasin for each 5 employees, or part thereof; and
- (b) one shower bath for each 8 employees, or part thereof.

Tas H117.10 Change rooms

In every work place in which lead is processed there must be provided two suitable furnished change rooms for the use of employees as follows—

- (a) one of the change rooms must be used for taking off, storing, and putting on of the street clothing of employees; and
- (b) the other of the change rooms must be used for the taking off, storing, and putting on of overalls and other clothing worn in any work room; and
- (c) each change room must be so constructed and situated as to prevent the entry into the room of dust or fumes generated in a workroom; and
- (d) each change room must be in close proximity to the washing facilities *required* in [Tas H117.9](#).

After Tas Part H117 insert Tas Part H118 as follows:

TAS PART H118 BOOTHS FOR SPRAY PAINTING OR SPRAY COATING

Tas H118.1 Application of Part

This Part is applicable to every building in which spray painting or spray coating is undertaken.

Tas H118.2 Design and construction of booths

A spray painting booth is to be designed and constructed to comply with AS/NZS 4114.1 Spray Painting Booths, designated spray painting areas and paint mixing rooms. Part 1: Design, construction and testing.

After Tas Part H118 insert Tas Part H119 as follows:

TAS PART H119 ELECTRICITY DISTRIBUTION SUBSTATIONS

Tas H119.1 Application of Part

This Part is applicable to every surface building type electricity distribution substation as defined in Aurora Energy's "Distribution Substation Design and Construction Standard".

Tas H119.2 Building-type substations

A building-type electricity distribution substation which complies with the building design and construction requirements of Aurora Energy's "Distribution Substation Design and Construction Standard" satisfies this Part.

After Tas Part H119 insert Tas Part H120 as follows:

TAS PART H120 PREMISES FOR STORAGE OF DANGEROUS GOODS

Tas H120.1 Application of Part

This Part applies to every building used for the storage of hazardous chemicals that are dangerous goods under the ADG7 Code, except for substances, mixtures or articles categorised only as explosives under the GHS.

Tas H120.2 Interpretation

The words "substance", "hazardous chemical", "mixture", "article" and "flammable liquid" have the same meaning as the *Work Health and Safety Act 2012*.

Tas H120.3 Class of dangerous goods

The classification of dangerous goods will be as prescribed in the *Dangerous Substances (Safe Handling) Regulations 2009*.

Tas H120.4 Premises for storage of dangerous goods

- (a) A building must comply with the relevant Australian Standard, applicable to the storage of dangerous goods listed below:
- (i) Class 3 flammable liquids: AS 1940.
 - (ii) Agricultural and Veterinary Chemicals: AS 2507.
 - (iii) Liquefied petroleum gas: AS/NZS 1596.
 - (iv) Gas installations: AS 5601.
 - (v) Anhydrous ammonia: AS/NZS 2022.
 - (vi) Chlorine: AS/NZS 2927.
 - (vii) Organic peroxides: AS 2714.
 - (viii) Class 8 substances-Corrosives: AS 3780.
- (b) Except as provided in (a) a room, or space, for the storage of dangerous goods must be on the ground floor and may be—
- (i) attached to an *external wall* of a building; or
 - (ii) located within a building; or
 - (iii) separate from any building.
- (c) A room, or space, attached to or located within a building must be separated from the remainder of the building by one or more walls, each having an FRL not less than 240/240/240.
- (d) Every *external wall* of a room used for the handling or storage of dangerous goods, if not *required* to have an FRL, must be *non-combustible*.
- (e) If a storage area attached to an *external wall* of a building is a space without walls, other than the separating wall, the fire protected separating wall must extend for a distance of 5 m on each side of the common part of the wall or to the end of the wall, whichever is less.
- (f) Unless the wall *required* in (c) extends, over its full length, to the underside of the roof covering, the ceiling of a room, or space, for the storage of dangerous goods must have FRL not less than 180/180/180.
- (g) The floor surface of a room, or space, for the storage of dangerous goods must be—
- (i) of hardwood or a *non-combustible* material; and
 - (ii) resistant to attack by, and compatible with the dangerous goods stored in the room or space; and
 - (iii) of impervious construction.
- (h) Where a Class 2.1 flammable gas cylinder is to be stored in a recess enclosed by walls and a ceiling, the side opposite the cylinder safety valve must allow for the free unimpeded discharge of gas from the safety valve.
- (i) The requirement of (h) is satisfied if the side is provided with a secure full height open *non-combustible* mesh or similar open material access door or enclosure with openings sufficient to prevent interference to the installation.
- (j) Except as *required* in (h) and (i), the provisions of the Australian Standards shall apply in cases of conflict between these provisions and those in the following section of this Appendix.

Tas H120.5 Workrooms

A workroom for industrial or commercial use of dangerous goods must—

- (a) be located in accordance with AS 2430 Part 1 from any *fire source feature*; and
- (b) have all doors opening outwards; and
- (c) have passages of escape clear of machinery or other plant.

Tas H120.6 Exits

- (a) *Exits* must be provided in accordance with **Part D1**.
- (b) Any door in a wall, separating a room or space for storage and handling of dangerous goods from another room, must have an FRL in accordance with **Specification C1.1** but not less than 120/120/120.

Tas H120.7 Explosion vents

- (a) A room, or space, in which dangerous goods are stored must be provided with natural or mechanical ventilation so that any vapour generated within the storage is diluted with and removed by air passing through the storage area. Air dilution of the vapour should be sufficient to maintain the storage below the lower explosive limits and recommended workplace exposure standards.
- (b) The requirements of (a) are satisfied if ventilation provided to the room or space in which the dangerous goods are stored is in accordance with the ventilation requirements of AS 1940.

Tas H120.8 Spill Collection Bunds

- (a) A spill collection bund must be provided for all liquid dangerous goods stored in a room or space.
- (b) For Class 3 dangerous goods the bund must comply with the requirements of AS 1940.
- (c) For liquid dangerous goods other than Class 3, the spill collection bund—
 - (i) must be capable of containing 100% of the largest package or tank plus 25% of the storage capacity up to 10 000 L together with 10% of the storage capacity greater than 10 000 L; and
 - (ii) may form part of the room or space or may be separate; and
 - (iii) must be constructed of materials that are impervious to the dangerous goods it is to contain.
- (d) Separate bunds must be provided for dangerous goods that are incompatible.

Tas H120.9 Electrical equipment

Any electrical equipment in a room or space used for the storage of dangerous goods is to comply with the provisions outlined in AS/NZS 60079.10.1 Part 1 and AS/NZS 2381 Part 1, 2, 6 and 7.

After Tas Part H120 insert Tas Part H121, as follows:

TAS PART H121 HAIRDRESSERS' PREMISES

Tas H121.1 Application of Part

This Part applies to any building or part of a building used as a hairdressers' premises.

Tas H121.2 Size of operating section

The operating section of a hairdressers' premises must have—

- (a) any floor plan dimension not less than 2.5 m; and
- (b) a *floor area* sufficient to enable the operations to proceed without inconvenience to the operators or the customers.

Tas H121.3 Premises in a residence

A hairdressers' premises located in a residence must—

- (a) be isolated from the living quarters; and
- (b) have direct access from a public place.

Tas H121.4 Sanitary facilities

Except where sanitary facilities are available for common use, every hairdressers' premises which has more than 5 operating seats must be provided with one water closet and one washbasin for use by customers.

After Tas Part H121 insert Tas Part H122 as follows:

TAS PART H122 EARLY CHILDHOOD CENTRES AND SCHOOL AGE CARE FACILITIES

| |
|------------------|
| OBJECTIVE |
|------------------|

Tas H122 O1

The *Objective* of this Part is to regulate the physical specification of *early childhood centres* and *school age care facilities* at which education and care is provided.

| |
|-----------------------------|
| FUNCTIONAL STATEMENT |
|-----------------------------|

Tas H122 F1

An *early childhood centre* and *school age care facility* must be designed and constructed to provide a safe environment and provide for the health, safety and well-being of the children, parents and staff using the centre.

PERFORMANCE REQUIREMENTS

Tas H122 P1

The design and construction of an *early childhood centre* and *school age care facility* must to the degree necessary, provide an environment that is spacious enough to prevent overcrowding, and supports a range of daily activities and routines including—

- (a) indoor playing; and
- (b) outdoor playing; and
- (c) sleeping.

Tas H122 P2

An *early childhood centre* and *school age care facility*, must to the degree necessary, have sufficient space and facilities to ensure a healthy, safe and comfortable environment for children, staff and parents including—

- (a) sanitary facilities; and
- (b) nappy changing facilities; and
- (c) laundry facilities; and
- (d) food preparation facilities; and
- (e) reception, administration and staff facilities; and
- (f) storage facilities; and
- (g) suitable—
 - (i) floor surfaces; and
 - (ii) lighting and ventilation; and
 - (iii) fire safety provisions; and
 - (iv) windows and glazing; and
 - (v) heating and cooling.

Tas H122 P3

An *early childhood centre* and *school age care facility* must to the degree necessary, have fencing around the perimeter of any outdoor play space, and any identified hazard isolated by fences, barriers and gates.

Application:

Tas H122 O1, **Tas H122 F1** and **Tas H122 P1** to **Tas H122 P3** apply to *early childhood centres* and *school age care facilities* approved under the *Education and Care Services National Law (Application) Act 2011* or licenced under the *Child Care Act 2001*.

DEEMED-TO-SATISFY PROVISIONS

Tas H122.0 Application of Part

This Part applies to *early childhood centres* and *school age care facilities* approved under the *Education and Care Services National Law Act (Tas) 2011* or licensed under the *Child Care Act 2001*.

Tas H122.1 Deemed-to-Satisfy Provisions

- (a) *Performance Requirement Tas H122 P1* is satisfied by complying with the relevant provisions of the Early Childhood Centre and School Age Care Facilities Code.
- (b) *Performance Requirement Tas H122 P2* is satisfied by complying with the relevant provisions of the Early Childhood Centre and School Age Care Facilities Code.
- (c) *Performance Requirement Tas H122 P3* is satisfied by complying with the relevant provisions of the Early Childhood Centre and School Age Care Facilities Code.

After Tas Part H122 insert Tas Part H123 as follows:

TAS PART H123 TEMPORARY STRUCTURES

OBJECTIVE

Tas H123 O1

The objective of this Part is to safeguard the *public* who assemble for public events in *temporary structures* and other persons who use *temporary structures* from illness or injury.

FUNCTIONAL STATEMENT

Tas H123 F1

A *temporary structure* is to—

- (a) withstand the combination of loads and other actions to which it may reasonably be subjected; and
- (b) be of materials that resists the spread of fire so that occupants have time to evacuate safely without being overcome by the effect of a fire; and
- (c) be provided with—
 - (i) safe, equitable and dignified access for the people using the structure; and
 - (ii) means of evacuation that allow occupants time to evacuate safely without being overcome by the effects of an emergency; and
 - (iii) a safe and hazard free environment for the people using the structure; and

- (iv) adequate lighting upon failure of normal lighting during an emergency; and
 - (v) adequate means for occupants to identify exits and paths of travel to an exit; and
 - (vi) fire fighting equipment for occupants to undertake fire-fighting operation if a fire occurs; and
 - (vii) sanitary facilities for personal hygiene for the people using the structure; and
 - (viii) natural or artificial lighting to enable the safe use and movement of people using the structure; and
 - (ix) means of ventilation with outdoor air which will maintain adequate air quality; and
- (d) have any—
- (i) electrical services in or associated with the structure installed in a manner that provides adequate safety for occupants; and
 - (ii) heating appliances located in the structure installed in a way that reduces the likelihood of fire and harmful emissions spreading beyond the appliance; and
 - (iii) temporary seating located in or associated with the structure able to withstand the combination of loads and other actions to which they may reasonably be subjected to and provide a safe means of evacuation in an emergency.

PERFORMANCE REQUIREMENTS

Tas H123 P1

A *temporary structure* must, to the degree necessary, be capable of sustaining at an acceptable level of safety and serviceability the most adverse combination of loads and other actions to which it may reasonably be expected to be subjected.

Tas H123 P2

The material used in a *temporary structure* must, to the degree necessary, be capable of resisting the spread of fire to limit the generation of smoke and heat, and any toxic gases likely to be produced.

Tas H123 P3

- (a) Access must be provided to the degree necessary, to enable safe, equitable and dignified movement of people to and within a *temporary structure*.
- (b) So that people can move safely to and within a *temporary structure*, it must have—
 - (i) walking surfaces with safe gradients; and
 - (ii) stairways and ramps with slip-resistant walking surfaces; and
 - (iii) suitable handrails where necessary to assist and provide stability to people using a stairway or ramp.

Tas H123 P4

- (a) *Exits* must be provided to the degree necessary, from a *temporary structure* to enable the safe evacuation of occupants, with their number, location and dimensions being appropriate to the—
- (i) travel distances to *exits*; and
 - (ii) number, mobility and other characteristics of the occupants; and
 - (iii) function or use of the structure.
- (b) So that occupants can safely evacuate a *temporary structure*, paths of travel to *exits* must have dimensions appropriate to the—
- (i) number, mobility and other characteristics of the occupants; and
 - (ii) function or use of the structure.

Tas H123 P5

Where a person could fall 1 m or more, due to a sudden change of level within or associated with a *temporary structure*, a barrier must to the degree necessary, be provided which must be—

- (a) continuous and extend for the full extent of the hazard; and
- (b) of a height to protect the people from accidentally falling from the level; and
- (c) constructed to prevent the people from falling through the barrier; and
- (d) capable of restricting the passage of children; and
- (e) of strength and rigidity to withstand the foreseeable impact of the people and where appropriate, the static pressure of the people pressing against it.

Tas H123 P6

A level of illumination for safe evacuation from a *temporary structure* in an emergency must be provided, to the degree necessary, appropriate to the—

- (a) function or use of the structure; and
- (b) size of the structure; and
- (c) distance of travel to an *exit*.

Tas H123 P7

To facilitate evacuation from a *temporary structure* suitable signs or other means of identification must, to the degree necessary—

- (a) be provided to identify the location of *exits*; and
- (b) guide the occupants to *exits*; and
- (c) be clearly visible to the occupants; and
- (d) operate in the event of power failure for sufficient time for the occupants to safely evacuate.

Tas H123 P8

Fire equipment must be installed in a *temporary structure* to the degree necessary, to allow the occupants to undertake initial attack on a fire appropriate to the—

- (a) function or use of the structure; and
- (b) fire hazard.

Tas H123 P9

Sanitary facilities for personal hygiene must be provided in a convenient location associated with a *temporary structure*, to the degree necessary, appropriate to the—

- (a) function or use of the structure; and
- (b) number and gender of the occupants; and
- (c) disability or other particular needs of the occupants.

Tas H123 P10

Lighting must be installed to the degree necessary, to provide a level of illumination appropriate to the function or use of a *temporary structure* to enable safe use and movement by the occupants.

Tas H123 P11

Ventilation must be provided to the degree necessary, to a level appropriate to the function or use of a *temporary structure*.

Tas H123 P12

Electrical services must be installed to the degree necessary, to provide a level of safety appropriate to the environment and function or use of a *temporary structure* by the occupants.

Tas H123 P13

Where provided in a *temporary structure*, a heating appliance and its associated components must be installed to the degree necessary—

- (a) to withstand the temperatures likely to be generated by the appliance; and
- (b) so that it does not raise the temperature of any structural element to a level that would adversely affect the element's physical or mechanical properties or function; and
- (c) so that hot products of combustion will not—
 - (i) escape through the walls of the associated components; and
 - (ii) discharge to a position that will cause fire to spread to nearby combustible materials or allow smoke to penetrate the *temporary structure*; and
 - (iii) in the case of solid-fuel burning appliances, be discharged above appropriate emission limits.

Tas H123 P14

A *temporary structure* of tiered seating must be designed and constructed to the degree necessary, to provide for the safety of the occupants and orderly means of evacuation in an emergency.

Application:

Tas H123 O1, Tas H123 F1 and Tas H123 P1 to P14 only applies to a *temporary structure* that—

- (a) is used by the *public* as a place of assembly as described in the *Public Health Act 1997*; and
- (b) is a *temporary structure* as described in the *Building Act 2000*.

DEEMED-TO-SATISFY PROVISIONS

Tas H123.0 Application of Part

This Part only applies to a *temporary structure* that—

- (a) is used by the *public* as a place of assembly as described in the *Public Health Act 1997*; and
- (b) is a *temporary structure* as described in the *Building Act 2000*.

Tas H123.1 Deemed-to-Satisfy Provisions

Performance Requirements Tas H123 P1 to *Tas H123 P14* are satisfied by complying with the relevant provisions of *Tas H123.0* to *Tas H123.15*.

Tas H123.2 Structure

- (a) A *temporary structure* must be capable of resisting loads and actions determined in accordance with the following:
 - (i) Dead and live loads and load combinations: AS 1170.1 or AS/NZS 1170.1
 - (ii) Wind loads: AS 1170.2 or AS/NZS 1170.2.
- (b) Materials and forms of construction used in a *temporary structure* must as far as practicable comply with the relevant Australian Standard.

Tas H123.3 Fire resisting material

Roof and wall coverings to a *temporary structure* (including any lining or internal materials) must not be more than the *spread-of-flame index* and the *smoke-developed index* values in **Table Tas H123.3**:

TABLE Tas H123.3

| Component | Spread of Flame Index | Smoke Developed Index |
|-----------------------------|-----------------------|-----------------------|
| Roof covering (ceiling); or | 6 | 3 |

TABLE Tas H123.3— continued

| Component | Spread of Flame Index | Smoke Developed Index |
|---|-----------------------|-----------------------|
| Roof covering (ceiling); & walls; and | 0 | 7 |
| Walls (including lining material); or | 6 | 5 |
| Walls (including lining material) | 0 | 7 |
| Note: | | |
| <p>The <i>spread-of-flame index</i> and <i>smoke-developed index</i> are interrelated. When reading the table, the <i>spread-of-flame index</i> for a component determines the <i>smoke-developed index</i> for the component. If the <i>spread-of-flame index</i> for components is zero, then a higher <i>smoke-developed index</i> is permitted.</p> | | |

Tas H123.4 Access

- (a) Access for people with disabilities must be provided to and within a *temporary structure* by means of a continuous path of travel.
- (b) Access for people with disabilities must be provided to—
 - (i) any public sanitary facilities; and
 - (ii) all areas normally used by the *public* but excluding those areas only used by persons working in the *temporary structure*.
- (c) If fixed seating is provided, in a *temporary structure*, wheelchair spaces must be provided not less than—
 - (i) 1 wheelchair space for up to 100 seats; and
 - (ii) 2 wheelchair spaces for 100 - 200 seats; and
 - (iii) an additional wheelchair space for each additional 200 seats or part thereof.
- (d) Parts of the *temporary structure* required to be accessible must comply with AS 1428.1.

Tas H123.5 Exits and entrances

- (a) *Exits* to be provided to a *temporary structure* must be not less than the number of *exits* and aggregate width specified in **Table Tas H123.5** for the number of persons accommodated.
- (b) *Exits* are to be distributed as evenly as practicable around a *temporary structure*.
- (c) The maximum travel distance to an *exit* must as far as practicable, not be more than 20 m where only one *exit* is provided and 40 m where more than one *exit* is provided.
- (d) Every part of an entrance or *exit* must provide a minimum unobstructed height of 2000 mm and, where the entrance or *exit* is beneath a stepped seating platform, infilled riser or other projections, and overhead protection must be provided above the entrance or path of travel to the *exit*.
- (e) A flap or curtain used to cover an exit must be so designed that, when it is secured, it will not obstruct or impede egress.

Tas TABLE H123.5

| Number of exits and width | | |
|----------------------------------|--|--|
| Accommodation Provided (persons) | Number of <i>Exits Required</i> | Aggregate Width of <i>Exits</i> (mm) |
| 1-25 | 1 | 1000 |
| 26-50 | 1 | 1500 |
| 51-75 | 2 | 2000 |
| 76-100 | 2 | 2500 |
| 101-200 | 3 | 3000 |
| 201-400 | 3 | 4000 |
| 401-600 | 4 | 6000 |
| 601-800 | 5 | 8000 |
| 801-1000 | 5 | 9000 |
| over 1000 | 5 plus one additional <i>exit</i> for each additional 450 persons or part thereof. | 9000 plus 500 mm for each additional 50 persons or part thereof. |

Note:

(a) Where only one *exit* is provided that *exit* must be at least 1000 mm wide.

(b) Where 2 *exits* are provided each must be at least 1000 mm wide.

(c) Width may be reduced by 250 mm at doorways.

Tas H123.6 Barriers

A rigid barrier with no openings more than 125 mm wide must—

- (a) be provided at least 1000 mm high above the floor of a platform used as a *temporary structure*, and extend in the case of—
- (i) a stepped platform, from the front of the first riser to the back of the platform and along the rear of that platform for its full width; and
 - (ii) an inclined platform, from the front of the first row of seating to the back of the highest platform and along the rear of that platform for its full width; and
 - (iii) any other platform which is more than 1 m above the surrounding surface, other than a performance stage, to each side of the platform; and
- (b) not obstruct any aisle, cross-over or *exit*.

Tas H123.7 Emergency lighting

An emergency lighting system must as far as practicable—

- (a) be installed in any enclosed area of a *temporary structure* more than 300 m² in area; and
- (b) comply with AS 2293.1.

Tas H123.8 Exit signs

Exit signs must as far as practicable be provided above all *exits* and comply with AS 2293.1.

Tas H123.9 Fire fighting equipment

Portable fire extinguishers must as far as practicable be—

- (a) provided in a *temporary structure* as listed in **Table Tas H123.9**; and
- (b) be selected, located and distributed in accordance with Section 1, 2, 3, and 4 of AS 2444.

TABLE Tas H123.9

| Requirements for extinguishers | Risk class (as defined in AS 2444) |
|--------------------------------|--|
| All <i>temporary structure</i> | <ul style="list-style-type: none"> (a) To cover Class A fire risks: (b) To cover Class B fire risks in locations where flammable liquids in excess of 20 litres are stored or used (not including liquid held in fuel tanks or vehicles); (c) To cover fire risks involving live electrical equipment (E). (d) To cover Class F fire risks involving cooking oils and fats in cooking areas: |

Tas H123.10 Sanitary facilities

Sanitary facilities must as far as practicable be provided, within a 50 m distance from a *temporary structure* according to the numbers set out in **Table Tas H123.10**.

TABLE Tas H123.10

| Sanitary Facilities | | | | | | | | | |
|--|-----------------|-----|------------|---------|-----|------------|------------|-----|------------|
| | Closet Fixtures | | | Urinals | | | Washbasins | | |
| | 1 | 2 | Each extra | 1 | 2 | Each extra | 1 | 2 | Each extra |
| Sanitary facilities to be provided | | | | | | | | | |
| Number of males | 100 | 300 | 200 | 50 | 100 | 50* | 50 | 200 | 200 |
| Number of females | 25 | 50 | 50** | - | - | - | 50 | 150 | 200 |
| <p>*Where the number of male patrons exceeds 250, not less than 5 urinals must be provided plus one additional urinal for every additional 100 males in excess of 250.</p> <p>**Where the number of female patrons exceeds 250, not less than 6 closet fixtures must be provided plus one additional closet fixture for every 100 females in excess of 250.</p> <p>A unisex facility must be provided for people with disabilities and this facility must comply with AS 1428.1.</p> | | | | | | | | | |

Tas H123.11 Lighting

- (a) Natural or artificial lighting must be provided to all enclosed areas in a *temporary structure*.
- (b) Natural lighting must as far as practicable be not less than 10% of the floor area of the enclosed area.
- (c) The artificial lighting system must as far as practicable comply with the relevant provisions of AS 1680 Parts 1, 2.0, 2.1, 2.2 and 2.3.

Tas H123.12 Ventilation

- (a) Natural ventilation or mechanical ventilation must be provided to all enclosed areas in a *temporary structure*.
- (b) Natural ventilation must as far as is practicable consist of openings or devices which can be opened with an aggregate opening of not less than 5% of the floor area of the enclosed area.
- (c) Mechanical ventilation must as far as practicable comply with the relevant provisions of AS 1668.2.

Tas H123.13 Electrical

- (a) All electrical installations in a *temporary structure* must be installed in accordance with AS/NZS 3002.
- (b) All electrical equipment in a *temporary structure* must be tested in accordance with AS 3760.

Tas H123.14 Heating appliances

The installation of a stove, heater or similar appliance in a *temporary structure* must as far as practicable comply with the following standards:

- (a) Domestic oil-fired appliances – Installation: AS 1691.
- (b) Domestic solid-fuel burning appliances – Emissions: AS/NZS 4013
Installation: AS/NZS 2918.
- (c) Pressure equipment: AS/NZS 1200.
- (d) L P gas portable mobile appliances: AS 2658.

Tas H123.15 Seating

A seating area in a *temporary structure* must as far as practicable comply with **H1.4**.

After Tas Part H123 insert Tas Part H124 as follows:

TAS PART H124 PREMISES WHERE WORK IS UNDERTAKEN ON GAS-FUELLED VEHICLES

Tas H124.1 Application of Part

This Part is applicable to every building where work is undertaken on gas-fuelled vehicles.

Tas H124.2 Working areas

The working area of a building where work is undertaken on a gas-fuelled vehicle is to be designed and constructed to comply with the requirement for premises in AS 2746 Working areas for gas-fuelled vehicles.

Footnote: OTHER LEGISLATION AFFECTING BUILDINGS

All legislative technical requirements affecting the design, construction or performance of plumbing installations are consolidated into the *Building Act 2000* and other legislative instruments under that Act, such as regulations, codes (including the Tasmanian Plumbing Code (TPC) and the Tasmanian Appendix, Volume One - Appendices of the NCC) and standards.

VICTORIA

INTRODUCTION

This Appendix contains variations and additions to the Building Code of Australia (BCA) provisions which are considered necessary for the effective application of the Code in Victoria and shall be treated as amendments to the Code.

APPENDIX CONTENTS

APPENDIX VICTORIA

Victoria

A GENERAL PROVISIONS

Vic A1.1 Definitions
Vic Specification A1.3 Standards Adopted by Reference

D ACCESS AND EGRESS

Vic D1.4 Exit travel distances
Vic D1.6 Dimensions of exits and paths of travel to exits
Vic D2.21 Operation of latch

E SERVICES AND EQUIPMENT

Vic Table E1.5 Requirements for Sprinklers
Vic Specification E1.5 Fire Sprinkler Systems
Vic Specification E2.2a Smoke Detection and Alarm Systems

F HEALTH AND AMENITY

Vic FF2.2 Functional Statements
Vic FP2.2 Performance Requirement
Vic F2.0 Deemed-to-Satisfy Provisions
Vic F2.3 Facilities in Class 3 to 9 buildings
Vic Table F2.3 Sanitary Facilities in Class 3, 5, 6, 7, 8 and 9 Buildings
Vic F2.5 Construction of sanitary compartments
Vic F2.101 First aid rooms
Vic FO3 Objective
Vic FF3.1 Functional Statement
Vic FP3.1 Performance Requirement
Vic F3.0 Deemed-to-Satisfy Provisions
Vic F3.101 Childrens services - size of rooms
Vic F3.102 Class 3 buildings - size of rooms
Vic F3.103 Class 3, 9a and 9c residential aged care buildings - size of rooms
Vic F4.1 Provision of natural light
Vic F4.2 Methods and extent of natural lighting

G ANCILLARY PROVISIONS

Vic GO1 Objective
Vic GF1.2 Functional Statement
Vic GP1.2 Performance Requirements
Vic G1.1 Swimming pools

H SPECIAL USE BUILDINGS

Vic Part H101 CLASS 3, CLASS 9a and CLASS 9c RESIDENTIAL AGED CARE BUILDINGS

- Vic HP101.1 - HP101.3 Performance Requirements
- Vic H101.0 Deemed-to-Satisfy Provisions
- Vic H101.1 Application of Part
- Vic H101.2 Doorway width
- Vic H101.3 Windows
- Vic H101.4 Grab rails and handrails
- Vic H101.5 Water temperature
- Vic H101.6 Electronic communications system
- Vic H101.7 Electrical power outlets

Vic Part H102 PLACES OF PUBLIC ENTERTAINMENT

- Vic HP102.1 - HP102.3 Performance Requirements
- Vic H102.0 Deemed-to-Satisfy Provisions
- Vic H102.1 Application of Part
- Vic H102.2 Temporary tiered seating, concourses and embankments
- Vic H102.3 Motor vehicle racing
- Vic H102.4 Sanitary and amenity facilities

Vic Part H103 FIRE SAFETY IN CLASS 2 AND CLASS 3 BUILDINGS

- Vic H103.1 Fire safety in Class 2 and Class 3 buildings

Vic Part H104 CLASS 9b CHILDREN'S SERVICES

- Vic HP104.1 Performance Requirement
- Vic H104.0 Deemed-to-Satisfy Provisions
- Vic H104.1 Application of Part
- Vic H104.2 Doorways to a children's room

J ENERGY EFFICIENCY

VIC Part J7 HOT WATER SUPPLY AND SWIMMING POOL AND SPA POOL PLANT

Footnote: Other Legislation Affecting Buildings

SECTION A GENERAL PROVISIONS

PART A1 INTERPRETATION

Vary A1.1 as follows:

Vic A1.1 Definitions

Add the definition of "*children's service*" as follows:

Children's service has the same meaning as it has under the Children's Services Act 1996, but excludes a service where education and care is primarily provided to school aged children.

Substitute the definition of "*early childhood centre*" as follows:

Early childhood centre means—

- (a) any premises, or part thereof, providing or intending to provide a centre-based education and care service within the meaning of the Education and Care Services National Law Act 2010, and the Education and Care Services National Regulations 2011, excluding a service where education and care is primarily provided to school aged children; and
- (b) a *children's service*.

Add the definition of "*hotel offering shared accommodation*" as follows:

Hotel offering shared accommodation means a hotel which has any *sole-occupancy units* that can be shared by unrelated persons.

Add the definition of "*residential care building*" as follows:

Residential care building means a building which is a place of residence where 10% or more of persons who reside there need physical assistance in conducting their daily activities and to evacuate the building during an emergency (including any residential care service, State funded residential care service or supported residential service as defined in the Health Services Act 1988 and an *aged care building*) but does not include—

- (a) a hospital; or
- (b) a dwelling in which 2 or more members of the same family and not more than 2 other persons would ordinarily be resident; or
- (c) a place of residence where only one resident needs physical assistance in conducting their daily activities and to evacuate the building during an emergency.

Add the definition of "*restricted children's service*" as follows:

Restricted children’s service means a *children’s service* that is—

- (a) a limited hours Type 1 service; or
 - (b) a limited hours Type 2 service; or
 - (c) a short term Type 1 service; or
 - (d) a short term Type 2 service,
- as defined in the Children’s Services Regulations 2009; or
- (e) an associated children’s service within the meaning of the Children’s Services Act 1996 approved to be operated by an approved provider at the same place as an approved education and care service that is required to meet the conditions of a limited hours Type 1 service, a limited hours Type 2 service, a short term Type 1 service, or a short term Type 2 service.

Add the definition of “*shared accommodation building*” as follows:

Shared accommodation building means a Class 3 building having—

- (a) more than one *sole-occupancy unit* of which any *sole-occupancy unit* has sleeping facilities capable of accommodating 3 or more unrelated persons; or
- (b) sleeping facilities capable of accommodating 13 or more unrelated persons,

that is a boarding-house, chalet, guest house, lodging-house, backpacker accommodation or the like, or a residential part of a *hotel offering shared accommodation* but does not include a *residential care building*, a motel or a residential part of a *school*, *health-care building* or detention centre.

Insert in Table 1 of Specification A1.3 the following additional and revised clause references and additional documents:

VIC Specification A1.3 STANDARDS ADOPTED BY REFERENCE

Vic Table 1 SCHEDULE OF REFERENCED DOCUMENTS

| No. | Date | Title | BCA Clause(s) |
|---|-----------|--|--------------------------------------|
| AS 1926 | | Swimming pool safety | |
| Part 1 | 1993 | Fencing for swimming pools | Vic G1.1(a) |
| | | Amdt 1, June 2000 | |
| Part 2 | 1995 | Location of fencing for private swimming pools | Vic G1.1(a) |
| AS 2118 | | Automatic fire sprinkler systems | |
| Part 4 | 1995 | Residential | Vic Spec E1.5, Vic H103.1 |
| CAMS—Track operator’s safety guide | | | |
| Edition 2 | June 1993 | Confederation of Australian Motor Sport | Vic H102.3 |

Vic Table 1 SCHEDULE OF REFERENCED DOCUMENTS— continued

| No. | Date | Title | BCA Clause(s) |
|---|-----------|------------------------------|---------------------------------------|
| Supported residential services design guidelines | | | |
| Second edition | July 2006 | Department of Human Services | Vic H101.4, Vic H101.5 |
| Residential fire safety systems | | | |
| Practice Note 2008–07 | May 2008 | Building Commission | Vic Spec E2.2a, Vic H103.1 |
| Emergency communication systems | | | |
| Practice Note 2008–08 | May 2008 | Building Commission | Vic H103.1 |

SECTION D ACCESS AND EGRESS

PART D1 PROVISION FOR ESCAPE

Substitute the lead-in to D1.4(d) as follows:

Vic D1.4 Exit travel distances

- (d) **Class 9 buildings** — in a *patient care area* in a Class 9a building and in a *children's service*—

Delete D1.6(f)(iv) as follows:

Vic D1.6 Dimensions of exits and paths of travel to exits

- (f)
(iv) (Deleted)

PART D2 CONSTRUCTION OF EXITS

Substitute D2.21 (a) as follows:

Vic D2.21 Operation of latch

- (a) A door in a *required exit*, forming part of a *required exit* or in the path of travel to a *required exit* must be readily openable without a key from the side that faces a person seeking egress, by—
- (i) a single hand downward action on a single device which is located between 900 mm and 1.1 m from the floor and if serving an area *required* to be *accessible* by **Part D3**—
 - (A) be such that the hand of a person who cannot grip will not slip from the handle during the operation of the latch; and
 - (B) have a clearance between the handle and the back plate or door face at the centre grip section of the handle of not less than 35 mm and not more than 45 mm; or

- (ii) a single hand pushing action on a single device which is located between 900 mm and 1.2 m from the floor,

except that an exit door from a *children's service* which does not open to an outdoor space enclosed in accordance with **G1.3**, must have the device located between 1.5 m and 1.65 m above the floor and the door must be *self-closing*.

SECTION E SERVICES AND EQUIPMENT

PART E1 FIRE FIGHTING EQUIPMENT

Delete reference to Class 9c *aged care building* and add references to *shared accommodation buildings* and *residential care buildings* in **Table E1.5** and substitute Note (3) of **Table E1.5** as follows:

VIC Table E1.5 REQUIREMENTS FOR SPRINKLERS

| Occupancy | When sprinklers are required |
|---|------------------------------|
| <i>Residential care buildings</i> | In all buildings. |
| <i>Shared accommodation buildings</i> | In all buildings. |
| <p>(3) For the purposes of this Table, occupancies of excessive <i>fire hazard</i> comprise buildings which contain—</p> <ul style="list-style-type: none"> (a) hazardous process risks including the following: <ul style="list-style-type: none"> (i) Aircraft hangars. (ii) Electrical/electronic manufacturing and assembly (predominantly plastic components). (iii) Fire-lighter manufacturing. (iv) Fireworks manufacturing. (v) Flammable liquid spraying. (vi) Foam plastic goods manufacturing and/or processing. (vii) Foam rubber goods manufacturing and/or processing. (viii) Hydrocarbon based sheet product manufacturing and/or processing. (ix) Nitrocellulose and nitrocellulose goods manufacturing. (x) Paint and varnish works, solvent based. (xi) Plastic goods manufacturing and/or processing works. (xii) Resin and turpentine manufacturing. (xiii) Vehicle repair shops. (b) <i>combustible</i> goods with an aggregate volume exceeding 2000 m³ and stored to a height greater than 4 m such as the following: <ul style="list-style-type: none"> (i) Aerosol packs with flammable contents. (ii) Cartons and associated packing material excluding cartons with densely packed non-combustible content. (iii) Electrical appliances where the components are predominantly plastic. | |

VIC Table E1.5 REQUIREMENTS FOR SPRINKLERS— continued

| Occupancy | When sprinklers are required |
|-----------|---|
| (iv) | Foamed rubber or plastics including wrappings or preformed containers. |
| (v) | Paper products. |
| (vi) | Plastic, rubber, vinyl and other sheets in the form of offcuts, random pieces or rolls. |
| (vii) | Textiles raw and finished. |
| (viii) | Timber products. |

Substitute Clause 2(b) of Specification E1.5 as follows:

Vic Specification E1.5 FIRE SPRINKLER SYSTEMS

2. Adoption of AS 2118

- (b) for a Class 2 or 3 building or a *residential care building* other than a Class 9c *aged care building*: AS 2118.4 as applicable; or

Substitute Clause 4(e) of Specification E2.2a as follows:

Vic Specification E2.2a SMOKE DETECTION AND ALARM SYSTEMS

4. Smoke detection system

- (e) In a Class 9c *aged care building*—
 - (i) if the building accommodates more than 20 residents, manual call points must be installed in paths of travel so that no point on a floor is more than 30 m from a manual call point; and
 - (ii) indication of the zone where the smoke detection system has actuated must be achieved by one of the following:
 - (A)
 - (aa) remote automatic indication of each zone must be given in each smoke compartment; and
 - (bb) indication of (aa) must be indicated on remote annunciator panels with alpha-numeric displays with a minimum of 20 characters of 9 mm minimum height; or
 - (B)
 - (aa) indication of the zone where the smoke detection system has actuated must be communicated via a suitable interface with the fire indicator panel to a portable remote communication device; and
 - (bb) at least one such portable remote communication device per smoke compartment must be provided to staff nominated by the owner or operator and properly instructed as to the duties and responsibilities involved; and
 - (cc) the portable remote communication device may be a pager with alpha-numeric display or portable telephone handset with capability of receiving alpha-numeric display.

Substitute Clause 7(b) and (c) of Specification E2.2a as follows:

7. System monitoring

- (b) A smoke detection system in a Class 9a *health-care building*, if the building accommodates more than 20 patients, unless the building is sprinklered and the sprinkler system is permanently connected to a fire station, or other approved monitoring service with a direct data link to a fire station, in accordance with Practice Note 2008-07.
- (c) (deleted).

SECTION F HEALTH AND AMENITY

PART F2 SANITARY AND OTHER FACILITIES

Substitute application of *Functional Statement* FF2.2 as follows:

FUNCTIONAL STATEMENTS

Application:

FF2.2 only applies to—

- (a) a Class 2 building or a Class 4 part of a building; and
- (b) a Class 9a *health-care building*; and
- (c) a Class 9c *aged care building*; and
- (d) an *early childhood centre* other than a *restricted children's service*.

Substitute application of *Performance Requirement* FP2.2 as follows:

PERFORMANCE REQUIREMENTS

Application:

FP2.2 only applies to—

- (a) a Class 2 building or a Class 4 part of a building; and
- (b) a Class 9a *health-care building*; and
- (c) a Class 9c *aged care building*; and
- (d) an *early childhood centre* other than a *restricted children's service*.

Substitute Vic F2.0 as follows:

| |
|-------------------------------------|
| DEEMED-TO-SATISFY PROVISIONS |
|-------------------------------------|

Vic F2.0 Deemed-to-Satisfy Provisions

Performance Requirements FP2.1 to FP2.6 are satisfied by complying with **F2.1 to F2.8** and **Vic F2.101**.

Substitute F2.3(g) as follows:

Vic F2.3 Facilities in Class 3 to 9 buildings

- (g) A Class 9b *early childhood centre*, other than a *children's service*, must be provided with—
- (i) a kitchen or food preparation area with a kitchen sink, separate hand washing facilities, space for a refrigerator and space for cooking facilities, with—
 - (A) the facilities protected by a door or gate with child proof latches to prevent unsupervised access to the facilities by children younger than 5 years old; and
 - (B) the ability to facilitate supervision of children from the facilities if the *early childhood centre* accommodates children younger than 2 years old; and
 - (ii) one bath, shower or shower-bath; and
 - (iii) if the centre accommodates children younger than 3 years old—
 - (A) a laundry facility comprising a washtub and space in the same room for a washing machine; and
 - (B) a bench type baby bath, which is within 1 m of the nappy change bench; and
 - (C) a nappy changing bench which—
 - (aa) is within 1 m of separate adult hand washing facilities and bench type baby bath; and
 - (bb) must be not less than 900 mm² in area and at a height of not less than 850 mm, but not more than 900 mm above the finished floor level; and
 - (cc) must have a space not less than 800 mm high, 500 mm wide and 800 mm deep for the storage of steps; and
 - (dd) is positioned to permit a staff member changing a nappy to have visibility of the play area at all times.
- (ga) A *children's service* must be provided with—
- (i) a kitchen or facilities for the preparation and cooking of food for children including washing up facilities and a space for refrigerated food storage facilities; and
 - (ii) except in a *restricted children's service*, if the service accommodates children younger than 3 years of age—
 - (A) a laundry facility comprising a washtub and space in the same room for a washing machine; and
 - (B) a bench-type baby bath, with hot and cold water connected, and a nappy change bench in close proximity; and
 - (iii) except in a *restricted children's service*, one bath or shower-bath.

Vary Table F2.3 as follows:

Vic Table F2.3 Sanitary Facilities in Class 3, 5, 6, 7, 8 and 9 Buildings

| User Group | Closet Pans | | Urinals | | Washbasins | |
|---|------------------|--------------|------------------|--------|------------------|--------------|
| | Design Occupancy | Number | Design Occupancy | Number | Design Occupancy | Number |
| Class 9b — <i>early childhood centre</i> | | | | | | |
| Children | 1 — 30 | 2 | | | 1 — 30 | 2 |
| | > 30 | Add 1 per 15 | | | >30 | Add 1 per 15 |

Note:

Facilities for use by children must be—

- (a) junior closet pans, except that those in a *restricted children's service* may be adult height toilets if they are fitted with a removable seat suitable for children and a wide and stable step in front; and
- (b) washbasins with a rim height not exceeding 600 mm, except that those in a *restricted children's service* may be adult height washbasins if they are provided with a wide and stable step in front; and
- (c) except in a *children's service*, accessible from both indoor and outdoor play areas; and
- (d) in a *children's service*, other than a *restricted children's service*, the closet pans must be located in relation to children's rooms and outdoor play spaces so that children using toilets can be observed by staff from children's rooms and outdoor play space.

Substitute Vic F2.5(c) as follows:

Vic F2.5 Construction of sanitary compartments

- (c) In an *early childhood centre*, other than a *restricted children's service*, closet pans situated in a group for use by children must be separated from one another by means of a partition, which, except for the doorway, is opaque for a height of not less than 900 mm but not more than 1200 mm above the floor.

Add Vic F2.101 as follows:

Vic F2.101 First aid rooms

- (a) If an *assembly building*, place of public entertainment (as defined in the Building Act 1993) or an *open spectator stand* accommodates more than 5000 spectators at an arena, sportsground, showground, racecourse, cricket ground, football ground, coursing ground, motor racing arena, or the like, a suitable room or rooms must be provided in accordance with **Table F2.101** for use by para-medical attendants for first aid purposes.

Table F2.101 FIRST AID ROOMS

| Spectator Capacity | Number of Rooms |
|-----------------------------------|-----------------|
| 5 001–10 000 | 1 |
| 10 001–15 000 | 2 |
| 15 001–30 000 | 3 |
| each extra 15 000 or part thereof | 1 |

- (b) **Conditions:** First aid rooms *required* by (a) must—
- (i) be distributed as uniformly as possible throughout the *assembly building* or *open spectator stand*; and
 - (ii) be convenient to a public road; and
 - (iii) be readily accessible from within and outside the arena or ground; and
 - (iv) have a *floor area* of not less than 24 m²; and
 - (v) be provided with a suitable wash basin or sink.

PART F3 ROOM SIZES

Substitute FO3 as follows:

OBJECTIVE

Vic FO3

The *Objective* of this Part is to safeguard occupants from injury or loss of amenity caused by inadequate size of a room or space.

Substitute FF3.1 as follows:

FUNCTIONAL STATEMENT

Vic FF3.1

A building is to be constructed with sufficient size in a room or space suitable for the intended use.

Substitute FP3.1 as follows:

PERFORMANCE REQUIREMENT

Vic FP3.1

A *habitable room* or space must have sufficient size to enable the room or space to fulfil its intended use.

Substitute Vic F3.0 as follows:

DEEMED-TO-SATISFY PROVISIONS

Vic F3.0 Deemed-to-Satisfy Provisions

Performance Requirement Vic FP3.1 is satisfied by complying with **F3.1** and **Vic F3.101** to **Vic F3.103**.

Add Vic F3.101 as follows:

Vic F3.101 Children's services — size of rooms

- (a) A children's room in a *children's service* must have a *floor area* allowing a clear space of at least 3.25 m² for each child using that room.
- (b) When calculating the clear space *required* by (a) any passageway or thoroughfare less than 3 metres wide, kitchen, toilet or shower area, storage area (including cupboards), areas through which doors may swing, cot rooms (including areas where fixed cots will be used or stored) or any other ancillary area must not be included.

Add Vic F3.102 as follows:

Vic F3.102 Class 3 buildings — size of rooms

A *habitable room* in a Class 3 building (other than a *residential aged care building*)—

- (a) must have a *floor area* of at least 7.5 m²; or
- (b) may have a *floor area* less than 7.5 m² provided the room has light and ventilation not less than that *required* for a room having a *floor area* of 7.5 m².

Add Vic F3.103 as follows:

Vic F3.103 Class 3, 9a and 9c residential aged care buildings — size of rooms

In a *residential aged care building*—

- (a) each bedroom must have a *floor area* of not less than 12 m² per occupant; and
- (b) all other common *habitable rooms* (other than kitchens) must have a *floor area* of not less than 7.5 m² with—
 - (i) in a Class 3 hostel or supported residential services building or Class 9c *aged care building* an aggregate *floor area* of not less than 3.5 m² per occupant; or

- (ii) in a Class 9a nursing home an aggregate *floor area* of not less than 2.5 m² per occupant.

PART F4 LIGHT AND VENTILATION

Delete F4.1(d) and insert Vic F4.1(d) as follows:

Vic F4.1 Provision of natural light

- (d) **Class 9b buildings** — to all general purpose classrooms in primary or secondary *schools* and all playrooms or the like for the use of children in an *early childhood centre* other than a *restricted children's service*.

Substitute F4.2(b) and F4.2(d) and delete F4.2(c) as follows:

Vic F4.2 Methods and extent of natural lighting

- (b) In a Class 2, 3 or 9 building or Class 4 part of a building a *required window* that faces a boundary of an adjoining allotment or a wall of the same building or another building on the allotment must not be less than a horizontal distance from that boundary or wall that is the greater of—
- (i) generally — 1 m; and
 - (ii) in a *patient care area* or other room used for sleeping purposes in a Class 9a or Class 9c building — 3 m; and
 - (iii) 50% of the square root of the exterior height of the wall in which the *window* is located, measured in metres from its sill.
- (c) (deleted).
- (d) In a Class 9b *early childhood centre*, other than a *restricted children's service*, the sills of 50% of *windows* in children's rooms must be located not more than 500 mm above the floor level.

SECTION G ANCILLARY PROVISIONS

PART G1 MINOR STRUCTURES AND COMPONENTS

Delete GO1(c) and insert Vic GO1(c) as follows:

OBJECTIVE

Vic GO1

- (c) safeguard young children from drowning or injury in a *swimming pool*; and

Application:

Vic GO1(c) only applies to a *swimming pool* with a depth of water more than 300 mm associated with—

- (a) a Class 2 or 3 building or Class 4 part of a building; or

- (b) a *children's service*.

Delete GF1.2(a) and insert Vic GF1.2(a) as follows:

FUNCTIONAL STATEMENT

Vic GF1.2

A *swimming pool* is to be provided with—

- (a) means of restricting access by young children to it; and

Application:

Vic GF1.2(a) only applies to a *swimming pool* with a depth of water more than 300 mm associated with—

- (a) a Class 2 or 3 building or Class 4 part of a building; or
(b) a *children's service*.

Delete GP1.2(a) and insert Vic GP1.2(a) as follows:

PERFORMANCE REQUIREMENTS

Vic GP1.2

- (a) A barrier must be provided to a *swimming pool* and must—
- (i) be continuous for the full extent of the hazard; and
 - (ii) be of a strength and rigidity to withstand the foreseeable impact of people; and
 - (iii) restrict the access of young children to the pool and the immediate pool surrounds; and
 - (iv) have any gates and doors fitted with latching devices not readily operated by young children, and constructed to automatically close and latch.

Application:

Vic GP1.2(a) only applies to a *swimming pool* with a depth of water more than 300 mm associated with—

- (a) a Class 2 or 3 building or Class 4 part of a building; or
(b) a *children's service*.

Delete G1.1(a) and Insert Vic G1.1(a) as follows:

Vic G1.1 Swimming pools

- (a) A *swimming pool* associated with a *children's service*, with a depth of water more than 300 mm, must have fencing or other barriers in accordance with AS 1926 Parts 1 and 2.

SECTION H SPECIAL USE BUILDINGS

Add Vic Part H101 as follows:

Vic Part H101 CLASS 3, CLASS 9a AND CLASS 9c RESIDENTIAL AGED CARE BUILDINGS

Application:

This Part only applies to Class 3, Class 9a and Class 9c *residential aged care buildings*.

Note.

Vic Part H101 — Class 3, Class 9a and Class 9c Residential Aged Care Buildings contains additional *Deemed-to-Satisfy Provisions* for Sections D and F for Class 3, Class 9a and Class 9c *residential aged care buildings* as well as additional *Performance Requirements* and associated *Deemed-to-Satisfy Provisions*.

PERFORMANCE REQUIREMENTS

Vic HP101.1

The temperature of water supplied to baths and showers for use by residents must be controlled to avoid the risk of scalding whilst ensuring the stored water temperature does not encourage the growth of Legionella Bacteria.

Vic HP101.2

An electronic communication system must be provided to enable residents and staff to summon assistance in *habitable rooms* (other than kitchens), water closets, shower rooms and bathrooms.

Vic HP101.3

Sufficient general purpose outlets must be provided for electrical appliances in bedrooms in locations that obviate the need for extension leads.

| |
|-------------------------------------|
| DEEMED-TO-SATISFY PROVISIONS |
|-------------------------------------|

Vic H101.0 Deemed-to-Satisfy Provisions

Performance Requirements Vic HP101.1 to HP101.3 and relevant *Performance Requirements* in Sections D and F are satisfied by complying with Vic H101.1 to Vic H101.7.

Vic H101.1 Application of Part

The *Deemed-to-Satisfy Provisions* of this Part apply to Class 3, Class 9a and Class 9c residential aged care buildings.

Vic H101.2 Doorway width

- (a) The clear width of all bedroom entrance doorways must be not less than 900 mm.
- (b) The clear width of all other doorways must be not less than 800 mm.

Vic H101.3 Windows

- (a) The sill height of *windows* in *habitable rooms* (except kitchens) must be not more than 900 mm above the floor.
- (b) Openable *windows* must be provided with flyscreens.

Vic H101.4 Grab rails and handrails

- (a) Grab rails must be provided in association with every closet fixture, shower or bath in accordance with the Supported Residential Services Design Guidelines.
- (b) Handrails must be provided along both sides of every common passageway or common corridor used by residents and they must be—
 - (i) fixed not less than 50 mm clear of the wall; and
 - (ii) where practicable, continuous for their full length.

Vic H101.5 Water temperature

The hot water temperature must comply with the minimum design parameters of the Supported Residential Services Design Guidelines.

Vic H101.6 Electronic communications system

A communication system must—

- (a) contain a back-up power supply; and
- (b) have a control that enables the call to be cancelled manually at the point of origin only; and
- (c) incorporate a device at the point of origin that indicates the system has operated; and
- (d) incorporate an indication panel in the manager's office or staff area that clearly identifies the point of origin of a call; and
- (e) have an audible tone that has a continuous signal until deactivated at the point of origin; and

- (f) be operational at all times; and
- (g) have two call points in each en-suite or combined shower/water closet with one call point located in the shower recess and the other on the wall beside the closet pan ahead of the bowl rim; and
- (h) have call points (other than those mentioned in (g)) which are located—
 - (i) within the reach of a resident whilst in bed; and
 - (ii) in all common *habitable rooms*; and
 - (iii) in all bathrooms, *sanitary compartments* and shower rooms where the call point must be of waterproof construction and within reach of any fallen resident.

Vic H101.7 Electrical power outlets

General purpose outlets must be provided as follows:

- (a) In bedrooms with one occupant—two general purpose outlets provided on a minimum of two walls.
- (b) For each additional occupant—two general purpose outlets provided at the head of each additional bed.

Add Vic Part H102 as follows:

Vic Part H102 PLACES OF PUBLIC ENTERTAINMENT

Application:

This Part applies to all places of public entertainment as defined in the Building Act 1993 and prescribed in regulation 1102 of the Building Regulations 2006.

Note.

Vic Part H102 — Places of Public Entertainment contains additional deemed-to-satisfy and *Performance Requirements* for Sections B, D and F for places of public entertainment.

PERFORMANCE REQUIREMENTS

Vic HP102.1

Temporary tiered seating stands and embankments must be designed using engineering principles and constructed to provide for the safety of the patrons and orderly means of evacuation in an emergency.

Vic HP102.2

Every place of public entertainment where motor vehicle racing takes place must be provided with suitable barriers and guard rails to protect the public from injury.

Vic HP102.3

Sufficient sanitary and amenity facilities must be provided at places of public entertainment for use by patrons.

DEEMED-TO-SATISFY PROVISIONS

Vic H102.0 Deemed-to-Satisfy Provisions

Performance Requirements Vic HP102.1 to HP102.3 are satisfied by complying with Vic H102.1 to Vic H102.4.

Vic H102.1 Application of Part

The *Deemed-to-Satisfy Provisions* of this Part apply to all places of public entertainment.

Vic H102.2 Temporary tiered seating, concourses and embankments

Temporary tiered seating stands and embankments must be designed and constructed as follows:

- (a) Temporary tiered seating, concourses and embankments must comply with the *Deemed-to-Satisfy Provisions* of **Section B**, **Section D** and **Clause H1.4(a)(ii), (iii)** and **(b)**.
- (b) The maximum slope of tiered seating must not exceed 34 degrees when measured from the horizontal plane.
- (c) Aisles must be evenly spaced throughout the structure and have—
 - (i) a minimum width of 1 m; and
 - (ii) the aggregate of aisle widths leading to an *exit* must be not less than the *required* width of that *exit*; and
 - (iii) no one aisle may serve more than—
 - (A) 120 patrons where individual seating with backs is provided; or
 - (B) 200 patrons in any other case.
- (d) When applying the balustrading requirements of the *Deemed-to-Satisfy Provisions* of **Section D**, the height of plat balustrading that directly abuts seating (i.e. with no aisle between the seat and the balustrading) must be measured from the plat or seat base whichever is the higher.
- (e) Transverse aisles must be provided at a horizontal distance of not more than 10 m between any row of seats.
- (f) All individual moveable seats must be—
 - (i) fixed in groups of not less than four; and
 - (ii) not used in stepped or ramped seating areas.
- (g) For any spectators' embankment—
 - (i) where the rear slope exceeds 1 in 5, a guard rail must be installed with no openings except at the heads of steps or ramps; and

- (ii) where the forward or front slope exceeds 1 in 8, the embankment must be stepped with plats not less than 500 mm wide and risers not greater than 230 mm high.
- (h) Guard rails must be installed to protect any fence, balustrade or railing associated with stepped or ramped standing spaces where excess pressure is expected from spectators.

Vic H102.3 Motor vehicle racing

Motor vehicle racing barriers and guard rails must be provided so as to comply with the following:

- (a) CAMS “Track Operators Safety Guide”.
- (b) For stock car racing, barriers installed—
 - (i) on the outer amend of the track: a continuous concrete, close boarding or long guard barrier having a height of not less than 900 mm; and
 - (ii) on all curved sections of the track within 3 m of the barrier described in (i): a stout welded or woven wire mesh fence adequately supported having a height of not less than 1.8 m above the adjacent spectators viewing areas; and
 - (iii) between the public viewing area and the fence described in (ii): a suitable crowd barrier that will prevent spectators entering within 1.2 m of that fence.

Vic H102.4 Sanitary and amenity facilities

Sanitary and amenity facilities in places of public entertainment must be provided as follows:

- (a) In places other than buildings:
 - (i) One closet fixture for every 200 female patrons or part thereof.
 - (ii) One closet fixture or urinal for every 200 male patrons or part thereof, at least 30% of which must be in the form of closet fixtures.
 - (iii) One washbasin for every 200 patrons or part thereof.
 - (iv) For use by disabled persons, one unisex facility within the meaning of **Part F2** of the BCA for every 100 closet fixtures or part thereof *required* under **(i)** and **(ii)**.
 - (v) One drinking fountain or drinking tap for every washbasin *required* under **(iii)**.
 - (vi) First aid facilities in accordance with **Vic F2.101**.
- (b) In buildings, as *required* to comply with **Part F2**.

Add Vic Part H103 as follows:

Vic Part H103 FIRE SAFETY IN CLASS 2 AND CLASS 3 BUILDINGS

Note:

There are no *Performance Requirements* for Vic Part H103 — Fire Safety in Class 2 and Class 3 Buildings as the Part contains only additional *Deemed-to-Satisfy Provisions* for **Sections C, D** and **E** for Class 2 and Class 3 buildings.

Vic H103.1 Fire safety in Class 2 and Class 3 buildings

- (a) A Class 2 or Class 3 building not more than 25 m in *effective height* that has a sprinkler system complying with **Specification E1.5** installed throughout the building may be constructed in accordance with **(b)** provided that—

-
- (i) where a sprinkler system complying with AS 2118.4, as applicable, is installed in the building, the system must be permanently connected with a direct data link or other approved monitoring system to a fire station or fire station dispatch centre in accordance with Practice Note 2008-07 if—
 - (A) it has more than 100 sprinkler heads; or
 - (B) in the case of a *residential care building*, the building will accommodate more than 32 residents; and
 - (ii) the sprinkler system is fitted with sprinklers complying with Clause 2.6 of AS 2118.4 in bedrooms; and
 - (iii) an *automatic* smoke detection and alarm system is installed in accordance with **Specification E2.2a**, except that it need not be connected to a fire station and in the case of a *residential care building* must be installed in accordance with—
 - (A) **Specification E2.2a Clause 4**; or
 - (B)
 - (aa) **Specification E2.2a Clause 3** provided **Clause 3 (c)(ii)** is applied as if the building was not protected with a sprinkler system; and
 - (bb) Practice Note 2008-07; and
 - (iv) in a *residential care building*, the *automatic* smoke detection and alarm system and the sprinkler system are connected to an alarm panel constructed in accordance with Practice Note 2008-07; and
 - (v) fire orders are provided in a Class 3 building in accordance with **G4.9**.
- (b) Subject to compliance with (a), the following concessions are permissible:
- (i) **C3.11** — deletion of the requirement for *self-closing* fire doors or solid-core doors (except those opening to fire-isolated *exits*).
 - (ii) **Specification C1.1** — deletion of the requirement for *internal walls* to have an FRL subject to compliance with **Clause 2.2 of Specification C1.1**, except that walls bounding *public corridors* must be—
 - (A) clad in *non-combustible* material; and
 - (B) extend to the underside of a *non-combustible* roof covering or to the underside of the ceiling and be designed to minimise smoke spread to the corridor; and
 - (C) not incorporate any penetrations above door head height unless the penetrations are adequately stopped to prevent the free passage of smoke.
 - (iii) **D1.3** — deletion of the requirement for stairways that serve not more than 5 *storeys* to be *fire-isolated stairways* provided—
 - (A) the stairway is smoke enclosed with construction that complies with **D2.6** (except **D2.6(a)** and **(b)(i)**); and
 - (B) in a Class 3 building, *storeys* 4 and 5 are served by a minimum of 2 smoke enclosed stairways.
 - (iv) **D1.4(a)(i)(A)** — except in a *residential care building*, the maximum distance of travel may be increased from 6 m to 12 m.
 - (v) **D1.5(c)(i)** — except in a *residential care building*, the maximum distance between alternative *exits* may be increased from 45 m to 60 m.

- (vi) **E1.3** — deletion of the requirement for internal fire hydrants in buildings that have a *rise in storeys* of not more than 5 provided—
- (A) an external fire hydrant is installed in accordance with **E1.3** except that in a *residential care building*, the nozzle at the end of the length of hose need only reach the entry door of any *sole-occupancy unit* to be considered as covering the floor area within the *sole-occupancy unit*; or
 - (B) a dry fire main fitted with standard fire hydrant heads is installed in the building provided that—
 - (aa) each fire hydrant head is located in accordance with **E1.3** and fitted with a blank cap or plug; and
 - (bb) the pipework is installed in accordance with **E1.3** (as if it were a fire main suitable for that building) except that it does not need to be connected to a water supply; and
 - (cc) a booster inlet connection is provided in accordance with **E1.3**; and
 - (dd) an external fire hydrant is located within 60 m of the booster connection.
- (vii) **E1.4** — deletion of the requirement for fire hose reels in buildings that have a *rise in storeys* of not more than 5 provided the building is protected by—
- (A) fire hydrants that comply with **E1.3**; or
 - (B) dry fire mains in accordance with (vi)(B).
- (viii) **E4.9** — deletion of the requirement for a sound system and intercom system for emergency purposes in a *residential care building* provided an intercom system with override public address facility is installed in accordance with Practice Note 2008-08.

Add Vic Part H104 as follows:

Vic Part H104 CLASS 9b CHILDREN'S SERVICES

Application:

This Part only applies to Class 9b *children's services*.

Note:

Vic Part H104 — Class 9b Children's Services contains an additional *Performance Requirement* and *Deemed-to-Satisfy Provisions* for **Section D** for Class 9b *children's services*.

PERFORMANCE REQUIREMENT

Vic HP104.1

The number and location of doorways to a children's room must take into account the mobility of children in the event that emergency egress or entry is required.

DEEMED-TO-SATISFY PROVISIONS

Vic H104.0 Deemed-to-Satisfy Provisions

Performance Requirement Vic HP104.1 and relevant *Performance Requirements* in Section D are satisfied by complying with Vic H104.1 and Vic H104.2.

Vic H104.1 Application of Part

The *Deemed-to-Satisfy Provisions* of this Part apply to Class 9b *children's services*.

Vic H104.2 Doorways to a children's room

A children's room must have a doorway, or in the case of every such room accommodating more than 21 children at least two doorways as widely separated as possible, providing direct access to or from—

- (a) an outdoor play area; or
- (b) a passage leading to the outside; or
- (c) a fire-isolated *exit*.

Insert SECTION J ENERGY EFFICIENCY

SECTION J ENERGY EFFICIENCY

PART J7 HOT WATER SUPPLY AND SWIMMING POOL AND SPA POOL PLANT

Delete J7.2 and insert Vic J7.2 as follows:

Vic J7.2 * * * * *

This clause has deliberately been left blank.

Footnote: OTHER LEGISLATION AFFECTING BUILDINGS

In addition to any applicable provisions of the Building Act 1993, Building Regulations 2006 and this Code, there are a number of other legislative technical requirements affecting the design, construction and/or performance of buildings that practitioners may need to be aware of, including, but not necessarily limited to, the following list. Additional legislative instruments such as regulations, codes and standards may exist under the legislation listed.

1. Abattoirs and Knackeries

1.1 Administering Agency

Department of Primary Industries

Relevant Legislation

Meat Industry Act 1993

2. Accommodation – Residential (Boarding Houses, Guest Houses, Hostels, Motels)

2.1 Administering Agency

Department of Human Services

Municipal council

Relevant Legislation

Public Health and Wellbeing Act 2008

Public Health and Wellbeing Regulations 2009

3. Accommodation - Supported Residential Services

3.1 Administering Agency

Department of Health

Relevant Legislation

Health Services Act 1988

Health Services (Supported Residential Services) Regulations 2001

Supported Residential Services Design Guidelines

4. Alpine Resorts

4.1 Administering Agency

Department of Planning and Community Development

Alpine Resorts Management Boards

Relevant Legislation

Alpine Resorts (Management) Act 1997

5. Asbestos Removal

5.1 Administering Agency

Victorian WorkCover Authority

Environment Protection Authority

Relevant Legislation

Occupational Health and Safety Act 2004

Environment Protection Act 1970

6. Children's Services

6.1 Administering Agency

Department of Education and Early Childhood Development

Relevant Legislation

Children's Services Act 1996

Children's Services Regulations 2009

Education and Care Services National Law Act 2010

7. Crematoria, Mausolea, Vaults, etc.

7.1 Administering Agency

Department of Human Services, Cemeteries and Crematoria Program, Public Health Branch (crematoria, mausolea)

Cemetery Trusts (vaults)

Relevant Legislation

Cemeteries and Crematoria Act 2003

Cemeteries and Crematoria Regulations 2005

8. Crown Land

8.1 Administering Agency

Department of Planning and Community Development

Crown Land committees of management

Relevant Legislation

Crown Land (Reserves) Act 1978

9. Dairies

9.1 Administering Agency

Dairy Food Safety Victoria

Relevant Legislation

Dairy Act 2000

10. Dangerous Goods

10.1 Administering Agency

Victorian WorkCover Authority

Relevant Legislation

Dangerous Goods Act 1985

Dangerous Goods (Explosives) Regulations 2011

Dangerous Goods (HCDG) Regulations 2005

Dangerous Goods (Storage and Handling) Regulations 2000

Codes of practice published by the WorkCover Authority

11. Electrical Installations

11.1 Administering Agency

Energy Safe Victoria

Electrical transmission and distribution companies

Relevant Legislation

Electricity Industry Act 2000

Electricity Industry (Residual Provisions) Act 1993

Electricity Safety Act 1998

State Electricity Commission Act 1958

Electricity Safety (Installations) Regulations 2009

Standards Australia Wiring Rules, AS/NZS 3000/3013

12. Fences - dividing

12.1 Administering Agency

Department of Justice

Relevant Legislation

Fences Act 1968

13. Fire Prevention in Existing Buildings

13.1 Administering Agency

Municipal council

Relevant Legislation

Building Act 1993

Building Regulations 2006

14. Food Premises

14.1 Administering Agency

Department of Human Services

Municipal council

Relevant Legislation

Food Act 1984

15. Gas Installations

15.1 Administering Agency

Energy Safe Victoria

Relevant Legislation

Gas Industry Act 2001

Gas Safety Act 1997

Gas Safety (Gas Installation) Regulations 2008

AS5601 – 2004 Gas Installations

16. Historic Buildings

16.1 Administering Agency

Department of Planning and Community Development
Executive Director under the Heritage Act 1995

Relevant Legislation

Heritage Act 1995

17. Hospitals, Nursing Homes and Health Care Buildings

17.1 Administering Agency

Department of Health

Relevant Legislation

Public Health and Wellbeing Act 2008
Mental Health Act 1986

18. Lift Installations

18.1 Administering Agency

Victorian WorkCover Authority

Relevant Legislation

Occupational Health and Safety Act 2004
Occupational Health and Safety Regulations 2007
AS1735 Lifts, escalators and moving walks

19. Moveable Dwellings (in Caravan Parks)

19.1 Administering Agency

Department of Justice
Municipal council

Relevant Legislation

Residential Tenancies Act 1997
Residential Tenancies (Caravan Parks and Moveable Dwellings
Registration and Standards) Regulations 2010

20. Occupational Health and Safety

20.1 Administering Agency

Victorian WorkCover Authority

Relevant Legislation

Occupational Health and Safety Act 2004

Occupational Health and Safety Regulations 2007
Codes of practice published by the WorkCover Authority

21. Pharmacies

21.1 Administering Agency

Department of Health
Victorian Pharmacy Authority

Relevant Legislation

Pharmacy Regulation Act 2010
Guidelines for Good Pharmaceutical Practice 2010

22. Planning Controls

22.1 Administering Agency

Department of Planning and Community Development
Municipal council

Relevant Legislation

Planning and Environment Act 1987
Planning schemes

23. Prisons and Jails

23.1 Administering Agency

Department of Justice
Corrections Victoria

Relevant Legislation

Corrections Act 1986

24. Radiation Safety

24.1 Administering Agency

Department of Health

Relevant Legislation

Radiation Act 2005
Radiation Regulations 2007

25. Schools (Non-Government)

25.1 Administering Agency

Department of Education and Early Childhood Development
Registered Schools Board

Relevant Legislation

Education and Training Reform Act 2006

26. Sanitary Plumbing, Water Supply and Sewerage

26.1 Administering Agency

Plumbing Industry Commission

Relevant Legislation

Building Act 1993

Plumbing Regulations 2008

National Construction Code Volume Three Plumbing Code of Australia
AS/NZS3500 National Plumbing and Drainage Code

27 Septic Tank Installations

27.1 Administering Agency

Environment Protection Authority

Municipal council

Relevant Legislation

Environment Protection Act 1970

Guidelines For Environmental Management: Code of Practice-Onsite wastewater management

28. Smoking Restrictions

28.1 Administering Agency

Department of Human Services

Municipal council

Relevant Legislation

Tobacco Act 1987

29. Subdivision of Buildings

29.1 Administering Agency

Department of Planning and Community Development

Municipal council

Relevant Legislation

Subdivision Act 1988

WESTERN AUSTRALIA

INTRODUCTION

This Appendix contains variations and additions to the Building Code of Australia (BCA) provisions which are considered necessary for the effective application of the Code in Western Australia.

APPENDIX CONTENTS

APPENDIX WESTERN AUSTRALIA

Western Australia

G **ANCILLIARY PROVISIONS**

- WA GO1 Objective
- WA GF1.2 Functional Statement
- WA GP1.2 Performance Requirements
- WA G1.1 Swimming pools

Footnote: Other Legislation Affecting Buildings

SECTION G ANCILLARY PROVISIONS

PART G1 MINOR STRUCTURES AND COMPONENTS

Delete GO1(c) and insert WA GO1(c) as follows:

| |
|------------------|
| OBJECTIVE |
|------------------|

WA GO1

(c) * * * * *

Note:

The restriction of access to private *swimming pools* is regulated under the Building Act 2011 and the Building Regulations 2012.

Delete GF1.2(a) and insert WA GF1.2(a) as follows:

| |
|-----------------------------|
| FUNCTIONAL STATEMENT |
|-----------------------------|

WA GF1.2

A *swimming pool* is to be provided with—

(a) * * * * *

Note:

The restriction of access to private *swimming pools* is regulated under the Building Act 2011 and the Building Regulations 2012.

Delete GP1.2(a) and insert WA GP1.2(a) as follows:

| |
|---------------------------------|
| PERFORMANCE REQUIREMENTS |
|---------------------------------|

WA GP1.2

(a) * * * * *

Note:

The restriction of access to private *swimming pools* is regulated under the Building Act 2011 and the Building Regulations 2012.

Delete G1.1(a) and (b) and insert WA G1.1(a) and (b) as follows:

WA G1.1 Swimming pools

- (a) * * * * *
- (b) * * * * *

Note:

The restriction of access to private *swimming pools* is regulated under the Building Act 2011 and the Building Regulations 2012.

Footnote: OTHER LEGISLATION AFFECTING BUILDINGS

In addition to any applicable provisions of the Building Act 2011, Building Regulations 2012 and this Code, there are a number of other legislative technical requirements affecting the design, construction and/or performance of buildings that practitioners may need to be aware of, including, but not necessarily limited to, the following list. Additional legislative instruments such as regulations, codes and standards may exist under the legislation listed.

1. Building

1.1 Administering Agency

Building Commission, Department of Commerce

Relevant Legislation

Building Services (Complaint Resolution and Administration) Act 2011

Building Services (Complaint Resolution and Administration) Regulations 2011

Building Services (Registration) Act 2011

Building Services (Registration) Regulations 2011

2. Caravan Parks and Camping Grounds

2.1 Administering Agency

Department of Local Government

Relevant Legislation

Caravan Park and Camping Grounds Act 1995

Caravan Park and Camping Grounds Regulations 1997

3. Child Care

3.1 Administering Agency

Department for Communities

Relevant Legislation

Child Care Services Act 2007

Child Care Services Regulations 2007

Child Care Services (Child Care) Regulations 2006
Child Care Services (Family Day Care) Regulations 2006
Child Care Services (Outside School Hours Care) Regulations 2006
Child Care Services (Outside School Hours Family Day Care) Regulations 2006
Child Care Services (Rural Family Care) Regulations 2010

4. Fences

4.1 Administering Agency

Building Commission, Department of Commerce

Relevant Legislation

Dividing Fences Act 1961

5. Health

5.1 Administering Agency

Department of Health

Relevant Legislation

Health Act 1911

Health Act (Laundries & Bathrooms) Regulations

Health Act (Swimming Pools) Regulations 1964

Health (Air Handling and Water Systems) Regulations 1994

Health (Asbestos) Regulations 1992

Health (Aquatic Facilities) Regulations 2007

Health (Construction Work) Regulations 1973

Construction Camp Regulations

Health (Public Buildings) Regulations 1992

Health (Treatment of Sewage and Disposal of Effluent and Liquid Waste) Regulations 1974

Health (Rottnest Island) By-laws 1989

Health (Food Hygiene) Regulations 1993

Sewerage (Lighting, Ventilation and Construction) Regulations 1971

Model By-Laws Series 'A' and earlier versions where adopted by Local Government

Health Local Laws where adopted by Local Government

6. Heritage

6.1 Administering Agency

Heritage Council of Western Australia

Relevant Legislation

Heritage of Western Australia Act 1990

Heritage of Western Australia Regulations 1991

7. Hospitals and Health Services

7.1 Administering Agency

Department of Health

Relevant Legislation

Hospitals and Health Services Act 1927

8. Housing

8.1 Administering Agency

Department of Housing

Relevant Legislation

Housing Act 1980

9. Land

9.1 Administering Agency

Western Australian Land Information Authority

Relevant Legislation

Strata Titles Act 1985

10. Occupational Health and Safety

10.1 Administering Agency

WorkSafe, Department of Commerce

Relevant Legislation

Occupational Safety and Health Act 1984

11. Planning Controls

11.1 Administering Agency

Department for Planning

Relevant Legislation

Planning and Development Act 2005

Planning and Development (Consequential and Transitional Provisions) Act 2005

12. Public Works

12.1 Administering Agency

Building Management and Works, Department of Treasury and Finance

Relevant Legislation

Public Works Act 1902

INDEX, ABBREVIATIONS AND SYMBOLS

Index

Abbreviations and Symbols

CONTENTS

INDEX, ABBREVIATIONS AND SYMBOLS

Index

Abbreviations and Symbols

Index

A

Access for people with a disability

- D3.0** Deemed-to-Satisfy Provisions
- D3.1** General building access requirements
- D3.2** Access to buildings
- D3.3** Parts of buildings to be accessible
- D3.4** Exemptions
- D3.5** Accessible carparking
- D3.6** Signage
- D3.7** Hearing augmentation
- D3.8** Tactile indicators
- D3.9** Wheelchair seating spaces in Class 9b assembly buildings
- D3.10** Swimming pools
- D3.11** Ramps
- D3.12** Glazing on an accessway
- SPEC-D3.6** Braille and Tactile Signs
- SPEC-D3.10** Accessible water entry/exit for swimming pools

Access for people with a disability, Braille

- D3.6** Signage
- SPEC-D3.6** Braille and Tactile Signs

Access for people with a disability, carpark

- D3.5** Accessible carparking

Access for people with a disability, hearing augmentation

- D3.7** Hearing augmentation

Access for people with a disability, ramps

- D3.11** Ramps
- D3.12** Glazing on an accessway

Access for people with a disability, swimming pools

- D3.10** Swimming pools
- SPEC-D3.10** Accessible water entry/exit for swimming pools

Access for people with a disability, tactile indicators

- D3.8** Tactile indicators

Access for people with a disability, tactile signs

D3.6 Signage

SPEC-D3.6 Braille and Tactile Signs

Aged care building

C2.5 Class 9a and 9c buildings

D2.19 Doorways and doors

E3.8 Aged care buildings

SPEC-C2.5 Smoke-Proof Walls in Health-Care and Aged Care Buildings

Aged care building, lift

E3.8 Aged care buildings

Aged care building, smoke proof wall

SPEC-C2.5 Smoke-Proof Walls in Health-Care and Aged Care Buildings

Air movement, energy efficiency

J0.3 Ceiling fan

Air-conditioning, energy efficiency

J0.0 Deemed-to-Satisfy Provisions

J0.1 Application of Section J

J5.0 Deemed-to-Satisfy Provisions

J5.2 Air-conditioning and ventilation systems

J5.3 Time switch

J5.4 Heating and cooling systems

J5.5 Miscellaneous exhaust systems

Airlock

F4.9 Airlocks

Aisle lights

H1.7 Aisle lights in theatres

Alpine area

G4.0 Deemed-to-Satisfy Provisions

G4.1 Application of Part

G4.3 External doorways

G4.4 Emergency lighting

G4.5 External ramps

G4.6 Discharge of exits

G4.7 External trafficable structures

G4.8 Fire-fighting services and equipment

G4.9 Fire orders

Aluminium construction

B1.4 Determination of structural resistance of materials and forms of construction

Artificial lighting, energy efficiency

J0.0 Deemed-to-Satisfy Provisions

J0.1 Application of Section J

J6.0 Deemed-to-Satisfy Provisions

J6.2 Artificial lighting

J6.3 Interior artificial lighting and power control

J6.4 Interior decorative and display lighting

J6.5 Artificial lighting around the perimeter of a building

J6.6 Boiling water and chilled water storage units

SPEC-J6 Lighting and Power Control Devices

Atrium

C1.0 Deemed-to-Satisfy Provisions

C2.0 Deemed-to-Satisfy Provisions

C3.0 Deemed-to-Satisfy Provisions

D1.0 Deemed-to-Satisfy Provisions

D2.0 Deemed-to-Satisfy Provisions

D3.0 Deemed-to-Satisfy Provisions

E2.0 Deemed-to-Satisfy Provisions

G3.1 Atriums affected by this Part

SPEC-G3.8 Fire and Smoke Control Systems in Buildings Containing Atriums

Atrium construction

G3.1 Atriums affected by this Part

G3.2 Dimensions of atrium well

G3.3 Separation of atrium by bounding walls

G3.4 Construction of bounding walls

G3.5 Construction at balconies

G3.6 Separation at roof

G3.7 Means of egress

G3.8 Fire and smoke control systems

Atrium construction, fire and smoke control

G3.8 Fire and smoke control systems

Atrium, emergency warning and intercommunication

SPEC-G3.8-5 Fire and Smoke Control Systems in Buildings Containing Atriums - 5.
Sound Systems And Intercom Systems For Emergency Purposes

Atrium, fire and smoke control

SPEC-G3.8 Fire and Smoke Control Systems in Buildings Containing Atriums

Atrium, fire detection

SPEC-G3.8-4 Fire and Smoke Control Systems in Buildings Containing Atriums - 4. Fire Detection And Alarm System

Atrium, fire sprinkler system

SPEC-G3.8-2 Fire and Smoke Control Systems in Buildings Containing Atriums - 2. Automatic Fire Sprinkler System

Atrium, smoke control

SPEC-G3.8-3 Fire and Smoke Control Systems in Buildings Containing Atriums - 3. Smoke Control System

SPEC-G3.8-7 Fire and Smoke Control Systems in Buildings Containing Atriums - 7. System For Excluding Smoke From Fire-Isolated Exits

Atrium, standby power system

SPEC-G3.8-6 Fire and Smoke Control Systems in Buildings Containing Atriums - 6. Standby Power System

Attachments, fire resistance

SPEC-C1.1-2.4 Fire-Resisting Construction - 2.4 Attachments Not To Impair Fire-Resistance

B

Balcony, verandah

SPEC-C1.1-2.5 Fire-Resisting Construction - 2.5 General Concessions

Balustrade

D2.16 Balustrades or other barriers

D2.24 Protection of openable windows

BCA application

- A0.1** Adoption
- A0.2** BCA Volumes
- A0.3** BCA Structure
- A0.4** Compliance with the BCA
- A0.5** Meeting the Performance Requirements
- A0.6** Objectives and Functional Statements
- A0.7** Deemed-to-Satisfy Provisions
- A0.8** Alternative Solutions
- A0.9** Assessment Methods
- A0.10** Relevant Performance Requirements
- A1.2** Adoption of Standards and other references
- A1.3** Referenced Standards, etc
- A1.4** Differences between referenced documents and the BCA
- A1.5** Compliance with all Sections of the BCA
- A1.6** Application of the BCA to a particular State or Territory
- A1.7** Language

BCA application, Language

- A1.7** Language

BCA application, Standards

- A1.2** Adoption of Standards and other references
- A1.3** Referenced Standards, etc
- A1.4** Differences between referenced documents and the BCA
- SPEC-A1.3** Documents Adopted By Reference

BCA application, State/Territory Appendices

- A1.6** Application of the BCA to a particular State or Territory

Bounding construction

- C3.11** Bounding construction: Class 2, 3 and 4 buildings

Braille

- D3.6** Signage
- SPEC-D3.6** Braille and Tactile Signs

Building classification

- A3.1** Principles of classification
- A3.2** Classifications
- A3.3** Multiple classification
- A3.4** Parts with more than one classification

Building classification, multiple

A3.3 Multiple classification

A3.4 Parts with more than one classification

Building elements, fire resistance

SPEC-A2.3 Fire-Resistance of Building Elements

Building fabric, energy efficiency

J0.0 Deemed-to-Satisfy Provisions

J0.1 Application of Section J

J0.2 Heating and cooling loads of sole-occupancy units of a Class 2 building or a Class 4 part

J1.0 Deemed-to-Satisfy Provisions

Building occupant warning system

E2.0 Deemed-to-Satisfy Provisions

SPEC-E2.2a Smoke Detection and Alarm Systems

Building sealing, energy efficiency

J0.2 Heating and cooling loads of sole-occupancy units of a Class 2 building or a Class 4 part

J3.0 Deemed-to-Satisfy Provisions

J3.2 Chimneys and flues

J3.3 Roof lights

J3.4 Windows and doors

J3.5 Exhaust fans

J3.6 Construction of roofs, walls and floors

Buildings, united

A4.1 When buildings are united

A4.2 Alterations in a united building

Bushfire prone area

G5.0 Deemed-to-Satisfy Provisions

G5.1 Application of Part

G5.2 Protection

C

Carpark

D3.5 Accessible carparking

F4.11 Carparks

SPEC-C1.1-3.9 Fire-Resisting Construction - 3.9 Carparks

SPEC-C1.1-4.2 Fire-Resisting Construction - 4.2 Carparks

SPEC-C1.1-5.2 Fire-Resisting Construction - 5.2 Carparks

Carpark, access for people with a disability

D3.5 Accessible carparking

Carpark, Class2, 3

SPEC-C1.1-2.8 Fire-Resisting Construction - 2.8 Carparks In Class 2 And 3 Buildings

Carpark, Type A construction

SPEC-C1.1-3.9 Fire-Resisting Construction - 3.9 Carparks

Carpark, Type B construction

SPEC-C1.1-4.2 Fire-Resisting Construction - 4.2 Carparks

Carpark, Type C construction

SPEC-C1.1-5.2 Fire-Resisting Construction - 5.2 Carparks

Carpark, ventilation

F4.11 Carparks

Ceilings

A2.5 Resistance to the incipient spread of fire

Ceilings, fire resisting

A2.5 Resistance to the incipient spread of fire

Columns

C3.17 Columns protected with lightweight construction to achieve an FRL

Columns, protected with lightweight construction

C3.17 Columns protected with lightweight construction to achieve an FRL

Composite steel and concrete construction

B1.4 Determination of structural resistance of materials and forms of construction

Concrete construction

B1.4 Determination of structural resistance of materials and forms of construction

Construction joints

C3.16 Construction joints

Construction joints, protection

C3.16 Construction joints

Curtain wall, panel wall

SPEC-C1.1-2.5 Fire-Resisting Construction - 2.5 General Concessions

D

Damp and weatherproofing

F1.0 Deemed-to-Satisfy Provisions

F1.1 Stormwater drainage

F1.5 Roof coverings

F1.6 Sarking

F1.7 Water proofing of wet areas in buildings

F1.9 Damp-proofing

F1.10 Damp-proofing of floors on the ground

F1.11 Provision of floor wastes

F1.12 Sub-floor ventilation

F1.13 Glazed assemblies

Damp and weatherproofing, floor waste

F1.11 Provision of floor wastes

Damp and weatherproofing, glazing

F1.13 Glazed assemblies

Damp and weatherproofing, roof coverings

F1.5 Roof coverings

Damp and weatherproofing, sarking

F1.6 Sarking

Damp and weatherproofing, stormwater drainage

F1.1 Stormwater drainage

Damp and weatherproofing, sub-floor ventilation

F1.12 Sub-floor ventilation

damp and weatherproofing, wet areas

F1.7 Water proofing of wet areas in buildings

Definitions

A1.1 Definitions

Door, direction of swing

D2.20 Swinging doors

Door, latch

D2.21 Operation of latch

Door, sign

D2.23 Signs on doors

Door, sliding, revolving etc

D2.19 Doorways and doors

Doorway, protection in bounding construction

C3.11 Bounding construction: Class 2, 3 and 4 buildings

Ductwork, energy efficiency

SPEC-J5.2 Ductwork Insulation and Sealing

SPEC-J5.2-1 Ductwork Insulation and Sealing - 1. Scope

SPEC-J5.2-2 Ductwork Insulation and Sealing - 2. Ductwork Sealing

SPEC-J5.2-3 Ductwork Insulation and Sealing - 3. Ductwork Insulation

E

Early fire hazard indices

SPEC-A2.4 Fire Hazard Properties

SPEC-C1.10 Fire Hazard Properties

Electrical supply equipment

C2.13 Electricity supply system

Emergency (electrical) equipment

C2.13 Electricity supply system

Emergency lift

E3.4 Emergency lifts

Emergency lighting

E4.0 Deemed-to-Satisfy Provisions

E4.2 Emergency lighting requirements

E4.3 Measurement of distance

E4.4 Design and operation of emergency lighting

Emergency warning and intercommunication system

E4.0 Deemed-to-Satisfy Provisions

Energy efficiency

J0.0 Deemed-to-Satisfy Provisions

J0.1 Application of Section J

J0.2 Heating and cooling loads of sole-occupancy units of a Class 2 building or a Class 4 part

J1.0 Deemed-to-Satisfy Provisions

Energy efficiency, access for maintenance

- J0.1 Application of Section J
- J8.0 Deemed-to-Satisfy Provisions
- J8.2 Access for maintenance
- J8.3 Facilities for energy monitoring

Energy efficiency, air movement

- J0.3 Ceiling fan

Energy efficiency, air-conditioning

- J0.0 Deemed-to-Satisfy Provisions
- J0.1 Application of Section J
- J5.0 Deemed-to-Satisfy Provisions
- J5.2 Air-conditioning and ventilation systems
- J5.3 Time switch
- J5.4 Heating and cooling systems
- J5.5 Miscellaneous exhaust systems
- J6.6 Boiling water and chilled water storage units

Energy efficiency, artificial lighting

- J0.0 Deemed-to-Satisfy Provisions
- J0.1 Application of Section J
- J6.0 Deemed-to-Satisfy Provisions
- J6.2 Artificial lighting
- J6.3 Interior artificial lighting and power control
- J6.4 Interior decorative and display lighting
- J6.5 Artificial lighting around the perimeter of a building
- SPEC-J6 Lighting and Power Control Devices
- SPEC-J6-1 Lighting and Power Control Devices - 1. Scope
- SPEC-J6-2 Lighting and Power Control Devices - 2. Lighting Timers
- SPEC-J6-3 Lighting and Power Control Devices - 3. Time Switch
- SPEC-J6-4 Lighting and Power Control Devices - 4. Motion Detectors
- SPEC-J6-5 Lighting and Power Control Devices - 5. Daylight Sensor And Dynamic Lighting Control Device

Energy efficiency, building fabric

- J0.0 Deemed-to-Satisfy Provisions
- J0.1 Application of Section J
- J0.2 Heating and cooling loads of sole-occupancy units of a Class 2 building or a Class 4 part
- J1.0 Deemed-to-Satisfy Provisions

Energy efficiency, building sealing

J0.2 Heating and cooling loads of sole-occupancy units of a Class 2 building or a Class 4 part

J3.0 Deemed-to-Satisfy Provisions

Energy efficiency, ductwork

SPEC-J5.2 Ductwork Insulation and Sealing

SPEC-J5.2-1 Ductwork Insulation and Sealing - 1. Scope

SPEC-J5.2-2 Ductwork Insulation and Sealing - 2. Ductwork Sealing

SPEC-J5.2-3 Ductwork Insulation and Sealing - 3. Ductwork Insulation

Energy efficiency, evaporative cooler

J3.7 Evaporative coolers

Energy efficiency, floor construction

J1.6 Floors

SPEC-J1.6 Floor Construction

SPEC-J1.6-1 Floor Construction - 1. Scope

SPEC-J1.6-2 Floor Construction - 2. Construction Deemed-To-Satisfy

Energy efficiency, glazing

J2.0 Deemed-to-Satisfy Provisions

J2.1 Application of Part

J2.4 Glazing

Energy efficiency, hot water supply

J0.0 Deemed-to-Satisfy Provisions

J0.1 Application of Section J

J7.0 Deemed-to-Satisfy Provisions

J7.2 Hot water supply

J7.3 Swimming pool heating and pumping

J7.4 Spa pool heating and pumping

Energy efficiency, maintenance

I2.0 Deemed-to-Satisfy Provisions

I2.1 Application of Part

I2.2 Components of services

Energy efficiency, material properties

SPEC-J1.2 Material Properties

SPEC-J1.2-1 Material Properties - 1. Scope

SPEC-J1.2-2 Material Properties - 2. Construction Deemed-To-Satisfy

Energy efficiency, piping, vessels, heat exchangers and tanks

SPEC-J5.4 Insulating of Piping, Vessels, Heat Exchangers and Tanks

SPEC-J5.4-1 Insulating of Piping, Vessels, Heat Exchangers and Tanks - 1. Scope

SPEC-J5.4-2 Insulating of Piping, Vessels, Heat Exchangers and Tanks - 2. Insulation

Energy efficiency, power control

J0.0 Deemed-to-Satisfy Provisions

J0.1 Application of Section J

J5.3 Time switch

J6.0 Deemed-to-Satisfy Provisions

J6.3 Interior artificial lighting and power control

SPEC-J6 Lighting and Power Control Devices

SPEC-J6-1 Lighting and Power Control Devices - 1. Scope

SPEC-J6-2 Lighting and Power Control Devices - 2. Lighting Timers

SPEC-J6-3 Lighting and Power Control Devices - 3. Time Switch

SPEC-J6-4 Lighting and Power Control Devices - 4. Motion Detectors

SPEC-J6-5 Lighting and Power Control Devices - 5. Daylight Sensor And Dynamic Lighting Control Device

Energy efficiency, roof and ceiling construction

J1.3 Roof and ceiling construction

SPEC-J1.3 Roof and Ceiling Construction

SPEC-J1.3-1 Roof and Ceiling Construction - 1. Scope

SPEC-J1.3-2 Roof and Ceiling Construction - 2. Construction Deemed-To-Satisfy

Energy efficiency, roof lights

J1.4 Roof lights

Energy efficiency, sealing of chimneys and flues

J3.2 Chimneys and flues

Energy efficiency, sealing of exhaust fans

J3.5 Exhaust fans

Energy efficiency, sealing of external windows and doors

J3.4 Windows and doors

Energy efficiency, sealing of roof lights

J3.3 Roof lights

Energy efficiency, sealing of roofs, walls and floors

J3.6 Construction of roofs, walls and floors

Energy efficiency, shading

J2.5 Shading

Energy efficiency, thermal construction

J1.2 Thermal construction — general

Energy efficiency, ventilation systems

J0.0 Deemed-to-Satisfy Provisions

J0.1 Application of Section J

J5.0 Deemed-to-Satisfy Provisions

J5.2 Air-conditioning and ventilation systems

J5.3 Time switch

J5.5 Miscellaneous exhaust systems

Energy efficiency, Verification Method

JV3 Energy Efficiency - JV3 Verification Using A Reference Building

SPEC-JV Annual Energy Consumption Criteria

Energy efficiency, wall construction

J1.5 Walls

SPEC-J1.5 Wall Construction

SPEC-J1.5-1 Wall Construction - 1. Scope

SPEC-J1.5-2 Wall Construction - 2. Construction Deemed-To-Satisfy

Evaporative cooler, energy efficiency

J3.7 Evaporative coolers

Exit

- C3.8** Openings in fire-isolated exits
- C3.9** Service penetrations in fire-isolated exits
- D1.0** Deemed-to-Satisfy Provisions
 - D1.1** Application of Part
 - D1.2** Number of exits required
 - D1.3** When fire-isolated exits are required
 - D1.4** Exit travel distances
 - D1.5** Distance between alternative exits
 - D1.6** Dimensions of exits and paths of travel to exits
 - D1.7** Travel via fire-isolated exits
 - D1.8** External stairways or ramps in lieu of fire-isolated exits
 - D1.9** Travel by non-fire-isolated stairways or ramps
 - D1.10** Discharge from exits
 - D1.11** Horizontal exits
 - D1.13** Number of persons accommodated
 - D1.14** Measurement of distances
 - D1.15** Method of measurement
 - D1.16** Plant rooms and lift machine rooms: Concession
- D2.0** Deemed-to-Satisfy Provisions

Exit, alternative exit

- D1.5** Distance between alternative exits

Exit, construction

- D2.0 Deemed-to-Satisfy Provisions
- D2.1 Application of Part
- D2.2 Fire-isolated stairways and ramps
- D2.3 Non-fire-isolated stairways and ramps
- D2.4 Separation of rising and descending stair flights
- D2.5 Open access ramps and balconies
- D2.6 Smoke lobbies
- D2.7 Installations in exits and paths of travel
- D2.8 Enclosure of space under stairs and ramps
- D2.9 Width of stairways and ramps
- D2.10 Pedestrian ramps
- D2.11 Fire-isolated passageways
- D2.12 Roof as open space
- D2.13 Goings and risers
- D2.14 Landings
- D2.15 Thresholds
- D2.16 Balustrades or other barriers
- D2.17 Handrails
- D2.18 Fixed platforms, walkways, stairways and ladders
- D2.19 Doorways and doors
- D2.20 Swinging doors
- D2.21 Operation of latch
- D2.22 Re-entry from fire-isolated exits
- D2.23 Signs on doors
- D2.24 Protection of openable windows

Exit, construction, balustrade

- D2.16 Balustrades or other barriers
- D2.24 Protection of openable windows

Exit, construction, door sign

- D2.23 Signs on doors

Exit, construction, door threshold

- D2.15 Thresholds

Exit, construction, doorway and door

- D2.19 Doorways and doors

Exit, construction, enclosure of space

D2.8 Enclosure of space under stairs and ramps

Exit, construction, fire-isolated passageway

D2.11 Fire-isolated passageways

Exit, construction, fire-isolated stairway and ramp

D2.2 Fire-isolated stairways and ramps

Exit, construction, fixed platforms, walkways, stairways and ladders

D2.18 Fixed platforms, walkways, stairways and ladders

Exit, construction, handrail

D2.17 Handrails

Exit, construction, installations in exits

D2.7 Installations in exits and paths of travel

Exit, construction, installations in path of travel

D2.7 Installations in exits and paths of travel

Exit, construction, landing

D2.14 Landings

Exit, construction, latch

D2.21 Operation of latch

Exit, construction, non-fire-isolated stairway and ramp

D2.3 Non-fire-isolated stairways and ramps

Exit, construction, open access ramp or balcony

D2.5 Open access ramps and balconies

Exit, construction, ramp

D2.10 Pedestrian ramps

Exit, construction, re-entry

D2.22 Re-entry from fire-isolated exits

Exit, construction, rising and descending stair flights

D2.4 Separation of rising and descending stair flights

Exit, construction, smoke lobby

D2.6 Smoke lobbies

Exit, construction, stairway

D2.13 Goings and risers

Exit, construction, swinging door

D2.20 Swinging doors

Exit, construction, use of roof

D2.12 Roof as open space

Exit, construction, width of ramp

D2.9 Width of stairways and ramps

Exit, construction, width of stairway

D2.9 Width of stairways and ramps

Exit, dimensions

D1.6 Dimensions of exits and paths of travel to exits

Exit, discharge

D1.10 Discharge from exits

Exit, external stairs in lieu

D1.8 External stairways or ramps in lieu of fire-isolated exits

Exit, fire-isolated

C3.8 Openings in fire-isolated exits

C3.9 Service penetrations in fire-isolated exits

D1.3 When fire-isolated exits are required

D1.7 Travel via fire-isolated exits

Exit, fire-isolated, protection of openings

C3.8 Openings in fire-isolated exits

Exit, fire-isolated, service penetrations

C3.9 Service penetrations in fire-isolated exits

Exit, horizontal

D1.11 Horizontal exits

Exit, measurement of distance

D1.14 Measurement of distances

Exit, method of measurement of distance

D1.15 Method of measurement

Exit, non-fire-isolated

D1.9 Travel by non-fire-isolated stairways or ramps

Exit, number of persons accommodated

D1.13 Number of persons accommodated

Exit, number required

D1.2 Number of exits required

Exit, plant room lift machine room

D1.16 Plant rooms and lift machine rooms: Concession

Exit, re-entry

D2.22 Re-entry from fire-isolated exits

Exit, sign

- E4.0** Deemed-to-Satisfy Provisions
- E4.5** Exit signs
- E4.6** Direction signs
- E4.7** Class 2 and 3 buildings and Class 4 parts: Exemptions
- E4.8** Design and operation of exit signs

External stairs

- D1.8** External stairways or ramps in lieu of fire-isolated exits

External wall

- C1.11** Performance of external walls in fire
- C3.2** Protection of openings in external walls
- C3.3** Separation of external walls and associated openings in different fire compartments
- SPEC-C1.11** Performance of External Walls in Fire

External wall, fire resistance

- C1.11** Performance of external walls in fire

External wall, performance in fire

- SPEC-C1.11** Performance of External Walls in Fire

External wall, protection of path of travel

- D1.7** Travel via fire-isolated exits

F

Fencing, early childhood centres

- G1.3** Fencing for early childhood centres

Fire compartmentation

- C2.2** General floor area and volume limitations

Fire compartmentation and separation

- C2.0** Deemed-to-Satisfy Provisions
- C2.1** Application of Part
- C2.5** Class 9a and 9c buildings
- C2.7** Separation by fire walls

Fire compartmentation and separation, aged care building

- C2.5** Class 9a and 9c buildings

Fire compartmentation and separation, fire wall

- C2.7** Separation by fire walls

Fire compartmentation and separation, health-care building

- C2.5** Class 9a and 9c buildings

Fire control centre

E1.8 Fire control centres

SPEC-E1.8 Fire Control Centres

Fire detection, atrium

SPEC-G3.8-4 Fire and Smoke Control Systems in Buildings Containing Atriums - 4. Fire Detection And Alarm System

Fire door

C3.6 Sliding fire doors

Fire door, construction

SPEC-C3.4 Fire Doors, Smoke Doors, Fire Windows and Shutters

Fire door, sliding

C3.6 Sliding fire doors

Fire extinguisher

E1.6 Portable fire extinguishers

Fire fighting equipment

E1.0 Deemed-to-Satisfy Provisions

E1.3 Fire hydrants

E1.4 Fire hose reels

E1.5 Sprinklers

E1.6 Portable fire extinguishers

E1.8 Fire control centres

E1.9 Fire precautions during construction

E1.10 Provision for special hazards

Fire fighting equipment, fire control centre

E1.8 Fire control centres

Fire fighting equipment, fire extinguisher

E1.6 Portable fire extinguishers

Fire fighting equipment, fire hose reel

E1.4 Fire hose reels

Fire fighting equipment, fire hydrant

E1.3 Fire hydrants

Fire fighting equipment, fire precautions during construction

E1.9 Fire precautions during construction

Fire fighting equipment, fire sprinkler system

E1.5 Sprinklers

Fire fighting equipment, provisions for special hazards

E1.10 Provision for special hazards

Fire hazard properties

A2.4 Fire hazard properties

C1.10 Fire hazard properties

SPEC-A2.4 Fire Hazard Properties

SPEC-C1.10 Fire Hazard Properties

Fire hose reel

E1.4 Fire hose reels

Fire hydrant

E1.3 Fire hydrants

Fire precautions during construction

E1.9 Fire precautions during construction

Fire resistance

A2.3 Fire-resistance of building elements

C1.0 Deemed-to-Satisfy Provisions

C1.1 Type of construction required

C1.2 Calculation of rise in storeys

C1.3 Buildings of multiple classification

C1.4 Mixed types of construction

C1.5 Two storey Class 2, 3 or 9c buildings

C1.6 Class 4 parts of buildings

C1.7 Open spectator stands and indoor sports stadiums

C1.8 Lightweight construction

C1.11 Performance of external walls in fire

SPEC-A2.3 Fire-Resistance of Building Elements

Fire resistance, external wall

C1.11 Performance of external walls in fire

Fire resistance, lightweight construction

C1.8 Lightweight construction

Fire resistance, type of construction

C1.1 Type of construction required

C1.5 Two storey Class 2, 3 or 9c buildings

C1.6 Class 4 parts of buildings

C1.7 Open spectator stands and indoor sports stadiums

Fire separation

C2.6 Vertical separation of openings in external walls

C2.8 Separation of classifications in the same storey

C2.9 Separation of classifications in different storeys

C2.10 Separation of lift shafts

C2.11 Stairways and lifts in one shaft

C2.12 Separation of equipment

C2.13 Electricity supply system

Fire separation, electrical supply equipment

C2.13 Electricity supply system

Fire separation, equipment

C2.12 Separation of equipment

Fire separation, lift and stairway shaft

C2.11 Stairways and lifts in one shaft

Fire separation, lift shaft

C2.10 Separation of lift shafts

Fire separation, multiple classification in different storeys

C2.9 Separation of classifications in different storeys

Fire separation, multiple classification in same storey

C2.8 Separation of classifications in the same storey

Fire separation, openings in external wall

C2.6 Vertical separation of openings in external walls

Fire service drive control switch

E3.10 Lift car fire service drive control switch

Fire shutter, construction

SPEC-C3.4 Fire Doors, Smoke Doors, Fire Windows and Shutters

Fire sprinkler system

E1.5 Sprinklers

SPEC-E1.5 Fire Sprinkler Systems

Fire sprinkler system, atrium

SPEC-G3.8-2 Fire and Smoke Control Systems in Buildings Containing Atriums - 2.
Automatic Fire Sprinkler System

Fire stopping, service penetrations

SPEC-C3.15 Penetration of Walls, Floors and Ceilings by Services

Fire wall

C2.7 Separation by fire walls

C3.5 Doorways in fire walls

C3.6 Sliding fire doors

Fire wall, protection of doorway

C3.5 Doorways in fire walls

Fire window, construction

SPEC-C3.4 Fire Doors, Smoke Doors, Fire Windows and Shutters

Fire-isolated passageway, construction

D2.11 Fire-isolated passageways

Fire-resisting construction

SPEC-C1.1 Fire-Resisting Construction

Fire-resisting construction, attachments

SPEC-C1.1-2.4 Fire-Resisting Construction - 2.4 Attachments Not To Impair Fire-Resistance

Fire-resisting construction, carpark

SPEC-C1.1-2.8 Fire-Resisting Construction - 2.8 Carparks In Class 2 And 3 Buildings

Fire-resisting construction, concessions

SPEC-C1.1-2.5 Fire-Resisting Construction - 2.5 General Concessions

Fire-resisting construction, fire-source feature

SPEC-C1.1-2.1 Fire-Resisting Construction - 2.1 Exposure To Fire-Source Features

Fire-resisting construction, lintel

SPEC-C1.1-2.3 Fire-Resisting Construction - 2.3 Lintels

Fire-resisting construction, mezzanine floor

SPEC-C1.1-2.6 Fire-Resisting Construction - 2.6 Mezzanine Floors: Concession

Fire-resisting construction, residential aged care building

SPEC-C1.1-2.9 Fire-Resisting Construction - 2.9 Residential Aged Care Building: Concession

Fire-resisting construction, shaft

SPEC-C1.1-2.7 Fire-Resisting Construction - 2.7 Enclosure Of Shafts

Fire-resisting construction, support of another part

SPEC-C1.1-2.2 Fire-Resisting Construction - 2.2 Fire Protection For A Support Of Another Part

Fire-resisting construction, Type A

SPEC-C1.1-3 Fire-Resisting Construction - 3. Type A Fire-Resisting Construction

Fire-resisting construction, Type B

SPEC-C1.1-4 Fire-Resisting Construction - 4. Type B Fire-Resisting Construction

Fire-resisting construction, Type C

SPEC-C1.1-5 Fire-Resisting Construction - 5. Type C Fire-Resisting Construction

Fire-retardant coating

C1.10 Fire hazard properties

Fire-source feature

SPEC-C1.1-2.1 Fire-Resisting Construction - 2.1 Exposure To Fire-Source Features

Fireplace

G2.0 Deemed-to-Satisfy Provisions

G2.3 Open fireplaces

Flood

B1.6 Construction of buildings in flood hazard areas

Floor area and volume limitations

C2.2 General floor area and volume limitations

C2.3 Large Isolated Buildings

Floor area and volume limitations, type of construction

C2.2 General floor area and volume limitations

C2.3 Large Isolated Buildings

Floor construction, energy efficiency

J1.6 Floors

SPEC-J1.6 Floor Construction

SPEC-J1.6-1 Floor Construction - 1. Scope

SPEC-J1.6-2 Floor Construction - 2. Construction Deemed-To-Satisfy

Floor waste

F1.11 Provision of floor wastes

Flooring, particle board

B1.4 Determination of structural resistance of materials and forms of construction

G

Glazing

B1.4 Determination of structural resistance of materials and forms of construction

D3.12 Glazing on an accessway

F1.13 Glazed assemblies

Glazing, energy efficiency

J2.0 Deemed-to-Satisfy Provisions

J2.1 Application of Part

J2.4 Glazing

Going and risers, stairway

D2.13 Goings and risers

H

Handrail

D2.17 Handrails

Health-care building

C2.5 Class 9a and 9c buildings

SPEC-C2.5 Smoke-Proof Walls in Health-Care and Aged Care Buildings

Health-care building, smoke-proof wall

SPEC-C2.5 Smoke-Proof Walls in Health-Care and Aged Care Buildings

Hearing augmentation

D3.7 Hearing augmentation

Heating appliance

G2.0 Deemed-to-Satisfy Provisions

G2.2 Installation of appliances

Heating appliance, fireplace

G2.3 Open fireplaces

Heating appliance, incinerator

G2.4 Incinerator rooms

Horizontal exit

C3.7 Protection of doorways in horizontal exits

D1.11 Horizontal exits

Horizontal exit, protection

C3.7 Protection of doorways in horizontal exits

Hot water supply, energy efficiency

J0.0 Deemed-to-Satisfy Provisions

J0.1 Application of Section J

J7.0 Deemed-to-Satisfy Provisions

J7.2 Hot water supply

J7.3 Swimming pool heating and pumping

J7.4 Spa pool heating and pumping

I

Impact sound

SPEC-F5.5 Impact Sound - Test of Equivalence

Incinerator

G2.0 Deemed-to-Satisfy Provisions

G2.4 Incinerator rooms

K

Kitchen exhaust

F4.12 Kitchen local exhaust ventilation

L

Landing, construction

D2.14 Landings

Language

A1.7 Language

Large isolated buildings

C2.3 Large Isolated Buildings

C2.4 Requirements for open spaces and vehicular access

Legionella control

F2.7 Microbial (legionella) control

Lift

C3.10 Openings in fire-isolated lift shafts

E3.0 Deemed-to-Satisfy Provisions

E3.2 Stretcher facility in lifts

E3.3 Warning against use of lifts in fire

E3.4 Emergency lifts

E3.5 Landings

E3.6 Passenger lifts

E3.7 Fire service controls

E3.8 Aged care buildings

E3.9 Fire service recall operation switch

E3.10 Lift car fire service drive control switch

Lift and stairway shaft

C2.11 Stairways and lifts in one shaft

Lift cars

SPEC-C1.10 Fire Hazard Properties

Lift installations

SPEC-E3.1 Lift Installations

Lift shaft

B1.4 Determination of structural resistance of materials and forms of construction

C2.10 Separation of lift shafts

Lift, aged care building

E3.8 Aged care buildings

Lift, car

E3.10 Lift car fire service drive control switch

Lift, emergency

E3.4 Emergency lifts

Lift, fire service control

E3.7 Fire service controls

Lift, fire service recall operation switch

E3.9 Fire service recall operation switch

Lift, landing

E3.5 Landings

Lift, openings in fire-isolated shaft

C3.10 Openings in fire-isolated lift shafts

Lift, people with a disability

E3.6 Passenger lifts

Lift, stretcher facility

E3.2 Stretcher facility in lifts

Lift, warning

E3.3 Warning against use of lifts in fire

Light

F4.0 Deemed-to-Satisfy Provisions

Light, artificial

F4.4 Artificial lighting

Light, natural

F4.1 Provision of natural light

F4.2 Methods and extent of natural lighting

F4.3 Natural light borrowed from adjoining room

Lightweight construction

C1.8 Lightweight construction

C3.17 Columns protected with lightweight construction to achieve an FRL

SPEC-C1.8 Structural Tests for Lightweight Construction

Lightweight construction, protection of columns

C3.17 Columns protected with lightweight construction to achieve an FRL

Lightweight construction, structural tests

SPEC-C1.8 Structural Tests for Lightweight Construction

Lintel

SPEC-C1.1-2.3 Fire-Resisting Construction - 2.3 Lintels

M

Maintenance

I1.0 Deemed-to-Satisfy Provisions

I1.1 Safety measures

I1.2 Mechanical ventilation and hot water, warm water and cooling water systems

I2.0 Deemed-to-Satisfy Provisions

I2.1 Application of Part

I2.2 Components of services

Masonry construction

B1.4 Determination of structural resistance of materials and forms of construction

Materials

A2.1 Suitability of materials

A2.2 Evidence of suitability

A2.3 Fire-resistance of building elements

A2.4 Fire hazard properties

C1.10 Fire hazard properties

C1.12 Non-combustible materials

SPEC-A2.3 Fire-Resistance of Building Elements

SPEC-A2.4 Fire Hazard Properties

SPEC-C1.10 Fire Hazard Properties

Materials, fire hazard properties

A2.4 Fire hazard properties

C1.10 Fire hazard properties

SPEC-A2.4 Fire Hazard Properties

SPEC-C1.10 Fire Hazard Properties

Materials, fire resistance

A2.3 Fire-resistance of building elements

SPEC-A2.3 Fire-Resistance of Building Elements

Materials, non-combustible

C1.12 Non-combustible materials

Materials, suitability

A2.1 Suitability of materials

A2.2 Evidence of suitability

Mezzanine

C1.2 Calculation of rise in storeys

Mezzanine floor

SPEC-C1.1-2.6 Fire-Resisting Construction - 2.6 Mezzanine Floors: Concession

Minor structure

G1.0 Deemed-to-Satisfy Provisions

G1.1 Swimming pools

G1.2 Refrigerated chambers, strong-rooms and vaults

G1.3 Fencing for early childhood centres

Minor structure, refrigerated chamber, strong room, vault

G1.2 Refrigerated chambers, strong-rooms and vaults

Minor structure, swimming pool

G1.1 Swimming pools

Multiple classification

A3.3 Multiple classification

A3.4 Parts with more than one classification

C1.3 Buildings of multiple classification

Multiple classification in different storeys

C2.9 Separation of classifications in different storeys

Multiple classification in same storey

C2.8 Separation of classifications in the same storey

N

Non required, stairway, ramp, escalator

D1.12 Non-required stairways, ramps or escalators

Non-combustible materials

C1.12 Non-combustible materials

Number of persons accommodated

D1.13 Number of persons accommodated

O

Open space

C2.4 Requirements for open spaces and vehicular access

Open spectator stand, indoor sports stadium

C1.7 Open spectator stands and indoor sports stadiums

SPEC-C1.1-3.8 Fire-Resisting Construction - 3.8 Open Spectator Stands And Indoor Sports Stadiums: Concession

Openings in external wall

C2.6 Vertical separation of openings in external walls

Openings, method of protection

C3.4 Acceptable methods of protection

Openings, protection

C3.0 Deemed-to-Satisfy Provisions

C3.1 Application of Part

C3.2 Protection of openings in external walls

C3.3 Separation of external walls and associated openings in different fire compartments

C3.4 Acceptable methods of protection

C3.5 Doorways in fire walls

C3.6 Sliding fire doors

C3.7 Protection of doorways in horizontal exits

C3.8 Openings in fire-isolated exits

C3.9 Service penetrations in fire-isolated exits

C3.10 Openings in fire-isolated lift shafts

C3.12 Openings in floors and ceilings for services

C3.13 Openings in shafts

C3.15 Openings for service installations

C3.16 Construction joints

Openings, protection, atrium

C3.0 Deemed-to-Satisfy Provisions

Openings, protection, construction joints

C3.16 Construction joints

Openings, protection, doorway in fire wall

C3.5 Doorways in fire walls

C3.6 Sliding fire doors

Openings, protection, doorway in horizontal exit

C3.7 Protection of doorways in horizontal exits

Openings, protection, external wall

C3.2 Protection of openings in external walls

C3.3 Separation of external walls and associated openings in different fire compartments

Openings, protection, fire-isolated exit

C3.8 Openings in fire-isolated exits

Openings, protection, in fire-isolated lift shaft

C3.10 Openings in fire-isolated lift shafts

Openings, protection, openings in shaft

C3.13 Openings in shafts

Openings, protection, service penetrations

C3.15 Openings for service installations

Openings, protection, service penetrations in fire-isolated exit

C3.9 Service penetrations in fire-isolated exits

Openings, protection, service penetrations in floors and ceilings

C3.12 Openings in floors and ceilings for services

Openings, protection, theatre, stage and public hall

C3.0 Deemed-to-Satisfy Provisions

P

Path of travel

D1.6 Dimensions of exits and paths of travel to exits

D2.7 Installations in exits and paths of travel

Path of travel, dimensions

D1.6 Dimensions of exits and paths of travel to exits

Path of travel, installations within

D2.7 Installations in exits and paths of travel

Path of travel, protection of external wall

D1.7 Travel via fire-isolated exits

People with a disability, lift

E3.6 Passenger lifts

People with a disability, sanitary facilities

F2.2 Calculation of number of occupants and fixtures

F2.4 Accessible sanitary facilities

Piling

B1.4 Determination of structural resistance of materials and forms of construction

Piping, vessels, heat exchangers and tanks, energy efficiency

SPEC-J5.4 Insulating of Piping, Vessels, Heat Exchangers and Tanks

SPEC-J5.4-1 Insulating of Piping, Vessels, Heat Exchangers and Tanks - 1. Scope

SPEC-J5.4-2 Insulating of Piping, Vessels, Heat Exchangers and Tanks - 2. Insulation

Power control, energy efficiency

J0.0 Deemed-to-Satisfy Provisions

J0.1 Application of Section J

J5.3 Time switch

J6.0 Deemed-to-Satisfy Provisions

J6.3 Interior artificial lighting and power control

SPEC-J6 Lighting and Power Control Devices

Proscenium wall

H1.3 Proscenium wall construction

SPEC-H1.3 Construction of Theatres with Proscenium Walls

Public corridor

C2.14 Public corridors in Class 2 and 3 buildings

Public transport

H2.1 Application of Part

H2.2 Accessways

H2.3 Ramps

H2.4 Handrails and grabrails

H2.5 Doorways and doors

H2.6 Lifts

H2.7 Stairways

H2.8 Unisex accessible toilet

H2.9 Location of accessible toilets

H2.10 Symbols and signs

H2.11 Tactile ground surface indicators

H2.12 Lighting

H2.13 Hearing augmentation

H2.14 Emergency warning systems

H2.15 Controls

Pumps

F5.7 Sound isolation of pumps

R

Ramp

D2.8 Enclosure of space under stairs and ramps

D2.10 Pedestrian ramps

D3.11 Ramps

Ramp, construction, width

D2.9 Width of stairways and ramps

Refrigerated chamber, strong room, vault

G1.2 Refrigerated chambers, strong-rooms and vaults

Residential aged care building

SPEC-C1.1-2.9 Fire-Resisting Construction - 2.9 Residential Aged Care Building:
Concession

Resistance to the incipient spread of fire

A2.5 Resistance to the incipient spread of fire

Rise in storeys

C1.2 Calculation of rise in storeys

Roof and ceiling construction, energy efficiency

J1.3 Roof and ceiling construction

SPEC-J1.3 Roof and Ceiling Construction

SPEC-J1.3-1 Roof and Ceiling Construction - 1. Scope

SPEC-J1.3-2 Roof and Ceiling Construction - 2. Construction Deemed-To-Satisfy

Roof construction

B1.4 Determination of structural resistance of materials and forms of construction

Roof coverings

F1.5 Roof coverings

Roof lights, energy efficiency

J1.4 Roof lights

Rooflight

SPEC-C1.1-3.6 Fire-Resisting Construction - 3.6 Rooflights

Room heights

F3.0 Deemed-to-Satisfy Provisions

F3.1 Height of rooms and other spaces

S

Sanitary and other facilities

- F2.0 Deemed-to-Satisfy Provisions
- F2.1 Facilities in residential buildings
- F2.2 Calculation of number of occupants and fixtures
- F2.3 Facilities in Class 3 to 9 buildings
- F2.4 Accessible sanitary facilities
- F2.5 Construction of sanitary compartments
- F2.6 Interpretation: Urinals and washbasins
- F2.7 Microbial (legionella) control
- F2.8 Waste management

Sanitary and other facilities, construction of sanitary compartment

- F2.5 Construction of sanitary compartments

Sanitary and other facilities, legionella control

- F2.7 Microbial (legionella) control

Sanitary and other facilities, urinals and washbasins

- F2.6 Interpretation: Urinals and washbasins

Sanitary and other facilities, waste management

- F2.8 Waste management

Sarking

- F1.6 Sarking

Service penetrations

- C3.9 Service penetrations in fire-isolated exits
- C3.12 Openings in floors and ceilings for services
- C3.15 Openings for service installations

Service penetrations, fire-isolated exits

- C3.9 Service penetrations in fire-isolated exits

Service penetrations, protection of openings

- C3.12 Openings in floors and ceilings for services
- C3.15 Openings for service installations
- SPEC-C3.15 Penetration of Walls, Floors and Ceilings by Services

Shading, energy efficiency

- J2.5 Shading

Shaft

C3.13 Openings in shafts

SPEC-C1.1-2.7 Fire-Resisting Construction - 2.7 Enclosure Of Shafts

Shaft, enclosure

SPEC-C1.1-2.7 Fire-Resisting Construction - 2.7 Enclosure Of Shafts

Shaft, protection of openings

C3.13 Openings in shafts

Smoke alarm system

SPEC-E2.2a Smoke Detection and Alarm Systems

Smoke and heat vents

SPEC-E2.2c Smoke-and-Heat Vents

Smoke control, atrium

SPEC-G3.8-3 Fire and Smoke Control Systems in Buildings Containing Atriums - 3. Smoke Control System

SPEC-G3.8-7 Fire and Smoke Control Systems in Buildings Containing Atriums - 7. System For Excluding Smoke From Fire-Isolated Exits

Smoke detection and alarm system

E2.0 Deemed-to-Satisfy Provisions

SPEC-E2.2a Smoke Detection and Alarm Systems

Smoke door, construction

SPEC-C3.4 Fire Doors, Smoke Doors, Fire Windows and Shutters

Smoke exhaust system

SPEC-E2.2b Smoke Exhaust Systems

Smoke hazard management

E2.0 Deemed-to-Satisfy Provisions

E2.1 Application of Part

E2.2 General requirements

E2.3 Provision for special hazards

Smoke hazard management system

SPEC-E2.2b Smoke Exhaust Systems

SPEC-E2.2c Smoke-and-Heat Vents

Smoke hazard management system, smoke and heat vents

SPEC-E2.2c Smoke-and-Heat Vents

Smoke hazard management system, smoke exhaust system

SPEC-E2.2b Smoke Exhaust Systems

Smoke hazard management, special hazards

E2.3 Provision for special hazards

Smoke lobby

D2.6 Smoke lobbies

Smoke separation

C2.14 Public corridors in Class 2 and 3 buildings

Smoke separation, public corridor

C2.14 Public corridors in Class 2 and 3 buildings

Smoke-proof wall

SPEC-C2.5 Smoke-Proof Walls in Health-Care and Aged Care Buildings

Soil and waste pipes

F5.6 Sound insulation rating of services

Sound

E4.9 Sound systems and intercom systems for emergency purposes

Sound system and intercom system for emergency purposes, atrium

SPEC-G3.8-5 Fire and Smoke Control Systems in Buildings Containing Atriums - 5.
Sound Systems And Intercom Systems For Emergency Purposes

Sound transmission and insulation

F5.0 Deemed-to-Satisfy Provisions

F5.1 Application of Part

F5.2 Determination of airborne sound insulation ratings

F5.3 Determination of impact sound insulation ratings

F5.4 Sound insulation rating of floors

F5.5 Sound insulation rating of walls

F5.6 Sound insulation rating of services

F5.7 Sound isolation of pumps

SPEC-F5.2 Sound Insulation for Building Elements

SPEC-F5.5 Impact Sound - Test of Equivalence

Sound transmission and insulation, impact sound

SPEC-F5.5 Impact Sound - Test of Equivalence

Sound transmission and insulation, pumps

F5.7 Sound isolation of pumps

Sound transmission and insulation, soil and waste pipes

F5.6 Sound insulation rating of services

Sound transmission and insulation, sound insulation for building elements

SPEC-F5.2 Sound Insulation for Building Elements

Special hazards

E1.10 Provision for special hazards

E2.3 Provision for special hazards

Special hazards, smoke hazard management

E2.3 Provision for special hazards

Stairway, construction

D2.8 Enclosure of space under stairs and ramps

D2.9 Width of stairways and ramps

D2.13 Goings and risers

D2.14 Landings

Stairway, construction, landing

D2.14 Landings

Stairway, construction, width

D2.9 Width of stairways and ramps

Stairway, goings and risers

D2.13 Goings and risers

Stairway, ramp, escalator

D1.12 Non-required stairways, ramps or escalators

SPEC-D1.12 Non-Required Stairways, Ramps and Escalators

Stairway, ramp, escalator, non-required

SPEC-D1.12 Non-Required Stairways, Ramps and Escalators

Stairway, rising and descending stair flights

D2.4 Separation of rising and descending stair flights

Standards

A1.2 Adoption of Standards and other references

A1.3 Referenced Standards, etc

A1.4 Differences between referenced documents and the BCA

SPEC-A1.3 Documents Adopted By Reference

Standby power system, atrium

SPEC-G3.8-6 Fire and Smoke Control Systems in Buildings Containing Atriums - 6.
Standby Power System

State/Territory Appendices

A1.6 Application of the BCA to a particular State or Territory

Steel column

SPEC-C1.1-2.5 Fire-Resisting Construction - 2.5 General Concessions

Steel construction

B1.4 Determination of structural resistance of materials and forms of construction

Stormwater drainage

F1.1 Stormwater drainage

Structural

B1.0 Deemed-to-Satisfy Provisions

B1.1 Resistance to actions

B1.2 Determination of individual actions

B1.4 Determination of structural resistance of materials and forms of construction

Structural software

B1.5 Structural Software

Structures on roof

SPEC-C1.1-2.5 Fire-Resisting Construction - 2.5 General Concessions

Sub-floor ventilation

F1.12 Sub-floor ventilation

Suitability of materials

A2.1 Suitability of materials

A2.2 Evidence of suitability

Support of another part

SPEC-C1.1-2.2 Fire-Resisting Construction - 2.2 Fire Protection For A Support Of Another Part

Swimming pools

D3.10 Swimming pools

G1.1 Swimming pools

SPEC-D3.10 Accessible water entry/exit for swimming pools

System

E4.9 Sound systems and intercom systems for emergency purposes

System and intercom

E4.9 Sound systems and intercom systems for emergency purposes

T

Tactile indicators

D3.8 Tactile indicators

Tactile signs

D3.6 Signage

SPEC-D3.6 Braille and Tactile Signs

Termites

B1.4 Determination of structural resistance of materials and forms of construction

Theatre, stage and public hall

C1.0 Deemed-to-Satisfy Provisions

C2.0 Deemed-to-Satisfy Provisions

C3.0 Deemed-to-Satisfy Provisions

D1.0 Deemed-to-Satisfy Provisions

D2.0 Deemed-to-Satisfy Provisions

D3.0 Deemed-to-Satisfy Provisions

H1.1 Application of Part

H1.2 Separation

H1.3 Proscenium wall construction

H1.4 Seating area

H1.5 Exits from theatre stages

H1.6 Access to platforms and lofts

H1.7 Aisle lights in theatres

SPEC-H1.3 Construction of Theatres with Proscenium Walls

Theatre, stage and public hall, proscenium wall

SPEC-H1.3 Construction of Theatres with Proscenium Walls

Thermal construction

J1.2 Thermal construction — general

Threshold, doorway

D2.15 Thresholds

Tilt-up construction

SPEC-C1.11 Performance of External Walls in Fire

Timber column

SPEC-C1.1-2.5 Fire-Resisting Construction - 2.5 General Concessions

Timber construction

B1.4 Determination of structural resistance of materials and forms of construction

Type A construction

SPEC-C1.1-3 Fire-Resisting Construction - 3. Type A Fire-Resisting Construction

Type A construction, carpark

SPEC-C1.1-3.9 Fire-Resisting Construction - 3.9 Carparks

Type A construction, open spectator stand, indoor sports stadium

SPEC-C1.1-3.8 Fire-Resisting Construction - 3.8 Open Spectator Stands And Indoor Sports Stadiums: Concession

Type A construction, rooflight

SPEC-C1.1-3.6 Fire-Resisting Construction - 3.6 Rooflights

Type B construction

SPEC-C1.1-4 Fire-Resisting Construction - 4. Type B Fire-Resisting Construction

Type B construction, carpark

SPEC-C1.1-4.2 Fire-Resisting Construction - 4.2 Carparks

Type C construction

SPEC-C1.1-5 Fire-Resisting Construction - 5. Type C Fire-Resisting Construction

Type C construction, carpark

SPEC-C1.1-5.2 Fire-Resisting Construction - 5.2 Carparks

Type of construction

C1.1 Type of construction required

C1.2 Calculation of rise in storeys

C1.3 Buildings of multiple classification

C1.4 Mixed types of construction

C1.5 Two storey Class 2, 3 or 9c buildings

C1.6 Class 4 parts of buildings

C1.7 Open spectator stands and indoor sports stadiums

C2.2 General floor area and volume limitations

C2.3 Large Isolated Buildings

Type of construction, mixed

C1.4 Mixed types of construction

Type of construction, multiple classification

C1.3 Buildings of multiple classification

Type of construction, rise in storeys

C1.2 Calculation of rise in storeys

U

United buildings

A4.1 When buildings are united

A4.2 Alterations in a united building

V

Vehicular access

C2.4 Requirements for open spaces and vehicular access

Ventilation

- F4.0** Deemed-to-Satisfy Provisions
- F4.5** Ventilation of rooms
- F4.6** Natural ventilation
- F4.7** Ventilation borrowed from adjoining room
- F4.8** Restriction on position of water closets and urinals
- F4.9** Airlocks
- F4.11** Carparks
- F4.12** Kitchen local exhaust ventilation

Ventilation systems, energy efficiency

- J0.0** Deemed-to-Satisfy Provisions
- J0.1** Application of Section J
- J5.0** Deemed-to-Satisfy Provisions
- J5.2** Air-conditioning and ventilation systems
- J5.3** Time switch
- J5.5** Miscellaneous exhaust systems

Ventilation, carpark

- F4.11** Carparks

Ventilation, kitchen exhaust

- F4.12** Kitchen local exhaust ventilation

Verification Method, energy efficiency

- JV3** Energy Efficiency - JV3 Verification Using A Reference Building
- SPEC-JV** Annual Energy Consumption Criteria

W

Wall construction, energy efficiency

- J1.5** Walls
- SPEC-J1.5** Wall Construction
- SPEC-J1.5-1** Wall Construction - 1. Scope
- SPEC-J1.5-2** Wall Construction - 2. Construction Deemed-To-Satisfy

Water closets and urinals

- F4.8** Restriction on position of water closets and urinals
- F4.9** Airlocks

Wet areas

- F1.7** Water proofing of wet areas in buildings

Wheelchair seating spaces

D3.9 Wheelchair seating spaces in Class 9b assembly buildings

SUPERSEDED
INDEX, ABBREVIATIONS AND SYMBOLS

ABBREVIATIONS AND SYMBOLS

Abbreviations and Symbols used in the BCA include:

ABBREVIATIONS

| | |
|------------|--|
| ABCB | Australian Building Codes Board |
| AISC | Australian Institute of Steel Construction |
| ALGA | Australian Local Government Association |
| AS | Australian Standard |
| ASTM | American Society for Testing and Materials |
| BCA | Building Code of Australia |
| BCC | Building Codes Committee |
| C_{SHGC} | Constant for solar heat gain |
| CSIRO | Commonwealth Scientific and Industrial Research Organisation |
| C_U | Constant for conductance |
| FRL | Fire Resistance Level |
| GRP | Glass fibre reinforced polyester |
| ISO | International Organisation for Standardisation |
| NATA | National Association of Testing Authorities |
| PVC | Polyvinyl chloride |
| R_w | Weighted sound reduction index |
| SHGC | Solar Heat Gain Coefficient |
| STC | Sound Transmission Class |
| UPVC | Unplasticized polyvinyl chloride |
| U-Value | Thermal transmittance |

SYMBOLS (SI UNITS)

| | |
|--------------------|---------------------------------------|
| dB(A) | decibels "A" scale weighting network |
| °C | degree(s) Celsius |
| °CDB | degree(s) Celsius Dry Bulb |
| °CWB | degree(s) Celsius Wet Bulb |
| -e/MJ | equivalent per MegaJoule(s) |
| J | Joule(s) |
| J/kg.K | Joules per kilogram per degree Kelvin |
| J/s.m ² | Joules per second per square metre |

SUPERSEDED
INDEX, ABBREVIATIONS AND SYMBOLS

| | |
|--------------------------|--------------------------------------|
| K | kelvin(s) |
| kg | kilogram(s) |
| kg/m | kilogram(s) per metre |
| kg/m ² | kilogram(s) per square metre |
| kg/m ³ | kilogram(s) per cubic metre |
| KJ/hour.m ² | kiloJoules per hour per square metre |
| kPa | kilopascal(s) |
| kW/m ² | kilowatt(s) per square metre |
| kW _{heating} | kilowatt(s) of heating |
| kWr | kilowatt(s) of refrigeration |
| L | litre(s) |
| L/s | litre(s) per second |
| L/s.m ² | litre(s) per second square metre |
| Lumens/W | Lumens per Watt |
| lx | lux |
| m | metre(s) |
| m ² | square metre(s) |
| m ³ | cubic metre(s) |
| MJ/hour | MegaJoules per hour |
| MJ/m ² .annum | MegaJoules per square metre annum |
| m/s | metre(s) per second |
| m ³ /s | cubic metre(s) per second |
| mm | millimetre(s) |
| mm ² | square millimetre(s) |
| µm | micrometre |
| MW | megawatt(s) |
| N | newton(s) |
| Pa | pascal(s) |
| W | Watt(s) |
| W/m.K | Watts per metre per degree Kelvin |
| W/m ² | Watts per square metre |

HISTORY OF BCA ADOPTION

CONTENTS

HISTORY OF BCA ADOPTION

History of BCA Adoption

- 1.0 Adoption of BCA96
- 1.1 Amendment No. 1
- 1.2 Amendment No. 2
- 1.3 Amendment No. 3
- 1.4 Amendment No. 4
- 1.5 Amendment No. 5
- 1.6 Amendment No. 6
- 1.7 Amendment No. 7
- 1.8 Amendment No. 8
- 1.9 Amendment No. 9
- 1.10 Amendment No. 10
- 1.11 Amendment No. 11
- 1.12 Amendment No. 12
- 1.13 Amendment No. 13
- 2.0 Adoption of BCA 2004
- 3.0 Adoption of BCA 2005
- 4.0 Adoption of BCA 2006
- 5.0 Adoption of BCA 2007
- 6.0 Adoption of BCA 2008
- 7.0 Adoption of BCA 2009
- 8.0 Adoption of BCA 2010
- 9.0 Adoption of BCA 2011
- 10.0 Adoption of BCA 2012
- 11.0 Adoption of BCA 2013

HISTORY OF BCA ADOPTION

1.0 Adoption of BCA96

The 1996 edition of the BCA was adopted as set out in Table Amdt 1.0.

Table 1.0 History of adoption of BCA96

| Administration | Adoption Date |
|------------------------------|----------------|
| Australian Government | 1 July 1997 |
| Australian Capital Territory | 1 July 1997 |
| New South Wales | 1 July 1997 |
| Northern Territory | 7 January 1998 |
| Queensland | 1 July 1997 |
| South Australia | 1 January 1998 |
| Tasmania | 1 July 1997 |
| Victoria | 1 August 1997 |
| Western Australia | 1 July 1997 |

1.1 Amendment No. 1

(a) Amendment No. 1 of the 1996 edition of the BCA was adopted as set out in Table 1.1.

Table 1.1 History of adoption of Amendment No. 1 of the BCA96

| Administration | Adoption Date |
|------------------------------|----------------|
| Australian Government | 1 July 1997 |
| Australian Capital Territory | 1 July 1997 |
| New South Wales | 1 July 1997 |
| Northern Territory | 7 January 1998 |
| Queensland | 1 July 1997 |
| South Australia | 1 January 1998 |
| Tasmania | 1 July 1997 |
| Victoria | 1 August 1997 |
| Western Australia | 1 July 1997 |

(b) The purpose of Amendment No. 1 is to—

- (i) correct minor typographical errors including spelling, punctuation and layout; and
- (ii) include reference to a Certificate of Conformity issued by the ABCB in A2.2; and
- (iii) change the reference to the Standards Mark Certificate to refer to JAS–ANZ in A2.2; and

- (iv) update references to Standards.

Note:

Only substantive typographical corrections are noted in the margin.

1.2 Amendment No. 2

- (a) Amendment No. 2 of the 1996 edition of the BCA was adopted as set out in Table 1.2.

Table 1.2 History of adoption of Amendment No. 2 of the BCA96

| Administration | Adoption Date |
|------------------------------|------------------|
| Australian Government | 1 January 1998 |
| Australian Capital Territory | 1 January 1998 |
| New South Wales | 27 February 1998 |
| Northern Territory | 7 January 1998 |
| Queensland | 1 January 1998 |
| South Australia | 1 January 1998 |
| Tasmania | 1 January 1998 |
| Victoria | 1 January 1998 |
| Western Australia | 1 January 1998 |

- (b) The purpose of Amendment No. 2 is to—
 - (i) correct minor typographical errors; and
 - (ii) update references to Standards.

1.3 Amendment No. 3

- (a) Amendment No. 3 of the 1996 edition of the BCA was adopted as set out in Table 1.3.

Table 1.3 History of adoption of Amendment No. 3 of the BCA96

| Administration | Adoption Date |
|------------------------------|---------------|
| Australian Government | 1 July 1998 |
| Australian Capital Territory | 1 July 1998 |
| New South Wales | 1 July 1998 |
| Northern Territory | 1 July 1998 |
| Queensland | 1 July 1998 |
| South Australia | 13 July 1998 |
| Tasmania | 1 July 1998 |
| Victoria | 1 July 1998 |
| Western Australia | 1 July 1998 |

- (b) The purpose of Amendment No. 3 is to—
 - (i) incorporate the outcomes of the 1997 ABCB Variations Conference; and

- (ii) update references to Standards; and
- (iii) include minor technical changes.

1.4 Amendment No. 4

- (a) Amendment No. 4 of the 1996 edition of the BCA was adopted by the Australian Government, States and Territories as set out in Table 1.4.

Table 1.4 History of adoption of Amendment No. 4 of the BCA96

| Administration | Adoption Date |
|------------------------------|-----------------|
| Australian Government | 1 January 1999 |
| Australian Capital Territory | 17 May 1999 |
| New South Wales | 1 February 1999 |
| Northern Territory | 1 January 1999 |
| Queensland | 1 January 1999 |
| South Australia | 1 January 1999 |
| Tasmania | 1 January 1999 |
| Victoria | 1 January 1999 |
| Western Australia | 1 January 1999 |

- (b) The purpose of Amendment No. 4 is to—
- (i) update references to Standards; and
 - (ii) include minor technical changes.

Note:

Only substantive typographical corrections are noted in the margin.

1.5 Amendment No. 5

- (a) Amendment No. 5 of the 1996 edition of the BCA was adopted as set out in Table 1.5.

Table 1.5 History of adoption of Amendment No. 5 of the BCA96

| Administration | Adoption Date |
|------------------------------|-----------------|
| Australian Government | 1 July 1999 |
| Australian Capital Territory | 3 November 1999 |
| New South Wales | 1 August 1999 |
| Northern Territory | 1 July 1999 |
| Queensland | 1 July 1999 |
| South Australia | 1 July 1999 |
| Tasmania | 1 July 1999 |
| Victoria | 1 July 1999 |
| Western Australia | 1 July 1999 |

- (b) The purpose of Amendment No. 5 is to—
- (i) update references to Standards; and
 - (ii) include minor technical changes; and
 - (iii) amend clauses to improve clarity and to reduce the possibility of differences in interpretation; and
 - (iv) expand on the requirements for sub-floor ventilation based on climatic conditions.

Note:

Only substantive typographical corrections are noted in the margin.

1.6 Amendment No. 6

- (a) Amendment No. 6 of the 1996 edition of the BCA was adopted as set out in Table 1.6.

Table 1.6 History of adoption of Amendment No. 6 of the BCA96

| Administration | Adoption Date |
|------------------------------|------------------|
| Australian Government | 1 January 2000 |
| Australian Capital Territory | 10 February 2000 |
| New South Wales | 1 January 2000 |
| Northern Territory | 1 January 2000 |
| Queensland | 1 January 2000 |
| South Australia | 17 January 2000 |
| Tasmania | 1 January 2000 |
| Victoria | 1 January 2000 |
| Western Australia | 1 January 2000 |

- (b) The purpose of Amendment No. 6 is to—
- (i) update references to Standards; and
 - (ii) expand on the requirements for carparking for people with disabilities; and
 - (iii) replace Sound Transmission Class (STC) with weighted sound reduction index (R_w) within Part F5; and
 - (iv) include minor technical changes.

Note:

Only substantive typographical corrections are noted in the margin.

1.7 Amendment No. 7

- (a) Amendment No. 7 of the 1996 edition of the BCA was adopted as set out in Table 1.7.

Table 1.7 History of adoption of Amendment No. 7 of the BCA96

| Administration | Adoption Date |
|-----------------------|---------------|
| Australian Government | 1 July 2000 |

Table 1.7 History of adoption of Amendment No. 7 of the BCA96— continued

| Administration | Adoption Date |
|------------------------------|---------------|
| Australian Capital Territory | 10 July 2000 |
| New South Wales | 1 July 2000 |
| Northern Territory | 1 July 2000 |
| Queensland | 1 July 2000 |
| South Australia | 1 July 2000 |
| Tasmania | 1 July 2000 |
| Victoria | 1 July 2000 |
| Western Australia | 1 July 2000 |

- (b) The purpose of Amendment No. 7 is to—
- (i) update references to Standards; and
 - (ii) include requirements for non-required and private stairways; and
 - (iii) include minor technical changes.

Note:

Only substantive typographical corrections are noted in the margin.

1.8 Amendment No. 8

- (a) Amendment No. 8 of the 1996 edition of the BCA was adopted as set out in Table 1.8.

Table 1.8 History of adoption of Amendment No. 8 of the BCA96

| Administration | Adoption Date |
|------------------------------|-----------------|
| Australian Government | 1 January 2001 |
| Australian Capital Territory | 11 January 2001 |
| New South Wales | 1 January 2001 |
| Northern Territory | 1 January 2001 |
| Queensland | 1 January 2001 |
| South Australia | 1 January 2001 |
| Tasmania | 1 January 2001 |
| Victoria | 1 January 2001 |
| Western Australia | 1 January 2001 |

- (b) The purpose of Amendment No. 8 is to—
- (i) update references to Standards; and
 - (ii) include minor technical changes; and

- (iii) achieve greater consistency between both Volumes of the BCA for stairway construction.

Note:

Only substantive typographical corrections are noted in the margin.

1.9 Amendment No. 9

- (a) Amendment No. 9 of the 1996 edition of the BCA was adopted as set out in Table 1.9.

Table 1.9 History of adoption of Amendment No. 9 of the BCA96

| Administration | Adoption Date |
|------------------------------|---------------|
| Australian Government | 1 July 2001 |
| Australian Capital Territory | 12 July 2001 |
| New South Wales | 1 July 2001 |
| Northern Territory | 1 July 2001 |
| Queensland | 1 July 2001 |
| South Australia | 2 July 2001 |
| Tasmania | 1 July 2001 |
| Victoria | 1 July 2001 |
| Western Australia | 1 July 2001 |

- (b) The purpose of Amendment No. 9 is to—
 - (i) update references to Standards; and
 - (ii) include minor technical changes; and
 - (iii) clarify which glazed assemblies must comply with AS 2047 and which must comply with AS 1288.

Note:

Only substantive typographical corrections are noted in the margin.

1.10 Amendment No. 10

- (a) Amendment No. 10 of the 1996 edition of the BCA was adopted as set out in Table 1.10.

Table 1.10 History of adoption of Amendment No. 10 of the BCA96

| Administration | Adoption Date |
|------------------------------|----------------|
| Australian Government | 1 January 2002 |
| Australian Capital Territory | 1 January 2002 |
| New South Wales | 1 January 2002 |
| Northern Territory | 1 January 2002 |
| Queensland | 1 January 2002 |
| South Australia | 1 January 2002 |

Table 1.10 History of adoption of Amendment No. 10 of the BCA96—continued

| Administration | Adoption Date |
|-------------------|----------------|
| Tasmania | 1 January 2002 |
| Victoria | 1 January 2002 |
| Western Australia | 1 January 2002 |

- (b) The purpose of Amendment No. 10 is to—
- (i) update references to Standards; and
 - (ii) clarify that windows must comply with AS 2047 for resistance to water penetration; and
 - (iii) subject to certain conditions, allow a non-fire-isolated stairway to connect an additional storey; and
 - (iv) update signage required for people with disabilities, including the need for signs to contain Braille and tactile information; and
 - (v) include minor technical changes.

Note:

Only substantive typographical corrections are noted in the margin.

1.11 Amendment No. 11

- (a) Amendment No. 11 of the 1996 edition of the BCA was adopted as set out in Table 1.11.

Table 1.11 History of adoption of Amendment No. 11 of the BCA96

| Administration | Adoption Date |
|------------------------------|---------------|
| Australian Government | 1 July 2002 |
| Australian Capital Territory | 1 July 2002 |
| New South Wales | 1 July 2002 |
| Northern Territory | 1 July 2002 |
| Queensland | 1 July 2002 |
| South Australia | 1 July 2002 |
| Tasmania | 1 July 2002 |
| Victoria | 1 July 2002 |
| Western Australia | 1 July 2002 |

- (b) The purpose of Amendment No. 11 is to—
- (i) update references to Standards; and
 - (ii) transfer public policy matters, with respect to structural adequacy, from the AS 1170 series to the BCA; and
 - (iii) introduce Class 7a, 7b and 9c classifications; and
 - (iv) update the provisions for residential buildings used for the accommodation of the aged to align with the Commonwealth Aged Care Act, 1997; and

- (v) include minor technical changes.

Note:

Only substantive typographical corrections are noted in the margin.

1.12 Amendment No. 12

- (a) Amendment No. 12 of the 1996 edition of the BCA was adopted as set out in Table 1.12.

Table 1.12 History of adoption of Amendment No. 12 of the BCA96

| Administration | Adoption Date |
|------------------------------|----------------|
| Australian Government | 1 January 2003 |
| Australian Capital Territory | 1 January 2003 |
| New South Wales | 1 January 2003 |
| Northern Territory | 1 January 2003 |
| Queensland | 1 January 2003 |
| South Australia | 1 January 2003 |
| Tasmania | 1 January 2003 |
| Victoria | 1 January 2003 |
| Western Australia | 1 January 2003 |

- (b) The purpose of Amendment No. 12 is to—
 - (i) update references to Standards; and
 - (ii) apply the swimming pool safety provisions to swimming pools associated with Class 4 parts as well as Class 2 and 3 buildings; and
 - (iii) allow the use of either the 1989 editions or the 2002 editions of the 1170 series of standards; and
 - (iv) include minor technical changes.

Note:

Only substantive typographical corrections are noted in the margin.

1.13 Amendment No. 13

- (a) Amendment No. 13 of the 1996 edition of the BCA was adopted as set out in Table 1.13.

Table 1.13 History of adoption of Amendment No. 13 of the BCA96

| Administration | Adoption Date |
|------------------------------|---------------|
| Australian Government | 1 July 2003 |
| Australian Capital Territory | 1 July 2003 |
| New South Wales | 1 July 2003 |
| Northern Territory | 1 July 2003 |
| Queensland | 1 July 2003 |

Table 1.13 History of adoption of Amendment No. 13 of the BCA96— continued

| Administration | Adoption Date |
|-------------------|---------------|
| South Australia | To be advised |
| Tasmania | 1 July 2003 |
| Victoria | 1 July 2003 |
| Western Australia | 1 July 2003 |

- (b) The purpose of Amendment No. 13 is to—
- (i) update references to Standards; and
 - (ii) reform the provisions for fire hazard properties of materials; and
 - (iii) revise a requirement for the use of non-combustible materials; and
 - (iv) include additional requirements for the protection of electrical switchboards which sustain electricity supply to emergency equipment; and
 - (v) include minor changes to the requirements for aged care buildings; and
 - (vi) include minor technical changes.

Note:

Only substantive typographical corrections are noted in the margin.

2.0 Adoption of BCA 2004

- (a) The 2004 edition of the BCA was adopted as set out in Table 2.0.

Table 2.0 History of adoption of BCA 2004

| Administration | Adoption Date |
|------------------------------|---------------|
| Australian Government | 1 May 2004 |
| Australian Capital Territory | 1 May 2004 |
| New South Wales | 1 May 2004 |
| Northern Territory | 1 May 2004 |
| Queensland | 1 May 2004 |
| South Australia | 1 May 2004 |
| Tasmania | 1 May 2004 |
| Victoria | 1 May 2004 |
| Western Australia | 1 May 2004 |

- (b) The purpose of BCA 2004 is to—
- (i) update references to Standards; and
 - (ii) update references from BCA 96 to BCA 2004; and
 - (iii) include a Performance Requirement considering human impact with glazing; and
 - (iv) reform the provisions for sound insulation; and
 - (v) reform the maintenance provisions; and

- (vi) include minor technical changes.

3.0 Adoption of BCA 2005

- (a) The 2005 edition of the BCA was adopted as set out in Table 3.0.

Table 3.0 History of adoption of BCA 2005

| Administration | Adoption Date |
|------------------------------|---------------|
| Australian Government | 1 May 2005 |
| Australian Capital Territory | 1 May 2005 |
| New South Wales | 1 May 2005 |
| Northern Territory | 1 May 2005 |
| Queensland | 1 May 2005 |
| South Australia | 1 May 2005 |
| Tasmania | 1 May 2005 |
| Victoria | 1 May 2005 |
| Western Australia | 1 May 2005 |

- (b) The purpose of BCA 2005 is to—
 - (i) update references to Standards; and
 - (ii) clarify when fire sprinklers are required to be installed in buildings; and
 - (iii) update the provisions for waterproofing of wet areas; and
 - (iv) include energy efficiency measures for Class 2 and 3 buildings and Class 4 parts; and
 - (v) more closely align the requirements for lifts with those of Occupational Health and Safety legislation; and
 - (vi) include minor technical changes.

4.0 Adoption of BCA 2006

- (a) The 2006 edition of the BCA was adopted as set out in Table 4.0.

Table 4.0 History of adoption of BCA 2006

| Administration | Adoption Date |
|------------------------------|--|
| Australian Government | 1 May 2006 |
| Australian Capital Territory | 1 May 2006 |
| New South Wales | 1 May 2006 (except that the date for mandatory compliance with Section J provisions for Class 5 to 9 buildings is 1 November 2006) |
| Northern Territory | 1 May 2006 |
| Queensland | 1 May 2006 |

Table 4.0 History of adoption of BCA 2006— continued

| Administration | Adoption Date |
|-------------------|--|
| South Australia | 1 May 2006, except for Part I2 and Section J which were adopted on 1 August 2006 |
| Tasmania | 1 May 2006 |
| Victoria | 1 May 2006 |
| Western Australia | 1 May 2006 |

- (b) The purpose of BCA 2006 is to—
- (i) update schedule of referenced documents; and
 - (ii) include a national testing regime for cladding in cyclonic areas; and
 - (iii) withdraw of AS1530.3 tests on floor materials and floor coverings and wall and ceiling linings; and
 - (iv) include energy efficiency measures for Class 5 to 9 buildings; and
 - (v) include minor technical changes.

5.0 Adoption of BCA 2007

- (a) The 2007 edition of the BCA was adopted by the Commonwealth, States and Territories as set out in Table 5.0.

Table 5.0 History of adoption of BCA 2007

| Administration | Adoption Date |
|------------------------------|---------------|
| Australian Government | 1 May 2007 |
| Australian Capital Territory | 1 May 2007 |
| New South Wales | 1 May 2007 |
| Northern Territory | 1 May 2007 |
| Queensland | 1 May 2007 |
| South Australia | 1 May 2007 |
| Tasmania | 1 May 2007 |
| Victoria | 1 May 2007 |
| Western Australia | 1 May 2007 |

- (b) The purpose of BCA 2007 is to—
- (i) update references to other documents; and
 - (ii) update energy efficiency provisions including providing additional information; and
 - (ii) include minor technical changes.

6.0 Adoption of BCA 2008

- (a) The 2008 edition of the BCA was adopted by the Commonwealth, States and Territories as set out in Table 6.0.

Table 6.0 History of adoption of BCA 2008

| Administration | Adoption Date |
|------------------------------|----------------------|
| Australian Government | 1 May 2008 |
| Australian Capital Territory | 1 May 2008 |
| New South Wales | 1 May 2008 |
| Northern Territory | 1 May 2008 |
| Queensland | 1 May 2008 |
| South Australia | 1 May 2008 |
| Tasmania | 1 May 2008 |
| Victoria | 1 May 2008 |
| Western Australia | 1 May 2008 |

- (b) The purpose of BCA 2008 is to—
- (i) update references to other documents; and
 - (ii) due to changes in the types of detectors now available, rather than only allowing the use of a heat detectors when smoke detector would be unsuitable in the atmosphere, to also allow the use of any type of detector deemed suitable by AS 1670.1; and
 - (iii) clarify the intent of the BCA when a service penetrates a building element required to have an FRL; and
 - (iv) amend the requirements for door handle heights to be consistent with AS 1428.1; and
 - (v) align some BCA terms with current industry terminology; and
 - (vi) include lists of other Commonwealth, State and Territory legislation affecting buildings; and
 - (vii) include suitable provisions for swimming pool water recirculation systems; and
 - (viii) include minor technical changes.

7.0 Adoption of BCA 2009

- (a) The 2009 edition of the BCA was adopted by the Commonwealth, States and Territories as set out in Table 7.0.

Table 7.0 History of adoption of BCA 2009

| Administration | Adoption Date |
|------------------------------|----------------------|
| Australian Government | 1 May 2009 |
| Australian Capital Territory | 1 May 2009 |
| New South Wales | 1 May 2009 |
| Northern Territory | 1 May 2009 |
| Queensland | 1 May 2009 |
| South Australia | 1 May 2009 |

Table 7.0 History of adoption of BCA 2009— continued

| Administration | Adoption Date |
|-------------------|---------------|
| Tasmania | 1 May 2009 |
| Victoria | 1 May 2009 |
| Western Australia | 1 May 2009 |

- (b) The purpose of BCA 2009 is to—
- (i) update references to other documents; and
 - (ii) after expiry of the agreed transition period, except for the 1993 edition of AS 1170.4, delete all references to the older loading standards contained in the AS 1170 series and consequently, all provisions referring to them; and
 - (iii) clarify the application of the vertical separation provisions; and
 - (iv) clarify the intent of separation of equipment; and
 - (v) simplify the wire balustrade provisions, including the addition of a *Verification Method*; and
 - (vi) clarify the provisions for the construction of sanitary compartments to enable an unconscious occupant to be removed; and
 - (vii) clarify the height of rooms in an attic and with a sloping ceiling; and
 - (viii) further update the energy efficiency provisions; and
 - (ix) include minor technical changes.

8.0 Adoption of BCA 2010

- (a) The 2010 edition of the BCA was adopted by the Commonwealth, States and Territories as set out in Table 8.0.

Table 8.0 History of adoption of BCA 2010

| Administration | Adoption Date |
|------------------------------|---|
| Australian Government | 1 May 2010 |
| Australian Capital Territory | 1 May 2010 |
| New South Wales | 1 May 2010 |
| Northern Territory | 1 May 2010 |
| Queensland | 1 May 2010 |
| South Australia | 1 May 2010 except for Section J, which was adopted on 1 September 2010, and the restriction on child resistant door sets in G1.1 and the additional bushfire requirements for 'excluded areas' prescribed in SA G5.2(d) and (e), which were adopted on 2 December 2010. |
| Tasmania | 1 May 2010 |
| Victoria | 1 May 2010 |
| Western Australia | 1 May 2010 |

- (b) The purpose of BCA 2010 is to—
- (i) update references to other documents; and
 - (ii) delete reference to the 1993 edition of AS 1170.4 and consequently all provisions referring to it; and
 - (iii) increase the stringency of the energy efficiency provisions and, as part of reducing greenhouse gas emissions, introduce provisions for the greenhouse gas intensity of the energy source for services such as water and space heaters; and
 - (iv) update **Part G5**, as a consequence of referencing the 2009 edition of AS 3959 construction in bushfire-prone areas, to include provisions which apply to a Class 10a building or deck associated with a Class 2 or 3 building located in a *designated bushfire prone area*; and
 - (v) include minor technical changes.

9.0 Adoption of BCA 2011

- (a) The 2011 edition of the BCA was adopted by the Commonwealth, States and Territories as set out in **Table 9.0**.

Table 9.0 History of adoption of BCA 2011

| Administration | Adoption Date |
|------------------------------|---------------|
| Australian Government | 1 May 2011 |
| Australian Capital Territory | 1 May 2011 |
| New South Wales | 1 May 2011 |
| Northern Territory | 1 May 2011 |
| Queensland | 1 May 2011 |
| South Australia | 1 May 2011 |
| Tasmania | 1 May 2011 |
| Victoria | 1 May 2011 |
| Western Australia | 1 May 2011 |

- (b) The purpose of BCA 2011 is to—
- (i) update references to other documents; and
 - (ii) align the BCA with the Access Code in the Disability (Access to Premises — Buildings) Standards; and
 - (iii) restructure the fire hazard property provisions; and
 - (iv) include minor technical changes.

10.0 Adoption of BCA 2012

- (a) The 2012 edition of the BCA was adopted by the Commonwealth, States and Territories as set out in **Table 10.0**.

Table 10.0 History of adoption of BCA 2012

| Administration | Adoption Date |
|------------------------------|---------------|
| Australian Government | 1 May 2012 |
| Australian Capital Territory | 1 May 2012 |
| New South Wales | 1 May 2012 |
| Northern Territory | 1 May 2012 |
| Queensland | 1 May 2012 |
| South Australia | 1 May 2012 |
| Tasmania | 1 May 2012 |
| Victoria | 1 May 2012 |
| Western Australia | 1 May 2012 |

- (b) The purpose of BCA 2012 is to—
- (i) update references to other documents; and
 - (ii) include revised provisions aimed at reducing slips, trips and falls in buildings; and
 - (iii) include a Verification Method for emergency lighting; and
 - (iv) align the BCA with changes to the National Quality Standard for early childhood education and care; and
 - (v) include exemptions for Class 8 electricity network substations; and
 - (vi) include minor technical changes.

11.0 Adoption of BCA 2013

- (a) The 2013 edition of the BCA was adopted by the Commonwealth, States and Territories as set out in [Table 11.0](#).

Table 11.0 History of adoption of BCA 2013

| Administration | Adoption Date |
|------------------------------|---------------|
| Australian Government | 1 May 2013 |
| Australian Capital Territory | 1 May 2013 |
| New South Wales | 1 May 2013 |
| Northern Territory | 1 May 2013 |
| Queensland | 1 May 2013 |
| South Australia | 1 May 2013 |
| Tasmania | 1 May 2013 |
| Victoria | 1 May 2013 |
| Western Australia | 1 May 2013 |

- (b) The purpose of BCA 2013 is to—
- (i) update references to other documents; and

- (ii) include new provisions for openable windows to reduce falls in buildings; and
- (iii) include a Performance Requirement and reference a Standard for construction in flood hazard areas; and
- (iv) consolidate the building related components of the AS 1735 lift series into the BCA; and
- (v) enhance the egress provisions for people with disability; and
- (vi) include minor technical changes.

LIST OF AMENDMENTS

SUPERSEDED
LIST OF AMENDMENTS

CONTENTS

LIST OF AMENDMENTS

List of Amendments Volume One

**SUPERSEDED
LIST OF AMENDMENTS**

LIST OF AMENDMENTS - NCC 2013 - VOLUME ONE

This set of notes has been prepared by the Australian Building Codes Board to assist NCC users in identifying changes incorporated in the 2013 edition of Volume One.

The notes provide a description of major changes made from the previous edition of Volume One. If additional information is required to assist in understanding, interpreting or applying the provisions of the 2013 edition of Volume One, reference should be made to the Guide to Volume One.

While the Australian Building Codes Board has attempted to include all major changes made from the previous edition of Volume One, the Board does not give any warranty nor accept any liability in relation to the contents of this list of amendments.

| Reference | Changes and Commentary | |
|--|--|---|
| Introduction | | |
| Additional wording has been inserted to highlight the need to give consideration to whether a Building Solution developed to comply with the BCA may impact on compliance with the Plumbing Code of Australia. | | |
| Section A | | |
| A1.1 | The following definitions have been inserted or amended: | |
| | Appropriate authority | A new defined term has been included, as a consequence of including provisions for construction in flood hazard areas. |
| | Average recurrence interval | The defined term has been amended to include a 5 minute duration rainfall intensity. |
| | Conditioned space | The defined term has been amended to exempt a lift shaft. |
| | Defined flood event (DFE) | A new defined term has been included as a consequence of including provisions for construction in flood hazard areas. |
| | Defined flood level (DFL) | A new defined term has been included as a consequence of including provisions for construction in flood hazard areas. |
| | Electric passenger lift | A new defined term has been included as a consequence of relocating building-related requirements for lifts from the AS 1735 suite of standards into the BCA. |
| | Electrohydraulic passenger lift | A new defined term has been included as a consequence of relocating building-related requirements for lifts from the AS 1735 suite of standards into the BCA. |

**SUPERSEDED
LIST OF AMENDMENTS**

| Reference | Changes and Commentary |
|---|--|
| Fan motor power | The defined term has been amended from 'fan power' to 'fan motor power' to more clearly reflect the expanded understanding of what constitutes the power input. As a consequence, the term has been changed where it appears in the provisions. |
| Flood hazard area | A new defined term has been included as a consequence of including provisions for construction in flood hazard areas. |
| Flood hazard level (FHL) | A new defined term has been included as a consequence of including provisions for construction in flood hazard areas. |
| Freeboard | A new defined term has been included as a consequence of including provisions for construction in flood hazard areas. |
| Inclined lift | A new defined term has been included as a consequence of relocating building-related requirements for lifts from the AS 1735 suite of standards into the BCA. |
| Low-rise, low-speed constant pressure lift | A new defined term has been included as a consequence of relocating building-related requirements for lifts from the AS 1735 suite of standards into the BCA. |
| Low-rise platform lift | A new defined term has been included as a consequence of relocating building-related requirements for lifts from the AS 1735 suite of standards into the BCA. |
| Small-sized, low-speed automatic lift | A new defined term has been included as a consequence of relocating building-related requirements for lifts from the AS 1735 suite of standards into the BCA. |
| Stairway platform lift | A new defined term has been included as a consequence of relocating building-related requirements for lifts from the AS 1735 suite of standards into the BCA. |
| Surface water | The defined term has been amended to exclude the overflow of water from drains or large water bodies such as streams. |
| Total System Solar Heat Gain Coefficient (SHGC) | The defined term 'Solar Heat Gain Coefficient' (SHGC) has been amended to include 'total system' to reflect the correct method for calculating glazing performance values. As a consequence, the term has been changed where it appears in the provisions. |

**SUPERSEDED
LIST OF AMENDMENTS**

| Reference | Changes and Commentary | |
|----------------------------|---|---|
| | Total System U-Value | The defined term 'Total U-Value' has been amended to include 'system' to reflect the correct method for calculating glazing performance values. As a consequence, the term has been changed where it appears in the provisions. |
| | Waterproof | The defined term has been amended to remove the reference to AS 3740. |
| | Water resistant | The defined term has been amended to remove the reference to AS 3740. |
| Specification A1.3 Table 1 | The following references have been inserted or amended: | |
| | AS/NZS 1170.2 | Amdt 1 to AS/NZS 1170 - Part 2 'Wind actions' has been referenced. Reference to the 2002 edition has been removed as a consequence of the completion of a 12 month transition period between the 2002 and 2011 editions. |
| | AS 1562.1 | Amdt 3 to AS 1562 'Design and installation of sheet roof and wall cladding' has been referenced. |
| | AS 1668.2 | Reference to AS 1668 - Part 2 'The use of ventilation and airconditioning in buildings — Mechanical ventilation in buildings' has been updated to the 2012 edition. The 1991 edition of AS 1668.2 has been retained for a 12 month transition period. |
| | AS 1684.2 | Amdt 1 to AS 1684 - Part 2 'Residential timber-framed construction — Non-cyclonic areas' has been referenced. |
| | AS 1684.3 | Amdt 1 to AS 1684 - Part 3 'Residential timber-framed construction — Cyclonic areas' has been referenced. |
| | AS 1684.4 | Amdt 1 to AS 1684 - Part 4 'Residential timber-framed construction — Simplified - non-cyclonic areas' has been referenced. |
| | AS 1735.1 | Reference to AS 1735 - Part 1 'General requirements' has been deleted as a consequence of relocating building-related requirements for lifts from the AS 1735 suite of standards into the BCA. |

**SUPERSEDED
LIST OF AMENDMENTS**

| Reference | Changes and Commentary |
|------------|---|
| AS 1735.2 | Reference to AS 1735 - Part 2 'Passenger and goods lifts — Electric ' has been deleted as a consequence of relocating building-related requirements for lifts from the AS 1735 suite of standards into the BCA. |
| AS 1735.3 | Reference to AS 1735 - Part 3 'Passenger and goods lifts — Electrohydraulic ' has been deleted as a consequence of relocating building-related requirements for lifts from the AS 1735 suite of standards into the BCA. |
| AS 1735.7 | Reference to AS 1735 - Part 7 'Stairway lifts' has been deleted as a consequence of relocating building-related requirements for lifts from the AS 1735 suite of standards into the BCA. |
| AS 1735.8 | Reference to AS 1735 - Part 8 'Inclined lifts' has been deleted as a consequence of relocating building-related requirements for lifts from the AS 1735 suite of standards into the BCA. |
| AS 1735.14 | Reference to AS 1735 - Part 14 'Low-rise platforms for passengers' has been deleted as a consequence of relocating building-related requirements for lifts from the AS 1735 suite of standards into the BCA. |
| AS 1735.15 | Reference to AS 1735 - Part 15 'Lifts for people with limited mobility — Restricted use - Non-automatically controlled' has been deleted as a consequence of relocating building-related requirements for lifts from the AS 1735 suite of standards into the BCA. |
| AS 1735.16 | Reference to AS 1735 - Part 16 'Lifts for persons with limited mobility — Restricted use - Automatically controlled' has been deleted as a consequence of relocating building-related requirements for lifts from the AS 1735 suite of standards into the BCA. |
| AS 1926.1 | Reference to AS 1926 - Part 1 'Swimming pool safety — Safety barriers for swimming pools' has been updated to the 2012 edition. |
| AS 2050 | Amdt 2 to AS 2050 'Installation of roof tiles' has been referenced. |

**SUPERSEDED
LIST OF AMENDMENTS**

| Reference | Changes and Commentary |
|---------------------------|--|
| AS 2118.4 | Reference to AS 2118 - Part 4 'Automatic fire sprinkler systems — Sprinkler protection for accommodation buildings not exceeding four storeys in height' has been updated to the 2012 edition. The 1995 edition of AS 2118.4 has been retained for a 12 month transition period. |
| AS 2118.6 | Reference to AS 2118 - Part 6 'Automatic fire sprinkler systems — Combined sprinkler and hydrant systems in multistorey buildings' has been updated to the 2012 edition. The 1995 edition of AS 2118.6 has been retained for a 12 month transition period. |
| AS 2870 | Reference to the 1996 edition of AS 2870 'Residential slabs and footings — Construction' has been removed as a consequence of the completion of a 12 month transition period between the 1996 and 2011 editions. |
| AS 2904 | Amdt 2 to AS 2904 'Damp-proof courses and flashings' has been referenced. |
| AS/NZS 3500.3 | Amdt 3 to AS/NZS 3500 - Part 3 'Plumbing and drainage — Stormwater drainage' has been referenced. |
| AS 3740 | Amdt 1 to AS 3740 'Waterproofing of domestic wet areas' has been referenced. |
| AS 4254 Part 1 and Part 2 | AS 4254 'Ductwork in air-handling systems in buildings, Part 1 'Flexible duct' and Part 2 'Rigid duct' have been referenced. |
| AS/NZS 4505 | The 2012 edition of AS/NZS 4505 'Garage doors and other large access doors' has been referenced as a consequence of its inclusion in B1.4. |
| AS/NZS 4654 Part 1 and 2 | AS/NZS 4654 'Waterproofing membranes for external above-ground use, Part 1 'Materials' and Part 2 'Design and installation' have been referenced. |
| AIRAH-DA09 | The 1998 edition of AIRAH-DA09 'Air Conditioning Load Estimation' has been referenced as a consequence of expanding the options to determine the metabolic rates for occupants and hot meals production. |

**SUPERSEDED
LIST OF AMENDMENTS**

| Reference | Changes and Commentary |
|---|---|
| ABCB Standard for Construction of Buildings in Flood Hazard Areas | The 2012 edition of the ABCB Standard for Construction of Buildings in Flood Hazard Areas has been referenced as a consequence of its inclusion in B1.6. |
| CIBSE Guide A | The 2006 edition of CIBSE Guide A 'Environmental design' has been referenced as a consequence of expanding the options to determine the metabolic rates for occupants and hot meals production. |
| Section B | |
| BP1.4 | A new Performance Requirement has been included to require residential buildings to meet requirements and resist actions associated with a defined flood event if they are located in a flood hazard area. |
| B1.0 | As a consequence of the inclusion of BP1.4 and B1.6, the Performance Requirements and Deemed-to-Satisfy Provisions referred to have been updated. |
| B1.2(c)(ii) | As a consequence of referencing Amdt 1 to the 2011 edition of AS/NZS 1170 - Part 2 'Wind actions' and the removal of the 2002 edition, (ii) has been amended and restructured. |
| B1.4(l) | A new sub-clause has been included to require certain garage doors and other large access doors to comply with AS/NZS 4505. |
| B1.4(m) | Requirements for lift shafts, previously contained in AS 1735.2, have been included in the BCA and reference to that standard has been deleted. This change is a consequence of relocating building-related requirements for lifts from the AS 1735 suite of standards into the BCA. |
| Table B1.4 | As a consequence of relocating building-related requirements for lifts from the AS 1735 suite of standards into the BCA, a new table has been inserted setting out the requirements for glazing installed in lifts shafts not required to have an FRL. |
| B1.6 | A new provision has been inserted to require residential buildings to comply with the ABCB Standard for Construction of Buildings in Flood Hazard Areas. |
| Specification B1.2 Scope | The scope has been amended as a consequence of the referencing of Amdt 1 to the 2011 edition of AS/NZS 1170– Part 2 'Wind actions' and the removal of the 2002 edition. |
| Section C | |
| C2.5(a)(ii) | As a consequence of the redrafting of C2.5(a) to clarify the requirement for smoke separation between ward and treatment areas, the existing provisions for fire separation at C2.5(a)(iv) have been relocated. |
| C2.5(a)(iii) and (iv) | The existing (ii) and (iii) have been amended and redrafted to (iii) and (iv) to clarify the original intention that smoke separation is to be provided between ward and treatment areas regardless of size. The redrafting of the provision now reflects similar smoke separation requirements for Class 9c aged care buildings. |

**SUPERSEDED
LIST OF AMENDMENTS**

| Reference | Changes and Commentary |
|-----------------------------------|---|
| Specification C1.1, Table 3 and 4 | The Tables have been amended to clarify the original intent that a loadbearing external column must have an FRL whether incorporated within an external wall or not. |
| Specification C1.8, Clause 6 | The references to the AS 1735 suite of standards have been deleted. This change is a consequence of relocating building-related requirements for lifts from the AS 1735 suite of standards into the BCA. |
| Specification C1.10, Clause 6(b) | Sub-clause (b) has been deleted. This change is a consequence of relocating building-related requirements for lifts from the AS 1735 suite of standards into the BCA. |
| Section D | |
| DP3 | As a consequence of the inclusion of additional provisions for openable windows, sub-clause (b) of the Performance Requirement has been amended and a new sub-clause (c) has been inserted. The remaining sub-clauses have been renumbered. |
| DP7 | A new Performance Requirement has been inserted to facilitate the use of lifts to evacuate occupants from a building in addition to exits. |
| D1.0(a) | Sub-clause (a) has been amended to capture the Deemed to Satisfy Provisions applicable to Part D1 in exclusion to the new Performance Requirement DP7. |
| D1.0(a)(i) and (b)(i) | Sub-clauses (a)(i) and (b)(i) have been amended to include the new provision for openable windows. |
| D1.0(c) | A new sub-clause has been inserted to highlight there are no Deemed to Satisfy Provisions for the use of lifts to evacuate occupants and compliance is by reference to DP7. |
| D1.16(b)(iii) | The reference to AS 1735.2 has been deleted and the sub-clause restructured. This change is a consequence of relocating building-related requirements for lifts from the AS 1735 suite of standards into the BCA. |
| D1.16(b)(iv) | A new sub-clause (iv) has been inserted setting out the requirements for a lift machine room ladder. This change is a consequence of relocating building-related requirements for lifts from the AS 1735 suite of standards into the BCA. |
| D2.0(a) | Sub-clause (a) has been amended to capture the Deemed to Satisfy Provisions applicable to Part D1 in exclusion to the new Performance Requirement DP7. |
| D2.0(a)(i) and (b)(i) | Sub-clauses (a)(i) and (b)(i) have been amended to include the new provision for openable windows. |
| D2.15(c) | A new sub-clause (c) has been inserted to clarify threshold requirements for buildings required to be accessible by Part D3. The existing sub-clause (c) has been renumbered. |
| D2.16(a) | Sub-clause (a) has been amended to exclude barriers for openable windows covered by D2.24. |
| D2.16(g)(ii) (C) | As a consequence of the inclusion of additional provisions for openable windows, sub-clause (C) has been deleted. |
| D2.17(a)(vi) | A new sub-clause (a)(vi) has been inserted to require the installation of handrails compliant with AS 1428.1 in required ramp or stairway exits serving accessible areas of buildings. |

**SUPERSEDED
LIST OF AMENDMENTS**

| Reference | Changes and Commentary |
|-------------------------------|---|
| D2.21(a) and (b) | Sub-clause (a) has been amended and expanded to sub-clause (a) and (b) to require door furniture on egress doors in buildings required to be accessible to be suitable for use by people with disability. The existing sub-clause (b) has been renumbered. |
| D2.24 | A new D2.24 has been inserted to limit the risk of a young child falling through an openable window. |
| D2.24(a) | Sub-clause (a) has been inserted to apply restrictions to openable windows in a bedroom in certain residential Classes of buildings and in a Class 9b early childhood centre with floors 2 m above the surface level beneath. |
| D2.24(b) | A new sub-clause (b) has been inserted to require protection to any openings in windows less than 1.7 m above a floor level. |
| D2.24(c) and (d) | Sub-clause (c) has been inserted to clarify the circumstances when a 865 mm barrier is required under an openable window. Sub-clause (d) describes the design features of the barrier. |
| D3.0(a) | Sub-clause (a) has been amended to capture the Deemed to Satisfy Provisions applicable to Part D1 in exclusion to the new Performance Requirement DP7. |
| D3.0(a)(i) and (b)(i) | Sub-clauses (a)(i) and (b)(i) have been amended to include the new provision for openable windows. |
| D3.6(a)(i) | Sub-clause (a)(i) has been amended to include the signage for hearing augmentation previously contained in (a)(ii). |
| D3.6(a)(ii) | Sub-clause (a)(ii) has been amended to require braille and tactile signs to be installed to identify doors required by E4.5 to be provided with an exit sign. This change is to assist a person who is blind or has a vision impairment to exit a building in an emergency. |
| Specification D3.6, Clause 2 | A new sub-clause (d) has been inserted to specify the location of braille and tactile signs used to identify certain doors required by E4.5 to be provided with an exit sign. This change is to assist a person who is blind or has a vision impairment to exit a building in an emergency. |
| Specification D3.6, Clause 3 | Sub-clause (b)(i) has been amended to specify the height of tactile characters of signs used to identify certain doors required by E4.5 to be provided with an exit sign. This change is to assist a person who is blind or has a vision impairment to exit a building in an emergency. |
| Section E | |
| Specification E1.5, Clause 13 | A new Clause 13 has been inserted. This change is a consequence of relocating building-related requirements for lifts from the AS 1735 suite of standards into the BCA. |
| Specification E2.2b, Figure 2 | The original Figure 2.1 has been renumbered to Figure 2, reformatted to improve readability and amended to clarify its application to buildings covered by Part H1. |
| EF3 | The Functional Statement has been amended to permit the use of lifts to evacuate occupants from a building in addition to exits. |
| EP3 | The Performance Requirement has been amended to permit the use of lifts to evacuate occupants from a building in addition to exits. |

**SUPERSEDED
LIST OF AMENDMENTS**

| Reference | Changes and Commentary |
|---------------------------------|---|
| E3.0(a) and (b) | Sub-clauses (a) and (b) have been amended to expand the application of the Deemed-to Satisfy Provisions. The change is a consequence of relocating building-related requirements for lifts from the AS 1735 suite of standards into the BCA. |
| E3.1 | A new E3.1 has been inserted to require certain lifts to comply with new Specification E3.1. This change is a consequence of relocating building-related requirements for lifts from the AS 1735 suite of standards into the BCA. |
| E3.4(d) | The references to AS 1735.1 and AS 1735.2 have been deleted. As part of this change the requirements of (e) have now been included under (d). This change is a consequence of relocating building-related requirements for lifts from the AS 1735 suite of standards into the BCA. |
| E3.4(d)(iii) (A) and (B) | The sub-clause has expanded the required capacity rating of emergency lifts if provided with a stretcher facility |
| E3.5 | The provision has been amended to include access and egress requirements for liftwell landings. The change is a consequence of relocating building-related requirements for lifts from the AS 1735 suite of standards into the BCA. |
| Table E3.6(a) and Table E3.6(b) | The tables have been amended as a consequence of relocating building-related requirements for lifts from the AS 1735 suite of standards into the BCA. |
| E3.7 | The provision has been amended to include the requirement for a fire service control switch and lift car fire service drive control switches for lifts. The change is a consequence of relocating building-related requirements for lifts from the AS 1735 suite of standards into the BCA. |
| E3.9 | A new E3.9 has been inserted. This change is a consequence of relocating building-related requirements for lifts from the AS 1735 suite of standards into the BCA. |
| E3.10 | A new E3.10 has been inserted. This change is a consequence of relocating building-related requirements for lifts from the AS 1735 suite of standards into the BCA. |
| Specification E3.1 | A new Specification has been inserted. This change is a consequence of relocating building-related requirements for lifts from the AS 1735 suite of standards into the BCA. |
| Section F | |
| FP1.3 | The Performance Requirement has been restructured and amended to clarify the event for which a drainage system for the disposal of surface water must be designed. |
| F1.4 | A new F1.4 has been included to require external waterproofing membranes to comply with AS 4654. |
| F2.3(i) | A new (i) has been inserted to clarify that a wash basin is required whenever a closet pan or urinal is provided. |
| Section G | |
| Part G1 | As a consequence of the State and Territory variations for swimming pools being relocated to the Appendices, the Part has been restructured. |

**SUPERSEDED
LIST OF AMENDMENTS**

| Reference | Changes and Commentary |
|--|---|
| G1.1(c) and (d) | Sub-clauses (c) and (d) have been deleted as a consequence of the reference of the 2012 edition of AS 1926.1. |
| Section I | |
| Table I1.5 & I1.13 | The reference to E1.10 as a safety measure for 'Special Hazards' has been removed because of the lack of defined prescribed measures inherent in the provision. |
| Section J | |
| Specification JV, Clause 2 | The specified internal heat gains in a building have been amended to reference national and international data sources. |
| J1.1 | The Application of Part has been amended to align with the definition of conditioned space which excludes certain buildings. |
| Table J1.5(b) | The Table has been amended to clarify the original intention to apply the stringency of Part J2 glazing in the external wall of the non-conditioned space as if it was glazing in the envelope. Roof light heat gains are now to be accounted for and a new note has been added to the Table. |
| J2.1 | The Application of Part has been amended to align with the definition of conditioned space which excludes certain buildings. |
| J2.4(a)(iii) | A new (iii) has been inserted to clarify the requirement for glazing in the internal fabric with a P/H less than 2. |
| J3.1 | The Application of Part has been amended to align with the definition of conditioned space which excludes certain buildings. |
| Table J5.2 | The Table has been amended to incorporate the maximum power increases associated with fan motor power. |
| J5.2(b)(iii)(A) | As a consequence of amendments to Table J5.2 and the term 'fan motor power', the values in (A) have been amended. |
| J5.4(b)(ii)(H) | The existing sub-clause has been relocated and expanded to clarify that all forms of heating described in (A) to (G) along with the limited scope of electric heating can be used in combination. |
| J5.4(b)(iii) | A new sub-clause has been inserted to permit a 1.2kW electric heater in a bathroom of a Class 3 or 9c building. |
| Specification J1.6, Figure 2 | Typical R-Values for 100 mm and 150 mm thick concrete slab-on-ground construction have been included. |
| Australian Capital Territory Appendix | |
| ACT Table 1 | The following reference has been amended: AS 1692 Reference to AS 1692 'Tanks for flammable and combustible liquids' has been updated to the 2006 edition. |
| ACT D1.102 | New provision inserted advising of relevant ACT legislation dealing with access for people with disabilities. |
| ACT GO1(c) | As a consequence of the State and Territory variations for swimming pools being relocated to the Appendices, a new sub-clause (c) has been inserted. |
| ACT GF1.2(a) | As a consequence of the State and Territory variations for swimming pools being relocated to the Appendices, a new sub-clause (a) has been inserted. |

**SUPERSEDED
LIST OF AMENDMENTS**

| Reference | Changes and Commentary | |
|------------------------------------|---|--|
| ACT GP1.2(a) | As a consequence of the State and Territory variations for swimming pools being relocated to the Appendices, a new sub-clause (a) has been inserted. | |
| ACT G1.1 (d) and (e) | Sub-clauses (f) and (g) have been renumbered to (d) and (e) to align with the consequential changes of the 2012 edition of AS 1926. | |
| ACT J1.1 | Note to J1.1 amended to clarify relevant ACT legislation dealing with sustainability and that legislation may be applicable to the construction phase. | |
| New South Wales Appendix | | |
| NSW A1.1 | Appropriate authority | The defined term has been varied to reflect the NSW legislative framework. |
| NSW Table 1 | References to NSW legislation have been updated. | |
| NSW D2.15 | As a consequence of amendments to D2.15, NSW D2.15(c) and (d) have been renumbered. | |
| NSW D2.21 | As a consequence of amendments to D2.21, NSW D2.21(b) and (c) have been renumbered. | |
| NSW EP1.4 | A new note has been inserted to highlight that NSW has requirements for fire sprinkler systems in certain residential aged care facilities. | |
| NSW Table E1.5 | A new note has been inserted to highlight that NSW has requirements for fire sprinkler systems in certain residential aged care facilities. | |
| NSW FF2.1 | The note has been amended to update references to NSW legislation. | |
| NSW FP2.6 | The note has been amended to update references to NSW legislation. | |
| NSW F2.7 | The note has been amended to update references to NSW legislation. | |
| NSW F4.5 | The note has been amended to update references to NSW legislation. | |
| NSW GO1(c) | As a consequence of the State and Territory variations for swimming pools being relocated to the Appendices, a new sub-clause (c) has been inserted. | |
| NSW GF1.2(a) | As a consequence of the State and Territory variations for swimming pools being relocated to the Appendices, a new sub-clause (a) has been inserted. | |
| NSW GP1.2(a) | As a consequence of the State and Territory variations for swimming pools being relocated to the Appendices, a new sub-clause (a) has been inserted. | |
| NSW G1.1(a) | As a consequence of the State and Territory variations for swimming pools being relocated to the Appendices, a new sub-clauses (a) has been inserted. | |
| NSW I1.2 | The note has been amended to update references to NSW legislation. | |
| NSW Subsection J(B) | The provision has been amended to reference the energy efficiency provisions of BCA 2013. | |
| NSW J3.1 | As a consequence of amendments to J3.1, NSW J3.1(f) has been renumbered. | |
| Footnote | The Footnote listing other legislation has been updated. | |
| Northern Territory Appendix | | |
| NT GO1(a), (b) and (c) | As a consequence of the State and Territory variations for swimming pools being relocated to the Appendices, new sub-clauses (a), (b) and (c) have been inserted. | |

**SUPERSEDED
LIST OF AMENDMENTS**

| Reference | Changes and Commentary |
|--|--|
| NT GF1.1 | As a consequence of the State and Territory variations for swimming pools being relocated to the Appendices, a new provision has been inserted. |
| NT GF1.2 | As a consequence of the State and Territory variations for swimming pools being relocated to the Appendices, a new provision has been inserted. |
| NT GP1.1 | As a consequence of the State and Territory variations for swimming pools being relocated to the Appendices, a new provision has been inserted. |
| NT GP1.2 | As a consequence of the State and Territory variations for swimming pools being relocated to the Appendices, a new provision has been inserted. |
| NT G1.1(a) and (b) | As a consequence of the State and Territory variations for swimming pools being relocated to the Appendices, new sub-clauses (a) and (b) have been inserted. |
| Footnote | The Footnote listing other legislation has been updated. |
| Queensland Appendix | |
| Qld GO1(c) | As a consequence of the State and Territory variations for swimming pools being relocated to the Appendices, a new sub-clause (c) has been inserted. |
| Qld GF1.2(a) | As a consequence of the State and Territory variations for swimming pools being relocated to the Appendices, a new sub-clause (a) has been inserted. |
| Qld GP1.2(a) | As a consequence of the State and Territory variations for swimming pools being relocated to the Appendices, a new sub-clause (a) has been inserted. |
| Qld G1.1(a) and (b) | As a consequence of the State and Territory variations for swimming pools being relocated to the Appendices, new sub-clauses (a) and (b) have been inserted. |
| South Australian Appendix | |
| SA GO1(c) | As a consequence of the State and Territory variations for swimming pools being relocated to the Appendices, a new sub-clause (c) has been inserted. |
| SA GF1.2(a) | As a consequence of the State and Territory variations for swimming pools being relocated to the Appendices, a new sub-clause (a) has been inserted. |
| SA GP1.2(a) | As a consequence of the State and Territory variations for swimming pools being relocated to the Appendices, a new sub-clause (a) has been inserted. |
| Footnote | The Footnote listing other legislation has been updated. |
| Tasmanian Appendix | |
| Tas A1.1 | The following definitions have been amended: |
| | Early Childhood centre |
| | School age care facility |
| Tas Table 1 | The following reference has been amended: |
| AS 1187 | Title reference to AS 1187 has been updated. |
| AS/NZS 1680 Part 1, Part 2.1, Part 2.2 and Part 2.3. | Reference to 1680 'Interior lighting', Part 1, Part 2.1, Part 2.2 and Part 2.3. has been updated to the 2008 edition. |

**SUPERSEDED
LIST OF AMENDMENTS**

| Reference | Changes and Commentary |
|--|--|
| AS/NZS 60079.10.1 | Reference to AS/NZS 2430 has been updated to AS/NZS 60079.10.1 'Classification of hazardous areas — Explosive gas atmospheres'. |
| AS 2507 | Title reference to AS 2507 has been updated. |
| AS 2658 | Reference to AS 2658 'LP Gas - Portable and mobile appliances' has been updated to the 2011 edition, including Amdt 2. |
| AS/NZS 3002 | Reference to AS 3002 'Electrical installations — shows and carnivals' has been updated to the 2008 edition. |
| AS/NZS 3760 | Reference to AS/NZS 3760 'In-service safety inspection and testing of electrical equipment' has been updated to the 2010 edition. |
| AS 4464 | Reference to AS 4464 'Hygienic production of game meat for human consumption' has been updated to the 2007 edition. |
| AS 4465 | Reference to AS 4465 'Construction of premises and hygienic production of poultry meat for human consumption' has been updated to the 2006 edition. |
| AS 4466 | Reference to AS 4466 'Hygienic production of rabbit meat' has been updated to the 1998 edition. |
| AS 4696 | Reference to AS 4696 'Hygienic production and transportation of meat and meat products for human consumption' has been updated to the 2007 edition. |
| AS 5008 | Reference to AS 5008 'Hygienic rendering of animal products' has been updated to the 2007 edition. |
| AS 5601 Set | Reference to AS 5601 'Gas installations' has been updated to the 2010 edition. |
| BCA 2009 | BCA 2009 removed as a referenced document. |
| ADG7 Code | The 2011 edition of the 'Australian Dangerous Goods Code' has been referenced as a consequence of its inclusion in Tas H120.1. |
| Education and Care Services National Law (Application) Act | Title reference has been amended. |
| GHS | The 'Global Harmonised System of Classification and Labelling' has been referenced as a consequence of its inclusion in Tas H120.1. |
| Centre Based Care Class 4 Standards | Reference to the Centre Based Care Class 4 Standards - 'Tasmanian Licencing Standards for Centre Based Child Care Class 4' has been updated to the 2012 edition. |
| Centre Based Care Class 5 Standards | Title reference has been included. |

**SUPERSEDED
LIST OF AMENDMENTS**

| Reference | Changes and Commentary |
|-----------------------------------|--|
| | Export Control (Dairy Eggs and Fish) Orders Title reference has been amended and 2005 edition year included. |
| Tas GP5.1 | The Performance Requirement has been amended to remove the variation to GP5.1 while retaining the renumbered additions of sub-clause (c) and (d). |
| Tas H101.11(d) and Table H101.11 | A new sub-clause (d) has been inserted along with an adjustment to shower ratios in Table H101.11. |
| Tas H101.12 and Table Tas H101.12 | The provision has been amended to account for the change to spatial requirements of change rooms. |
| Tas H103.13(b) | A new sub-clause (b) has been included describing the clear space requirements for dining rooms. The current sub-clause (b) has been renumbered (c). |
| Tas H101.15(b) and (c) | The number of employees which determines the need for a first aid room has been amended in sub-clause (b) and a new sub-clause (c) now describes the construction details of the room. |
| Tas H108.1 | The Application of Part has been amended. |
| Tas H109.1 | The Application of Part has been amended. |
| Tas H111.1 | The Application of Part has been amended. |
| Tas H120.1 | The Application of Part has been amended to include changes to the referencing legislation. |
| Tas H120.2 | The provision has been amended to include a change to the referencing legislation. |
| Tas H120.3 | The provision has been amended to include a change to the referencing legislation. |
| Tas H120.4 | The provision has been amended to include a change to the referencing legislation. |
| Tas H120.5 | The provision has been amended to include a change to the relevant referenced standards. |
| Tas H122 P3 | The application to the Performance Requirement has been amended. |
| Tas H122.0 | The Application of Part has been amended. |
| Tas GO1(c) | As a consequence of the State and Territory variations for swimming pools being relocated to the Appendices, a new sub-clause (c) has been inserted. |
| Tas GO1(f), (g) and (h) | Sub-clauses (f) ,(g) and (h) have been renumbered to (g), (h) and (i) as a consequence of the State and Territory variations for swimming pools being relocated to the Appendices. |
| Tas GF1.2 (a) | As a consequence of the State and Territory variations for swimming pools being relocated to the Appendices, a new sub-clause (a) has been inserted. |

**SUPERSEDED
LIST OF AMENDMENTS**

| Reference | Changes and Commentary |
|---|--|
| Tas GF1.5, Tas GF1.6 and Tas GF1.7 | The provisions have been renumbered to align with the insertion of GF1.4 from BCA 2012. |
| Tas GP1.6 Limitation Note | The Limitation Note has been relocated to align with the appropriate provision. |
| Tas GP1.2(a) | As a consequence of the State and Territory variations for swimming pools being relocated to the Appendices, a new sub-clause (a) has been inserted. |
| Tas G1.1(d), (e), (f) and (g) | Sub-clause (f), (g), (h) and (i) have been renumbered to align with the consequential changes of the 2012 edition of AS 1926. |
| Section I2 | The variation to adopt Section I2 of BCA 2009 in lieu of the current edition has been deleted. |
| Section J | The variation to adopt Section J of BCA 2009 in lieu of the current edition has been deleted. |
| Victorian Appendix | |
| Vic D2.21 | As a consequence of amendments to D2.21, Vic D2.21(a)(vi) has been renumbered. |
| Vic GO1(c) | As a consequence of the State and Territory variations for swimming pools being relocated to the Appendices, a new sub-clause (c) has been inserted. |
| Vic GF1.2(a) | As a consequence of the State and Territory variations for swimming pools being relocated to the Appendices, a new sub-clause (a) has been inserted. |
| Vic GP1.2(a) | As a consequence of the State and Territory variations for swimming pools being relocated to the Appendices, a new sub-clause (a) has been inserted. |
| Vic G1.1(b) | Sub-clause (ba) has been renumbered to (b) as an editorial correction. |
| Western Australia Appendix | |
| WA GO1(c) | As a consequence of the State and Territory variations for swimming pools being relocated to the Appendices, a new sub-clause (c) has been inserted. |
| WA GF1.2(a) | As a consequence of the State and Territory variations for swimming pools being relocated to the Appendices, a new sub-clause (a) has been inserted. |
| WA GP1.2(a) | As a consequence of the State and Territory variations for swimming pools being relocated to the Appendices, a new sub-clause (a) has been inserted. |
| Footnote | The Footnote listing other legislation has been updated. |
| Abbreviations and Symbols | |
| Joules(J) | A new abbreviation has been included. |
| History of BCA Adoption | |
| 11.0 | New provision added in order to set out the adoption date of the 2013 edition of Volume One in each State and Territory and to summarise the purpose of the changes from the 2012 edition. |