



**NATIONAL
CONSTRUCTION
CODE**

2016

VOLUME ONE

Building Code of Australia
Class 2 to Class 9 Buildings

CONTENTS AND FEATURES INTRODUCTION

General Table of Contents

Introduction

Copyright and licence notice

© 2016 Commonwealth of Australia and States and Territories of Australia

Ownership of intellectual property rights

Unless otherwise noted, copyright (and any other intellectual property rights, if any) in this publication is jointly owned by the Commonwealth, States and Territories of Australia.

Creative Commons licence
Attribution CC BY-NC-ND 4.0



All material in this publication is licensed under a Creative Commons Attribution-NonCommercial-NoDerivatives 4.0 International Licence, save for logos. Attribution-NonCommercial-NoDerivatives 4.0 International Licence is a standard form licence agreement that does not permit any commercial use or derivatives of the original work. Under this licence: you may only distribute a verbatim copy of the work and must not adapt or change the work in any way. You must give appropriate credit and provide a link to the licence. You may do so in any reasonable manner, but not in any way that suggests the Commonwealth of Australia, States and Territories of Australia or Australian Building Codes Board endorses you or your use. You may not use the material for commercial purposes. If you remix, transform, or build upon the material for your own use, you may not distribute the modified material.

The full licence terms are available from <http://creativecommons.org/licenses/by-nc-nd/4.0/legalcode>.

Content contained herein should be attributed as:

The National Construction Code Series 2016[®] as released by the Australian Building Codes Board on behalf of the Commonwealth of Australia and States and Territories of Australia

Disclaimer

While care has been taken in the preparation of this publication of the National Construction Code 2016, the General Manager of the Australian Building Codes Board Office, as agent for the Commonwealth of Australia and States and Territories of Australia, does not warrant that any licensing or registration requirements specified in this publication are either complete or up-to-date for your State or Territory. The National Construction Code 2016 is reviewed every 3 years, but the Australian Building Codes Board may also update and amend the National Construction Code 2016 in part more often than this. You can ensure that you are using the most up-to-date version of the National Construction Code 2016 by checking the Australian Building Codes Board website (www.abcb.gov.au).

The General Manager of the Australian Building Codes Board Office, as agent for the Commonwealth of Australia and States and Territories of Australia, does not accept any liability, including liability for negligence, loss howsoever caused, damage, injury, expense or cost incurred by any person as a result of accessing, using or relying upon any information in this publication to the maximum extent permitted by law. No representation expressed or implied is made as to the currency, accuracy, reliability or completeness of any information or services which may appear on any linked websites, or other linked information sources.

The information in this publication is provided on the basis that all persons accessing the information undertake responsibility for assessing the relevance and accuracy of the information to their particular circumstances.

ARCHIVED
CONTENTS AND FEATURES INTRODUCTION

Published by: The Australian Building Codes Board
GPO Box 9839
CANBERRA ACT 2601
Phone: 1300 134 631
Email: ncc@abcb.gov.au
www.abcb.gov.au

First published: February 2016
Print version: 1.0
Release date: May 2016

GENERAL TABLE OF CONTENTS

CONTENTS AND FEATURES INTRODUCTION

Introduction	8
--------------------	---

SECTION A GENERAL PROVISIONS

Part A0 Application	14
Part A1 Interpretation	16
Part A2 Acceptance of Design and Construction	35
Part A3 Classification of Buildings and Structures	37
Part A4 United Buildings	40

SECTION B STRUCTURE

Part B1 Structural Provisions	70
-------------------------------------	----

SECTION C FIRE RESISTANCE

Part C1 Fire Resistance and Stability	90
Part C2 Compartmentation and Separation	96
Part C3 Protection of Openings	105

SECTION D ACCESS AND EGRESS

Part D1 Provision for Escape	164
Part D2 Construction of Exits	178
Part D3 Access for People with a Disability	197

SECTION E SERVICES AND EQUIPMENT

Part E1 Fire Fighting Equipment	222
Part E2 Smoke Hazard Management	238
Part E3 Lift Installations	259
Part E4 Visibility in an Emergency, Exit Signs and Warning Systems	269

ARCHIVED
CONTENTS AND FEATURES INTRODUCTION

SECTION F HEALTH AND AMENITY

Part F1	Damp and Weatherproofing	279
Part F2	Sanitary and Other Facilities	296
Part F3	Room Heights	315
Part F4	Light and Ventilation	318
Part F5	Sound Transmission and Insulation	325

SECTION G ANCILLARY PROVISIONS

Part G1	Minor Structures and Components	344
Part G2	Boilers, Pressure Vessels, Heating Appliances, Fireplaces, Chimneys and Flues	348
Part G3	Atrium Construction	352
Part G4	Construction in Alpine Areas	362
Part G5	Construction in Bushfire Prone Areas	367

SECTION H SPECIAL USE BUILDINGS

Part H1	Class 9b Buildings	372
Part H2	Public Transport Buildings	374
Part H3	Farm Buildings and Farm Sheds	377

SECTION I * * * * *

Part I1	* * * * *	385
Part I2	* * * * *	386

SECTION J ENERGY EFFICIENCY

Part J0	Energy Efficiency	404
Part J1	Building Fabric	406
Part J2	Glazing	415
Part J3	Building Sealing	435
Part J4	* * * * *	438
Part J5	Air-Conditioning and Ventilation Systems	439
Part J6	Artificial Lighting and Power	444

ARCHIVED
CONTENTS AND FEATURES INTRODUCTION

Part J7	Heated Water Supply and Swimming Pool and Spa Pool Plant	452
Part J8	Facilities for Energy Monitoring.....	454
STATE & TERRITORY APPENDICES		
	Appendix Commonwealth of Australia.....	487
	Appendix Australian Capital Territory	494
	Appendix New South Wales	506
	Appendix Northern Territory	559
	Appendix Queensland.....	579
	Appendix South Australia.....	584
	Appendix Tasmania.....	619
	Appendix Victoria	665
	Appendix Western Australia.....	694
INDEX, ABBREVIATIONS AND SYMBOLS		
	Index.....	701
	Abbreviations and Symbols	743
HISTORY OF ADOPTION		
	History of Adoption	747
LIST OF AMENDMENTS		
	List of Amendments	767

INTRODUCTION

THE NATIONAL CONSTRUCTION CODE

The National Construction Code (NCC) is an initiative of the Council of Australian Governments developed to incorporate all on-site construction requirements into a single code.

The NCC is produced and maintained by the Australian Building Codes Board (ABCB) on behalf of the Australian Government and each State and Territory government.

The NCC is a uniform set of technical provisions for the design and construction of buildings and other structures, and plumbing and drainage systems throughout Australia. It allows for variations in climate and geological or geographic conditions.

THE NCC – FORMAT

The NCC is published in three volumes. The Building Code of Australia (BCA) is Volume One and Volume Two of the NCC and the Plumbing Code of Australia (PCA) is Volume Three of the NCC.

VOLUME ONE: contains the requirements for—

- (a) all Class 2 to 9 buildings; and
- (b) access requirements for people with a disability in Class 1b and 10a buildings; and
- (c) certain Class 10b structures including access requirements for people with a disability in Class 10b *swimming pools*.

VOLUME TWO: contains the requirements for—

- (a) Class 1 and 10a buildings (other than access requirements for people with a disability in Class 1b and 10a buildings); and
- (b) certain Class 10b structures (other than access requirements for people with a disability in Class 10b *swimming pools*); and
- (c) Class 10c *private bushfire shelters*.

VOLUME THREE: contains the requirements for plumbing and drainage associated with all classes of buildings.

The NCC is accompanied by other documents, comprising the NCC Consolidated Performance Requirements and the Guide to Volume One. Additional guidance material is also located on the ABCB web site at www.abcb.gov.au.

The NCC is drafted in a performance format allowing a choice of *Deemed-to-Satisfy Solutions* or flexibility to develop *Performance Solutions* based on existing or new innovative building, plumbing and drainage products, systems and designs.

When complying with the *Deemed-to-Satisfy Provisions*, or when developing *Performance Solutions* in order to comply with the NCC, consideration may need to be given to whether the solution impacts on compliance with other Parts of the NCC.

THE GOAL

The goal of the NCC is to enable the achievement of nationally consistent, minimum necessary standards of relevant safety (including structural safety and safety from fire), health, amenity and sustainability objectives efficiently.

This goal is applied so that—

- (a) there is a rigorously tested rationale for the regulation; and
- (b) the regulation is effective and proportional to the issues being addressed such that the regulation will generate benefits to society greater than the costs (that is, net benefits); and
- (c) there is no regulatory or non-regulatory alternative (whether under the responsibility of the Board or not) that would generate higher net benefits; and
- (d) the competitive effects of the regulation have been considered and the regulation is no more restrictive than necessary in the public interest.

THE AUSTRALIAN BUILDING CODES BOARD

The ABCB is established by agreement between the Australian Government and each State and Territory government. It is a co-operative arrangement between the signatories, local government and the building industry.

The ABCB's mission is to address issues relating to safety, health, amenity and sustainability in the design, construction and performance of buildings. This is achieved through the NCC and the development of effective regulatory systems and appropriate non-regulatory solutions.

The Board comprises—

- (a) a Chair; and
- (b) the head of each Commonwealth, State and Territory department, statutory body, division, or agency that has the relevant administrative responsibility for NCC matters; and
- (c) a representative of the Australian Local Government Association (ALGA); and
- (d) representatives of the building and construction industry, including one representative with plumbing expertise.

The Building Codes Committee (BCC) is the peak technical advisory body to the ABCB, with responsibility for technical matters associated with the BCA.

The BCC comprises—

- (a) a representative of the ABCB; and
- (b) one nominee each of the Australian, State and Territory government members of the ABCB; and
- (c) representatives of the building and construction industry.

LEGISLATIVE ARRANGEMENTS

GENERAL

The BCA is given legal effect by building regulatory legislation in each State and Territory. This legislation consists of an Act of Parliament and subordinate legislation which empowers the regulation of certain aspects of buildings and structures, and contains the administrative provisions necessary to give effect to the legislation.

Any provision of the BCA may be overridden by, or subject to, State or Territory legislation. The BCA must therefore be read in conjunction with that legislation. Any queries on such matters should be referred to the State or Territory authority responsible for building regulatory matters.

STATE AND TERRITORY VARIATIONS AND ADDITIONS

Each State's and Territory's legislation adopts the BCA subject to the variation or deletion of some of its provisions, or the addition of extra provisions. These variations, deletions and additions are contained in Appendices to the BCA.

ARCHIVED
CONTENTS AND FEATURES INTRODUCTION

Flags identifying variations are located within relevant provisions and at the beginning of relevant Tables. Additional provisions to a Part of the BCA are identified at the end of that Part.

BCA ADOPTION

The dates of adoption and amendments are shown in the “History of Adoption” division at the end of this Volume.

DOCUMENTATION OF DECISIONS

Decisions made under the BCA should be fully documented and copies of all relevant documentation should be retained.

Examples of the kind of documentation which should be prepared and retained include:

- (a) Details of the *Performance Solution* or the *Deemed-to-Satisfy Solution* including all relevant plans and other supporting documentation.
- (b) In cases where a *Performance Solution* has been proposed—
 - (i) details of the relevant *Performance Requirements*; and
 - (ii) the *Assessment Method* or methods used to establish compliance with the relevant *Performance Requirements*; and
 - (iii) details of any *Expert Judgement* relied upon including the extent to which the judgement was relied upon and the qualifications and experience of the expert; and
 - (iv) details of any tests or calculations used to determine compliance with the relevant *Performance Requirements*; and
 - (v) details of any Standards or other information which were relied upon.

GENERAL PROVISIONS

- A0** **Application**
- A1** **Interpretation**
- A2** **Acceptance of Design and Construction**
- A3** **Classification of Buildings and Structures**
- A4** **United Buildings**

SECTION A CONTENTS

SECTION A GENERAL PROVISIONS

Part A0 Application

- A0.1 Compliance with the NCC
- A0.2 Meeting the Performance Requirements
- A0.3 Performance Solutions
- A0.4 Deemed-to-Satisfy Solutions
- A0.5 Assessment Methods
- A0.6 Defined Terms
- A0.7 Relevant Performance Requirements

Part A1 Interpretation

- A1.1 Definitions
- A1.2 Adoption of Standards and other references
- A1.3 Referenced Standards, etc
- A1.4 Differences between referenced documents and the NCC
- A1.5 Compliance with all Performance Requirements
- A1.6 Application of the NCC to a particular State or Territory
- A1.7 Language
- A1.8 Explanatory Information

Part A2 Acceptance of Design and Construction

- A2.1 Suitability of materials
- A2.2 Evidence of suitability
- A2.3 Fire-resistance of building elements
- A2.4 Fire hazard properties
- A2.5 Resistance to the incipient spread of fire

Part A3 Classification of Buildings and Structures

- A3.1 Principles of classification
- A3.2 Classifications
- A3.3 Multiple classification
- A3.4 Parts with more than one classification

Part A4 United Buildings

- A4.1 When buildings are united
- A4.2 Alterations in a united building

Specifications

- Specification A1.1 Fire-Protected Timber
- Specification A1.3 Documents Adopted By Reference
- Specification A2.3 Fire-Resistance of Building Elements
- Specification A2.4 Fire Hazard Properties

ARCHIVED
GENERAL PROVISIONS

PART A0 APPLICATION

A0.1 Compliance with the NCC

Compliance with the NCC is achieved by satisfying the *Performance Requirements*.

A0.2 Meeting the Performance Requirements

The *Performance Requirements* can only be satisfied by a—

- (a) *Performance Solution*; or
- (b) *Deemed-to-Satisfy Solution*; or
- (c) combination of (a) and (b).

Figure A0.2

NCC COMPLIANCE STRUCTURE

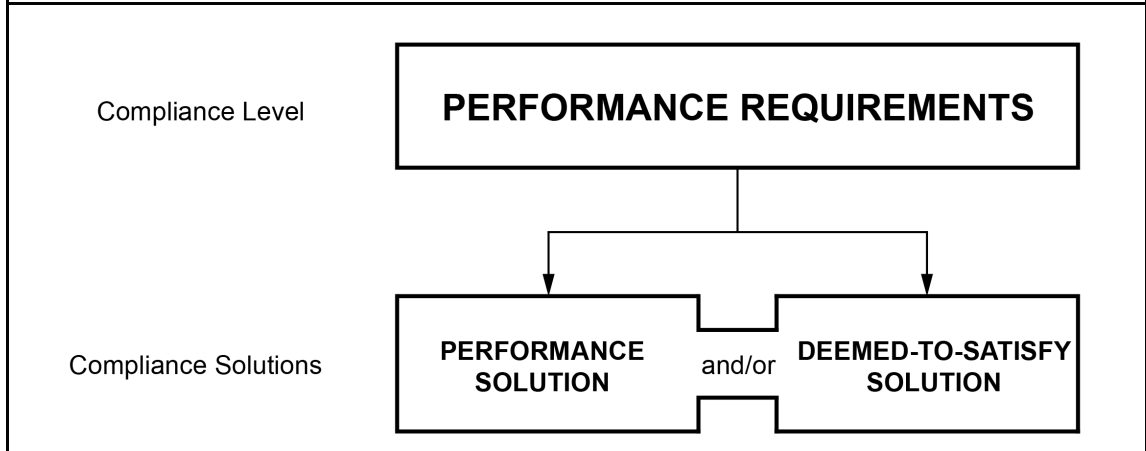

Note:

- 1. The term *Performance Solution* was formerly known as *Alternative Solution*.
- 2. The terms *Performance Solution* and *Deemed-to-Satisfy Solution* were formerly used under the term *Building Solution*.

A0.3 Performance Solutions

- (a) A *Performance Solution* must—
 - (i) comply with the *Performance Requirements*; or
 - (ii) be at least *equivalent* to the *Deemed-to-Satisfy Provisions*, and be assessed according to one or more of the *Assessment Methods*.
- (b) A *Performance Solution* will only comply with the NCC when the *Assessment Methods* used satisfactorily demonstrate compliance with the *Performance Requirements*.

A0.4 Deemed-to-Satisfy Solutions

- (a) A *Deemed-to-Satisfy Solution* which complies with the *Deemed-to-Satisfy Provisions* is deemed to comply with the *Performance Requirements*.
- (b) A *Deemed-to-Satisfy Solution* may be assessed according to one or more of the *Assessment Methods*, as appropriate.

A0.5 Assessment Methods

The following *Assessment Methods*, or any combination of them, can be used to determine that a *Performance Solution* or a *Deemed-to-Satisfy Solution* complies with the *Performance Requirements*, as appropriate:

- (a) Evidence to support that the use of a material or product, form of construction or design meets a *Performance Requirement* or a *Deemed-to-Satisfy Provision* as described in **A2.2**.
- (b) *Verification Methods* such as—
 - (i) the *Verification Methods* in the NCC; or
 - (ii) such other *Verification Methods* as the *appropriate authority* accepts for determining compliance with the *Performance Requirements*.
- (c) *Expert Judgement*.
- (d) Comparison with the *Deemed-to-Satisfy Provisions*.

A0.6 Defined terms

Words with specific meanings are printed in *italics* and are defined in **A1.1**.

A0.7 Relevant Performance Requirements

In order to comply with the provisions of **A1.5** (to comply with Section A and the NCC *Performance Requirements*) the following method must be used to determine the *Performance Requirement* or *Performance Requirements* relevant to the *Performance Solution*:

- (a) Where a *Performance Requirement* is satisfied entirely by a *Performance Solution*:
 - (i) Identify the relevant *Performance Requirement* from the Section or Part to which the *Performance Solution* applies.
 - (ii) Identify *Performance Requirements* from other Sections or Parts that are relevant to any aspects of the *Performance Solution* proposed or that are affected by the application of the *Performance Solution*.
- (b) Where a *Performance Requirement* is satisfied by a *Performance Solution* in combination with a *Deemed-to-Satisfy Solution*:
 - (i) Identify the relevant *Deemed-to-Satisfy Provisions* of each Section or Part that is to be the subject of the *Performance Solution*.
 - (ii) Identify the *Performance Requirements* from the same Sections or Parts that are relevant to the identified *Deemed-to-Satisfy Provisions*.
 - (iii) Identify *Performance Requirements* from other Sections or Parts that are relevant to any aspects of the *Performance Solution* proposed or that are affected by the application of the *Deemed-to-Satisfy Provisions* that are the subject of the *Performance Solution*.

PART A1 INTERPRETATION

A1.1 Definitions

Note: States and Territories may vary or add to the definitions contained in **A1.1** at the relevant State or Territory Appendix.

In Volume One of the BCA unless the contrary intention appears—

Accessible means having features to enable use by people with a disability.

Accessway means a continuous *accessible* path of travel (as defined in AS 1428.1) to, into or within a building.

Aged care building means a Class 9c building for residential accommodation of aged persons who, due to varying degrees of incapacity associated with the ageing process, are provided with *personal care services* and 24 hour staff assistance to evacuate the building during an emergency.

Air-conditioning , for the purposes of **Section J**, means a *service* that actively cools or heats the air within a space, but does not include a *service* that directly—

- (a) cools or heats cold or hot rooms; or
- (b) maintains specialised conditions for equipment or processes, where this is the main purpose of the *service*.

Alpine area means land—

- (a) likely to be subject to significant snowfalls; and
- (b) in New South Wales, A.C.T. or Victoria more than 1200 m above the Australian Height Datum; and
- (c) in Tasmania more than 900 m above the Australian Height Datum.

Alteration , in relation to a building, includes an addition or extension to a building.

Alternative Solution means a *Performance Solution*.

Annual energy consumption means the theoretical amount of energy used annually by the building's *services*, excluding kitchen exhaust and the like.

(NSW, Appropriate authority)

Appropriate authority means the relevant authority with the statutory responsibility to determine the particular matter.

(NSW, Assembly building)

(SA, Assembly building)

Assembly building means a building where people may assemble for—

- (a) civic, theatrical, social, political or religious purposes including a library, theatre, public hall or place of worship; or
- (b) educational purposes in a *school*, *early childhood centre*, preschool, or the like; or
- (c) entertainment, recreational or sporting purposes including—
 - (i) a discotheque, nightclub or a bar area of a hotel or motel providing live entertainment or containing a dance floor; or
 - (ii) a cinema; or
 - (iii) a sports stadium, sporting or other club; or
- (d) transit purposes including a bus station, railway station, airport or ferry terminal.

Assessment Method means a method that can be used for determining that a *Performance Solution* or *Deemed-to-Satisfy Solution* complies with the *Performance Requirements*.

Atrium means a space within a building that connects 2 or more *storeys*, and—

- (a) is wholly or substantially enclosed at the top by a floor or roof (including a glazed roof structure); and
- (b) includes any adjacent part of the building not separated by an appropriate barrier to fire; but
- (c) does not include a stairwell, rampwell or the space within a *shaft*.

Atrium well means a space in an *atrium* bounded by the perimeter of the openings in the floors or by the perimeter of the floors and the *external walls*.

Automatic means designed to operate when activated by a heat, smoke or fire sensing device.

Average recurrence interval , applied to rainfall, means the expected or average interval between exceedances for a 5 minute duration rainfall intensity.

Average specific extinction area means the average specific extinction area for smoke as determined by AS/NZS 3837.

Backstage means a space associated with, and adjacent to, a *stage* in a Class 9b building for scenery, props, equipment, dressing rooms, or the like.

Boiler means a vessel or an arrangement of vessels and interconnecting parts, wherein steam or other vapour is generated, or water or other liquid is heated at a pressure above that of the atmosphere, by the application of fire, the products of combustion, electrical power, or similar high temperature means, and—

- (a) includes superheaters, reheaters, economisers, *boiler* piping, supports, mountings, valves, gauges, fittings, controls, the *boiler* settings and directly associated equipment; but
- (b) excludes a fully flooded or pressurised system where water or other liquid is heated to a temperature lower than the normal atmospheric boiling temperature of the liquid.

Building Solution means a solution which complies with the *Performance Requirements* and is a—

- (a) *Performance Solution*; or
- (b) *Deemed-to-Satisfy Solution*; or
- (c) combination of (a) and (b).

Carpark means a building that is used for the parking of motor vehicles but is neither a *private garage* nor used for the servicing of vehicles, other than washing, cleaning or polishing.

Cavity wall , for the purposes of **FB1**, means a wall that incorporates a drained cavity.

Certificate of Accreditation means a certificate issued by a State or Territory accreditation authority stating that the properties and performance of a building material or method of construction or design fulfill specific requirements of the BCA.

Certificate of Conformity means a certificate issued under the ABCB scheme for products and systems certification stating that the properties and performance of a building material or method of construction or design fulfill specific requirements of the BCA.

Climate zone means an area defined in **Figure A1.1** and in **Table A1.1** for specific locations, having energy efficiency provisions based on a range of similar climatic characteristics.

Figure A1.1 — CLIMATE ZONES FOR THERMAL DESIGN

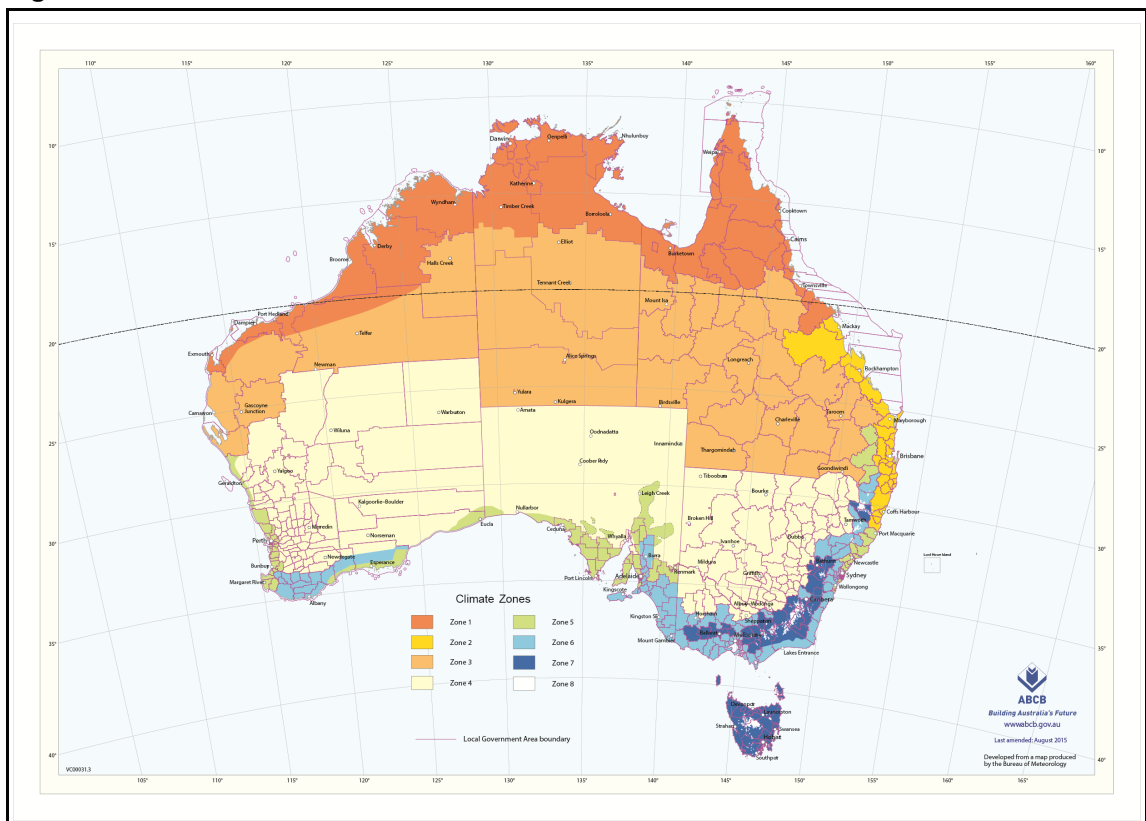

Notes:

1. This map can be viewed in enlargeable form on the ABCB website at www.abcb.gov.au.
2. A Zone 4 area in South Australia, other than a council area, at an altitude greater than 300 m above the Australian Height Datum is to be considered as Zone 5.

These areas have been defined in an enlarged format on the following maps produced by the Department of Planning, Transport and Infrastructure:

Adelaide Hills Council Climate Zone Map

Barossa Council Climate Zone Map

Figure A1.1 — CLIMATE ZONES FOR THERMAL DESIGN— continued

Regional Council of Goyder Climate Zone Map
These maps can be viewed on the Government of South Australia website at www.sa.gov.au
3. Locations in <i>climate zone</i> 8 are in <i>alpine areas</i> .

Table A1.1 CLIMATE ZONES FOR THERMAL DESIGN - VARIOUS LOCATIONS

Location	Climate zone	Location	Climate zone	Location	Climate zone	Location	Climate zone
Australian Capital Territory				Canberra	7		
New South Wales							
Albury	4	Byron Bay	2	Lord Howe Island	2	Sydney West	6
Armidale	7	Cobar	4	Moree	4	Tamworth	4
Batemans Bay	6	Coffs Harbour	2	Newcastle	5	Thredbo	8
Bathurst	7	Dubbo	4	Nowra	6	Wagga Wagga	4
Bega	6	Goulburn	7	Orange	7	Williamstown	5
Bellingen Shire - Dorrigo Plateau	7	Grafton	2	Perisher Smiggins	8	Wollongong	5
Bellingen Shire - Valley & seaboard	2	Griffith	4	Port Macquarie	5	Yass	6
Bourke	4	Ivanhoe	4	Sydney East	5		
Broken Hill	4	Lismore	2				
Northern Territory							
Alice Springs	3	Elliot	3	Renner Springs	3		
Darwin	1	Katherine	1	Tennant Creek	3		
Queensland							
Birdsville	3	Cunnamulla	3	Maryborough	2	Toowoomba	5
Brisbane	2	Longreach	3	Mount Isa	3	Torrens Creek	3
Bundaberg	2	Gladstone	2	Normanton	1	Townsville	1
Cairns	1	Labrador	2	Rockhampton	2	Warwick	5
Cooktown	1	Mackay	2	Roma	3	Weipa	1
South Australia							
Adelaide	5	Kingscote	6	Marree	4	Port Lincoln	5
Bordertown	6	Leigh Creek	5	Mount Gambier	6	Renmark	5
Ceduna	5	Lobethal	6	Murray Bridge	6	Tarcoola	4
Cook	4	Loxton	5	Oodnadatta	4	Victor Harbour	6
Elliston	5	Naracoorte	6	Port Augusta	4	Whyalla	4

Table A1.1 CLIMATE ZONES FOR THERMAL DESIGN - VARIOUS LOCATIONS— continued

Location	Climate zone	Location	Climate zone	Location	Climate zone	Location	Climate zone
Tasmania							
Burnie	7	Flinders Island	7	Launceston	7	Rossarden	7
Bicheno	7	Hobart	7	New Norfolk	7	Smithton	7
Deloraine	7	Huonville	7	Oatlands	7	St Marys	7
Devonport	7	King Island	7	Orford	7	Zeehan	7
Victoria							
Anglesea	6	Bright	7	Horsham	6	Swan Hill	4
Ararat	7	Colac	6	Melbourne	6	Traralgon	6
Bairnsdale	6	Dandenong	6	Mildura	4	Wangaratta	7
Ballarat	7	Echuca	4	Portland	6	Warrnambool	6
Benalla	6	Geelong	6	Sale	6	Wodonga	6
Bendigo	6	Hamilton	7	Shepparton	4		
Western Australia							
Albany	6	Cocos Island	1	Kalgoorlie-Boulder	4	Port Hedland	1
Balladonia	4	Derby	1	Karratha	1	Wagin	4
Broome	1	Esperance	5	Meekatharra	4	Wyndham	1
Bunbury	5	Exmouth	1	Northam	4		
Carnarvon	3	Geraldton	5	Pemberton	6		
Christmas Island	1	Halls Creek	3	Perth	5		

Combustible means—

- (a) applied to a material — *combustible* as determined by AS 1530.1; and
- (b) applied to construction or part of a building — constructed wholly or in part of *combustible* materials.

Common wall means a wall that is common to adjoining buildings.

Conditioned space means a space within a building, including a ceiling or under-floor supply air plenum or return air plenum, where the environment is likely, by the intended use of the space, to have its temperature controlled by *air-conditioning*, but does not include—

- (a) a non-*habitable room* of a Class 2 building or Class 4 part of a building in which a heater with a capacity of not more than 1.2 kW or 4.3 MJ/hour provides the *air-conditioning*; or
- (b) a space in a Class 6, 7, 8 or 9b building where the input energy to an *air-conditioning* system is not more than 15 W/m² or 15 J/s.m² (54 KJ/hour.m²); or
- (c) a lift *shaft*.

Construction activity actions means actions due to stacking of building materials or the use of equipment, including cranes and trucks, during construction or actions which may be induced by floor to floor propping.

Critical radiant flux means the critical heat flux at extinguishment as determined by AS ISO 9239.1.

Curtain wall means a non-*loadbearing external wall* that is not a *panel wall*.

Deemed-to-Satisfy Provisions means provisions which are deemed to satisfy the *Performance Requirements*.

Deemed-to-Satisfy Solution means a method of satisfying the *Deemed-to-Satisfy Provisions*.

Defined flood event (DFE) means the flood event selected for the management of flood hazard for the location of specific development as determined by the *appropriate authority*.

Defined flood level (DFL) means the flood level associated with a *defined flood event* relative to a specified datum.

(NSW, Designated bushfire prone area)

Designated bushfire prone area means land which has been designated under a power of legislation as being subject, or likely to be subject, to bushfires.

Detention centre means a building in which persons are securely detained by means of the built structure including a prison, remand centre, juvenile *detention centre*, holding cells or psychiatric *detention centre*.

Direct fix cladding wall , for the purposes of **FV1**, means a wall with cladding attached directly to the wall framing without the use of a drained cavity.

(NSW, Early childhood centre)

(Tas, Early childhood centre)

(Vic, Early childhood centre)

Early childhood centre means any premises or part thereof providing or intending to provide a centre-based education and care service within the meaning of the Education and Care Services National Law Act 2010 (Vic), the Education and Care Services National Regulations and centre-based services that are licensed or approved under State and Territory children's services law, but excludes education and care primarily provided to school aged children in outside school hours settings.

Effective height means the vertical distance between the floor of the lowest *storey* included in the calculation of *rise in storeys* and the floor of the topmost *storey* (excluding the topmost *storey* if it contains only heating, ventilating, lift or other equipment, water tanks or similar service units).

Electric passenger lift means a power-operated lift for raising or lowering people in a car in which the motion of the car is obtained from an electric motor mechanically coupled to the hoisting mechanism.

Electricity network substation means a building in which high voltage supply is converted or transformed and which is controlled by a licensed network service provider designated under a power of legislation.

Electrohydraulic passenger lift means a power-operated lift for raising or lowering people in a car in which the motion of the car is obtained from the action of liquid under pressure acting on a piston or ram, the pressure being generated by a pump driven by an individual electric motor.

Envelope, for the purposes of **Section J**, means the parts of a building's *fabric* that separate a *conditioned space* or *habitable room* from—

- (a) the exterior of the building; or
- (b) a non-*conditioned space* including—
 - (i) the floor of a rooftop plant room, lift-machine room or the like; and
 - (ii) the floor above a *carpark* or warehouse; and
 - (iii) the *common wall* with a *carpark*, warehouse or the like.

Equivalent means equivalent to the level of health, safety and amenity provided by the *Deemed-to-Satisfy Provisions*.

Evacuation route means the continuous path of travel (including *exits*, *public corridors* and the like) from any part of a building, including within a *sole-occupancy unit* in a Class 2 or 3 building or Class 4 part, to a *safe place*.

Evacuation time means the time calculated from when the emergency starts for the occupants of the building to evacuate to a *safe place*.

Exit means—

- (a) Any, or any combination of the following if they provide egress to a road or *open space*—
 - (i) An internal or external stairway.
 - (ii) A ramp.
 - (iii) A *fire-isolated passageway*.
 - (iv) A doorway opening to a road or *open space*.
- (b) A *horizontal exit* or a *fire-isolated passageway* leading to a *horizontal exit*.

Expert Judgement means the judgement of an expert who has the qualifications and experience to determine whether a *Performance Solution* or *Deemed-to-Satisfy Solution* complies with the *Performance Requirements*.

External wall means an outer wall of a building which is not a *common wall*.

Fabric means the basic building structural elements and components of a building including the roof, ceilings, walls and floors.

Fan motor power means the power delivered to a motor of a fan, including the power needed for any drive and impeller losses.

(SA, Farming)

Farming means—

- (a) cultivating, propagating and harvesting plants or fungi or their products or parts, including seeds, spores, bulbs or the like, but does not include forestry; or
- (b) maintaining animals in any physical environment for the purposes of—
 - (i) breeding them; or
 - (ii) selling them; or
 - (iii) acquiring and selling their bodily produce such as milk, wool, eggs or the like; or

(c) a combination of **(a)** and **(b)**,

but does not include forestry or maintaining animals for sport or recreational purposes.

(SA, Farm building)

Farm building means a Class 7 or 8 building located on land primarily used for *farming*—

- (a) that is—
 - (i) used in connection with *farming*; or
 - (ii) used primarily to store one or more *farm vehicles*; or
 - (iii) a combination of **(i)** and **(ii)**; and
- (b) in which the total number of persons accommodated at any time does not exceed one person per 200 m² of *floor area* or part thereof, up to a maximum of 8 persons; and
- (c) with a total *floor area* of not more than 3500 m².

(SA, Farm shed)

Farm shed means a single *storey* Class 7 or 8 building located on land primarily used for *farming*—

- (a) that is—
 - (i) used in connection with *farming*; or
 - (ii) used primarily to store one or more *farm vehicles*; or
 - (iii) a combination of **(i)** and **(ii)**; and
- (b) occupied neither frequently nor for extended periods by people; and
- (c) in which the total number of persons accommodated at any time does not exceed 2; and
- (d) with a total *floor area* of more than 500 m² but not more than 2000 m².

(SA, Farm vehicle)

Farm vehicle means a vehicle used in connection with *farming*.

Fire brigade means a statutory authority constituted under an Act of Parliament having as one of its functions, the protection of life and property from fire and other emergencies.

Fire compartment means—

- (a) the total space of a building; or
- (b) when referred to in—
 - (i) the *Performance Requirements* — any part of a building separated from the remainder by barriers to fire such as walls and/or floors having an appropriate resistance to the spread of fire with any openings adequately protected; or
 - (ii) the *Deemed-to-Satisfy Provisions* — any part of a building separated from the remainder by walls and/or floors each having an FRL not less than that *required* for a *fire wall* for that type of construction and where all openings in the separating construction are protected in accordance with the *Deemed-to-Satisfy Provisions* of the relevant Part.

Fire hazard means the danger in terms of potential harm and degree of exposure arising from the start and spread of fire and the smoke and gases that are thereby generated.

Fire hazard properties means the following properties of a material or assembly that indicate how they behave under specific fire test conditions:

- (a) *Average specific extinction area*, *critical radiant flux* and *Flammability Index*, determined as defined in **A1.1**.
- (b) *Smoke-Developed Index*, *smoke development rate* and *Spread-of-Flame Index*, determined in accordance with **Specification A2.4**.
- (c) *Group number* and *smoke growth rate index* (SMOGR_{RC}), determined in accordance with **Specification C1.10**.

Fire intensity means the rate release of calorific energy in watts, determined either theoretically or empirically, as applicable.

Fire-isolated passageway means a corridor, hallway or the like, of *fire-resisting construction*, which provides egress to or from a *fire-isolated stairway* or *fire-isolated ramp* or to a road or *open space*.

Fire-isolated ramp means a ramp within a *fire-resisting* enclosure which provides egress from a *storey*.

Fire-isolated stairway means a stairway within a *fire-resisting shaft* and includes the floor and roof or top enclosing structure.

Fire load means the sum of the net calorific values of the *combustible* contents which can reasonably be expected to burn within a *fire compartment*, including furnishings, built-in and removable materials, and building elements. The calorific values must be determined at the ambient moisture content or humidity. (The unit of measurement is MJ.)

Fire-protected timber means *fire-resisting* timber building elements that comply with **Specification A1.1**.

Fire-protective covering means—

- (a) 13 mm fire-protective grade plasterboard; or
- (b) 12 mm cellulose cement flat sheeting complying with AS/NZS 2908.2 or ISO 8336; or
- (c) 12 mm fibrous plaster reinforced with 13 mm x 13 mm x 0.7 mm galvanised steel wire mesh located not more than 6 mm from the exposed face; or
- (d) other material not less fire-protective than 13 mm fire-protective grade plasterboard, fixed in accordance with the normal trade practice for a *fire-protective covering*.

Fire-resistance level (FRL) means the grading periods in minutes determined in accordance with **Specification A2.3**, for the following criteria—

- (a) *structural adequacy*; and
- (b) *integrity*; and
- (c) *insulation*,

and expressed in that order.

Note: A dash means that there is no requirement for that criterion. For example, 90/–/– means there is no requirement for an FRL for integrity and insulation, and –/–/– means there is no requirement for an FRL.

Fire-resisting, applied to a building element, means having an FRL appropriate for that element.

Fire-resisting construction means one of the Types of construction referred to in **Part C1**.

Fire safety system means one or any combination of the methods used in a building to—

- (a) warn people of an emergency; or
- (b) provide for safe evacuation; or
- (c) restrict the spread of fire; or
- (d) extinguish a fire,

and includes both active and passive systems.

Fire-source feature means—

- (a) the far boundary of a road, river, lake or the like adjoining the allotment; or
- (b) a side or rear boundary of the allotment; or
- (c) an *external wall* of another building on the allotment which is not a Class 10 building.

Fire wall means a wall with an appropriate resistance to the spread of fire that divides a *storey* or building into *fire compartments*.

Flashover , in relation to *fire hazard properties*, means a heat release rate of 1 MW.

Flammability Index means the index number as determined by AS 1530.2.

Flight means that part of a stairway that has a continuous series of risers, including risers of winders, not interrupted by a landing or floor.

(Vic, Flood hazard area)

Flood hazard area means the *site* (whether or not mapped) encompassing land lower than the *flood hazard level* which has been determined by the *appropriate authority*.

Flood hazard level (FHL) means the flood level used to determine the height of floors in a building and represents the *defined flood level* plus the *freeboard*.

Floor area means—

- (a) in relation to a building — the total area of all *storeys*; and
- (b) in relation to a *storey* — the area of all floors of that *storey* measured over the enclosing walls, and includes—
 - (i) the area of a *mezzanine* within the *storey*, measured within the finished surfaces of any *external walls*; and
 - (ii) the area occupied by any *internal walls* or partitions, any cupboard, or other built-in furniture, fixture or fitting; and
 - (iii) if there is no enclosing wall, an area which has a use that—
 - (A) contributes to the *fire load*; or
 - (B) impacts on the safety, health or amenity of the occupants in relation to the provisions of the BCA; and
- (c) in relation to a room — the area of the room measured within the finished surfaces of the walls, and includes the area occupied by any cupboard or other built-in furniture, fixture or fitting; and
- (d) in relation to a *fire compartment* — the total area of all floors within the *fire compartment* measured within the finished surfaces of the bounding construction, and if there is no bounding construction, includes an area which has a use which contributes to the *fire load*; and
- (e) in relation to an *atrium* — the total area of all floors within the *atrium* measured within the finished surfaces of the bounding construction and if no bounding construction, within the *external walls*.

(Vic, Freeboard)

Freeboard means the height above the *defined flood level* as determined by the *appropriate authority*, used to compensate for effects such as wave action and localised hydraulic behaviour.

Glazing, for the purposes of **Section J**, means a transparent or translucent element and its supporting frame located in the *envelope*, and includes a *window* other than a *roof light*.

Group number means the number of one of 4 groups of materials used in the regulation of *fire hazard properties* and applied to materials used as a finish, surface, lining, or attachment to a wall or ceiling.

Habitable room means a room used for normal domestic activities, and—

- (a) includes a bedroom, living room, lounge room, music room, television room, kitchen, dining room, sewing room, study, playroom, family room, home theatre and sunroom; but
- (b) excludes a bathroom, laundry, water closet, pantry, walk-in wardrobe, corridor, hallway, lobby, photographic darkroom, clothes-drying room, and other spaces of a specialised nature occupied neither frequently nor for extended periods.

Health-care building means a building whose occupants or patients undergoing medical treatment generally need physical assistance to evacuate the building during an emergency and includes—

- (a) a public or private hospital; or
- (b) a nursing home or similar facility for sick or disabled persons needing full-time care; or
- (c) a clinic, day surgery or procedure unit where the effects of the predominant treatment administered involve patients becoming non-ambulatory and requiring supervised medical care on the premises for some time after the treatment.

Horizontal exit means a *required* doorway between 2 parts of a building separated from each other by a *fire wall*.

House energy rating software means software accredited under the Nationwide House Energy Rating Scheme and is limited to assessing the potential thermal efficiency of the dwelling envelope.

Illuminance means the luminous flux falling onto a unit area of surface.

Illumination power density (W/m²) means the total of the power that will be consumed by the lights in a space, including any lamps, ballasts, current regulators and control devices other than those that are plugged into socket outlets for intermittent use such as floor standing lamps, desk lamps or work station lamps, divided by the area of the space.

Inclined lift means a power-operated device for raising or lowering people within a carriage that has one or more rigid guides on an inclined plane.

Insulation, in relation to an FRL, means the ability to maintain a temperature on the surface not exposed to the furnace below the limits specified in AS 1530.4.

Integrity, in relation to an FRL, means the ability to resist the passage of flames and hot gases specified in AS 1530.4.

Internal wall excludes a *common wall* or a party wall.

Lamp power density (W/m²) means the total of the maximum power rating of the lamps in a space, other than those that are plugged into socket outlets for intermittent use such as floor standing lamps, desk lamps or work station lamps, divided by the area of the space.

Latent heat gain means the heat gained by the vapourising of liquid without change of temperature.

Light source efficacy means the luminous flux of a lamp or the total radiant flux in the visible spectrum weighted by the spectral response of the eye, divided by the electric power that will be consumed by the lamp but excluding ballast and control gear power losses.

Lightweight construction means construction which incorporates or comprises—

- (a) sheet or board material, plaster, render, sprayed application, or other material similarly susceptible to damage by impact, pressure or abrasion; or
- (b) concrete and concrete products containing pumice, perlite, vermiculite, or other soft material similarly susceptible to damage by impact, pressure or abrasion; or
- (c) masonry having a thickness less than 70 mm.

Loadbearing means intended to resist vertical forces additional to those due to its own weight.

Low-rise, low-speed constant pressure lift means a power-operated low-rise, low-speed device for raising or lowering people with limited mobility on a carriage that is controlled by the application of constant pressure to a control.

Low-rise platform lift means a power-operated device for raising or lowering people with limited mobility on a platform, that is controlled automatically or by the application of constant pressure to a control.

Luminance contrast means the light reflected from one surface or component, compared to the light reflected from another surface or component.

Massive timber means an element not less than 75 mm thick as measured in each direction formed from chemically bonded laminated timber and includes:

- (a) Cross laminated timber (CLT).
- (b) Laminated veneer lumber (LVL).
- (c) Glued laminated timber (Glulam).

Mezzanine means an intermediate floor within a room.

Non-combustible means—

- (a) applied to a material — not deemed *combustible* as determined by AS 1530.1 — Combustibility Tests for Materials; and
- (b) applied to construction or part of a building — constructed wholly of materials that are not deemed *combustible*.

Non-illuminated exit sign means an *exit* sign that complies with the requirements for an externally illuminated *exit* sign under AS 2293.3, except clause 3.4.4.

Open-deck carpark means a carpark in which all parts of the parking *storeys* are cross-ventilated by permanent unobstructed openings in not fewer than 2 opposite or approximately opposite sides, and—

- (a) each side that provides ventilation is not less than $\frac{1}{6}$ of the area of any other side; and
- (b) the openings are not less than $\frac{1}{2}$ of the wall area of the side concerned.

Open space means a space on the allotment, or a roof or similar part of a building adequately protected from fire, open to the sky and connected directly with a public road.

Open spectator stand means a tiered stand substantially open at the front.

Other property means all or any of the following—

- (a) any building on the same or an adjoining allotment; and
- (b) any adjoining allotment; and
- (c) a road.

Outdoor air means air outside the building.

Outdoor air economy cycle is a mode of operation of an *air-conditioning* system that, when the outside air thermodynamic properties are favourable, increases the quantity of outside air used to condition the space.

Outfall means that part of the disposal system receiving *surface water* from the drainage system and may include a natural water course, kerb and channel, or soakage system.

Panel wall means a non-*loadbearing external wall*, in frame or similar construction, that is wholly supported at each *storey*.

Patient care area means a part of a *health-care building* normally used for the treatment, care, accommodation, recreation, dining and holding of patients including a *ward area* and *treatment area*.

Performance Requirement means a requirement which states the level of performance which a *Performance Solution* or *Deemed-to-Satisfy Solution* must meet.

Performance Solution (Alternative Solution) means a method of complying with the *Performance Requirements* other than by a *Deemed-to-Satisfy Solution*.

Personal care services means any of the following:

- (a) The provision of nursing care.
- (b) Assistance or supervision in—
 - (i) bathing, showering or personal hygiene; or
 - (ii) toileting or continence management; or
 - (iii) dressing or undressing; or
 - (iv) consuming food.
- (c) The provision of direct physical assistance to a person with mobility problems.
- (d) The management of medication.
- (e) The provision of substantial rehabilitative or development assistance.

Piping, for the purposes of **Section J**, means an assembly of pipes, with or without valves or other fittings, connected together for the conveyance of liquids and gases.

Pressure vessel means a vessel subject to internal or external pressure. It includes interconnected parts and components, valves, gauges and other fittings up to the first point of connection to connecting piping, and—

- (a) includes fire heaters and gas cylinders; but
- (b) excludes—
 - (i) any vessel that falls within the definition of a *boiler*; and
 - (ii) storage tanks and equipment tanks intended for storing liquids where the pressure at the top of the tank is not exceeding 1.4 kPa above or 0.06 kPa below atmospheric pressure; and
 - (iii) domestic-type hot water supply heaters and tanks; and
 - (iv) pressure vessels installed for the purposes of fire suppression or which serve a fire suppression system.

Primary building element means a member of a building designed specifically to take part of the loads specified in **B1.2** and includes roof, ceiling, floor, stairway or ramp and wall framing members including bracing members designed for the specific purpose of acting as a brace to those members.

Private bushfire shelter means a structure associated with, but not attached to, or part of a Class 1a dwelling that may, as a last resort, provide shelter for occupants from immediate life threatening effects of a bushfire.

Private garage means—

- (a) any garage associated with a Class 1 building; or
- (b) any single *storey* of a building of another Class containing not more than 3 vehicle spaces, if there is only one such *storey* in the building; or
- (c) any separate single *storey* garage associated with another building where such garage contains not more than 3 vehicle spaces.

Professional engineer means a person who is—

- (a) if legislation is applicable — a registered *professional engineer* in the relevant discipline who has appropriate experience and competence in the relevant field; or
- (b) if legislation is not applicable—
 - (i) a Corporate Member of the Institution of Engineers, Australia; or
 - (ii) eligible to become a Corporate Member of the Institution of Engineers, Australia, and has appropriate experience and competence in the relevant field.

Public corridor means an enclosed corridor, hallway or the like which—

- (a) serves as a means of egress from 2 or more *sole-occupancy units* to a *required exit* from the *storey* concerned; or
- (b) is *required* to be provided as a means of egress from any part of a *storey* to a *required exit*.

Pump power means the power delivered to a pump, including the power needed for any drivetrain.

R-Value (m².K/W) means the thermal resistance of a component calculated by dividing its thickness by its thermal conductivity.

Reference building means a hypothetical building that is used to calculate the maximum allowable annual energy load, or maximum allowable *annual energy consumption* for the proposed building.

Reflective insulation means a building membrane with a reflective surface such as a reflective foil laminate, reflective barrier, foil batt or the like capable of reducing radiant heat flow.

Registered Testing Authority means—

- (a) an organisation registered by the National Association of Testing Authorities (NATA) to test in the relevant field; or
- (b) an organisation outside Australia registered by an authority recognised by NATA through a mutual recognition agreement; or
- (c) an organisation recognised as being a *Registered Testing Authority* under legislation at the time the test was undertaken.

Renewable energy means energy that is derived from sources that are regenerated, replenished, or for all practical purposes cannot be depleted and the energy sources include, but are not limited to, solar, wind, hydroelectric, wave action and geothermal.

Required means *required* to satisfy a *Performance Requirement* or a *Deemed-to-Satisfy Provision* of the BCA as appropriate.

Residential aged care building means a building whose residents, due to their incapacity associated with the ageing process, are provided with physical assistance in conducting their daily activities and to evacuate the building during an emergency.

Resident use area means part of a Class 9c building normally used by residents, and—

- (a) includes *sole-occupancy units*, lounges, dining areas, activity rooms and the like; but
- (b) excludes offices, storage areas, commercial kitchens, commercial laundries and other spaces not for the use of residents.

Resistance to the incipient spread of fire, in relation to a ceiling membrane, means the ability of the membrane to insulate the space between the ceiling and roof, or ceiling and floor above, so as to limit the temperature rise of materials in this space to a level which will not permit the rapid and general spread of fire throughout the space.

Rise in storeys means the greatest number of *storeys* calculated in accordance with **C1.2**.

Roof light, for the purposes of **Section J** and **Part F4**, means a skylight, *window* or the like installed in a roof—

- (a) to permit natural light to enter the room below; and
- (b) at an angle between 0 and 70 degrees measured from the horizontal plane.

Safe place means—

- (a) a place of safety within a building—
 - (i) which is not under threat from a fire; and
 - (ii) from which people must be able to safely disperse after escaping the effects of an emergency to a road or *open space*; or
- (b) a road or *open space*.

Sanitary compartment means a room or space containing a closet pan or urinal.

Sarking-type material means a material such as a *reflective insulation* or other flexible membrane of a type normally used for a purpose such as water proofing, vapour proofing or thermal reflectance.

School includes a primary or secondary *school*, college, university or similar educational establishment.

Self-closing , applied to a door, means equipped with a device which returns the door to the fully closed position immediately after each opening.

Sensible heat gain means the heat gained which causes a change in temperature.

Service , for the purposes of **Section J**, means a mechanical or electrical system that uses energy to provide *air-conditioning*, mechanical ventilation, heated water supply, artificial lighting, vertical transport and the like within a building, but which does not include—

- (a) systems used solely for emergency purposes; and
- (b) cooking facilities; and
- (c) portable appliances.

Service station means a garage which is not a *private garage* and is for the servicing of vehicles, other than only washing, cleaning or polishing.

Shaft means the walls and other parts of a building bounding—

- (a) a well, other than an *atrium well*; or
- (b) a vertical chute, duct or similar passage, but not a chimney or flue.

Shower area means the area affected by water from a shower, including a shower over a bath.

Site means the part of the allotment of land on which a building stands or is to be erected.

Sitework means work on or around a *site*, including earthworks, preparatory to or associated with the construction, *alteration*, demolition or removal of a building.

Small-sized, low-speed automatic lift means a restricted use power-operated device for the infrequent raising or lowering of people with limited mobility on a platform that is controlled automatically but has the capability of being electrically isolated by a key-lockable control.

Smoke-and-heat vent means a vent, located in or near the roof for smoke and hot gases to escape if there is a fire in the building.

Smoke-Developed Index means the index number for smoke as determined by AS/NZS 1530.3.

Smoke development rate means the development rate for smoke as determined by testing flooring materials in accordance with AS ISO 9239.1.

Smoke growth rate index (SMOGR_{RC}) means the index number for smoke used in the regulation of *fire hazard properties* and applied to materials used as a finish, surface, lining or attachment to a wall or ceiling.

Sole-occupancy unit means a room or other part of a building for occupation by one or joint owner, lessee, tenant, or other occupier to the exclusion of any other owner, lessee, tenant, or other occupier and includes—

- (a) a dwelling; or
- (b) a room or suite of rooms in a Class 3 building which includes sleeping facilities; or
- (c) a room or suite of associated rooms in a Class 5, 6, 7, 8 or 9 building; or
- (d) a room or suite of associated rooms in a Class 9c building, which includes sleeping facilities and any area for the exclusive use of a resident.

Spread-of-Flame Index means the index number for spread of flame as determined by AS/NZS 1530.3.

Stage means a floor or platform in a Class 9b building on which performances are presented before an audience.

Stairway platform lift means a power-operated device for raising or lowering people with limited mobility on a platform (with or without a chair) in the direction of a stairway.

Standard Fire Test means the Fire-resistance Tests of Elements of Building Construction as described in AS 1530.4.

Storey means a space within a building which is situated between one floor level and the floor level next above, or if there is no floor above, the ceiling or roof above, but not—

- (a) a space that contains only—
 - (i) a lift *shaft*, stairway or meter room; or
 - (ii) a bathroom, shower room, laundry, water closet, or other *sanitary compartment*; or
 - (iii) accommodation intended for not more than 3 vehicles; or
 - (iv) a combination of the above; or
- (b) a *mezzanine*.

Structural adequacy, in relation to an FRL, means the ability to maintain stability and adequate *loadbearing* capacity as determined by AS 1530.4.

Surface water means all naturally occurring water, other than sub-*surface water*, which results from rainfall on or around the *site* or water flowing onto the *site*.

Swimming pool means any excavation or structure containing water and principally used, or that is designed, manufactured or adapted to be principally used for swimming, wading, paddling, or the like, including a bathing or wading pool, or spa.

Total R-Value means the sum of the *R-Values* of the individual component layers in a composite element including any building material, insulating material, airspace and associated surface resistances.

Total System Solar Heat Gain Coefficient (SHGC) means the fraction of incident irradiance on *glazing* or a *roof light* that adds heat to a building's space.

Total System U-Value (W/m².K) means the thermal transmittance of the composite element allowing for the effect of any airspaces and associated surface resistances.

Treatment area means an area within a *patient care area* such as an operating theatre and rooms used for recovery, minor procedures, resuscitation, intensive care and coronary care from which a patient may not be readily moved.

Unique wall, for the purposes of **FV1**, means a wall which is neither a *cavity wall* nor a *direct fix cladding wall*.

Verification Method means a test, inspection, calculation or other method that determines whether a *Performance Solution* complies with the relevant *Performance Requirements*.

Vessel means an open, pre-formed, pre-finished concave receptacle capable of holding water, usually for the purpose of washing, including a basin, sink, bath, laundry tub and the like.

Ward area means that part of a *patient care area* for resident patients and may contain areas for accommodation, sleeping, associated living and nursing facilities.

Waterproof means the property of a material that does not allow moisture to penetrate through it.

Water resistant means the property of a system or material that restricts moisture movement and will not degrade under conditions of moisture.

Wet area means an area within a building supplied with water from a water supply system, which includes bathrooms, showers, laundries and *sanitary compartments* and excludes kitchens, bar areas, kitchenettes or domestic food and beverage preparation areas.

Window includes a roof light, glass panel, glass block or brick, glass louvre, glazed sash, glazed door, or other device which transmits natural light directly from outside a building to the room concerned when in the closed position.

A1.2 Adoption of Standards and other references

Where a *Deemed-to-Satisfy Provision* references a document, rule, specification or provision, that adoption does not include a provision—

- (a) specifying or defining the respective rights, responsibilities or obligations as between themselves of any manufacturer, supplier or purchaser; or
- (b) specifying the responsibilities of any trades person or other building operative, architect, engineer, authority, or other person or body; or
- (c) requiring the submission for approval of any material, building component, form or method of construction, to any person, authority or body other than a person or body empowered under State or Territory legislation to give that approval; or
- (d) specifying that a material, building component, form or method of construction must be submitted to any person, authority or body for expression of opinion; or
- (e) permitting a departure from the code, rule, specification or provision at the sole discretion of the manufacturer or purchaser, or by arrangement or agreement between the manufacturer and purchaser.

A1.3 Referenced Standards, etc

- (a) A reference in a *Deemed-to-Satisfy Provision* to a document under **A1.2** refers to the edition or issue, together with any amendment, listed in **Specification A1.3** and only so much as is relevant in the context in which the document is quoted.
- (b) Any—
 - (i) reference in a document listed in **Specification A1.3** (primary document) to another document (secondary document); and
 - (ii) subsequent references to other documents in secondary documents and those other documents,

is a reference to the secondary and other documents as they existed at the time of publication of the primary document listed in **Specification A1.3**.

- (c) The provisions of (b) do not apply if the secondary referenced document is also a primary referenced document.
- (d) Where the BCA references a document under **A1.2** which is subject to publication of a new edition or amendment not listed under **Specification A1.3**, the new edition or amendment need not be complied with in order to comply with the *Deemed-to-Satisfy Provisions*.

A1.4 Differences between referenced documents and the NCC

The NCC overrules in any difference arising between it and any Standard, rule, specification or provision in a document listed in **Specification A1.3**.

A1.5 Compliance with all Performance Requirements

Subject to [A1.6](#), Class 2–9 buildings must be so designed and constructed that they comply with the relevant provisions of [Section A](#) and the *Performance Requirements* of this Volume.

A1.6 Application of the NCC to a particular State or Territory

For application within a particular State or Territory, this Volume of the NCC comprises—

- (a) Sections [A](#) to [J](#) (inclusive); and
- (b) the variations, deletions and additions to Sections [A](#) to [J](#) applicable to that State or Territory specified in the relevant Appendix.

A1.7 Language

- (a) A reference to a building in the NCC is a reference to an entire building or part of a building, as the case requires.
- (b) A reference in a *Performance Requirement* of the NCC to “the degree necessary” means that consideration of all the criteria referred to in the *Performance Requirement* will determine the outcome appropriate to the circumstances. These words have been inserted to indicate that in certain situations it may not be necessary to incorporate any specific measures to meet the *Performance Requirement*.
- (c) A reference to “BCA” in this volume, other than in the [Introduction](#), means “Volume One of the Building Code of Australia”.
- (d) A reference to a Class 1a, 1b, 7a, 7b, 9a, 9b, 9c, 10a, 10b and 10c is a reference to the separate classification.
- (e) A reference to—
 - (i) Class 1 — is a reference to a Class 1a and 1b; and
 - (ii) Class 7 — is a reference to a Class 7a and 7b; and
 - (iii) Class 9 — is a reference to a Class 9a, 9b and 9c; and
 - (iv) Class 10 — is a reference to a Class 10a, 10b and 10c.

A1.8 Explanatory Information

- (a) These elements of the BCA are non-mandatory. They are used to provide additional guidance on the application of the particular Parts and clauses and do not need to be followed to meet the requirements of the BCA.
- (b) Explanatory Information identified for cross-volume consideration is provided under certain *Deemed-to-Satisfy Provisions* to identify Parts of NCC Volume Three – the Plumbing Code of Australia (PCA) which may be relevant where the work being undertaken is subject to the requirements of the PCA.
- (c) The ABCB gives no warranty or guarantee that the Explanatory Information is correct or complete. The ABCB shall not be liable for any loss howsoever caused whether due to negligence or otherwise arising from the use of or reliance on the Explanatory Information.
- (d) The ABCB recommends that anyone seeking to rely on the Explanatory Information obtain their own independent expert advice in relation to building or related activities.

PART A2

ACCEPTANCE OF DESIGN AND CONSTRUCTION

A2.1 Suitability of materials

Every part of a building must be constructed in an appropriate manner to achieve the requirements of the BCA, using materials and construction being fit for the purpose for which they are intended including the provision of access for maintenance.

A2.2 Evidence of suitability

- (a) Subject to [A2.3](#) and [A2.4](#), evidence to support that the use of a material, form of construction or design meets a *Performance Requirement* or a *Deemed-to-Satisfy Provision* may be in the form of one or a combination of the following:
- (i) A report issued by a *Registered Testing Authority*, showing that the material or form of construction has been submitted to the tests listed in the report, and setting out the results of those tests and any other relevant information that demonstrates its suitability for use in the building.
 - (ii) A current *Certificate of Conformity* or a current *Certificate of Accreditation*.
 - (iii) A certificate from a *professional engineer* or other appropriately qualified person which—
 - (A) certifies that a material, design, or form of construction complies with the requirements of the BCA; and
 - (B) sets out the basis on which it is given and the extent to which relevant specifications, rules, codes of practice or other publications have been relied upon.
 - (iv) A current certificate issued by a product certification body that has been accredited by the Joint Accreditation System of Australia and New Zealand (JAS-ANZ).
 - (v) * * * * *
 - (vi) Any other form of documentary evidence that correctly describes the properties and performance of the material or form of construction and adequately demonstrates its suitability for use in the building.
- (b) Evidence to support that a calculation method complies with an ABCB protocol may be in the form of one or a combination of the following:
- (i) A certificate from a *professional engineer* or other appropriately qualified person which—
 - (A) certifies that the calculation method complies with a relevant ABCB protocol; and
 - (B) sets out the basis on which it is given and the extent to which relevant specifications, rules, codes of practice and other publications have been relied upon.
 - (ii) Any other form of documentary evidence that correctly describes how the calculation method complies with a relevant ABCB protocol.

- (c) Any copy of documentary evidence submitted, must be a complete copy of the original report or document.

A2.3 Fire-resistance of building elements

Where a *Deemed-to-Satisfy Provision* requires a building element to have an FRL, it must be determined in accordance with **Specification A2.3**.

A2.4 Fire hazard properties

Where a *Deemed-to-Satisfy Provision* requires a building component or assembly to have a *fire hazard property* it must be determined as follows:

- (a) For *average specific extinction area*, *critical radiant flux* or *Flammability Index* — as defined in **A1.1**.
- (b) For *Smoke-Developed Index*, *Spread-of-Flame Index* — in accordance with **Specification A2.4**.
- (c) For a material's *group number* or *smoke growth rate index* (SMOGR_{RC}) — **Clause 4(b) of Specification C1.10**.

A2.5 Resistance to the incipient spread of fire

A ceiling is deemed to have the *resistance to the incipient spread of fire* to the space above itself if—

- (a) it is identical with a prototype that has been submitted to the *Standard Fire Test* and the *resistance to the incipient spread of fire* achieved by the prototype is confirmed in a report from a *Registered Testing Authority* which—
- (i) describes the method and conditions of the test and form of construction of the tested prototype in full; and
 - (ii) certifies that the application of restraint to the prototype complies with the *Standard Fire Test*; or
- (b) it differs in only a minor degree from a prototype tested under (a) and the *resistance to the incipient spread of fire* attributed to the ceiling is confirmed in a report from a *Registered Testing Authority* which—
- (i) certifies that the ceiling is capable of achieving the *resistance to the incipient spread of fire* despite the minor departures from the tested prototype; and
 - (ii) describes the materials, construction and conditions of restraint which are necessary to achieve the *resistance to the incipient spread of fire*.

ACT A02 to A2.102

PART A3

CLASSIFICATION OF BUILDINGS AND STRUCTURES

A3.1 Principles of classification

The classification of a building or part of a building is determined by the purpose for which it is designed, constructed or adapted to be used.

A3.2 Classifications

Buildings are classified as follows:

Class 1: one or more buildings which in association constitute—

- (a) **Class 1a** — a single dwelling being—
 - (i) a detached house; or
 - (ii) one of a group of two or more attached dwellings, each being a building, separated by a *fire-resisting* wall, including a row house, terrace house, town house or villa unit; or
- (b) **Class 1b** —
 - (i) a boarding house, guest house, hostel or the like—
 - (A) with a total area of all floors not exceeding 300 m² measured over the enclosing walls of the Class 1b; and
 - (B) in which not more than 12 persons would ordinarily be resident; or
 - (ii) 4 or more single dwellings located on one allotment and used for short-term holiday accommodation,

which are not located above or below another dwelling or another Class of building other than a *private garage*.

Class 2: a building containing 2 or more *sole-occupancy units* each being a separate dwelling.

Class 3: a residential building, other than a building of Class 1 or 2, which is a common place of long term or transient living for a number of unrelated persons, including—

- (a) a boarding house, guest house, hostel, lodging house or backpackers accommodation; or
- (b) a residential part of a hotel or motel; or
- (c) a residential part of a *school*; or
- (d) accommodation for the aged, children or people with disabilities; or
- (e) a residential part of a *health-care building* which accommodates members of staff; or
- (f) a residential part of a *detention centre*.

Class 4: a dwelling in a building that is Class 5, 6, 7, 8 or 9 if it is the only dwelling in the building.

Class 5: an office building used for professional or commercial purposes, excluding buildings of Class 6, 7, 8 or 9.

NSW Class 6

SA Class 6

Class 6: a shop or other building for the sale of goods by retail or the supply of services direct to the public, including—

- (a) an eating room, café, restaurant, milk or soft-drink bar; or
- (b) a dining room, bar area that is not an *assembly building*, shop or kiosk part of a hotel or motel; or
- (c) a hairdresser's or barber's shop, public laundry, or undertaker's establishment; or
- (d) market or sale room, showroom, or *service station*.

Class 7: a building which is—

- (a) **Class 7a** — a *carpark*; or
- (b) **Class 7b** — for storage, or display of goods or produce for sale by wholesale.

Class 8: a laboratory, or a building in which a handicraft or process for the production, assembling, altering, repairing, packing, finishing, or cleaning of goods or produce is carried on for trade, sale, or gain.

Class 9: a building of a public nature—

- (a) **Class 9a** — a *health-care building*, including those parts of the building set aside as a laboratory; or
- (b) **Class 9b** — an *assembly building*, including a trade workshop, laboratory or the like in a primary or secondary *school*, but excluding any other parts of the building that are of another Class; or
- (c) **Class 9c** — an *aged care building*.

Class 10: a non-habitable building or structure—

- (a) **Class 10a** — a non-habitable building being a *private garage*, carport, shed, or the like; or
- (b) **Class 10b** — a structure being a fence, mast, antenna, retaining or free-standing wall, *swimming pool*, or the like; or
- (c) **Class 10c** — a *private bushfire shelter*.

A3.3 Multiple classification

Each part of a building must be classified separately, and—

- (a)
 - (i) where parts have different purposes — if not more than 10% of the *floor area* of a *storey*, being the minor use, is used for a purpose which is a different classification, the classification applying to the major use may apply to the whole *storey*; and
 - (ii) the provisions of (i) do not apply when the minor use is a laboratory or Class 2, 3 or 4 part; and
- (b) a plant room, machinery room, lift motor room, boiler room or the like must have the same classification as the part of the building in which it is situated; and
- (c) if a building has parts of different classification, each part must comply with all the relevant provisions for its classification.

A3.4 Parts with more than one classification

- (a) Notwithstanding **A3.3**, a building or part of a building may have more than one classification applying to the whole building or to the whole of that part of the building.
- (b) If a building or part of a building has more than one classification applying to the whole building or part in accordance with **(a)**, that building or part must comply with all the relevant provisions of the BCA for each classification.

PART **A4** UNITED BUILDINGS

A4.1 When buildings are united

Two or more buildings adjoining each other form one united building if they—

- (a) are connected through openings in the walls dividing them; and
- (b) together comply with all the requirements of the BCA as though they are a single building.

A4.2 Alterations in a united building

If, after *alterations* or any other building work, two or more of the buildings in **A4.1** cease to be connected through openings in the dividing walls, each of those buildings not now connected must comply with all the requirements for a single building.

SPECIFICATION **A1.1** FIRE-PROTECTED TIMBER

1. Scope

This Specification contains requirements for *fire-protected timber* and procedures for determining the time at which the temperature at the interface between the protection system and the timber is exceeded.

2. Requirements

2.1 General requirements

- (a) *Fire-protected timber* must—
- (i) utilise a *non-combustible fire-protective covering* fixed in accordance with the system requirements to achieve an FRL not less than that *required* for the building element; and
 - (ii) have a *non-combustible fire-protective covering* fixed in accordance with system requirements—
 - (A) to achieve a resistance to the incipient spread of fire of not less than 45 minutes when tested in accordance with—
 - (aa) for horizontal elements — Section 4 of AS 1530.4; and
 - (bb) for other elements — the relevant test procedures from Section 4 of AS 1530.4 applied to the element lining; or
 - (B) which consists of not less than 2 layers of 13 mm thick, fire-protective grade plasterboard.
- (b) For the purposes of (a), the *non-combustible fire-protective covering* provided under (a)(ii) may form all or part of the *non-combustible fire-protective covering* provided under (a)(i).

2.2 Massive timber

- (a) *Fire-protected timber*, where the timber is *massive timber*, need not comply with **Clause 2.1** if the *fire-protected timber*—
- (i) utilises a *non-combustible fire-protective covering* fixed in accordance with system requirements to achieve an FRL not less than that *required* for the building element; and
 - (ii) has a *non-combustible fire-protective covering* fixed in accordance with system requirements—
 - (A) so as the temperature at the interface between the protection system and the timber does not exceed 300°C during a fire resistance test performed in accordance with **Clause 3** for the application and periods listed in **Table 1**; or
 - (B) not less than that specified by **Table 1**; and
 - (iii) has no cavities—

- (A) between the surface of the timber and the *fire-protective covering*; or
 - (B) between timber elements within the *fire-protective covering*.
- (b) For the purposes of (a), the *non-combustible fire-protective covering* provided under (a)(ii) may form all or part of the *non-combustible fire-protective covering* provided under (a)(i).

Table 1 INTERFACE TEMPERATURE AND MINIMUM FIRE-PROTECTIVE GRADE PLASTERBOARD THICKNESS

Application	Time – minutes without timber interface exceeding 300°C	Minimum thickness of fire-grade plasterboard (mm)
Inside a <i>fire-isolated stairway</i> or lift shaft	20	13
<i>External walls</i> within 1 m of an allotment boundary or 2 m of a building on the same allotment	45	2 x 13
All other applications	30	16

3. Determination of time the timber interface temperature exceeds 300°C for timber at least 75 mm thick

3.1 Form of test

- (a) Tests must be carried out in accordance with the *Standard Fire Test*, or an equivalent or more severe test, on the timber element with the proposed *non-combustible* coverings fixed in a representative manner, with the time the timber interface temperatures exceeded 300°C confirmed in a report from a *Registered Testing Authority*.
- (b) If a fire protection system incorporates joints, the test specimens must incorporate representative joints.
- (c) Interface temperatures must be measured over the following features by a minimum of two thermocouples:
 - (i) At joint positions in the protection systems.
 - (ii) At least 200 mm from any joint.
 - (iii) At service penetrations.
 - (iv) At any other locations where, in the opinion of the *Registered Testing Authority*, the interface temperature may be higher than the above positions.
- (d) The temperatures must be measured in accordance with Appendix C1 and Section 2 of AS 1530.4 as appropriate.

3.2 Smaller specimen permitted

A *Registered Testing Authority* may carry out the test specified in **Clause 3.1** at pilot scale provided—

- (a) a specimen (which must be not less than 1000 mm x 1000 mm) adequately represents the proposed construction in the building; and

- (b) the fire resistance of the specimen has already been determined in a full scale test performed in accordance with AS 1530.4 to demonstrate adequate retention of the fire protection system in conjunction with the timber elements being protected; and
- (c) the results of the test do not apply to construction larger than limits defined by the *Registered Testing Authority* conducting the pilot examination.

3.3 Acceptance criteria

The time the timber interface temperature exceeds 300°C must be taken as the minimum time any of the thermocouples specified in **Clause 3.1** exceeded 300°C.

SPECIFICATION **A1.3** DOCUMENTS ADOPTED BY REFERENCE

1. Schedule of referenced documents

ACT, NSW, NT, QLD, SA, Tas, Vic Spec A1.3 Table 1

The Standards and other documents listed in **Table 1** are referred to in Volume One of the BCA.

Table 1: SCHEDULE OF REFERENCED DOCUMENTS

No.	Date	Title	BCA Clause(s)
AS ISO 717 Part 2	2004	Acoustics — Rating of sound insulation in buildings and building elements Impact sound insulation	F5.3, FV5.1
AS/NZS 1170 Part 0	2002	Structural design actions General principles Amdt 1 Amdt 3 Amdt 4	B1.1, B1.2, Spec B1.2
Part 1	2002	Permanent, imposed and other actions Amdt 1 Amdt 2	B1.2
Part 2	2011	Wind actions Amdt 1 Amdt 2 Amdt 3	B1.2, B1.4, Spec B1.2, FV1
Part 3	2003	Snow and ice actions Amdt 1	B1.2
AS 1170 Part 4	2007	Structural design actions Earthquake actions in Australia Amdt 1	B1.2
AS 1191	2002	Acoustics — Method for laboratory measurement of airborne sound insulation of building elements	Spec F5.5
AS/NZS 1276		Acoustics — Rating of sound insulation in buildings and of building elements	

Table 1: SCHEDULE OF REFERENCED DOCUMENTS — continued

No.	Date	Title	BCA Clause(s)
Part 1	1999	Airborne sound insulation [Note: Test reports based on AS1276 – 1979 and issued prior to AS/NZS 1276.1 – 1999 being referenced in the BCA, remain valid. The STC values in reports based on AS 1276 – 1979 shall be considered to be equivalent to R _w values. Test reports prepared after the BCA reference date for AS/NZS 1276.1 – 1999 must be based on that version]	F5.2, FV5.1, FV5.2
AS 1288	2006	Glass in buildings — Selection and Installation Amdt 1 Amdt 2	B1.4, Spec C2.5, Spec C3.4
AS 1428		Design for access and mobility	
Part 1	2009	General requirements for access — New building work Amdt 1	A1.1, D2.10, D2.15, D2.17, D3.1, D3.2, D3.3, D3.6, D3.8, D3.9, D3.10, D3.12, Spec D3.10, E3.8, F2.4, G4.5
Part 1	2001	General requirements for access — New building work	H2.7, H2.8, H2.10, H2.15
Part 1 (Supplement 1)	1993	General requirements for access — Buildings — Commentary	H2.2
Part 2	1992	Enhanced and additional requirements — Buildings and facilities	H2.2, H2.3, H2.4, H2.5, H2.7, H2.10, H2.11, H2.12, H2.13, H2.14
Part 4	1992	Tactile ground surface indicators for orientation of people with vision impairment	H2.11
AS/NZS 1428		Design for access and mobility	
Part 4.1	2009	Means to assist the orientation of people with vision impairment — Tactile ground surface indicators Amdt 1 Amdt 2	D3.8

Table 1: SCHEDULE OF REFERENCED DOCUMENTS — continued

No.	Date	Title	BCA Clause(s)
AS 1530		Methods for fire tests on building materials, components and structures	
Part 1	1994	Combustibility test for materials	A1.1
Part 2	1993	Test for flammability of materials	A1.1
Part 4	2014	Amdt 1 Fire-resistance tests on elements of construction [Note: Subject to the note to AS 4072.1, reports relating to tests carried out under earlier editions of AS 1530 Parts 1 to 4 remain valid. Reports relating to tests carried out after the date of an amendment to a Standard must relate to the amended Standard]	A1.1, C3.15, C3.16, Spec A2.4, Spec C3.15, Spec D1.12
AS/NZS 1530		Methods for fire tests on building materials, components and structures	
Part 3	1999	Simultaneous determination of ignitability, flame propagation, heat release and smoke release	A1.1, Spec A2.4
AS 1562		Design and installation of sheet roof and wall cladding	
Part 1	1992	Metal Amdt 1 Amdt 2 Amdt 3	B1.4, F1.5
AS/NZS 1562		Design and installation of sheet roof and wall cladding	
Part 2	1999	Corrugated fibre-reinforced cement	F1.5
Part 3	1996	Plastics	B1.4, F1.5
AS 1657	2013	Fixed platforms, walkways, stairways and ladders — Design, construction and installation	D1.16, D1.17, D2.18, H1.6, H3.5
AS/NZS 1664		Aluminium structures	
Part 1	1997	Limit state design Amdt 1	B1.4
Part 2	1997	Allowable stress design	B1.4

Table 1: SCHEDULE OF REFERENCED DOCUMENTS — continued

No.	Date	Title	BCA Clause(s)
		Amdt 1	
AS/NZS 1668 Part 1	2015	The use of ventilation and airconditioning in buildings Fire and smoke control in buildings	C2.12, C3.15, Spec C2.5, D1.7, Spec E1.8, E2.2, F4.12, Spec E2.2b, Spec G3.8
AS 1668 Part 2	2012	The use of ventilation and airconditioning in buildings Mechanical ventilation in buildings	FV4.1, F4.5, F4.11, F4.12, Spec J5.2a
Part 4	2012	Natural ventilation of buildings	F4.11
AS 1670 Part 1	2015	Fire detection, warning, control and intercom systems — Systems design, installation and commissioning Fire	C3.5, C3.6, C3.7, C3.8, C3.11, D2.21, G4.8, Spec C3.4, E2.2, Spec E2.2a, Spec G3.8
Part 3	2004	Fire alarm monitoring	Spec E2.2a
Part 4	2015	Sound systems and intercom systems for emergency purposes	E4.9, Spec G3.8
AS/NZS 1680 Part 0	2009	Interior lighting Safe Movement	F4.4
AS 1684 Part 2	2010	Residential timber-framed construction Non-cyclonic areas	B1.4, B1.5, F1.12
Part 3	2010	Amdt 1 Amdt 2 Cyclonic areas	B1.4, B1.5, F1.12
		Amdt 1	

Table 1: SCHEDULE OF REFERENCED DOCUMENTS — continued

No.	Date	Title	BCA Clause(s)
Part 4	2010	Simplified — non-cyclonic areas Amdt 1	B1.4, B1.5, F1.12
AS 1720 Part 1	 2010	Timber structures Design methods Amdt 1 Amdt 2 Amdt 3	 B1.4
Part 4	2006	Fire resistance for structural adequacy of timber members	Spec A2.3
Part 5	2015	Nailplated timber roof trusses	B1.4
AS 1735 Part 11	 1986	Lifts, escalators and moving walks Fire-rated landing doors	 C3.10
Part 12	1999	Facilities for persons with disabilities Amdt 1	 E3.6, H2.6
AS 1860 Part 2	 2006	Particleboard flooring Installation Amdt 1	 B1.4
AS 1905 Part 1	 2015	Components for the protection of openings in fire-resistant walls Fire-resistant doorsets	 C3.6, Spec C3.4
Part 2	2005	Fire-resistant roller shutters	Spec C3.4
AS 1926 Part 1	 2012	Swimming pool safety Safety barriers for swimming pools	 G1.1, G1.3
Part 2	2007	Location of safety barriers for swimming pools Amdt 1 Amdt 2	 G1.1
Part 3	2010	Water recirculation systems Amdt 1	 G1.1
AS 2047	2014	Windows and external glazed doors in buildings	B1.4, FV1, F1.13, J3.4
AS 2049	2002	Roof tiles Amdt 1	B1.4, F1.5

Table 1: SCHEDULE OF REFERENCED DOCUMENTS — continued

No.	Date	Title	BCA Clause(s)
AS 2050	2002	Installation of roof tiles Amdt 1 Amdt 2	B1.4, F1.5
AS 2118 Part 1	1999	Automatic fire sprinkler systems General requirements Amdt 1	Spec E1.5
Part 4	2012	Sprinkler protection for accommodation buildings not exceeding four storeys in height	Spec E1.5
Part 6	2012	Combined sprinkler and hydrant systems in multistorey buildings	Spec E1.5
AS 2159	2009	Piling — Design and installation Amdt 1	B1.4
AS 2293 Part 1	2005	Emergency escape lighting and exit signs for buildings System design, installation and operation Amdt 1 Amdt 2	E4.4, E4.8
Part 3	2005	Emergency escape luminaires and exit signs Amdt 1 Amdt 2	A1.1, H3.15
AS 2327 Part 1	2003	Composite structures Simply supported beams	Spec A2.3, B1.4
AS 2419 Part 1	2005	Fire hydrant installations System design, installation and commissioning Amdt 1	C2.12, E1.3
AS 2441	2005	Installation of fire hose reels Amdt 1	E1.4
AS 2444	2001	Portable fire extinguishers and fire blankets — Selection and location	E1.6
AS 2665	2001	Smoke/heat venting systems — Design, installation and commissioning	Spec E2.2c, Spec G3.8
AS 2870	2011	Residential slabs and footings	F1.10

Table 1: SCHEDULE OF REFERENCED DOCUMENTS — continued

No.	Date	Title	BCA Clause(s)
AS/NZS 2890 Part 6	2009	Parking facilities Off-street parking for people with disabilities	D3.5
AS/NZS 2904	1995	Damp-proof courses and flashings Amdt 1 Amdt 2	F1.9
AS/NZS 2908 Part 1	2000	Cellulose cement products Corrugated sheets	B1.4, F1.5
Part 2	2000	Flat sheets	A1.1
AS/NZS 2918	2001	Domestic solid-fuel burning appliances — Installation	G2.2
AS/NZS 3013	2005	Electrical installations — Classification of the fire and mechanical performance of wiring system elements	C2.13
AS/NZS 3500 Part 3	2015	Plumbing and drainage Stormwater drainage	F1.1
AS 3600	2009	Concrete structures Amdt 1 Amdt 2	Spec A2.3, B1.4
AS 3660 Part 1	2014	Termite management New building work	B1.4, F1.9
Part 1	2000	New building work [Note: The 2000 edition has been retained for a transitional period ending on 30 April 2017]	B1.4, F1.9
AS/NZS 3666 Part 1	2011	Air-handling and water systems of buildings — Microbial control Design, installation and commissioning	F2.7, F4.5
AS 3700	2011	Masonry structures Amdt 1	Spec A2.3, B1.4
AS 3740	2010	Waterproofing of domestic wet areas Amdt 1	F1.7
AS 3786	2014	Smoke alarms using scattered light, transmitted light or ionization Amdt 1	Spec E2.2a

Table 1: SCHEDULE OF REFERENCED DOCUMENTS — continued

No.	Date	Title	BCA Clause(s)
AS 3786	1993	Smoke alarms Amdt 1 Amdt 2 Amdt 3 Amdt 4 [Note: The 1993 edition has been retained for a transitional period ending on 30 April 2017]	Spec E2.2a
AS/NZS 3823 Part 1.2	2012	Performance of electrical appliances - Airconditioners and heat pumps Ducted airconditioners and air-to-air heat pumps — Testing and rating for performance	JV2, JV3, Spec J5.2e
AS/NZS 3837	1998	Method of test for heat and smoke release rates for materials and products using an oxygen consumption calorimeter Amdt 1	A1.1
AS 3959	2009	Construction of buildings in bushfire-prone areas Amdt 1 Amdt 2 Amdt 3	G5.2
AS 4072 Part 1	2005	Components for the protection of openings in fire-resistant separating elements Service penetrations and control joints Amdt 1 [Note: Systems tested to AS 1530.4 prior to 1 January 1995 need not be retested to comply with the provisions in AS 4072.1]	C3.15
AS 4100	1998	Steel Structures Amdt 1	Spec A2.3, B1.4
AS/NZS 4200 Part 1 Part 2	1994 1994	Pliable building membranes and underlays Materials Amdt 1 Installation requirements	F1.6
AS 4254		Ductwork for air-handling systems in buildings	Spec C1.10, Spec J5.2b

Table 1: SCHEDULE OF REFERENCED DOCUMENTS — continued

No.	Date	Title	BCA Clause(s)
Part 1	2012	Flexible duct	
Part 2	2012	Rigid duct	
AS/NZS 4256		Plastic roof and wall cladding materials	B1.4, F1.5
Part 1	1994	General requirements	
Part 2	1994	Unplasticized polyvinyl chloride (uPVC) building sheets	
Part 3	1994	Glass fibre reinforced polyester (GRP)	
Part 5	1996	Polycarbonate	
AS/NZS 4284	2008	Testing of building facades	FV1
AS/NZS 4505	2012	Garage doors and other large access doors Amdt 1	B1.4
AS 4586	2013	Slip resistance classification of new pedestrian surface materials [Note: Test reports based on the 2004 edition of AS/NZS 4586 and issued prior to the 2013 edition of AS 4586 being referenced in the BCA remain valid. Test reports prepared after the BCA reference date of the 2013 edition of AS 4586 must be based on that version. For the purposes of assessing compliance, the slip-resistance classifications of V, W and X in reports based on the 2004 edition of AS/NZS 4586 may be considered to be equivalent to slip-resistance classifications of P5, P4 and P3 respectively in the 2013 edition of AS 4586.]	D2.10, D2.13, D2.14
AS/NZS 4600	2005	Cold-formed steel structures Amdt 1	B1.4
AS 4654		Waterproofing membranes for external above-ground use	F1.4
Part 1	2012	Materials	
Part 2	2012	Design and installation	
AS/NZS 4859		Materials for the thermal insulation of buildings	
Part 1	2002	General criteria and technical provisions Amdt 1	J1.2, Spec J5.2b, Spec J5.2c
AS 5146.1	2015	Reinforced autoclaved aerated concrete	B1.4

Table 1: SCHEDULE OF REFERENCED DOCUMENTS — continued

No.	Date	Title	BCA Clause(s)
Part 1		Structures	
AS 5637.1 Part 1	2015	Determination of fire hazard properties Wall and ceiling linings [Note: Test reports indicating the <i>group number</i> of wall and ceiling linings determined under versions of the BCA applicable prior to 1 May 2016 remain valid until 1 May 2019.]	Spec C1.10
AS ISO 9239 Part 1	2003	Reaction to fire tests for flooring Determination of the burning behaviour using a radiant heat source	A1.1
AIRAH-DA09	1998	Air Conditioning Load Estimation	Spec JV
AISC	1987	Guidelines for assessment of fire resistance of structural steel members	Spec A2.3
ASTM D3018-90	1994	Class A asphalt shingles surfaced with mineral granules	B1.4, F1.5
ASTM E2073-10	2010	Standard Test Method for Photopic Luminance of Photoluminescent (Phosphorescent) Markings	Spec E4.8
ASTM E72-80	1981	Standard method of conducting strength tests of panels for building construction	Spec C1.8
ASTM E695-79	1985	Standard method of measuring relative resistance of wall, floor and roof construction to impact loading	Spec C1.8
AHRI 460	2005	Remote mechanical-draft air-cooled refrigerant condensers	Spec J5.2a
AHRI 550/590	2003	Water chilling packages using the vapour compression cycle	JV3, Spec J5.2e
BS 7190	1989	Assessing thermal performance of low temperature hot water boilers using a test rig	JV3, Spec J5.2d
ABCB	2006	Protocol for Building Energy Analysis Software Version 2006.1	JV2, JV3
ABCB	2011	Protocol for Structural Software, Version 2011.1	B1.5
ABCB	2012	Standard for Construction of Buildings in Flood Hazard Areas, Version 2012.2	B1.6
CIBSE Guide A	2006	Environmental design	Spec JV

Table 1: SCHEDULE OF REFERENCED DOCUMENTS — continued

No.	Date	Title	BCA Clause(s)
Disability Standards for Accessible Public Transport	2002		H2.1
Education and Care Services National Law Act (Vic)	2010		A1.1
ISO 140 Part 6	1998 E	Acoustics — Measurement of sound insulation in buildings and of building elements Laboratory measurements of impact sound insulation of floors	Spec F5.5
ISO 540	2008	Hard coal and coke — Determination of ash fusibility	Spec C3.15
ISO 717 Part 1	1996	Acoustics — Rating of sound insulation in buildings and of building elements Airborne sound insulation	F5.2, FV5.1, FV5.2
ISO 8336	1993 E	Fibre cement flat sheets	A1.1
NASH Standard Part 1	2005	Residential and Low-Rise Steel Framing Design Criteria Amdt A Amdt B Amdt C	B1.4
Part 2	2014	Design Solutions Amdt A	B1.4, B1.5, F1.12
SA TS 101	2015	Design of post-installed and cast-in fastenings for use in concrete	B1.4

SPECIFICATION **A2.3** FIRE-RESISTANCE OF BUILDING ELEMENTS

1. Scope

This Specification sets out the procedures for determining the FRL of building elements.

2. Rating

A building element meets the requirements of this Specification if—

- (a) it is listed in, and complies with **Table 1** of this Specification; or
- (b) it is identical with a prototype that has been submitted to the *Standard Fire Test*, or an equivalent or more severe test, and the FRL achieved by the prototype without the assistance of an active fire suppression system is confirmed in a report from a *Registered Testing Authority* which—
 - (i) describes the method and conditions of the test and the form of construction of the tested prototype in full; and
 - (ii) certifies that the application of restraint to the prototype complied with the *Standard Fire Test*; or
- (c) it differs in only a minor degree from a prototype tested under (b) and the FRL attributed to the building element is confirmed in a report from a *Registered Testing Authority* which—
 - (i) certifies that the building element is capable of achieving the FRL despite the minor departures from the tested prototype; and
 - (ii) describes the materials, construction and conditions of restraint which are necessary to achieve the FRL; or
- (d) it is designed to achieve the FRL in accordance with—
 - (i) AS 2327.1, AS 4100 and AISC Guidelines for Assessment of Fire Resistance of Structural Steel Members if it is a steel or composite structure; or
 - (ii) AS 3600 if it is a concrete structure; or
 - (iii) AS 1720.4 if it is a timber element other than *fire-protected timber*; or
 - (iv) AS 3700 if it is a masonry structure; or
- (e) the FRL is determined by calculation based on the performance of a prototype in the *Standard Fire Test* and confirmed in a report in accordance with **Clause 3**; or
- (f) for *fire-protected timber*, it complies with **Specification A1.1** where applicable.

3. FRLs determined by calculation

If the FRL of a building element is determined by calculation based on a tested prototype—

- (a) the building element may vary from the prototype in relation to—
 - (i) length and height if it is a wall; and
 - (ii) height if it is a column; and

- (iii) span if it is a floor, roof or beam; and
 - (iv) conditions of support; and
 - (v) to a minor degree, cross-section and components; and
- (b) the report must demonstrate by calculation that the building element would achieve the FRL if it is subjected to the regime of the *Standard Fire Test* in relation to—
- (i) *structural adequacy* (including deflection); and
 - (ii) *integrity*; and
 - (iii) *insulation*; and
- (c) the calculations must take into account—
- (i) the temperature reached by the components of the prototype and their effects on strength and modulus of elasticity; and
 - (ii) appropriate features of the building element such as support, restraint, cross-sectional shape, length, height, span, slenderness ratio, reinforcement, ratio of surface area to mass per unit length, and fire protection; and
 - (iii) features of the prototype that influenced its performance in the *Standard Fire Test* although these features may not have been taken into account in the design for dead and live load; and
 - (iv) features of the conditions of test, the manner of support and the position of the prototype during the test, that might not be reproduced in the building element if it is exposed to fire; and
 - (v) the design load of the building element in comparison with the tested prototype.

4. Interchangeable materials

- (a) Concrete and plaster — An FRL achieved with any material of Group A, B, C, D or E as an ingredient in concrete or plaster, applies equally when any other material of the same group is used in the same proportions:

Group A: Any portland cement.

Group B: Any lime.

Group C: Any dense sand.

Group D: Any dense calcareous aggregate, including any limestone or any calcareous gravel.

Group E: Any dense siliceous aggregate, including any basalt, diorite, dolerite, granite, granodiorite or trachyte.

- (b) Perlite and vermiculite — An FRL achieved with either gypsum-perlite plaster or gypsum-vermiculite plaster applies equally for each plaster.

5. Columns covered with lightweight construction

If the *fire-resisting* covering of a steel column is *lightweight construction*, the construction must comply with **C1.8** and **C3.17**.

6. Non-loadbearing elements

If a non-*loadbearing* element is able to be used for a purpose where the *Deemed-to-Satisfy Provisions* prescribe an FRL for *structural adequacy*, *integrity* and *insulation*, that non-*loadbearing* element need not comply with the *structural adequacy* criteria.

Table 1 FRLs DEEMED TO BE ACHIEVED BY CERTAIN BUILDING ELEMENT

Building element	Minimum thickness (mm) of principal material for FRL's					Annexure reference
WALL						
	60/60/60	90/90/90	120/120/120	180/180/180	240/240/240	Clause
Masonry						
Ashlar	–	–	–	–	300	1, 2, 5, 6
Calcium silicate		see 2(d)(iv) of this Specification				
Concrete		see 2(d)(iv) of this Specification				
Fired clay (inc terracotta)		see 2(d)(iv) of this Specification				
Concrete						
No-fines	–	–	–	150	170	1, 5, 6
Prestressed		see 2(d)(ii) of this Specification				
Reinforced		see 2(d)(ii) of this Specification				
Plain	–	–	–	150	170	1, 5, 6
Solid gypsum blocks	75	90	100	110	125	1, 5, 6
Gypsum — perlite or Gypsum vermiculite-plaster on metal lath and channel (non-loadbearing walls only)	50	50	65	–	–	1, 5, 7
CONCRETE COLUMN						
	60/60/60	90/90/90	120/120/120	180/180/180	240/240/240	Clause
Prestressed		see 2(d)(ii) of this Specification				
Reinforced		see 2(d)(ii) of this Specification				
HOT-ROLLED STEEL COLUMN						
	60/60/60	90/90/90	120/120/120	180/180/180	240/240/240	Clause
(inc a fabricated column) exposed on no more than 3 sides:						8
Fire protection of Concrete — Cast in-situ—						
<i>loadbearing</i>	25	30	40	55	75	9, 11, 12
non- <i>loadbearing</i> -						
unplastered	25	30	40	50	65	9, 11, 12
plastered 13 mm—	25	25	30	40	50	1, 6, 9, 11, 12
Gypsum — Cast in-situ	–	–	–	–	50	9, 11, 12
Gypsum — perlite or Gypsum-vermiculite plaster						

Table 1 FRLs DEEMED TO BE ACHIEVED BY CERTAIN BUILDING ELEMENT — continued

Building element	Minimum thickness (mm) of principal material for FRL's					Annexure reference
sprayed to contour	20	25	35	50	55	1, 11
sprayed on metal lath	20	20	25	35	45	1, 7
HOT-ROLLED STEEL COLUMN						
	60/60/60	90/90/90	120/120/120	180/180/180	240/240/240	Clause
(inc. a fabricated column) exposed on no more than 3 sides and with column spaces filled:						8, 9
Fire protection of—						
Solid calcium-silicate masonry	50	50	50	50	65	1, 3, 11, 12
Solid clay masonry	50	50	50	65	90	1, 3, 11, 12
Solid concrete masonry	50	50	50	65	90	1, 3, 11, 12
Solid gypsum blocks	50	50	50	50	65	1, 3, 11, 12
Hollow terracotta blocks						
plastered 13 mm	50	50	50	65	90	1, 3, 6, 10, 11, 12
HOT-ROLLED STEEL COLUMN						
	60/60/60	90/90/90	120/120/120	180/180/180	240/240/240	Clause
(inc a fabricated column) exposed on no more than 3 sides and with column spaces unfilled:						8
Fire protection of—						
Solid calcium- silicate masonry	50	50	50	–	–	1, 3, 11, 12
Solid clay masonry	50	50	65	–	–	1, 3, 11, 12
Solid concrete masonry	50	50	65	–	–	1, 3, 11, 12
Solid gypsum blocks	50	50	50	–	–	1, 3, 11, 12
Hollow terracotta blocks—						
plastered 13 mm	50	50	65	–	–	1, 3, 6, 10, 11, 12
HOT-ROLLED STEEL COLUMN						
	60/-/-	90/-/-	120/-/-	180/-/-	240/-/-	Clause
(inc. a fabricated column) exposed on 4 sides:						8
Fire protection of—						
Concrete — Cast in-situ—						
<i>loadbearing</i>	25	40	45	65	90	9, 11, 12
<i>non-loadbearing-</i>						
unplastered	25	30	40	50	65	9, 11, 12
plastered 13 mm	25	25	30	40	50	1, 6, 9, 11, 12
Gypsum — Cast in-situ	–	–	–	–	50	9, 11, 12

Table 1 FRLs DEEMED TO BE ACHIEVED BY CERTAIN BUILDING ELEMENT — continued

Building element	Minimum thickness (mm) of principal material for FRL's					Annexure reference		
Gypsum-perlite or Gypsum-vermiculite plaster	sprayed to contour	25	30	40	55	65	1, 11	
	sprayed on metal lath	20	20	30	40	50	1, 7	
HOT-ROLLED STEEL COLUMN								
	60/-/-	90/-/-	120/-/-	180/-/-	240/-/-	Clause		
(inc. a fabricated column) exposed on 4 sides and with column spaces filled:							8, 9	
Fire protection of—								
Solid calcium- silicate masonry	50	50	50	65	75	1, 3, 11, 12,		
Solid clay masonry	50	50	50	75	100	1, 3, 11, 12		
Solid concrete masonry	50	50	50	75	100	1, 3, 11, 12		
Solid gypsum blocks	50	50	50	65	75	1, 3, 11, 12		
Hollow terracotta blocks—								
plastered 13 mm	50	50	50	75	100	1, 3, 6, 10, 11, 12		
HOT-ROLLED STEEL COLUMN								
	60/-/-	90/-/-	120/-/-	180/-/-	240/-/-	Clause		
(inc. a fabricated column) exposed on 4 sides and with column spaces unfilled:							8	
Fire protection of—								
Solid calcium-silicate masonry	50	50	50	–	–	1, 3, 11, 12		
Solid clay masonry	50	50	65	–	–	1, 3, 11, 12		
Solid concrete masonry	50	50	65	–	–	1, 3, 11, 12		
Solid gypsum blocks	50	50	50	–	–	1, 3, 11, 12		
Hollow terracotta blocks—								
plastered 13 mm	50	50	65	–	–	1, 3, 6, 10, 11, 12		
BEAM								
	60/-/-	90/-/-	120/-/-	180/-/-	240/-/-	Clause		
Concrete—								
Prestressed	see 2(d)(ii) of this Specification							
Reinforced	see 2(d)(ii) of this Specification							
Hot-rolled Steel (inc. an open-web joist girder truss etc) exposed on no more than 3 sides:							8	
Fire protection of—								
Concrete — Cast in-situ	25	30	40	50	65	11, 12		

Table 1 FRLs DEEMED TO BE ACHIEVED BY CERTAIN BUILDING ELEMENT — continued

Building element	Minimum thickness (mm) of principal material for FRL's					Annexure reference
Gypsum-perlite or Gypsum-vermiculite plaster						
sprayed to contour	20	25	35	50	55	1, 11
sprayed on metal lath	20	20	25	35	45	1, 7
Hot-rolled Steel (inc. an open-web joist girder truss etc) exposed on 4 sides:						8
Fire protection of—						
Concrete — Cast in-situ	25	40	45	65	90	11, 12
Gypsum-perlite or Gypsum-vermiculite plaster—						
sprayed to contour	25	30	40	55	65	1, 11
sprayed on metal lath	20	20	30	40	50	1, 7
FLOOR, ROOF OR CEILING						
	60/60/60	90/90/90	120/120/120	180/180/180	240/240/240	Clause
Concrete—						
Prestressed		see 2(d)(ii) of this Specification				
Reinforced		see 2(d)(ii) of this Specification				

ANNEXURE TO TABLE 1

1. MORTAR, PLASTER AND PLASTER REINFORCEMENT

1.1 Mortar for masonry

Masonry units of ashlar, calcium silicate, concrete or fired clay (including terracotta blocks) must be laid in cement mortar or composition mortar complying with the relevant provisions of AS 3700.

1.2 Gypsum blocks

Gypsum blocks must be laid in gypsum-sand mortar or lime mortar.

1.3 Gypsum-sand mortar and plaster

Gypsum-sand mortar and gypsum-sand plaster must consist of either—

- (a) not more than 3 parts by volume of sand to 1 part by volume of gypsum; or
- (b) if lime putty is added, not more than 2.5 parts by volume of sand to 1 part by volume of gypsum and not more than 5% of lime putty by volume of the mixed ingredients.

1.4 Gypsum-perlite and gypsum-vermiculite plaster

Gypsum-perlite or gypsum-vermiculite plaster must be applied—

- (a) in either one or 2 coats each in the proportions of 1 m³ of perlite or vermiculite to 640 kg of gypsum if the *required* thickness of the plaster is not more than 25 mm; and
- (b) in 2 coats if the *required* thickness is more than 25 mm, the first in the proportions of 1 m³ of perlite or vermiculite to 800 kg of gypsum and the second in the proportions of 1 m³ of perlite or vermiculite to 530 kg of gypsum.

1.5 Plaster of cement and sand or cement, lime and sand

Plaster prescribed in [Table 1](#) must consist of—

- (a) cement and sand or cement, lime and sand; and
- (b) may be finished with gypsum, gypsum-sand, gypsum-perlite or gypsum-vermiculite plaster or with lime putty.

1.6 Plaster reinforcement

If plaster used as fire protection on walls is more than 19 mm thick—

- (a) it must be reinforced with expanded metal lath that—
 - (i) has a mass per unit area of not less than 1.84 kg/m²; and
 - (ii) has not fewer than 98 meshes per metre; and
 - (iii) is protected against corrosion by galvanising or other suitable method; or
- (b) it must be reinforced with 13 mm x 13 mm x 0.7 mm galvanised steel wire mesh, and with the reinforcement must be securely fixed at a distance from the face of the wall of not less than 1/3 of the total thickness of the plaster.

2. ASHLAR STONE MASONRY

Ashlar masonry must not be used in a part of the building containing more than 2 *storeys*, and must not be of—

- (a) aplite, granite, granodiorite, quartz dacite, quartz diorite, quartz porphyrite or quartz porphyry; or
- (b) conglomerate, quartzite or sandstone; or
- (c) chert or flint; or
- (d) limestone or marble.

3. DIMENSIONS OF MASONRY

The thicknesses of masonry of calcium-silicate, concrete and fired clay are calculated as follows:

3.1 Solid units

For masonry in which the amount of perforation or coring of the units does not exceed 25% by volume (based on the overall rectangular shape of the unit) the thickness of the wall must be calculated from the manufacturing dimensions of the units and the specified thickness of the joints between them as appropriate.

3.2 Hollow units

For masonry in which the amount of perforation or coring of the units exceeds 25% by volume (based on the overall rectangular shape of the unit) the thickness of the wall must be calculated from the equivalent thicknesses of the units and the specified thickness of the joints between them as appropriate.

3.3 Equivalent thickness

The equivalent thickness of a masonry unit is calculated by dividing the net volume by the area of one vertical face.

4. * * * * *

This Clause has deliberately been left blank.

5. HEIGHT-TO-THICKNESS RATIO OF CERTAIN WALLS

The ratio of height between lateral supports to overall thickness of a wall of ashlar, no-fines concrete, unreinforced concrete, solid gypsum blocks, gypsum-perlite or gypsum-vermiculite plaster on metal lath and channel, must not exceed—

- (a) 20 for a *loadbearing* wall; or
- (b) 27 for a non-*loadbearing* wall.

6. INCREASE IN THICKNESS BY PLASTERING

6.1 Walls

If a wall of ashlar, solid gypsum blocks or concrete is plastered on both sides to an equal thickness, the thickness of the wall for the purposes of [Table 1](#) (but not for the purposes of [Annexure Clause 5](#)) may be increased by the thickness of the plaster on one side.

6.2 Columns

Where [Table 1](#) indicates that column-protection is to be plastered, the tabulated thicknesses are those of the principal material. They do not include the thickness of plaster which must be additional to the listed thickness of the material to which it is applied.

7. GYPSUM-PERLITE OR GYPSUM-VERMICULITE PLASTER ON METAL LATH

7.1 Walls

In walls fabricated of gypsum-perlite or gypsum-vermiculite plaster on metal lath and channel—

- (a) the lath must be securely wired to each side of 19 mm x 0.44 kg/m steel channels (used as studs) spaced at not more than 400 mm centres; and
- (b) the gypsum-perlite or gypsum-vermiculite plaster must be applied symmetrically to each exposed side of the lath.

7.2 Columns

For the fire protection of steel columns with gypsum-perlite or gypsum-vermiculite on metal lath—

- (a) the lath must be fixed at not more than 600 mm centres vertically to steel furring channels, and—
 - (i) if the plaster is to be 35 mm thick or more — at least 12 mm clear of the column; or
 - (ii) if the plaster is to be less than 35 mm thick — at least 6 mm clear of the column; or
- (b) the plaster may be applied to self-furring lath with furring dimples to hold it not less than 10 mm clear of the column, and

the thickness of the plaster must be measured from the back of the lath.

7.3 Beams

For the fire protection of steel beams with gypsum-perlite or gypsum-vermiculite on metal lath—

- (a) the lath must be fixed at not more than 600 mm centres to steel furring channels and at least 20 mm clear of the steel; and
- (b) the thickness of the plaster must be measured from the back of the lath.

8. EXPOSURE OF COLUMNS AND BEAMS

8.1 Columns

A column incorporated in or in contact on one or more sides with a wall of solid masonry or concrete at least 100 mm thick may be considered to be exposed to fire on no more than 3 sides.

8.2 Beams

A beam, open-web joist, girder or truss in direct and continuous contact with a concrete slab or a hollow block floor or roof may be considered to be exposed to fire on no more than 3 sides.

9. FILLING OF COLUMN SPACES

- (a) The spaces between the fire-protective material and the steel (and any re-entrant parts of the column itself) must be filled solid with a fire-protective material like concrete, gypsum or grout.
- (b) The insides of hollow sections, including pipes, need not be filled.

10. HOLLOW TERRACOTTA BLOCKS

The proportion of cored holes or perforations in a hollow terracotta block (based on the overall rectangular volume of the unit) must not exceed the following:

- | | |
|---|-----|
| (a) For blocks up to 75 mm thick | 35% |
| (b) For blocks more than 75 mm but not more than 100 mm thick | 40% |
| (c) For blocks more than 100 mm | 50% |

11. REINFORCEMENT FOR COLUMN AND BEAM PROTECTION

11.1 Masonry

Masonry of calcium-silicate, fired clay and concrete for the protection of steel columns must have steel-wire or mesh reinforcement in every second course and lapped at the corners.

11.2 Gypsum blocks and hollow terracotta blocks

Gypsum blocks and hollow terracotta blocks for the protection of steel columns must have steel-wire or mesh reinforcement in every course and lapped at corners.

11.3 Structural concrete and poured gypsum

If a steel column or a steel beam is to be protected with structural concrete or poured gypsum—

- (a) the concrete or gypsum must be reinforced with steel-wire mesh or steel-wire binding placed about 20 mm from its outer surface, and—
 - (i) for concrete or gypsum less than 50 mm thick, the steel wire must be—
 - (A) at least 3.15 mm in diameter; and

- (B) spaced at not more than 100 mm vertically; or
- (ii) for concrete or gypsum not less than 50 mm thick, the steel wire must be either—
 - (A) of a diameter and spacing in accordance with (i); or
 - (B) at least 5 mm in diameter and spaced at not more than 150 mm vertically.

11.4 Gypsum-perlite or gypsum-vermiculite plaster sprayed to contour

- (a) If a steel column or steel beam is protected with either gypsum-perlite or gypsum-vermiculite plaster sprayed to contour and the construction falls within the limits of **Table 11.4**, the plaster must be reinforced with—
 - (i) expanded metal lath complying with **Clause 1.6 of this Annexure**; or
 - (ii) galvanised steel wire mesh complying with **Clause 1.6 of this Annexure**.
- (b) The reinforcement must be placed at a distance from the face of the plaster of at least 1/3 of the thickness of the plaster and must be securely fixed to the column or beam at intervals of not more than the relevant listing in **Table 11.4**.
- (c) For the purposes of **Table 11.4**—
 - (i) “vertical” includes a surface at not more than 10° to the vertical; and
 - (ii) “horizontal” includes a surface at not more than 10° to the horizontal; and
 - (iii) “underside” means the underside of any horizontal or non-vertical surface.

Table 11.4 REINFORCEMENT OF GYPSUM-PERLITE OR GYPSUM-VERMICULITE PLASTER SPRAYED TO CONTOUR

Surface to be protected	Reinforcement required if smaller dimension of surface exceeds (mm)	Max spacing of fixings of the mesh to surface (mm)
Members with H or I cross-section:		
Vertical—	450	450
Non-vertical—	300	300
Underside—	300	300
Upper side of a horizontal surface—	Not required	
Members with other shapes:		
Vertical—	Any size	450
Non-vertical—	Any size	300
Underside—	Any size	300
Upper side of a horizontal surface—	Not required	

12. THICKNESS OF COLUMN AND BEAM PROTECTION

12.1 Measurement of thickness

The thickness of the fire protection to steel columns and steel beams (other than fire protection of gypsum-perlite or gypsum-vermiculite plaster sprayed on metal lath or sprayed to contour) is to be measured from the face or edge of the steel, from the face of a splice plate or from the outer part of a rivet or bolt, whichever is the closest to the outside of the fire-protective construction, except that—

- (a) if the thickness of the fire protection is 40 mm or more, rivet heads may be disregarded; and
- (b) if the thickness of the fire protection is 50 mm or more—
 - (i) any part of a bolt (other than a high-tensile bolt) may be disregarded; and
 - (ii) a column splice plate within 900 mm of the floor may encroach upon the fire protection by up to a 1/4 of the thickness of the fire protection; and
- (c) the flange of a column or beam may encroach by up to 12 mm upon the thickness of the fire protection at right angles to the web if—
 - (i) the column or beam is intended to have an FRL of 240/240/240 or 240/-/-; and
 - (ii) the flange projects 65 mm or more from the web; and
 - (iii) the thickness of the edge of the flange (inclusive of any splice plate) is not more than 40 mm.

SPECIFICATION **A2.4** FIRE HAZARD PROPERTIES

1. Scope

This Specification sets out the procedures for determining the *fire hazard properties* of assemblies tested to AS/NZS 1530.3.

2. Assemblies

2.1 General requirement

The *fire hazard properties* of assemblies and their ability to screen their core materials as *required* under **Specification C1.10** must be determined by testing in accordance with this Clause.

2.2 Form of test

Tests must be carried out in accordance with—

- (a) for the determination of the *Spread-of-Flame Index* and *Smoke-Developed Index* — AS/NZS 1530.3; and
- (b) for the determination of the ability to prevent ignition and to screen its core material from free air — AS 1530.4.

2.3 Test specimens

Test specimens must incorporate—

- (a) all types of joints; and
- (b) all types of perforations, recesses or the like for pipes, light switches or other fittings, which are proposed to be used for the member or assembly of members in the building.

2.4 Concession

Clause 2.3 does not apply to joints, perforations, recesses or the like that are larger than those in the proposed application and have already been tested in the particular form of construction concerned and found to comply with the conditions of the test.

2.5 Smaller specimen permitted

A testing laboratory may carry out the test specified in **Clause 2.2(b)** at pilot scale if a specimen (which must be not less than 900 mm x 900 mm) will adequately represent the proposed construction in the building, but the results of that test do not apply to construction larger than limits defined by the laboratory conducting the pilot examination.

SECTION **B**

STRUCTURE

B1 Structural Provisions

SECTION B CONTENTS

SECTION B STRUCTURE

B1 STRUCTURAL PROVISIONS

Performance Requirements BP1.1 - BP1.4

Verification Methods BV1-BV2

B1.0 Deemed-to-Satisfy Provisions

B1.1 Resistance to actions

B1.2 Determination of individual actions

B1.3 * * * * *

B1.4 Determination of structural resistance of materials and forms of construction

B1.5 Structural software

B1.6 Construction of buildings in flood hazard areas.

Specifications

Specification B1.2 Design of Buildings in Cyclonic Areas

PART B1 STRUCTURAL PROVISIONS

PERFORMANCE REQUIREMENTS

BP1.1

- (a) A building or structure, during construction and use, with appropriate degrees of reliability, must—
- (i) perform adequately under all reasonably expected design actions; and
 - (ii) withstand extreme or frequently repeated design actions; and
 - (iii) be designed to sustain local damage, with the structural system as a whole remaining stable and not being damaged to an extent disproportionate to the original local damage; and
 - (iv) avoid causing damage to *other properties*,
- by resisting the actions to which it may reasonably expect to be subjected.
- (b) The actions to be considered to satisfy (a) include but are not limited to—
- (i) permanent actions (dead loads); and
 - (ii) imposed actions (live loads arising from occupancy and use); and
 - (iii) wind action; and
 - (iv) earthquake action; and
 - (v) snow action; and
 - (vi) liquid pressure action; and
 - (vii) ground water action; and
 - (viii) rainwater action (including ponding action); and
 - (ix) earth pressure action; and
 - (x) differential movement; and
 - (xi) time dependent effects (including creep and shrinkage); and
 - (xii) thermal effects; and
 - (xiii) ground movement caused by—
 - (A) swelling, shrinkage or freezing of the subsoil; and
 - (B) landslide or subsidence; and
 - (C) siteworks associated with the building or structure; and
 - (xiv) *construction activity actions*; and
 - (xv) termite actions.

BP1.2

The structural resistance of materials and forms of construction must be determined using five percentile characteristic material properties with appropriate allowance for—

- (a) known construction activities; and
- (b) type of material; and
- (c) characteristics of the site; and
- (d) the degree of accuracy inherent in the methods used to assess the structural behaviour; and
- (e) action effects arising from the differential settlement of foundations, and from restrained dimensional changes due to temperature, moisture, shrinkage, creep and similar effects.

BP1.3

Glass installations that are at risk of being subjected to human impact must have glazing that—

- (a) if broken on impact, will break in a way that is not likely to cause injury to people; and
- (b) resists a reasonably foreseeable human impact without breaking; and
- (c) is protected or marked in a way that will reduce the likelihood of human impact.

BP1.4

Qld BP1.4

SA BP1.4

- (a) A building in a *flood hazard area*, must be designed and constructed, to the degree necessary, to resist flotation, collapse or significant permanent movement resulting from the action of hydrostatic, hydrodynamic, erosion and scour, wind and other actions during the *defined flood event*.
- (b) The actions and requirements to be considered to satisfy (a) include but are not limited to—
 - (i) flood actions; and
 - (ii) elevation requirements; and
 - (iii) foundation and footing requirements; and
 - (iv) requirements for enclosures below the *flood hazard level*; and
 - (v) requirements for structural connections; and
 - (vi) material requirements; and
 - (vii) requirements for utilities; and
 - (viii) requirements for occupant egress.

Application:

BP1.4 only applies to—

- (a) a Class 2 or 3 building or Class 4 part of a building; and
- (b) a Class 9a *health-care building*; and

(c) a Class 9c building.

VERIFICATION METHODS

BV1 Structural reliability

Compliance with **BP1.1** and **BP1.2** is verified for the design of structural components and connections when—

- (a) the calculated annual structural reliability index (β), for each action, is not less than that listed in **Table BV1.1**; and

Table BV1.1 – ANNUAL STRUCTURAL RELIABILITY INDICES (β) FOR STRUCTURAL COMPONENTS AND CONNECTIONS

Importance Level (see Table B1.2a)	Permanent and imposed actions	Wind, earthquake and snow actions
1	3.8	3.2
2		3.4
3		3.6
4		3.8

Note: The structural reliability indices shown in this table are for primary structural components and connections whose failure could result in collapse of the building, structure or *other property*. For other structural components and connections, the target structural reliability indices can be reduced by 0.3.

- (b) the annual structural reliability index (β) is calculated in accordance with the following formula:

$$\beta = \ln\left[\left(\frac{R_m}{Q_m}\right) \sqrt{\frac{C_Q}{C_R}}\right] / \sqrt{\ln(C_R \cdot C_Q)}$$

where—

$$\left(\frac{R_m}{Q_m}\right) = \left(\frac{\gamma}{\phi}\right) \left(\frac{R_m}{R_n}\right) / \left(\frac{Q_m}{Q_n}\right)$$

$$C_R = 1 + V_R^2$$

$$C_Q = 1 + V_Q^2$$

- C_Q = correction factor for action; and
- C_R = correction factor for resistance; and
- Q_m = mean action; and
- Q_n = nominal design action; and
- R_m = mean resistance; and
- R_n = nominal design resistance; and
- V_Q = coefficient of variation with respect to action; and
- V_R = coefficient of variation with respect to resistance; and
- Φ = capacity factor; and
- γ = load factor; and

- (c) the action models for calculation of the structural reliability index are determined in accordance with **Table BV1.2**; and
- (d) the resistance model for the structural component or connection is established after taking into account variability due to material properties, fabrication and construction processes, and structural modelling.

Table BV1.2 – ACTION MODELS

Importance Level (see Table B1.2a)	Permanent action		Imposed action		Wind action				Snow action		Earthquake action	
					Non-cyclonic		Cyclonic		Q _m	V ₀	Q _m	V ₀
	Q _m	V ₀	Q _m	V ₀	Q _m	V ₀	Q _m	V ₀				
1	1.00	0.10	0.50	0.43	0.41	0.52	0.21	0.79	0.32	0.57	0.072	1.97
2	1.00	0.10	0.50	0.43	0.34	0.52	0.18	0.79	0.30	0.57	0.054	1.97
3	1.00	0.10	0.50	0.43	0.32	0.52	0.16	0.79	0.28	0.57	0.042	1.97
4	1.00	0.10	0.50	0.43	0.30	0.52	0.14	0.79	0.27	0.57	0.036	1.97

BV2 Structural robustness

Compliance with **BP1.1(a)(iii)** is verified for structural robustness by—

- (a) assessment of the structure such that upon the notional removal in isolation of—
 - (i) any supporting column; or
 - (ii) any beam supporting one or more columns; or
 - (iii) any segment of a load bearing wall of length equal to the height of the wall,
the building remains stable and the resulting collapse does not extend further than the immediately adjacent *storeys*; and
- (b) demonstrating that if a supporting structural component is relied upon to carry more than 25% of the total structure a systematic risk assessment of the building is undertaken and critical high risk components are identified and designed to cope with the identified hazard or protective measures chosen to minimise the risk.

PART B1 STRUCTURAL PROVISIONS

Deemed-to-Satisfy Provisions

B1.0 Deemed-to-Satisfy Provisions

- (a) Where a *Deemed-to-Satisfy Solution* is proposed, *Performance Requirements BP1.1* to *BP1.4* are satisfied by complying with *B1.1*, *B1.2*, *B1.4*, *B1.5* and *B1.6*.
- (b) Where a *Performance Solution* is proposed, the relevant *Performance Requirements* must be determined in accordance with *A0.7*.

B1.1 Resistance to actions

The resistance of a building or structure must be greater than the most critical action effect resulting from different combinations of actions, where—

- (a) the most critical action effect on a building or structure is determined in accordance with *B1.2* and the general design procedures contained in AS/NZS 1170.0; and
- (b) the resistance of a building or structure is determined in accordance with *B1.4*.

B1.2 Determination of individual actions

The magnitude of individual actions must be determined in accordance with the following:

- (a) Permanent actions:
 - (i) the design or known dimensions of the building or structure; and
 - (ii) the unit weight of the construction; and
 - (iii) AS/NZS 1170.1.
- (b) Imposed actions:
 - (i) the known loads that will be imposed during the occupation or use of the building or structure; and
 - (ii) *construction activity actions*; and
 - (iii) AS/NZS 1170.1.
- (c) Wind, snow and ice and earthquake actions:
 - (i) the applicable annual probability of design event for safety, determined by—
 - (A) assigning the building or structure an Importance Level in accordance with *Table B1.2a*; and
 - (B) determining the corresponding annual probability of exceedance in accordance with *Table B1.2b*; and
 - (ii) AS/NZS 1170.2; and
 - (iii) AS/NZS 1170.3 and AS 1170.4 as appropriate; and
 - (iv) in cyclonic areas, metal roof cladding, its connections and immediate supporting members must comply with *Specification B1.2*; and

Deemed-to-Satisfy Provisions

- (v) for the purposes of (iv), cyclonic areas are those determined as being located in wind regions C and D in accordance with AS/NZS 1170.2.
- (d) Actions not covered in (a), (b) and (c) above:
 - (i) the nature of the action; and
 - (ii) the nature of the building or structure; and
 - (iii) the Importance Level of the building or structure determined in accordance with **Table B1.2a**; and
 - (iv) AS/NZS 1170.1.
- (e) For the purposes of (d) the actions include but are not limited to—
 - (i) liquid pressure action; and
 - (ii) ground water action; and
 - (iii) rainwater action (including ponding action); and
 - (iv) earth pressure action; and
 - (v) differential movement; and
 - (vi) time dependent effects (including creep and shrinkage); and
 - (vii) thermal effects; and
 - (viii) ground movement caused by—
 - (A) swelling, shrinkage or freezing of the subsoil; and
 - (B) landslip or subsidence; and
 - (C) *siteworks* associated with the building or structure; and
 - (ix) *construction activity actions*.

Table B1.2a IMPORTANCE LEVELS OF BUILDINGS AND STRUCTURES

Importance Level	Building Types
1	Buildings or structures presenting a low degree of hazard to life and <i>other property</i> in the case of failure.
2	Buildings or structures not included in Importance Levels 1, 3 and 4.
3	Buildings or structures that are designed to contain a large number of people.
4	Buildings or structures that are essential to post-disaster recovery or associated with hazardous facilities.

Table B1.2b DESIGN EVENTS FOR SAFETY

Importance Level	Annual probability of exceedance			
	Wind		Snow	Earthquake
	Non-cyclonic	Cyclonic		
1	1:100	1:200	1:100	1:250
2	1:500	1:500	1:150	1:500

Deemed-to-Satisfy Provisions

Table B1.2b DESIGN EVENTS FOR SAFETY — continued

Importance Level	Annual probability of exceedance			
	Wind		Snow	Earthquake
	Non-cyclonic	Cyclonic		
3	1:1000	1:1000	1:200	1:1000
4	1:2000	1:2000	1:250	1:1500

B1.3 * * * * *

This clause has deliberately been left blank

B1.4 Determination of structural resistance of materials and forms of construction

The structural resistance of materials and forms of construction must be determined in accordance with the following, as appropriate:

- (a) Masonry (including masonry-veneer, unreinforced masonry and reinforced masonry): AS 3700.
- (b) Concrete:
 - (i) Concrete construction (including reinforced and prestressed concrete): AS 3600.
 - (ii) Autoclaved aerated concrete: AS 5146.1.
 - (iii) Post-installed and cast-in fastenings: SA TS 101.
- (c) Steel construction—
 - (i) Steel structures: AS 4100.
 - (ii) Cold-formed steel structures: AS/NZS 4600.
 - (iii) Residential and low-rise steel framing: NASH Standard – Residential and Low-Rise Steel Framing Part 1 or Part 2.
- (d) Composite steel and concrete: AS 2327.1.
- (e) Aluminium construction: AS/NZS 1664.1 or AS/NZS 1664.2.
- (f) Timber construction:
 - (i) Design of timber structures: AS 1720.1.
 - (ii) * * * * *
 - (iii) Timber structures: AS 1684 Part 2, Part 3 or Part 4.
 - (iv) Nailplated timber roof trusses: AS 1720.5.

Qld B1.4(f)(v)

- (g) Piling: AS 2159.
- (h) Glazed assemblies:
 - (i) The following glazed assemblies in an *external wall* must comply with AS 2047:

Deemed-to-Satisfy Provisions

- (A) Windows excluding those listed in (ii).
- (B) Sliding and swinging glazed doors with a frame, including french and bi-fold doors with a frame.
- (C) Adjustable louvres.
- (D) Shopfronts.
- (E) Window walls with one piece framing.
- (ii) All glazed assemblies not covered by (i) and the following glazed assemblies must comply with AS 1288:
 - (A) All glazed assemblies not in an *external wall*.
 - (B) Revolving doors.
 - (C) Fixed louvres.
 - (D) Skylights, roof lights and windows in other than the vertical plane.
 - (E) Sliding and swinging doors without a frame.
 - (F) Windows constructed on site and architectural one-off windows, which are not design tested in accordance with AS 2047.
 - (G) Second-hand windows, re-used windows and recycled windows.
 - (H) Heritage windows.
 - (I) Glazing used in balustrades and sloping overhead glazing.

NT B1.4(i)

- (i) Termite Risk Management: Where a *primary building element* is subject to attack by subterranean termites: AS 3660.1, and—
 - (i) for the purposes of this provision, a *primary building element* consisting entirely of, or a combination of, any of the following materials is considered not subject to termite attack:
 - (A) Steel, aluminium or other metals.
 - (B) Concrete.
 - (C) Masonry.
 - (D) Fibre-reinforced cement.
 - (E) Timber — naturally termite resistant in accordance with Appendix C of AS 3660.1.
 - (F) Timber — preservative treated in accordance with Appendix D of AS 3660.1; and
 - (ii) a durable notice must be permanently fixed to the building in a prominent location, such as a meter box or the like, indicating—
 - (A) the termite management system used; and
 - (B) the date of installation of the system; and
 - (C) where a chemical is used, its life expectancy as listed on the *appropriate authority's* pesticides register label; and

Deemed-to-Satisfy Provisions

- (D) the installer's or manufacturer's recommendations for the scope and frequency of future inspections for termite activity.
- (j) Roof construction (except in cyclone areas):
 - (i) Plastic sheeting: AS/NZS 1562.3, AS/NZS 4256 Parts 1, 2, 3 and 5.
 - (ii) Roofing tiles: AS 2049, AS 2050.
 - (iii) Cellulose cement corrugated sheets: AS/NZS 2908.1 with safety mesh installed in accordance with AS/NZS 1562.3 clause 2.4.3.2 except for sub clause (g) for plastic sheeting.
 - (iv) Metal roofing: AS 1562.1.
 - (v) Asphalt shingles: ASTM D3018-90, Class A.
- (k) Particleboard structural flooring: AS 1860.2.
- (l) Garage doors and other large access doors in openings not more than 3 m in height in *external walls* of buildings determined as being located in wind region C or D in accordance with AS/NZS 1170.2: AS/NZS 4505.
- (m) Lift *shafts* which are not *required* to have an FRL, must—
 - (i) except as required by (ii), be completely enclosed with non-perforated material between the bottom of the pit and the ceiling of the lift *shaft*, other than—
 - (A) at landing doors, emergency doors and pit access doors; and
 - (B) *low-rise, low-speed constant pressure lifts*; and
 - (C) *small-sized, low-rise automatic lifts*; and
 - (ii) in *atrium* and observation areas, be protected with non-perforated material not less than 2.5 m in height—
 - (A) above any places on which a person can stand, which are within 800 mm horizontal reach of any vertical moving lift component including ropes and counterweights; and
 - (B) at the lowest level of the *atrium* area that the lift serves, on all sides except the door opening, for not less than 2.5 m in height, by enclosure with non-perforated material; and
 - (iii) be of non-brittle material; and
 - (iv) where glazing is used—
 - (A) comply with **Table B1.4**; or
 - (B) not fail the deflection criteria *required* by **Clause 6(c)(iii) of Specification C1.8**.

Table B1.4 MATERIAL AND THICKNESS OF GLAZING

Application	Minimum thickness	
	Lift <i>shaft</i> vision panels more than 65 000 mm ² , door panels, and lift <i>shafts</i>	Lift <i>shaft</i> vision panels less than or equal to 65 000 mm ²
Laminated glass	10 mm (0.76 mm interlayer)	6 mm (0.76 mm interlayer)

Deemed-to-Satisfy Provisions

Table B1.4 MATERIAL AND THICKNESS OF GLAZING — continued

Application	Minimum thickness	
	Lift <i>shaft</i> vision panels more than 65 000 mm ² , door panels, and lift <i>shafts</i>	Lift <i>shaft</i> vision panels less than or equal to 65 000 mm ²
Toughened/Laminated	10 mm (0.76 mm interlayer)	6 mm (0.76 mm interlayer)
Annealed, with security polyester film coating	10 mm	6 mm
Safety wire	Not applicable	Subject to fire test
Polycarbonate	13 mm	6 mm

B1.5 Structural software

- (a) Structural software used in computer aided design of a building or structure, that uses design criteria based on the *Deemed-to-Satisfy Provisions* of the BCA, including its referenced documents, for the design of steel or timber trussed roof and floor systems and framed building systems, must comply with the ABCB Protocol for Structural Software.
- (b) Structural software referred to in (a) can only be used for buildings within the following geometrical limits:
 - (i) The distance from ground level to the underside of eaves must not exceed 6 m.
 - (ii) The distance from ground level to the highest point of the roof, neglecting chimneys must not exceed 8.5 m.
 - (iii) The building width including roofed verandahs, excluding eaves, must not exceed 16 m.
 - (iv) The building length must not exceed five times the building width.
 - (v) The roof pitch must not exceed 35 degrees.
- (c) The requirements of (a) do not apply to design software for individual frame members such as electronic tables similar to those provided in—
 - (i) AS 1684; or
 - (ii) NASH Standard Residential and Low-Rise Steel Framing Part 2.

B1.6 Construction of buildings in flood hazard areas

Qld B1.6

Vic B1.6

SA B1.6

A Class 2 or 3 building, Class 9a *health-care building*, Class 9c building or Class 4 part of a building, in a *flood hazard area* must comply with the ABCB Standard for Construction of Buildings in Flood Hazard Areas.

SPECIFICATION B1.2 DESIGN OF BUILDINGS IN CYCLONIC AREAS

Deemed-to-Satisfy Provisions

1. Scope

This specification contains requirements for the design of buildings in cyclonic areas in addition to the requirements of AS/NZS 1170.2.

For the purposes of **Specification B1.2**, cyclonic areas are those determined as being located in wind regions C and D in accordance with AS/NZS 1170.2.

2. Roof Cladding

Test for strength - Metal roof cladding, its connections and immediate supporting members must be capable of remaining in position notwithstanding any permanent distortion, fracture or damage that might occur in the sheet or fastenings under the pressure sequences A to G defined in **Table 1**.

TABLE 1 LOW-HIGH-LOW PRESSURE SEQUENCE

Sequence	Number of cycles	Load
A	4500	0 to 0.45 Pt
B	600	0 to 0.6 Pt
C	80	0 to 0.8 Pt
D	1	0 to 1.0 Pt
E	80	0 to 0.8 Pt
F	600	0 to 0.6 Pt
G	4500	0 to 0.45 Pt

Notes:

1. Pt is the ultimate limit state wind pressure on internal and external surfaces as determined in accordance with AS/NZS 1170.2, modified by an appropriate factor for variability, as determined in accordance with Table B1 of AS/NZS 1170.0.
2. The rate of load cycling must be less than 3Hz.
3. The single load cycle (sequence D) must be held for a minimum of 10 seconds.

NT Specification B1.2 Clause NT3 — NT4.

FIRE RESISTANCE

- C1** **Fire Resistance and Stability**
- C2** **Compartmentation and Separation**
- C3** **Protection of Openings**

SECTION C CONTENTS

SECTION C FIRE RESISTANCE

Section C Fire Resistance

Performance Requirements CP1 - CP9
Verification Methods CV1 - CV2

Part C1 Fire Resistance and Stability

C1.0 Deemed-to-Satisfy Provisions
C1.1 Type of construction required
C1.2 Calculation of rise in storeys
C1.3 Buildings of multiple classification
C1.4 Mixed types of construction
C1.5 Two storey Class 2, 3 or 9c buildings
C1.6 Class 4 parts of buildings
C1.7 Open spectator stands and indoor sports stadiums
C1.8 Lightweight construction
C1.9 * * * * *
C1.10 Fire hazard properties
C1.11 Performance of external walls in fire
C1.12 Non-combustible materials
C1.13 Fire-protected timber: Concession

Part C2 Compartmentation and Separation

C2.0 Deemed-to-Satisfy Provisions
C2.1 Application of Part
C2.2 General floor area and volume limitations
C2.3 Large isolated buildings
C2.4 Requirements for open spaces and vehicular access
C2.5 Class 9a and 9c buildings
C2.6 Vertical separation of openings in external walls
C2.7 Separation by fire walls
C2.8 Separation of classifications in the same storey
C2.9 Separation of classifications in different storeys
C2.10 Separation of lift shafts
C2.11 Stairways and lifts in one shaft
C2.12 Separation of equipment
C2.13 Electricity supply system
C2.14 Public corridors in Class 2 and 3 buildings

Part C3 Protection of Openings

C3.0 Deemed-to-Satisfy Provisions
C3.1 Application of Part
C3.2 Protection of openings in external walls

- C3.3 Separation of external walls and associated openings in different fire compartments
- C3.4 Acceptable methods of protection
- C3.5 Doorways in fire walls
- C3.6 Sliding fire doors
- C3.7 Protection of doorways in horizontal exits
- C3.8 Openings in fire-isolated exits
- C3.9 Service penetrations in fire-isolated exits
- C3.10 Openings in fire-isolated lift shafts
- C3.11 Bounding construction: Class 2 and 3 buildings and Class 4 Parts
- C3.12 Openings in floors and ceilings for services
- C3.13 Openings in shafts
- C3.14 * * * * *
- C3.15 Openings for service installations
- C3.16 Construction joints
- C3.17 Columns protected with lightweight construction to achieve an FRL

Specifications

- Specification C1.1 Fire-Resisting Construction
- Specification C1.8 Structural Tests for Lightweight Construction
- Specification C1.10 Fire Hazard Properties
- Specification C1.11 Performance of External Walls in Fire
- Specification C1.13 Cavity Barriers for Fire-Protected Timber
- Specification C2.5 Smoke-Proof Walls in Health-Care and Aged Care Buildings
- Specification C3.4 Fire Doors, Smoke Doors, Fire Windows and Shutters
- Specification C3.15 Penetration of Walls, Floors and Ceilings by Services

SECTION C FIRE RESISTANCE

PERFORMANCE REQUIREMENTS

CP1

A building must have elements which will, to the degree necessary, maintain structural stability during a fire appropriate to—

- (a) the function or use of the building; and
- (b) the *fire load*; and
- (c) the potential *fire intensity*; and
- (d) the *fire hazard*; and
- (e) the height of the building; and
- (f) its proximity to *other property*; and
- (g) any active *fire safety systems* installed in the building; and
- (h) the size of any *fire compartment*; and
- (i) *fire brigade* intervention; and
- (j) other elements they support; and
- (k) the *evacuation time*.

CP2

(a) A building must have elements which will, to the degree necessary, avoid the spread of fire—

- (i) to *exits*; and
- (ii) to *sole-occupancy units* and *public corridors*; and

Application:

CP2(a)(ii) only applies to a Class 2 or 3 building or Class 4 part of a building.

- (iii) between buildings; and
 - (iv) in a building.
- (b) Avoidance of the spread of fire referred to in (a) must be appropriate to—
- (i) the function or use of the building; and
 - (ii) the *fire load*; and
 - (iii) the potential *fire intensity*; and
 - (iv) the *fire hazard*; and

- (v) the number of *storeys* in the building; and
- (vi) its proximity to *other property*; and
- (vii) any active *fire safety systems* installed in the building; and
- (viii) the size of any *fire compartment*; and
- (ix) *fire brigade* intervention; and
- (x) other elements they support; and
- (xi) the *evacuation time*.

CP3

A building must be protected from the spread of fire and smoke to allow sufficient time for the orderly evacuation of the building in an emergency.

Application:

CP3 only applies to—

- (a) a *patient care area* of a Class 9a *health-care building*; and
- (b) a Class 9c building.

CP4

To maintain tenable conditions during occupant evacuation, a material and an assembly must, to the degree necessary, resist the spread of fire and limit the generation of smoke and heat, and any toxic gases likely to be produced, appropriate to—

- (a) the *evacuation time*; and
- (b) the number, mobility and other characteristics of occupants; and
- (c) the function or use of the building; and
- (d) any active *fire safety systems* installed in the building.

Application:

CP4 applies to linings, materials and assemblies in a Class 2 to 9 building.

CP5

A concrete *external wall* that could collapse as a complete panel (e.g. tilt-up and pre-cast concrete) must be designed so that in the event of fire within the building the likelihood of outward collapse is avoided.

Limitation:

CP5 does not apply to a building having more than two *storeys* above ground level.

CP6

A building must have elements, which will, to the degree necessary, avoid the spread of fire from service equipment having—

- (a) a high *fire hazard*; or
- (b) a potential for explosion resulting from a high *fire hazard*.

CP7

A building must have elements, which will, to the degree necessary, avoid the spread of fire so that emergency equipment provided in a building will continue to operate for a period of time necessary to ensure that the intended function of the equipment is maintained during a fire.

CP8

Any building element provided to resist the spread of fire must be protected, to the degree necessary, so that an adequate level of performance is maintained—

- (a) where openings, construction joints and the like occur; and
- (b) where penetrations occur for building services.

CP9

Access must be provided to and around a building, to the degree necessary, for *fire brigade* vehicles and personnel to facilitate *fire brigade* intervention appropriate to—

- (a) the function or use of the building; and
- (b) the *fire load*; and
- (c) the potential *fire intensity*; and
- (d) the *fire hazard*; and
- (e) any active *fire safety systems* installed in the building; and
- (f) the size of any *fire compartment*.

VERIFICATION METHODS

CV1

Compliance with **CP2(a)(iii)** to avoid the spread of fire between buildings on adjoining allotments is verified when it is calculated that—

- (a) a building will not cause heat flux in excess of those set out in column 2 of **Table CV1** at locations within the boundaries of an adjoining property set out in column 1 of **Table CV1** where another building may be constructed; and
- (b) when located at the distances from the allotment boundary set out in column 1 of **Table CV1**, a building is capable of withstanding the heat flux set out in column 2 of **Table CV1** without ignition.

Table CV1

Column 1	Column 2
Location	Heat Flux (kW/m ²)
On boundary	80

Table CV1 — continued

Column 1	Column 2
Location	Heat Flux (kW/m ²)
1 m from boundary	40
3 m from boundary	20
6 m from boundary	10

CV2

Compliance with **CP2(a)(iii)** to avoid the spread of fire between buildings on the same allotment is verified when it is calculated that a building—

- (a) is capable of withstanding the heat flux set out in column 2 of **Table CV2** without ignition; and
- (b) will not cause heat flux in excess of those set out in column 2 of **Table CV2**, when the distance between the buildings is as set out in column 1 of **Table CV2**.

Table CV2

Column 1	Column 2
Distance between buildings	Heat Flux (kW/m ²)
0 m	80
2 m	40
6 m	20
12 m	10

PART C1 FIRE RESISTANCE AND STABILITY

Deemed-to-Satisfy Provisions

C1.0 Deemed-to-Satisfy Provisions

- (a) Where a *Deemed-to-Satisfy Solution* is proposed, *Performance Requirements CP1* to *CP9* are satisfied by complying with—
 - (i) **C1.1** to **C1.13**, **C2.1** to **C2.14** and **C3.1** to **C3.17**; and
 - (ii) in a building containing an *atrium*, **Part G3**; and
 - (iii) for additional requirement for Class 9b buildings, **Part H1**; and
 - (iv) for *farm sheds*, **Part H3**.
- (b) Where a *Performance Solution* is proposed, the relevant *Performance Requirements* must be determined in accordance with **A0.7**.

C1.1 Type of construction required

- (a) The minimum Type of *fire-resisting construction* of a building must be that specified in **Table C1.1** and **Specification C1.1**, except as allowed for—
 - (i) certain Class 2, 3 or 9c buildings in **C1.5**; and
 - (ii) a Class 4 part of a building located on the top *storey* in **C1.3(b)**; and
 - (iii) *open spectator stands* and indoor sports stadiums in **C1.7**.
 - (iv) * * * * *

SA C1.1(a)(v)

- (b) Type A construction is the most fire-resistant and Type C the least fire-resistant of the Types of construction.

Table C1.1 TYPE OF CONSTRUCTION REQUIRED

Rise in storeys	Class of building	
	2, 3, 9	5, 6, 7, 8
4 OR MORE	A	A
3	A	B
2	B	C
1	C	C

SA C1.1(c) and (d)

C1.2 Calculation of rise in storeys

- (a) The *rise in storeys* is the sum of the greatest number of *storeys* at any part of the *external walls* of the building and any *storeys* within the roof space—
 - (i) above the finished ground next to that part; or

Deemed-to-Satisfy Provisions

- (ii) if part of the *external wall* is on the boundary of the allotment, above the natural ground level at the relevant part of the boundary.
- (b) A *storey* is not counted if—
 - (i) it is situated at the top of the building and contains only heating, ventilating or lift equipment, water tanks, or similar service units or equipment; or
 - (ii) it is situated partly below the finished ground and the underside of the ceiling is not more than 1 m above the average finished level of the ground at the *external wall*, or if the *external wall* is more than 12 m long, the average for the 12 m part where the ground is lowest.
- (c) In a Class 7 or 8 building, a *storey* that has an average internal height of more than 6 m is counted as—
 - (i) one *storey* if it is the only *storey* above the ground; or
 - (ii) 2 *storeys* in any other case.
- (d) For the purposes of calculating the *rise in storeys* of a building—
 - (i) a *mezzanine* is regarded as a *storey* in that part of the building in which it is situated if its *floor area* is more than 200 m² or more than 1/3 of the *floor area* of the room, whichever is the lesser; and
 - (ii) two or more *mezzanines* are regarded as a *storey* in that part of the building in which they are situated if they are at or near the same level and have an aggregate *floor area* more than 200 m² or more than 1/3 of the *floor area* of the room, whichever is the lesser.

C1.3 Buildings of multiple classification

- (a) In a building of multiple classifications, the Type of construction *required* for the building is the most *fire-resisting* Type resulting from the application of **Table C1.1** on the basis that the classification applying to the top *storey* applies to all *storeys*.
- (b) In a building containing a Class 4 part on the top *storey*, for the purpose of (a), the classification applying to the top *storey* must be—
 - (i) when the Class 4 part occupies the whole of the top *storey*, the classification applicable to the next highest *storey*; or
 - (ii) when the Class 4 part occupies part of the top *storey*, the classification applicable to the adjacent part.

C1.4 Mixed types of construction

A building may be of mixed Types of construction where it is separated in accordance with **C2.7** and the Type of construction is determined in accordance with **C1.1** or **C1.3**.

C1.5 Two storey Class 2, 3 or 9c buildings

A building having a *rise in storeys* of 2 may be of Type C construction if—

- (a) it is a Class 2 or 3 building or a mixture of these classes and each *sole-occupancy unit* has—
 - (i) access to at least 2 *exits*; or

Deemed-to-Satisfy Provisions

- (ii) its own direct access to a road or *open space*; or
- (b) it is a Class 9c building protected throughout with a sprinkler system complying with **Specification E1.5** and complies with the maximum compartment size specified in **Table C2.2** for Type C construction.

C1.6 Class 4 parts of buildings

For the Type of construction *required* by **C1.3**, a Class 4 part of a building requires the same FRL for building elements and the same construction separating the Class 4 part from the remainder of the building as a Class 2 part in the same Type of construction.

C1.7 Open spectator stands and indoor sports stadiums

- (a) An *open spectator stand* or indoor sports stadium may be of Type C construction and need not comply with the other provisions of this Part if it contains not more than 1 tier of seating, is of *non-combustible* construction, and has only changing rooms, sanitary facilities or the like below the tiered seating.
- (b) In (a), one tier of seating means numerous rows of tiered seating incorporating cross-overs but within one viewing level.

C1.8 Lightweight construction

- (a) *Lightweight construction* must comply with **Specification C1.8** if it is used in a wall system—
 - (i) that is *required* to have an FRL; or
 - (ii) for a lift *shaft*, stair *shaft* or service *shaft* or an *external wall* bounding a *public corridor* including a non *fire-isolated passageway* or non *fire-isolated ramp*, in a spectator stand, sports stadium, cinema or theatre, railway station, bus station or airport terminal.
- (b) If *lightweight construction* is used for the *fire-resisting* covering of a steel column or the like, and if—
 - (i) the covering is not in continuous contact with the column, then the void must be filled solid, to a height of not less than 1.2 m above the floor to prevent indenting; and
 - (ii) the column is liable to be damaged from the movement of vehicles, materials or equipment, then the covering must be protected by steel or other suitable material.

C1.9 * * * * *

This clause has deliberately been left blank.

C1.10 Fire hazard properties

- (a) The *fire hazard properties* of the following linings, materials and assemblies in a Class 2 to 9 building must comply with **Specification C1.10**:
 - (i) Floor linings and floor coverings.
 - (ii) Wall linings and ceiling linings.

Deemed-to-Satisfy Provisions

- (iii) Air-handling ductwork.
- (iv) Lift cars.

NSW C1.10(a)(v)

- (v) In Class 9b buildings used as a theatre, public hall or the like—
 - (A) fixed seating in the audience area or auditorium; and
 - (B) a proscenium curtain *required* by **Specification H1.3**.
- (vi) Escalators, moving walkways and non-*required* non *fire-isolated stairways* or pedestrian ramps subject to **Specification D1.12**.
- (vii) *Sarking-type materials*.
- (viii) Attachments to floors, ceilings, internal walls and the internal linings of external walls.
- (ix) Other materials including insulation materials other than *sarking-type materials*.

NSW C1.10(b)

- (b) Paint or fire-retardant coatings must not be used to achieve compliance with the *required fire hazard properties*.
- (c) The requirements of **(a)** do not apply to a material or assembly if it is—
 - (i) plaster, cement render, concrete, terrazzo, ceramic tile or the like; or
 - (ii) a *fire-protective covering*; or
 - (iii) a timber-framed *window*; or
 - (iv) a solid timber handrail or skirting; or
 - (v) a timber-faced solid-core door or timber-faced fire door; or
 - (vi) an electrical switch, socket-outlet, cover plate or the like; or
 - (vii) a material used for—
 - (A) a roof insulating material applied in continuous contact with a substrate; or
 - (B) an adhesive; or
 - (C) a damp-proof course, flashing, caulking, sealing, ground moisture barrier, or the like; or
 - (viii) a paint, varnish, lacquer or similar finish, other than nitro-cellulose lacquer; or
 - (ix) a clear or translucent roof light of glass fibre-reinforced polyester if—
 - (A) the roof in which it is installed forms part of a single *storey* building *required* to be Type C construction; and
 - (B) the material is used as part of the roof covering; and
 - (C) it is not closer than 1.5 m from another roof light of the same type; and
 - (D) each roof light is not more than 14 m² in area; and
 - (E) the area of the roof lights per 70 m² of roof surface is not more than 14 m²; or
 - (x) a face plate or neck adaptor of supply and return air outlets of an air handling system; or

Deemed-to-Satisfy Provisions

- (xi) a face plate or diffuser plate of light fitting and emergency *exit* signs and associated electrical wiring and electrical components; or
- (xii) a joinery unit, cupboard, shelving, or the like; or

NSW C1.10(c)(xiii)

- (xiii) an attached non-building fixture and fitting such as—
 - (A) a curtain, blind, or similar decor, other than a proscenium curtain *required* by **Specification H1.3**; and
 - (B) a whiteboard, *window* treatment or the like; or
- (xiv) timber treads, risers, landings and associated supporting framework installed in accordance with **D2.25** where the *Spread-of-Flame Index* and the *Smoke-Developed Index* of the timber does not exceed 9 and 8 respectively; or

Vic C1.10(c)(xv)

- (xv) any other material that does not significantly increase the hazards of fire.

C1.11 Performance of external walls in fire

Concrete *external walls* that could collapse as complete panels (e.g. tilt-up and pre-cast concrete), in a building having a *rise in storeys* of not more than 2, must comply with **Specification C1.11**.

C1.12 Non-combustible materials

The following materials, though *combustible* or containing *combustible* fibres, may be used wherever a *non-combustible* material is *required*:

- (a) Plasterboard.
- (b) Perforated gypsum lath with a normal paper finish.
- (c) Fibrous-plaster sheet.
- (d) Fibre-reinforced cement sheeting.
- (e) Pre-finished metal sheeting having a *combustible* surface finish not exceeding 1 mm thickness and where the *Spread-of-Flame Index* of the product is not greater than 0.
- (f) Bonded laminated materials where—
 - (i) each laminate is *non-combustible*; and
 - (ii) each adhesive layer does not exceed 1 mm in thickness; and
 - (iii) the total thickness of the adhesive layers does not exceed 2 mm; and
 - (iv) the *Spread-of-Flame Index* and the *Smoke-Developed Index* of the laminated material as a whole does not exceed 0 and 3 respectively.

C1.13 Fire-protected timber: Concession

Fire-protected timber in a Class 2, 3 or 5 building may be used wherever an element is *required* to be *non-combustible*, provided—

- (a) the building is—
 - (i) a separate building; or

Deemed-to-Satisfy Provisions

- (ii) a part of a building—
 - (A) which only occupies part of a *storey*, and is separated from the remaining part by a *fire wall*; or
 - (B) which is located above or below a part not containing *fire-protected timber* and the floor between the adjoining parts is provided with an FRL not less than that prescribed for a *fire wall* for the lower *storey*; and
- (b) the building has an *effective height* of not more than 25 m; and
- (c) the building has a sprinkler system throughout complying with **Specification E1.5**; and
- (d) any insulation installed in the cavity of the timber building element *required* to have an FRL is *non-combustible*; and
- (e) cavity barriers are provided in accordance with **Specification C1.13**.

PART C2

COMPARTMENTATION AND SEPARATION

Deemed-to-Satisfy Provisions

C2.0 Deemed-to-Satisfy Provisions

- (a) Where a *Deemed-to-Satisfy Solution* is proposed, *Performance Requirements CP1* to *CP9* are satisfied by complying with—
- (i) **C1.1** to **C1.13**, **C2.1** to **C2.14** and **C3.1** to **C3.17**; and
 - (ii) in a building containing an *atrium*, **Part G3**; and
 - (iii) for additional requirements for Class 9b buildings, **Part H1**; and
 - (iv) for *farm sheds*, **Part H3**.
- (b) Where a *Performance Solution* is proposed, the relevant *Performance Requirements* must be determined in accordance with **A0.7**.

C2.1 Application of Part

- (a) **C2.2**, **C2.3** and **C2.4** do not apply to a *carpark* provided with a sprinkler system complying with **Specification E1.5**, an *open-deck carpark* or an *open spectator stand*.
- (b) **C2.12(a)(v)** does not apply to a Class 8 *electricity network substation*.

C2.2 General floor area and volume limitations

- (a) The size of any *fire compartment* or *atrium* in a Class 5, 6, 7, 8 or 9 building must not exceed the relevant maximum *floor area* nor the relevant maximum volume set out in **Table C2.2** and **C2.5** except as permitted in **C2.3**.
- (b) A part of a building which contains only heating, ventilating, or lift equipment, water tanks, or similar service units is not counted in the *floor area* or volume of a *fire compartment* or *atrium* if it is situated at the top of the building.
- (c) In a building containing an *atrium*, the part of the *atrium well* bounded by the perimeter of the openings in the floors and extending from the level of the first floor above the *atrium* floor to the roof covering is not counted in the volume of the *atrium* for the purposes of this clause.

Table C2.2 MAXIMUM SIZE OF FIRE COMPARTMENTS OR ATRIA

Classification		Type of construction of building		
		Type A	Type B	Type C
5, 9b or 9c <i>aged care building</i>	max <i>floor area</i> —	8 000 m ²	5 500 m ²	3 000 m ²
	max volume—	48 000 m ³	33 000 m ³	18 000 m ³
6, 7, 8 or 9a (except for <i>patient care areas</i>)	max <i>floor area</i> —	5 000 m ²	3 500 m ²	2 000 m ²
	max volume—	30 000 m ³	21 000 m ³	12 000 m ³

Note: See **C2.5** for maximum size of compartments in *patient care areas* in Class 9a *health care buildings*.

Deemed-to-Satisfy Provisions

C2.3 Large isolated buildings

The size of a *fire compartment* in a building may exceed that specified in **Table C2.2** where—

- (a) the building does not exceed 18 000 m² in *floor area* nor exceed 108 000 m³ in volume, if—
 - (i) the building is Class 7 or 8 and—
 - (A) contains not more than 2 *storeys*; and
 - (B) is provided with open space complying with **C2.4(a)** not less than 18 m wide around the building; or
 - (ii) the building is Class 5, 6, 7, 8 or 9 and is—
 - (A) protected throughout with a sprinkler system complying with **Specification E1.5**; and
 - (B) provided with a perimeter vehicular access complying with **C2.4(b)**; or
- (b) the building is Class 5, 6, 7, 8 or 9 and exceeds 18 000 m² in *floor area* or 108 000 m³ in volume, if it is—
 - (i) protected throughout with a sprinkler system complying with **Specification E1.5**; and
 - (ii) provided with a perimeter vehicular access complying with **C2.4(b)**; or
- (c) there is more than one building on the allotment and—
 - (i) each building complies with **(a)** or **(b)**; or
 - (ii) if the buildings are closer than 6 m to each other they are regarded as one building and collectively comply with **(a)** or **(b)**.

C2.4 Requirements for open spaces and vehicular access

- (a) An open space *required* by **C2.3** must—
 - (i) be wholly within the allotment except that any road, river, or public place adjoining the allotment, but not the farthest 6 m of it may be included; and
 - (ii) include vehicular access in accordance with **(b)**; and
 - (iii) not be used for the storage or processing of materials; and
 - (iv) not be built upon, except for guard houses and service structures (such as electricity substations and pump houses) which may encroach upon the width of the space if they do not unduly impede fire-fighting at any part of the perimeter of the allotment or unduly add to the risk of spread of fire to any building on an adjoining allotment.
- (b) Vehicular access *required* by this Part—
 - (i) must be capable of providing continuous access for emergency vehicles to enable travel in a forward direction from a public road around the entire building; and
 - (ii) must have a minimum unobstructed width of 6 m with no part of its furthest boundary more than 18 m from the building and in no part of the 6 m width be built upon or used for any purpose other than vehicular or pedestrian movement; and

Deemed-to-Satisfy Provisions

- (iii) must provide reasonable pedestrian access from the vehicular access to the building; and
- (iv) must have a load bearing capacity and unobstructed height to permit the operation and passage of *fire brigade* vehicles; and
- (v) must be wholly within the allotment except that a public road complying with (i), (ii), (iii) and (iv) may serve as the vehicular access or part thereof.

C2.5 Class 9a and 9c buildings

- (a) A Class 9a *health care building* must comply with the following:
 - (i) *Patient care areas* must be divided into *fire compartments* not exceeding 2000 m².
 - (ii) A *fire compartment* must be separated from the remainder of the building by *fire walls* and—
 - (A) in Type A construction—floors and roof or ceiling as *required* in **Specification C1.1**; and
 - (B) in Type B construction—floors with an FRL of not less than 120/120/120 and with the openings in *external walls* bounding *patient care areas* being vertically separated in accordance with the requirements of **C2.6** as if the building were of Type A construction.
 - (iii) *Ward areas*—
 - (A) where the *floor area* exceeds 1000 m², must be divided into *floor areas* not more than 1000 m² by walls with an FRL of not less than 60/60/60; and
 - (B) where the *floor area* exceeds 500 m², must be divided into *floor areas* not more than 500 m² by smoke-proof walls complying with **Specification C2.5**; and
 - (C) where the *floor area* is not more than 500 m², must be separated from the remainder of the *patient care area* by smoke-proof walls complying with **Specification C2.5**; and
 - (D) where division of *ward areas* by *fire-resisting* walls under (i) or (iii)(A) is not *required*, any smoke-proof wall *required* under (iii)(B) or (C) must have an FRL of not less than 60/60/60.
 - (iv) *Treatment areas*—
 - (A) where the *floor area* exceeds 1000 m², must be divided into *floor areas* not more than 1000 m² by smoke-proof walls complying with **Specification C2.5**; and
 - (B) where the *floor area* is not more than 1000 m², must be separated from the remainder of the *patient care area* by smoke-proof walls complying with **Specification C2.5**.
 - (v) Ancillary use areas located within a *patient care area* and containing equipment or materials that are a high potential *fire hazard*, must be separated from the remainder of the *patient care area* by walls with an FRL of not less than 60/60/60.
 - (vi) The ancillary use areas referred to in (v) include, but are not limited to, the following:

Deemed-to-Satisfy Provisions

- (A) A kitchen and related food preparation areas having a combined *floor area* of more than 30 m².
 - (B) A room containing a hyperbaric facility (pressure chamber).
 - (C) A room used predominantly for the storage of medical records having a *floor area* of more than 10 m².
 - (D) A laundry, where items of equipment are of the type that are potential fire sources (e.g. gas fire dryers).
- (vii) A wall *required* by (v) to separate ancillary use areas from the remainder of the building must extend to the underside of—
- (A) the floor above; or
 - (B) a *non-combustible* roof covering; or
 - (C) a ceiling having a *resistance to the incipient spread of fire* to the space above itself of not less than 60 minutes.
- (viii) Openings in walls *required* by (iii) and (v) to have an FRL must be protected as follows:
- (A) Doorways—*self-closing* or *automatic* closing –/60/30 fire doors.
 - (B) Windows—*automatic* or permanently fixed closed –/60/– fire windows or –/60/– *automatic* fire shutters.
 - (C) Other openings—construction having an FRL not less than –/60/–.

NSW C2.5(b)

- (b) A Class 9c building must comply with the following:
- (i) A building must be divided into areas not more than 500 m² by smoke-proof walls complying with **Specification C2.5**.
 - (ii) A *fire compartment* must be separated from the remainder of the building by *fire walls* and, notwithstanding **C2.7** and **Specification C1.1**, floors with an FRL of not less than 60/60/60.
 - (iii) Internal walls (other than those bounding lift and stair shafts) supported by floors provided in accordance with **C2.5(b)(ii)** need not comply with **Specification C1.1** if they have an FRL not less than 60/–/–.
 - (iv) Ancillary use areas containing equipment or materials that are a high potential *fire hazard*, must be separated from the *sole-occupancy units* by smoke-proof walls complying with **Specification C2.5**.
 - (v) The ancillary use areas referred to in (iv) include, but are not limited to, the following:
 - (A) A kitchen and related food preparation areas having a combined *floor area* of more than 30 m².
 - (B) A laundry, where items of equipment are of the type that are potential fire sources (e.g. gas fired dryers).
 - (C) Storage rooms greater than 10 m² used predominantly for the storage of administrative records.
 - (vi) Openings in *fire walls* must be protected as follows:

Deemed-to-Satisfy Provisions

- (A) Doorways — *self-closing* or *automatic* closing –/60/30 fire doors.
- (B) Windows — *automatic* or permanently fixed closed –/60/– fire windows or –/60/– *automatic* fire shutters.
- (C) Other openings — construction having an FRL not less than –/60/–.

C2.6 Vertical separation of openings in external walls

- (a) If in a building of Type A construction, any part of a *window* or other opening in an *external wall* is above another opening in the *storey* next below and its vertical projection falls no further than 450 mm outside the lower opening (measured horizontally), the openings must be separated by—
 - (i) a spandrel which—
 - (A) is not less than 900 mm in height; and
 - (B) extends not less than 600 mm above the upper surface of the intervening floor; and
 - (C) is of *non-combustible* material having an FRL of not less than 60/60/60; or
 - (ii) part of a *curtain wall* or *panel wall* that complies with (i); or
 - (iii) construction that complies with (i) behind a *curtain wall* or *panel wall* and has any gaps packed with a *non-combustible* material that will withstand thermal expansion and structural movement of the walling without the loss of seal against fire and smoke; or
 - (iv) a slab or other horizontal construction that—
 - (A) projects outwards from the external face of the wall not less than 1100 mm; and
 - (B) extends along the wall not less than 450 mm beyond the openings concerned; and
 - (C) is *non-combustible* and has an FRL of not less than 60/60/60.
- (b) The requirements of (a) do not apply to—
 - (i) an *open-deck carpark*; or
 - (ii) an *open spectator stand*; or
 - (iii) a building which has a sprinkler system complying with **Specification E1.5** installed throughout; or
 - (iv) openings within the same stairway; or
 - (v) openings in *external walls* where the floor separating the *storeys* does not require an FRL with respect to *integrity* and *insulation*.
- (c) For the purposes of C2.6, *window* or other opening means that part of the *external wall* of a building that does not have an FRL of 60/60/60 or greater.

C2.7 Separation by fire walls

- (a) **Construction** — A *fire wall* must be constructed in accordance with the following:

Deemed-to-Satisfy Provisions

- (i) The *fire wall* has the relevant FRL prescribed by **Specification C1.1** for each of the adjoining parts, and if these are different, the greater FRL, except where **Tables 3.9, 4.2 and 5.2 of Specification C1.1** permit a lower FRL on the *carpark* side.
 - (ii) Any openings in a *fire wall* must not reduce the FRL *required* by **Specification C1.1** for the *fire wall*, except where permitted by the *Deemed-to-Satisfy Provisions* of **Part C3**.
 - (iii) Building elements, other than roof battens with dimensions of 75 mm x 50 mm or less or *sarking-type material*, must not pass through or cross the *fire wall* unless the *required fire resisting* performance of the *fire wall* is maintained.
- (b) **Separation of buildings** — A part of a building separated from the remainder of the building by a *fire wall* may be treated as a separate building for the purposes of the *Deemed-to-Satisfy Provisions* of **Sections C, D and E** if it is constructed in accordance with **(a)** and the following:
- (i) The *fire wall* extends through all *storeys* and spaces in the nature of *storeys* that are common to that part and any adjoining part of the building.
 - (ii) The *fire wall* is carried through to the underside of the roof covering.
 - (iii) Where the roof of one of the adjoining parts is lower than the roof of the other part, the *fire wall* extends to the underside of—
 - (A) the covering of the higher roof, or not less than 6 m above the covering of the lower roof; or
 - (B) the lower roof if it has an FRL not less than that of the *fire wall* and no openings closer than 3 m to any wall above the lower roof; or
 - (C) the lower roof if its covering is *non-combustible* and the lower part has a sprinkler system complying with **Specification E1.5**.
- (c) **Separation of fire compartments** — A part of a building separated from the remainder of the building by a *fire wall* may be treated as a separate *fire compartment* if it is constructed in accordance with **(a)** and the *fire wall* extends to the underside of—
- (i) a floor having an FRL *required* for a *fire wall*; or
 - (ii) the roof covering.

C2.8 Separation of classifications in the same storey

If a building has parts of different classifications located alongside one another in the same *storey*—

- (a) each building element in that *storey* must have the higher FRL prescribed in **Specification C1.1** for that element for the classifications concerned; or
- (b) the parts must be separated in that *storey* by a *fire wall* having—
 - (i) the higher FRL prescribed in **Table 3 or 4**; or
 - (ii) the FRL prescribed in **Table 5**,
 of **Specification C1.1** as applicable, for that element for the Type of construction and the classifications concerned; or
- (c) where one part is a carpark complying with **Table 3.9, 4.2 or 5.2 of Specification C1.1**, the parts may be separated by a *fire wall* complying with the appropriate Table.

Deemed-to-Satisfy Provisions

C2.9 Separation of classifications in different storeys

If parts of different classification are situated one above the other in adjoining *storeys* they must be separated as follows:

- (a) Type A construction — The floor between the adjoining parts must have an FRL of not less than that prescribed in **Specification C1.1** for the classification of the lower *storey*.
- (b) Type B or C construction — If one of the adjoining parts is of Class 2, 3 or 4, the floor separating the part from the *storey* below must—
 - (i) be a floor/ceiling system incorporating a ceiling which has a *resistance to the incipient spread of fire* to the space above itself of not less than 60 minutes; or
 - (ii) have an FRL of at least 30/30/30; or
 - (iii) have a *fire-protective covering* on the underside of the floor, including beams incorporated in it, if the floor is *combustible* or of metal.

C2.10 Separation of lift shafts

- (a) Any lift connecting more than 2 *storeys*, or more than 3 *storeys* if the building is sprinklered, (other than lifts which are wholly within an *atrium*) must be separated from the remainder of the building by enclosure in a *shaft* in which—
 - (i) in a building *required* to be of Type A construction—the walls have the relevant FRL prescribed by **Specification C1.1**; and
 - (ii) in a building *required* to be of Type B construction — the walls—
 - (A) if *loadbearing*, have the relevant FRL prescribed by **Table 4 of Specification C1.1**; or
 - (B) if *non-loadbearing*, be of *non-combustible* construction.
- (b) Any lift in a *patient care area* in a Class 9a *health-care building* or a *resident use area* in Class 9c building must be separated from the remainder of the building by a *shaft* having an FRL of not less than—
 - (i) in a building of Type A or B construction — 120/120/120; or
 - (ii) in a building of Type C construction — 60/60/60.
- (c) An emergency lift must be contained within a *fire-resisting shaft* having an FRL of not less than 120/120/120.
- (d) Openings for lift landing doors and services must be protected in accordance with the *Deemed-to-Satisfy Provisions* of **Part C3**.

C2.11 Stairways and lifts in one shaft

A stairway and lift must not be in the same *shaft* if either the stairway or the lift is *required* to be in a *fire-resisting shaft*.

C2.12 Separation of equipment

- (a) Equipment other than that described in (b) and (c) must be separated from the remainder of the building with construction complying with (d), if that equipment comprises—

Deemed-to-Satisfy Provisions

- (i) lift motors and lift control panels; or
 - (ii) emergency generators used to sustain emergency equipment operating in the emergency mode; or
 - (iii) central smoke control plant; or
 - (iv) *boilers*; or
 - (v) a battery or batteries installed in the building that have a voltage exceeding 24 volts and a capacity exceeding 10 ampere hours.
- (b) Equipment need not be separated in accordance with (a) if the equipment comprises—
- (i) smoke control exhaust fans located in the air stream which are constructed for high temperature operation in accordance with **Specification E2.2b**; or
 - (ii) stair pressurising equipment installed in compliance with the relevant provisions of AS/NZS 1668.1; or
 - (iii) a lift installation without a machine-room; or
 - (iv) equipment otherwise adequately separated from the remainder of the building.
- (c) Separation of on-site fire pumps must comply with the requirements of AS 2419.1.
- (d) Separating construction must have—
- (i) except as provided by (ii)—
 - (A) an FRL as *required* by **Specification C1.1**, but not less than 120/120/120; and
 - (B) any doorway protected with a *self-closing* fire door having an FRL of not less than –/120/30; or
 - (ii) when separating a lift *shaft* and lift motor room, an FRL not less than 120/–/–.

C2.13 Electricity supply system

- (a) An electricity substation located within a building must—
- (i) be separated from any other part of the building by construction having an FRL of not less than 120/120/120; and
 - (ii) have any doorway in that construction protected with a *self-closing* fire door having an FRL of not less than –/120/30.
- (b) A main switchboard located within the building which sustains emergency equipment operating in the emergency mode must—
- (i) be separated from any other part of the building by construction having an FRL of not less than 120/120/120; and
 - (ii) have any doorway in that construction protected with a *self-closing* fire door having an FRL of not less than –/120/30.
- (c) Electrical conductors located within a building that supply—
- (i) a substation located within the building which supplies a main switchboard covered by (b); or
 - (ii) a main switchboard covered by (b),

Deemed-to-Satisfy Provisions

must—

- (iii) have a classification in accordance with AS/NZS 3013 of not less than—
 - (A) if located in a position that could be subject to damage by motor vehicles — WS53W; or
 - (B) otherwise — WS52W; or
- (iv) be enclosed or otherwise protected by construction having an FRL of not less than 120/120/120.
- (d) Where emergency equipment is *required* in a building, all switchboards in the electrical installation, which sustain the electricity supply to the emergency equipment, must be constructed so that emergency equipment switchgear is separated from non-emergency equipment switchgear by metal partitions designed to minimise the spread of a fault from the non-emergency equipment switchgear.
- (e) For the purposes of (d), emergency equipment includes but is not limited to the following:
 - (i) Fire hydrant booster pumps.
 - (ii) Pumps for *automatic* sprinkler systems, water spray, chemical fluid suppression systems or the like.
 - (iii) Pumps for fire hose reels where such pumps and fire hose reels form the sole means of fire protection in the building.
 - (iv) Air handling systems designed to exhaust and control the spread of fire and smoke.
 - (v) Emergency lifts.
 - (vi) Control and indicating equipment.
 - (vii) Sound systems and intercom systems for emergency purposes.

C2.14 Public corridors in Class 2 and 3 buildings

In a Class 2 or 3 building, a *public corridor*, if more than 40 m in length, must be divided at intervals of not more than 40 m with smoke-proof walls complying with **Clause 2 of Specification C2.5**.

SA C2.15

PART C3 PROTECTION OF OPENINGS

Deemed-to-Satisfy Provisions

C3.0 Deemed-to-Satisfy Provisions

- (a) Where a *Deemed-to-Satisfy Solution* is proposed, *Performance Requirements CP1* to *CP9* are satisfied by complying with—
- (i) **C1.1** to **C1.13**, **C2.1** to **C2.14** and **C3.1** to **C3.17**; and
 - (ii) in a building containing an *atrium*, **Part G3**; and
 - (iii) for additional requirements for Class 9b buildings, **Part H1**; and
 - (iv) for *farm sheds*, **Part H3**.
- (b) Where a *Performance Solution* is proposed, the relevant *Performance Requirements* must be determined in accordance with **A0.7**.

C3.1 Application of Part

- (a) The *Deemed-to-Satisfy Provisions* of this Part do not apply to—
- (i) control joints, weep holes and the like in *external walls* of masonry construction and joints between panels in *external walls* of pre-cast concrete panel construction if, in all cases they are not larger than necessary for the purpose; and
 - (ii) *non-combustible* ventilators for subfloor or cavity ventilation, if each does not exceed 45 000 mm² in face area and is spaced not less than 2 m from any other ventilator in the same wall; and
 - (iii) openings in the vertical plane formed between building elements at the construction edge or perimeter of a balcony or verandah, colonnade, terrace, or the like; and
 - (iv) in a *carpark*—
 - (A) service penetrations through; and
 - (B) openings formed by a vehicle ramp in,
a floor other than a floor that separates a part not used as a *carpark*, providing the connected floors comply as a single *fire compartment* for the purposes of all other requirements of the *Deemed-to-Satisfy Provisions* of **Sections C, D** and **E**.
- (b) For the purposes of the *Deemed-to-Satisfy Provisions* of this Part, openings in building elements *required* to be *fire-resisting* include doorways, *windows* (including any associated fanlight), infill panels and fixed or openable glazed areas that do not have the *required* FRL.
- (c) For the purposes of the *Deemed-to-Satisfy Provisions* of this Part, openings, other than those covered under (a)(iii), between building elements such as columns, beams and the like, in the plane formed at the construction edge or perimeter of the building, are deemed to be openings in an *external wall*.

C3.2 Protection of openings in external walls

Openings in an *external wall* that is *required* to have an FRL must—

Deemed-to-Satisfy Provisions

- (a) if the distance between the opening and the *fire-source feature* to which it is exposed is less than—
 - (i) 3 m from a side or rear boundary of the allotment; or
 - (ii) 6 m from the far boundary of a road, river, lake or the like adjoining the allotment, if not located in a *storey* at or near ground level; or
 - (iii) 6 m from another building on the allotment that is not Class 10,
 be protected in accordance with **C3.4** and if wall-wetting sprinklers are used, they are located externally; and
- (b) if *required* to be protected under (a), not occupy more than 1/3 of the area of the *external wall* of the *storey* in which it is located unless they are in a Class 9b building used as an *open spectator stand*.

C3.3 Separation of external walls and associated openings in different fire compartments

The distance between parts of *external walls* and any openings within them in different *fire compartments* separated by a *fire wall* must not be less than that set out in **Table C3.3**, unless—

- (a) those parts of each wall have an FRL not less than 60/60/60; and
- (b) any openings protected in accordance with **C3.4**.

Table C3.3 DISTANCE BETWEEN EXTERNAL WALLS AND ASSOCIATED OPENINGS IN DIFFERENT FIRE COMPARTMENTS

Angle between walls	Min. Distance
0° (walls opposite)	6 m
more than 0° to 45°	5 m
more than 45° to 90°	4 m
more than 90° to 135°	3 m
more than 135° to less than 180°	2 m
180° or more	Nil

C3.4 Acceptable methods of protection

- (a) Where protection is *required*, doorways, *windows* and other openings must be protected as follows:
 - (i) Doorways—
 - (A) internal or external wall-wetting sprinklers as appropriate used with doors that are *self-closing* or *automatic* closing; or
 - (B) –/60/30 fire doors that are *self-closing* or *automatic* closing.
 - (ii) *Windows*—
 - (A) internal or external wall-wetting sprinklers as appropriate used with *windows* that are *automatic* closing or permanently fixed in the closed position; or

Deemed-to-Satisfy Provisions

- (B) –/60/– fire *windows* that are *automatic* closing or permanently fixed in the closed position; or
- (C) –/60/– *automatic* closing fire shutters.
- (iii) Other openings—
 - (A) excluding voids — internal or external wall-wetting sprinklers, as appropriate; or
 - (B) construction having an FRL not less than –/60/–.
- (b) Fire doors, fire *windows* and fire shutters must comply with **Specification C3.4**.

C3.5 Doorways in fire walls

- (a) The aggregate width of openings for doorways in a *fire wall*, which are not part of a *horizontal exit*, must not exceed $\frac{1}{2}$ of the length of the *fire wall*, and each doorway must be protected by—
 - (i) 2 fire doors or fire shutters, one on each side of the doorway, each of which has an FRL of not less than $\frac{1}{2}$ that *required* by **Specification C1.1** for the *fire wall* except that each door or shutter must have an *insulation* level of at least 30; or
 - (ii) a fire door on one side and a fire shutter on the other side of the doorway, each of which complies with (i); or
 - (iii) a single fire door or fire shutter which has an FRL of not less than that *required* by **Specification C1.1** for the *fire wall* except that each door or shutter must have an *insulation* level of at least 30.
- (b)
 - (i) A fire door or fire shutter *required* by (a)(i), (a)(ii) or (a)(iii) must be *self-closing*, or *automatic* closing in accordance with (ii) and (iii).
 - (ii) The *automatic* closing operation must be initiated by the activation of a smoke detector, or any other detector deemed suitable in accordance with AS 1670.1 if smoke detectors are unsuitable in the atmosphere, installed in accordance with the relevant provisions of AS 1670.1 and located on each side of the *fire wall* not more than 1.5 m horizontal distance from the opening.
 - (iii) Where any other *required* suitable fire alarm system, including a sprinkler system complying with **Specification E1.5**, is installed in the building, activation of the system in either *fire compartment* separated by the *fire wall* must also initiate the *automatic* closing operation.

C3.6 Sliding fire doors

- (a) If a doorway in a *fire wall* is fitted with a sliding fire door which is open when the building is in use—
 - (i) it must be held open with an electromagnetic device, which when de-activated in accordance with (b), allows the door to be fully closed in not less than 20 seconds and not more than 30 seconds after release; and
 - (ii) in the event of power failure to the door — the door must fail safe in the closed position in accordance with (i); and

Deemed-to-Satisfy Provisions

- (iii) an audible warning device must be located near the doorway and a red flashing warning light of adequate intensity on each side of the doorway must be activated in accordance with (b); and
- (iv) signs must be installed on each side of the doorway located directly over the opening stating—

WARNING — SLIDING FIRE DOOR

in capital letters not less than 50 mm high in a colour contrasting with the background.

- (b)
 - (i) The electromagnetic device must be de-activated and the warning system activated by heat or smoke detectors, as appropriate, installed in accordance with AS 1905.1 and the relevant provisions of AS 1670.1.
 - (ii) Where any other *required* suitable fire alarm system, including a sprinkler system complying with **Specification E1.5**, is installed in the building, activation in either *fire compartment* separated by the *fire wall* must also de-activate the electromagnetic device and activate the warning system.

C3.7 Protection of doorways in horizontal exits

- (a) A doorway that is part of a *horizontal exit* must be protected by either—
 - (i) a single fire door that has an FRL of not less than that *required* by **Specification C1.1** for the *fire wall* except that the door must have an *insulation* level of at least 30; or
 - (ii) in a Class 7 or 8 building — 2 fire doors, one on each side of the doorway, each with an FRL of not less than ½ that *required* by **Specification C1.1** for the *fire wall* except that each door must have an *insulation* level of at least 30.
- (b)
 - (i) Each door *required* by (a) must be *self-closing*, or *automatic-closing* in accordance with (ii) and (iii).
 - (ii) The *automatic-closing* operation must be initiated by the activation of a smoke detector, or any other detector deemed suitable in accordance with AS 1670.1 if smoke detectors are unsuitable in the atmosphere, installed in accordance with the relevant provisions of AS 1670.1 and located on each side of the *fire wall* not more than 1.5 m horizontal distance from the opening.
 - (iii) Where any other *required* suitable fire alarm system, including a sprinkler system complying with **Specification E1.5**, is installed in the building, activation of the system in either *fire compartment* separated by the *fire wall* must also initiate the *automatic-closing* operation.

C3.8 Openings in fire-isolated exits

- (a)
 - (i) Doorways that open to *fire-isolated stairways*, *fire-isolated passageways* or *fire-isolated ramps*, and are not doorways opening to a road or *open space*, must be protected by –/60/30 fire doors that are *self-closing*, or *automatic-closing* in accordance with (ii) and (iii).

Deemed-to-Satisfy Provisions

- (ii) The *automatic*-closing operation must be initiated by the activation of a smoke detector, or any other detector deemed suitable in accordance with AS 1670 if smoke detectors are unsuitable in the atmosphere, installed in accordance with the relevant provisions of AS 1670.1 and located not more than 1.5 m horizontal distance from the approach side of the doorway.
 - (iii) Where any other *required* suitable fire alarm system, including a sprinkler system complying with **Specification E1.5**, is installed in the building, activation of the system must also initiate the *automatic*-closing operation.
- (b) A *window* in an *external wall* of a *fire-isolated stairway*, *fire-isolated passageway* or *fire-isolated ramp* must be protected in accordance with **C3.4** if it is within 6 m of, and exposed to, a *window* or other opening in a wall of the same building, other than in the same fire-isolated enclosure.

C3.9 Service penetrations in fire-isolated exits

Fire-isolated *exits* must not be penetrated by any services other than—

- (a) electrical wiring permitted by **D2.7(e)** to be installed within the *exit*; or
- (b) ducting associated with a pressurisation system if it—
 - (i) is constructed of material having an FRL of not less than $-/120/60$ where it passes through any other part of the building; and
 - (ii) does not open into any other part of the building; or
- (c) water supply pipes for fire services.

C3.10 Openings in fire-isolated lift shafts

- (a) **Doorways** — If a lift *shaft* is *required* to be fire-isolated, an entrance doorway to that *shaft* must be protected by $-/60/-$ fire doors that—
 - (i) comply with AS 1735.11; and
 - (ii) are set to remain closed except when discharging or receiving passengers, goods or vehicles.
- (b) **Lift indicator panels** — A lift call panel, indicator panel or other panel in the wall of a fire-isolated lift *shaft* must be backed by construction having an FRL of not less than $-/60/60$ if it exceeds 35 000 mm² in area.

C3.11 Bounding construction: Class 2 and 3 buildings and Class 4 parts

- (a) A doorway in a Class 2 or 3 building must be protected if it provides access from a *sole-occupancy unit* to—
 - (i) a *public corridor*, public lobby, or the like; or
 - (ii) a room not within a *sole-occupancy unit*; or
 - (iii) the landing of an internal non *fire-isolated stairway* that serves as a *required exit*; or
 - (iv) another *sole-occupancy unit*.
- (b) A doorway in a Class 2 or 3 building must be protected if it provides access from a room not within a *sole-occupancy unit* to—
 - (i) a *public corridor*, public lobby, or the like; or

Deemed-to-Satisfy Provisions

- (ii) the landing of an internal non *fire-isolated stairway* that serves as a *required exit*.
- (c) A doorway in a Class 4 part of a building must be protected if it provides access to any other internal part of the building.

NSW C3.11(d)

- (d) Protection for a doorway must be at least—
 - (i) in a building of Type A construction — a *self-closing* –/60/30 fire door; and
 - (ii) in a building of Type B or C construction — a *self-closing*, tight fitting, solid core door, not less than 35 mm thick,
 except—
 - (iii) in a Class 3 building used as a *residential aged care building* protected with a sprinkler system complying with **Specification E1.5**—
 - (A) a tight fitting, solid core door not less than 35 mm thick if the building is divided into *floor areas* not exceeding 500 m² with smoke proof walls complying with **Clause 2 of Specification C2.5**; or
 - (B) a tight fitting, solid core door not less than 35 mm thick fitted with a *self-closing* device, a delayed closing device or an *automatic* closing device.
- (e) Other openings in *internal walls* which are *required* to have an FRL with respect to *integrity* and *insulation* must not reduce the *fire-resisting* performance of the wall.
- (f) A door *required* by (d) may be *automatic*-closing in accordance with the following:
 - (i) The *automatic*-closing operation must be initiated by the activation of a smoke detector, or any other detector deemed suitable in accordance with AS 1670.1 if smoke detectors are unsuitable in the atmosphere, installed in accordance with the relevant provisions of AS 1670.1 and located not more than 1.5 m horizontal distance from the approach side of the doorway.
 - (ii) Where any other *required* suitable fire alarm system, including a sprinkler system complying with **Specification E1.5**, is installed in the building, activation of the system must also initiate the *automatic*-closing operation.
- (g) In a Class 2 or 3 building where a path of travel to an *exit* does not provide a person seeking egress with a choice of travel in different directions to alternative *exits* and is along an open balcony, landing or the like and passes an *external wall* of—
 - (i) another *sole-occupancy unit*; or
 - (ii) a room not within a *sole-occupancy unit*,
 then that *external wall* must—
 - (iii) be constructed of concrete or masonry, or be lined internally with a *fire-protective covering*; and
 - (iv) have any doorway fitted with a *self-closing*, tight-fitting solid core door not less than 35 mm thick; and
 - (v) have any *windows* or other openings—
 - (A) protected internally in accordance with **C3.4**; or
 - (B) located at least 1.5 m above the floor of the balcony, landing or the like.

NSW C3.11(h)

Deemed-to-Satisfy Provisions

C3.12 Openings in floors and ceilings for services

- (a) Where a service passes through—
 - (i) a floor that is *required* to have an FRL with respect to *integrity* and *insulation*; or
 - (ii) a ceiling *required* to have a *resistance to the incipient spread of fire*,
the service must be installed in accordance with **(b)**.
- (b) A service must be protected—
 - (i) in a building of Type A construction, by a *shaft* complying with **Specification C1.1**;
or
 - (ii) in a building of Type B or C construction, by a *shaft* that will not reduce the fire performance of the building elements it penetrates; or
 - (iii) in accordance with **C3.15**.
- (c) Where a service passes through a floor which is *required* to be protected by a *fire-protective covering*, the penetration must not reduce the fire performance of the covering.

C3.13 Openings in shafts

In a building of Type A construction, an opening in a wall providing access to a ventilating, pipe, garbage or other service *shaft* must be protected by—

- (a) if it is in a *sanitary compartment* — a door or panel which, together with its frame, is *non-combustible* or has an FRL of not less than –/30/30; or
- (b) a *self-closing* –/60/30 fire door or hopper; or
- (c) an access panel having an FRL of not less than –/60/30; or
- (d) if the *shaft* is a garbage *shaft* — a door or hopper of *non-combustible* construction.

C3.14 * * * * *

This clause has deliberately been left blank.

C3.15 Openings for service installations

Where an electrical, electronic, plumbing, mechanical ventilation, air-conditioning or other service penetrates a building element (other than an *external wall* or roof) that is *required* to have an FRL with respect to *integrity* or *insulation* or a *resistance to the incipient spread of fire*, that installation must comply with any one of the following:

- (a) **Tested systems**
 - (i) The service, building element and any protection method at the penetration are identical with a prototype assembly of the service, building element and protection method which has been tested in accordance with AS 4072.1 and AS 1530.4 and has achieved the *required* FRL or *resistance to the incipient spread of fire*.
 - (ii) It complies with **(i)** except for the *insulation* criteria relating to the service if—
 - (A) the service is a pipe system comprised entirely of metal (excluding pipe seals or the like); and

Deemed-to-Satisfy Provisions

- (B) any *combustible* building element is not located within 100 mm of the service for a distance of 2 m from the penetration; and
 - (C) *combustible* material is not able to be located within 100 mm of the service for a distance of 2 m from the penetration; and
 - (D) it is not located in a *required exit*.
- (b) **Ventilation and air-conditioning** — In the case of ventilating or air-conditioning ducts or equipment, the installation is in accordance with AS/NZS 1668.1.
- (c) **Compliance with Specification C3.15**
- (i) The service is a pipe system comprised entirely of metal (excluding pipe seals or the like) and is installed in accordance with **Specification C3.15** and it—
 - (A) penetrates a wall, floor or ceiling, but not a ceiling *required* to have a *resistance to the incipient spread of fire*; and
 - (B) connects not more than 2 *fire compartments* in addition to any *fire-resisting* service *shafts*; and
 - (C) does not contain a flammable or combustible liquid or gas.
 - (ii) The service is sanitary plumbing installed in accordance with **Specification C3.15** and it—
 - (A) is of metal or UPVC pipe; and
 - (B) penetrates the floors of a Class 5, 6, 7, 8 or 9b building; and
 - (C) is in a *sanitary compartment* separated from other parts of the building by walls with the FRL *required* by **Specification C1.1** for a stair *shaft* in the building and a *self-closing* –/60/30 fire door.
 - (iii) The service is a wire or cable, or a cluster of wires or cables installed in accordance with **Specification C3.15** and it—
 - (A) penetrates a wall, floor or ceiling, but not a ceiling *required* to have a *resistance to the incipient spread of fire*; and
 - (B) connects not more than 2 *fire compartments* in addition to any *fire-resisting* service *shafts*.
 - (iv) The service is an electrical switch, outlet, or the like, and it is installed in accordance with **Specification C3.15**.

C3.16 Construction joints

- (a) Construction joints, spaces and the like in and between building elements *required* to be *fire-resisting* with respect to *integrity* and *insulation* must be protected in a manner identical with a prototype tested in accordance with AS 1530.4 to achieve the *required* FRL.
- (b) The requirements of (a) do not apply where joints, spaces and the like between *fire-protected timber* elements are provided with cavity barriers in accordance with **Specification C1.13**.

Deemed-to-Satisfy Provisions

C3.17 Columns protected with lightweight construction to achieve an FRL

A column protected by *lightweight construction* to achieve an FRL which passes through a building element that is *required* to have an FRL or a *resistance to the incipient spread of fire*, must be installed using a method and materials identical with a prototype assembly of the construction which has achieved the *required* FRL or *resistance to the incipient spread of fire*.

SPECIFICATION **C1.1** FIRE-RESISTING CONSTRUCTION

Deemed-to-Satisfy Provisions

1. SCOPE

This Specification contains requirements for the *fire-resisting construction* of building elements.

2. GENERAL REQUIREMENTS

2.1 Exposure to fire-source features

- (a) A part of a building element is exposed to a *fire-source feature* if any of the horizontal straight lines between that part and the *fire-source feature*, or vertical projection of the feature, is not obstructed by another part of the building that—
 - (i) has an FRL of not less than 30/—/—; and
 - (ii) is neither transparent nor translucent.
- (b) A part of a building element is not exposed to a *fire-source feature* if the *fire-source feature* is—
 - (i) an *external wall* of another building that stands on the allotment and the part concerned is more than 15 m above the highest part of that *external wall*; or
 - (ii) a side or rear boundary of the allotment and the part concerned is below the level of the finished ground at every relevant part of the boundary concerned.
- (c) If various distances apply for different parts of a building element—
 - (i) the entire element must have the FRL applicable to that part having the least distance between itself and the relevant *fire-source feature*; or
 - (ii) each part of the element must have the FRL applicable according to its individual distance from the relevant *fire-source feature*,but this provision does not override or permit any exemption from **Clause 2.2**.

2.2 Fire protection for a support of another part

- (a) Where a part of a building *required* to have an FRL depends upon direct vertical or lateral support from another part to maintain its FRL, that supporting part, subject to **(b)**, must—
 - (i) have an FRL not less than that *required* by other provisions of this Specification; and
 - (ii) if located within the same *fire compartment* as the part it supports have an FRL in respect of *structural adequacy* the greater of that *required*—
 - (A) for the supporting part itself; and
 - (B) for the part it supports; and
 - (iii) be *non-combustible*—
 - (A) if *required* by other provisions of this Specification; or
 - (B) if the part it supports is *required* to be *non-combustible*.

Deemed-to-Satisfy Provisions

- (b) The following building elements need not comply with (a)(ii) and (a)(iii)(B):
- (i) An element providing lateral support to an *external wall* complying with **Clause 5.1(b)** or **C1.11**.
 - (ii) An element providing support within a *carpark* and complying with **Clause 3.9, 4.2** or **5.2**.
 - (iii) A roof providing lateral support in a building—
 - (A) of Type A construction if it complies with **Clause 3.5(a), (b)** or **(d)**; and
 - (B) of Type B and C construction.
 - (iv) A column providing lateral support to a wall where the column complies with **Clause 2.5(a)** and **(b)**.
 - (v) An element providing lateral support to a *fire wall* or *fire-resisting wall*, provided the wall is supported on both sides and failure of the element on one side does not affect the fire performance of the wall.

2.3 Lintels

A lintel must have the FRL *required* for the part of the building in which it is situated, unless it does not contribute to the support of a fire door, fire *window* or fire shutter, and—

- (a) it spans an opening in—
 - (i) a wall of a building containing only one *storey*; or
 - (ii) a non-*loadbearing* wall of a Class 2 or 3 building; or
- (b) it spans an opening in masonry which is not more than 150 mm thick and—
 - (i) not more than 3 m wide if the masonry is non-*loadbearing*; or
 - (ii) not more than 1.8 m wide if the masonry is *loadbearing* and part of a solid wall or one of the leaves of a cavity wall.

2.4 Attachments not to impair fire-resistance

- (a) A *combustible* material may be used as a finish or lining to a wall or roof, or in a sign, sunscreen or blind, awning, or other attachment to a building element which has the *required* FRL if—
 - (i) the material is exempted under **C1.10** or complies with the *fire hazard properties* prescribed in **Specification C1.10**; and
 - (ii) it is not located near or directly above a *required exit* so as to make the *exit* unusable in a fire; and
 - (iii) it does not otherwise constitute an undue risk of fire spread via the facade of the building.
- (b) The attachment of a facing or finish, or the installation of ducting or any other service, to a part of a building *required* to have an FRL must not impair the *required* FRL of that part.

2.5 General concessions

- (a) **Steel columns** — A steel column, other than one in a *fire wall* or *common wall*, need not have an FRL in a building that contains—

Deemed-to-Satisfy Provisions

- (i) only 1 *storey*; or
 - (ii) 2 *storeys* in some of its parts and 1 *storey* only in its remaining parts if the sum of the *floor areas* of the upper *storeys* of its 2 *storey* parts does not exceed the lesser of—
 - (A) 1/8 of the sum of the *floor areas* of the 1 *storey* parts; or
 - (B) in the case of a building to which one of the maximum *floor areas* specified in **Table C2.2** is applicable — 1/10 of that area; or
 - (C) in the case of a building to which two or more of the maximum *floor areas* specified in **Table C2.2** is applicable — 1/10 of the lesser of those areas.
- (b) **Timber columns** — A timber column may be used in a single *storey* building if—
- (i) in a *fire wall* or *common wall* the column has an FRL not less than that listed in the appropriate **Table 3, 4 or 5**; and
 - (ii) in any other case where the column is *required* to have an FRL in accordance with **Table 3, 4 or 5**, it has an FRL of not less than 30/–/–.
- (c) **Structures on roofs** — A *non-combustible* structure situated on a roof need not comply with the other provisions of this Specification if it only contains—
- (i) lift motor equipment; or
 - (ii) one or more of the following:
 - (A) Hot water or other water tanks.
 - (B) Ventilating ductwork, ventilating fans and their motors.
 - (C) Air-conditioning chillers.
 - (D) *Window* cleaning equipment.
 - (E) Other service units that are *non-combustible* and do not contain flammable or combustible liquids or gases.
- (d) **Curtain walls and panel walls** — A requirement for an *external wall* to have an FRL does not apply to a *curtain wall* or *panel wall* which is of *non-combustible* construction and fully protected by *automatic* external wall-wetting sprinklers.
- (e) * * * * *
- (f) **Balconies and verandahs** — A balcony, verandah or the like and any incorporated supporting part, which is attached to or forms part of a building, need not comply with **Tables 3, 4 and 5** if—
- (i) it does not form part of the only path of travel to a *required exit* from the building; and
 - (ii) in Type A construction—
 - (A) it is situated not more than 2 *storeys* above the lowest *storey* providing direct egress to a road or *open space*; and
 - (B) any supporting columns are of *non-combustible* construction.

Deemed-to-Satisfy Provisions

2.6 Mezzanine floors: Concession

- (a) This Clause does not apply to a Class 9b building that is a spectator stand or audience viewing area accommodating more than 100 persons as calculated according to **D1.13**.
- (b) A *mezzanine* and its supports need not have an FRL or be *non-combustible* provided—
 - (i) the total *floor area* of all the *mezzanines* in the same room does not exceed 1/3 of the *floor area* of the room or 200 m², whichever is the lesser; and
 - (ii) the FRL of each wall and column that supports any other part of the building within 6 m of the *mezzanine* is increased by the amount listed in **Table 2.6**.

Table 2.6 INCREASED FRLs — CONSTRUCTION SURROUNDING MEZZANINES

Level otherwise required for any FRL criterion (mins)	Increase in level to (not less than):
30	60
60	90
90	120
120	180
180	240

Note: The increase in level applies to each FRL criterion (*structural adequacy, integrity or insulation*) relevant to the building element concerned.

2.7 Enclosure of shafts

Shafts required to have an FRL must be enclosed at the top and bottom by construction having an FRL not less than that *required* for the walls of a *non-loadbearing shaft* in the same building, except that these provisions need not apply to—

- (a) the top of a *shaft* extending beyond the roof covering, other than one enclosing a *fire-isolated stairway* or *ramp*; or
- (b) the bottom of a *shaft* if it is *non-combustible* and laid directly on the ground.

2.8 Carparks in Class 2 and 3 buildings

- (a) If a Class 2 building contains not more than 4 *storeys* of which—
 - (i) one *storey* is Class 7 used solely for the purpose of parking motor vehicles or for some other purpose that is ancillary to a Class 2; and
 - (ii) the remaining *storeys* are of Class 2,
 the *carpark storey* is regarded as Class 2 only for the purpose of determining the relevant *fire-resisting* requirements of this Specification.
- (b) If a Class 3 building or a building of Class 2 and 3 contains not more than 3 *storeys* of which—
 - (i) one *storey* is Class 7 used solely for the purpose of parking motor vehicles or for some other purpose that is ancillary to the other *storeys*; and
 - (ii) the remaining *storeys* are of Class 2 or 3,

Deemed-to-Satisfy Provisions

the *carpark storey* is regarded as Class 2 or 3 only for the purpose of determining the relevant *fire-resisting* requirements of this Specification.

2.9 Residential aged care building: Concession

- (a) In a Class 3 building protected with a sprinkler system complying with **Specification E1.5** and used as a *residential aged care building*, any FRL criterion prescribed in **Tables 3, 4 or 5**—
 - (i) for any floor and any *loadbearing* wall, may be reduced to 60, except any FRL criterion of 90 for an *external wall* must be maintained when tested from the outside; and
 - (ii) for any non-*loadbearing internal wall*, need not apply if—
 - (A) it is lined on each side with standard grade plasterboard not less than 13 mm thick or similar *non-combustible* material; and
 - (B) it extends—
 - (aa) to the underside of the floor next above; or
 - (bb) to the underside of a ceiling lined with standard grade plasterboard not less than 13 mm thick or a material with at least an equivalent level of fire protection; or
 - (cc) to the underside of a *non-combustible* roof covering; and
 - (C) any insulation installed in the cavity of the wall is *non-combustible*; and
 - (D) any construction joint, space or the like between the top of the wall and the floor, ceiling or roof is smoke sealed with intumescent putty or other suitable material.
- (b) The concession described at (a) does not apply to *fire-protected timber* building elements.

3. TYPE A FIRE-RESISTING CONSTRUCTION

3.1 Fire-resistance of building elements

In a building *required* to be of Type A construction—

- (a) each building element listed in **Table 3** and any beam or column incorporated in it, must have an FRL not less than that listed in the Table for the particular Class of building concerned; and
- (b) *external walls, common walls* and the flooring and floor framing of lift pits must be *non-combustible*; and
- (c) any *internal wall required* to have an FRL with respect to *integrity* and *insulation* must extend to—
 - (i) the underside of the floor next above; or
 - (ii) the underside of a roof complying with **Table 3**; or
 - (iii) if under **Clause 3.5** the roof is not *required* to comply with **Table 3**, the underside of the *non-combustible* roof covering and, except for roof battens with dimensions of 75 mm x 50 mm or less or *sarking-type material*, must not be crossed by timber or other *combustible* building elements; or

Deemed-to-Satisfy Provisions

- (iv) a ceiling that is immediately below the roof and has a *resistance to the incipient spread of fire* to the roof space between the ceiling and the roof of not less than 60 minutes; and
- (d) a *loadbearing internal wall* and a *loadbearing fire wall* (including those that are part of a *loadbearing shaft*) must be constructed from—
 - (i) concrete; or
 - (ii) masonry; or
 - (iii) *fire-protected timber*, provided that—
 - (A) the building is a Class 2, 3 or 5 building which is—
 - (aa) a separate building; or
 - (bb) a part of a building—
 - (AA) which only occupies part of a *storey*, and is separated from the remaining part by a *fire wall*; or
 - (BB) which is located above or below a part not containing *fire-protected timber* and the floor between the adjoining parts is provided with an FRL not less than that prescribed for a *fire wall* for the lower *storey*; and
 - (B) the building has an *effective height* of not more than 25 m; and
 - (C) the building has a sprinkler system throughout complying with **Specification E1.5**; and
 - (D) any insulation installed in the cavity of the timber building element *required* to have an FRL is *non-combustible*; and
 - (E) cavity barriers are provided in accordance with **Specification C1.13**; or
 - (iv) any combination of (i) to (iii).
- (e) a non-*loadbearing*—
 - (i) *internal wall required* to be *fire-resisting*; and
 - (ii) lift, ventilating, pipe, garbage, or similar *shaft* that is not for the discharge of hot products of combustion,

must be of *non-combustible* construction; and
- (f) the FRLs specified in **Table 3** for an external column apply also to those parts of an internal column that face and are within 1.5 m of a *window* and are exposed through that *window* to a *fire-source feature*.

Deemed-to-Satisfy Provisions

Table 3 TYPE A CONSTRUCTION: FRL OF BUILDING ELEMENTS

Building element	Class of building — FRL: (in minutes)			
	<i>Structural adequacy/Integrity/Insulation</i>			
	2, 3 or 4 part	5, 7a or 9	6	7b or 8
EXTERNAL WALL (including any column and other building element incorporated therein) or other external building element, where the distance from any <i>fire-source feature</i> to which it is exposed is—				
For <i>loadbearing</i> parts—				
less than 1.5 m	90/ 90/ 90	120/120/120	180/180/180	240/240/240
1.5 to less than 3 m	90/ 60/ 60	120/ 90/ 90	180/180/120	240/240/180
3 m or more	90/ 60/ 30	120/ 60/ 30	180/120/ 90	240/180/ 90
For non- <i>loadbearing</i> parts—				
less than 1.5 m	–/ 90/ 90	–/120/120	–/180/180	–/240/240
1.5 to less than 3 m	–/ 60/ 60	–/ 90/ 90	–/180/120	–/240/180
3 m or more	–/–/–	–/–/–	–/–/–	–/–/–
EXTERNAL COLUMN not incorporated in an <i>external wall</i> —				
For <i>loadbearing</i> columns—				
	90/–/–	120/–/–	180/–/–	240/–/–
For non- <i>loadbearing</i> columns—				
	–/–/–	–/–/–	–/–/–	–/–/–
COMMON WALLS and FIRE WALLS—	90/ 90/ 90	120/120/120	180/180/180	240/240/240
INTERNAL WALLS—				
<i>Fire-resisting</i> lift and stair <i>shafts</i> —				
<i>Loadbearing</i>	90/ 90/ 90	120/120/120	180/120/120	240/120/120
Non- <i>loadbearing</i>	–/ 90/ 90	–/120/120	–/120/120	–/120/120
Bounding <i>public corridors</i> , public lobbies and the like—				
<i>Loadbearing</i>	90/ 90/ 90	120/–/–	180/–/–	240/–/–
Non- <i>loadbearing</i>	–/ 60/ 60	–/–/–	–/–/–	–/–/–
Between or bounding <i>sole-occupancy units</i> —				
<i>Loadbearing</i>	90/ 90/ 90	120/–/–	180/–/–	240/–/–
Non- <i>loadbearing</i>	–/ 60/ 60	–/–/–	–/–/–	–/–/–
Ventilating, pipe, garbage, and like <i>shafts</i> not used for the discharge of hot products of combustion—				
<i>Loadbearing</i>	90/ 90/ 90	120/ 90/ 90	180/120/120	240/120/120
Non- <i>loadbearing</i>	–/ 90/ 90	–/ 90/ 90	–/120/120	–/120/120

Deemed-to-Satisfy Provisions

Table 3 TYPE A CONSTRUCTION: FRL OF BUILDING ELEMENTS — continued

Building element	Class of building — FRL: (in minutes)			
	<i>Structural adequacy/Integrity/Insulation</i>			
	2, 3 or 4 part	5, 7a or 9	6	7b or 8
OTHER LOADBEARING INTERNAL WALLS, INTERNAL BEAMS, TRUSSES and COLUMNS—	90/–/–	120/–/–	180/–/–	240/–/–
FLOORS	90/ 90/ 90	120/120/120	180/180/180	240/240/240
ROOFS	90/ 60/ 30	120/ 60/ 30	180/ 60/ 30	240/ 90/ 60

3.2 Concessions for floors

A floor need not comply with **Table 3** if—

- (a) it is laid directly on the ground; or
- (b) in a Class 2, 3, 5 or 9 building, the space below is not a *storey*, does not accommodate motor vehicles, is not a storage or work area, and is not used for any other ancillary purpose; or
- (c) it is a timber *stage* floor in a Class 9b building laid over a floor having the *required* FRL and the space below the *stage* is not used as a dressing room, store room, or the like; or
- (d) it is within a *sole-occupancy unit* in a Class 2 or 3 building or Class 4 part of a building; or
- (e) it is an open-access floor (for the accommodation of electrical and electronic services and the like) above a floor with the *required* FRL.

3.3 Floor loading of Class 5 and 9b buildings: Concession

If a floor in a Class 5 or 9b building is designed for a live load not exceeding 3 kPa—

- (a) the floor next above (including floor beams) may have an FRL of 90/90/90; or
- (b) the roof, if that is next above (including roof beams) may have an FRL of 90/60/30.

3.4 Roof superimposed on concrete slab: Concession

A roof superimposed on a concrete slab roof need not comply with **Clause 3.1** as to *fire-resisting construction* if—

- (a) the superimposed roof and any construction between it and the concrete slab roof are *non-combustible* throughout; and
- (b) the concrete slab roof complies with **Table 3**.

3.5 Roof: Concession

A roof need not comply with **Table 3** if its covering is *non-combustible* and the building—

- (a) has a sprinkler system complying with **Specification E1.5** installed throughout; or
- (b) has a *rise in storeys* of 3 or less; or
- (c) is of Class 2 or 3; or

Deemed-to-Satisfy Provisions

- (d) has an *effective height* of not more than 25 m and the ceiling immediately below the roof has a *resistance to the incipient spread of fire* to the roof space of not less than 60 minutes.

3.6 Rooflights

If a roof is *required* to have an FRL or its covering is *required* to be *non-combustible*, rooflights or the like installed in that roof must—

- (a) have an aggregate area of not more than 20% of the roof surface; and
- (b) be not less than 3 m from—
 - (i) any boundary of the allotment other than the boundary with a road or public place; and
 - (ii) any part of the building which projects above the roof unless that part has the FRL *required* of a *fire wall* and any openings in that part of the wall for 6 m vertically above the rooflight or the like are protected in accordance with **C3.4**; and
 - (iii) any rooflight or the like in an adjoining *sole-occupancy unit* if the walls bounding the unit are *required* to have an FRL; and
 - (iv) any rooflight or the like in an adjoining fire-separated section of the building; and
- (c) if a ceiling with a *resistance to the incipient spread of fire* is *required*, be installed in a way that will maintain the level of protection provided by the ceiling to the roof space.

3.7 Internal columns and walls: Concession

For a building with an *effective height* of not more than 25 m and having a roof without an FRL in accordance with **Clause 3.5**, in the *storey* immediately below that roof, internal columns other than those referred to in **Clause 3.1(f)** and *internal walls* other than *fire walls* and *shaft walls* may have—

- (a) in a Class 2 or 3 building: FRL 60/60/60; or
- (b) in a Class 5, 6, 7, 8 or 9 building—
 - (i) with *rise in storeys* exceeding 3: FRL 60/60/60
 - (ii) with *rise in storeys* not exceeding 3: no FRL.

3.8 Open spectator stands and indoor sports stadiums: Concession

In an *open spectator stand* or indoor sports stadium, the following building elements need not have the FRL specified in **Table 3**:

- (a) The roof if it is *non-combustible*.
- (b) Columns and *loadbearing* walls supporting only the roof if they are *non-combustible*.
- (c) Any non-*loadbearing* part of an *external wall* less than 3 m—
 - (i) from any *fire-source feature* to which it is exposed if it has an FRL of not less than –/60/60 and is *non-combustible*; or
 - (ii) from an *external wall* of another *open spectator stand* if it is *non-combustible*.

Deemed-to-Satisfy Provisions

3.9 Carparks

- (a) Notwithstanding **Clause 3.1**, a *carpark* may comply with **Table 3.9** if it is an *open-deck carpark* or is protected with a sprinkler system complying with **Specification E1.5** and is—
- (i) a separate building; or
 - (ii) a part of a building—
 - (A) which only occupies part of a *storey*, and is separated from the remaining part by a *fire wall*; or
 - (B) which is located above or below another classification, and the floor separating the classifications complies with **C2.9**; or
 - (C) which is located above another Class 7 part of the building not used for carparking, and the floor separating the parts complies with **Table 3** for a Class 7 part other than a *carpark*; or
 - (D) which is located below another Class 7 part of the building not used for carparking, and the floor separating the parts complies with **Table 3.9**.
- (b) For the purposes of this Clause, a *carpark*—
- (i) includes—
 - (A) an administration area associated with the functioning of the *carpark*; and
 - (B) where the *carpark* is sprinklered, is associated with a Class 2 or 3 building and provides carparking for separate *sole-occupancy units*, each carparking area with an area not greater than 10% of its *floor area* for purposes ancillary to the *sole-occupancy units*; but
 - (ii) excludes—
 - (A) except for **(b)(i)**, any area of another classification, or other part of a Class 7 building not used for carparking; and
 - (B) a building or part of a building specifically intended for the parking of trucks, buses, vans and the like.

Deemed-to-Satisfy Provisions

Table 3.9 REQUIREMENTS FOR CARPARKS

Building element	FRL (not less than) <i>Structural adequacy/Integrity/Insulation</i> ESA/M (not greater than)
Wall	
(a) <i>external wall</i>	
(i) less than 3 m from a <i>fire-source feature</i> to which it is exposed:	
<i>Loadbearing</i>	60/60/60
<i>Non-loadbearing</i>	–/60/60
(ii) 3 m or more from a <i>fire-source feature</i> to which it is exposed	–/–/–
(b) <i>internal wall</i>	
(i) <i>loadbearing</i> , other than one supporting only the roof (not used for carparking)	60/–/–
(ii) supporting only the roof (not used for carparking)	–/–/–
(iii) <i>non-loadbearing</i>	–/–/–
(c) <i>fire wall</i>	
(i) from the direction used as a <i>carpark</i>	60/60/60
(ii) from the direction not used as a <i>carpark</i>	as <i>required</i> by Table 3
Column	
(a) supporting only the roof (not used for carparking) and 3 m or more from a <i>fire-source feature</i> to which it is exposed	–/–/–
(b) steel column, other than one covered by (a) and one that does not support a part of a building that is not used as a <i>carpark</i>	60/–/– or 26 m ² /tonne
(c) any other column not covered by (a) or (b)	60/–/–
Beam	
(a) steel floor beam in continuous contact with a concrete floor slab	60/–/– or 30 m ² /tonne
(b) any other beam	60/–/–

Deemed-to-Satisfy Provisions

Table 3.9 REQUIREMENTS FOR CARPARKS — *continued*

Building element	FRL (not less than) <i>Structural adequacy/Integrity/Insulation</i> ESA/M (not greater than)
Fire-resisting lift and stair shaft (within the <i>carpark</i> only)	60/60/60
Floor slab and vehicle ramp	60/60/60
Roof (not used for carparking)	-/-/-
Notes:	
1. ESA/M means the ratio of exposed surface area to mass per unit length.	
2. Refer to Specification E1.5 for special requirements for a sprinkler system in a <i>carpark</i> complying with Table 3.9 and located within a multi-classified building.	

3.10 Class 2 and 3 buildings: Concession

- (a) A Class 2 or 3 building having a *rise in storeys* of not more than 3 need not comply with **Clauses 3.1(b), (d) and (e)** of **Specification C1.1** and the requirement of **C2.6** for *non-combustible* material, if it is constructed using—
 - (i) timber framing throughout; or
 - (ii) *non-combustible* material throughout; or
 - (iii) a combination of (i) and (ii),
provided—
 - (iv) * * * * *
 - (v) any insulation installed in the cavity of a wall *required* to have an FRL is *non-combustible*; and
 - (vi) the building is fitted with an *automatic* smoke alarm system complying with **Specification E2.2a**.

- (b) A Class 2 or 3 building having a *rise in storeys* of not more than 4 may have the top three *storeys* constructed in accordance with (a) provided—
 - (i) the lowest *storey* is used solely for the purpose of parking motor vehicles or for some other ancillary purpose; and
 - (ii) the lowest *storey* is constructed of concrete or masonry including the floor between it and the Class 2 or 3 part of the building above; and
 - (iii) the lowest *storey* and the *storey* above are separated by construction having an FRL of not less than 90/90/90 with no openings or penetrations that would reduce the *fire-resisting* performance of that construction except that a doorway in that construction may be protected by a -/60/30 *self-closing* fire door.

- (c) In a Class 2 or 3 building complying with (a) or (b) and fitted with a sprinkler system complying with **Specification E1.5**, any FRL criterion prescribed in **Table 3—**

Deemed-to-Satisfy Provisions

- (i) for any floor and any *loadbearing* wall, may be reduced to 60, except any FRL criterion of 90 for an *external wall* must be maintained when tested from the outside; and
- (ii) for any non-*loadbearing internal wall*, need not apply if—
 - (A) it is lined on each side with 13 mm standard grade plasterboard or similar *non-combustible* material; and
 - (B) it extends—
 - (aa) to the underside of the floor next above; or
 - (bb) to the underside of a ceiling with a *resistance to the incipient spread of fire* of 60 minutes; or
 - (cc) to the underside of a *non-combustible* roof covering; and
 - (C) any insulation installed in the cavity of the wall is *non-combustible*; and
 - (D) any construction joint, space or the like between the top of the wall and the floor, ceiling or roof is smoke sealed with intumescent putty or other suitable material; and
 - (E) any doorway in the wall is protected by a *self-closing*, tight fitting, solid core door not less than 35 mm thick.

4. TYPE B FIRE-RESISTING CONSTRUCTION

4.1 Fire-resistance of building elements

In a building *required* to be of Type B construction—

- (a) each building element listed in **Table 4**, and any beam or column incorporated in it, must have an FRL not less than that listed in the Table for the particular Class of building concerned; and
- (b) the *external walls*, *common walls*, and the flooring and floor framing in any lift pit, must be *non-combustible*; and
- (c) if a stair *shaft* supports any floor or a structural part of it—
 - (i) the floor or part must have an FRL of 60/–/– or more; or
 - (ii) the junction of the stair *shaft* must be constructed so that the floor or part will be free to sag or fall in a fire without causing structural damage to the *shaft*; and
- (d) any *internal wall* which is *required* to have an FRL with respect to *integrity* and *insulation*, except a wall that bounds a *sole-occupancy unit* in the topmost (or only) *storey* and there is only one unit in that *storey*, must extend to—
 - (i) the underside of the floor next above if that floor has an FRL of at least 30/30/30; or
 - (ii) the underside of a ceiling having a *resistance to the incipient spread of fire* to the space above itself of not less than 60 minutes; or
 - (iii) the underside of the roof covering if it is *non-combustible* and, except for roof battens with dimensions of 75 mm x 50 mm or less or *sarking-type material*, must not be crossed by timber or other *combustible* building elements; or

Deemed-to-Satisfy Provisions

- (iv) 450 mm above the roof covering if it is *combustible*; and
- (e) a *loadbearing internal wall* and a *loadbearing fire wall* (including those that are part of a *loadbearing shaft*) must be constructed from—
 - (i) concrete; or
 - (ii) masonry; or
 - (iii) *fire-protected timber*, provided that—
 - (A) the building is a Class 2, 3 or 5 building which is—
 - (aa) a separate building; or
 - (bb) a part of a building—
 - (AA) which only occupies part of a *storey*, and is separated from the remaining part by a *fire wall*; or
 - (BB) which is located above or below a part not containing *fire-protected timber* and the floor between the adjoining parts is provided with an FRL not less than that prescribed for a *fire wall* for the lower *storey*; and
 - (B) the building has an *effective height* of not more than 25 m; and
 - (C) the building has a sprinkler system throughout complying with **Specification E1.5**; and
 - (D) any insulation installed in the cavity of the timber building element *required* to have an FRL is *non-combustible*; and
 - (E) cavity barriers are provided in accordance with **Specification C1.13**; or
 - (iv) any combination of (i) to (iii).
- (f) a non-*loadbearing internal wall required* to be *fire-resisting* must be of *non-combustible* construction; and
- (g) in a Class 5, 6, 7, 8 or 9 building, in the *storey* immediately below the roof, internal columns and *internal walls* other than *fire walls* and *shaft* walls, need not comply with **Table 4**; and
- (h) lift, subject to **C2.10**, ventilating, pipe, garbage, and similar *shafts* which are not for the discharge of hot products of combustion and not *loadbearing*, must be of *non-combustible* construction in—
 - (i) a Class 2, 3 or 9 building; and
 - (ii) a Class 5, 6, 7 or 8 building if the *shaft* connects more than 2 *storeys*; and
- (i) in a Class 2 or 3 building, except where within the one *sole-occupancy unit*, or a Class 9a *health-care building* or a Class 9b building, a floor separating *storeys* or above a space for the accommodation of motor vehicles or used for storage or any other ancillary purpose, must—
 - (i) be constructed so that it is at least of the standard achieved by a floor/ceiling system incorporating a ceiling which has a *resistance to the incipient spread of fire* to the space above itself of not less than 60 minutes; or
 - (ii) have an FRL of at least 30/30/30; or

Deemed-to-Satisfy Provisions

- (iii) have a *fire-protective covering* on the underside of the floor, including beams incorporated in it, if the floor is *combustible* or of metal; and
- (j) in a Class 9c building a floor above a space for the accommodation of motor vehicles or used for storage or any other ancillary purpose, and any column supporting the floor must—
 - (i) be constructed so that it is at least of the standard achieved by a floor/ceiling system incorporating a ceiling which has a *resistance to the incipient spread of fire* to the space above itself of not less than 60 minutes; or
 - (ii) have an FRL of at least 30/30/30; or
 - (iii) have a *fire-protective covering* on the underside of the floor, including beams incorporated in it, if the floor is *combustible* or of metal.

Table 4 TYPE B CONSTRUCTION: FRL OF BUILDING ELEMENTS

Building element	Class of building—FRL: (in minutes)			
	<i>Structural adequacy/Integrity/Insulation</i>			
	2, 3 or 4 part	5, 7a or 9	6	7b or 8
EXTERNAL WALL (including any column and other building element incorporated therein) or other external building element, where the distance from any <i>fire-source feature</i> to which it is exposed is—				
For <i>loadbearing</i> parts—				
less than 1.5 m	90/ 90/ 90	120/120/120	180/180/180	240/240/240
1.5 to less than 3 m	90/ 60/ 30	120/ 90/ 60	180/120/ 90	240/180/120
3 to less than 9 m	90/ 30/ 30	120/ 30/ 30	180/ 90/ 60	240/ 90/ 60
9 to less than 18 m	90/ 30/—	120/ 30/—	180/ 60/—	240/ 60/—
18 m or more	—/—/—	—/—/—	—/—/—	—/—/—
For non- <i>loadbearing</i> parts—				
less than 1.5 m	—/ 90/ 90	—/120/120	—/180/180	—/240/240
1.5 to less than 3 m	—/ 60/ 30	—/ 90/ 60	—/120/ 90	—/180/120
3 m or more	—/—/—	—/—/—	—/—/—	—/—/—
EXTERNAL COLUMN not incorporated in an <i>external wall</i> , where the distance from any <i>fire-source feature</i> to which it is exposed is—				
For <i>loadbearing</i> columns—				
less than 18 m	90/—/—	120/—/—	180/—/—	240/—/—
18 m or more	—/—/—	—/—/—	—/—/—	—/—/—
For non- <i>loadbearing</i> columns—				
	—/—/—	—/—/—	—/—/—	—/—/—
COMMON WALLS and FIRE WALLS—	90/ 90 / 90	120/120/120	180/180/180	240/240/240

Deemed-to-Satisfy Provisions

Table 4 TYPE B CONSTRUCTION: FRL OF BUILDING ELEMENTS — continued

Building element	Class of building—FRL: (in minutes)			
	<i>Structural adequacy/Integrity/Insulation</i>			
	2, 3 or 4 part	5, 7a or 9	6	7b or 8
INTERNAL WALLS—				
<i>Fire-resisting lift and stair shafts—</i>				
<i>Loadbearing</i>	90/ 90/ 90	120/120/120	180/120/120	240/120/120
<i>Fire-resisting stair shafts—</i>				
<i>Non-loadbearing</i>	–/ 90/ 90	–/120/120	–/120/120	–/120/120
Bounding <i>public corridors</i> , public lobbies and the like—				
<i>Loadbearing</i>	60/ 60/ 60	120/–/–	180/–/–	240/–/–
<i>Non-loadbearing</i>	–/ 60/ 60	–/–/–	–/–/–	–/–/–
Between or bounding <i>sole-occupancy units—</i>				
<i>Loadbearing</i>	60/ 60/ 60	120/–/–	180/–/–	240/–/–
<i>Non-loadbearing</i>	–/ 60/ 60	–/–/–	–/–/–	–/–/–
OTHER LOADBEARING INTERNAL WALLS				
and COLUMNS—	60/–/–	120/–/–	180/–/–	240/–/–
ROOFS	–/–/–	–/–/–	–/–/–	–/–/–

4.2 Carparks

- (a) Notwithstanding **Clause 4.1**, a *carpark* may comply with **Table 4.2** if it is an *open-deck carpark* or is protected with a sprinkler system complying with **Specification E1.5** and is—
 - (i) a separate building; or
 - (ii) a part of a building, and if occupying only part of a *storey*, is separated from the remaining part by a *fire wall*.
- (b) For the purposes of this Clause, a *carpark*—
 - (i) includes—
 - (A) an administration area associated with the functioning of the *carpark*; and
 - (B) where the *carpark* is sprinklered, is associated with a Class 2 or 3 building and provides carparking for separate *sole-occupancy units*, each carparking area with an area not greater than 10% of its *floor area* for purposes ancillary to the *sole-occupancy units*; but
 - (ii) excludes—
 - (A) except for **(b)(i)**, any area of another classification, or other part of a Class 7 building not used for carparking; and
 - (B) a building or part of a building specifically intended for the parking of trucks, buses, vans and the like.

Deemed-to-Satisfy Provisions

Table 4.2 REQUIREMENTS FOR CARPARKS

Building element	FRL (not less than) <i>Structural adequacy/Integrity/Insulation</i> ESA/M (not greater than)
Wall	
(a) <i>external wall</i>	
(i) less than 3 m from a <i>fire-source feature</i> to which it is exposed:	
<i>Loadbearing</i>	60/60/60
<i>Non-loadbearing</i>	–/60/60
(ii) 3 m or more from a <i>fire-source feature</i> to which it is exposed	–/–/–
(b) <i>internal wall</i>	
(i) <i>loadbearing</i> , other than one supporting only the roof (not used for carparking)	60/–/–
(ii) supporting only the roof (not used for carparking)	–/–/–
(iii) <i>non-loadbearing</i>	–/–/–
(c) <i>fire wall</i>	
(i) from the direction used as a <i>carpark</i>	60/60/60
(ii) from the direction not used as a <i>carpark</i>	as <i>required</i> by Table 4
Column	
(a) supporting only the roof (not used for carparking) and 3 m or more from a <i>fire-source feature</i> to which it is exposed	–/–/–
(b) steel column, other than one covered by (a)	60/–/– or 26 m ² /tonne
(c) any other column not covered by (a) or (b)	60/–/–
Beam	
(a) less than 3 m from a <i>fire-source feature</i> :	
(i) steel floor beam in continuous contact with a concrete floor slab	60/–/– or 30 m ² /tonne
(ii) any other beam	60/–/–
(b) 3 m or more from a <i>fire-source feature</i>	–/–/–
Lift shaft	–/–/–
Fire-resisting stair shaft (within the <i>carpark</i> only)	60/60/60
Roof, floor slab and vehicle ramp	–/–/–
Note: ESA/M means the ratio of exposed surface area to mass per unit length.	

Deemed-to-Satisfy Provisions

4.3 Class 2 and 3 buildings: Concession

- (a) A Class 2 or 3 building having a *rise in storeys* of not more than 2 need not comply with **Clause 4.1(b), (e), (f) and (h)** of **Specification C1.1** if it is constructed using—
 - (i) timber framing throughout; or
 - (ii) *non-combustible* material throughout; or
 - (iii) a combination of **(i)** and **(ii)**,
provided—
 - (iv) * * * * *
 - (v) any insulation installed in the cavity of a wall *required* to have an FRL is *non-combustible*; and
 - (vi) the building is fitted with an *automatic* smoke alarm system complying with **Specification E2.2a**.

- (b) A Class 2 or 3 building having a *rise in storeys* of not more than 2 may have the top *storey* constructed in accordance with **(a)** provided—
 - (i) the lowest *storey* is used solely for the purpose of parking motor vehicles or for some other ancillary purpose; and
 - (ii) the lowest *storey* is constructed of concrete or masonry including the floor between it and the Class 2 or 3 part of the building above; and
 - (iii) the lowest *storey* and the *storey* above are separated by construction having an FRL of not less than 90/90/90 with no openings or penetrations that would reduce the *fire-resisting* performance of that construction except that a doorway in that construction may be protected by a –/60/30 *self-closing* fire door.

- (c) In a Class 2 or 3 building complying with **(a)** or **(b)** and fitted with a sprinkler system complying with **Specification E1.5**, any FRL criterion prescribed in **Table 4**—
 - (i) for any *loadbearing* wall, may be reduced to 60, except any FRL criterion of 90 for an *external wall* must be maintained when tested from the outside; and
 - (ii) for any non-*loadbearing internal wall*, need not apply, if—
 - (A) it is lined on both sides with 13 mm standard grade plasterboard or similar *non-combustible* material; and
 - (B) it extends—
 - (aa) to the underside of the floor next above if that floor has an FRL of at least 30/30/30 or is lined on the underside with a *fire-protective covering*; or
 - (bb) to the underside of a ceiling with a *resistance to the incipient spread of fire* of 60 minutes; or
 - (cc) to the underside of a *non-combustible* roof covering; and
 - (C) any insulation installed in the cavity of the wall is *non-combustible*; and

Deemed-to-Satisfy Provisions

- (D) any construction joints, spaces and the like between the top of the wall and the floor, ceiling or roof is smoke sealed with intumescent putty or other suitable material.

5. TYPE C FIRE-RESISTING CONSTRUCTION

5.1 Fire-resistance of building elements

In a building *required* to be of Type C construction—

- (a) a building element listed in **Table 5** and any beam or column incorporated in it, must have an FRL not less than that listed in the Table for the particular Class of building concerned; and
- (b) an *external wall* that is *required* by **Table 5** to have an FRL need only be tested from the outside to satisfy the requirement; and
- (c) a *fire wall* or an *internal wall* bounding a *sole-occupancy unit* or separating adjoining units must comply with **Specification C1.8** if it is of *lightweight construction* and is *required* to have an FRL; and
- (d) in a Class 2 or 3 building, an *internal wall* which is *required* by **Table 5** to have an FRL must extend—
 - (i) to the underside of the floor next above if that floor has an FRL of at least 30/30/30 or a *fire-protective covering* on the underside of the floor; or
 - (ii) to the underside of a ceiling having a *resistance to the incipient spread of fire* to the space above itself of not less than 60 minutes; or
 - (iii) to the underside of the roof covering if it is *non-combustible*, and except for roof battens with dimensions of 75 mm x 50 mm or less or *sarking-type material*, must not be crossed by timber or other *combustible* building elements; or
 - (iv) 450 mm above the roof covering if it is *combustible*; and
- (e) in a Class 2 or 3 building, except where within the one *sole-occupancy unit*, or a Class 9a *health-care building*, or a Class 9b building, a floor separating *storeys*, or above a space for the accommodation of motor vehicles or used for storage or any other ancillary purpose, and any column supporting the floor, must—
 - (i) have an FRL of at least 30/30/30; or
 - (ii) have a *fire-protective covering* on the underside of the floor including beams incorporated in it and around the column, if the floor or column is *combustible* or of metal; and
- (f) in a Class 9c building a floor above a space for the accommodation of motor vehicles or used for storage or any other ancillary purpose, and any column supporting the floor, must—
 - (i) have an FRL of at least 30/30/30; or
 - (ii) have a *fire-protective covering* on the underside of the floor including beams incorporated in it and around the column, if the floor or column is *combustible* or of metal.

Deemed-to-Satisfy Provisions

Table 5 TYPE C CONSTRUCTION: FRL OF BUILDING ELEMENTS

Building element	Class of building—FRL: (in minutes)			
	<i>Structural adequacy/Integrity/Insulation</i>			
	2, 3 or 4 part	5, 7a or 9	6	7b or 8
EXTERNAL WALL (including any column and other building element incorporated therein) or other external building element, where the distance from any <i>fire-source feature</i> to which it is exposed is—				
Less than 1.5 m	90/ 90/ 90	90/ 90/ 90	90/ 90/ 90	90/ 90/ 90
1.5 to less than 3 m	-/-/-	60/ 60/ 60	60/ 60/ 60	60/ 60/ 60
3 m or more	-/-/-	-/-/-	-/-/-	-/-/-
EXTERNAL COLUMN not incorporated in an <i>external wall</i> , where the distance from any <i>fire-source feature</i> to which it is exposed is—				
Less than 1.5 m	90/-/-	90/-/-	90/-/-	90/-/-
1.5 to less than 3 m	-/-/-	60/-/-	60/-/-	60/-/-
3 m or more	-/-/-	-/-/-	-/-/-	-/-/-
COMMON WALLS and FIRE WALLS—	90/ 90/ 90	90/ 90/ 90	90/ 90/ 90	90/ 90/ 90
INTERNAL WALLS-				
Bounding <i>public corridors</i> , public lobbies and the like—	60/ 60/ 60	-/-/-	-/-/-	-/-/-
Between or bounding <i>sole-occupancy units</i> —	60/ 60/ 60	-/-/-	-/-/-	-/-/-
Bounding a stair if <i>required</i> to be rated—	60/ 60/ 60	60/ 60/ 60	60/ 60/ 60	60/ 60/ 60
ROOFS	-/-/-	-/-/-	-/-/-	-/-/-

5.2 Carparks

- (a) Notwithstanding **Clause 5.1**, a *carpark* may comply with **Table 5.2** if it is an *open-deck carpark* or is protected with a sprinkler system complying with **Specification E1.5** and is—
 - (i) a separate building; or
 - (ii) a part of a building, and if occupying only part of a *storey*, is separated from the remaining part by a *fire wall*.
- (b) For the purposes of this Clause, a *carpark*—
 - (i) includes—
 - (A) an administration area associated with the functioning of the *carpark*; and
 - (B) where the *carpark* is sprinklered, is associated with a Class 2 or 3 building and provides carparking for separate *sole-occupancy units*,

Deemed-to-Satisfy Provisions

each carparking area with an area not greater than 10% of its *floor area* for purposes ancillary to the *sole-occupancy units*; but

- (ii) excludes—
 - (A) except for **(b)(i)**, any area of another classification, or other part of a Class 7 building not used for carparking; and
 - (B) a building or part of a building specifically intended for the parking of trucks, buses, vans and the like.

Table 5.2 REQUIREMENTS FOR CARPARKS

Building element	FRL (not less than) <i>Structural adequacy/Integrity/Insulation</i> ESA/M (not greater than)
Wall	
(a) <i>external wall</i>	
(i) less than 1.5 m from a <i>fire-source feature</i> to which it is exposed:	
<i>Loadbearing</i>	60/60/60
<i>Non-loadbearing</i>	–/60/60
(ii) 1.5 m or more from a <i>fire-source feature</i> to which it is exposed	–/–/–
(b) <i>internal wall</i>	–/–/–
(c) <i>fire wall</i>	
(i) from the direction used as a <i>carpark</i>	60/60/60
(ii) from the direction not used as a <i>carpark</i>	90/90/90
Column	
(a) steel column less than 1.5 m from a <i>fire-source feature</i>	60/–/– or 26 m ² /tonne
(b) any other column less than 1.5 m from a <i>fire-source feature</i>	60/–/–
(c) any other column not covered by (a) or (b)	–/–/–
Beam	
(a) less than 1.5 m from a <i>fire-source feature</i>	
(i) steel floor beam in continuous contact with a concrete floor slab	60/–/– or 30 m ² /tonne
(ii) any other beam	60/–/–
(b) 1.5 m or more from a <i>fire-source feature</i>	–/–/–
Roof, floor slab and vehicle ramp	–/–/–

Note: ESA/M means the ratio of exposed surface area to mass per unit length.

SPECIFICATION **C1.8** STRUCTURAL TESTS FOR
LIGHTWEIGHT CONSTRUCTION

Deemed-to-Satisfy Provisions

1. Scope

This Specification describes tests to be applied to and criteria to be satisfied by a wall system of *lightweight construction*.

2. Application

A wall system need not be tested in accordance with this Specification for static pressure or impact if it is designed and constructed in accordance with the *Deemed-to-Satisfy Provisions* of **Section B** to resist the appropriate pressures and impacts defined in this Specification.

3. Tests

3.1 Walls of certain Class 9b buildings

Lightweight construction forming—

- (a) a wall of a lift *shaft* and stair *shaft*; and
- (b) an *external* and *internal wall* bounding a *public corridor*, public lobby or the like, including a *fire-isolated* and non *fire-isolated passageway* or *ramp*, in a spectator stand, sports stadium, cinema or theatre, railway or bus station or airport terminal, must be subjected to the following tests and must fulfil the following criteria:
 - (i) The materials tests of **Clause 5(a)** and the criteria of **Clause 6(a)**.
 - (ii) A static test by the imposition of a uniformly distributed load of 1.0 kPa (or its equivalent) in accordance with **Clause 5(b)** and the damage and deflection criteria of **Clauses 6(b)** and **(c)** respectively.
 - (iii) A dynamic test by the fall of the impact bag through a height of 350 mm in accordance with **Clause 5(c)** and the damage and deflection criteria of **Clauses 6(b)** and **(d)** respectively.
 - (iv) The surface indentation test of **Clause 5(d)** and the surface indentation criterion of **Clause 6(e)**.

3.2 Walls of shafts and fire-isolated exits generally

A wall of *lightweight construction* that is *required* to be *fire-resisting* and which bounds a lift *shaft*, stair *shaft*, or service *shaft*, *fire-isolated passageway* or *fire-isolated ramp* must be subjected to the following tests and must fulfil the following criteria:

- (a) The materials tests of **Clause 5(a)** and the criteria of **Clause 6(a)**.
- (b) A static test by the imposition of a uniformly distributed load of 0.35 kPa (or its equivalent) in accordance with **Clause 5(b)** and the damage and deflection criteria of **Clauses 6(b)** and **(c)** respectively.
- (c) A dynamic test by the fall of the impact bag through a height of 150 mm in accordance with **Clause 5(c)** and the damage and deflection criteria of **Clauses 6(b)** and **(d)** respectively.

Deemed-to-Satisfy Provisions

- (d) The surface indentation test of **Clause 5(d)** and the surface indentation criterion of **Clause 6(e)**.

3.3 Additional requirements for lift shafts

- (a) In addition to the requirements of **Clauses 3.1** and **3.2**, a wall system for use in a lift *shaft* that is *required* to be *fire-resisting* must be subjected to dynamic test by the imposition of—
 - (i) where the lift car speed is 7 m/s or less — 10⁶ cycles of a uniformly distributed load between 0 and 0.2 kPa (or its equivalent); or
 - (ii) where the lift car speed is greater than 7 m/s — 10⁶ cycles of a uniformly distributed load between 0 and 0.35 kPa (or its equivalent) in accordance with **Clause 5(e)** and must fulfil the damage criteria of **Clause 6(b)**.
- (b) The wall system must be subjected to the static test in accordance with **Clause 3.2(b)** after the successful conclusion of the dynamic test specified in (a).

3.4 Walls generally

An *external* and *internal wall* of *lightweight construction* that is *required* to be *fire-resisting*, other than one covered by **Clauses 3.1**, **3.2** or **3.3**, must be subjected to the following tests and must fulfil the following criteria:

- (a) The materials tests of **Clause 5(a)** and the criteria of **Clause 6(a)**.
- (b) A static test by the imposition of a uniformly distributed load of 0.25 kPa (or its equivalent) in accordance with **Clause 5(b)** and the damage and deflection criteria of **Clauses 6(b)** and (c) respectively.
- (c) A dynamic test by fall of the impact bag through a height of 100 mm in accordance with **Clause 5(c)** and the damage and deflection criteria of **Clauses 6(b)** and (d) respectively.
- (d) The surface indentation test of **Clause 5(d)** and the surface indentation criterion of **Clause 6(e)**.

4. Test specimens

4.1 General

Testing must be carried out on either—

- (a) construction in-situ; or
- (b) a laboratory specimen of the construction.

4.2 Testing in-situ

If testing is carried out in-situ, it must be done on that part of the construction least likely, because of the particular combination of the height of the walls, the support conditions and other aspects of the construction, to resist the loads.

4.3 Testing of specimens

If a laboratory specimen is tested, the specimen must span only in the direction corresponding to the height of the wall and testing must be done in accordance with either (a) or (b) below:

Deemed-to-Satisfy Provisions

- (a)
 - (i) The height of the test specimen (or length, if the specimen is tested horizontally) must be identical with the height between supports in the actual construction; and
 - (ii) the specimen must be supported at the top and bottom (or at each end if tested horizontally) by components identical with, and in a manner identical with, the actual construction.
- (b) If the distance between supports of the actual construction is more than 3 m, then a smaller specimen may be tested but—
 - (i) the distance between supports must be not less than 3 m; and
 - (ii) forces, reactions and support conditions must be modelled so as to reproduce the behaviour of the actual construction if it were tested in-situ.

5. Test methods

Tests must be carried out in accordance with the following:

- (a) **Material tests** — The methods specified for the constituent materials of the construction of the standards adopted by reference in the BCA.
- (b) **For resistance to static pressure** — The provisions for testing walls under transverse load in ASTM E72-80, except that—
 - (i) support conditions must be as specified in **Clause 4.3**; and
 - (ii) equivalent load shall mean the quarter-point load that produces the same deflection or central moment as appropriate.
- (c) **For resistance to impact** — The provisions for testing wall systems in ASTM E695-79, except that—
 - (i) the point of impact must be set 1.5 m above finished floor level or 1.5 m above the part of the specimen that corresponds to finished floor level; and
 - (ii) the impact bag must be not less than 225 mm in diameter and not more than 260 mm in diameter and have a mass of not less than 27.2 or more than 27.3 kg; and
 - (iii) the mass must be achieved by putting loose, dry sand into the bag and must be adjusted before each series of impact tests; and
 - (iv) where the impact bag and suspension cannot be vertical at the instant of impact on a curved surface or an inclined surface, the height of drop is the net height at the point of impact.
- (d) **For resistance to surface indentation** — The test for resistance to surface indentation must be carried out at three points on the surface of an undamaged sample sheet as follows:
 - (i) A steel ball of 10 mm diameter with a load of 150 N must be placed gently on the surface of the sheet and allowed to remain in position for 5 minutes.
 - (ii) The ball and load must then be removed and the diameter of each impression of the ball on the surface measured.
- (e) **For resistance of lift shaft construction to repetitive load** — As for **5(b)** except that—

Deemed-to-Satisfy Provisions

- (i) it is sufficient to test one specimen with the pressure applied from the side of the construction on which the lift will operate; and
- (ii) the load must be applied dynamically at a frequency not less than 1 Hz and not more than 3 Hz; and
- (iii) equivalent load shall mean the quarter-point load that produces the same central moment as the distributed load.

6. Criteria for compliance

The wall system or the specimen of it must fulfil the following criteria:

- (a) **Materials** — Materials must comply with the applicable standard adopted by reference in the BCA.
- (b) **Damage** — There must be no crack, penetration or permanent surface-deformation to a depth of more than 0.5 mm or any other non-elastic deformation or fastener failure.
- (c) **Deflection — Static pressure** — Under static pressure the deflection must not be more than—
 - (i) 1/240th of the height between supports; or
 - (ii) for construction other than a lift *shaft* — 30 mm; or
 - (iii) for a lift *shaft* — 20 mm.
- (d) **Deflection — Impact** — Under impact the instantaneous deflection must not be more than—
 - (i) 1/120th of the height of the wall between supports; or
 - (ii) for construction other than a lift *shaft* — 30 mm; or
 - (iii) for a lift *shaft* — 20 mm.
- (e) **Surface indentation** — No impression must be more than 5 mm in diameter.

SPECIFICATION **C1.10** FIRE HAZARD PROPERTIES

Deemed-to-Satisfy Provisions

1. Scope

This Specification sets out requirements in relation to the *fire hazard properties* of linings, materials and assemblies in Class 2 to 9 buildings as set out in **Table 1**.

2. Application

Linings, materials and assemblies in Class 2 to 9 buildings must comply with the appropriate provisions described in **Table 1**.

Table 1 FIRE HAZARD PROPERTY REQUIREMENTS

Lining, material or assembly	Requirement
Floor linings and floor coverings.	Clause 3
Wall linings and ceiling linings.	Clause 4
Air-handling ductwork.	Clause 5
Lift cars.	Clause 6
In fire control rooms subject to Specification E1.8 and fire isolated <i>exits</i>	Clause 7
In Class 9b buildings used as a theatre, public hall or the like— (a) fixed seating in the audience area or auditorium; and (b) a proscenium curtain <i>required</i> by Specification H1.3 .	
Escalators, moving walkways and non- <i>required</i> non- <i>fire-isolated stairways</i> or pedestrian ramps subject to Specification D1.12 .	
<i>Sarking-type material</i> .	
Attachments to internal floors, walls and ceilings.	
Other materials including Insulation.	

3. Floor linings and floor coverings

A floor lining or floor covering must have—

- (a) a *critical radiant flux* not less than that listed in **Table 2**; and
- (b) in a building not protected by a sprinkler system complying with **Specification E1.5**, a maximum *smoke development rate* of 750 percent-minutes; and
- (c) a group number complying with **Clause 6(b)**, for any portion of the floor covering that is continued more than 150 mm up a wall.

Deemed-to-Satisfy Provisions

Table 2 CRITICAL RADIANT FLUX (CRF in kW/m²) OF FLOOR MATERIALS AND FLOOR COVERINGS

Class of building	General		Fire-isolated exits and fire control rooms
	Building not fitted with a sprinkler system complying with Specification E1.5	Building fitted with a sprinkler system complying with Specification E1.5	
Class 2, 3, 5, 6, 7, 8 or 9b, excluding— (i) Class 3 accommodation for the aged; and (ii) Class 9b as specified below.	2.2	1.2	2.2
Class 3 Accommodation for the aged.	4.5	2.2	4.5
Class 9a <i>Patient care areas.</i>	4.5	2.2	4.5
Areas other than <i>patient care areas.</i>	2.2	1.2	4.5
Class 9b auditorium or audience seating area used mainly for— (i) indoor swimming or ice skating; and (ii) other sports or multi-purpose functions.	1.2 2.2	1.2 1.2	2.2 2.2
Class 9c <i>Resident use areas.</i>	—	2.2	4.5
Areas other than <i>resident use areas.</i>	—	1.2	4.5

4. Wall and ceiling linings

- (a) A wall or ceiling lining system must comply with the *group number* specified in **Table 3** and for buildings not fitted with a sprinkler system complying with **Specification E1.5** have—
- (i) a *smoke growth rate index* not more than 100; or
 - (ii) an *average specific extinction area* less than 250 m²/kg.
- (b) A *group number* of a wall or ceiling lining and the *smoke growth rate index* or *average specific extinction area* must be determined in accordance with AS 5637.1.

Deemed-to-Satisfy Provisions

Table 3 WALL AND CEILING LINING MATERIALS (Material Groups permitted)

Class of building	Fire-isolated exits and fire control rooms	Public corridors		Specific areas		Other areas
	Wall/ceiling	Wall	Ceiling	Wall	Ceiling	Wall/ceiling
Class 2 or 3 Excluding accommodation for the aged, people with disabilities, and children						
Unsprinklered	1	1, 2	1, 2	1, 2, 3	1, 2, 3	1, 2, 3
Sprinklered	1	1, 2, 3	1, 2, 3	1, 2, 3	1, 2, 3	1, 2, 3
Class 3 or 9a Accommodation for the aged, people with a disability, children and <i>health-care buildings</i>						
Unsprinklered	1	1	1	1, 2	1, 2	1, 2, 3
Sprinklered	1	1, 2	1, 2	1, 2, 3	1, 2, 3	1, 2, 3
Class 5, 6, 7, 8 or 9b <i>schools</i>						
Unsprinklered	1	1, 2	1, 2	1, 2, 3	1, 2	1, 2, 3
Sprinklered	1	1, 2, 3	1, 2, 3	1, 2, 3	1, 2, 3	1, 2, 3
Class 9b other than <i>schools</i>						
Unsprinklered	1	1	1	1, 2	1, 2	1, 2, 3
Sprinklered	1	1, 2	1, 2	1, 2, 3	1, 2, 3	1, 2, 3
Class 9c						
Sprinklered	1	1, 2	1, 2	1, 2, 3	1, 2, 3	1, 2, 3
For the purpose of this Table—						
1. "Sprinklered" means a building fitted with a sprinkler system complying with Specification E1.5 .						
2. "Specific areas" means within—						
(a) for Class 2 and 3 buildings, a <i>sole-occupancy unit</i> ; and						
(b) for Class 5 buildings, open plan offices with a minimum floor dimension/floor to ceiling height ratio > 5; and						
(c) for Class 6 buildings, shops or other building with a minimum floor dimension/floor to ceiling height ratio > 5; and						
(d) for Class 9a <i>health-care buildings, patient care areas</i> ; and						
(e) for Class 9b theatres and halls, etc, an auditorium; and						
(f) for Class 9b <i>schools</i> , a classroom; and						
(g) for Class 9c buildings, <i>resident use areas</i> .						

5. Air-handling ductwork

Rigid and flexible ductwork in a Class 2 to 9 building must comply with the *fire hazard properties* set out in AS 4254 Parts 1 and 2.

Deemed-to-Satisfy Provisions

6. Lift cars

Materials used as—

- (a) floor linings and floor coverings must have a *critical radiant flux* not less than 2.2; and
- (b) wall and ceiling linings must be a Group 1 material or a Group 2 material in accordance with AS 5637.1.

7. Other materials

NSW Spec C1.10 NSW 7

Materials and assemblies in a Class 2 to 9 building not included in **Clauses 3, 4, 5** or **6** must not exceed the indices set out in **Table 4**.

Table 4 OTHER MATERIALS

Material or assembly location	Flammability Index	Spread-of-Flame Index	Smoke-Developed Index
Fire control rooms subject to Specification E1.8 and fire-isolated <i>exits</i> , other than a <i>sarking-type material</i> used in a ceiling or used as an attachment or part of an attachment to a building element. <small>Note 1</small>	—	0	2
Class 9b buildings used as a theatre, public hall or the like:			
(a) Any part of fixed seating in the audience area or auditorium.	—	0	5
(b) A proscenium curtain <i>required</i> by Specification H1.3 .	—	0	3
Escalators, moving walkways or non- <i>required</i> non- <i>fire-isolated stairways</i> or pedestrian ramps subject to Specification D1.12 .	—	0	5
<i>Sarking-type material</i> :			
(a) In a fire control room subject to Specification E1.8 or a fire-isolated <i>exit</i> or fire control room used in the form of an exposed wall or ceiling.	0	—	—
(b) In other locations. <small>Note 2</small>	5	—	—
Other materials or locations and insulation materials other than <i>sarking-type materials</i> . <small>Notes 2 and 3</small>	—	9	8 if the <i>Spread-of-Flame Index</i> is more than 5

Notes:

1. In a fire control room or *fire-isolated stairway*, a material used as an attachment or part of an attachment to a building element must, if *combustible*, be attached directly to a *non-combustible* substrate and not exceed 1 mm finished thickness.

Deemed-to-Satisfy Provisions

Table 4 OTHER MATERIALS— continued

Material or assembly location	Flammability Index	Spread-of-Flame Index	Smoke-Developed Index
<p>2. A material, other than one located within a fire-isolated <i>exit</i> or fire control room, may be covered on all faces by concrete or masonry not less than 50 mm thick, as an alternative to meeting the specified indices.</p> <p>3. In the case of a composite member or assembly, the member or assembly must be constructed so that when assembled as proposed in a building—</p> <p style="margin-left: 20px;">(a) any material which does not comply with this Table is protected on all sides and edges from exposure to the air; and</p> <p style="margin-left: 20px;">(b) the member or assembly, when tested in accordance with Specification A2.4, has a <i>Spread-of-Flame Index</i> and a <i>Smoke-Developed Index</i> not exceeding those prescribed in this Table; and</p> <p style="margin-left: 20px;">(c) the member or assembly retains the protection in position so that it prevents ignition of the material and continues to screen it from access to free air for a period of not less than 10 minutes.</p>			

SPECIFICATION C1.11 PERFORMANCE OF EXTERNAL WALLS IN FIRE

Deemed-to-Satisfy Provisions

1. Scope

This Specification contains measures to minimise, in the event of fire, the likelihood of *external walls* covered by **Clause 2** collapsing outwards as complete panels and the likelihood of panels separating from supporting members.

2. Application

This Specification applies to buildings having a *rise in storeys* of not more than 2 with concrete *external walls* that could collapse as complete panels (e.g. tilt-up and precast concrete) which—

- (a) consist of either single or multiple panels attached by steel connections to lateral supporting members; and
- (b) depend on those connections to resist outward movement of the panels relative to the supporting members; and
- (c) have height to thickness ratio not greater than 50.

3. General requirements for external wall panels

- (a) Cast-in inserts and fixings must be anchored into the panel with welded bars or be fixed to the panel reinforcement.
- (b) Cast-in inserts for top connections and fixings acting together must be able to resist an ultimate load of two times the larger of the forces *required* to develop—
 - (i) the ultimate bending moment capacity of the panel at its base; or
 - (ii) the overturning moment at the base of the panel arising from an outwards lateral displacement at the top of the panel equal to one tenth of the panel height.
- (c) Top connections of the panel exposed to fire, such as clips and drilled-in inserts, acting together must be able to resist an ultimate load of six times the larger of the forces *required* to develop the moment specified in **(b)(i)** or **(ii)**.

Note.

The increased forces specified by use of the multiplier of two or six in **(b)** and **(c)** above are to take account of the lower strength of the connections and members at the higher than ambient temperatures expected in a fire.

- (d) Lateral supporting members and their connections must be designed to resist the connection forces specified in **(b)** and **(c)** and in the case of an eaves tie member the force in the member must be determined assuming that it deforms in a manner compatible with the lateral displacement of the wall panels, and that it acts in tension only.
- (e) *External wall* panels that span vertically must have at least two upper connections per panel to the supporting member, except that where a number of panels are designed to

Deemed-to-Satisfy Provisions

act as one unit, (e.g. tongue and groove hollow-core panels), only two upper connections are *required* for each unit.

- (f) *External wall* panels that span horizontally between columns must have at least two connections at each column.
- (g) Connections providing lateral support to a panel must be designed to remain engaged to the supported panel both before and during a fire.

4. Additional requirements for vertically spanning external wall panels adjacent to columns

- (a) Where vertically spanning *external wall* panels are located adjacent to columns, connections to the panels must be located and/or detailed to minimise forces that may develop between the panels and columns arising from the restraint of differential displacement.
- (b) The requirements of (a) are satisfied by—
 - (i) detailing the connections and/or the supporting member to sustain a relative outward displacement of (d) between the panels and columns at the connection height where d(m) is calculated as—
 - (A) the square of the connection height (m) divided by one hundred and twenty-five, when the connection height is less than 5 m; or
 - (B) the connection height (m) divided by twenty-five, when the connection height (m) is greater than or equal to 5 m; or
 - (ii) in situations where an eaves tie member is used to provide lateral support to *external wall* panels, the tie member is connected to the panels no closer than a distance (s) from the column where s(m) is taken as one quarter of the panel height (m).

SPECIFICATION C1.13 CAVITY BARRIERS FOR FIRE-PROTECTED TIMBER

Deemed-to-Satisfy Provisions

1. Scope

This Specification sets out requirements for cavity barriers in *fire-protected timber* construction.

2. Requirements

- (a) Cavity barriers must be provided in the following locations where *fire-protected timber* is used in any of the listed elements:
- (i) At concealed cavities adjacent to junctions between *fire-resisting* floor/ceiling assemblies and *fire-resisting* walls.
 - (ii) At concealed cavities adjacent to junctions between *fire-resisting* floor/ceiling assemblies and *fire-resisting* or *non-combustible external walls*.
 - (iii) At concealed cavities adjacent to junctions between *fire-resisting* walls and *fire-resisting* or *non-combustible external walls*.
 - (iv) Around the perimeter of door and window openings in *fire-resisting* construction.
- (b) Cavity barriers must be installed so they are tight fitting and are able to withstand thermal expansion and structural movement without the loss of seal against fire and smoke.
- (c) In addition to cavity barriers *required* by **Clause 2(a)**, horizontal and vertical cavity barriers are to be provided to wall cavities within, around or adjacent to *fire-protected timber* elements as follows:
- (i) Horizontal cavity barriers — at not more than 5 m centres.
 - (ii) Vertical cavity barriers — at not more than 10 m centres.
- (d) Cavity barriers must—
- (i) achieve the performance specified in **Table 1** based on the highest FRL of the elements they are mounted within or seal against; or
 - (ii) consist of—
 - (A) timber with the minimum thickness specified in **Table 1**; or
 - (B) polythene-sleeved mineral wool or mineral wool slabs or strips placed under compression to achieve the minimum thickness specified in **Table 1**.
- (e) Cavity barriers provided around openings may be formed by the window or door frame if—
- (i) the frame is constructed of steel or timber with the minimum thickness specified in **Table 1** for timber; and
 - (ii) the frame is tightly fitted to rigid construction and mechanically fixed in position.
- (f) The FRL of cavity barriers in *fire-protected timber* construction must be determined in accordance with **Specification A2.3** applying the criteria for control joint systems

Deemed-to-Satisfy Provisions

specified in Section 10 of AS 1530.4 with the cavity barrier system fitted within an opening between timber members exposed directly to the furnace heating conditions.

- (g) Notwithstanding anything to the contrary in **Specification A2.3** or AS 1530.4, the test results from (f) may be used when the *fire-protected timber* is constructed from timber having a nominal density at least equal to the tested timber.

Table 1 CAVITY BARRIER FRLs

System <i>Required</i> FRL	-/60/60	-/90/90	-/120/120
Cavity barrier <i>required</i> FRL	-/45/45	-/45/45	-/60/60
Timber, <i>required</i> minimum thickness	45 mm	45 mm	55 mm
Mineral wool, <i>required</i> minimum thickness	45 mm	45 mm	60 mm

Note: Minimum thicknesses are to be measured in the direction of heat flow.

SPECIFICATION **C2.5** SMOKE-PROOF WALLS IN HEALTH-CARE AND AGED CARE BUILDINGS

Deemed-to-Satisfy Provisions

1. Scope

This Specification sets out requirements for the construction of smoke-proof walls in Class 9a *health-care buildings* and Class 9c buildings. Smoke proof walls *required* to have an FRL are to be in accordance with **Clause A2.3**.

2. Class 9a health-care buildings

Smoke-proof walls *required* by **C2.5** in Class 9a *health-care buildings* must comply with the following:

- (a) Be *non-combustible* and extend to the underside of—
 - (i) the floor above; or
 - (ii) a *non-combustible* roof covering; or
 - (iii) a ceiling having a *resistance to the incipient spread of fire* to the space above itself of not less than 60 minutes.
- (b) Not incorporate any glazed areas unless the glass is safety glass as defined in AS 1288.
- (c) Only have doorways which are fitted with smoke doors complying with **Specification C3.4**.
- (d) Have all openings around penetrations and the junctions of the smoke-proof wall and the remainder of the building stopped with *non-combustible* material to prevent the free passage of smoke.
- (e) Incorporate smoke dampers where air-handling ducts penetrate the wall unless the duct forms part of a smoke hazard management system *required* to continue air movement through the duct during a fire.

3. Class 9c buildings

Smoke-proof walls *required* by **C2.5** in Class 9c buildings must comply with the following:

- (a) The wall may be lined on one side only.
- (b) Linings on the wall must be *non-combustible* and extend to the underside of—
 - (i) the floor above; or
 - (ii) a *non-combustible* roof covering; or
 - (iii) a flush plasterboard ceiling lined with 13 mm standard grade plasterboard or a *fire-protective covering*, with all penetrations sealed against the free passage of smoke.
- (c) If plasterboard is used in the lining on a wall, it must be a minimum of 13 mm standard grade plasterboard.
- (d) Not incorporate any glazed areas unless the glass is safety glass as defined in AS 1288.

Deemed-to-Satisfy Provisions

- (e) Only have doorways which are fitted with smoke doors complying with **Specification C3.4**.
- (f) Have all openings around penetrations and the junctions of the smoke-proof wall and the remainder of the building stopped with *non-combustible* material to prevent the free passage of smoke.
- (g) Incorporate smoke dampers where air-handling ducts penetrate the wall unless the duct forms part of a smoke hazard management system *required* to continue air movement through the duct during a fire.

4. Doorways in smoke-proof walls

A door *required* by **C2.5** or this Specification to be smoke-proof or have an FRL, other than one that serves a *fire compartment* provided with a zone smoke control system in accordance with AS/NZS 1668.1, must provide a smoke reservoir by not extending within 400 mm of the underside of—

- (a) a roof covering; or
- (b) the floor above; or
- (c) an imperforate false ceiling that will prevent the free passage of smoke.

SPECIFICATION **C3.4** FIRE DOORS, SMOKE DOORS, FIRE WINDOWS AND SHUTTERS

Deemed-to-Satisfy Provisions

1. SCOPE

This Specification sets out requirements for the construction of fire doors, smoke doors, fire *windows* and fire shutters.

2. FIRE DOORS

A *required* fire door must—

- (a) comply with AS 1905.1; and
- (b) not fail by radiation through any glazed part during the period specified for *integrity* in the *required* FRL.

3. SMOKE DOORS

3.1 General requirements

Smoke doors must be constructed so that smoke will not pass from one side of the doorway to the other and, if they are glazed, there is minimal danger of a person being injured by accidentally walking into them.

3.2 Construction deemed-to-satisfy

A smoke door of one or two leaves satisfies **Clause 3.1** if it is constructed as follows:

- (a) The leaves are side-hung to swing—
 - (i) in the direction of egress; or
 - (ii) in both directions.
- (b)
 - (i) The leaves are capable of resisting smoke at 200°C for 30 minutes.
 - (ii) Solid-core leaves at least 35 mm thick satisfy **(i)**.
- (c) The leaves are fitted with smoke seals.
- (d)
 - (i) The leaves are normally in the closed position; or
 - (ii)
 - (A) The leaves are closed *automatically* with the *automatic* closing operation initiated by smoke detectors, installed in accordance with the relevant provisions of AS 1670.1, located on each side of the doorway not more than 1.5 m horizontal distance from the doorway; and

Deemed-to-Satisfy Provisions

- (B) in the event of power failure to the door, the leaves fail-safe in the closed position.
- (e) The leaves return to the fully closed position after each manual opening.
- (f) Any glazing incorporated in the door complies with AS 1288.
- (g)
 - (i) If a glazed panel is capable of being mistaken for an unobstructed *exit*, the presence of the glass must be identified by opaque construction.
 - (ii) An opaque mid-height band, mid-rail or crash bar satisfies (i).

4. FIRE SHUTTERS

A *required* fire shutter must—

- (a) be a shutter that—
 - (i) is identical with a tested prototype that has achieved the *required* FRL; and
 - (ii) is installed in the same manner and in an opening that is not larger than the tested prototype; and
 - (iii) did not have a rise in average temperature on the side remote from the furnace of more than 140 K during the first 30 minutes of the test; or
- (b) be a steel shutter complying with AS 1905.2 if a metallic fire shutter is not prohibited by **C3.5**.

5. FIRE WINDOWS

A *required* fire *window* must be—

- (a) identical in construction with a prototype that has achieved the *required* FRL; and
- (b) installed in the same manner and in an opening that is not larger than the tested prototype.

SPECIFICATION C3.15 PENETRATION OF WALLS, FLOORS AND CEILINGS BY SERVICES

Deemed-to-Satisfy Provisions

1. Scope

This Specification prescribes materials and methods of installation for services that penetrate walls, floors and ceilings *required* to have an FRL.

2. Application

- (a) This Specification applies to installations permitted under the *Deemed-to-Satisfy Provisions* of the BCA as alternatives to systems that have been demonstrated by test to fulfil the requirements of **C3.15(a)**.
- (b) This Specification does not apply to installations in ceilings *required* to have a *resistance to the incipient spread of fire* nor to the installation of piping that contains or is intended to contain a flammable liquid or gas.

3. Metal pipe systems

- (a) A pipe system comprised entirely of metal (excluding pipe seals or the like) that is not normally filled with liquid must not be located within 100 mm, for a distance of 2 m from the penetration, of any *combustible* building element or a position where *combustible* material may be located, and must be constructed of—
 - (i) copper alloy or stainless steel with a wall thickness of at least 1 mm; or
 - (ii) cast iron or steel (other than stainless steel) with a wall thickness of at least 2 mm.
- (b) An opening for a pipe system comprised entirely of metal (excluding pipe seals or the like) must—
 - (i) be neatly formed, cut or drilled; and
 - (ii) be no closer than 200 mm to any other service penetration; and
 - (iii) accommodate only one pipe.
- (c) A pipe system comprised entirely of metal (excluding pipe seals or the like) must be wrapped but must not be lagged or enclosed in thermal insulation over the length of its penetration of a wall, floor or ceiling unless the lagging or thermal insulation fulfils the requirements of **Clause 7**.
- (d) The gap between a metal pipe and the wall, floor or ceiling it penetrates must be fire-stopped in accordance with **Clause 7**.

4. Pipes penetrating sanitary compartments

If a pipe of metal or UPVC penetrates the floor of a *sanitary compartment* in accordance with **C3.15(c)(ii)**—

- (a) the opening must be neatly formed and no larger than is necessary to accommodate the pipe or fitting; and

Deemed-to-Satisfy Provisions

- (b) the gap between pipe and floor must be fire-stopped in accordance with **Clause 7**.

5. Wires and cables

If a wire or cable or cluster of wires or cables penetrates a floor, wall or ceiling—

- (a) the opening must be neatly formed, cut or drilled and no closer than 50 mm to any other service; and
- (b) the opening must be no larger in cross-sectional area than—
- (i) 2000 mm² if only a single cable is accommodated and the gap between cable and wall, floor or ceiling is no wider than 15 mm; or
 - (ii) 500 mm² in any other case; and
- (c) the gap between the service and the wall, floor or ceiling must be fire-stopped in accordance with **Clause 7**.

6. Electrical switches and outlets

If an electrical switch, outlet, socket or the like is accommodated in an opening or recess in a wall, floor or ceiling—

- (a) the opening or recess must not—
- (i) be located opposite any point within 300 mm horizontally or 600 mm vertically of any opening or recess on the opposite side of the wall; or
 - (ii) extend beyond half the thickness of the wall; and
- (b) the gap between the service and the wall, floor or ceiling must be fire-stopped in accordance with **Clause 7**.

7. Fire-stopping

- (a) **Material:** The material used for the fire-stopping of service penetrations must be concrete, high-temperature mineral fibre, high-temperature ceramic fibre or other material that does not flow at a temperature below 1120°C when tested in accordance with ISO 540, and must have—
- (i) demonstrated in a system tested in accordance with **C3.15(a)** that it does not impair the *fire-resisting* performance of the building element in which it is installed; or
 - (ii) demonstrated in a test in accordance with **(e)** that it does not impair the *fire-resisting* performance of the test slab.
- (b) **Installation:** Fire-stopping material must be packed into the gap between the service and wall, floor or ceiling in a manner, and compressed to the same degree, as adopted for testing under **Clause 7(a)(i)** or **(ii)**.
- (c) **Hollow construction:** If a pipe penetrates a hollow wall (such as a stud wall, a cavity wall or a wall of hollow blockwork) or a hollow floor/ceiling system, the cavity must be so framed and packed with fire-stopping material that is—
- (i) installed in accordance with **Clause 7(b)** to a thickness of 25 mm all round the service for the full length of the penetration; and

Deemed-to-Satisfy Provisions

- (ii) restrained, independently of the service, from moving or parting from the surfaces of the service and of the wall, floor or ceiling.
- (d) **Recesses:** If an electrical switch, socket, outlet or the like is accommodated in a recess in a hollow wall or hollow floor/ceiling system—
- (i) the cavity immediately behind the service must be framed and packed with fire-stopping material in accordance with **Clause 7(c)**; or
 - (ii) the back and sides of the service must be protected with refractory lining board identical with and to the same thickness as that in which the service is installed.
- (e) **Test:** The test to demonstrate compliance of a fire-stopping material with this Specification must be conducted as follows:
- (i) The test specimen must comprise a concrete slab not less than 1 m square and not more than 100 mm thick, and appropriately reinforced if necessary for *structural adequacy* during manufacture, transport and testing.
 - (ii) The slab must have a hole 50 mm in diameter through the centre and the hole must be packed with the fire-stopping material.
 - (iii) The slab must be conditioned in accordance with AS 1530.4.
 - (iv) Two thermocouples complying with AS 1530.4 must be attached to the upper surface of the packing each about 5 mm from its centre.
 - (v) The slab must be tested on flat generally in accordance with Section 10 of AS 1530.4 and must achieve an FRL of 60/60/60 or as otherwise *required*.

SECTION **D**

ACCESS AND EGRESS

- D1** **Provision for Escape**
- D2** **Construction of Exits**
- D3** **Access for People with a Disability**

SECTION D CONTENTS

SECTION D ACCESS AND EGRESS

Section D Access and Egress

Performance Requirements DP1 - DP9
Verification Methods DV1

Part D1 Provision for Escape

- D1.0 Deemed-to-Satisfy Provisions
- D1.1 Application of Part
- D1.2 Number of exits required
- D1.3 When fire-isolated stairways and ramps are required
- D1.4 Exit travel distances
- D1.5 Distance between alternative exits
- D1.6 Dimensions of exits and paths of travel to exits
- D1.7 Travel via fire-isolated exits
- D1.8 External stairways or ramps in lieu of fire-isolated exits
- D1.9 Travel by non-fire-isolated stairways or ramps
- D1.10 Discharge from exits
- D1.11 Horizontal exits
- D1.12 Non-required stairways, ramps or escalators
- D1.13 Number of persons accommodated
- D1.14 Measurement of distances
- D1.15 Method of measurement
- D1.16 Plant rooms, lift machine rooms and electricity network substations:
Concession
- D1.17 Access to lift pits

Part D2 Construction of Exits

- D2.0 Deemed-to-Satisfy Provisions
- D2.1 Application of Part
- D2.2 Fire-isolated stairways and ramps
- D2.3 Non-fire-isolated stairways and ramps
- D2.4 Separation of rising and descending stair flights
- D2.5 Open access ramps and balconies
- D2.6 Smoke lobbies
- D2.7 Installations in exits and paths of travel
- D2.8 Enclosure of space under stairs and ramps
- D2.9 Width of required stairways and ramps
- D2.10 Pedestrian ramps
- D2.11 Fire-isolated passageways
- D2.12 Roof as open space
- D2.13 Goings and risers
- D2.14 Landings
- D2.15 Thresholds
- D2.16 Barriers to prevent falls

- D2.17 Handrails
- D2.18 Fixed platforms, walkways, stairways and ladders
- D2.19 Doorways and doors
- D2.20 Swinging doors
- D2.21 Operation of latch
- D2.22 Re-entry from fire-isolated exits
- D2.23 Signs on doors
- D2.24 Protection of openable windows
- D2.25 Timber stairways: Concession

Part D3 Access for People with a Disability

- D3.0 Deemed-to-Satisfy Provisions
- D3.1 General building access requirements
- D3.2 Access to buildings
- D3.3 Parts of buildings to be accessible
- D3.4 Exemptions
- D3.5 Accessible carparking
- D3.6 Signage
- D3.7 Hearing augmentation
- D3.8 Tactile indicators
- D3.9 Wheelchair seating spaces in Class 9b assembly buildings
- D3.10 Swimming pools
- D3.11 Ramps
- D3.12 Glazing on an accessway

Specifications

- Specification D1.12 Non-Required Stairways, Ramps and Escalators
- Specification D3.6 Braille and Tactile Signs
- Specification D3.10 Accessible Water Entry/Exit for Swimming Pools

SECTION D ACCESS AND EGRESS

PERFORMANCE REQUIREMENTS

ACT DP0.1—0.5

DP1

Access must be provided, to the degree necessary, to enable—

- (a) people to—
 - (i) approach the building from the road boundary and from any *accessible* carparking spaces associated with the building; and
 - (ii) approach the building from any *accessible* associated building; and
 - (iii) access work and public spaces, accommodation and facilities for personal hygiene; and
- (b) identification of *accessways* at appropriate locations which are easy to find.

Limitation:

DP1 does not apply to a Class 4 part of a building.

DP2

So that people can move safely to and within a building, it must have—

- (a) walking surfaces with safe gradients; and
- (b) any doors installed to avoid the risk of occupants—
 - (i) having their egress impeded; or
 - (ii) being trapped in the building; and
- (c) any stairways and ramps with—
 - (i) slip-resistant walking surfaces on—
 - (A) ramps; and
 - (B) stairway treads or near the edge of the nosing; and
 - (ii) suitable handrails where necessary to assist and provide stability to people using the stairway or ramp; and
 - (iii) suitable landings to avoid undue fatigue; and
 - (iv) landings where a door opens from or onto the stairway or ramp so that the door does not create an obstruction; and
 - (v) in the case of a stairway, suitable safe passage in relation to the nature, volume and frequency of likely usage.

DP3

Where people could fall—

- (a) 1 m or more—
 - (i) from a floor or roof or through an opening (other than through an openable window) in the *external wall* of a building; or
 - (ii) due to a sudden change of level within or associated with a building; or
- (b) 2 m or more from a floor through an openable window—
 - (i) in a bedroom in a Class 2 or 3 building or a Class 4 part of a building; or
 - (ii) in a Class 9b *early childhood centre*; or
- (c) 4 m or more from a floor through an openable window not covered by (b), a barrier must be provided which must be—
- (d) continuous and extend for the full extent of the hazard; and
- (e) of a height to protect people from accidentally falling from the floor or roof or through the opening or openable window; and
- (f) constructed to prevent people from falling through the barrier; and
- (g) capable of restricting the passage of children; and
- (h) of strength and rigidity to withstand—
 - (i) the foreseeable impact of people; and
 - (ii) where appropriate, the static pressure of people pressing against it.

Limitations:

DP3 does not apply where such a barrier would be incompatible with the intended use of an area such as a stage, loading dock or the like.

DP3(g) does not apply to—

- (a) *fire-isolated stairways*, *fire-isolated ramps*, and other areas used primarily for emergency purposes, excluding external stairways and external ramps; and
- (b) Class 7 (other than *carparks*) and Class 8 buildings and parts of buildings containing those classes.

DP4

Exits must be provided from a building to allow occupants to evacuate safely, with their number, location and dimensions being appropriate to—

- (a) the travel distance; and
- (b) the number, mobility and other characteristics of occupants; and
- (c) the function or use of the building; and
- (d) the height of the building; and
- (e) whether the *exit* is from above or below ground level.

DP5

To protect evacuating occupants from a fire in the building *exits* must be fire-isolated, to the degree necessary, appropriate to—

- (a) the number of *storeys* connected by the *exits*; and
- (b) the *fire safety system* installed in the building; and
- (c) the function or use of the building; and
- (d) the number of *storeys* passed through by the *exits*; and
- (e) *fire brigade* intervention.

DP6

So that occupants can safely evacuate the building, paths of travel to *exits* must have dimensions appropriate to—

- (a) the number, mobility and other characteristics of occupants; and
- (b) the function or use of the building.

Limitation:

DP6 does not apply to the internal parts of a *sole-occupancy unit* in a Class 2 or 3 building or Class 4 part of a building.

DP7

Where a lift is intended to be used in addition to the *required exits* to assist occupants to evacuate a building safely, the type, number, location and fire-isolation must be appropriate to—

- (a) the travel distance to the lift; and
- (b) the number, mobility and other characteristics of occupants; and
- (c) the function or use of the building; and
- (d) the number of *storeys* connected by the lift; and
- (e) the *fire safety system* installed in the building; and
- (f) the waiting time, travel time and capacity of the lift; and
- (g) the reliability and availability of the lift; and
- (h) the emergency procedures for the building.

DP8

Carparking spaces for use by people with a disability must be—

- (a) provided, to the degree necessary, to give equitable access for carparking; and
- (b) designated and easy to find.

Limitation:

DP8 does not apply to a building where—

- (a) a parking service is provided; and
- (b) direct access to any carparking spaces by the general public or occupants is not available.

DP9

An inbuilt communication system for entry, information, entertainment, or for the provision of a service, must be suitable for occupants who are deaf or hearing impaired.

Limitation:

DP9 does not apply to—

- (a) a Class 4 part of a building; or
- (b) an inbuilt communication system used only for emergency warning purposes.

Tas DP10

VERIFICATION METHODS

DV1 Wire barriers

Compliance with **DP3(f)** and **(g)** for wire barriers is verified when the wire barrier passes the test described below:

(a) Application

The test must be carried out on either—

- (i) a prototype of a wire barrier that is identical to that proposed to be installed on-site; or
- (ii) a wire barrier installed on-site.

(b) Test equipment

The test equipment must consist of the following:

- (i) A horizontally suspended 125 mm diameter, 405 mm long cylinder of 1 mm thick steel having a highly polished 105 mm long cone at one end with a 20 mm diameter flat leading edge to which an eye bolt is fixed.
- (ii) A sufficiently flexible horizontal cable with mechanisms capable of applying and measuring a tension of 150 N (or a 15.3 kg weight suspended over a low friction pulley) is to be attached to the eye bolt (see **Figure DV1**).
- (iii) A mechanism capable of measuring the tension force applied to each wire.

Figure DV1

APPARATUS FOR TESTING WIRE BARRIERS

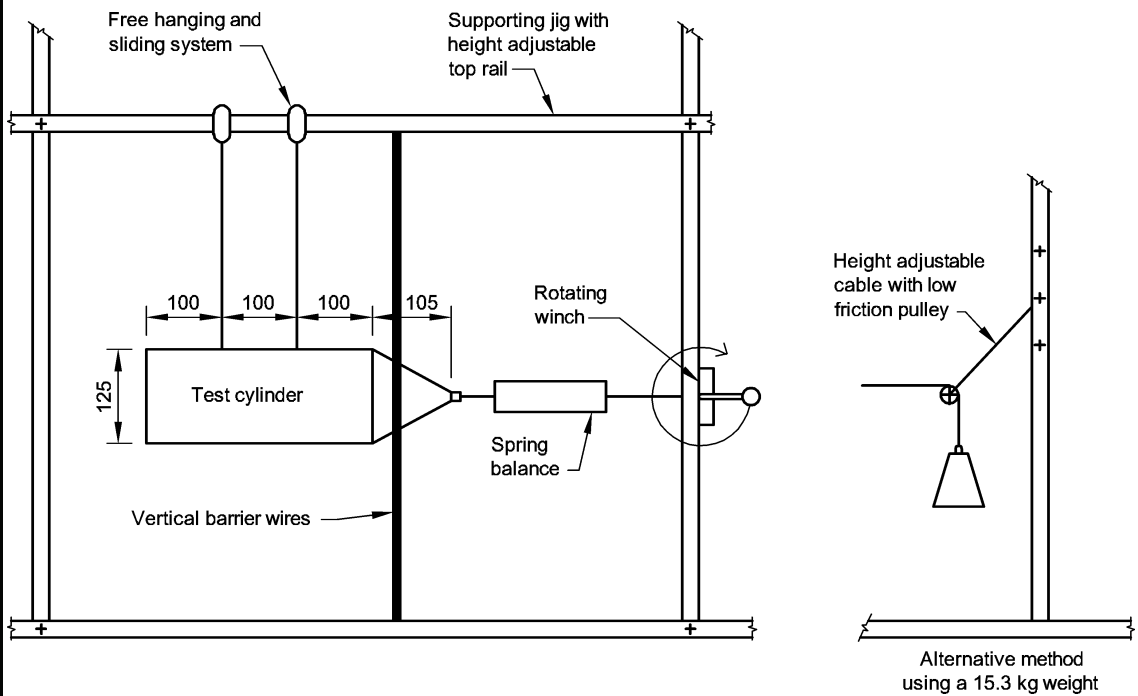

(c) Test procedure

The test procedure must be as follows:

- (i) Tension the wires, within their safe load, to the same tension in all wires and measure the tensions with a strain indicator.
- (ii) For—
 - (A) horizontal or near horizontal wires, position the cone against a pair of wires at the mid-span between supports, then apply the 150 N tension force to the cone; and
 - (B) vertical wires, position the cone against a pair of wires at the mid-span between supporting rails, then apply the 150 N tension force to the cone; and
 - (C) near-vertical wires, position the cone against a pair of wires at the widest opening between the wires, then apply the 150 N tension force to the cone.
- (iii) Attempt to pull the cone through the gap between the wires under the 150 N load, and—
 - (A) increase the tension in the wires and repeat (ii) until such time as the cone will not pull through; or
 - (B) if it does not pull through, reduce the tension in the wires and repeat step (ii); and
- (iv) When the cone is just prevented from pulling through the gap, the wires are at the correct tension in which case the cone is withdrawn and the tension recorded.

- (v) Reduce the tension in the wires and repeat steps (ii) to (iv) twice more, recording the tension in each case after the cone has been removed and then calculate the average of the three tensions as the *required* tension for each wire.
 - (vi) For prototype tests of horizontal or near horizontal wires, record the deflection of each wire at the average tension calculated in accordance with (v) when a 2 kg mass is hung at mid-span between supports.
- (d) **Test report**
- The test report must include the following information:
- (i) The name and address of the person supervising the test.
 - (ii) The test report number.
 - (iii) The date of the test.
 - (iv) The wire manufacturer's name and address, and specifications of the wires used in the test including the safe load limit of the wires.
 - (v) The construction details of the test specimen, including a description and drawings and details of the components including supports, post or railing spacings and wire spacings.
 - (vi) For a prototype test, the *required* tension calculated in accordance with (c)(v).
 - (vii) For prototype tests of horizontal or near horizontal wires, the deflection measured in accordance with (c)(vi).

PART D1 PROVISION FOR ESCAPE

Deemed-to-Satisfy Provisions

D1.0 Deemed-to-Satisfy Provisions

- (a) Where a *Deemed-to-Satisfy Solution* is proposed, *Performance Requirements DP1* to *DP6*, *DP8* and *DP9* are satisfied by complying with—
- (i) **D1.1** to **D1.17**, **D2.1** to **D2.25** and **D3.1** to **D3.12**; and
 - (ii) in a building containing an *atrium*, **Part G3**; and
 - (iii) in a building in an *alpine area*, **Part G4**; and
 - (iv) for additional requirements for Class 9b buildings, **Part H1**; and
 - (v) for public transport buildings, **Part H2**; and
 - (vi) for *farm sheds*, **Part H3**.
- (b) Where a *Performance Solution* is proposed, the relevant *Performance Requirements* must be determined in accordance with **A0.7**.
- (c) *Performance Requirement DP7* must be complied with if lifts are to be used to assist occupants to evacuate a building.

There are no *Deemed-to-Satisfy Provisions* for this *Performance Requirement* in respect of using lifts.

D1.1 Application of Part

The *Deemed-to-Satisfy Provisions* of this Part do not apply to the internal parts of a *sole-occupancy unit* in a Class 2 or 3 building or a Class 4 part of a building.

D1.2 Number of exits required

- (a) **All buildings** — Every building must have at least one *exit* from each *storey*.
- (b) **Class 2 to 8 buildings** — In addition to any *horizontal exit*, not less than 2 *exits* must be provided from the following:
- (i) Each *storey* if the building has an *effective height* of more than 25 m.
 - (ii) A Class 2 or 3 building subject to **C1.5**.
- (c) **Basements** — In addition to any *horizontal exit*, not less than 2 *exits* must be provided from any *storey* if egress from that *storey* involves a vertical rise within the building of more than 1.5 m, unless—
- (i) the *floor area* of the *storey* is not more than 50 m²; and
 - (ii) the distance of travel from any point on the floor to a single *exit* is not more than 20 m.
- (d) **Class 9 buildings** — In addition to any *horizontal exit*, not less than 2 *exits* must be provided from the following:

Deemed-to-Satisfy Provisions

- (i) Each *storey* if the building has a *rise in storeys* of more than 6 or an *effective height* of more than 25 m.
- (ii) Any *storey* which includes a *patient care area* in a Class 9a *health-care building*.
- (iii) Any *storey* that contains sleeping areas in a Class 9c building.
- (iv) Each *storey* in a Class 9b building used as an *early childhood centre*.
- (v) Each *storey* in a primary or secondary *school* with a *rise in storeys* of 2 or more.
- (vi) Any *storey* or *mezzanine* that accommodates more than 50 persons, calculated under **D1.13**.

NSW D1.2(d)(vii)

- (e) **Exits from Class 9c buildings and patient care areas in Class 9a health-care buildings** — In a Class 9a *health-care building* and a Class 9c building, at least one *exit* must be provided from every part of a *storey* which has been divided into *fire compartments* in accordance with **C2.2** or **C2.5**.
- (f) **Exits in open spectator stands** — In an *open spectator stand* containing more than one tier of seating, every tier must have not less than 2 stairways or ramps, each forming part of the path of travel to not less than 2 *exits*.
- (g) **Access to exits** — Without passing through another *sole-occupancy unit* every occupant of a *storey* or part of a *storey* must have access to—
 - (i) an *exit*; or
 - (ii) at least 2 *exits*, if 2 or more *exits* are *required*.

SA D1.2(h)

D1.3 When fire-isolated stairways and ramps are required

- (a) **Class 2 and 3 buildings** — Every stairway or ramp serving as a *required exit* must be fire-isolated unless it connects, passes through or passes by not more than—
 - (i) 3 consecutive *storeys* in a Class 2 building; or
 - (ii) 2 consecutive *storeys* in a Class 3 building,
and one extra *storey* of any classification may be included if—
 - (iii) it is only for the accommodation of motor vehicles or for other ancillary purposes; or
 - (iv) the building has a sprinkler system complying with **Specification E1.5** installed throughout; or
 - (v) the *required exit* does not provide access to or egress for, and is separated from, the extra *storey* by construction having—
 - (A) an FRL of –/60/60, if non-*loadbearing*; and
 - (B) an FRL of 90/90/90, if *loadbearing*; and
 - (C) no opening that could permit the passage of fire or smoke.
- (b) **Class 5, 6, 7, 8 or 9 buildings** — Every stairway or ramp serving as a *required exit* must be fire-isolated unless—
 - (i) in a Class 9a *health-care building* — it connects, or passes through or passes by not more than 2 consecutive *storeys* in areas other than *patient care areas*; or

Deemed-to-Satisfy Provisions

- (ii) it is part of an *open spectator stand*; or
- (iii) in any other case except in a Class 9c building, it connects, passes through or passes by not more than 2 consecutive *storeys* and one extra *storey* of any classification may be included if—
 - (A) the building has a sprinkler system complying with **Specification E1.5** installed throughout; or
 - (B) the *required exit* does not provide access to or egress for, and is separated from, the extra *storey* by construction having—
 - (aa) an FRL of –/60/60, if non-*loadbearing*; and
 - (bb) an FRL of 90/90/90 for Type A construction or 60/60/60 for Type B construction, if *loadbearing*; and
 - (cc) no opening that could permit the passage of fire or smoke.

D1.4 Exit travel distances

- (a) **Class 2 and 3 buildings**—
 - (i) The entrance doorway of any *sole-occupancy unit* must be not more than—
 - (A) 6 m from an *exit* or from a point from which travel in different directions to 2 *exits* is available; or
 - (B) 20 m from a single *exit* serving the *storey* at the level of egress to a road or *open space*; and
 - (ii) no point on the floor of a room which is not in a *sole-occupancy unit* must be more than 20 m from an *exit* or from a point at which travel in different directions to 2 *exits* is available.
- (b) **Class 4 parts of a building** — The entrance doorway to any Class 4 part of a building must be not more than 6 m from an *exit* or a point from which travel in different directions to 2 *exits* is available.
- (c) **Class 5, 6, 7, 8 or 9 buildings** — Subject to (d), (e) and (f)—
 - (i) no point on a floor must be more than 20 m from an *exit*, or a point from which travel in different directions to 2 *exits* is available, in which case the maximum distance to one of those *exits* must not exceed 40 m; and
 - (ii) in a Class 5 or 6 building, the distance to a single *exit* serving a *storey* at the level of access to a road or *open space* may be increased to 30 m.

Vic D1.4(d)

- (d) **Class 9a buildings** — In a *patient care area* in a Class 9a building—
 - (i) no point on the floor must be more than 12 m from a point from which travel in different directions to 2 of the *required exits* is available; and
 - (ii) the maximum distance to one of those *exits* must not be more than 30 m from the starting point.
- (e) **Open spectator stands** — The distance of travel to an *exit* in a Class 9b building used as an *open spectator stand* must be not more than 60 m.
- (f) **Assembly buildings** — In a Class 9b building other than a *school* or *early childhood centre*, the distance to one of the *exits* may be 60 m if—

Deemed-to-Satisfy Provisions

- (i) the path of travel from the room concerned to that *exit* is through another area which is a corridor, hallway, lobby, ramp or other circulation space; and
- (ii) the room is smoke-separated from the circulation space by construction having an FRL of not less than 60/60/60 with every doorway in that construction protected by a tight fitting, *self-closing*, solid-core door not less than 35 mm thick; and
- (iii) the maximum distance of travel does not exceed 40 m within the room and 20 m from the doorway to the room through the circulation space to the *exit*.

D1.5 Distance between alternative exits

Exits that are *required* as alternative means of egress must be—

- (a) distributed as uniformly as practicable within or around the *storey* served and in positions where unobstructed access to at least 2 *exits* is readily available from all points on the floor including lift lobby areas; and
- (b) not less than 9 m apart; and
- (c) not more than—
 - (i) in a Class 2 or 3 building — 45 m apart; or
 - (ii) in a Class 9a *health-care building*, if such *required exit* serves a *patient care area* — 45 m apart; or
 - (iii) in all other cases — 60 m apart; and
- (d) located so that alternative paths of travel do not converge such that they become less than 6 m apart.

D1.6 Dimensions of exits and paths of travel to exits

In a *required exit* or path of travel to an *exit*—

- (a) the unobstructed height throughout must be not less than 2 m, except the unobstructed height of any doorway may be reduced to not less than 1980 mm; and
- (b) the unobstructed width of each *exit* or path of travel to an *exit*, except for doorways, must be not less than—
 - (i) 1 m; or
 - (ii) 1.8 m in a passageway, corridor or ramp normally used for the transportation of patients in beds within a *treatment area* or *ward area*; and
 - (iii) in a *public corridor* in a Class 9c building, notwithstanding (c) and (d)—
 - (A) 1.5 m; and
 - (B) 1.8 m for the full width of the doorway, providing access into a *sole-occupancy unit* or communal bathroom; and
- (c) if the *storey*, *mezzanine* or *open spectator stand* accommodates more than 100 persons but not more than 200 persons, the aggregate unobstructed width, except for doorways, must be not less than—
 - (i) 1 m plus 250 mm for each 25 persons (or part) in excess of 100; or
 - (ii) 1.8 m in a passageway, corridor or ramp normally used for the transportation of patients in beds within a *treatment area* or *ward area*; and

Deemed-to-Satisfy Provisions

- (d) if the *storey, mezzanine* or *open spectator stand* accommodates more than 200 persons, the aggregate unobstructed width, except for doorways, must be increased to—
 - (i) 2 m plus 500 mm for every 60 persons (or part) in excess of 200 persons if egress involves a change in floor level by a stairway or ramp with a gradient steeper than 1 in 12; or
 - (ii) in any other case, 2 m plus 500 mm for every 75 persons (or part) in excess of 200; and
- (e) in an *open spectator stand* which accommodates more than 2000 persons, the aggregate unobstructed width, except for doorways, must be increased to 17 m plus a width (in metres) equal to the number in excess of 2000 divided by 600; and
- (f) the unobstructed width of a doorway must be not less than—
 - (i) in *patient care areas* through which patients would normally be transported in beds, if the doorway provides access to, or from, a corridor of width—
 - (A) less than 2.2 m — 1200 mm; or
 - (B) 2.2 m or greater — 1070 mm,and where the doorway is fitted with two leaves and one leaf is secured in the closed position in accordance with **D2.21(b)(v)**, the other leaf must permit an unobstructed opening not less than 800 mm wide; or
 - (ii) in *patient care areas* in a *horizontal exit* — 1250 mm; or
 - (iii) the unobstructed width of each *exit* provided to comply with **(b)**, **(c)**, **(d)** or **(e)**, minus 250 mm; or

Vic D1.6(f)(iv)

- (iv) in a Class 9c building—
 - (A) 1070 mm where it opens from a *public corridor* to a *sole-occupancy unit*; or
 - (B) 870 mm in other *resident use areas*; or
 - (C) 800 mm in non-*resident use areas*,and where the doorway is fitted with two leaves and one leaf is secured in the closed position in accordance with **D2.21(b)(v)**, the other leaf must permit an unobstructed opening not less than 870 mm wide in *resident use areas* and 800 mm wide in non-*resident use areas*; or
- (v) in any other case except where it opens to a *sanitary compartment* or bathroom — 750 mm wide; and

NSW D1.6(f)(vi)

- (g) the unobstructed width of a *required exit* must not diminish in the direction of travel to a road or *open space*, except where the width is increased in accordance with **(b)(ii)** or **(f)(i)**; and
- (h) the *required* width of a stairway or ramp must—
 - (i) be measured clear of all obstructions such as handrails, projecting parts of barriers and the like; and
 - (ii) extend without interruption, except for ceiling cornices, to a height not less than 2 m vertically above a line along the nosings of the treads or the floor surface of the ramp or landing; and

Deemed-to-Satisfy Provisions

- (i) to determine the aggregate unobstructed width, the number of persons accommodated must be calculated according to **D1.13**.

NSW D1.6(j)

D1.7 Travel via fire-isolated exits

- (a) A doorway from a room must not open directly into a stairway, passageway or ramp that is *required* to be fire-isolated unless it is from—
 - (i) a *public corridor*, public lobby or the like; or
 - (ii) a *sole-occupancy unit* occupying all of a *storey*; or
 - (iii) a *sanitary compartment*, airlock or the like.
- (b) Each *fire-isolated stairway* or *fire-isolated ramp* must provide independent egress from each *storey* served and discharge directly, or by way of its own *fire-isolated passageway*—
 - (i) to a road or *open space*; or
 - (ii) to a point—
 - (A) in a *storey* or space, within the confines of the building, that is used only for pedestrian movement, car parking or the like and is open for at least $\frac{2}{3}$ of its perimeter; and
 - (B) from which an unimpeded path of travel, not further than 20 m, is available to a road or *open space*; or
 - (iii) into a covered area that—
 - (A) adjoins a road or *open space*; and
 - (B) is open for at least $\frac{1}{3}$ of its perimeter; and
 - (C) has an unobstructed clear height throughout, including the perimeter openings, of not less than 3 m; and
 - (D) provides an unimpeded path of travel from the point of discharge to the road or *open space* of not more than 6 m.
- (c) Where a path of travel from the point of discharge of a fire-isolated *exit* necessitates passing within 6 m of any part of an *external wall* of the same building, measured horizontally at right angles to the path of travel, that part of the wall must have—
 - (i) an FRL of not less than 60/60/60; and
 - (ii) any openings protected internally in accordance with **C3.4**,for a distance of 3 m above or below, as appropriate, the level of the path of travel, or for the height of the wall, whichever is the lesser.
- (d) If more than 2 access doorways, not from a *sanitary compartment* or the like, open to a *required* fire-isolated *exit* in the same *storey*—
 - (i) a smoke lobby in accordance with **D2.6** must be provided; or
 - (ii) the *exit* must be pressurised in accordance with AS/NZS 1668.1.
- (e) A ramp must be provided at any change in level less than 600 mm in a *fire-isolated passageway* in a Class 9 building.

Deemed-to-Satisfy Provisions

D1.8 External stairways or ramps in lieu of fire-isolated exits

- (a) An external stairway or ramp may serve as a *required exit* in lieu of a fire-isolated *exit* serving a *storey* below an *effective height* of 25 m, if the stairway or ramp is—
- (i) *non-combustible* throughout; and
 - (ii) protected in accordance with (c) if it is within 6 m of, and exposed to any part of the *external wall* of the building it serves.
- (b) For the purposes of this clause—
- (i) exposure under (a)(ii), is measured in accordance with **Clause 2.1 of Specification C1.1**, as if the *exit* was a building element and the *external wall* of the building was a *fire-source feature* to the *exit*, except that the FRL *required* in **Clause 2.1(a)(i)** must not be less than 60/60/60; and
 - (ii) the plane formed at the construction edge or perimeter of an unenclosed building or part such as an *open-deck carpark*, *open spectator stand* or the like, is deemed to be an *external wall*; and
 - (iii) openings in an *external wall* and openings under (c) and (d), are determined in accordance with **C3.1**.
- (c) The protection referred to in (a)(ii), must adequately protect occupants using the *exit* from exposure to a fire within the building, in accordance with one of the following methods:
- (i) The part of the *external wall* of the building to which the *exit* is exposed must have—
 - (A) an FRL of not less than 60/60/60; and
 - (B) no openings less than 3 m from the *exit* (except a doorway serving the *exit* protected by a –/60/30 fire door in accordance with **C3.8(a)**); and
 - (C) any opening 3 m or more but less than 6 m from the *exit*, protected in accordance with **C3.4** and if wall wetting sprinklers are used, they are located internally.
 - (ii) The *exit* must be protected from—
 - (A) any part of the *external wall* of the building having an FRL of less than 60/60/60; and
 - (B) any openings in the *external wall*,by the construction of a wall, roof, floor or other shielding element as appropriate in accordance with (d).
- (d) The wall, roof, floor or other shielding element *required* by (c)(ii) must—
- (i) have an FRL of not less than 60/60/60; and
 - (ii) have no openings less than 3 m from the *external wall* of the building (except a doorway serving the *exit* protected by a –/60/30 fire door in accordance with **C3.8(a)**); and
 - (iii) have any opening 3 m or more but less than 6 m from any part of the *external wall* of the building protected in accordance with **C3.4** and if wall wetting sprinklers are used, they are located on the side exposed to the *external wall*.

Deemed-to-Satisfy Provisions

D1.9 Travel by non-fire-isolated stairways or ramps

- (a) A non-*fire-isolated stairway* or non-*fire-isolated ramp* serving as a *required exit* must provide a continuous means of travel by its own *flights* and landings from every *storey* served to the level at which egress to a road or *open space* is provided.
- (b) In a Class 2, 3 or 4 building, the distance between the doorway of a room or *sole-occupancy unit* and the point of egress to a road or *open space* by way of a stairway or ramp that is not fire-isolated and is *required* to serve that room or *sole-occupancy unit* must not exceed—
 - (i) 30 m in a building of Type C construction; or
 - (ii) 60 m in all other cases.
- (c) In a Class 5, 6, 7, 8 or 9 building, the distance from any point on a floor to a point of egress to a road or *open space* by way of a *required non-fire-isolated stairway* or non-*fire-isolated ramp* must not exceed 80 m.
- (d) In a Class 2, 3 or 9a building, a *required non-fire-isolated stairway* or non-*fire-isolated ramp* must discharge at a point not more than—
 - (i) 15 m from a doorway providing egress to a road or *open space* or from a *fire-isolated passageway* leading to a road or *open space*; or
 - (ii) 30 m from one of 2 such doorways or passageways if travel to each of them from the non-*fire-isolated stairway* or non-*fire-isolated ramp* is in opposite or approximately opposite directions.
- (e) In a Class 5 to 8 or 9b building, a *required non-fire-isolated stairway* or non-*fire-isolated ramp* must discharge at a point not more than—
 - (i) 20 m from a doorway providing egress to a road or *open space* or from a *fire-isolated passageway* leading to a road or *open space*; or
 - (ii) 40 m from one of 2 such doorways or passageways if travel to each of them from the non-*fire-isolated stairway* or non-*fire-isolated ramp* is in opposite or approximately opposite directions.
- (f) In a Class 2 or 3 building, if 2 or more *exits* are *required* and are provided by means of internal non-*fire-isolated stairways* or non-*fire-isolated ramps*, each *exit* must—
 - (i) provide separate egress to a road or *open space*; and
 - (ii) be suitably smoke-separated from each other at the level of discharge.

D1.10 Discharge from exits

- (a) An *exit* must not be blocked at the point of discharge and where necessary, suitable barriers must be provided to prevent vehicles from blocking the *exit*, or access to it.
- (b) If a *required exit* leads to an *open space*, the path of travel to the road must have an unobstructed width throughout of not less than—
 - (i) the minimum width of the *required exit*; or
 - (ii) 1 m,whichever is the greater.
- (c) If an *exit* discharges to *open space* that is at a different level than the public road to which it is connected, the path of travel to the road must be by—

Deemed-to-Satisfy Provisions

- (i) a ramp or other incline having a gradient not steeper than 1:8 at any part, or not steeper than 1:14 if *required* by the *Deemed-to-Satisfy Provisions* of **Part D3**; or
 - (ii) except if the *exit* is from a Class 9a building, a stairway complying with the *Deemed-to-Satisfy Provisions* of the BCA.
- (d) The discharge point of alternative *exits* must be located as far apart as practical.
- (e) In a Class 9b building which is an *open spectator stand* that accommodates more than 500 persons, a *required* stairway or *required* ramp must not discharge to the ground in front of the stand.

NSW D1.10(f)

- (f) In a Class 9b building containing an auditorium which accommodates more than 500 persons, not more than $\frac{2}{3}$ of the *required* width of *exits* must be located in the main entrance foyer.
- (g) The number of persons accommodated must be calculated according to **D1.13**.

D1.11 Horizontal exits

- (a) *Horizontal exits* must not be counted as *required exits*—
- (i) between *sole-occupancy units*; or
 - (ii) in a Class 9b building used as an *early childhood centre*, primary or secondary *school*.
- (b) In a Class 9a *health-care building* or Class 9c building, *horizontal exits* may be counted as *required exits* if the path of travel from a *fire compartment* leads by one or more *horizontal exits* directly into another *fire compartment* which has at least one *required exit* which is not a *horizontal exit*.
- (c) In cases other than in (b), *horizontal exits* must not comprise more than half of the *required exits* from any part of a *storey* divided by a *fire wall*.
- (d) *Horizontal exits* must have a clear area on the side of the *fire wall* to which occupants are evacuating, to accommodate the total number of persons (calculated under **D1.13**) served by the *horizontal exit* of not less than—
- (i) 2.5 m² per patient/resident in a Class 9a *health-care building* or Class 9c building; and
 - (ii) 0.5 m² per person in any other case.
- (e) Where a *fire compartment* is provided with only two *exits*, and one of those *exits* is a *horizontal exit*, the clear area *required* by (d) is to be of a size that accommodates all the occupants from the *fire compartment* being evacuated.
- (f) The clear area *required* by (d) must be connected to the *horizontal exit* by an unobstructed path that has at least the dimensions *required* for the *horizontal exit* and may include the area of the unobstructed path.

D1.12 Non-required stairways, ramps or escalators

An escalator, moving walkway or non-*required* non *fire-isolated stairway* or pedestrian ramp—

- (a) must not be used between *storeys* in—
- (i) a *patient care area* in a Class 9a *health-care building*; or

Deemed-to-Satisfy Provisions

- (ii) a *resident use area* in a Class 9c building; and
- (b) may connect any number of *storeys* if it is—
 - (i) in an *open spectator stand* or indoor sports stadium; or
 - (ii) in a *carpark* or an *atrium*; or
 - (iii) outside a building; or
 - (iv) in a Class 5 or 6 building that is sprinklered throughout, where the escalator, walkway, stairway or ramp complies with **Specification D1.12**; and
- (c) except where permitted in (b) must not connect more than—
 - (i) 3 *storeys* if each of those *storeys* is provided with a sprinkler system complying with **Specification E1.5** throughout; or
 - (ii) 2 *storeys*,
 provided that in each case, those *storeys* must be consecutive, and one of those *storeys* is situated at a level at which there is direct egress to a road or *open space*; and
- (d) except where permitted in (b) or (c), must not connect, directly or indirectly, more than 2 *storeys* at any level in a Class 5, 6, 7, 8 or 9 building and those *storeys* must be consecutive.

D1.13 Number of persons accommodated

For the purposes of the *Deemed-to-Satisfy Provisions*, the number of persons accommodated in a *storey*, room or *mezzanine* must be determined with consideration to the purpose for which it is used and the layout of the *floor area* by—

- (a) calculating the sum of the numbers obtained by dividing the *floor area* of each part of the *storey* by the number of square metres per person listed in **Table D1.13** according to the use of that part, excluding spaces set aside for—
 - (i) lifts, stairways, ramps and escalators, corridors, hallways, lobbies and the like; and
 - (ii) service ducts and the like, *sanitary compartments* or other ancillary uses; or
- (b) reference to the seating capacity in an *assembly building* or room; or
- (c) any other suitable means of assessing its capacity.

NSW Table D1.13

Table D1.13 AREA PER PERSON ACCORDING TO USE

Type of use	m ² per person
Art gallery, exhibition area, museum	4
Bar	—bar standing
	—other
Board room	2
Boarding house	15
Cafe, church, dining room	1
<i>Carpark</i>	30

Deemed-to-Satisfy Provisions

Table D1.13 AREA PER PERSON ACCORDING TO USE — continued

Type of use	m² per person
Computer room	25
Court room	10
—judicial area	10
—public seating	1
Dance floor	0.5
Dormitory	5
<i>Early childhood centre</i>	4
Factory—	
(a) machine shop, fitting shop or like place for cutting, grading, finishing or fitting of metals or glass, except in the fabrication of structural steelwork or manufacture of vehicles or bulky products	5
(b) areas used for fabrication and processing other than those in (a)	50
(c) a space in which the layout and natural use of fixed plant or equipment determines the number of persons who will occupy the space during working hours	Area per person determined by the use of the plant or equipment
Gymnasium	3
Hostel, hotel, motel, guest house	15
Indoor sports stadium—arena	10
Kiosk	1
Kitchen, laboratory, laundry	10
Library	
—reading space	2
—storage space	30
Office, including one for typewriting or document copying	10
<i>Patient care areas</i>	10
Plant room	
—ventilation, electrical or other service units	30
—boilers or power plant	50
Reading room	2
Restaurant	1
<i>School</i>	
—general classroom	2
—multi-purpose hall	1
—staff room	10
—trade and practical area —primary	4

Deemed-to-Satisfy Provisions

Table D1.13 AREA PER PERSON ACCORDING TO USE — continued

Type of use	m ² per person
	—secondary As for workshop
Shop	
—space for sale of goods—	
(a) at a level entered direct from the open air or any lower level	3
(b) all other levels	5
Showroom	5
—display area, covered mall or arcade	
Skating rink, based on rink area	1.5
Spectator stand, audience viewing area:	
—standing viewing area	0.3
—removable seating	1
—fixed seating (number of seats)	
—bench seating (450 mm/person)	
Storage space	30
<i>Swimming pool</i> , based on pool area	1.5
Switch room, transformer room	30
Telephone exchange	30
—private	
Theatre and public hall	1
Theatre dressing room	4
Transport terminal	2
Workshop	
—for maintenance staff	30
—for manufacturing processes	As for Factory

Note: Bar standing is the area used by standing patrons and extends not less than 1.5m wide from the outside edge of the bar top for the length of the serving area of the bar.

D1.14 Measurement of distances

The nearest part of an *exit* means in the case of—

- (a) a *fire-isolated stairway*, *fire-isolated passageway*, or *fire-isolated ramp*, the nearest part of the doorway providing access to them; and
- (b) a non-*fire-isolated stairway*, the nearest part of the nearest riser; and
- (c) a non-*fire-isolated ramp*, the nearest part of the junction of the floor of the ramp and the floor of the *storey*; and
- (d) a doorway opening to a road or *open space*, the nearest part of the doorway; and
- (e) a *horizontal exit*, the nearest part of the doorway.

Deemed-to-Satisfy Provisions

D1.15 Method of measurement

The following rules apply:

- (a) In the case of a room that is not a *sole-occupancy unit* in a Class 2 or 3 building or Class 4 part of a building, the distance includes the straight-line measurement from any point on the floor of the room to the nearest part of a doorway leading from it, together with the distance from that part of the doorway to the single *required exit* or point from which travel in different directions to 2 *required exits* is available.
- (b) Subject to (d), the distance from the doorway of a *sole-occupancy unit* in a Class 2 or 3 building or a Class 4 part of a building is measured in a straight line to the nearest part of the *required* single *exit* or point from which travel in different directions to 2 *required exits* is available.
- (c) Subject to (d), the distance between *exits* is measured in a straight line between the nearest parts of those *exits*.
- (d) Only the shortest distance is taken along a corridor, hallway, external balcony or other path of travel that curves or changes direction.
- (e) If more than one corridor, hallway, or other internal path of travel connects *required exits*, the measurement is along the path of travel through the point at which travel in different directions to those *exits* is available.
- (f) If a wall (including a demountable *internal wall*) that does not bound—
 - (i) a room; or
 - (ii) a corridor, hallway or the like,causes a change of direction in proceeding to a *required exit*, the distance is measured along the path of travel past that wall.
- (g) If permanent fixed seating is provided, the distance is measured along the path of travel between the rows of seats.
- (h) In the case of a non-*fire-isolated stairway* or non-*fire-isolated ramp*, the distance is measured along a line connecting the nosings of the treads, or along the slope of the ramp, together with the distance connecting those lines across any intermediate landings.

D1.16 Plant rooms, lift machine rooms and electricity network substations: Concession

- (a) A ladder may be used in lieu of a stairway to provide egress from—
 - (i) a plant room with a *floor area* of not more than 100 m²; or
 - (ii) all but one point of egress from a plant room, a lift machine room or a Class 8 *electricity network substation* with a *floor area* of not more than 200 m².
- (b) A ladder permitted under (a)—
 - (i) may form part of an *exit* provided that in the case of a *fire-isolated stairway* it is contained within the *shaft*; or
 - (ii) may discharge within a *storey* in which case it must be considered as forming part of the path of travel; and
 - (iii) for a plant room or a Class 8 *electricity network substation*, must comply with AS 1657; and

Deemed-to-Satisfy Provisions

- (iv) for a lift machine room, where access is provided from within a machine room to a secondary floor, a fixed rung type ladder complying with AS 1657 may be used, provided that—
 - (A) the height between the floors is not more than 2800 mm; and
 - (B) the ladder is inclined at an angle to the horizontal not less than 65 degrees nor more than 75 degrees; and
 - (C) the distance between the front face of the ladder and any adjacent obstruction is not less than—
 - (aa) 960 mm, where the ladder is inclined 65 degrees to the horizontal; or
 - (bb) 760 mm, where the ladder is inclined 75 degrees to the horizontal; or
 - (cc) a distance that is determined by interpolating the values in (aa) and (bb), where the ladder is inclined at any angle between 65 degrees and 75 degrees to the horizontal; and
 - (D) a clear space not less than 600 mm exists between the foot of the ladder and any equipment.

D1.17 Access to lift pits

Access to lift pits must—

- (a) where the pit depth is not more than 3 m, be through the lowest landing doors; or
- (b) where the pit depth is more than 3 m, be provided through an access doorway complying with the following:
 - (i) In lieu of **D1.6**, the doorway must be level with the pit floor and not be less than 600 mm wide by 1980 mm high clear opening, which may be reduced to 1500 mm where it is necessary to comply with (ii).
 - (ii) No part of the lift car or platform must encroach on the pit doorway entrance when the car is on a fully compressed buffer.
 - (iii) Access to the doorway must be by a stairway complying with AS 1657.
 - (iv) In lieu of **D2.21**, doors fitted to the doorway must be—
 - (A) of the horizontal sliding or outwards opening hinged type; and
 - (B) self-closing and self-locking from the outside; and
 - (C) marked on the landing side with the letters not less than 35 mm high:
“DANGER LIFTWELL - ENTRY OF UNAUTHORIZED PERSONS PROHIBITED - KEEP CLEAR AT ALL TIMES”

ACT D1.101, ACT D1.102

PART D2 CONSTRUCTION OF EXITS

Deemed-to-Satisfy Provisions

D2.0 Deemed-to-Satisfy Provisions

- (a) Where a *Deemed-to-Satisfy Solution* is proposed, *Performance Requirements DP1 to DP6, DP8 and DP9* are satisfied by complying with—
 - (i) **D1.1 to D1.16, D2.1 to D2.25 and D3.1 to D3.12**; and
 - (ii) in a building containing an *atrium*, **Part G3**; and
 - (iii) in a building in an *alpine area*, **Part G4**; and
 - (iv) for additional requirements for Class 9b buildings, **Part H1**; and
 - (v) for public transport buildings, **Part H2**; and
 - (vi) for *farm buildings* and *farm sheds*, **Part H3**.
- (b) Where a *Performance Solution* is proposed, the relevant *Performance Requirements* must be determined in accordance with **A0.7**.
- (c) *Performance Requirement DP7* must be complied with if lifts are to be used to assist occupants to evacuate a building.

D2.1 Application of Part

Except for—

- (a) **D2.13, D2.14(a), D2.16, D2.17(d), D2.17(e), D2.21 and D2.24**, the *Deemed-to-Satisfy Provisions* of this Part do not apply to the internal parts of a *sole-occupancy unit* in a Class 3 building; and
- (b) **D2.13, D2.14(a), D2.16, D2.17(d), D2.17(e), D2.18 and D2.24**, the *Deemed-to-Satisfy Provisions* of this Part do not apply to the internal parts of a *sole-occupancy unit* in a Class 2 building or Class 4 part of a building.

NSW D2.1(c)

D2.2 Fire-isolated stairways and ramps

A stairway or ramp (including any landings) that is *required* to be within a *fire-resisting shaft* must be constructed—

- (a) of *non-combustible* materials; and
- (b) so that if there is local failure it will not cause structural damage to, or impair the fire-resistance of, the *shaft*.

D2.3 Non-fire-isolated stairways and ramps

In a building having a *rise in storeys* of more than 2, *required* stairs and ramps (including landings and any supporting building elements) which are not *required* to be within a *fire-resisting shaft*, must be constructed according to **D2.2**, or only of—

- (a) reinforced or prestressed concrete; or

Deemed-to-Satisfy Provisions

- (b) steel in no part less than 6 mm thick; or
- (c) timber that—
 - (i) has a finished thickness of not less than 44 mm; and
 - (ii) has an average density of not less than 800 kg/m³ at a moisture content of 12%; and
 - (iii) has not been joined by means of glue unless it has been laminated and glued with resorcinol formaldehyde or resorcinol phenol formaldehyde glue.

D2.4 Separation of rising and descending stair flights

If a stairway serving as an *exit* is *required* to be fire-isolated—

- (a) there must be no direct connection between—
 - (i) a *flight* rising from a *storey* below the lowest level of access to a road or *open space*; and
 - (ii) a *flight* descending from a *storey* above that level; and
- (b) any construction that separates or is common to the rising and descending *flights* must be—
 - (i) *non-combustible*; and
 - (ii) smoke proof in accordance with **Clause 2 of Specification C2.5**.

D2.5 Open access ramps and balconies

Where an open access ramp or balcony is provided to meet the smoke hazard management requirements of **Table E2.2a**, it must—

- (a) have ventilation openings to the outside air which—
 - (i) have a total unobstructed area not less than the *floor area* of the ramp or balcony; and
 - (ii) are evenly distributed along the open sides of the ramp or balcony; and
- (b) not be enclosed on its open sides above a height of 1 m except by an open grille or the like having a free air space of not less than 75% of its area.

D2.6 Smoke lobbies

A smoke lobby *required* by **D1.7** must—

- (a) have a *floor area* not less than 6 m²; and
- (b) be separated from the occupied areas in the *storey* by walls which are impervious to smoke, and—
 - (i) have an FRL of not less than 60/60/– (which may be fire-protective grade plasterboard, gypsum block with set plaster, face brickwork, glass blocks or glazing); and
 - (ii) extend from slab to slab, or to the underside of a ceiling with a *resistance to the incipient spread of fire* of 60 minutes which covers the lobby; and

Deemed-to-Satisfy Provisions

- (iii) any construction joints between the top of the walls and the floor slab, roof or ceiling must be smoke sealed with intumescent putty or other suitable material; and
- (c) at any opening from the occupied areas, have smoke doors complying with **Clause 3 of Specification C3.4** except that the smoke sensing device need only be located on the approach side of the opening; and
- (d) be pressurised as part of the *exit* if the *exit* is *required* to be pressurised under **E2.2**.

D2.7 Installations in exits and paths of travel

- (a) Access to service *shafts* and services other than to fire-fighting or detection equipment as permitted in the *Deemed-to-Satisfy Provisions* of **Section E**, must not be provided from a *fire-isolated stairway*, *fire-isolated passageway* or *fire-isolated ramp*.
- (b) An opening to any chute or duct intended to convey hot products of combustion from a boiler, incinerator, fireplace or the like, must not be located in any part of a *required exit* or any corridor, hallway, lobby or the like leading to a *required exit*.
- (c) Gas or other fuel services must not be installed in a *required exit*.
- (d) Services or equipment comprising—
 - (i) electricity meters, distribution boards or ducts; or
 - (ii) central telecommunications distribution boards or equipment; or
 - (iii) electrical motors or other motors serving equipment in the building, may be installed in—
 - (iv) a *required exit*, except for fire-isolated *exits* specified in (a); or
 - (v) in any corridor, hallway, lobby or the like leading to a *required exit*, if the services or equipment are enclosed by *non-combustible* construction or a *fire-protective covering* with doorways or openings suitably sealed against smoke spreading from the enclosure.
- (e) Electrical wiring may be installed in a fire-isolated *exit* if the wiring is associated with—
 - (i) a lighting, detection, or pressurisation system serving the *exit*; or
 - (ii) a security, surveillance or management system serving the *exit*; or
 - (iii) an intercommunication system or an audible or visual alarm system in accordance with **D2.22**; or
 - (iv) the monitoring of hydrant or sprinkler isolating valves.

D2.8 Enclosure of space under stairs and ramps

- (a) **Fire-isolated stairways and ramps** — If the space below a *required fire-isolated stairway* or *fire-isolated ramp* is within the fire-isolated *shaft*, it must not be enclosed to form a cupboard or similar enclosed space.
- (b) **Non fire-isolated stairways and ramps** — The space below a *required non fire-isolated stairway* (including an external stairway) or non *fire-isolated ramp* must not be enclosed to form a cupboard or other enclosed space unless—
 - (i) the enclosing walls and ceilings have an FRL of not less than 60/60/60; and

Deemed-to-Satisfy Provisions

- (ii) any access doorway to the enclosed space is fitted with a *self-closing* –/60/30 fire door.

D2.9 Width of required stairways and ramps

A *required* stairway or ramp that exceeds 2 m in width is counted as having a width of only 2 m unless it is divided by a handrail or barrier continuous between landings and each division has a width of not more than 2 m.

D2.10 Pedestrian ramps

- (a) A *fire-isolated ramp* may be substituted for a *fire-isolated stairway* if the construction enclosing the *ramp* and the width and ceiling height comply with the requirements for a *fire-isolated stairway*.
- (b) A ramp serving as a *required exit* must—
 - (i) where the ramp is also serving as an *accessible* ramp under **Part D3**, be in accordance with AS 1428.1; or
 - (ii) in any other case, have a gradient not steeper than 1:8.
- (c) The floor surface of a ramp must have a slip-resistance classification not less than that listed in **Table D2.14** when tested in accordance with AS 4586.

D2.11 Fire-isolated passageways

- (a) The enclosing construction of a *fire-isolated passageway* must have an FRL when tested for a fire outside the passageway in another part of the building of—
 - (i) if the passageway discharges from a *fire-isolated stairway* or *ramp* — not less than that *required* for the stairway or ramp *shaft*; or
 - (ii) in any other case — not less than 60/60/60.
- (b) Notwithstanding **(a)(ii)**, the top construction of a *fire-isolated passageway* need not have an FRL if the walls of the *fire-isolated passageway* extend to the underside of—
 - (i) a *non-combustible* roof covering; or
 - (ii) a ceiling having a *resistance to the incipient spread of fire* of not less than 60 minutes separating the roof space or ceiling space in all areas surrounding the passageway within the *fire compartment*.

D2.12 Roof as open space

If an *exit* discharges to a roof of a building, the roof must—

- (a) have an FRL of not less than 120/120/120; and
- (b) not have any rooflights or other openings within 3 m of the path of travel of persons using the *exit* to reach a road or *open space*.

D2.13 Goings and risers

- (a) A stairway must have—
 - (i) not more than 18 and not less than 2 risers in each *flight*; and

Deemed-to-Satisfy Provisions

- (ii) going (G), riser (R) and quantity (2R + G) in accordance with **Table D2.13**, except as permitted by **(b)** and **(c)**; and
- (iii) constant goings and risers throughout each *flight*, except as permitted by **(b)** and **(c)**, and the dimensions of goings (G) and risers (R) in accordance with **(a)(ii)** are considered constant if the variation between—
 - (A) adjacent risers, or between adjacent goings, is no greater than 5 mm; and
 - (B) the largest and smallest riser within a *flight*, or the largest and smallest going within a *flight*, does not exceed 10 mm; and
- (iv) risers which do not have any openings that would allow a 125 mm sphere to pass through between the treads; and
- (v) treads which have—
 - (A) a surface with a slip-resistance classification not less than that listed in **Table D2.14** when tested in accordance with AS 4586; or
 - (B) a nosing strip with a slip-resistance classification not less than that listed in **Table D2.14** when tested in accordance with AS 4586; and
- (vi) treads of solid construction (not mesh or other perforated material) if the stairway is more than 10 m high or connects more than 3 *storeys*; and
- (vii) in a Class 9b building, not more than 36 risers in consecutive *flights* without a change in direction of at least 30°; and
- (viii) in the case of a *required* stairway, no winders in lieu of a landing.

NSW D2.13(a)(ix),(x),(xi)

- (b) In the case of a non-*required* stairway—
 - (i) the stairway must have—
 - (A) not more than 3 winders in lieu of a quarter landing; and
 - (B) not more than 6 winders in lieu of a half landing; and
 - (ii) the going of all straight treads must be constant throughout the same *flight* and the dimensions of goings (G) is considered constant if the variation between—
 - (A) adjacent goings, is no greater than 5 mm; and
 - (B) the largest and smallest going within a *flight*, does not exceed 10 mm; and
 - (iii) the going of all winders in lieu of a quarter or half landing may vary from the going of the straight treads within the same *flight* provided that the going of all such winders is constant.
- (c) Where a stairway discharges to a sloping public walkway or public road—
 - (i) the riser (R) may be reduced to account for the slope of the walkway or road; and
 - (ii) the quantity (2R+G) may vary at that location.

Deemed-to-Satisfy Provisions

Table D2.13 RISER AND GOING DIMENSIONS (mm)

	Riser (R)		Going (G) ⁽²⁾		Quantity (2R+G)	
	Max	Min	Max	Min	Max	Min
Public stairways	190	115	355	250	700	550
Private stairways ⁽¹⁾	190	115	355	240	700	550

125 mm sphere must not pass through treads

Notes:

1. Private stairways are—
 - (a) stairways in a *sole-occupancy unit* in a Class 2 building or Class 4 part of a building; and
 - (b) in any building, stairways which are not part of a *required exit* and to which the public do not normally have access.
2. The going in tapered treads (except winders in lieu of a quarter or half landing) in a curved or spiral stairway is measured—
 - (a) 270 mm in from the outer side of the unobstructed width of the stairway if the stairway is less than 1 m wide (applicable to a non-*required* stairway only); and
 - (b) 270 mm from each side of the unobstructed width of the stairway if the stairway is 1 m wide or more.

D2.14 Landings

In a stairway—

- (a) landings having a maximum gradient of 1:50 may be used in any building to limit the number of risers in each *flight* and each landing must—
 - (i) be not less than 750 mm long, and where this involves a change in direction, the length is measured 500 mm from the inside edge of the landing; and
 - (ii) have—
 - (A) a surface with a slip-resistance classification not less than that listed in **Table D2.14** when tested in accordance with AS 4586; or
 - (B) a strip at the edge of the landing with a slip-resistance classification not less than that listed in **Table D2.14** when tested in accordance with AS 4586, where the edge leads to a *flight* below; and

Deemed-to-Satisfy Provisions

- (b) in a Class 9a building—
 - (i) the area of any landing must be sufficient to move a stretcher, 2 m long and 600 mm wide, at a gradient not more than the gradient of the stairs, with at least one end of the stretcher on the landing while changing direction between *flights*; or
 - (ii) the stair must have a change of direction of 180°, and the landing a clear width of not less than 1.6 m and a clear length of not less than 2.7 m.

Table D2.14 SLIP-RESISTANCE CLASSIFICATION

Application	Surface conditions	
	Dry	Wet
Ramp steeper than 1:14	P4 or R11	P5 or R12
Ramp steeper than 1:20 but not steeper than 1:14	P3 or R10	P4 or R11
Tread or landing surface	P3 or R10	P4 or R11
Nosing or landing edge strip	P3	P4

D2.15 Thresholds

The threshold of a doorway must not incorporate a step or ramp at any point closer to the doorway than the width of the door leaf unless—

- (a) in *patient care areas* in a Class 9a *health-care building*, the door sill is not more than 25 mm above the finished floor level to which the doorway opens; or
- (b) in a Class 9c building, a ramp is provided with a maximum gradient of 1:8 for a maximum height of 25 mm over the threshold; or
- (c) in a building *required* to be *accessible* by **Part D3**, the doorway—
 - (i) opens to a road or *open space*; and
 - (ii) is provided with a threshold ramp or step ramp in accordance with AS 1428.1; or

NSW D2.15(d),(e)

- (d) in other cases—
 - (i) the doorway opens to a road or *open space*, external stair landing or external balcony; and
 - (ii) the door sill is not more than 190 mm above the finished surface of the ground, balcony, or the like, to which the doorway opens.

D2.16 Barriers to prevent falls

- (a) A continuous barrier must be provided along the side of—
 - (i) a roof to which general access is provided; and
 - (ii) a stairway or ramp; and
 - (iii) a floor, corridor, hallway, balcony, deck, verandah, *mezzanine*, access bridge or the like; and
 - (iv) any delineated path of access to a building,

Deemed-to-Satisfy Provisions

if the trafficable surface is 1 m or more above the surface beneath.

- (b) The requirements of (a) do not apply to—
- (i) the perimeter of a *stage*, rigging loft, loading dock or the like; or
 - (ii) areas referred to in **D2.18**; or
 - (iii) a retaining wall unless the retaining wall forms part of, or is directly associated with a delineated path of access to a building from the road, or a delineated path of access between buildings; or
 - (iv) a barrier provided to an openable window covered by **D2.24**.
- (c) A barrier *required* by (a) must be constructed in accordance with **Table D2.16a**.

NSW Table D2.16a 1

Table D2.16a BARRIER CONSTRUCTION

1. Barrier heights	
Location	Minimum height
(a) Stairways or ramps with a gradient of 1:20 or steeper.	865 mm
(b) Landings to a stair or ramp where the barrier is provided along the inside edge of the landing and does not exceed 500 mm in length.	
(c) In front of fixed seating on a <i>mezzanine</i> or balcony within an auditorium in a Class 9b building, where the horizontal projection extends not less than 1 m outwards from the top of the barrier.	700 mm
(d) In all other locations.	1 m
Notes:	
1. Heights are measured vertically from the surface beneath, except that for stairways the height must be measured above the nosing line of the stair treads.	
2. A transition zone may be incorporated where the barrier height changes from 865 mm on a stair <i>flight</i> or ramp to 1 m at a landing or floor.	
2. Barrier openings	
Location	Maximum Opening
(a) <i>Fire-isolated stairways, fire-isolated ramps</i> and other areas used primarily for emergency purposes, excluding—	A 300 mm sphere must not be able to pass through any opening; or where rails are used—
(i) external stairways; and	
(ii) external ramps.	

Deemed-to-Satisfy Provisions

Table D2.16a BARRIER CONSTRUCTION— continued

(b) Class 7 (other than <i>carparks</i>) and Class 8 buildings.	(i) a 150 mm sphere must not be able to pass through the opening between the nosing line of the stair treads and the rail or between the rail and the floor of the landing, balcony or the like; and (ii) the opening between rails must not be more than 460 mm.
(c) In all other locations.	A 125 mm sphere must not be able to pass through any opening.
Note: The maximum 125 mm barrier opening for a stairway, such as a non <i>fire-isolated stairway</i> , is measured above the nosing line of the stair treads.	
3. Barrier climbability	
Location	Requirement
(a) <i>Fire-isolated stairways, fire-isolated ramps</i> and other areas used primarily for emergency purposes, excluding— (i) external stairways; and (ii) external ramps.	No requirement.
(b) Class 7 (other than <i>carparks</i>) and Class 8 buildings.	
(c) For floors more than 4 m above the surface beneath in all other locations.	Any horizontal or near horizontal elements between 150 mm and 760 mm above the floor must not facilitate climbing.

- (d) Where a *required* barrier is constructed of wire, it is deemed to meet the requirements of **Table D2.16a 2(c)** if it is constructed in accordance with the following:
- (i) For horizontal wire systems—
 - (A) when measured with a strain indicator, it must be in accordance with the tension values in **Table D2.16b**; or
 - (B) must not exceed the maximum deflections in **Table D2.16d**.
 - (ii) For non-continuous vertical wire systems, when measured with a strain indicator, must be in accordance with the tension values in **Table D2.16b** (see Note 4).
 - (iii) For continuous vertical or continuous near vertical sloped wire systems—
 - (A) must have wires of no more than 2.5 mm diameter with a lay of 7×7 or 7×19 construction; and
 - (B) changes in direction at support rails must pass around a pulley block without causing permanent deformation to the wire; and
 - (C) must have supporting rails, constructed with a spacing of not more than 900 mm, of a material that does not allow deflection that would decrease the tension of the wire under load; and

Deemed-to-Satisfy Provisions

- (D) when the wire tension is measured with a strain indicator, it must be in accordance with the tension values in **Table D2.16c** and measured in the furthest span from the tensioning device.

TABLE D2.16b WIRE BARRIER CONSTRUCTION – REQUIRED TENSION FOR STAINLESS STEEL HORIZONTAL WIRES

			Clear distance between posts (mm)								
			600	800	900	1000	1200	1500	1800	2000	2500
Wire dia. (mm)	Lay	Wire spacing (mm)	Minimum <i>required</i> tension in Newtons (N)								
2.5	7x7	60	55	190	263	415	478	823	1080	1139	X
		80	382	630	730	824	1025	1288	X	X	X
		100	869	1218	1368	X	X	X	X	X	X
2.5	1x19	60	35	218	310	402	585	810	1125	1325	X
		80	420	630	735	840	1050	1400	1750	X	X
		100	1140	1565	X	X	X	X	X	X	X
3.0	7x7	60	15	178	270	314	506	660	965	1168	1491
		80	250	413	500	741	818	1083	1370	1565	X
		100	865	1278	1390	1639	X	X	X	X	X
3.0	1x19	60	25	183	261	340	520	790	1025	1180	X
		80	325	555	670	785	1015	1330	1725	1980	X
		100	1090	1500	1705	1910	X	X	X	X	X
4.0	7x7	60	5	73	97	122	235	440	664	813	1178
		80	196	422	480	524	760	1100	1358	1530	2130
		100	835	1182	1360	1528	1837	2381	2811	3098	X
4.0	1x19	60	5	5	10	15	20	147	593	890	1280
		80	30	192	300	415	593	1105	1303	1435	1844
		100	853	1308	1487	1610	2048	2608	3094	3418	3849
4.0	7x19	60	155	290	358	425	599	860	1080	1285	1540
		80	394	654	785	915	1143	1485	1860	2105	2615
		100	1038	1412	1598	1785	2165	2735	X	X	X

Notes:

- Lay = number of strands by the number of individual wires in each strand. For example a lay of 7x19 consists of 7 strands with 19 individual wires in each strand.
- Where a change of direction is made in a run of wire, the tensioning device is to be placed at the end of the longest span.
- If a 3.2 mm wire is used the tension figures for 3.0 mm wire are applied.

Deemed-to-Satisfy Provisions

TABLE D2.16b WIRE BARRIER CONSTRUCTION – REQUIRED TENSION FOR STAINLESS STEEL HORIZONTAL WIRES —
continued

4.	This table may also be used for a set of non-continuous (single) vertical wires forming a barrier using the appropriate clear distance between posts as the vertical clear distance between the rails.
5.	X = Not allowed because the required tension would exceed the safe load of the wire.
6.	Tension measured with a strain indicator.

TABLE D2.16c CONTINUOUS WIRE BARRIER CONSTRUCTION – REQUIRED TENSION FOR VERTICAL OR NEAR VERTICAL STAINLESS STEEL WIRES

Wire dia. (mm)	Lay	Widest spacing between wires (mm)	Maximum clear spacing between rails (mm)
			900
			<i>Required</i> tension in Newtons (N)
2.5	7x19	80	145
		100	310
		110	610
2.5	7x7	80	130
		100	280
		110	500

Notes:

1. Lay = number of strands by the number of individual wires in each strand. For example a lay of 7x19 consists of 7 strands with 19 individual wires in each strand.
2. Vertical wires require two pulley blocks to each 180° change of direction in the wire.
3. Near vertical wires may only require one pulley block for each change of direction.
4. Tension measured with a strain indicator.
5. The table only includes 7x7 and 7x19 wires due to other wires not having sufficient flexibility to make the necessary turns.

TABLE D2.16d WIRE BARRIER CONSTRUCTION – MAXIMUM PERMISSIBLE DEFLECTION FOR STAINLESS STEEL WIRES

		Clear distance between posts (mm)					
		600	900	1200	1500	1800	2000
Wire dia. (mm)	Wire spacing (mm)	Maximum permissible deflection of each wire in mm when a 2 kg mass is suspended at mid span					
2.5	60	17	11	9	8	8	8
	80	7	5	5	5	X	X

Deemed-to-Satisfy Provisions

TABLE D2.16d WIRE BARRIER CONSTRUCTION – MAXIMUM PERMISSIBLE DEFLECTION FOR STAINLESS STEEL WIRES —
continued

3.0	60	19	13	8	7	7	7
	80	8	6	6	5	5	5
4.0	60	18	12	8	8	7	7
	80	8	6	4	4	4	4

Notes:

1. Where a change of direction is made in a run of wire the 2 kg mass must be placed at the middle of the longest span.
2. If a 3.2 mm wire is used the deflection figures for 3.0 mm wire are applied.
3. This table may also be used for a set of non-continuous (single) vertical wires forming a barrier using the appropriate clear distance between posts as the vertical clear distance between the rails. The deflection (offset) is measured by hooking a standard spring scale to the mid span of each wire and pulling it horizontally until a force of 19.6 N is applied.
4. X = Not allowed because the required tension would exceed the safe load of the wire.
5. This table has been limited to 60 mm and 80 mm spaces for 2.5 mm, 3 mm and 4 mm diameter wires because the required wire tensions at greater spacings would require the tension to be beyond the wire safe load limit, or the allowed deflection would be impractical to measure.

D2.17 Handrails

- (a) Except for handrails referred to in **D2.18**, handrails must be—
- (i) located along at least one side of the ramp or *flight*; and
 - (ii) located along each side if the total width of the stairway or ramp is 2 m or more; and
 - (iii) in a Class 9b building used as a primary *school*—
 - (A) have one handrail fixed at a height of not less than 865 mm; and
 - (B) have a second handrail fixed at a height between 665 mm and 750 mm, measured above the nosings of stair treads and the floor surface of the ramp, landing or the like; and
 - (iv) in any other case, fixed at a height of not less than 865 mm measured above the nosings of stair treads and the floor surface of the ramp, landing, or the like; and
 - (v) continuous between stair *flight* landings and have no obstruction on or above them that will tend to break a hand-hold; and
 - (vi) in a *required exit* serving an area *required* to be *accessible*, designed and constructed to comply with clause 12 of AS 1428.1, except that clause 12(d) does not apply to a handrail *required* by (a)(iii)(B).
- (b) Handrails—

Deemed-to-Satisfy Provisions

- (i) in a Class 9a *health-care building* must be provided along at least one side of every passageway or corridor used by patients, and must be—
 - (A) fixed not less than 50 mm clear of the wall; and
 - (B) where practicable, continuous for their full length.
- (ii) in a Class 9c building must be provided along both sides of every passageway or corridor used by residents, and must be—
 - (A) fixed not less than 50 mm clear of the wall; and
 - (B) where practicable, continuous for their full length.
- (c) Handrails *required* to assist people with a disability must be provided in accordance with **D3.3**.
- (d) Handrails to a stairway or ramp within a *sole-occupancy unit* in a Class 2 or 3 building or Class 4 part of a building must—
 - (i) be located along at least one side of the *flight* or ramp; and
 - (ii) be located along the full length of the *flight* or ramp, except in the case where a handrail is associated with a barrier, the handrail may terminate where the barrier terminates; and
 - (iii) have the top surface of the handrail not less than 865 mm vertically above the nosings of the stair treads or the floor surface of the ramp; and
 - (iv) have no obstruction on or above them that will tend to break a handhold, except for newel posts, ball type stanchions, or the like.
- (e) The requirements of (d) do not apply to—
 - (i) handrails referred to in **D2.18**; or
 - (ii) a stairway or ramp providing a change in elevation of less than 1 m; or
 - (iii) a landing; or
 - (iv) a winder where a newel post is installed to provide a handhold.

D2.18 Fixed platforms, walkways, stairways and ladders

A fixed platform, walkway, stairway, ladder and any going and riser, landing, handrail or barrier attached thereto may comply with AS 1657 in lieu of **D2.13**, **D2.14**, **D2.16** and **D2.17** if it only serves:

- (a) machinery rooms, boiler houses, lift-machine rooms, plant-rooms, and the like; or
- (b) *non-habitable rooms*, such as attics, storerooms and the like that are not used on a frequent or daily basis in the internal parts of a *sole-occupancy unit* in a Class 2 building or Class 4 part of a building.

D2.19 Doorways and doors

- (a) A doorway in a *resident use area* of a Class 9c building must not be fitted with—
 - (i) a sliding fire door; or
 - (ii) a sliding smoke door; or
 - (iii) a revolving door; or

Deemed-to-Satisfy Provisions

- (iv) a roller shutter door; or
- (v) a tilt-up door.
- (b) A doorway serving as a *required exit* or forming part of a *required exit*, or a doorway in a *patient care area* of a Class 9a *health-care building*—
 - (i) must not be fitted with a revolving door; and
 - (ii) must not be fitted with a roller shutter or tilt-up door unless—
 - (A) it serves a Class 6, 7 or 8 building or part with a *floor area* not more than 200 m²; and
 - (B) the doorway is the only *required exit* from the building or part; and
 - (C) it is held in the open position while the building or part is lawfully occupied; and
 - (iii) must not be fitted with a sliding door unless—
 - (A) it leads directly to a road or *open space*; and
 - (B) the door is able to be opened manually under a force of not more than 110 N; and
 - (iv) if fitted with a door which is power-operated—
 - (A) it must be able to be opened manually under a force of not more than 110 N if there is a malfunction or failure of the power source; and
 - (B) if it leads directly to a road or *open space* it must open automatically if there is a power failure to the door or on the activation of a fire or smoke alarm anywhere in the *fire compartment* served by the door.

NSW D2.19(b)(v)

- (c) A power-operated door in a path of travel to a *required exit*, except for a door in a *patient care area* of a Class 9a *health-care building* as provided in (b), must be able to be opened manually under a force of not more than 110 N if there is a malfunction or failure of the power source.

D2.20 Swinging doors

A swinging door in a *required exit* or forming part of a *required exit*—

- (a) must not encroach—
 - (i) at any part of its swing by more than 500 mm on the *required* width (including any landings) of a *required*—
 - (A) stairway; or
 - (B) ramp; or
 - (C) passageway,if it is likely to impede the path of travel of the people already using the *exit*; and
 - (ii) when fully open, by more than 100 mm on the *required* width of the *required exit*, and

the measurement of encroachment in each case is to include door handles or other furniture or attachments to the door; and

Deemed-to-Satisfy Provisions

- (b) must swing in the direction of egress unless—
 - (i) it serves a building or part with a *floor area* not more than 200 m², it is the only *required exit* from the building or part and it is fitted with a device for holding it in the open position; or
 - (ii) it serves a *sanitary compartment* or airlock (in which case it may swing in either direction); and
- (c) must not otherwise impede the path or direction of egress.

D2.21 Operation of latch

Vic D2.21(a)

- (a) A door in a *required exit*, forming part of a *required exit* or in the path of travel to a *required exit* must be readily openable without a key from the side that faces a person seeking egress, by—
 - (i) a single hand downward action on a single device which is located between 900 mm and 1.1 m from the floor and if serving an area *required* to be *accessible* by **Part D3**—
 - (A) be such that the hand of a person who cannot grip will not slip from the handle during the operation of the latch; and
 - (B) have a clearance between the handle and the back plate or door face at the centre grip section of the handle of not less than 35 mm and not more than 45 mm; or
 - (ii) a single hand pushing action on a single device which is located between 900 mm and 1.2 m from the floor.
- (b) The requirements of (a) do not apply to a door that—
 - (i) serves a vault, strong-room, *sanitary compartment*, or the like; or
 - (ii) serves only, or is within—
 - (A) a *sole-occupancy unit* in a Class 2 building or a Class 4 part of a building; or
 - (B) a *sole-occupancy unit* in a Class 3 building (other than an entry door to a *sole-occupancy unit* of a boarding house, guest house, hostel, lodging house or backpacker accommodation); or
 - (C) a *sole-occupancy unit* with a *floor area* not more than 200 m² in a Class 5, 6, 7 or 8 building; or
 - (D) a space which is otherwise inaccessible to persons at all times when the door is locked; or
 - (iii) serves—
 - (A) Australian Government Security Zones 4 or 5; or
 - (B) the secure parts of a bank, *detention centre*, mental health facility, *early childhood centre* or the like; andit can be immediately unlocked—
 - (C) by operating a fail-safe control switch, not contained within a protective enclosure, to actuate a device to unlock the door; or

Deemed-to-Satisfy Provisions

- (D) by hand by a person or persons, specifically nominated by the owner, properly instructed as to the duties and responsibilities involved and available at all times when the building is lawfully occupied so that persons in the building or part may immediately escape if there is a fire; or
- (iv) is fitted with a fail-safe device which *automatically* unlocks the door upon the activation of any sprinkler system complying with **Specification E1.5** or smoke, or any other detector system deemed suitable in accordance with AS 1670.1 installed throughout the building; or
- (v) is in a Class 9a or 9c building and—
 - (A) is one leaf of a two-leaf door complying with **D1.6(f)(i)** or **D1.6(f)(iv)** provided that it is not held closed by a locking mechanism and is readily openable; and
 - (B) the door is not *required* to be a fire door or smoke door.

NSW D2.21(c), (d)

SA D2.21(c)

- (c) The requirements of **(a)** do not apply in a Class 9b building (other than a *school*, an *early childhood centre* or a building used for religious purposes) to a door in a *required exit*, forming part of a *required exit* or in the path of travel to a *required exit* serving a *storey* or room accommodating more than 100 persons, determined in accordance with **D1.13**, in which case it must be readily openable—
 - (i) without a key from the side that faces a person seeking egress; and
 - (ii) by a single hand pushing action on a single device such as a panic bar located between 900 mm and 1.2 m from the floor; and
 - (iii) where a two-leaf door is fitted, the provisions of **(i)** and **(ii)** need only apply to one door leaf if the appropriate requirements of **D1.6** are satisfied by the opening of that one leaf.

D2.22 Re-entry from fire-isolated exits

- (a) Doors of a fire-isolated *exit* must not be locked from the inside as follows:
 - (i) In a Class 9a *health-care building*.
 - (ii) In a Class 9c building.
 - (iii) In a fire-isolated *exit* serving any storey above an *effective height* of 25 m, throughout the *exit*.
- (b) The requirements of **(a)** do not apply to a door fitted with a fail-safe device that *automatically* unlocks the door upon the activation of a fire alarm and—
 - (i) on at least every fourth *storey*, the doors are not able to be locked and a sign is fixed on such doors stating that re-entry is available; or
 - (ii) an intercommunication system, or an audible or visual alarm system, operated from within the enclosure is provided near the doors and a sign is fixed adjacent to such doors explaining its purpose and method of operation.

Deemed-to-Satisfy Provisions

D2.23 Signs on doors

- (a) A sign, to alert persons that the operation of certain doors must not be impaired, must be installed where it can readily be seen on, or adjacent to, a—
- (i)
 - (A) *required* fire door providing direct access to a fire-isolated *exit*, except a door providing direct egress from a *sole-occupancy unit* in a Class 2 or 3 building or Class 4 part of a building; and
 - (B) *required* smoke door,
on the side of the door that faces a person seeking egress and, if the door is fitted with a device for holding it in the open position, on either the wall adjacent to the doorway or both sides of the door; and
 - (ii)
 - (A) fire door forming part of a *horizontal exit*; and
 - (B) smoke door that swings in both directions; and
 - (C) door leading from a fire isolated *exit* to a road or *open space*,
on each side of the door.
- (b) A sign referred to in (a) must be in capital letters not less than 20 mm high in a colour contrasting with the background and state—
- (i) for an *automatic* door held open by an *automatic* hold-open device—
“FIRE SAFETY DOOR—DO NOT OBSTRUCT”; or
 - (ii) for a *self-closing* door—
**“FIRE SAFETY DOOR
DO NOT OBSTRUCT
DO NOT KEEP OPEN”**; or
 - (iii) for a door discharging from a fire-isolated *exit*—
“FIRE SAFETY DOOR—DO NOT OBSTRUCT”.

D2.24 Protection of openable windows

- (a) A window opening must be provided with protection, if the floor below the window is 2 m or more above the surface beneath in—
- (i) a bedroom in a Class 2 or 3 building or Class 4 part of a building; or
 - (ii) a Class 9b *early childhood centre*.
- (b) Where the lowest level of the window opening is less than 1.7 m above the floor, a window opening covered by (a) must comply with the following:
- (i) The openable portion of the window must be protected with—
 - (A) a device capable of restricting the window opening; or
 - (B) a screen with secure fittings.
 - (ii) A device or screen *required* by (i) must—

Deemed-to-Satisfy Provisions

- (A) not permit a 125 mm sphere to pass through the window opening or screen; and
 - (B) resist an outward horizontal action of 250 N against the—
 - (aa) window restrained by a device; or
 - (bb) screen protecting the opening; and
 - (C) have a child resistant release mechanism if the screen or device is able to be removed, unlocked or overridden.
- (c) A barrier with a height not less than 865 mm above the floor is *required* to an openable window—
- (i) in addition to window protection, when a child resistant release mechanism is *required* by **(b)(ii)(C)**; and
 - (ii) where the floor below the window is 4 m or more above the surface beneath if the window is not covered by **(a)**.
- (d) A barrier covered by **(c)** except for **(e)** must not—
- (i) permit a 125 mm sphere to pass through it; and
 - (ii) have any horizontal or near horizontal elements between 150 mm and 760 mm above the floor that facilitate climbing.
- (e) A barrier *required* by **(c)** to an openable window in—
- (i) *fire-isolated stairways*, *fire-isolated ramps* and other areas used primarily for emergency purposes, excluding external stairways and external ramps; and
 - (ii) Class 7 (other than *carparks*) and Class 8 buildings and parts of buildings containing those classes;
- must not permit a 300mm sphere to pass through it.

D2.25 Timber stairways: Concession

- (a) Notwithstanding **D2.2(a)**, timber treads, risers, landings and associated supporting framework which—
- (i) has a finished thickness of not less than 44 mm; and
 - (ii) has an average density of not less than 800 kg/m³ at a moisture content of 12%, may be used within a *required fire-isolated stairway* or *fire-isolated passageway* constructed from *fire-protected timber* in accordance with **C1.13** subject to—
 - (iii) the building being protected throughout by a sprinkler system complying with **Specification E1.5** which extends to within the fire-isolated enclosure; and
 - (iv) fire protection being provided to the underside of stair *flights* and landings located immediately above a landing level which—
 - (A) is at or near the level of egress; or
 - (B) provides direct access to a carpark.
- (b) Fire protection required by **(a)** must be not less than one layer of 13 mm fire-protective grade plasterboard fixed in accordance with the system requirements for a *fire-protective covering*.

Deemed-to-Satisfy Provisions

NSW D2.101

PART D3

ACCESS FOR PEOPLE WITH A DISABILITY

Deemed-to-Satisfy Provisions

D3.0 Deemed-to-Satisfy Provisions

Tas D3.0

- (a) Where a *Deemed-to-Satisfy Solution* is proposed, *Performance Requirements DP1* to **DP6**, **DP8** and **DP9** are satisfied by complying with—
- (i) **D1.1** to **D1.16**, **D2.1** to **D2.25** and **D3.1** to **D3.12**; and
 - (ii) in a building containing an *atrium*, **Part G3**; and
 - (iii) in a building in an *alpine area*, **Part G4**; and
 - (iv) for additional requirements for Class 9b buildings, **Part H1**; and
 - (v) for public transport buildings, **Part H2**.
- (b) Where a *Performance Solution* is proposed, the relevant *Performance Requirements* must be determined in accordance with **A0.7**.
- (c) *Performance Requirement DP7* must be complied with if lifts are to be used to assist occupants to evacuate a building.

D3.1 General building access requirements

SA D3.1

Buildings and parts of buildings must be *accessible* as *required* by **Table D3.1**, unless exempted by **D3.4**.

Table D3.1 REQUIREMENTS FOR ACCESS FOR PEOPLE WITH A DISABILITY

Class of building	Access requirements
Class 1b	
(a) Dwellings located on one allotment ⁽¹⁾ and used for short-term holiday accommodation, consisting of—	To and within—
(i) 4 to 10 dwellings	1 dwelling
(ii) 11 to 40 dwellings	2 dwellings
(iii) 41 to 60 dwellings	3 dwellings
(iv) 61 to 80 dwellings	4 dwellings
(v) 81 to 100 dwellings	5 dwellings
(vi) more than 100 dwellings	5 dwellings plus 1 additional dwelling for each additional 30 dwellings or part thereof in excess of 100 dwellings.
(b) A boarding house, bed and breakfast, guest house, hostel or the like, other than those described in (a)	To and within—

Deemed-to-Satisfy Provisions

Table D3.1 REQUIREMENTS FOR ACCESS FOR PEOPLE WITH A DISABILITY — continued

Class of building	Access requirements
	<p>1 bedroom and associated sanitary facilities; and</p> <p>not less than 1 of each type of room or space for use in common by the residents or guests, including a cooking facility, sauna, gymnasium, <i>swimming pool</i>, laundry, games room, eating area, or the like; and</p> <p>rooms or spaces for use in common by all residents on a floor to which access by way of a ramp complying with AS 1428.1 or a passenger lift is provided.</p>
<p>⁽¹⁾ A community or strata-type subdivision or development is considered to be on a single allotment.</p>	
Class 2	
Common areas	<p>From a pedestrian entrance <i>required</i> to be <i>accessible</i> to at least 1 floor containing <i>sole-occupancy units</i> and to the entrance doorway of each <i>sole-occupancy unit</i> located on that level.</p> <p>To and within not less than 1 of each type of room or space for use in common by the residents, including a cooking facility, sauna, gymnasium, <i>swimming pool</i>, common laundry, games room, individual shop, eating area, or the like.</p> <p>Where a ramp complying with AS 1428.1 or a passenger lift is installed—</p> <p>(a) to the entrance doorway of each <i>sole-occupancy unit</i>; and</p> <p>(b) to and within rooms or spaces for use in common by the residents, located on the levels served by the lift or ramp.</p>
Class 3	

Deemed-to-Satisfy Provisions

Table D3.1 REQUIREMENTS FOR ACCESS FOR PEOPLE WITH A DISABILITY — continued

Class of building	Access requirements
<p>If the building or group of buildings contain—</p> <p>1 to 10 <i>sole-occupancy units</i></p> <p>11 to 40 <i>sole-occupancy units</i></p> <p>41 to 60 <i>sole-occupancy units</i></p> <p>61 to 80 <i>sole-occupancy units</i></p> <p>81 to 100 <i>sole-occupancy units</i></p> <p>101 to 200 <i>sole-occupancy units</i></p> <p>201 to 500 <i>sole-occupancy units</i></p> <p>more than 500 <i>sole-occupancy units</i></p>	<p>To and within—</p> <p>1 <i>accessible sole-occupancy unit</i>.</p> <p>2 <i>accessible sole-occupancy units</i>.</p> <p>3 <i>accessible sole-occupancy units</i>.</p> <p>4 <i>accessible sole-occupancy units</i>.</p> <p>5 <i>accessible sole-occupancy units</i>.</p> <p>5 <i>accessible sole-occupancy units</i> plus 1 additional <i>accessible sole-occupancy unit</i> for every 25 units or part thereof in excess of 100.</p> <p>9 <i>accessible sole-occupancy units</i> plus 1 additional <i>accessible sole-occupancy unit</i> for every 30 units or part thereof in excess of 200.</p> <p>19 <i>accessible sole-occupancy units</i> plus 1 additional <i>accessible sole-occupancy unit</i> for every 50 units or part thereof in excess of 500.</p>
Class 5	To and within all areas normally used by the occupants.
Class 6	To and within all areas normally used by the occupants.
Class 7a	To and within any level containing <i>accessible</i> carparking spaces.
Class 7b	To and within all areas normally used by the occupants.
Class 8	To and within all areas normally used by the occupants.
Class 9a	To and within all areas normally used by the occupants.
Class 9b	
<p><i>Schools</i> and <i>early childhood centres</i></p> <p>An <i>assembly building</i> not being a <i>school</i> or an <i>early childhood centre</i></p>	<p>To and within all areas normally used by the occupants.</p> <p>To wheelchair seating spaces provided in accordance with D3.9.</p> <p>To and within all other areas normally used by the occupants, except that access need not be provided to tiers or platforms of seating areas that do not contain wheelchair seating spaces.</p>

Deemed-to-Satisfy Provisions

Table D3.1 REQUIREMENTS FOR ACCESS FOR PEOPLE WITH A DISABILITY — continued

Class of building	Access requirements
Class 9c	
Common areas	<p>From a pedestrian entrance <i>required</i> to be <i>accessible</i> to at least 1 floor containing <i>sole-occupancy units</i> and to the entrance doorway of each <i>sole-occupancy unit</i> located on that level.</p> <p>To and within not less than 1 of each type of room or space for use in common by the residents, including a cooking facility, sauna, gymnasium, <i>swimming pool</i>, common laundry, games room, TV room, individual shop, dining room, public viewing area, ticket purchasing service, lunch room, lounge room, or the like.</p> <p>Where a ramp complying with AS 1428.1 or a passenger lift is installed—</p> <ul style="list-style-type: none"> (a) to the entrance doorway of each <i>sole-occupancy unit</i>; and (b) to and within rooms or spaces for use in common by the residents, <p>located on the levels served by the lift or ramp.</p>
<i>Sole-occupancy units</i>	<p>Where more than 2 <i>accessible sole-occupancy units</i> are <i>required</i>, they must be representative of the range of rooms available.</p>
If the building or group of buildings contain—	To and within—
1 to 10 <i>sole-occupancy units</i>	1 <i>accessible sole-occupancy unit</i> .
11 to 40 <i>sole-occupancy units</i>	2 <i>accessible sole-occupancy units</i> .
41 to 60 <i>sole-occupancy units</i>	3 <i>accessible sole-occupancy units</i> .
61 to 80 <i>sole-occupancy units</i>	4 <i>accessible sole-occupancy units</i> .
81 to 100 <i>sole-occupancy units</i>	5 <i>accessible sole-occupancy units</i> .
101 to 200 <i>sole-occupancy units</i>	5 <i>accessible sole-occupancy units</i> plus 1 additional <i>sole-occupancy unit</i> for every 25 units or part thereof in excess of 100.
201 to 500 <i>sole-occupancy units</i>	9 <i>accessible sole-occupancy units</i> plus 1 additional <i>sole-occupancy unit</i> for every 30 units or part thereof in excess of 200.
more than 500 <i>sole-occupancy units</i>	19 <i>accessible sole-occupancy units</i> plus 1 additional <i>sole-occupancy unit</i> for every 50 units or part thereof in excess of 500.

Deemed-to-Satisfy Provisions

Table D3.1 REQUIREMENTS FOR ACCESS FOR PEOPLE WITH A DISABILITY — continued

Class of building	Access requirements
<p>Class 10a</p> <p>Non-habitable building located in an <i>accessible</i> area intended for use by the public and containing a sanitary facility, change room facility or shelter</p>	<p>To and within—</p> <p>(a) An <i>accessible</i> sanitary facility; and</p> <p>(b) a change room facility; and</p> <p>(c) a public shelter or the like.</p>
<p>Class 10b</p> <p><i>Swimming pool</i></p>	<p>To and into <i>swimming pools</i> with a total perimeter greater than 40 m, associated with a Class 1b, 2, 3, 5, 6, 7, 8 or 9 building that is <i>required</i> to be <i>accessible</i>, but not <i>swimming pools</i> for the exclusive use of occupants of a Class 1b building or a <i>sole-occupancy unit</i> in a Class 2 or Class 3 building.</p>

SA Table D3.1a

D3.2 Access to buildings

- (a) An *accessway* must be provided to a building *required* to be *accessible*—
 - (i) from the main points of a pedestrian entry at the allotment boundary; and
 - (ii) from another *accessible* building connected by a pedestrian link; and
 - (iii) from any *required accessible* carparking space on the allotment.
- (b) In a building *required* to be *accessible*, an *accessway* must be provided through the principal pedestrian entrance, and—
 - (i) through not less than 50% of all pedestrian entrances including the principal pedestrian entrance; and
 - (ii) in a building with a total *floor area* more than 500 m², a pedestrian entrance which is not *accessible* must not be located more than 50 m from an *accessible* pedestrian entrance,

except for pedestrian entrances serving only areas exempted by **D3.4**.
- (c) Where a pedestrian entrance *required* to be *accessible* has multiple doorways—
 - (i) if the pedestrian entrance consists of not more than 3 doorways — not less than 1 of those doorways must be *accessible*; and
 - (ii) if a pedestrian entrance consists of more than 3 doorways — not less than 50% of those doorways must be *accessible*.
- (d) For the purposes of (c)—
 - (i) an *accessible* pedestrian entrance with multiple doorways is considered to be one pedestrian entrance where—

Deemed-to-Satisfy Provisions

- (A) all doorways serve the same part or parts of the building; and
- (B) the distance between each doorway is not more than the width of the widest doorway at that pedestrian entrance (see **Figure D3.2**); and
- (ii) a doorway is considered to be the clear, unobstructed opening created by the opening of one or more door leaves (see **Figure D3.2**).
- (e) Where a doorway on an *accessway* has multiple leaves, (except an automatic opening door) one of those leaves must have a clear opening width of not less than 850 mm in accordance with AS 1428.1.

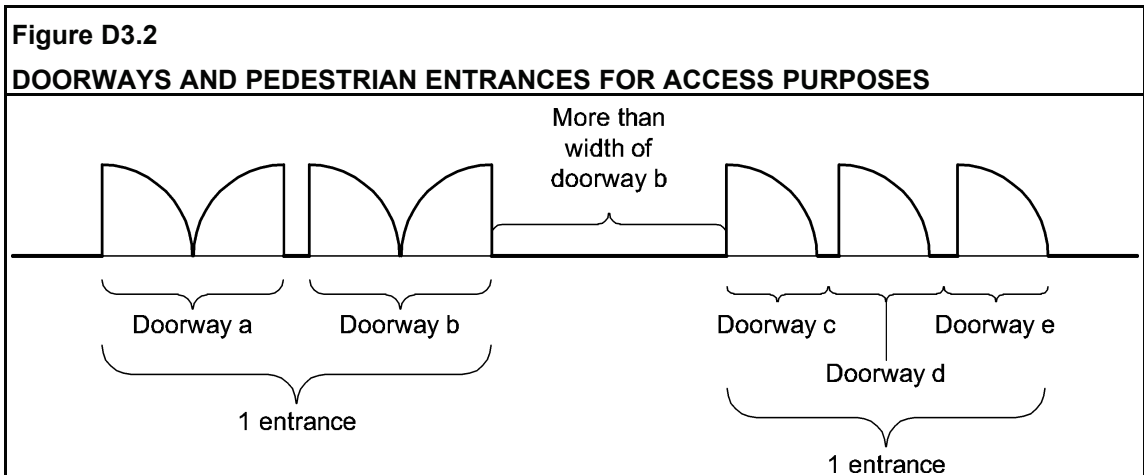

D3.3 Parts of buildings to be accessible

In a building *required* to be *accessible*—

- (a) every ramp and stairway, except for ramps and stairways in areas exempted by **D3.4**, must comply with—
 - (i) for a ramp, except a *fire-isolated ramp*, clause 10 of AS 1428.1; and
 - (ii) for a stairway, except a *fire-isolated stairway*, clause 11 of AS 1428.1; and
 - (iii) for a *fire-isolated stairway*, clause 11.1(f) and (g) of AS 1428.1; and
- (b) every passenger lift must comply with **E3.6**; and
- (c) *accessways* must have—
 - (i) passing spaces complying with AS 1428.1 at maximum 20 m intervals on those parts of an *accessway* where a direct line of sight is not available; and
 - (ii) turning spaces complying with AS 1428.1—
 - (A) within 2 m of the end of *accessways* where it is not possible to continue travelling along the *accessway*; and
 - (B) at maximum 20 m intervals along the *accessway*; and
- (d) an intersection of *accessways* satisfies the spatial requirements for a passing and turning space; and
- (e) a passing space may serve as a turning space; and

Deemed-to-Satisfy Provisions

- (f) a ramp complying with AS 1428.1 or a passenger lift need not be provided to serve a *storey* or level other than the entrance *storey* in a Class 5, 6, 7b or 8 building—
 - (i) containing not more than 3 *storeys*; and
 - (ii) with a *floor area* for each *storey*, excluding the entrance *storey*, of not more than 200 m²; and
- (g) clause 7.4.1(a) of AS 1428.1 does not apply and is replaced with 'the pile height or pile thickness shall not exceed 11 mm and the carpet backing thickness shall not exceed 4 mm'; and
- (h) the carpet pile height or pile thickness dimension, carpet backing thickness dimension and their combined dimension shown in Figure 8 of AS 1428.1 do not apply and are replaced with 11 mm, 4 mm and 15 mm respectively.

D3.4 Exemptions

The following areas are not *required* to be *accessible*:

- (a) An area where access would be inappropriate because of the particular purpose for which the area is used.
- (b) An area that would pose a health or safety risk for people with a disability.
- (c) Any path of travel providing access only to an area exempted by (a) or (b).

ACT D3.4(d)

D3.5 Accessible carparking

Accessible carparking spaces—

- (a) subject to (b), must be provided in accordance with **Table D3.5** in—
 - (i) a Class 7a building *required* to be *accessible*; and
 - (ii) a carparking area on the same allotment as a building *required* to be *accessible*; and
- (b) need not be provided in a Class 7a building or a carparking area where a parking service is provided and direct access to any of the carparking spaces is not available to the public; and
- (c) subject to (d), must comply with AS/NZS 2890.6; and
- (d) need not be designated where there is a total of not more than 5 carparking spaces, so as to restrict the use of the carparking space only for people with a disability.

Deemed-to-Satisfy Provisions

Table D3.5 CARPARKING SPACES FOR PEOPLE WITH A DISABILITY

Class of building to which the <i>carpark</i> or carparking area is associated	Number of <i>accessible</i> carparking spaces <i>required</i>
Class 1b and 3	
(a) Boarding house, guest house, hostel, lodging house, backpackers accommodation, or the residential part of a hotel or motel.	To be calculated by multiplying the total number of carparking spaces by the percentage of— (i) <i>accessible sole-occupancy units</i> to the total number of <i>sole-occupancy units</i> ; or (ii) <i>accessible</i> bedrooms to the total number of bedrooms; and the calculated number is to be taken to the next whole figure.
(b) Residential part of a <i>school</i> , accommodation for the aged, disabled or children, residential part of a <i>health-care building</i> which accommodates members of staff or the residential part of a <i>detention centre</i> .	1 space for every 100 carparking spaces or part thereof.
Class 5, 7, 8 or 9c	1 space for every 100 carparking spaces or part thereof.
Class 6	
(a) Up to 1000 carparking spaces; and	1 space for every 50 carparking spaces or part thereof.
(b) for each additional 100 carparking spaces or part thereof in excess of 1000 carparking spaces.	1 space.
Class 9a	
(a) Hospital (non-outpatient area)	1 space for every 100 carparking spaces or part thereof.
(b) Hospital (outpatient area)—	
(i) up to 1000 carparking spaces; and	1 space for every 50 carparking spaces or part thereof.
(ii) for each additional 100 carparking spaces or part thereof in excess of 1000 carparking spaces.	1 space.
(c) Nursing home	1 space for every 100 carparking spaces or part thereof.
(d) Clinic or day surgery not forming part of a hospital.	1 space for every 50 carparking spaces or part thereof.

Deemed-to-Satisfy Provisions

Table D3.5 CARPARKING SPACES FOR PEOPLE WITH A DISABILITY — continued

Class of building to which the <i>carpark</i> or <i>carparking area</i> is associated	Number of <i>accessible</i> carparking spaces <i>required</i>
Class 9b	
(a) <i>School</i>	1 space for every 100 carparking spaces or part thereof.
(b) Other <i>assembly building</i> —	
(i) up to 1000 carparking spaces; and	1 space for every 50 carparking spaces or part thereof.
(ii) for each additional 100 carparking spaces or part thereof in excess of 1000 carparking spaces.	1 space.

D3.6 Signage

In a building *required* to be *accessible*—

- (a) braille and tactile signage complying with **Specification D3.6** must—
 - (i) incorporate the international symbol of access or deafness, as appropriate, in accordance with AS 1428.1 and identify each—
 - (A) sanitary facility, except a sanitary facility within a *sole-occupancy unit* in a Class 1b or Class 3 building; and
 - (B) space with a hearing augmentation system; and
 - (ii) identify each door *required* by **E4.5** to be provided with an *exit* sign and state—
 - (A) "**Exit**"; and
 - (B) "**Level**"; and either
 - (aa) the floor level number; or
 - (bb) a floor level descriptor; or
 - (cc) a combination of **(aa)** and **(bb)**; and
- (b) signage including the international symbol for deafness in accordance with AS 1428.1 must be provided within a room containing a hearing augmentation system identifying—
 - (i) the type of hearing augmentation; and
 - (ii) the area covered within the room; and
 - (iii) if receivers are being used and where the receivers can be obtained; and
- (c) signage in accordance with AS 1428.1 must be provided for *accessible* unisex sanitary facilities to identify if the facility is suitable for left or right handed use; and
- (d) signage to identify an ambulant *accessible* sanitary facility in accordance with AS 1428.1 must be located on the door of the facility; and
- (e) where a pedestrian entrance is not *accessible*, directional signage incorporating the international symbol of access, in accordance with AS 1428.1 must be provided to direct a person to the location of the nearest *accessible* pedestrian entrance; and

Deemed-to-Satisfy Provisions

- (f) where a bank of sanitary facilities is not provided with an *accessible* unisex sanitary facility, directional signage incorporating the international symbol of access in accordance with AS 1428.1 must be placed at the location of the sanitary facilities that are not *accessible*, to direct a person to the location of the nearest *accessible* unisex sanitary facility.

D3.7 Hearing augmentation

- (a) A hearing augmentation system must be provided where an inbuilt amplification system, other than one used only for emergency warning, is installed—
- (i) in a room in a Class 9b building; or
 - (ii) in an auditorium, conference room, meeting room or room for judicatory purposes; or
 - (iii) at any ticket office, teller's booth, reception area or the like, where the public is screened from the service provider.
- (b) If a hearing augmentation system *required* by (a) is—
- (i) an induction loop, it must be provided to not less than 80% of the *floor area* of the room or space served by the inbuilt amplification system; or
 - (ii) a system requiring the use of receivers or the like, it must be available to not less than 95% of the *floor area* of the room or space served by the inbuilt amplification system, and the number of receivers provided must not be less than—
 - (A) if the room or space accommodates up to 500 persons, 1 receiver for every 25 persons or part thereof, or 2 receivers, whichever is the greater; and
 - (B) if the room or space accommodates more than 500 persons but not more than 1000 persons, 20 receivers plus 1 receiver for every 33 persons or part thereof in excess of 500 persons; and
 - (C) if the room or space accommodates more than 1000 persons but not more than 2000 persons, 35 receivers plus 1 receiver for every 50 persons or part thereof in excess of 1000 persons; and
 - (D) if the room or space accommodates more than 2000 persons, 55 receivers plus 1 receiver for every 100 persons or part thereof in excess of 2000 persons.
- (c) The number of persons accommodated in the room or space served by an inbuilt amplification system must be calculated according to **D1.13**.
- (d) Any screen or scoreboard associated with a Class 9b building and capable of displaying public announcements must be capable of supplementing any public address system, other than a public address system used for emergency warning purposes only.

D3.8 Tactile indicators

- (a) For a building *required* to be *accessible*, tactile ground surface indicators must be provided to warn people who are blind or have a vision impairment that they are approaching—
- (i) a stairway, other than a *fire-isolated stairway*; and
 - (ii) an escalator; and

Deemed-to-Satisfy Provisions

- (iii) a passenger conveyor or moving walk; and
- (iv) a ramp other than a *fire-isolated ramp*, step ramp, kerb ramp or *swimming pool ramp*; and
- (v) in the absence of a suitable barrier—
 - (A) an overhead obstruction less than 2 m above floor level, other than a doorway; and
 - (B) an *accessway* meeting a vehicular way adjacent to any pedestrian entrance to a building, excluding a pedestrian entrance serving an area referred to in **D3.4**, if there is no kerb or kerb ramp at that point,

except for areas exempted by **D3.4**.

- (b) Tactile ground surface indicators *required* by (a) must comply with sections 1 and 2 of AS/NZS 1428.4.1.
- (c) A hostel for the aged, nursing home for the aged, a *residential aged care building* Class 3 accommodation for the aged, Class 9a *health-care building* or a Class 9c building need not comply with (a)(i) and (iv) if handrails incorporating a raised dome button in accordance with the requirements for stairway handrails in AS 1428.1 are provided to warn people who are blind or have a vision impairment that they are approaching a stairway or ramp.

D3.9 Wheelchair seating spaces in Class 9b assembly buildings

Where fixed seating is provided in a Class 9b *assembly building*, wheelchair seating spaces complying with AS 1428.1 must be provided in accordance with the following:

- (a) The number and grouping of wheelchair seating spaces must be in accordance with **Table D3.9**.
- (b) In a cinema—
 - (i) with not more than 300 seats — wheelchair seating spaces must not be located in the front row of seats; and
 - (ii) with more than 300 seats — not less than 75% of *required* wheelchair seating spaces must be located in rows other than the front row of seats; and
 - (iii) the location of wheelchair seating is to be representative of the range of seating provided.

Table D3.9 WHEELCHAIR SEATING SPACES IN CLASS 9b ASSEMBLY BUILDINGS

Number of fixed seats in a room or space	Number of wheelchair seating spaces	Grouping and location
Up to 150	3 spaces	1 single space; and 1 group of 2 spaces.
151 to 800	3 spaces; plus	Not less than 1 single space; and

Deemed-to-Satisfy Provisions

Table D3.9 WHEELCHAIR SEATING SPACES IN CLASS 9b ASSEMBLY BUILDINGS — continued

Number of fixed seats in a room or space	Number of wheelchair seating spaces	Grouping and location
	1 additional space for each additional 50 seats or part thereof in excess of 150 seats	not less than 1 group of 2 spaces; and not more than 5 spaces in any other group.
801 to 10 000	16 spaces; plus 1 additional space for each additional 100 seats or part thereof in excess of 800 seats	Not less than 2 single spaces; and not less than 2 groups of 2 spaces; and not more than 5 spaces in any other group; and the location of spaces is to be representative of the range of seating provided.
More than 10 000	108 spaces; plus 1 additional space for each additional 200 seats or part thereof in excess of 10 000 seats	Not less than 5 single spaces; and not less than 5 groups of 2 spaces; and not more than 10 spaces in any other group; and the location of spaces is to be representative of the range of seating provided.

D3.10 Swimming pools

- (a) Not less than 1 means of *accessible* water entry/exit in accordance with **Specification D3.10** must be provided for each *swimming pool required* by **Table D3.1** to be *accessible*.
- (b) An *accessible* entry/exit must be by means of—
 - (i) a fixed or movable ramp and an aquatic wheelchair; or
 - (ii) a zero depth entry at a maximum gradient of 1:14 and an aquatic wheelchair; or
 - (iii) a platform *swimming pool* lift and an aquatic wheelchair; or
 - (iv) a sling-style *swimming pool* lift.
- (c) Where a *swimming pool* has a perimeter of more than 70 m in length, at least one *accessible* water entry/exit must be provided by a means specified in **(b)(i), (ii) or (iii)**.
- (d) Latching devices on gates and doors forming part of a *swimming pool* safety barrier need not comply with AS 1428.1.

D3.11 Ramps

On an *accessway*—

Deemed-to-Satisfy Provisions

- (a) a series of connected ramps must not have a combined vertical rise of more than 3.6 m; and
- (b) a landing for a step ramp must not overlap a landing for another step ramp or ramp.

D3.12 Glazing on an accessway

On an *accessway*, where there is no chair rail, handrail or transom, all frameless or fully glazed doors, sidelights and any glazing capable of being mistaken for a doorway or opening, must be clearly marked in accordance with AS 1428.1.

SPECIFICATION D1.12 NON-REQUIRED STAIRWAYS, RAMPS AND ESCALATORS

Deemed-to-Satisfy Provisions

1. Scope

This Specification contains the requirements to allow non-*required* stairways, ramps or escalators to connect any number of *storeys* in a Class 5 or 6 building. The requirements do not apply in an *atrium* or outside a building.

2. Requirements

An escalator, moving walkway or non-*required* non-*fire-isolated stairway* or pedestrian ramp must comply with the following:

- (a) The escalator, walkway, stairway or ramp must be bounded by a *shaft* of—
 - (i) construction with an FRL of not less than 120/120/120 if *loadbearing* or –/120/120 if non-*loadbearing* and if of *lightweight construction* must comply with **Specification C1.8**; or
 - (ii) glazed construction with an FRL of not less than –/60/30 protected by a wall wetting system in accordance with **Clause 2.4 of Specification G3.8**.
- (b) The void of each non-*required* stairway, ramp or escalator must not connect more than 2 *storeys*.
- (c) Rising and descending escalators, walkways, stairways and ramps within one *shaft* must be separated by construction with an FRL of not less than –/60/30.
- (d) Openings into the *shaft* must be protected by fire doors with an FRL not less than –/60/30.
- (e) When the fire door is in the closed position, the floor or any covering over the floor beneath the fire door must not be *combustible*.
- (f) Fire doors must be fitted with smoke seals and the assembly must be tested in accordance with AS 1530.4.
- (g) Fire doors must be—
 - (i) closed and locked for security reasons; or
 - (ii) held open and be *automatic* closing.
- (h) Smoke detectors must be installed on both sides of the opening, not more than 1.5 m horizontal distance from the opening.
- (i) In the closed position, fire doors must be openable on a single hand downward action or horizontal pushing action on a single device within the *shaft* and by key only from outside the *shaft*.
- (j) A warning sign must be displayed where it can readily be seen outside the *shaft* near all fire doors opening to the *shaft*. The sign must comply with the details and dimensions of **Figure 2**.

Deemed-to-Satisfy Provisions

Figure 2 WARNING SIGN FOR NON-REQUIRED STAIRWAY, RAMP OR ESCALATOR

**DO NOT USE THIS STAIRWAY IF
THERE IS A FIRE** =20 mm

OR

**Do not use this stairway if there is
a fire** =16 mm

- (k) All doors opening into the *shaft* must be within 20 m of a *required exit*.
- (l) Signs showing the direction of the nearest *required exit* must be installed where they can be readily seen.
- (m) Materials attached to any wall, ceiling or floor within the *shaft* must comply with **Specification C1.10**.
- (n) Emergency lighting must be installed in the *shaft* in accordance with **E4.4**.
- (o) No step or ramp may be closer to the threshold of the doorway than the width of the door leaf.

SPECIFICATION **D3.6** BRAILLE AND TACTILE SIGNS

Deemed-to-Satisfy Provisions

1. Scope

This Specification sets out the requirements for the design and installation of braille and tactile signage as *required* by **D3.6**.

2. Location of braille and tactile signs

Signs including symbols, numbering and lettering must be designed and installed as follows:

- (a) Braille and tactile components of a sign must be located not less than 1200 mm and not higher than 1600 mm above the floor or ground surface.
- (b) Signs with single lines of characters must have the line of tactile characters not less than 1250 mm and not higher than 1350 mm above the floor or ground surface.
- (c) Signs identifying rooms containing features or facilities listed in **D3.6** must be located—
 - (i) on the wall on the latch side of the door with the leading edge of the sign located between 50 mm and 300 mm from the architrave; and
 - (ii) where (i) is not possible, the sign may be placed on the door itself.
- (d) Signs identifying a door *required* by **E4.5** to be provided with an *exit* sign must be located—
 - (i) on the side that faces a person seeking egress; and
 - (ii) on the wall on the latch side of the door with the leading edge of the sign located between 50 mm and 300 mm from the architrave; and
 - (iii) where (ii) is not possible, the sign may be placed on the door itself.

3. Braille and tactile sign specification

- (a) Tactile characters must be raised or embossed to a height of not less than 1 mm and not more than 1.5 mm.
- (b) Sentence case (upper case for the first letter of each main word and lower case for all other letters) must be used for all tactile characters, and—
 - (i) upper case tactile characters must have a height of not less than 15 mm and not more than 55 mm, except that the upper case tactile characters on a sign identifying a door *required* by **E4.5** to be provided with an *exit* sign must have a height of not less than 20 mm and not more than 55 mm; and
 - (ii) lower case tactile characters must have a height of 50% of the related upper case characters.
- (c) Tactile characters, symbols, and the like, must have rounded edges.
- (d) The entire sign, including any frame, must have all edges rounded.
- (e) The background, negative space or fill of signs must be of matt or low sheen finish.

Deemed-to-Satisfy Provisions

- (f) The characters, symbols, logos and other features on signs must be matt or low sheen finish.
- (g) The minimum letter spacing of tactile characters on signs must be 2 mm.
- (h) The minimum word spacing of tactile characters on signs must be 10 mm.
- (i) The thickness of letter strokes must be not less than 2 mm and not more than 7 mm.
- (j) Tactile text must be left justified, except that single words may be centre justified.
- (k) Tactile text must be Arial typeface.

4. Luminance contrast

The following applies to *luminance contrast*:

- (a) The background, negative space, fill of a sign or border with a minimum width of 5 mm must have a *luminance contrast* with the surface on which it is mounted of not less than 30%.
- (b) Tactile characters, icons and symbols must have a minimum *luminance contrast* of 30% to the surface on which the characters are mounted.
- (c) *Luminance contrasts* must be met under the lighting conditions in which the sign is to be located.

5. Lighting

Braille and tactile signs must be illuminated to ensure *luminance contrast* requirements are met at all times during which the sign is required to be read.

6. Braille

The following applies to braille:

- (a) Braille must be grade 1 braille (uncontracted) in accordance with the criteria set out by the Australian Braille Authority.
- (b) Braille must be raised and domed.
- (c) Braille must be located 8 mm below the bottom line of text (not including descenders).
- (d) Braille must be left justified.
- (e) Where an arrow is used in the tactile sign, a solid arrow must be provided for braille readers.
- (f) On signs with multiple lines of text and characters, a semicircular braille locator at the left margin must be horizontally aligned with the first line of braille text.

SPECIFICATION **D3.10** ACCESSIBLE WATER ENTRY/EXIT
FOR SWIMMING POOLS

Deemed-to-Satisfy Provisions

1. Scope

This Specification sets out the requirements for types of *accessible* water entry/exit for *swimming pools*.

2. Fixed or moveable ramp

A fixed or moveable ramp must—

- (a) have a slip-resistant surface; and
- (b) have a maximum gradient of 1:14; and
- (c) have handrails complying with the requirements for ramps in AS 1428.1, installed on both sides of the ramp; and
- (d) have kerbs in accordance with the requirements for ramps in AS 1428.1; and
- (e) extend to a depth of not less than 900 mm and not more than 1100 mm below the stationary water level; and
- (f) have landings in accordance with the requirements for ramps in AS 1428.1, with a landing located at the bottom and top of each ramp and a landing must be located at a level between 900 mm and 1100 mm below the stationary water level.

3. Zero depth entry

A zero depth entry must have—

- (a) a slip-resistant surface; and
- (b) a maximum gradient of 1:14; and
- (c) a single handrail complying with the requirements for handrails in AS 1428.1, from the top of the entry point continuous to the bottom level area; and
- (d) a level area—
 - (i) 1500 mm long for the width of the zero depth entry at the entry point; and
 - (ii) located at the bottom of the zero depth entry at a level between 900 mm and 1100 mm below the stationary water level.

4. Platform swimming pool lift

A platform *swimming pool* lift must be—

- (a) capable of being operated from the *swimming pool* surround, within the *swimming pool*, and on the platform; and
- (b) located where the water depth is not more than 1300 mm; and

Deemed-to-Satisfy Provisions

- (c) designed to withstand a weight capacity of not less than 160 kg and be capable of sustaining a static load of not less than 1.5 times the rated load.

5. Sling-style swimming pool lift

A sling lift must comply with the following:

- (a) A sling lift must be located where the water depth is not more than 1300 mm.
- (b) When the sling is in the raised position and in the transfer position, the centreline of the sling must be located over the *swimming pool* surround and not less than 450 mm from the *swimming pool* edge.
- (c) The surface of the *swimming pool* surround between the centreline of the sling and the *swimming pool* edge must have a gradient of not more than 1:50 and must be slip-resistant.
- (d) A clear space—
 - (i) not less than 900 mm x 1300 mm; and
 - (ii) with a gradient of not more than 1:50; and
 - (iii) having a slip-resistant surface; and
 - (iv) located so that the centreline of the space is directly below the lifting point for the sling,
must be provided on the *swimming pool* surround parallel with the *swimming pool* edge on the side remote from the water (see **Figure 5**).
- (e) A sling lift must be capable of being operated from the *swimming pool* surround, within the *swimming pool* and from the sling.
- (f) A sling must be designed so that it will submerge to a water depth of not less than 500 mm below the stationary water level.
- (g) A sling lift must be designed to withstand a weight of not less than 136 kg and be capable of sustaining a static load not less than 1.5 times the rated load.

Deemed-to-Satisfy Provisions

Figure 5
CLEAR SWIMMING POOL SURROUND SPACE FOR SLING LIFT

Diagram a. Clear pool surround space for sling lift
Plan view

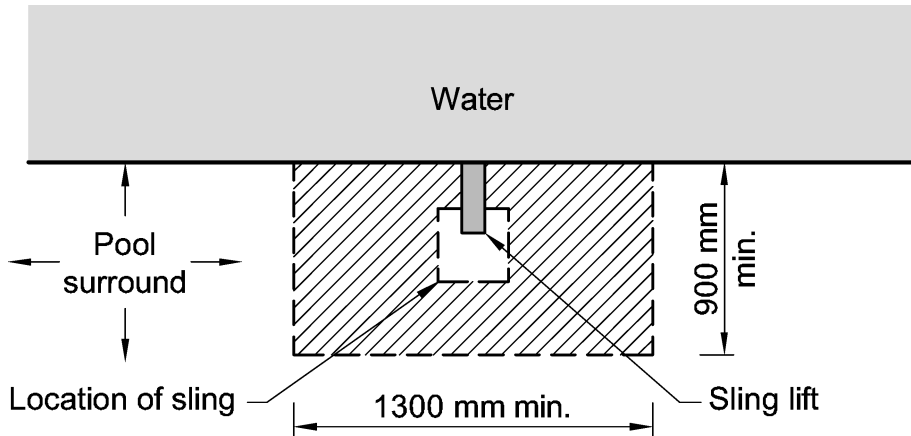
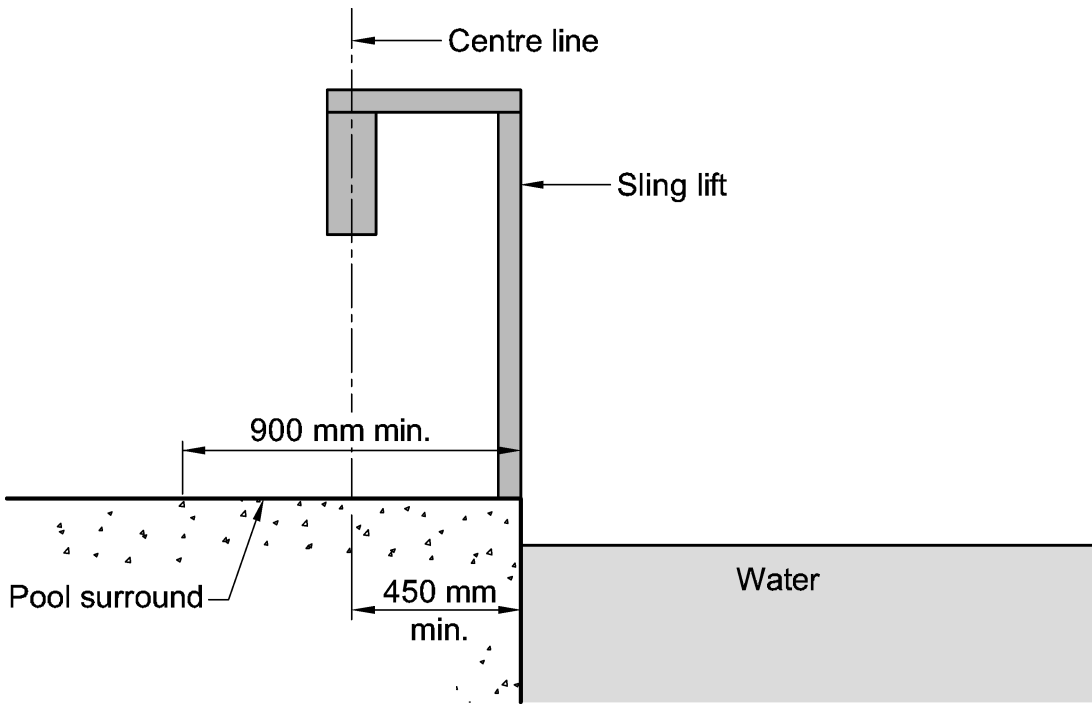

Diagram b. Clear space for sling lift in the transfer position
Sectional elevation



6. Aquatic wheelchair

An aquatic wheelchair must comply with the following:

Deemed-to-Satisfy Provisions

- (a) The height of the top surface of the seat must be not less than 430 mm.
- (b) The seat width must not be not less than 480 mm.
- (c) A footrest must be provided.
- (d) Armrests must be located on both sides of the seat and must be capable of being moved away from the side of the chair to allow a person to transfer on and off the seat.

SECTION **E**

SERVICES AND EQUIPMENT

- E1** **Fire Fighting Equipment**
- E2** **Smoke Hazard Management**
- E3** **Lift Installations**
- E4** **Visibility in an Emergency, Exit Signs and Warning Systems**

SECTION E CONTENTS

SECTION E SERVICES AND EQUIPMENT

Part E1 Fire Fighting Equipment

Performance Requirements EP1.1 - EP1.6

E1.0 Deemed-to-Satisfy Provisions

E1.1 * * * * *

E1.2 * * * * *

E1.3 Fire hydrants

E1.4 Fire hose reels

E1.5 Sprinklers

E1.6 Portable fire extinguishers

E1.7 * * * * *

E1.8 Fire control centres

E1.9 Fire precautions during construction

E1.10 Provision for special hazards

Specification E1.5 Fire Sprinkler Systems

Specification E1.8 Fire Control Centres

Part E2 Smoke Hazard Management

Performance Requirements EP2.1 - EP2.2

E2.0 Deemed-to-Satisfy Provisions

E2.1 Application of Part

E2.2 General requirements

E2.3 Provision for special hazards

Specification E2.2a Smoke Detection and Alarm Systems

Specification E2.2b Smoke Exhaust Systems

Specification E2.2c Smoke-and-Heat Vents

Part E3 Lift Installations

Performance Requirements EP3.1 - EP3.4

E3.0 Deemed-to-Satisfy Provisions

E3.1 Lift installations

E3.2 Stretcher facility in lifts

E3.3 Warning against use of lifts in fire

E3.4 Emergency lifts

E3.5 Landings

E3.6 Passenger lifts

E3.7 Fire service controls

E3.8 Aged care buildings

E3.9 Fire service recall control switch

E3.10 Lift car fire service drive control switch

Specification E3.1 Lift Installations

Part E4 Visibility in an Emergency, Exit Signs and Warning Systems

ARCHIVED
SERVICES AND EQUIPMENT

Performance Requirements EP4.1 - EP4.3
Verification Methods EV4.1 Emergency Lighting
E4.0 Deemed-to-Satisfy Provisions
E4.1 * * * * *
E4.2 Emergency lighting requirements
E4.3 Measurement of distance
E4.4 Design and operation of emergency lighting
E4.5 Exit signs
E4.6 Direction signs
E4.7 Class 2 and 3 buildings and Class 4 parts: Exemptions
E4.8 Design and operation of exit signs
E4.9 Sound systems and intercom systems for emergency purposes
Specification E4.8 Photoluminescent Exit Signs

PART E1 FIRE FIGHTING EQUIPMENT

PERFORMANCE REQUIREMENTS

EP1.1

A fire hose reel system must be installed to the degree necessary to allow occupants to safely undertake initial attack on a fire appropriate to—

- (a) the size of the *fire compartment*; and
- (b) the function or use of the building; and
- (c) any other *fire safety systems* installed in the building; and
- (d) the *fire hazard*.

EP1.2

Fire extinguishers must be installed to the degree necessary to allow occupants to undertake initial attack on a fire appropriate to—

- (a) the function or use of the building; and
- (b) any other *fire safety systems* installed in the building; and
- (c) the *fire hazard*.

EP1.3

A fire hydrant system must be provided to the degree necessary to facilitate the needs of the *fire brigade* appropriate to—

- (a) fire-fighting operations; and
- (b) the *floor area* of the building; and
- (c) the *fire hazard*.

Application:

EP1.3 only applies to a building where a *fire brigade* is available to attend.

EP1.4

NSW EP1.4

An *automatic* fire suppression system must be installed to the degree necessary to control the development and spread of fire appropriate to—

- (a) the size of the *fire compartment*; and
- (b) the function or use of the building; and
- (c) the *fire hazard*; and

- (d) the height of the building.

EP1.5

Suitable means of fire-fighting must be installed to the degree necessary in a building under construction to allow initial fire attack by construction workers and for the *fire brigade* to undertake attack on the fire appropriate to—

- (a) the *fire hazard*; and
(b) the height the building has reached during its construction.

EP1.6

Suitable facilities must be provided to the degree necessary in a building to co-ordinate *fire brigade* intervention during an emergency appropriate to—

- (a) the function or use of the building; and
(b) the *floor area* of the building; and
(c) the height of the building.

Tas EP1.7

PART E1 FIRE FIGHTING EQUIPMENT

Deemed-to-Satisfy Provisions

E1.0 Deemed-to-Satisfy Provisions

Tas E1.0

- (a) Where a *Deemed-to-Satisfy Solution* is proposed, *Performance Requirements EP1.1 to EP1.6* are satisfied by complying with—
- (i) **E1.1 to E1.10**; and
 - (ii) in a building containing an *atrium*, **Part G3**; and
 - (iii) in a building in an *alpine area*, **Part G4**; and
 - (iv) for additional requirements for Class 9b buildings, **Part H1**; and
 - (v) for *farm buildings* and *farm sheds*, **Part H3**.
- (b) Where a *Performance Solution* is proposed, the relevant *Performance Requirements* must be determined in accordance with **A0.7**.

E1.1 * * * * *

This clause has deliberately been left blank.

E1.2 * * * * *

This clause has deliberately been left blank.

E1.3 Fire hydrants

- (a) A fire hydrant system must be provided to serve a building—
- (i) having a total *floor area* greater than 500 m²; and
 - (ii) where a *fire brigade* is available to attend a building fire.
- (b) The fire hydrant system—
- (i) must be installed in accordance with AS 2419.1, except a Class 8 *electricity network substation* need not comply with clause 4.2 of AS 2419.1 if—
 - (A) it cannot be connected to town main supply; and
 - (B) one hour water storage is provided for firefighting; and
 - (ii) where internal fire hydrants are provided, they must serve only the *storey* on which they are located except that a *sole-occupancy unit*—
 - (A) in a Class 2 or 3 building or Class 4 part of a building may be served by a single fire hydrant located at the level of egress from that *sole-occupancy unit*; or
 - (B) of not more than 2 *storeys* in a Class 5, 6, 7, 8 or 9 building may be served by a single fire hydrant located at the level of egress from that *sole-*

Deemed-to-Satisfy Provisions

occupancy unit provided the fire hydrant can provide coverage to the whole of the *sole-occupancy unit*.

E1.4 Fire hose reels

- (a) E1.4 does not apply to—
 - (i) a Class 2 or 3 building or Class 4 part of a building; or
 - (ii) a Class 8 *electricity network substation*; or
 - (iii) a Class 9c building; or
 - (iv) classrooms and associated corridors in a primary or secondary *school*.
- (b) A fire hose reel system must be provided—
 - (i) to serve the whole building where one or more internal fire hydrants are installed; or
 - (ii) where internal fire hydrants are not installed, to serve any *fire compartment* with a *floor area* greater than 500 m².
- (c) The fire hose reel system must—
 - (i) have fire hose reels installed in accordance with AS 2441; and
 - (ii) provide fire hose reels to serve only the *storey* at which they are located, except a *sole-occupancy unit* of not more than 2 *storeys* in a Class 5, 6, 7, 8 or 9 building may be served by a single fire hose reel located at the level of egress from that *sole-occupancy unit* provided the fire hose reel can provide coverage to the whole of the *sole-occupancy unit*.
- (d) Fire hose reels must be located internally, externally or in combination, to achieve the system coverage specified in AS 2441.
- (e) In achieving system coverage, one or a combination of the following criteria for individual internally located fire hose reels must be met in determining the layout of any fire hose reel system:
 - (i) Fire hose reels must be located adjacent to an internal fire hydrant (other than one within a fire-isolated *exit*), except that a fire hose reel need not be located adjacent to every fire hydrant, provided system coverage can be achieved.
 - (ii) Fire hose reels must be located within 4 m of an *exit*, except that a fire hose reel need not be located adjacent to every *exit*, provided system coverage can be achieved.
 - (iii) Where system coverage is not achieved by compliance with (i) and (ii), additional fire hose reels may be located in paths of travel to an *exit* to achieve the *required* coverage.
- (f) Fire hose reels must be located so that the fire hose will not need to pass through doorways fitted with fire or smoke doors, except—
 - (i) doorways in walls referred to in **C2.5(a)(v)** in a Class 9a building and **C2.5(b)(iv)** in a Class 9c building, separating ancillary use areas of high potential *fire hazard*; and
 - (ii) doorways in walls referred to in **C2.12** or **C2.13** separating equipment or electrical supply systems; and
 - (iii) doorway openings to *shafts* referred to in **C3.13**.

Deemed-to-Satisfy Provisions

- (g) Where the normal water supply cannot achieve the flow and pressures required by AS 2441, or is unreliable—
- (i) a pump; or
 - (ii) water storage facility; or
 - (iii) both a pump and water storage facility,
- must be installed to provide the minimum flow and pressures required by clause 6.1 of AS 2441.

E1.5 Sprinklers

A sprinkler system must—

- (a) be installed in a building or part of a building when *required* by **Table E1.5**; and
- (b) comply with **Specification E1.5**.

NSW Table E1.5

NT Table E1.5

Vic Table E1.5

Table E1.5 REQUIREMENTS FOR SPRINKLERS

Occupancy	When sprinklers are required
All classes— <ul style="list-style-type: none"> (a) including an <i>open-deck carpark</i> within a multi-classified building; but (b) excluding— <ul style="list-style-type: none"> (i) an <i>open-deck carpark</i> being a separate building; and (ii) a Class 8 <i>electricity network substation</i>, with a <i>floor area</i> not more than 200 m², located within a multi-classified building. 	Throughout the whole building if any part of the building has an <i>effective height</i> of more than 25 m.
Class 3 building used as a <i>residential aged care building</i>	Throughout the building and in any <i>fire compartment</i> containing a Class 3 part used for residential aged care.
Class 6	In <i>fire compartments</i> where either of the following apply: <ul style="list-style-type: none"> (a) A <i>floor area</i> of more than 3 500 m². (b) A volume more than 21 000 m³.
Class 7a, other than <i>open-deck carparks</i>	In <i>fire compartments</i> where more than 40 vehicles are accommodated.
Class 9a <i>health care building</i> used as a <i>residential aged care building</i>	Throughout the building and in any <i>fire compartment</i> containing a Class 9a part used for residential aged care.

Deemed-to-Satisfy Provisions

Table E1.5 REQUIREMENTS FOR SPRINKLERS — continued

Occupancy	When sprinklers are required
Class 9c building	Throughout the building and any <i>fire compartment</i> containing a Class 9c part.
Class 9b	see Part H1
Atrium construction	see Part G3
Large isolated buildings	see Clause C2.3
Occupancies of excessive hazard (see Note 3)	In <i>fire compartments</i> where either of the following apply: (a) A <i>floor area</i> of more than 2 000 m ² . (b) A volume of more than 12 000 m ³ .

Notes:

1. See **Specification C1.1** for use of sprinklers in Class 2 buildings and *carparks* generally.
2. See **Part E2** for use of sprinklers to satisfy Smoke Hazard Management provisions.
3. See **C1.13** and **Specification C1.1** for use of sprinklers in Class 2, 3 and 5 buildings containing *fire-protected timber*.
4. For the purposes of this Table, occupancies of excessive *fire hazard* comprise buildings which contain—
 - (a) hazardous processes or storage including the following:
 - (i) Aircraft hangars.
 - (ii) Cane furnishing manufacture, processing and storage.
 - (iii) Fire-lighter and fireworks manufacture and warehousing.
 - (iv) Foam plastic and foam plastic goods manufacture, processing and warehousing e.g. furniture factory.
 - (v) Hydrocarbon based sheet product, manufacture, processing and warehousing e.g. vinyl floor coverings.
 - (vi) Woodwool and other flammable loose fibrous material manufacture.
 - (b) Combustible goods with an aggregate volume exceeding 1000 m³ and stored to a height greater than 4 m including the following:
 - (i) Aerosol packs with flammable contents.
 - (ii) Carpets and clothing.
 - (iii) Electrical appliances.
 - (iv) Combustible compressed fibreboards (low and high density) and plywoods.
 - (v) Combustible cartons, irrespective of content
 - (vi) Esparto and other fibrous combustible material.

Deemed-to-Satisfy Provisions

Table E1.5 REQUIREMENTS FOR SPRINKLERS — *continued*

Occupancy	When sprinklers are required
	(vii) Furniture including timber, cane and composite, where foamed rubber or plastics are incorporated.
	(viii) Paper storage (all forms of new or waste) e.g. bales, sheet, horizontal or vertical rolls, waxed coated or processed.
	(ix) Textiles raw and finished, eg, rolled cloth, clothing and manchester.
	(x) Timber storage including sheets, planks, boards, joists and cut sizes.
	(xi) Vinyl, plastic, foamed plastic, rubber and other combustible sheets, offcuts and random pieces and rolled material storage, eg, carpet, tar paper, linoleum, wood veneer and foam mattresses.
	(xii) All materials having wrappings or preformed containers of foamed plastics.

E1.6 Portable fire extinguishers

- (a) Portable fire extinguishers must be—
- (i) provided as listed in **Table E1.6**; and
 - (ii) for a Class 2 or 3 building or Class 4 part of a building, provided—
 - (A) to serve the whole Class 2 or 3 building or Class 4 part of a building where one or more internal fire hydrants are installed; or
 - (B) where internal fire hydrants are not installed, to serve any *fire compartment* with a *floor area* greater than 500 m², and for the purposes of this clause, a *sole-occupancy unit* in a Class 2 or 3 building or Class 4 part of a building is considered to be a *fire compartment*; and
 - (iii) subject to **(b)**, selected, located and distributed in accordance with Sections 1, 2, 3 and 4 of AS 2444.
- (b) Portable fire extinguishers provided in a Class 2 or 3 building or Class 4 part of a building must be—
- (i) an ABE type fire extinguisher; and
 - (ii) a minimum size of 2.5 kg; and
 - (iii) distributed outside a *sole-occupancy unit*—
 - (A) to serve only the *storey* at which they are located; and
 - (B) so that the travel distance from the entrance doorway of any *sole-occupancy unit* to the nearest fire extinguisher is not more than 10 m.

E1.7 * * * * *

This clause has deliberately been left blank.

Deemed-to-Satisfy Provisions

E1.8 Fire control centres

A fire control centre facility in accordance with **Specification E1.8** must be provided for—

- (a) a building with an *effective height* of more than 25 m; and
- (b) a Class 6, 7, 8 or 9 building with a total *floor area* of more than 18 000 m².

E1.9 Fire precautions during construction

In a building under construction—

- (a) not less than one fire extinguisher to suit Class A, B and C fires and electrical fires must be provided at all times on each *storey* adjacent to each *required exit* or temporary stairway or *exit*; and
- (b) after the building has reached an *effective height* of 12 m—
 - (i) the *required* fire hydrants and fire hose reels must be operational in at least every *storey* that is covered by the roof or the floor structure above, except the 2 uppermost *storeys*; and
 - (ii) any *required* booster connections must be installed.

Table E1.6 REQUIREMENTS FOR EXTINGUISHERS

Occupancy class	Risk class (as defined in AS 2444)
<p>General provisions—Class 2 to 9 buildings (except within <i>sole-occupancy units</i> of a Class 9c building)</p>	<ul style="list-style-type: none"> (a) To cover Class AE or E fire risks associated with emergency services switchboards. (Note 1) (b) To cover Class F fire risks involving cooking oils and fats in kitchens. (c) To cover Class B fire risks in locations where flammable liquids in excess of 50 litres are stored or used (not including that held in fuel tanks of vehicles). (d) To cover Class A fire risks in normally occupied <i>fire compartments</i> less than 500 m² not provided with fire hose reels (excluding <i>open deck carparks</i>). (e) To cover Class A fire risks in classrooms and associated corridors in primary and secondary schools not provided with fire hose reels. (f) To cover Class A fire risks associated with a Class 2 or 3 building or Class 4 part of a building.

Deemed-to-Satisfy Provisions

Table E1.6 REQUIREMENTS FOR EXTINGUISHERS — *continued*

Occupancy class	Risk class (as defined in AS 2444)
<p>Specific provisions (in addition to general provisions)—</p> <p>(a) Class 9a <i>health care building</i></p> <p>(b) Class 3 parts of detention and correctional occupancies</p> <p>(c) Class 3 accommodation for children, aged persons and people with disabilities</p> <p>(d) Class 9c building</p>	<p>To cover Class A and E fire risks. (Note 2)</p>
<p>Notes</p> <ol style="list-style-type: none"> 1. For the purposes of this Table, an emergency services switchboard is one which sustains emergency equipment operating in the emergency mode. 2. A Class E fire extinguisher need only be located at each nurses', supervisors' station or the like. 3. Additional extinguishers may be required to cover fire risks in relation to special hazards provided for in E1.10. 4. The fire risks in a Class 2 or 3 building or Class 4 part of a building must include risks within any <i>sole-occupancy units</i>, however portable fire extinguishers are not required to be located within a <i>sole-occupancy unit</i> unless the <i>sole-occupancy unit</i> has a <i>floor area</i> greater than 500 m². 	

E1.10 Provision for special hazards

Suitable additional provision must be made if special problems of fighting fire could arise because of—

- (a) the nature or quantity of materials stored, displayed or used in a building or on the allotment; or
- (b) the location of the building in relation to a water supply for fire-fighting purposes.

Tas E1.101

Explanatory information: Cross-volume considerations

Part B4 of NCC Volume Three sets out the requirements for access for maintenance to fire-fighting water services.

SPECIFICATION **E1.5** FIRE SPRINKLER SYSTEMS

Deemed-to-Satisfy Provisions

1. Scope

This Specification sets out requirements for the design and installation of fire sprinkler systems.

2. Adoption of AS 2118

Vic Spec E1.5 2

Subject to this Specification, a sprinkler system must comply with—

- (a) AS 2118.1; or
- (b) for a Class 2 or 3 building: AS 2118.4 as applicable; or
- (c) for a combined sprinkler and fire hydrant system: AS 2118.6; or
- (d) for a Class 9a *health care building* used as a *residential aged care building*: AS 2118.4 as applicable; or
- (e) for a Class 9c building: AS 2118.4 as applicable.

3. Separation of sprinklered and non-sprinklered areas

Where a part of a building is not protected with sprinklers, the sprinklered and non-sprinklered parts must be fire-separated with a wall or floor which must—

- (a) comply with any specific requirement of the *Deemed-to-Satisfy Provisions* of the BCA; or
- (b) where there is no specific requirement, comply with the relevant part of AS 2118.

4. Protection of openings

Any openings, including those for service penetrations, in construction separating sprinklered and non-sprinklered parts of a building, including the construction separating the areas nominated as permitted exceptions in AS 2118.1, must be protected in accordance with the *Deemed-to-Satisfy Provisions* of **Part C3**.

5. Fast response sprinklers

Fast response sprinklers may be installed only if they are suitable for the type of application proposed and it is demonstrated that the sprinkler system is designed to accommodate their use.

6. Sprinkler valve enclosures

- (a) Sprinkler alarm valves must be located in a secure room or enclosure which has direct egress to a road or open space.
- (b) All sprinkler valve rooms and enclosures must be secured with a system suitable for use by the *fire brigade*.

Deemed-to-Satisfy Provisions

7. Water supply

The Grade of water supply to a *required* sprinkler system must not be less than—

- (a) for a building greater than 25 m in *effective height*, Grade 1, except that a secondary water supply storage capacity of 25,000 litres may be used if—
 - (i) the storage tank is located at the topmost *storey* of the building; and
 - (ii) the building occupancy is classified as no more hazardous than Ordinary Hazard 2 (OH2) under AS 2118.1; and
 - (iii) an operational *fire brigade* service is available to attend a building fire; and
- (b) for a building not greater than 25 m in *effective height*, at least Grade 3.

8. Building occupant warning system

A *required* sprinkler system must be connected to and activate a building occupant warning system complying with **Clause 6 of Specification E2.2a**.

9. Connection to other systems

Where a smoke hazard management system is installed and is actuated by smoke detectors, the sprinkler system must, wherever practicable, be arranged to also activate the smoke hazard management system.

10. Anti-tamper devices

Where a sprinkler system is installed in a theatre, public hall or the like, any valves provided to control sprinklers over any *stage* area must be fitted with anti-tamper devices connected to a monitoring panel at the location normally used by the *stage* manager.

11. Sprinkler systems in carparks

The sprinkler system protecting a *carpark* complying with **Table 3.9 of Specification C1.1** in a multi-classified building must—

- (a) be independent of the sprinkler system protecting any part of the building not used as a *carpark*; or
- (b) if forming part of a sprinkler system protecting a part of the building not used as a *carpark*, be designed such that the section protecting the non-*carpark* part can be isolated without interrupting the water supply or otherwise affecting the effective operation of the section protecting the *carpark*.

12. Aged care buildings

In addition to the provisions of AS 2118.4, a sprinkler system in—

- (a) a Class 3 building used as a *residential aged care building*; or
- (b) a Class 9a *health care building* used as a *residential aged care building*; or
- (c) a Class 9c building,

must—

- (d) be provided with a monitored main stop valve in accordance with AS 2118.1; and

Deemed-to-Satisfy Provisions

- (e) be permanently connected with a direct data link or other approved monitoring system to a fire station or fire station dispatch centre.

13. Sprinkler systems in lift installations

Where sprinklers are installed in a space housing lift electrical and control equipment, including machine rooms, secondary floors and sheave rooms, they must be of the dry system type in accordance with AS 2118.1.

SPECIFICATION **E1.8** FIRE CONTROL CENTRES

Deemed-to-Satisfy Provisions

1. Scope

This Specification describes the construction and content of *required* fire control centres and rooms. A fire control room is a fire control centre in a dedicated room with additional specific requirements. **Clauses 2 to 5** apply to fire control centres (including fire control rooms). **Clauses 6 to 12** apply additional requirements to fire control rooms.

2. Purpose and content

A fire control centre must—

- (a) provide an area from which fire-fighting operations or other emergency procedures can be directed or controlled; and
- (b) contain controls, panels, telephones, furniture, equipment and the like associated with the *required* fire services in the building; and
- (c) not be used for any purpose other than the control of—
 - (i) fire-fighting activities; and
 - (ii) other measures concerning the occupant safety or security.

3. Location of fire control centre

A fire control centre must be so located in a building that egress from any part of its floor, to a road or *open space*, does not involve changes in level which in aggregate exceed 300 mm.

4. Equipment not permitted within a fire control centre

An internal combustion engine, pumps, sprinkler control valves, pipes and pipe fittings must not be located in a fire control centre, but may be located in rooms accessed through the fire control centre.

5. Ambient sound level for a fire control centre

- (a) The ambient sound level within the fire control centre measured when all fire safety equipment is operating in the manner in which it operates in an emergency must not exceed 65 dB(A).
- (b) The measurement must be taken for a sufficient time to characterize the effects of all sound sources. Where there is not a great variation in noise level, a measurement time of 60 seconds may be used.

6. Construction of a fire control room

A fire control centre in a building more than 50 m in *effective height* must be in a separate room where—

Deemed-to-Satisfy Provisions

- (a) the enclosing construction is of concrete, masonry or the like, sufficiently impact resistant to withstand the impact of any likely falling debris, and with an FRL of not less than 120/120/120; and
- (b) any material used as a finish, surface, lining or the like within the room complies with the requirements of **Specification C1.10**; and
- (c) services, pipes, ducts and the like that are not directly *required* for the proper functioning of the fire control room do not pass through it; and
- (d) openings in the walls, floors or ceiling which separate the room from the interior of the building are confined to doorways, ventilation and other openings for services necessary for the proper functioning of the facility.

7. Protection of openings in a fire control room

Openings permitted by **Clause 6** must be protected as follows:

- (a) Openings for *windows*, doorways, ventilation, service pipes, conduits and the like, in an *external wall* of the building that faces a road or *open space*, must be protected in accordance with the *Deemed-to-Satisfy Provisions* of **Part C3**.
- (b) Openings in the floors, ceilings and *internal walls* enclosing a fire control room must, except for doorways, be protected in accordance with the *Deemed-to-Satisfy Provisions* of **Part C3**.
- (c) A door opening in the *internal walls* enclosing a fire-control room, must be fitted with a *self closing* –/120/30 smoke sealed fire door.
- (d) Openings associated with natural or mechanical ventilation must—
 - (i) not be made in any ceiling or floor immediately above or below the fire control room; and
 - (ii) be protected by a –/120/– fire damper if the opening is for a duct through a wall *required* to have an FRL, other than an *external wall*.

8. Doors to a fire control room

- (a) *Required* doors to a fire control room must open into the room, be lockable and located so that persons using escape routes from the building will not obstruct or hinder access to the room.
- (b) The fire control room must be accessible via two paths of travel—
 - (i) one from the front entrance of the building; and
 - (ii) one direct from a public place or *fire-isolated passageway* which leads to a public place and has a door with an FRL of not less than –/120/30.

9. Size and contents of a fire control room

- (a) A fire control room must contain—
 - (i) a Fire Indicator Panel and necessary control switches and visual status indication for all *required* fire pumps, smoke control fans and other *required* fire safety equipment installed in the building; and
 - (ii) a telephone directly connected to an external telephone exchange; and

Deemed-to-Satisfy Provisions

- (iii) a blackboard or whiteboard not less than 1200 mm wide x 1000 mm high; and
 - (iv) a pin-up board not less than 1200 mm wide x 1000 mm high; and
 - (v) a raked plan layout table of a size suitable for laying out the plans provided under (vi); and
 - (vi) colour-coded, durable, tactical fire plans.
- (b) In addition, a fire control room may contain—
- (i) master emergency control panels, lift annunciator panels, remote switching controls for gas or electrical supplies and emergency generator backup; and
 - (ii) building security, surveillance and management systems if they are completely segregated from all other systems.
- (c) A fire control room must—
- (i) have a *floor area* of not less than 10 m² and the length of any internal side must be not less than 2.5 m; and
 - (ii) if only the minimum prescribed equipment is installed — have a net *floor area* of not less than 8 m² with a clear space of not less than 1.5 m² in front of the Fire Indicator Panel; and
 - (iii) if additional equipment is installed — have an additional area of not less than 2 m² net *floor area* for each additional facility and a clear space of not less than 1.5 m² in front of each additional control or indicator panel,
- and the area *required* for any path of travel through the room to other areas must be provided in addition to the requirements (ii) and (iii).

10. Ventilation and power supply for a fire control room

A fire control room must be ventilated by—

- (a) natural ventilation from a *window* or doorway in an *external wall* of the building which opens directly into the fire control room from a road or *open space*; or
- (b) a pressurisation system that only serves the fire control room, and—
 - (i) is installed in accordance with AS/NZS 1668.1 as though the room is a *fire-isolated stairway*; and
 - (ii) is activated *automatically* by operation of the fire alarm, or sprinkler system complying with **Specification E1.5**, installed in the building and manually by an over-riding control in the room; and
 - (iii) provides a flow of fresh air through the room of not less than 30 air changes per hour when the system is operating and any door to the room is open; and
 - (iv) has fans, motors and ductwork that form part of the system but not contained within the fire control room protected by enclosing construction with an FRL of not less than 120/120/120; and
 - (v) has any electrical supply to the fire control room or equipment necessary for its operation connected to the supply side of the main disconnection switch for the building,

Deemed-to-Satisfy Provisions

and no openable devices other than necessary doorways, pressure controlled relief louvres and *windows* that are openable by a key, must be constructed in the fire control room.

11. Sign for a fire control room

The external face of the door to the fire control room must have a sign with the words—

FIRE CONTROL ROOM

in letters of not less than 50 mm high and of a colour which contrasts with that of the background.

12. Lighting for a fire control room

Emergency lighting in accordance with the *Deemed-to-Satisfy Provisions* of **Part E4** must be provided in a fire control room, except that an illumination level of not less than 400 lux must be maintained at the surface of the plan table.

PART E2

SMOKE HAZARD MANAGEMENT

PERFORMANCE REQUIREMENTS

EP2.1

In a building providing sleeping accommodation, occupants must be provided with *automatic* warning on the detection of smoke so they may evacuate in the event of a fire to a *safe place*.

Application:

EP2.1 only applies to a Class 2, 3, 9a or 9c building or Class 4 part of a building.

EP2.2

- (a) In the event of a fire in a building the conditions in any *evacuation route* must be maintained for the period of time occupants take to evacuate the part of the building so that—
- (i) the temperature will not endanger human life; and
 - (ii) the level of visibility will enable the *evacuation route* to be determined; and
 - (iii) the level of toxicity will not endanger human life.
- (b) The period of time occupants take to evacuate referred to in (a) must be appropriate to—
- (i) the number, mobility and other characteristics of the occupants; and
 - (ii) the function or use of the building; and
 - (iii) the travel distance and other characteristics of the building; and
 - (iv) the *fire load*; and
 - (v) the potential *fire intensity*; and
 - (vi) the *fire hazard*; and
 - (vii) any active *fire safety systems* installed in the building; and
 - (viii) *fire brigade* intervention.

Limitation:

EP2.2 does not apply to an *open-deck carpark* or *open spectator stand*.

PART E2 SMOKE HAZARD MANAGEMENT

Deemed-to-Satisfy Provisions

E2.0 Deemed-to-Satisfy Provisions

- (a) Where a *Deemed-to-Satisfy Solution* is proposed, *Performance Requirements EP2.1* to *EP2.2* are satisfied by complying with—
- (i) **E2.1** to **E2.3**; and
 - (ii) in a building containing an *atrium*, **Part G3**; and
 - (iii) in a building in an *alpine area*, **Part G4**; and
 - (iv) for additional requirements for Class 9b buildings, **Part H1**.
- (b) Where a *Performance Solution* is proposed, the relevant *Performance Requirements* must be determined in accordance with **A0.7**.

E2.1 Application of Part

- (a) The *Deemed-to-Satisfy Provisions* of this Part do not apply to—
- (i) any *open deck carpark*; or
 - (ii) any *open spectator stand*; or
 - (iii) a Class 8 *electricity network substation* with a *floor area* not more than 200 m², located within a multi-classified building.
- (b) The smoke exhaust and *smoke-and-heat vent* provisions of this Part do not apply to any area not used by occupants for an extended period of time such as a storeroom with a *floor area* less than 30 m², *sanitary compartment*, plant room or the like.

E2.2 General requirements

- (a) A building must comply with **(b)**, **(c)**, **(d)** and—
- (i) **Table E2.2a** as applicable to Class 2 to 9 buildings such that each separate part complies with the relevant provisions for the classification; and
 - (ii) **Table E2.2b** as applicable to Class 6 and 9b buildings such that each separate part complies with the relevant provisions for the classification.
- (b) An air-handling system which does not form part of a smoke hazard management system in accordance with **Table E2.2a** or **Table E2.2b** and which recycles air from one *fire compartment* to another *fire compartment* or operates in a manner that may unduly contribute to the spread of smoke from one *fire compartment* to another *fire compartment* must—
- (i) be designed and installed to operate as a smoke control system in accordance with AS/NZS 1668.1; or
 - (ii)
 - (A) incorporate smoke dampers where the air-handling ducts penetrate any elements separating the *fire compartments* served; and

Deemed-to-Satisfy Provisions

- (B) be arranged such that the air-handling system is shut down and the smoke dampers are activated to close *automatically* by smoke detectors complying with clause 7.5 of AS 1670.1; and
for the purposes of this provision, each *sole-occupancy unit* in a Class 2 or 3 building is treated as a separate *fire compartment*.
- (c) Miscellaneous air-handling systems covered by Sections 5 and 6 of AS/NZS 1668.1 serving more than one *fire compartment* (other than a *carpark* ventilation system) and not forming part of a smoke hazard management system must comply with that Section of the Standard.
- (d) A smoke detection system must be installed in accordance with **Clause 5 of Specification E2.2a** to operate AS/NZS 1668.1 systems that are provided for zone smoke control and *automatic* air pressurisation for fire-isolated *exits*.

E2.3 Provision for special hazards

Additional smoke hazard management measures may be necessary due to the—

- (a) special characteristics of the building; or
- (b) special function or use of the building; or
- (c) special type or quantity of materials stored, displayed or used in a building; or
- (d) special mix of classifications within a building or *fire compartment*,

which are not addressed in **Tables E2.2a** and **E2.2b**.

NSW Table E2.2a

Table E2.2a GENERAL PROVISIONS

FIRE-ISOLATED EXITS
<p>A <i>required</i>—</p> <ul style="list-style-type: none"> (a) <i>fire-isolated stairway</i>, including any associated <i>fire-isolated passageway</i> or <i>fire-isolated ramp</i> serving— <ul style="list-style-type: none"> (i) any <i>storey</i> above an <i>effective height</i> of 25 m; or (ii) more than 2 below ground <i>storeys</i>, not counted in the <i>rise in storeys</i> in accordance with C1.2; or (iii) an <i>atrium</i> to which Part G3 applies; or (iv) a Class 9a building with a <i>rise in storeys</i> of more than 2; or (v) a Class 9c building with a <i>rise in storeys</i> of more than 2; and (b) <i>fire-isolated passageway</i> or <i>fire-isolated ramp</i> with a length of travel more than 60 m to a road or <i>open space</i>, <p>must be provided with—</p> <ul style="list-style-type: none"> (c) an <i>automatic</i> air pressurisation system for fire-isolated <i>exits</i> in accordance with AS/NZS 1668.1; or (d) open access ramps or balconies in accordance with D2.5.

Deemed-to-Satisfy Provisions

Table E2.2a GENERAL PROVISIONS — continued

<p>Notes:</p> <ol style="list-style-type: none"> 1. An <i>automatic</i> air pressurisation system for fire-isolated <i>exits</i> applies to the entire <i>exit</i>. 2. Refer D1.7(d) for pressurisation of a fire-isolated <i>exit</i> having more than 2 access doorways from within the same <i>storey</i>.
BUILDINGS MORE THAN 25 M IN EFFECTIVE HEIGHT
CLASS 2 AND 3 BUILDINGS AND CLASS 4 PART OF A BUILDING
A Class 2 and 3 building or part of a building and Class 4 part of a building must be provided with an <i>automatic</i> smoke detection and alarm system complying with Specification E2.2a .
Note: Refer C2.14 for division of <i>public corridors</i> greater than 40 m in length.
CLASS 5, 6, 7b, 8 or 9b BUILDINGS
A Class 5, 6, 7b, 8 or 9b building or part of a building must be provided with a zone smoke control system in accordance with AS/NZS 1668.1.
<p>Notes:</p> <ol style="list-style-type: none"> 1. Refer Table E2.2b for Specific Provisions applicable to a Class 6 (in a <i>fire compartment</i> having a <i>floor area</i> of more than 2000 m²) and 9b building or part of a building. 2. This requirement does not apply to a building that has a <i>fire compartment</i> containing a Class 5, 6, 7b, 8 or 9b part (or a combination of these classes in the same <i>fire compartment</i>) where there is only one <i>fire compartment</i> containing these classifications in an otherwise Class 2, 3, 9a or 9c building.
CLASS 9a BUILDINGS
A Class 9a building must be provided with—
(a) an <i>automatic</i> smoke detection and alarm system complying with Specification E2.2a ; and
(b) a zone smoke control system in accordance with AS/NZS 1668.1.
Note: A building more than 25 m in <i>effective height</i> requires a sprinkler system under E1.5 .
BUILDINGS NOT MORE THAN 25 M IN EFFECTIVE HEIGHT
CLASS 2 AND 3 BUILDINGS AND CLASS 4 PART OF A BUILDING
A Class 2 and 3 building or part of a building and Class 4 part of a building—
(a) must be provided with an <i>automatic</i> smoke detection and alarm system complying with Specification E2.2a ; and

Deemed-to-Satisfy Provisions

Table E2.2a GENERAL PROVISIONS — *continued*

<p>(b) where a <i>required fire-isolated stairway</i> serving the Class 2 or 3 parts also serves one or more <i>storeys</i> of Class 5, 6, 7 (other than an <i>open deck carpark</i>), 8 or 9b parts—</p> <p style="margin-left: 20px;">(i) the <i>fire-isolated stairway</i>, including any associated <i>fire-isolated passageway</i> or <i>fire-isolated ramp</i>, must be provided with an <i>automatic</i> air pressurisation system for fire-isolated <i>exits</i> in accordance with AS/NZS 1668.1; or</p> <p style="margin-left: 20px;">(ii) the Class 5, 6, 7 (other than an <i>open deck carpark</i>), 8 and 9b parts must be provided with—</p> <p style="margin-left: 40px;">(A) an <i>automatic</i> smoke detection and alarm system complying with Specification E2.2a; or</p> <p style="margin-left: 40px;">(B) a sprinkler system complying with Specification E1.5; and</p> <p>(c) where a <i>required fire-isolated stairway</i> serving the Class 4 part also serves one or more <i>storeys</i> of Class 5, 6, 7 (other than an <i>open deck carpark</i>), 8 or 9b parts—</p> <p style="margin-left: 20px;">(i) a system complying with (b)(i) or (b)(ii) must be installed; or</p> <p style="margin-left: 20px;">(ii) a smoke alarm or detector system complying with Specification E2.2a must be provided except that alarms or detectors need only be installed adjacent to each doorway into each <i>fire-isolated stairway</i> (set back horizontally from the doorway by a distance of not more than 1.5 m) to initiate a building occupant warning system for the Class 4 part.</p>
<p>Notes:</p> <ol style="list-style-type: none"> 1. Refer C2.14 for division of <i>public corridors</i> greater than 40 m in length. 2. Refer Table E2.2b for Specific Provisions applicable to a Class 6 (in a <i>fire compartment</i> having a <i>floor area</i> of more than 2000 m²) and 9b building or part of a building.
<p>CLASS 5, 6, 7b, 8 and 9b BUILDINGS</p>
<p>In a—</p> <p>(a) Class 5 or 9b <i>school</i> building or part of a building having a <i>rise in storeys</i> of more than 3; or</p> <p>(b) Class 6, 7b, 8 or 9b building (other than a <i>school</i>) or part of a building having a <i>rise in storeys</i> of more than 2; or</p> <p>(c) building having a <i>rise in storeys</i> of more than 2 and containing—</p> <p style="margin-left: 20px;">(i) a Class 5 or 9b <i>school</i> part; and</p> <p style="margin-left: 20px;">(ii) a Class 6, 7b, 8 or 9b (other than a <i>school</i>) part,</p> <p>the building must be provided with—</p> <p>(d) in each <i>required fire-isolated stairway</i>, including any associated <i>fire-isolated passageway</i> or <i>fire-isolated ramp</i>, an <i>automatic</i> air pressurisation system for fire-isolated <i>exits</i> in accordance with AS/NZS 1668.1; or</p> <p>(e) a zone smoke control system in accordance with AS/NZS 1668.1, if the building has more than one <i>fire compartment</i>; or</p> <p>(f) an <i>automatic</i> smoke detection and alarm system complying with Specification E2.2a; or</p> <p>(g) a sprinkler system complying with Specification E1.5.</p>

Deemed-to-Satisfy Provisions

Table E2.2a GENERAL PROVISIONS — continued

LARGE ISOLATED BUILDINGS SUBJECT TO C2.3	
(a)	<p>In a Class 7 or 8 building, which does not exceed 18 000 m² in <i>floor area</i> nor exceed 108 000 m³ in volume, the building must be provided with—</p> <ul style="list-style-type: none"> (i) a sprinkler system complying with Specification E1.5, and provided with perimeter vehicular access complying with C2.4(b); or (ii) an <i>automatic</i> fire detection and alarm system complying with AS 1670.1 and monitored in accordance with Clause 7 of Specification E2.2a; or (iii) an <i>automatic</i> smoke exhaust system in accordance with Specification E2.2b; or (iv) <i>automatic smoke-and-heat vents</i> in accordance with Specification E2.2c; or (v) natural smoke venting, with ventilation openings distributed as evenly as practicable and comprising permanent openings at roof level with a free area not less than 1.5% of <i>floor area</i> and low level openings which may be permanent or readily openable with a free area not less than 1.5% of <i>floor area</i>.
(b)	<p>In a Class 5, 6, 7, 8 or 9 building, which exceeds 18 000 m² in <i>floor area</i> or 108 000 m³ in volume, the building must be provided with—</p> <ul style="list-style-type: none"> (i) if the ceiling height of the <i>fire compartment</i> is not more than 12 m— <ul style="list-style-type: none"> (A) an <i>automatic</i> smoke exhaust system in accordance with Specification E2.2b; or (B) <i>automatic smoke-and-heat vents</i> in accordance with Specification E2.2c; or (ii) if the ceiling height of the <i>fire compartment</i> is more than 12 m, an <i>automatic</i> smoke exhaust system in accordance with Specification E2.2b.
Notes:	
<ol style="list-style-type: none"> 1. Refer Table E2.2b for Specific Provisions applicable to a Class 6 (in a <i>fire compartment</i> having a <i>floor area</i> of more than 2000 m²) and 9b building or part of a building. 2. Refer provisions under Class 2 and 3 buildings and Class 4 part of a building in this Table where a Class 5, 6, 7b, 8 and 9b building contains a Class 2, 3 or 4 part. 3. Reference to "the building" being provided with specified measures, means to the nominated classes within the building. For parts of the building of other classes, see other parts of this Table. 	
CLASS 9a and 9c BUILDINGS	
<p>A Class 9a <i>health-care building</i> or a Class 9c building, or a building containing a part thereof, must be provided throughout with—</p>	
(a)	<p>an <i>automatic</i> smoke detection and alarm system complying with Specification E2.2a; and</p>

Deemed-to-Satisfy Provisions

Table E2.2a GENERAL PROVISIONS — *continued*

<p>(b) <i>automatic</i> shutdown of any air-handling system which does not form part of a zone smoke control system (other than individual room units with a capacity not more than 1000 L/s, systems serving critical treatment areas and miscellaneous exhaust air systems installed in accordance with Sections 5 and 6 of AS/NZS 1668.1) on the activation of—</p> <ul style="list-style-type: none"> (i) smoke detectors installed in accordance with (a); and (ii) any other installed fire detection and alarm system including a sprinkler system complying with Specification E1.5; and <p>(c) in a building having a <i>rise in storeys</i> of more than 2 and not more than 25 m <i>effective height</i> (not being a Class 9c building)—</p> <ul style="list-style-type: none"> (i) a zone smoke control system in accordance with AS/NZS 1668.1; or (ii) a sprinkler system complying with Specification E1.5 throughout with residential sprinkler heads in <i>patient care areas</i>.
<p>Note: Refer to Clause 2 of Specification C2.5 for the provisions for smoke dampers.</p>
<p>CLASS 7a BUILDINGS</p> <p>A Class 7a building, including a basement, provided with a mechanical ventilation system in accordance with AS 1668.2 must comply with clause 5.5 of AS/NZS 1668.1 except that—</p> <ul style="list-style-type: none"> (a) fans with metal blades suitable for operation at normal temperature may be used; and (b) the electrical power and control cabling need not be fire rated.
<p>BASEMENTS (other than Class 7a buildings)</p> <p>A basement, not counted in the <i>rise in storeys</i> in accordance with C1.2, must—</p> <ul style="list-style-type: none"> (a) comply with measures in accordance with this Table applicable to the building generally; and (b) where the basement has a total <i>floor area</i> of more than 2000 m², be provided with— <ul style="list-style-type: none"> (i) if not more than 2 below ground <i>storeys</i>— <ul style="list-style-type: none"> (A) a zone smoke control system in accordance with AS/NZS 1668.1, if the basement has more than one <i>fire compartment</i>; or (B) an <i>automatic</i> smoke detection and alarm system complying with Specification E2.2a; or (C) a sprinkler system complying with Specification E1.5; or (ii) if more than 2 below ground <i>storeys</i>, a sprinkler system complying with Specification E1.5.
<p>Notes:</p> <ol style="list-style-type: none"> 1. Refer Table E2.2b for Specific Provisions applicable to a Class 6 (in a <i>fire compartment</i> having a <i>floor area</i> of more than 2000 m²) and 9b building or part of a building. 2. Basements with more than 3 below ground <i>storeys</i> or containing Class 6 or 9b occupancies with a large number of occupants may require special consideration in accordance with E2.3.

Deemed-to-Satisfy Provisions

Table E2.2a GENERAL PROVISIONS — continued

ATRIUMS
Refer Part G3 .

NSW Table E2.2b

Table E2.2b SPECIFIC PROVISIONS

CLASS 6 BUILDINGS IN FIRE COMPARTMENTS MORE THAN 2000 m²
CLASS 6 BUILDINGS (not containing an enclosed common walkway or mall serving more than one Class 6 sole-occupancy unit)
<p>(a) Where the <i>floor area</i> of a Class 6 part of a <i>fire compartment</i> is more than 2000 m², the <i>fire compartment</i>, must be provided with—</p> <ul style="list-style-type: none"> (i) an <i>automatic</i> smoke exhaust system complying with Specification E2.2b; or (ii) <i>automatic smoke-and-heat vents</i> complying with Specification E2.2c, if the building is single <i>storey</i>; or (iii) if the <i>floor area</i> of the <i>fire compartment</i> is not more than 3500 m² and the building— <ul style="list-style-type: none"> (A) is single <i>storey</i>, an <i>automatic</i> smoke detection and alarm system complying with Specification E2.2a; or (B) has a <i>rise in storeys</i> of not more than 2, a sprinkler system complying with Specification E1.5. <p>(b) The provisions of (a) do not apply to—</p> <ul style="list-style-type: none"> (i) a Class 6 <i>sole-occupancy unit</i> that— <ul style="list-style-type: none"> (A) has a <i>floor area</i> of not more than 2000 m²; and (B) is single <i>storey</i> with a main public entrance opening to a road or <i>open space</i>; and (C) is separated from other parts of the <i>fire compartment</i> by construction, including openings, penetrations and junctions with other building elements, that prevents the free passage of smoke; and (ii) parts of any other classification that are smoke separated from a Class 6 part by construction complying with (i)(C).
CLASS 6 BUILDINGS (containing an enclosed common walkway or mall serving more than one Class 6 sole-occupancy unit)
<p>(a) Where the <i>floor area</i> of a Class 6 part of a <i>fire compartment</i> is more than 2000 m², the <i>fire compartment</i>, including the enclosed common walkway or mall, must be provided with—</p> <ul style="list-style-type: none"> (i) an <i>automatic</i> smoke exhaust system complying with Specification E2.2b; or (ii) <i>automatic smoke-and-heat vents</i> complying with Specification E2.2c, if the building is single <i>storey</i>; or (iii) if the <i>floor area</i> of the <i>fire compartment</i> is not more than 3500 m² and the building has a <i>rise in storeys</i> of not more than 2, a sprinkler system complying with Specification E1.5.

Deemed-to-Satisfy Provisions

Table E2.2b SPECIFIC PROVISIONS — *continued*

<p>(b) The provisions of (a) do not apply to—</p> <ul style="list-style-type: none"> (i) a Class 6 <i>sole-occupancy unit</i> that— <ul style="list-style-type: none"> (A) opens onto the enclosed common walkway or mall if the Class 6 <i>sole-occupancy unit</i> has a <i>floor area</i> of not more than 1000 m²; or (B) does not open onto the enclosed common walkway or mall if the Class 6 <i>sole-occupancy unit</i>— <ul style="list-style-type: none"> (aa) has a <i>floor area</i> of not more than 2000 m²; and (bb) is single <i>storey</i> with a main entrance opening to a road or <i>open space</i>; and (cc) is separated from other parts of the <i>fire compartment</i> by construction, including openings, penetrations and junctions with other building elements, that prevents the free passage of smoke; and (ii) parts of any other classification that are smoke separated from a Class 6 part by construction complying with (i)(B)(cc).
<p>Note: A <i>fire compartment</i> having a <i>floor area</i> of more than 3500 m² in a Class 6 building requires a sprinkler system under E1.5.</p>
CLASS 9b ASSEMBLY BUILDINGS
NIGHTCLUBS and DISCOTHEQUES AND THE LIKE
<p>A building or part of a building used as a nightclub, discotheque or the like must be provided with—</p> <ul style="list-style-type: none"> (a) <i>automatic</i> shutdown of any air-handling system (other than miscellaneous exhaust air systems installed in accordance with Sections 5 and 6 of AS/NZS 1668.1) which does not form part of the smoke hazard management system, on the activation of— <ul style="list-style-type: none"> (i) smoke detectors installed complying with Clause 5 of Specification E2.2a; and (ii) any other installed fire detection and alarm system, including a sprinkler system complying with Specification E1.5; and (b) <ul style="list-style-type: none"> (i) an <i>automatic</i> smoke exhaust system complying with Specification E2.2b; or (ii) <i>automatic smoke-and-heat vents</i> complying with Specification E2.2c, if the building is single <i>storey</i>; or (iii) a sprinkler system complying with Specification E1.5 with fast response sprinkler heads.
EXHIBITION HALLS
<p>A building or part of a building used as an exhibition hall must be provided with—</p> <ul style="list-style-type: none"> (a) <i>automatic</i> shutdown of any air-handling system (other than miscellaneous exhaust air systems installed in accordance with Sections 5 and 6 of AS/NZS 1668.1) which does not form part of the smoke hazard management system, on the activation of— <ul style="list-style-type: none"> (i) smoke detectors installed complying with Specification E2.2a; and (ii) any other installed fire detection and alarm system, including a sprinkler system complying with Specification E1.5; and

Deemed-to-Satisfy Provisions

Table E2.2b SPECIFIC PROVISIONS — *continued*

<p>(b) where the <i>floor area</i> is more than 2000 m² and not more than 3500 m²—</p> <ul style="list-style-type: none"> (i) an <i>automatic</i> smoke exhaust system complying with Specification E2.2b; or (ii) <i>automatic smoke-and-heat vents</i> complying with Specification E2.2c, if the building is single <i>storey</i>; or (iii) a sprinkler system complying with Specification E1.5; and <p>(c) where the <i>floor area</i> is more than 3500 m², a sprinkler system complying with Specification E1.5 and—</p> <ul style="list-style-type: none"> (i) an <i>automatic</i> smoke exhaust system complying with Specification E2.2b; or (ii) <i>automatic smoke-and-heat vents</i> complying with Specification E2.2c, if the building is single <i>storey</i>.
THEATRES and PUBLIC HALLS
<p>A building or part of a building used as a theatre or public hall which—</p> <ul style="list-style-type: none"> (a) is a <i>school</i> assembly, church or community hall, and has a <i>stage</i> and any <i>backstage</i> area with a total <i>floor area</i> of more than 300 m²; or (b) is not a <i>school</i> assembly, church or community hall, and has a <i>stage</i> and any <i>backstage</i> area with a total <i>floor area</i> of more than 200 m²; or (c) has a <i>stage</i> with an associated rigging loft— <p>must be provided with—</p> <ul style="list-style-type: none"> (i) an <i>automatic</i> smoke exhaust system complying with Specification E2.2b; or (ii) <i>automatic smoke-and-heat vents</i> complying with Specification E2.2c, if the building is single <i>storey</i>.
THEATRES and PUBLIC HALLS (not listed above) INCLUDING LECTURE THEATRES AND CINEMA/AUDITORIUM COMPLEXES
<p>A building or part of a building used as a theatre or public hall (not listed above) including a lecture theatre and cinema/auditorium complex—</p> <ul style="list-style-type: none"> (a) must be provided with <i>automatic</i> shutdown of any air-handling system (other than miscellaneous exhaust air systems installed in accordance with Sections 5 and 6 of AS/NZS 1668.1) which does not form part of the smoke hazard management system, on the activation of— <ul style="list-style-type: none"> (i) smoke detectors installed complying with Specification E2.2a; and (ii) any other installed fire detection and alarm system, including a sprinkler system complying with Specification E1.5; and

Deemed-to-Satisfy Provisions

Table E2.2b SPECIFIC PROVISIONS — *continued*

<p>(b) other than in the case of a <i>school</i> lecture theatre, where the <i>floor area</i> of the <i>fire compartment</i> is more than 2000 m²—</p> <ul style="list-style-type: none"> (i) an <i>automatic</i> smoke exhaust system complying with Specification E2.2b; or (ii) <i>automatic smoke-and-heat vents</i> complying with Specification E2.2c, if the building is single <i>storey</i>; or (iii) if the <i>floor area</i> of the <i>fire compartment</i> is not more than 5000 m² and the building has a <i>rise in storeys</i> of not more than 2— <ul style="list-style-type: none"> (A) an <i>automatic</i> smoke detection and alarm system complying with Specification E2.2a; or (B) a sprinkler system complying with Specification E1.5.
OTHER ASSEMBLY BUILDINGS (not listed above) and EXCLUDING SCHOOLS
<p>(a) Each <i>fire compartment</i>, other than one in a building described in (b), having a <i>floor area</i> of more than 2000 m² must be provided with—</p> <ul style="list-style-type: none"> (i) an <i>automatic</i> smoke exhaust system complying with Specification E2.2b; or (ii) <i>automatic smoke-and-heat vents</i> complying with Specification E2.2c, if the building is single <i>storey</i>; or (iii) if the <i>floor area</i> of the <i>fire compartment</i> is not more than 5000 m² and the building has a <i>rise in storeys</i> of not more than 2— <ul style="list-style-type: none"> (A) an <i>automatic</i> smoke detection and alarm system complying with Specification E2.2a; or (B) a sprinkler system complying with Specification E1.5. <p>(b) The following buildings are exempt from the provisions of (a):</p> <ul style="list-style-type: none"> (i) Sporting complexes (including sports halls, gymnasiums, <i>swimming pools</i>, ice and roller rinks, and the like) other than an indoor sports stadium with a total spectator seating for more than 1000. (ii) Churches and other places used solely for religious worship.

SPECIFICATION **E2.2a** SMOKE DETECTION AND ALARM SYSTEMS

Deemed-to-Satisfy Provisions

1. Scope

This Specification describes the installation and operation of *automatic* smoke detection and alarm systems.

2. Type of system

A *required automatic* smoke detection and alarm system must comply with the following:

- (a) **Class 2 and 3 buildings and Class 4 parts of a building:**
 - (i) Subject to (ii), a Class 2 and 3 building and Class 4 part of a building must be provided with—
 - (A) a smoke alarm system complying with **Clause 3**; or
 - (B) a smoke detection system complying with **Clause 4**; or
 - (C) a combination of a smoke alarm system complying with **Clause 3** within *sole-occupancy units* and a smoke detection system complying with **Clause 4** in areas not within the *sole-occupancy units*.
 - (ii) A Class 3 building must be provided with a smoke detection system complying with **Clause 4** if it—
 - (A) has a Class 3 part located more than 2 *storeys* above ground level; or
 - (B) accommodates more than 20 residents and is used as a residential part of a *school* or accommodation for the aged, children or people with a disability.
- (b) **Class 5, 6, 7, 8 and 9b buildings:** A smoke detection system complying with **Clause 4**.
- (c) **Class 9a health-care building:**
 - (i) Where 6 or less bed patients are accommodated—
 - (A) a smoke alarm system complying with **Clause 3**; or
 - (B) a smoke detection system complying with **Clause 4**.
 - (ii) Where more than 6 bed patients are accommodated, a smoke detection system complying with **Clause 4**.
- (d) **Class 9c building:** A smoke detection system complying with **Clause 4**.

3. Smoke alarm system

- (a) A smoke alarm system must—
 - (i) consist of smoke alarms complying with AS 3786; and
 - (ii) be powered from the consumers mains source.
- (b) In kitchens and other areas where the use of the area is likely to result in smoke alarms causing spurious signals—

Deemed-to-Satisfy Provisions

- (i) any other alarm deemed suitable in accordance with AS 1670.1 may be installed provided that smoke alarms are installed elsewhere in the *sole-occupancy unit* in accordance with **Clause 3(c)(i)** and **3(c)(ii)** or
- (ii) an alarm acknowledgement facility may be installed,
except where the kitchen or other area is sprinklered, the alarms need not be installed in the kitchen or other areas likely to result in spurious signals.
- (c) In a Class 2 or 3 building or Class 4 part of a building, alarms must—
 - (i) be installed within each *sole-occupancy unit*, and located on or near the ceiling in any *storey*—
 - (A) containing bedrooms—
 - (aa) between each part of the *sole-occupancy unit* containing bedrooms and the remainder of the *sole-occupancy unit*; and
 - (bb) where bedrooms are served by a hallway, in that hallway; and
 - (B) not containing any bedrooms, in egress paths; and
 - (ii) where there is more than one alarm installed within a *sole-occupancy unit*, be interconnected within that *sole-occupancy unit*; and
 - (iii) be installed in a building not protected with a sprinkler system, in *public corridors* and other internal public spaces, located in accordance with the requirements for smoke detectors in AS 1670.1 and connected to activate a building occupant warning system in accordance with **Clause 6**.
- (d) In a Class 9a building, smoke alarms must be installed in every room, *public corridor* and other internal public spaces and—
 - (i) be located in accordance with the requirements for smoke detectors in AS 1670.1 and interconnected to provide a common alarm; and
 - (ii) have manual call points installed in *evacuation routes* so that no point on a floor is more than 30 m from a manual call point.

4. Smoke detection system

- (a) A smoke detection system must—
 - (i) subject to **(c)** and **(d)**, comply with AS 1670.1 except for the provisions of—
 - (A) Clause 3.28(f); and
 - (B) * * * * *
 - (C) * * * * *
 - (ii) activate a building occupant warning system in accordance with **Clause 6**.
- (b) In kitchens and other areas where the use of the area is likely to result in smoke detectors causing spurious signals—
 - (i) any other detector deemed suitable in accordance with AS 1670.1 may be installed provided that smoke detectors are installed elsewhere in the *sole-occupancy unit* in accordance with **Clause 3(c)(i)** and **3(c)(ii)**; or
 - (ii) an alarm acknowledgement facility may be installed,

Deemed-to-Satisfy Provisions

except where the kitchen or other area is sprinklered, the detectors need not be installed in the kitchen or other areas likely to result in spurious signals.

- (c) In a Class 2 or 3 building or Class 4 part of a building smoke detectors must be installed—
 - (i) within each *sole-occupancy unit*, in accordance with the requirements for alarms in **Clause 3(c)(i)** and **3(c)(ii)**; and
 - (ii) in a building not protected with a sprinkler system, in *public corridors* and other internal public spaces.
- (d) In a Class 9a *health-care building*—
 - (i)
 - (A) photoelectric type smoke detectors must be installed in *patient care areas* and in paths of travel to *exits* from *patient care areas*; and
 - (B) in areas other than *patient care areas* and paths of travel to *exits* from *patient care areas*, where the use of the area is likely to result in smoke detectors causing spurious signals, any other detector deemed suitable in accordance with AS 1670.1 may be installed in lieu of smoke detectors,

except where an area is sprinklered, smoke detectors need not be installed where the use of the area is likely to result in spurious signals; and
 - (ii) manual call points must be installed in *evacuation routes* so that no point on a floor is more than 30 m from a manual call point.

Vic Spec E2.2a 4(e)

- (e) In a Class 9c building—
 - (i) remote automatic indication of each zone must be given in each smoke compartment by means of—
 - (A) mimic panels with an illuminated display; or
 - (B) annunciator panels with alpha numeric display; and
 - (ii) if the building accommodates more than 20 residents, manual call points must be installed in paths of travel so that no point on a floor is more than 30 m from a manual call point.

5. Smoke detection for smoke control systems

- (a) Smoke detectors *required* to activate air pressurisation systems for fire-isolated *exits* and zone smoke control systems must—
 - (i) be installed in accordance with AS 1670.1; and
 - (ii) have additional smoke detectors installed adjacent to each bank of lift landing doors set back horizontally from the door openings by a distance of not more than 3 m.
- (b) Smoke detectors *required* to activate—
 - (i) *automatic* shutdown of air-handling systems in accordance with **Table E2.2b**; or
 - (ii) a smoke exhaust system in accordance with **Specification E2.2b**, must—

Deemed-to-Satisfy Provisions

- (iii) be spaced—
 - (A) not more than 20 m apart and not more than 10 m from any wall, bulkhead or smoke curtain; and
 - (B) in enclosed malls and walkways in a Class 6 building not more than 15 m apart and not more than 7.5 m from any wall, bulkhead or curtain; and
- (iv) have a sensitivity—
 - (A) in accordance with AS 1670.1 in areas other than a multi-storey walkway and mall in a Class 6 building; and
 - (B) not exceeding 0.5% smoke obscuration per metre with compensation for external airborne contamination as necessary, in a multi-storey walkway and mall in a Class 6 building.
- (c) Smoke detectors provided to activate a smoke control system must—
 - (i)
 - (A) form part of a building fire or smoke detection system complying with AS 1670.1; or
 - (B) be a separate dedicated system incorporating control and indicating equipment complying with AS 1670.1; and
 - (ii) activate a building occupant warning system complying with **Clause 6**, except that smoke detectors provided solely to initiate *automatic* shutdown of air-handling systems in accordance with **(b)(i)** need not activate a building occupant warning system.

6. Building occupant warning system

Subject to **E4.9**, a building occupant warning system provided as part of a smoke hazard management system must comply with clause 3.22 of AS 1670.1 to sound through all occupied areas except—

- (a) in a Class 2 and 3 building or Class 4 part of a building provided with a smoke alarm system in accordance with **Clause 3(c)(iii)**—
 - (i) the sound pressure level need not be measured within a *sole-occupancy unit* if a level of not less than 85 dB(A) is provided at the door providing access to the *sole-occupancy unit*; and
 - (ii) the inbuilt sounders of the smoke alarms may be used to wholly or partially meet the requirements; and
- (b) in a Class 2 and 3 building or Class 4 part of a building provided with a smoke detection system in accordance with **Clause 4(c)**, the sound pressure level from a building occupant warning system need not be measured within a *sole-occupancy unit* if a level of not less than 100 dB(A) is provided at the door providing access to the *sole-occupancy unit*; and
- (c) in a Class 3 building used as a *residential aged care building*, the system—
 - (i) must be arranged to provide a warning for occupants; and
 - (ii) in areas used by residents, may have its alarm adjusted in volume and content to minimise trauma consistent with the type and condition of residents; and

Deemed-to-Satisfy Provisions

- (d) in a Class 9a *health-care building*, in a *patient care area*, the system—
 - (i) must be arranged to provide a warning for occupants; and
 - (ii) in a *ward area*, may have its alarm adjusted in volume and content to minimise trauma consistent with the type and condition of the patients; and
- (e) in a Class 9c building, the system—
 - (i) must be arranged to provide a warning for occupants; and
 - (ii) must notify staff caring for the residents of the building; and
 - (iii) in areas used by residents, may have its alarm adjusted in volume and content to minimise trauma consistent with the type and condition of residents.

7. System monitoring

The following installations must be connected to a fire alarm monitoring system connected to a fire station or fire station dispatch centre in accordance with AS 1670.3:

- (a) A smoke detection system in a Class 3 building provided in accordance with **Clause 2(a)(ii)**.

Vic Spec E2.2a 7(b)

- (b) A smoke detection system in a Class 9a *health-care building*, if the building accommodates more than 20 patients.

Vic Spec E2.2a 7(c)

- (c) A smoke detection system in a Class 9c building.
- (d) Smoke detection in accordance with **Clause 5** provided to activate—
 - (i) a smoke exhaust system in accordance with **Specification E2.2b**; or
 - (ii) *smoke-and-heat vents* in accordance with **Specification E2.2c**.

NSW Spec E2.2a 7(e)

- (e) An *automatic* fire detection and alarm system *required* by **Table E2.2a** for large isolated buildings subject to **C2.3**.

SPECIFICATION E2.2b SMOKE EXHAUST SYSTEMS

Deemed-to-Satisfy Provisions

1. Scope

This Specification describes the requirements for mechanical smoke exhaust systems.

2. Smoke exhaust capacity

- (a) Smoke exhaust fans must have a sufficient capacity to contain the smoke layer—
 - (i) within a smoke reservoir formed in accordance with **Clause 4** and not less than 2 m above the highest floor level; and
 - (ii) above the top of any openings interconnecting different smoke reservoirs.
- (b) Exhaust rates must be determined in accordance with **Figure 2**, with the height measurement taken from the lowest floor level to the underside of the smoke layer.

3. Smoke exhaust fans

Each smoke exhaust fan, complete with its drive, flexible connections, control gear and wiring must—

- (a) be constructed and installed so that it is capable of continuous operation (exhausting the *required* volumetric flow rate at the installed system resistance) at a temperature of 200° C for a period of not less than 1 hour; and
- (b) in a building not fitted with a sprinkler system, be capable of continuous operation at a temperature of 300° C for a period of not less than 30 minutes; and
- (c) be rated to handle the *required* volumetric flow rate at ambient temperature to be capable of exhausting cool smoke during the early stages of a fire and to allow routine testing; and
- (d) have any high temperature overload devices installed, *automatically* overridden during the smoke exhaust operation.

Deemed-to-Satisfy Provisions

Figure 2

SMOKE EXHAUST RATE

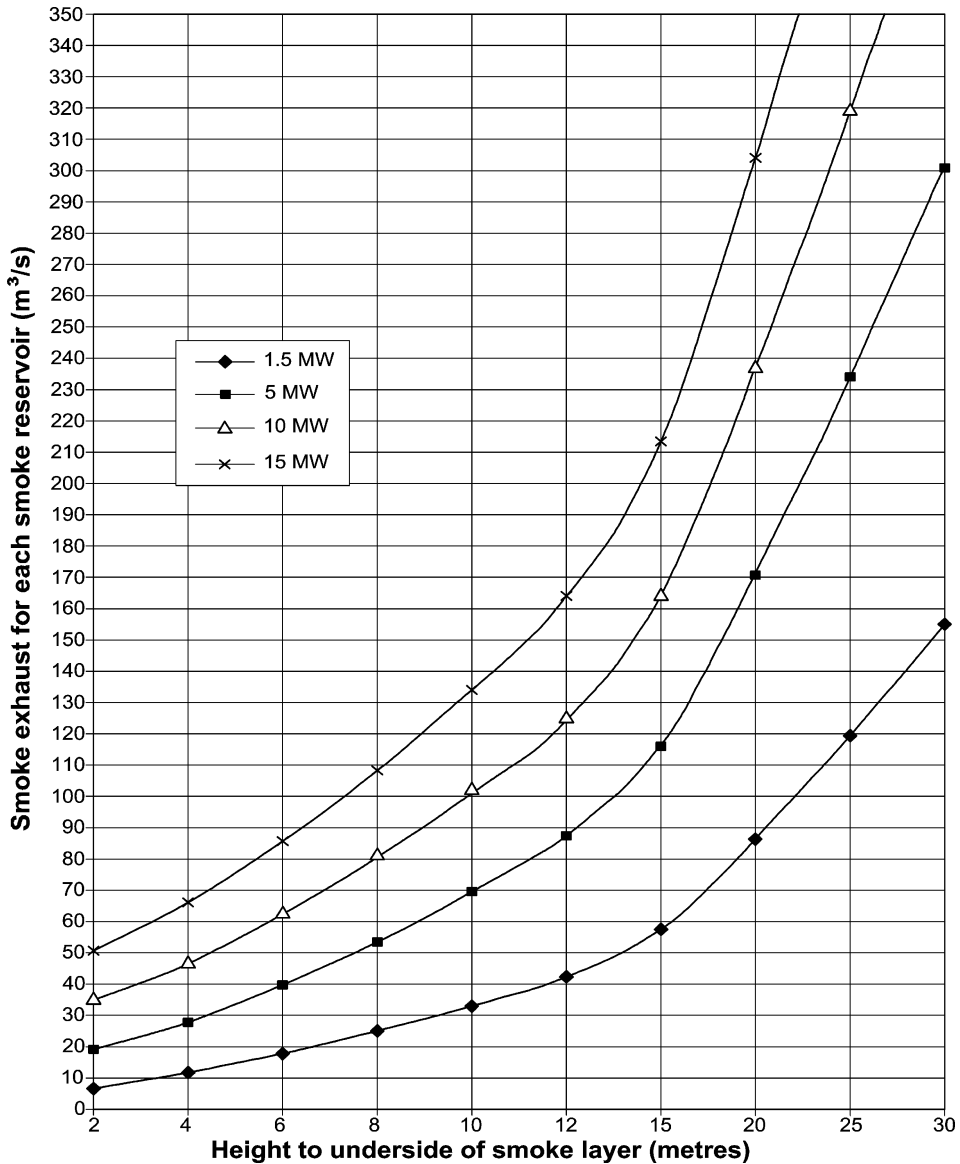

Classification	Fire Load (MW)	
	Unsprinklered	Sprinklered
Class 2, 3 or 5	5	1.5
Class 6	10	5
Class 7 or 8	15	5

Deemed-to-Satisfy Provisions

Figure 2

SMOKE EXHAUST RATE

Class 9—		
Generally	5	1.5
Class 9b buildings covered by Part H1 (see Note), or exhibition halls.	10	5

Note: If the smoke reservoir above the *stage* is smoke separated from the audience area, the *fire load* specified applies to the *stage* area only and the *fire load* for the audience area is as per Class 9 generally.

4. Smoke reservoirs

- (a) A *fire compartment* must be divided at ceiling level into smoke reservoirs formed by smoke baffles/curtains of *non-combustible* and non-shatterable construction.
- (b) The horizontal area of a smoke reservoir must not exceed 2000 m² and in enclosed walkways and malls of a Class 6 building must not exceed 60 m in length.
- (c) Smoke reservoirs must be of sufficient depth to contain the smoke layer and must not be less than 500 mm below an imperforate ceiling or roof.
- (d)
 - (i) Within a multi-*storey fire compartment*, a *non-combustible* bulkhead or smoke baffle/curtain must be provided around the underside of each opening into a building void to minimise the spread of smoke to other *storeys*.
 - (ii) The depth of the bulkhead or smoke baffle must be not less than the depth of the smoke reservoir provided under (c) plus an additional 400 mm.

5. Smoke exhaust fan and vent location

Smoke exhaust fans and vents must be located—

- (a) such that each smoke reservoir is served by one or more fans with the maximum exhaust rate at any one point limited to avoid extracting air from below the smoke layer; and
- (b) to prevent the formation of stagnant regions resulting in excessive cooling and downward mixing of smoke; and
- (c) at natural collection points for the hot smoky gases within each smoke reservoir having due regard to the ceiling geometry and its effect on the migratory path of the smoke; and
- (d) away from the intersection of walkways or malls; and
- (e) to ensure that any voids containing escalators and/or stairs commonly used by the public are not used as a smoke exhaust path; and
- (f) to discharge directly to outdoor with a velocity of not less than 5 m/s, at a suitable point not less than 6 m from any air intake point or *exit*.

6. Make-up air

- (a) Low level make-up air must be provided either *automatically* or via permanent ventilation openings to replace the air exhausted so as to minimise—

Deemed-to-Satisfy Provisions

- (i) any disturbance of the smoke layer due to turbulence created by the incoming air; and
 - (ii) the risk of smoke migration to areas remote from the fire due to the effect of make-up air on the air balance of the total system.
- (b) The velocity of make-up air through doorways must not exceed 2.5 m/s.
- (c) Within a multi-*storey fire compartment*, make-up air must be provided across each vertical opening from a building void to the fire-affected *storey* at an average velocity of 1 m/s so as to minimise the spread of smoke from the fire-affected *storey* to other *storeys*.

7. Smoke exhaust system control

- (a) Each smoke exhaust fan must be activated sequentially by smoke detectors complying with **Specification E2.2a** and arranged in zones to match the smoke reservoir served by the fan(s).
- (b) Subject to (c) and (d), an air handling system (other than individual room units less than 1000 L/s and miscellaneous exhaust air systems installed in accordance with Sections 5 and 6 of AS/NZS 1668.1) which does not form part of the smoke hazard management system must be *automatically* shut down on the activation of the smoke exhaust system.
- (c) In a single *storey fire compartment*, air handling systems in all non fire-affected zones may operate on 100% *outdoor air* to provide make-up air to the fire-affected zone.
- (d) Within a multi-*storey fire compartment*, air handling systems in all non fire-affected zones and *storeys* must operate at 100% *outdoor air* to provide make-up air to the fire-affected *storey* via building voids connecting *storeys*.
- (e) Manual override control and indication together with operating instructions for use by emergency personnel must be provided adjacent to the fire indicator panel in accordance with the requirements of clauses 4.11 and 4.13 of AS/NZS 1668.1.
- (f) Manual control for the smoke exhaust system must also be provided at a location normally used by the *stage* manager in a theatre.
- (g) Power supply wiring to exhaust fans together with detection, control, and indication circuits (and where necessary to *automatic* make-up air supply arrangements) must comply with AS/NZS 1668.1.

8. Smoke detection

A smoke detection system must be installed in accordance with **Specification E2.2a** to activate the smoke exhaust system.

SPECIFICATION **E2.2c** SMOKE-AND-HEAT VENTS

Deemed-to-Satisfy Provisions

1. Adoption of AS 2665

Automatic smoke-and-heat vents must be installed as a system complying with AS 2665 except that—

- (a) * * * * *
- (b) * * * * *
- (c) permanently open vents may form part of the smoke/heat venting system provided they comply with the relevant criteria for *automatic smoke-and-heat vents* in AS 2665.

2. Controls

Where a *smoke-and-heat vent* system is installed to comply with **Table E2.2b**, the following must apply:

- (a) In addition to thermally released link operation, *smoke-and-heat vents* must also be initiated by smoke detection complying with **Clauses 5 and 7 of Specification E2.2a** and arranged in zones to match the smoke reservoirs.

PART E3 LIFT INSTALLATIONS

PERFORMANCE REQUIREMENTS

EP3.1

Stretcher facilities must be provided, to the degree necessary—

- (a) in at least one emergency lift *required* by EP3.2; or
- (b) where an emergency lift is not *required* and a passenger lift is provided, in at least one lift, to serve each floor in the building served by the passenger lift.

EP3.2

One or more passenger lifts fitted as emergency lifts to serve each floor served by the lifts in a building must be installed to facilitate the activities of the *fire brigade* and other emergency services personnel.

Application:

EP3.2 only applies to—

- (a) a building with an *effective height* of more than 25 m; and
- (b) a Class 9a building in which *patient care areas* are located at a level that does not have direct access to a road or *open space*.

EP3.3

Signs or other means must be provided to alert occupants about the use of a lift during an emergency.

EP3.4

When a passenger lift is provided in a building *required* to be *accessible*, it must be suitable for use by people with a disability.

PART E3

LIFT INSTALLATIONS

Deemed-to-Satisfy Provisions

E3.0 Deemed-to-Satisfy Provisions

- (a) Where a *Deemed-to-Satisfy Solution* is proposed, *Performance Requirements EP3.1* to *EP3.4* are satisfied by complying with—
 - (i) **E3.1** to **E3.10**; and
 - (ii) for public transport buildings, **Part H2**.
- (b) Where a *Performance Solution* is proposed, the relevant *Performance Requirements* must be determined in accordance with **A0.7**.

E3.1 Lift installations

An *electric passenger lift* installation and an *electrohydraulic passenger lift* installation must comply with **Specification E3.1**.

E3.2 Stretcher facility in lifts

- (a) A stretcher facility in accordance with **(b)** must be provided—
 - (i) in at least one emergency lift *required* by **E3.4**; or
 - (ii) where an emergency lift is not *required*, if passenger lifts are installed to serve any storey above an *effective height* of 12 m, in at least one of those lifts to serve each floor served by the lifts.
- (b) A stretcher facility must accommodate a raised stretcher with a patient lying on it horizontally by providing a clear space not less than 600 mm wide x 2000 mm long x 1400 mm high above the floor level.

E3.3 Warning against use of lifts in fire

A warning sign must—

- (a) be displayed where it can be readily seen—
 - (i) near every call button for a passenger lift or group of lifts throughout a building; except
 - (ii) a small lift such as a dumb-waiter or the like that is for the transport of goods only; and
- (b) comply with the details and dimensions of **Figure E3.3** and consist of—
 - (i) incised, inlaid or embossed letters on a metal, wood, plastic or similar plate securely and permanently attached to the wall; or
 - (ii) letters incised or inlaid directly into the surface of the material forming the wall.

Deemed-to-Satisfy Provisions

Figure E3.3

WARNING SIGN FOR PASSENGER LIFTS

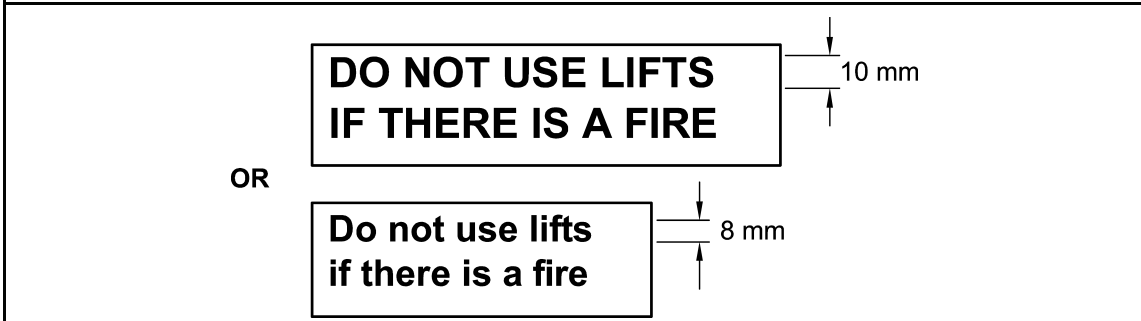

E3.4 Emergency lifts

- (a) At least one emergency lift complying with (d) must be installed in—
 - (i) a building which has an *effective height* of more than 25 m; and
 - (ii) a Class 9a building in which *patient care areas* are located at a level that does not have direct egress to a road or *open space*.
- (b) An emergency lift may be combined with a passenger lift and must serve those *storeys* served by the passenger lift so that all *storeys* of the building served by passenger lifts are served by at least one emergency lift.
- (c) Where two or more passenger lifts are installed and serve the same *storeys*, excluding a lift that is within an *atrium* and not contained wholly within a *shaft*—
 - (i) at least two emergency lifts must be provided to serve those *storeys*; and
 - (ii) if located within different *shafts*, at least one emergency lift must be provided in each *shaft*.
- (d) An emergency lift must—
 - (i) be contained within a *fire-resisting shaft* in accordance with C2.10; and
 - (ii) in a Class 9a building serving a *patient care area*—
 - (A) have minimum dimensions, measured clear of all obstructions, including handrails, etc complying with Table E3.4; and
 - (B) be connected to a standby power supply system where installed; and
 - (iii) if the building has an *effective height* of more than 75 m, have a rating of at least—
 - (A) 600 kg if not provided with a stretcher facility; or
 - (B) 900 kg if provided with a stretcher facility.

Deemed-to-Satisfy Provisions

Table E3.4 MINIMUM EMERGENCY LIFT DIMENSIONS IN CLASS 9a BUILDINGS

Minimum depth of car	2280 mm
Minimum width of car	1600 mm
Minimum floor to ceiling height	2300 mm
Minimum door height	2100 mm
Minimum door width	1300 mm

E3.5 Landings

Access and egress to and from liftwell landings must comply with the *Deemed-to-Satisfy Provisions* of **Section D**.

E3.6 Passenger lifts

In an *accessible* building, every passenger lift must—

- (a) be one of the types identified in **Table E3.6a**, subject to the limitations on use specified in the Table; and
- (b) have *accessible* features in accordance with **Table E3.6b**; and
- (c) not rely on a constant pressure device for its operation if the lift car is fully enclosed.

Table E3.6a LIMITATIONS ON USE OF TYPES OF PASSENGER LIFTS

Lift type	Limitations on use
<i>Electric passenger lift</i>	No limitation.
<i>Electrohydraulic passenger lift</i>	No limitation.
<i>Stairway platform lift</i>	Must not— <ol style="list-style-type: none"> (a) be used to serve a space in a building accommodating more than 100 persons calculated according to D1.13; or (b) be used in a high traffic public use area such as a theatre, cinema, auditorium, transport interchange, shopping centre or the like; or (c) be used where it is possible to install another type of passenger lift; or (d) connect more than 2 <i>storeys</i>; or (e) where more than 1 stairway lift is installed, serve more than 2 consecutive <i>storeys</i>; or (f) when in the folded position, encroach on the minimum width of a stairway <i>required</i> by D1.6.
<i>Inclined lift</i>	No limitation.
<i>Low-rise platform lift</i>	Must not travel more than 1000 mm.
<i>Low-rise, low-speed constant pressure lift</i>	Must not— <ol style="list-style-type: none"> (a) for an enclosed type, travel more than 4 m; or

Deemed-to-Satisfy Provisions

Table E3.6a LIMITATIONS ON USE OF TYPES OF PASSENGER LIFTS— continued

Lift type	Limitations on use
	(b) for an unenclosed type, travel more than 2 m; or (c) be used in high traffic public use areas in buildings such as a theatre, cinema, auditorium, transport interchange, shopping complex or the like.
<i>Small sized, low-speed automatic lift</i>	Must not travel more than 12 m.

Table E3.6b APPLICATION OF FEATURES TO PASSENGER LIFTS

Feature	Application
Handrail complying with the provisions for a mandatory handrail in AS 1735.12	All lifts except— (a) a <i>stairway platform lift</i> ; and (b) a <i>low-rise platform lift</i> .
Lift floor dimension of not less than 1400 mm wide x 1600 mm deep	All lifts which travel more than 12 m.
Lift floor dimensions of not less than 1100 mm wide x 1400 mm deep	All lifts which travel not more than 12 m except a <i>stairway platform lift</i> .
Lift floor dimensions of not less than 810 mm wide x 1200 mm deep	A <i>stairway platform lift</i> .
Minimum clear door opening complying with AS 1735.12	All lifts except a <i>stairway platform lift</i> .
Passenger protection system complying with AS 1735.12	All lifts with a power operated door.
Lift landing doors at the upper landing	All lifts except a <i>stairway platform lift</i> .
Lift car and landing control buttons complying with AS 1735.12	All lifts except— (a) a <i>stairway platform lift</i> ; and (b) a <i>low-rise platform lift</i> .
Lighting in accordance with AS 1735.12	All enclosed lift cars.
(a) Automatic audible information within the lift car to identify the level each time the car stops; and (b) audible and visual indication at each lift landing to indicate the arrival of the lift car; and (c) audible information and audible indication <i>required</i> by (a) and (b) is to be provided in a range of between 20–80 dB(A) at a maximum frequency of 1 500 Hz	All lifts serving more than 2 levels.

Deemed-to-Satisfy Provisions

Table E3.6b APPLICATION OF FEATURES TO PASSENGER LIFTS— continued

Feature	Application
Emergency hands-free communication, including a button that alerts a call centre of a problem and a light to signal that the call has been received	All lifts except a <i>stairway platform lift</i> .

E3.7 Fire service controls

Where lifts serve any *storey* above an *effective height* of 12m, the following must be provided:

- (a) A fire service recall control switch complying with **E3.9** for—
 - (i) a group of lifts; or
 - (ii) a single lift not in a group that serves the *storey*.
- (b) A lift car fire service drive control switch complying with **E3.10** for every lift.

E3.8 Aged care buildings

Where residents in a Class 9c *aged care building* are on levels which do not have direct access to a road or *open space*, the building must be provided with either—

- (a) at least one lift to accommodate a stretcher in accordance with **E3.2(b)**; or
- (b) a ramp in accordance with AS 1428.1, and

the lift or ramp must discharge at a level providing direct access to a road or *open space*.

E3.9 Fire service recall control switch

- (a) Each group of lifts must be provided with one fire service recall control switch *required* by **E3.7** that activates the fire service recall operation at **(e)**. The switch must—
 - (i) be located at the landing nominated by the *appropriate authority*; and
 - (ii) be labelled "FIRE SERVICE" in indelible white lettering on a red background; and
 - (iii) have two positions with an "OFF" and an "ON" position identified; and
 - (iv) be operable only by the use of a key that is removable in either the "OFF" position or the "ON" position.
- (b) Adhesive labels must not be used for compliance with **(a)(ii)** and **(a)(iii)**.
- (c) The key in **(a)(iv)** must be able to turn all fire service recall control switches in the building and must have a different key combination to other keys used for lifts in the building.
- (d) The fire service recall operation must be activated by—
 - (i) switching the fire service recall control switch in **(a)** to "ON"; or
 - (ii) a signal from a fire management system approved by the *appropriate authority*.
- (e) The activation of the fire service recall operation at **(d)** must—
 - (i) cancel all registered car and landing calls; and
 - (ii) inactivate all door reopening devices that may be affected by smoke; and

Deemed-to-Satisfy Provisions

- (iii) ensure lift cars travelling toward the nominated floor continue to the nominated floor without stopping; and
 - (iv) ensure lift cars travelling away from the nominated floor stop at or before the next available floor without opening the doors (either automatically or by the door open button), reverse direction and travel without stopping to the nominated floor; and
 - (v) for lifts stopped at a floor other than the nominated floor, close the doors and travel without stopping to the nominated floor; and
 - (vi) ensure that lifts stay at the nominated floor with doors open; and
 - (vii) permit all lifts to return to normal service if the fire service recall control switch at (a) is switched to the "OFF" position during or after the fire service recall operation.
- (f) The requirements of (e) do not apply to lifts on inspection service or when the lift car fire service control switch *required* by **E3.10** is in the "ON" position.
- (g) Lifts having manual controls must signal an alert to the lift for the lift to return to the nominated floor containing the recall switch that activated the signal.

E3.10 Lift car fire service drive control switch

- (a) The lift car fire service drive control switch *required* by **E3.7** must be activated from within the lift car. The switch must—
- (i) be located between 600 mm and 1500 mm above the lift car floor; and
 - (ii) be labelled "FIRE SERVICE" by indelible white lettering on a red background; and
 - (iii) have two positions with an "OFF" and an "ON" position identified; and
 - (iv) operate only by the use of a key that is removable in either the "OFF" position or the "ON" position.
- (b) Adhesive labels must not be used for compliance with (a)(ii) or (a)(iii).
- (c) When the lift car fire service drive control switch at (a) is turned to the "ON" position, the lift must—
- (i) not respond to the fire service recall control switch; and
 - (ii) cancel all registered lift car and landing calls; and
 - (iii) override all lift car call access control systems; and
 - (iv) inactivate all door reopening devices that may be affected by smoke; and
 - (v) allow the registration of lift car call by lift car call buttons, however the lift doors must not close in response to the registration of lift car calls; and
 - (vi) activate door closing by constant pressure being applied on the "door close" button unless the button is released before the doors are fully closed, in which case the doors must reopen and any registered lift car calls must be cancelled; and
 - (vii) when the doors are closed, move the lift in response to registered lift car calls while allowing additional lift car calls to also be registered; and
 - (viii) travel to the first possible floor in response to registered lift car calls and cancel all registered lift car calls after the lift stops; and

Deemed-to-Satisfy Provisions

- (ix) ensure doors do not open automatically, rather by constant pressure being applied on the "door open" button unless the button is released before the doors are fully open, in which case the doors must re-close; and

the requirements of **(c)(i)** to **(c)(ix)** do not apply to a lift operating on inspection service.

- (d) A multi-deck lift installation must have systems in place that—
 - (i) are able to communicate to the fire officer that the fire service drive control switch will not operate until all decks have been cleared of passengers; and
 - (ii) ensure there is an appropriate method of clearing all deck landings of passengers; and
 - (iii) maintain all doors to deck landings not containing the fire service control switch closed and inoperative while the lift is on fire service drive control.

SPECIFICATION **E3.1** LIFT INSTALLATIONS

Deemed-to-Satisfy Provisions

1. Scope

This Specification contains requirements for *electric passenger lift* installations and *electrohydraulic passenger lift* installations.

2. Lift cars exposed to solar radiation

- (a) A lift car exposed to solar radiation directly, or indirectly by re-radiation, must have—
 - (i) mechanical ventilation at a rate of one air change per minute; or
 - (ii) mechanical cooling.
- (b) A 2 hour alternative power source for ventilation or mechanical cooling at (a) must be provided in the event of normal power loss.

3. Lift car emergency lighting

A lift car must have an emergency lighting system designed—

- (a) to come on automatically upon failure of the normal lighting supply; and
- (b) to provide at least 20 lux of lighting for 2 hours on the alarm initiation button.

4. Cooling of lift shaft

While a lift in a lift *shaft* is in service, the cooling of the lift *shaft* must—

- (a) ensure that the dry bulb air temperature in the lift *shaft* does not exceed 40°C; and
- (b) if the cooling is by a ventilation system, be provided with an air change rate determined using a temperature rise of no more than 5 K.

5. Lift foyer access

Where there is a security foyer in a building, access may be via locked security doors provided—

- (a) security doors revert to the unlocked state in the event of—
 - (i) power failure; or
 - (ii) fire alarm; and
- (b) locked foyer areas are monitored by closed circuit television and intercom system to a 24 hour staffed location.

6. Emergency access doors in a single enclosed lift shaft

- (a) Where a lift is installed in a single enclosed lift *shaft* having a distance between normal landing entrances greater than 12.2 m, emergency access doors must be provided and constructed as follows:

Deemed-to-Satisfy Provisions

- (i) The clear opening size of emergency doors must be not less than 600 mm wide x 980 mm high.
 - (ii) Hinged doors must not open towards the interior of the lift *shaft*.
 - (iii) Doors must be *self-closing* and self-locking.
 - (iv) Doors must be marked on the landing side with the letters not less than 35 mm high:
"DANGER LIFTWELL ACCESS"
"KEEP FURNITURE AND FIXTURES CLEAR".
 - (v) Doors from the landing side must only be openable by a tool.
 - (vi) Each emergency door must be provided with a positive breaking electrical contact, wired into the control circuit to prevent movement of the lift until the emergency door is both closed and locked.
- (b) In single enclosed lift *shafts* where—
- (i) ropes are installed; and
 - (ii) the vertical distance between the lift car sill and the landing door head is less than 600 mm; and
 - (iii) the counterweight is resting on its fully compressed buffer,
- emergency egress from the lift car must be provided in the form of an interlocked door with clear opening dimensions not less than 600 mm x 600 mm, accessible from the lift car entrance or the lift car roof (where the door is located in the wall of the lift *shaft*).

PART E4

VISIBILITY IN AN EMERGENCY, EXIT SIGNS AND WARNING SYSTEMS

PERFORMANCE REQUIREMENTS

EP4.1

To facilitate safe evacuation in an emergency, a building must be provided with a system that—

- (a) ensures a level of visibility sufficient to enable *exits*, paths of travel to *exits* and any obstacles along a path of travel to an *exit* to be identified; and
- (b) activates instantaneously upon the failure of an artificial lighting system, to the degree necessary, appropriate to—
 - (c) the function or use of the building; and
 - (d) the *floor area* of the building; and
 - (e) the distance of travel to an *exit*.

Limitation:

EP4.1 does not apply to the internal parts of a *sole-occupancy unit* in a Class 2, 3 or 9c building or Class 4 part of a building.

EP4.2

To facilitate evacuation, suitable signs or other means of identification must, to the degree necessary—

- (a) be provided to identify the location of *exits*; and
- (b) guide occupants to *exits*; and
- (c) be clearly visible to occupants; and
- (d) operate in the event of a power failure of the main lighting system for sufficient time for occupants to safely evacuate.

Limitation:

EP4.2 does not apply to the internal parts of a *sole-occupancy unit* in a Class 2 or 3 building or Class 4 part of a building.

EP4.3

To warn occupants of an emergency and assist evacuation of a building, a sound system and intercom system for emergency purposes must be provided, to the degree necessary, appropriate to—

- (a) the *floor area* of the building; and

- (b) the function or use of the building; and
- (c) the height of the building.

VERIFICATION METHODS

EV4.1 Emergency Lighting

Compliance with **EP4.1** is verified for the level of visibility for safe evacuation in an emergency and instantaneous activation, when an emergency lighting system satisfies the requirements below:

- (a) The calculated horizontal *illuminance* is not less than—
 - (i) 0.2 lux at floor level in the path of travel to an *exit*; and
 - (ii) 1 lux at each floor level or tread in every *required*—
 - (A) *fire-isolated stairway*; or
 - (B) *fire-isolated passageway*; or
 - (C) *fire-isolated ramp*; or
 - (D) *non-fire-isolated stairway*; or
 - (E) *non-fire-isolated ramp*.
- (b) The emergency lighting provides a level of *illuminance* not less than—
 - (i) 10% of that *required* by (a) within 1 second of energization; and
 - (ii) 80% of that *required* by (a) within 15 seconds of energization.
- (c) The full level of illumination *required* by (a) must be achieved within 60 seconds of energization.
- (d) An emergency lighting system must operate at not less than the minimum *required* level of *illuminance* for not less than 90 minutes.

PART E4

VISIBILITY IN AN EMERGENCY, EXIT SIGNS AND WARNING SYSTEMS

Deemed-to-Satisfy Provisions

E4.0 Deemed-to-Satisfy Provisions

- (a) Where a *Deemed-to-Satisfy Solution* is proposed, *Performance Requirements EP4.1 to EP4.3* are satisfied by complying with—
- (i) **E4.1 to E4.9**; and
 - (ii) in a building containing an *atrium*, **Part G3**; and
 - (iii) in a building in an *alpine area*, **Part G4**; and
 - (iv) for additional requirements for Class 9b buildings, **Part H1**; and
 - (v) for *farm buildings* and *farm sheds*, **Part H3**.
- (b) Where a *Performance Solution* is proposed, the relevant *Performance Requirements* must be determined in accordance with **A0.7**.

E4.1 * * * * *

This clause has deliberately been left blank.

E4.2 Emergency lighting requirements

An emergency lighting system must be installed—

- (a) in every *fire-isolated stairway*, *fire-isolated passageway* or *fire-isolated ramp*; and
- (b) in every *storey* of a Class 5, 6, 7, 8 or 9 building where the *storey* has a *floor area* more than 300 m²—
 - (i) in every passageway, corridor, hallway, or the like, that is part of the path of travel to an *exit*; and
 - (ii) in any room having a *floor area* more than 100 m² that does not open to a corridor or space that has emergency lighting or to a road or *open space*; and
 - (iii) in any room having a *floor area* more than 300 m²; and
- (c) in every passageway, corridor, hallway, or the like, having a length of more than 6 m from the entrance doorway of any *sole-occupancy unit* in a Class 2 or 3 building or Class 4 part of a building to the nearest doorway opening directly to—
 - (i) a *fire-isolated stairway*, *fire-isolated passageway* or *fire-isolated ramp*; or
 - (ii) an external stairway serving instead of a *fire-isolated stairway* under **D1.8**; or
 - (iii) an external balcony leading to a *fire-isolated stairway*, *fire-isolated passageway* or *fire-isolated ramp*; or
 - (iv) a road or *open space*; and
- (d) in every *required non-fire-isolated stairway*; and

Deemed-to-Satisfy Provisions

- (e) in a *sole-occupancy unit* in a Class 5, 6 or 9 building if—
 - (i) the *floor area* of the unit is more than 300 m²; and
 - (ii) an *exit* from the unit does not open to a road or *open space* or to an external stairway, passageway, balcony or ramp, leading directly to a road or *open space*; and
- (f) in every room or space to which there is public access in every *storey* in a Class 6 or 9b building if—
 - (i) the *floor area* in that *storey* is more than 300 m²; or
 - (ii) any point on the floor of that *storey* is more than 20 m from the nearest doorway leading directly to a stairway, ramp, passageway, road or *open space*; or
 - (iii) egress from that *storey* involves a vertical rise within the building of more than 1.5 m, or any vertical rise if the *storey* concerned does not admit sufficient light; or
 - (iv) the *storey* provides a path of travel from any other *storey required* by (i), (ii) or (iii) to have emergency lighting; and
- (g) in a Class 9a *health-care building*—
 - (i) in every passageway, corridor, hallway, or the like, serving a *treatment area* or a *ward area*; and
 - (ii) in every room having a *floor area* of more than 120 m² in a *patient care area*; and
- (h) in every Class 9c building excluding within *sole-occupancy units*; and
- (i) in every *required* fire control centre.

E4.3 Measurement of distance

Distances, other than vertical rise, must be measured along the shortest path of travel whether by straight lines, curves or a combination of both.

E4.4 Design and operation of emergency lighting

Every *required* emergency lighting system must comply with AS 2293.1.

E4.5 Exit signs

An *exit* sign must be clearly visible to persons approaching the *exit*, and must be installed on, above or adjacent to each—

- (a) door providing direct egress from a *storey* to—
 - (i) an enclosed stairway, passageway or ramp serving as a *required exit*; and
 - (ii) an external stairway, passageway or ramp serving as a *required exit*; and
 - (iii) an external access balcony leading to a *required exit*; and
- (b) door from an enclosed stairway, passageway or ramp at every level of discharge to a road or *open space*; and
- (c) *horizontal exit*; and
- (d) door serving as, or forming part of, a *required exit* in a *storey required* to be provided with emergency lighting in accordance with **E4.2**.

Deemed-to-Satisfy Provisions

E4.6 Direction signs

NSW E4.6

If an *exit* is not readily apparent to persons occupying or visiting the building then *exit* signs must be installed in appropriate positions in corridors, hallways, lobbies, and the like, indicating the direction to a *required exit*.

E4.7 Class 2 and 3 buildings and Class 4 parts: Exemptions

E4.5 does not apply to—

- (a) a Class 2 building in which every door referred to is clearly and legibly labelled on the side remote from the *exit* or balcony—
 - (i) with the word “EXIT” in capital letters 25 mm high in a colour contrasting with that of the background; or
 - (ii) by some other suitable method; and
- (b) an entrance door of a *sole-occupancy unit* in a Class 2 or 3 building or Class 4 part of a building.

E4.8 Design and operation of exit signs

Every *required exit* sign must comply with—

- (a) AS 2293.1; or
- (b) for a photoluminescent *exit* sign, **Specification E4.8**; and

be clearly visible at all times when the building is occupied by any person having the right of legal entry to the building.

E4.9 Sound systems and intercom systems for emergency purposes

A sound system and intercom system for emergency purposes complying where applicable with AS 1670.4 must be installed—

- (a) in a building with an *effective height* of more than 25 m; and
- (b) in a Class 3 building having a *rise in storeys* of more than 2 and used as—
 - (i) the residential part of a *school*; or
 - (ii) accommodation for the aged, children or people with a disability; and
- (c) in a Class 3 building used as a *residential aged care building*, except that the system—
 - (i) must be arranged to provide a warning for occupants; and
 - (ii) in areas used by the residents, may have its alarm adjusted in volume and content to minimise trauma consistent with the type and condition of residents; and
- (d) in a Class 9a building having a *floor area* of more than 1000 m² or a *rise in storeys* of more than 2, and the system—
 - (i) must be arranged to provide a warning for occupants; and
 - (ii) in a *ward area*, may have its alarm adjusted in volume and content to minimise trauma consistent with the type and condition of patients; and

Deemed-to-Satisfy Provisions

- (e) in a Class 9b building—
 - (i) used as a *school* and having a *rise in storeys* of more than 3; or
 - (ii) used as a theatre, public hall, or the like, having a *floor area* more than 1000 m² or a *rise in storeys* of more than 2.

SPECIFICATION **E4.8** PHOTOLUMINESCENT EXIT SIGNS

Deemed-to-Satisfy Provisions

1. Scope

This Specification contains requirements for photoluminescent *exit* signs.

2. Application

A photoluminescent *exit* sign must comply with Section 6 and Appendix D of AS 2293.1, except where varied by this Specification.

3. Illumination

A photoluminescent *exit* sign must—

- (a) be maintained in a continuously charged state by a minimum illumination of 100 lux at the face of the sign by a dedicated light source with a colour temperature not less than 4000 K; and
- (b) in the event of a power failure, continue to provide a minimum luminance of 30 mcd/m² for not less than 90 minutes; and
- (c) have its performance verified by testing in accordance with ASTM E2073-10, except the activation illumination in clause 8.3 is replaced with 54 lux.

4. Pictorial elements

Pictorial elements on a photoluminescent *exit* sign must—

- (a) where the colour white is used, be replaced with a photoluminescent material; and
- (b) be not less than 1.3 times larger than that specified in Table 6.1 of AS 2293.1; and
- (c) have a border of photoluminescent material that extends not less than 15 mm beyond the pictorial elements.

5. Viewing distance

The maximum viewing distance in clause 6.6 of AS 2293.1 must not be more than 24 m.

6. Smoke control systems

Smoke control systems required by clause 6.3 of AS 2293.1 do not apply to a photoluminescent *exit* sign.

HEALTH AND AMENITY

- F1 Damp and Weatherproofing**
- F2 Sanitary and Other Facilities**
- F3 Room Heights**
- F4 Light and Ventilation**
- F5 Sound Transmission and Insulation**

SECTION F CONTENTS

SECTION F HEALTH AND AMENITY

Part F1 Damp and Weatherproofing

- Performance Requirements FP1.1 - FP1.7
- Verification Methods FV1
- F1.0 Deemed-to-Satisfy Provisions
- F1.1 Stormwater drainage
- F1.2 * * * * *
- F1.3 * * * * *
- F1.4 External above ground membranes
- F1.5 Roof coverings
- F1.6 Sarking
- F1.7 Waterproofing of wet areas in buildings
- F1.8 * * * * *
- F1.9 Damp-proofing
- F1.10 Damp-proofing of floors on the ground
- F1.11 Provision of floor wastes
- F1.12 Sub-floor ventilation
- F1.13 Glazed assemblies

Part F2 Sanitary and Other Facilities

- Performance Requirements FP2.1 - FP2.6
- F2.0 Deemed-to-Satisfy Provisions
- F2.1 Facilities in residential buildings
- F2.2 Calculation of number of occupants and facilities
- F2.3 Facilities in Class 3 to 9 buildings
- F2.4 Accessible sanitary facilities
- F2.5 Construction of sanitary compartments
- F2.6 Interpretation: Urinals and washbasins
- F2.7 Microbial (legionella) control
- F2.8 Waste management

Part F3 Room Heights

- Performance Requirements FP3.1
- F3.0 Deemed-to-Satisfy Provisions
- F3.1 Height of rooms and other spaces

Part F4 Light and Ventilation

- Performance Requirements FP4.1 - FP4.5
- Verification Methods FV4.1 - FV4.2
- F4.0 Deemed-to-Satisfy Provisions
- F4.1 Provision of natural light
- F4.2 Methods and extent of natural lighting
- F4.3 Natural light borrowed from adjoining room

- F4.4 Artificial lighting
- F4.5 Ventilation of rooms
- F4.6 Natural ventilation
- F4.7 Ventilation borrowed from adjoining room
- F4.8 Restriction on location of sanitary compartments
- F4.9 Airlocks
- F4.10 * * * * *
- F4.11 Carparks
- F4.12 Kitchen local exhaust ventilation

Part F5 Sound Transmission and Insulation

- Performance Requirements FP5.1 - FP5.6
- Verification Methods FV5.1 and FV5.2
- F5.0 Deemed-to-Satisfy Provisions
- F5.1 Application of Part
- F5.2 Determination of airborne sound insulation ratings
- F5.3 Determination of impact sound insulation ratings
- F5.4 Sound insulation rating of floors
- F5.5 Sound insulation rating of walls
- F5.6 Sound insulation rating of internal services
- F5.7 Sound isolation of pumps
- Specification F5.2 Sound Insulation for Building Elements
- Specification F5.5 Impact Sound - Test of Equivalence

PART F1 DAMP AND WEATHERPROOFING

PERFORMANCE REQUIREMENTS

FP1.1

Surface water, resulting from a storm having an *average recurrence interval* of 20 years and which is collected or concentrated by a building or *sitework*, must be disposed of in a way that avoids the likelihood of damage or nuisance to any *other property*.

FP1.2

Surface water, resulting from a storm having an *average recurrence interval* of 100 years must not enter the building.

Limitation:

FP1.2 does not apply to—

- (a) a Class 7 or 8 building where in the particular case there is no necessity for compliance; or
- (b) a garage, tool shed, *sanitary compartment*, or the like, forming part of a building used for other purposes; or
- (c) an *open spectator stand* or *open-deck carpark*.

FP1.3

A drainage system for the disposal of *surface water* resulting from a storm having an *average recurrence interval* of—

- (a) 20 years must—
 - (i) convey *surface water* to an appropriate *outfall*; and
 - (ii) avoid *surface water* damaging the building; and
- (b) 100 years must avoid the entry of *surface water* into a building.

FP1.4

A roof and *external wall* (including openings around *windows* and doors) must prevent the penetration of water that could cause—

- (a) unhealthy or dangerous conditions, or loss of amenity for occupants; and
- (b) undue dampness or deterioration of building elements.

Limitation:

FP1.4 does not apply to—

- (a) a Class 7 or 8 building where in the particular case there is no necessity for compliance; or
- (b) a garage, tool shed, *sanitary compartment*, or the like, forming part of a building used for other purposes; or
- (c) an *open spectator stand* or *open-deck carpark*.

FP1.5

SA FP1.5

Moisture from the ground must be prevented from causing—

- (a) undue dampness or deterioration of building elements; and
- (b) unhealthy or dangerous conditions, or loss of amenity for occupants.

Limitation:

FP1.5 does not apply to—

- (a) a Class 7 or 8 building where in the particular case there is no necessity for compliance; or
- (b) a garage, tool shed, *sanitary compartment*, or the like, forming part of a building used for other purposes; or
- (c) an *open spectator stand* or *open-deck carpark*.

FP1.6

SA FP1.6

Overflow from a bathroom, laundry facility or the like must be prevented from penetrating to—

- (a) another *sole-occupancy unit* used for sleeping accommodation; and
- (b) a public space,

in a *storey* below in the same building.

FP1.7

To protect the structure of the building and to maintain the amenity of the occupants, water must be prevented from penetrating—

- (a) behind fittings and linings; and
- (b) into concealed spaces,

of *sanitary compartments*, bathrooms, laundries and the like.

SA FP1.8

VERIFICATION METHODS

FV1 Weatherproofing

- (a) Compliance with **FP1.4** for weatherproofing of an *external wall*— that

- (i) has a risk score of 20 or less, when the sum of all risk factor scores are determined in accordance with **Table FV1.1**; and
- (ii) is not subjected to an ultimate limit state wind pressure of more than 2.5 kPa; and
- (iii) includes only windows that comply with AS 2047,
is verified when a prototype passes the procedure described below:
 - (iv) The test specimen is in accordance with the requirements of **(b)**.
 - (v) The test procedure is in accordance with the requirements of **(c)**.
 - (vi) The test specimen does not fail the criteria in **(d)**.
 - (vii) The test is recorded in accordance with the requirements of **(e)**.

Table FV1.1 – RISK FACTORS AND SCORES

Risk factor	Category	Risk severity	Score
Wind region	Region A (AS/NZS 1170.2)	Low to medium	0
	Region B (AS/NZS 1170.2)		
	Region C (AS/NZS 1170.2)	High	1
	Region D (AS/NZS 1170.2)	Very high	2
Number of storeys	One <i>storey</i>	Low	0
	Two <i>storeys</i> in part	Medium	1
	Two <i>storeys</i>	High	2
	More than two <i>storeys</i>	Very high	4
Roof/wall junctions	Roof-to-wall junctions fully protected	Low	0
	Roof-to-wall junctions partially exposed	Medium	1
	Roof-to-wall junctions fully exposed	High	3
	Roof elements finishing within the boundaries formed by the <i>external walls</i>	Very high	5
Eaves width	More than 600 mm for single <i>storey</i>	Low	0
	451-600 mm for single <i>storey</i> ; or more than 600 mm for two <i>storey</i>	Medium	1
	101-450 mm for single <i>storey</i> ; or 451-600 mm for two <i>storey</i> ; or more than 600 mm for above two <i>storey</i>	High	2
	0-100 mm for single <i>storey</i> ; or 0-450 mm for two <i>storey</i> ; or less than 600 mm for above two <i>storey</i>	Very high	5

Table FV1.1 – RISK FACTORS AND SCORES— continued

Risk factor	Category	Risk severity	Score
Envelope complexity	Simple shape with single cladding type	Low	0
	Complex shape with not more than two cladding types	Medium	1
	Complex shape with more than two cladding types	High	3
	As for high risk but with fully exposed roof-to-wall junctions	Very high	6
Decks, porches and balconies	None; or timber slat deck or porch at ground level	Low	0
	Fully covered in plan view by roof; or timber slat deck attached at first or second floor level	Medium	2
	Balcony exposed in plan view at first floor level; or balcony cantilevered at first floor level	High	4
	Balcony exposed in plan view at second floor level or above; or balcony cantilevered at second floor level or above	Very high	6

Notes:

1. Eaves width is measured horizontally from the external face of any wall cladding to the outer edge of any overhang, including fascia and external gutters.
2. Barriers to prevent falling and parapets are considered as 0 mm eaves.

(b) Test specimen

The test specimen must incorporate—

- (i) representative samples of openings and joints, including—
 - (A) vertical and horizontal control joints; and
 - (B) wall junctions; and
 - (C) *windows* or doors; and
 - (D) electrical boxes; and
 - (E) balcony drainage and parapet flashings; and
 - (F) footer and header termination systems; and
- (ii) for a *cavity wall*—
 - (A) a transparent material for a proportion of the internal wall lining (to provide an unobstructed view of the *external wall* cladding) with sufficient structural capability and similar air tightness to resist the applied wind pressures; and
 - (B) a 15 mm diameter hole in the internal wall lining below a *window*.

(c) Test procedure

- (i) The test procedure for a *direct fix cladding wall* or *unique wall* must be as follows:
 - (A) Apply 100% positive and negative serviceability wind pressures to the external face of the test specimen for a period of not less than 1 minute each.
 - (B) Apply static pressure of either 300 Pa or 30% serviceability wind pressure, whichever is higher, in accordance with the water penetration test procedure at clause 8.5.2 of AS/NZS 4284.
 - (C) Apply cyclic pressure in accordance with—
 - (aa) the three stages of **Table FV1.2**; and
 - (bb) the water penetration test procedure at clause 8.6.2 of AS/NZS 4284.

Table FV1.2

Stage number	Serviceability wind pressure
1	15% to 30%
2	20% to 40%
3	30% to 60%

- (ii) The test procedure for a *cavity wall* must be as follows:
 - (A) Apply 100% positive and negative serviceability wind pressures to the external face of the test specimen for a period of not less than 1 minute each.
 - (B) Apply static pressure of either 300 Pa or 30% serviceability wind pressure, whichever is higher, in accordance with the water penetration test procedure at clause 8.5.2 of AS/NZS 4284.
 - (C) Apply cyclic pressure in accordance with—
 - (aa) stage 3 of **Table FV1.2**; and
 - (bb) the water penetration test procedure at clause 8.6.2 of AS/NZS 4284.
 - (D) To simulate the failure of the primary weather-defence or sealing, the following procedure must be applied to the test specimen:
 - (aa) Insert 6 mm diameter holes through the external face of the *cavity wall* in all places specified below:
 - (AA) Wall/window or wall/door junctions at $\frac{3}{4}$ height.
 - (BB) Immediately above the head flashing.
 - (CC) Through external sealing of the horizontal and vertical joints.
 - (DD) Above any other penetration detail not covered by **(AA)** to **(CC)**.
 - (bb) Repeat the static and cyclic pressure tests of **(B)** and **(C)**.
 - (cc) Within 30 minutes of the completion of **(bb)**, remove the internal lining of the *cavity wall* and check for compliance with **(d)**.
 - (dd) With the internal lining removed, apply a final static pressure test at 50 Pa for a period of 15 minutes.

(d) Compliance

- (i) A *direct fix cladding wall* and *unique wall* are verified for compliance with **FP1.4** if there is no presence of water on the inside surface of the facade.
- (ii) A *cavity wall* is verified for compliance with **FP1.4** if there is no presence of water on the removed surface of the cavity, except that during the simulation of the failure of the primary weather-defence or sealing, water may—
 - (A) transfer to the removed surface of the cavity due to the introduced defects (6 mm holes); and
 - (B) contact, but not pool on, battens and other cavity surfaces.

(e) **Test report**

The test report must include the following information:

- (i) Name and address of the person supervising the test.
- (ii) Test report number.
- (iii) Date of the test.
- (iv) Cladding manufacturer's name and address.
- (v) Construction details of the test specimen, including a description, and drawings and details of the components, showing modifications, if any.
- (vi) Test sequence with the pressures used in all tests.
- (vii) For each of the static and cyclic pressure tests, full details of all leakages, including position, extent and timing.

PART F1 DAMP AND WEATHERPROOFING

Deemed-to-Satisfy Provisions

F1.0 Deemed-to-Satisfy Provisions

- (a) *Performance Requirement FP1.4*, for the prevention of the penetration of water through *external walls*, must be complied with.

There are no *Deemed-to-Satisfy Provisions* for this *Performance Requirement* in respect of *external walls*.

SA F1.0(b)

- (b) Where a *Deemed-to-Satisfy Solution* is proposed, *Performance Requirements FP1.1 to FP1.3* and *FP1.5 to FP1.7* are satisfied by complying with *F1.1 to F1.13*.
- (c) Where a *Performance Solution* is proposed, the relevant *Performance Requirements* must be determined in accordance with *A0.7*.

F1.1 Stormwater drainage

Stormwater drainage must comply with AS/NZS 3500.3.

Explanatory information: Cross-volume considerations

Part C2 of NCC Volume Three set out the requirements for overflow relief gullies.

F1.2 * * * * *

This clause has deliberately been left blank.

F1.3 * * * * *

This clause has deliberately been left blank.

F1.4 External above ground membranes

Waterproofing membranes for external above ground use must comply with AS 4654 Parts 1 and 2.

F1.5 Roof coverings

A roof must be covered with—

- (a) concrete roofing tiles complying with AS 2049 and fixed, except in cyclonic areas, in accordance with AS 2050, as appropriate; or
- (b) terracotta roofing tiles complying with AS 2049 and fixed, except in cyclonic areas, in accordance with AS 2050; or

Deemed-to-Satisfy Provisions

- (c) cellulose cement corrugated sheeting complying with AS/NZS 2908.1 and installed in accordance with AS/NZS 1562.2; or
- (d) metal sheet roofing complying with AS 1562.1; or
- (e) plastic sheet roofing designed and installed in accordance with AS/NZS 4256 Parts 1, 2, 3 and 5 and AS/NZS 1562.3; or
- (f) asphalt shingles complying with ASTM D3018-90, Class A.

F1.6 Sarking

Sarking-type materials used for weatherproofing of roofs and walls must comply with AS/NZS 4200 Parts 1 and 2.

F1.7 Waterproofing of wet areas in buildings

SA F1.7(a)

- (a) In a Class 2 and 3 building and a Class 4 part of a building, building elements in *wet areas* must—
 - (i) be *water resistant* or *waterproof* in accordance with **Table F1.7**; and
 - (ii) comply with AS 3740.
- (b) In a Class 5, 6, 7, 8 or 9 building, building elements in the bathroom or shower room, a slop hopper or sink compartment, a laundry or *sanitary compartment* must—
 - (i) be *water resistant* or *waterproof* in accordance with **Table F1.7**; and
 - (ii) comply with AS 3740,as if they were in a Class 2 or 3 building or a Class 4 part of a building.
- (c) Where a slab or stall type urinal is installed—
 - (i) the floor surface of the room containing the urinal must—
 - (A) be an impervious material; and
 - (B) where no step is installed—
 - (aa) be graded to the urinal channel for a distance of 1.5 m from the urinal channel; and
 - (bb) the remainder of the floor be graded to a floor waste; and
 - (C) where a step is installed—
 - (aa) the step must have an impervious surface and be graded to the urinal channel; and
 - (bb) the floor behind the step must be graded to a floor waste; and
 - (ii) the junction between the floor surface and the urinal channel must be impervious.
- (d) Where a wall hung urinal is installed—
 - (i) the wall must be surfaced with impervious material extending from the floor to not less than 50 mm above the top of the urinal and not less than 225 mm on each side of the urinal.
 - (ii) the floor must be surfaced with impervious material and graded to a floor waste.

Deemed-to-Satisfy Provisions

- (e) In a room with timber or steel framed walls and containing a urinal—
 - (i) the wall must be surfaced with an impervious material extending from the floor to not less than 100 mm above the floor surface; and
 - (ii) the junction of the floor surface and the wall surface must be impervious.

SA Table F1.7

Table F1.7 WATERPROOFING AND WATER-RESISTANCE REQUIREMENTS FOR BUILDING ELEMENTS IN WET AREAS

Vessels or area where the fixture is installed	Floors and horizontal surfaces	Walls	Wall junctions and joints	Wall / floor junctions	Penetrations
Shower area (enclosed and unenclosed)					
With hob	<i>Waterproof</i> floor in <i>shower area</i> (including any hob or step-down).	(a) <i>Waterproof</i> all walls in <i>shower area</i> to a height the greater of— (i) not less than 150 mm above floor substrate; or (ii) not less than 25 mm above maximum retained water level; and	<i>Waterproof</i> wall junctions within <i>shower area</i> .	<i>Waterproof</i> wall / floor junctions within <i>shower area</i> .	<i>Waterproof</i> penetrations in <i>shower area</i> .
With step-down					
Without hob or step-down		(b) <i>Water resistant</i> walls in <i>shower area</i> to not less than 1800 mm above finished floor level of the shower.			

Deemed-to-Satisfy Provisions

Table F1.7 WATERPROOFING AND WATER-RESISTANCE REQUIREMENTS FOR BUILDING ELEMENTS IN WET AREAS— continued

Vessels or area where the fixture is installed	Floors and horizontal surfaces	Walls	Wall junctions and joints	Wall / floor junctions	Penetrations
With preformed shower base	N/A	<i>Water resistant</i> walls in <i>shower area</i> to not less than 1800 mm above finished floor level of the shower.	<i>Waterproof</i> wall junctions within <i>shower area</i> .	<i>Waterproof</i> wall / floor junctions within <i>shower area</i> .	<i>Waterproof</i> penetrations in <i>shower area</i> .
Area outside shower area					
For concrete and compressed fibre-cement sheet flooring	<i>Water resistant</i> floor of the room.	N/A	N/A	<i>Waterproof</i> wall / floor junctions.	N/A
For timber floors including particleboard, plywood and other timber based flooring materials	<i>Waterproof</i> floor of the room.				

Table F1.7 WATERPROOFING AND WATER-RESISTANCE REQUIREMENTS FOR BUILDING ELEMENTS IN WET AREAS— continued

Vessels or area where the fixture is installed	Floors and horizontal surfaces	Walls	Wall junctions and joints	Wall / floor junctions	Penetrations
Areas adjacent to baths and spas					
For concrete and compressed fibre-cement sheet flooring	<i>Water resistant</i> floor of the room.	(a) <i>Water resistant</i> to a height of not less than 150 mm above the <i>vessel</i> , for the extent of the <i>vessel</i> , where the <i>vessel</i> is within 75 mm of a wall.	<i>Water resistant</i> junctions within 150 mm above a <i>vessel</i> for the extent of the <i>vessel</i> .	<i>Water resistant</i> wall / floor junctions for the extent of the <i>vessel</i> .	<i>Waterproof</i> tap and spout penetrations where they occur in horizontal surfaces.
For timber floors including particleboard, plywood and other timber based flooring materials	<i>Waterproof</i> floor of the room.	(b) <i>Water resistant</i> all exposed surfaces below <i>vessel</i> lip.			
Inserted baths and spas	(a) <i>Waterproof</i> shelf area, incorporating waterstop under the bath lip.	(a) <i>Waterproof</i> to not less than 150 mm above lip of bath or spa; and	(a) <i>Waterproof</i> junctions within 150 mm above bath or spa; and	N/A	<i>Waterproof</i> tap and spout penetrations where they occur in horizontal surfaces.
	(b) No requirement under bath.	(b) No requirement under bath.	(b) No requirement under bath.		

ARCHIVED
Deemed-to-Satisfy Provisions

Table F1.7 WATERPROOFING AND WATER-RESISTANCE REQUIREMENTS FOR BUILDING ELEMENTS IN WET AREAS— continued

Vessels or area where the fixture is installed	Floors and horizontal surfaces	Walls	Wall junctions and joints	Wall / floor junctions	Penetrations
Note: Where a shower is above a bath or spa, use requirements for shower.					
Other areas					
Walls adjoining other <i>vessel</i> (e.g. sink, basin or laundry tub)	N/A	<i>Water resistant</i> to a height of not less than 150 mm above the <i>vessel</i> , for the extent of the <i>vessel</i> , where the <i>vessel</i> is within 75 mm of a wall.	<i>Waterproof</i> wall junctions where a <i>vessel</i> is fixed to a wall.	N/A	<i>Waterproof</i> tap and spout penetrations where they occur in surfaces <i>required</i> to be <i>waterproof</i> or <i>water resistant</i> .
Laundries and WCs	<i>Water resistant</i> floor of the room.	N/A	N/A	<i>Waterproof</i> wall / floor junctions.	<i>Waterproof</i> penetrations where they occur in surfaces <i>required</i> to be <i>waterproof</i> .
Bathrooms and laundries <i>required</i> to provide a floor waste by F1.11 .	<i>Waterproof</i> floor of the room.	N/A	N/A	<i>Waterproof</i> wall / floor junctions.	<i>Waterproof</i> penetrations where they occur through the floor.
Note: N/A means not applicable.					

Deemed-to-Satisfy Provisions

F1.8 * * * * *

This clause has deliberately been left blank.

F1.9 Damp-proofing

- (a) Except for a building covered by (c), moisture from the ground must be prevented from reaching—
- (i) the lowest floor timbers and the walls above the lowest floor joists; and
 - (ii) the walls above the damp-proof course; and
 - (iii) the underside of a suspended floor constructed of a material other than timber, and the supporting beams or girders.

SA F1.9(b)

- (b) Where a damp-proof course is provided, it must consist of—
- (i) a material that complies with AS/NZS 2904; or
 - (ii) impervious sheet material in accordance with AS 3660.1.
- (c) The following buildings need not comply with (a):
- (i) A Class 7 or 8 building where in the particular case there is no necessity for compliance.
 - (ii) A garage, tool shed, *sanitary compartment*, or the like, forming part of a building used for other purposes.
 - (iii) An *open spectator stand* or *open-deck carpark*.

F1.10 Damp-proofing of floors on the ground

SA F1.10

If a floor of a room is laid on the ground or on fill, moisture from the ground must be prevented from reaching the upper surface of the floor and adjacent walls by the insertion of a vapour barrier in accordance with AS 2870, except damp-proofing need not be provided if—

- (a) weatherproofing is not *required*; or
- (b) the floor is the base of a stair, lift or similar *shaft* which is adequately drained by gravitation or mechanical means.

F1.11 Provision of floor wastes

SA F1.11

In a Class 2 or 3 building or Class 4 part of a building, a bathroom or laundry located at any level above a *sole-occupancy unit* or public space must have—

- (a) a floor waste; and
- (b) the floor graded to the floor waste to permit drainage of water.

Deemed-to-Satisfy Provisions

F1.12 Subfloor ventilation

- (a) Subfloor spaces must—
- (i) be provided with openings in *external walls* and internal subfloor walls in accordance with **Table F1.12** for the climatic zones given in **Figure F1.12**; and
 - (ii) have clearance between the ground surface and the underside of the lowest horizontal member in the subfloor in accordance with **Table F1.12**.

Table F1.12 SUBFLOOR OPENINGS AND GROUND CLEARANCE

Climatic zone (see Figure F1.12)	Minimum aggregate subfloor ventilation openings (mm ² /m of wall)		Minimum ground clearance height (mm)	
	No membrane	Ground sealed with impervious membrane	Termite inspection or management system not <i>required</i>	Termite inspection <i>required</i> ^{Note 1}
A	2000	1000	150	400
B	4000	2000	150	400
C	6000	3000	150	400

Notes:

1. 400 mm clearance *required* only where termite management systems are installed that need to be inspected (see **B1.4**).
2. On sloping sites, the 400 mm clearance *required* by (1) may be reduced to 150 mm within 2 m of *external walls*.
3. In situations where openings in *external walls* and internal subfloor walls, are not able to be provided, additional measures must be provided to ensure that the overall level of ventilation of the subfloor space is maintained. This may include measures similar to those in **F1.12(e)** i.e. providing durability class timbers, or having the ground sealed in the subfloor space with an impervious membrane.

Deemed-to-Satisfy Provisions

Figure F1.12

CLIMATIC ZONES BASED ON RELATIVE HUMIDITY

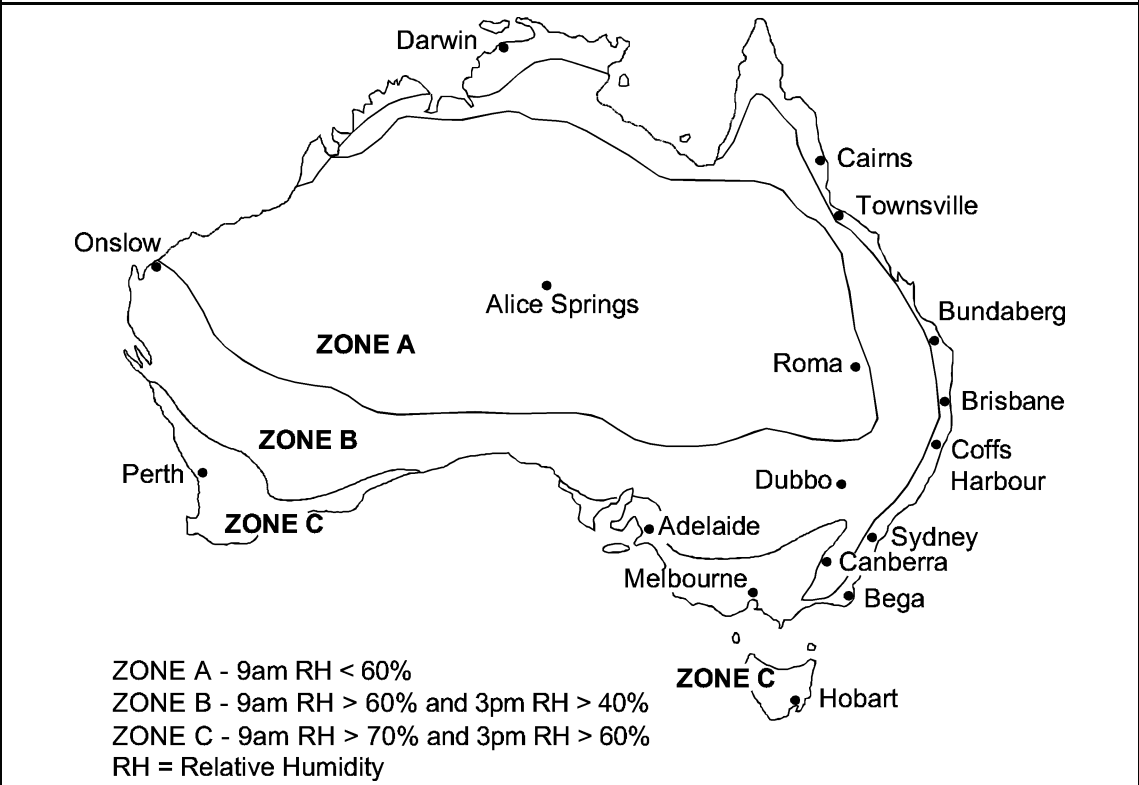

Note: The season with the highest relative humidity is used. Generally this will be July for southern Australia and January for northern Australia.

- (b) In addition to (a), a subfloor space must—
 - (i) be cleared of all building debris and vegetation; and
 - (ii) have the ground beneath the suspended floor graded to prevent *surface water* ponding under the building; and
 - (iii) contain no dead air spaces; and
 - (iv) have openings evenly spaced as far as practicable; and
 - (v) have openings placed not more than 600 mm in from corners.
- (c) In double leaf masonry walls, openings specified in (a) must be provided in both leaves of the masonry, with openings being aligned to allow an unobstructed flow of air.
- (d) Openings in internal subfloor walls specified in (a) must have an unobstructed area equivalent to that *required* for the adjacent external openings.
- (e) Where the ground or subfloor space is excessively damp or subject to frequent flooding, in addition to the requirements of (a) to (d)—
 - (i) the subfloor ventilation *required* in (a) must be increased by 50%; or

Deemed-to-Satisfy Provisions

- (ii) the ground within the subfloor space must be sealed with an impervious membrane; or
- (iii) subfloor framing must be—
 - (A) durability Class 1 or 2 timbers or H3 preservative treated timbers in accordance with AS 1684.2, AS 1684.3 or AS 1684.4; or
 - (B) steel in accordance with NASH Standard 'Residential and Low-Rise Steel Framing' Part 2.

F1.13 Glazed assemblies

- (a) Subject to (b) and (c), the following glazed assemblies in an *external wall*, must comply with AS 2047 requirements for resistance to water penetration:
 - (i) Windows.
 - (ii) Sliding and swinging glazed doors with a frame, including french and bi-fold doors with a frame.
 - (iii) Adjustable louvres.
 - (iv) Shopfronts.
 - (v) Window walls with one piece framing.
- (b) The following buildings need not comply with (a):
 - (i) A Class 7 or 8 building where in the particular case there is no necessity for compliance.
 - (ii) A garage, tool shed, *sanitary compartment*, or the like, forming part of a building used for other purposes, except where the construction of the garage, tool shed, *sanitary compartment* or the like contributes to the weatherproofing of the other part of the building.
 - (iii) An *open spectator stand* or *open-deck carpark*.
- (c) The following glazed assemblies need not comply with (a):
 - (i) All glazed assemblies not in an *external wall*.
 - (ii) Revolving doors.
 - (iii) Fixed louvres.
 - (iv) Skylights, roof lights and windows in other than the vertical plane.
 - (v) Sliding and swinging glazed doors without a frame.
 - (vi) Windows constructed on site and architectural one-off windows, which are not design tested in accordance with AS 2047.
 - (vii) Second-hand windows, re-used windows and recycled windows.
 - (viii) Heritage windows.

PART F2 SANITARY AND OTHER FACILITIES

PERFORMANCE REQUIREMENTS

FP2.1

Suitable sanitary facilities for personal hygiene must be provided in a convenient location within or associated with a building, to the degree necessary, appropriate to—

- (a) the function or use of the building; and
- (b) the number and gender of the occupants; and
- (c) the disability or other particular needs of the occupants.

FP2.2

Laundrying facilities or space for laundrying facilities and the means for the sanitary disposal of waste water must be provided in a convenient location within or associated with a building appropriate to the function or use of the building.

Vic FP2.2 Application

Application:

FP2.2 only applies to—

- (a) a Class 2 building or Class 4 part of a building; and
- (b) a Class 9a *health-care building*; and
- (c) a Class 9b *early childhood centre*; and
- (d) a Class 9c building.

FP2.3

A facility must be provided which includes—

- (a) a means for food rinsing, utensil washing and the sanitary disposal of associated waste water; and
- (b) a means for cooking food; and
- (c) a space for food preparation.

Application:

FP2.3 only applies to—

- (a) a Class 2 building or Class 4 part of a building; and
- (b) a Class 9a *health-care building*; and
- (c) a Class 9b *early childhood centre*; and
- (d) a Class 9c building.

FP2.4

Suitable means must be provided in a building containing wards or bedrooms to facilitate the emptying of sewage or dirty water from containers.

Application:

FP2.4 only applies to a Class 9a or 9c building.

FP2.5

A *sanitary compartment* must be constructed with sufficient space or other means to permit an unconscious occupant to be removed from the compartment.

FP2.6

NSW FP2.6

Hot water, warm water and cooling water systems installed in a building must control the accumulation of harmful levels of micro-organisms.

Limitation:

FP2.6 does not apply to a system serving only a single *sole-occupancy unit* in a Class 2 or 3 building or Class 4 part of a building.

PART F2 SANITARY AND OTHER FACILITIES

Deemed-to-Satisfy Provisions

F2.0 Deemed-to-Satisfy Provisions

Vic F2.0

- (a) Where a *Deemed-to-Satisfy Solution* is proposed, *Performance Requirements FP2.1 to FP2.6* are satisfied by complying with—
- (i) **F2.1 to F2.8**; and
 - (ii) for public transport buildings, **Part H2**; and
 - (iii) for *farm sheds*, **Part H3**.
- (b) Where a *Performance Solution* is proposed, the relevant *Performance Requirements* must be determined in accordance with **A0.7**.

F2.1 Facilities in residential buildings

Sanitary and other facilities for Class 2, 3 and 9c buildings and for Class 4 parts of buildings must be provided in accordance with **Table F2.1**.

Table F2.1 PROVISION OF SANITARY AND OTHER FACILITIES IN RESIDENTIAL BUILDINGS

Class 2
Within each <i>sole-occupancy unit</i> , provide—
(a) a kitchen sink and facilities for the preparation and cooking of food; and
(b) a bath or shower; and
(c) a closet pan; and
(d) a washbasin.
Laundry facilities, provide either—
(a) in each <i>sole-occupancy unit</i> —
(i) clothes washing facilities, comprising at least one washtub and space for a washing machine; and
(ii) clothes drying facilities comprising—
(A) clothes line or hoist with not less than 7.5 m of line; or
(B) space for one heat-operated drying cabinet or appliance in the same room as the clothes washing facilities; or
Note: A kitchen sink or washbasin must not be counted as a laundry washtub.
(b) a separate laundry for each 4 <i>sole-occupancy units</i> , or part thereof—
(i) clothes washing facilities comprising at least one washtub and one washing machine; and

Deemed-to-Satisfy Provisions

Table F2.1 PROVISION OF SANITARY AND OTHER FACILITIES IN RESIDENTIAL BUILDINGS— continued

- (ii) clothes drying facilities comprising—
 - (A) clothes line or hoist with not less than 7.5 m of line per *sole-occupancy unit*; or
 - (B) one heat-operated drying cabinet or appliance for each 4 *sole-occupancy units*.

Facilities for employees—

If the building contains more than 10 *sole-occupancy units*, or a group of Class 2 buildings on the one allotment contains, in total, more than 10 *sole-occupancy units* — provide a closet pan and washbasin in a compartment or room at or near ground level and accessible to employees without entering a *sole-occupancy unit*.

Note: A reference to "employees" includes owners, managers, workers and contractors.

Class 3 (other than Class 3 *residential aged care buildings*)

Facilities for residents—

For each building or group of buildings, provide—

- (a) a bath or shower; and
- (b) a closet pan; and
- (c) a washbasin,

for each 10 residents for whom private facilities are not provided, except that—

- (c) if one urinal is provided for each 25 males up to 50 and one additional urinal for each additional 50 males or part thereof,

one closet pan for each 12 males may be provided.

Facilities for employees — see **F2.3**.

Note: These facilities need not be situated within the building.

Class 3 (*residential aged care buildings*)

Facilities for residents—

For each building or group of buildings, provide—

- (a) a shower, closet pan and wash basin for each 8 residents or part thereof for whom private facilities are not provided; and
- (b) a suitable bath for each 30 residents or part thereof.

Note: Urinals must not be taken into consideration in calculating the number of facilities.

Class 4

For each *sole-occupancy unit*, provide—

- (a) a kitchen sink and facilities for the preparation and cooking of food; and
- (b) a bath or shower; and
- (c) a closet pan; and
- (d) a washbasin; and
- (e) clothes washing facilities, comprising a washtub and space in the same room for a washing machine; and

Deemed-to-Satisfy Provisions

Table F2.1 PROVISION OF SANITARY AND OTHER FACILITIES IN RESIDENTIAL BUILDINGS— continued

<p>(f) a clothes line or hoist, or space for a heat-operated drying cabinet or similar appliance for the exclusive use of the occupants.</p> <p>Note: A kitchen sink or washbasin must not be counted as a laundry washtub.</p>
Class 9c
<p>Facilities for residents—</p> <p>For each building or group of buildings, provide—</p> <p>(a) a closet pan and wash basin for each 6 residents or part thereof for whom private facilities are not provided; and</p> <p>(b) a shower for each 7 residents or part thereof for whom private facilities are not provided; and</p> <p>(c) a suitable bath, fixed or mobile.</p> <p>Other facilities, provide—</p> <p>(a) one kitchen or other adequate facility for the preparation and cooking or reheating of food including a kitchen sink and washbasin; and</p> <p>(b) laundry facilities for the cleansing and drying of linen and clothing or adequate facilities for holding and dispatch or treatment of soiled linen and clothing and the like and the receipt and storage of clean linen; and</p> <p>(c) one clinical hand washing basin for each 16 residents or part thereof.</p> <p>Note: Urinals must not be taken into consideration in calculating the number of facilities.</p>

F2.2 Calculation of number of occupants and facilities

- (a) The number of persons accommodated must be calculated according to **D1.13** if it cannot be more accurately determined by other means.
- (b) Unless the premises are used predominantly by one sex, sanitary facilities must be provided on the basis of equal numbers of males and females.
- (c) In calculating the number of sanitary facilities to be provided under **F2.1** and **F2.3**, a unisex facility *required* for people with a disability may be counted once for each sex.
- (d) For the purposes of this Part, a unisex facility comprises one closet pan, one washbasin and means for the disposal of sanitary towels.

F2.3 Facilities in Class 3 to 9 buildings

- (a) Except where permitted by (b), (c), (f), **F2.4(a)** and **F2.4(b)**, separate sanitary facilities for males and females must be provided for Class 3, 5, 6, 7, 8 or 9 buildings in accordance with **Table F2.3**.
- (b) If not more than 10 people are employed, a unisex facility may be provided instead of separate facilities for each sex.
- (c) If the majority of employees are of one sex, not more than 2 employees of the other sex may share toilet facilities if the facilities are separated by means of walls, partitions and doors to afford privacy.

Deemed-to-Satisfy Provisions

- (d) Employees and the public may share the same facilities in a Class 6 and 9b building (other than a *school* or *early childhood centre*) provided the number of facilities provided is not less than the total number of facilities *required* for employees plus those *required* for the public.
- (e) Adequate means of disposal of sanitary towels must be provided in sanitary facilities for use by females.
- (f) Separate sanitary facilities for males and females need not be provided for patients in a *ward area* of a Class 9a building.
- (g) A Class 9a *health-care building* must be provided with—
 - (i) one kitchen or other adequate facility for the preparation and cooking or reheating of food including a kitchen sink and washbasin; and
 - (ii) laundry facilities for the cleansing and drying of linen and clothing or adequate facilities for holding and dispatch or treatment of soiled linen and clothing, sanitary towels and the like and the receipt and storage of clean linen; and
 - (iii) one shower for each 8 patients or part thereof; and
 - (iv) one island-type plunge bath in each *storey* containing a *ward area*.

Vic F2.3(g) and (ga)

- (h) A Class 9b *early childhood centre* must be provided with—
 - (i) a kitchen or food preparation area with a kitchen sink, separate hand washing facilities, space for a refrigerator and space for cooking facilities, with—
 - (A) the facilities protected by a door or gate with child proof latches to prevent unsupervised access to the facilities by children younger than 5 years old; and
 - (B) the ability to facilitate supervision of children from the facilities if the *early childhood centre* accommodates children younger than 2 years old; and
 - (ii) one bath, shower or shower-bath; and
 - (iii) if the centre accommodates children younger than 3 years old—
 - (A) a laundry facility comprising a washtub and space in the same room for a washing machine; and
 - (B) a bench type baby bath, which is within 1 m of the nappy change bench; and
 - (C) a nappy changing bench which—
 - (aa) is within 1 m of separate adult hand washing facilities and bench type baby bath; and
 - (bb) must be not less than 0.9 m² in area and at a height of not less than 850 mm, but not more than 900 mm above the finished floor level; and
 - (cc) must have a space not less than 800 mm high, 500 mm wide and 800 mm deep for the storage of steps; and
 - (dd) is positioned to permit a staff member changing a nappy to have visibility of the play area at all times.
- (i) Class 9b theatres and sporting venues must be provided with one shower for each 10 participants or part thereof.

Deemed-to-Satisfy Provisions

- (j) Not less than one washbasin must be provided where closet pans or urinals are provided.

Tas Table F2.3

Vic Table F2.3

Table F2.3 SANITARY FACILITIES IN CLASS 3, 5, 6, 7, 8 OR 9 BUILDINGS

User Group	Closet Pans		Urinals		Washbasins	
	Design Occupancy	Number	Design Occupancy	Number	Design Occupancy	Number
Class 3, 5, 6 and 9 other than <i>schools</i>						
Male employees	1 — 20	1	1 — 10	0	1 — 30	1
	> 20	Add 1 per 20	11 — 25	1	> 30	Add 1 per 30
			26 — 50	2		
			>50	Add 1 per 50		
Female employees	1 — 15	1			1 — 30	1
	> 15	Add 1 per 15			> 30	Add 1 per 30
Class 7 and 8						
Male employees	1 — 20	1	1 — 10	0	1 — 20	1
	> 20	Add 1 per 20	11 — 25	1	> 20	Add 1 per 20
			26 — 50	2		
			>50	Add 1 per 50		
Female employees	1 — 15	1			1 — 20	1
	> 15	Add 1 per 15			> 20	Add 1 per 20
Note: Sanitary facilities need not be provided for a Class 8 <i>electricity network substation</i>						
Class 6 — department stores, shopping centres						
Male patrons	1 — 1200	1	1 — 600	1	1 — 600	1
	> 1200	Add 1 per 1200	>600	Add 1 per 1200	>600	Add 1 per 1200

Deemed-to-Satisfy Provisions

Table F2.3 SANITARY FACILITIES IN CLASS 3, 5, 6, 7, 8 OR 9 BUILDINGS — continued

User Group	Closet Pans		Urinals		Washbasins	
	Design Occupancy	Number	Design Occupancy	Number	Design Occupancy	Number
Female patrons	1 — 300	1			1 — 600	1
	301 — 600	2			601 — 1200	2
	>600	Add 1 per 1200			>1200	Add 1 per 1200
Note: Sanitary facilities need not be provided for patrons if the total number of persons accommodated in the building is not more than 600.						
Class 6 — restaurants, cafes, bars						
Male patrons	1 — 100	1	1 — 50	1	1 — 50	1
	101 — 300	2	51 — 100	2	51 — 200	2
	>300	Add 1 per 200	101 — 150	3	>200	Add 1 per 200
			151 — 200	4		
			201 — 250	5		
>250	Add 1 per 100					
Female patrons	1 — 25	1			1 — 50	1
	26 — 50	2			51 — 150	2
	51 — 100	3			>150	Add 1 per 200
	101 — 150	4				
	151 — 200	5				
	201 — 250	6				
	>250	Add 1 per 100				
Note: Sanitary facilities need not be provided for patrons if the total number of persons accommodated in the building is not more than 20.						

Deemed-to-Satisfy Provisions

Table F2.3 SANITARY FACILITIES IN CLASS 3, 5, 6, 7, 8 OR 9 BUILDINGS — continued

User Group	Closet Pans		Urinals		Washbasins	
	Design Occupancy	Number	Design Occupancy	Number	Design Occupancy	Number
Class 9a — health-care buildings						
Male patients	1 — 16	2			1 — 8	1
	>16	Add 1 per 8			> 8	Add 1 per 8
Female patients	1 — 16	2			1 — 8	1
	>16	Add 1 per 8			> 8	Add 1 per 8
Class 9b — schools						
Male employees	1 — 20	1	1 — 10	0	1 — 30	1
	> 20	Add 1 per 20	11 — 20	1	> 30	Add 1 per 30
			21 — 45	2		
			>45	Add 1 per 30		
Female employees	1 — 5	1			1 — 30	1
	>5	Add 1 per 15			> 30	Add 1 per 30
Male students	1 — 25	1	1 — 50	1	1 — 10	1
	26 — 75	2	51 — 100	2	11 — 50	2
	76 — 150	3	>100	Add 1 per 100	51 — 100	3
	151 — 200	4			> 100	Add 1 per 75
	> 200	Add 1 per 100				
Female students	1 — 10	1			1 — 10	1
	11 — 25	2			11 — 50	2
	26 — 100	Add 1 per 25			51 — 100	3
	> 100	Add 1 per 50			> 100	Add 1 per 75

Deemed-to-Satisfy Provisions

Table F2.3 SANITARY FACILITIES IN CLASS 3, 5, 6, 7, 8 OR 9 BUILDINGS — continued

User Group	Closet Pans		Urinals		Washbasins	
	Design Occupancy	Number	Design Occupancy	Number	Design Occupancy	Number
Class 9b — early childhood centres						
Children	1 — 30	2			1 — 30	2
	> 30	Add 1 per 15			> 30	Add 1 per 15
Note: Facilities for use by children must be— (a) junior pans; and (b) washbasins with a rim height not exceeding 600mm; and (c) accessible from both indoor and outdoor play areas.						
Class 9b — theatres and cinemas with multiple auditoria, art galleries or the like						
Male participants	1 — 20	1	1 — 10	1	1 — 10	1
	> 20	Add 1 per 20	> 10	Add 1 per 10	> 10	Add 1 per 10
Female participants	1 — 10	1			1 — 10	1
	> 10	Add 1 per 10			> 10	Add 1 per 10
Male spectators or patrons	1 — 250	1	1 — 100	1	1 — 150	1
	251 — 500	2	>100	Add 1 per 100	>150	Add 1 per 150
	>500	Add 1 per 500				
Female spectators or patrons	1 — 10	1			1 — 80	1
	11 — 50	2			81 — 250	2
	>51	Add 1 per 60			251 — 430	3
				> 430	Add 1 per 200	

Deemed-to-Satisfy Provisions

Table F2.3 SANITARY FACILITIES IN CLASS 3, 5, 6, 7, 8 OR 9 BUILDINGS — continued

User Group	Closet Pans		Urinals		Washbasins	
	Design Occupancy	Number	Design Occupancy	Number	Design Occupancy	Number
Class 9b — single auditorium theatres and cinemas						
Male patrons	1 — 50	0	1 — 50	0	1 — 50	0
	51 — 250	1	51 — 100	1	51 — 150	1
	251 — 500	2	>100	Add 1 per 100	>150	Add 1 per 150
	>500	Add 1 per 500				
Female patrons	1 — 50	0			1 — 50	0
	51 — 110	3			51 — 150	1
	111 — 170	4			>150	Add 1 per 150
	171 — 230	5				
	231 — 250	6				
	>250	Add 1 per 80				
Class 9b — sports venues or the like						
Male participants	1 — 20	1	1 — 10	1	1 — 10	1
	> 20	Add 1 per 20	> 10	Add 1 per 10	> 10	Add 1 per 10
Female participants	1 — 10	1			1 — 10	1
	> 10	Add 1 per 10			> 10	Add 1 per 10
Male spectators or patrons	1 — 250	1	1 — 100	1	1 — 150	1
	251 — 500	2	> 100	Add 1 per 100	> 150	Add 1 per 150
	> 500	Add 1 per 500				

Deemed-to-Satisfy Provisions

Table F2.3 SANITARY FACILITIES IN CLASS 3, 5, 6, 7, 8 OR 9 BUILDINGS — continued

User Group	Closet Pans		Urinals		Washbasins	
	Design Occupancy	Number	Design Occupancy	Number	Design Occupancy	Number
Female spectators or patrons	1 — 15	1			1 — 60	1
	16 — 60	2			61 — 200	2
	61 — 120	3			201 — 350	3
	> 120	Add 1 per 70			> 350	Add 1 per 150
Class 9b — churches, chapels or the like						
Male patrons	1 — 300	1	1 — 200	1	1 — 250	1
	>300	Add 1 per 500	> 200	Add 1 per 200	> 250	Add 1 per 250
Female patrons	1 — 150	1			1 — 250	1
	> 150	Add 1 per 150			> 250	Add 1 per 250
Class 9b — public halls, function rooms or the like						
Male patrons	1 — 100	1	1 — 50	1	1 — 50	1
	>100	Add 1 per 200	51 — 100	2	51 — 200	2
			101 — 150	3	>200	Add 1 per 200
			151 — 200	4		
			201 — 250	5		
			>250	Add 1 per 100		

Deemed-to-Satisfy Provisions

Table F2.3 SANITARY FACILITIES IN CLASS 3, 5, 6, 7, 8 OR 9 BUILDINGS — continued

User Group	Closet Pans		Urinals		Washbasins	
	Design Occupancy	Number	Design Occupancy	Number	Design Occupancy	Number
Female patrons	1 — 25	1			1 — 50	1
	26 — 50	2			51 — 150	2
	51 — 100	3			>150	Add 1 per 200
	101 — 150	4				
	151 — 200	5				
	201 — 250	6				
	>250	Add 1 per 100				

Note: Sanitary facilities need not be provided for patrons if the total number of persons accommodated in the building is not more than 20.

Notes:

1. Number — means the number of facilities *required*.
2. > — means greater than
3. Employees — a reference to employees includes owners and managers using the building.
4. A reference to "add 1 per 100 or 150, 250, 500" etc. includes any part of that number.

Deemed-to-Satisfy Provisions

F2.4 Accessible sanitary facilities

In a building *required* to be *accessible*—

SA F2.4(a)

- (a) *accessible* unisex *sanitary compartments* must be provided in *accessible* parts of the building in accordance with **Table F2.4(a)**; and

SA F2.4(b)

- (b) *accessible* unisex showers must be provided in accordance with **Table F2.4(b)**; and
- (c) at each bank of toilets where there is one or more toilets in addition to an *accessible* unisex *sanitary compartment* at that bank of toilets, a *sanitary compartment* suitable for a person with an ambulant disability in accordance with AS 1428.1 must be provided for use by males and females; and
- (d) an *accessible* unisex *sanitary compartment* must contain a closet pan, washbasin, shelf or bench top and adequate means of disposal of sanitary towels; and
- (e) the circulation spaces, fixtures and fittings of all *accessible* sanitary facilities provided in accordance with **Table F2.4(a)** and **Table F2.4(b)** must comply with the requirements of AS 1428.1; and
- (f) an *accessible* unisex sanitary facility must be located so that it can be entered without crossing an area reserved for one sex only; and
- (g) where two or more of each type of *accessible* unisex sanitary facility are provided, the number of left and right handed mirror image facilities must be provided as evenly as possible; and
- (h) where male sanitary facilities are provided at a separate location to female sanitary facilities, *accessible* unisex sanitary facilities are only *required* at one of those locations; and
- (i) an *accessible* unisex *sanitary compartment* or an *accessible* unisex shower need not be provided on a *storey* or level that is not *required* by **D3.3(f)** to be provided with a passenger lift or ramp complying with AS 1428.1.

Table F2.4(a) ACCESSIBLE UNISEX SANITARY COMPARTMENTS

Class of building	Minimum accessible unisex sanitary compartments to be provided
Class 1b	<ul style="list-style-type: none"> (a) Not less than 1; and (b) where private <i>accessible</i> unisex <i>sanitary compartments</i> are provided for every <i>accessible</i> bedroom, common <i>accessible</i> unisex <i>sanitary compartments</i> need not be provided.
Class 2	Where <i>sanitary compartments</i> are provided in common areas, not less than 1.

Deemed-to-Satisfy Provisions

Table F2.4(a) ACCESSIBLE UNISEX SANITARY COMPARTMENTS — *continued*

Class of building	Minimum accessible unisex sanitary compartments to be provided
Class 3 and Class 9c	<p>(a) In every <i>accessible sole-occupancy unit</i> provided with <i>sanitary compartments</i> within the <i>accessible sole-occupancy unit</i>, not less than 1; and</p> <p>(b) at each bank of <i>sanitary compartments</i> containing male and female <i>sanitary compartments</i> provided in common areas, not less than 1.</p>
Class 5, 6, 7, 8 or 9 — except for within a <i>ward area</i> of a Class 9a <i>health-care building</i>	<p>Where F2.3 requires closet pans—</p> <p>(a) 1 on every <i>storey</i> containing <i>sanitary compartments</i>; and</p> <p>(b) where a <i>storey</i> has more than 1 bank of <i>sanitary compartments</i> containing male and female <i>sanitary compartments</i>, at not less than 50% of those banks.</p>
<p>Class 10a except—</p> <p>(a) a Class 10a appurtenant to another Class of building; and</p> <p>(b) a <i>sanitary compartments</i> dedicated to a single caravan/camping site</p>	<p>At each bank of <i>sanitary compartments</i> containing male and female <i>sanitary compartments</i>, not less than 1.</p>

SA Table F2.4(a)(i)

Table F2.4(b) ACCESSIBLE UNISEX SHOWERS

Class of building	Minimum accessible unisex showers to be provided
Class 1b	<p>(a) Not less than 1; and</p> <p>(b) where private <i>accessible</i> unisex showers are provided for every <i>accessible</i> bedroom, common <i>accessible</i> unisex showers need not be provided.</p>
Class 2	<p>Where showers are provided in common areas, not less than 1</p>
Class 3 and Class 9c	<p>(a) In every <i>accessible sole-occupancy unit</i> provided with showers within the <i>accessible sole-occupancy unit</i>, not less than 1; and</p> <p>(b) 1 for every 10 showers or part thereof provided in common areas.</p>
Class 5, 6, 7, 8 or 9 — except for within a <i>ward area</i> of a Class 9a <i>health-care building</i>	<p>Where F2.3 requires 1 or more showers, not less than 1 for every 10 showers or part thereof.</p>

Deemed-to-Satisfy Provisions

Table F2.4(b) ACCESSIBLE UNISEX SHOWERS — continued

Class of building	Minimum accessible unisex showers to be provided
Class 10a except— (a) a Class 10a appurtenant to another Class of building; and (b) a <i>sanitary compartment</i> dedicated to a single caravan/camping site	Where showers are provided, 1 for every 10 showers or part thereof.

SA Table F2.4(b)(i)

F2.5 Construction of sanitary compartments

- (a) Other than in an *early childhood centre*, *sanitary compartments* must have doors and partitions that separate adjacent compartments and extend—
 - (i) from floor level to the ceiling in the case of a unisex facility; or
 - (ii) to a height of not less than 1.5 m above the floor if primary *school* children are the principal users; or
 - (iii) 1.8 m above the floor in all other cases.
- (b) The door to a fully enclosed *sanitary compartment* must—
 - (i) open outwards; or
 - (ii) slide; or
 - (iii) be readily removable from the outside of the *sanitary compartment*,
 unless there is a clear space of at least 1.2 m, measured in accordance with **Figure F2.5**, between the closet pan within the *sanitary compartment* and the doorway.

Vic F2.5(c)

- (c) In an *early childhood centre*, facilities for use by children must have each *sanitary compartment* screened by a partition which, except for the doorway, is opaque for a height of at least 900 mm but not more than 1200 mm above the floor level.

Deemed-to-Satisfy Provisions

Figure F2.5

CONSTRUCTION OF SANITARY COMPARTMENTS

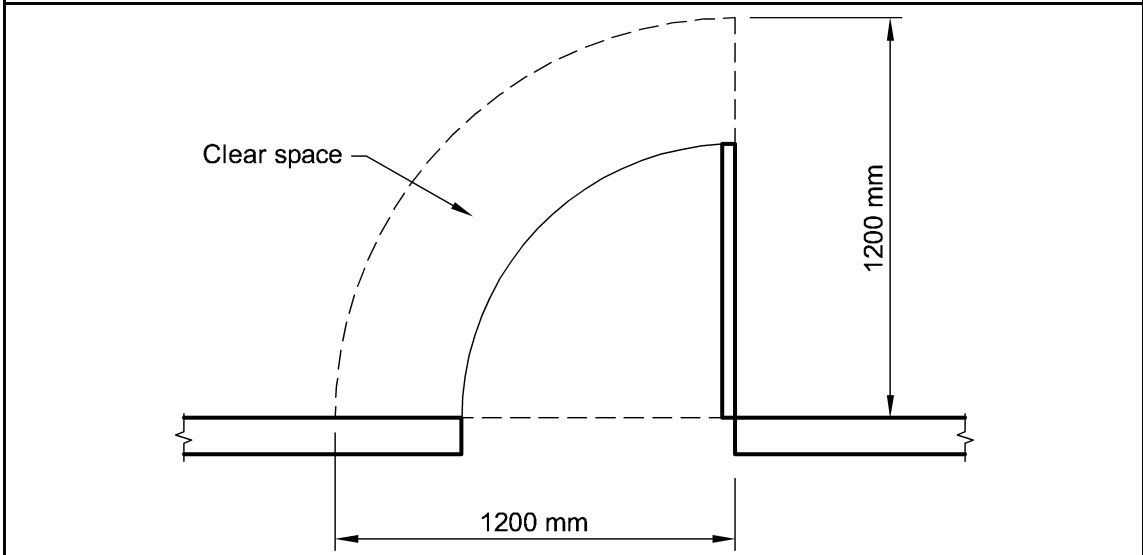

F2.6 Interpretation: Urinals and washbasins

- (a) A urinal may be—
 - (i) an individual stall or wall-hung urinal; or
 - (ii) each 600 mm length of a continuous urinal trough; or
 - (iii) a closet pan used in place of a urinal.
- (b) A washbasin may be—
 - (i) an individual basin; or
 - (ii) a part of a hand washing trough served by a single water tap.

F2.7 Microbial (legionella) control

NSW F2.7

Hot water, warm water and cooling water systems in a building other than a system serving only a single *sole-occupancy unit* in a Class 2 or 3 building or Class 4 part of a building must be installed in accordance with AS/NZS 3666.1.

F2.8 Waste management

- (a) In a Class 9a *health-care building*, at least one slop-hopper or other device, other than a water closet pan or urinal, must be provided—
 - (i) on any *storey* containing *ward areas* or bedrooms to facilitate emptying of containers of sewage or dirty water; and
 - (ii) with a flushing apparatus, tap and grating.

Deemed-to-Satisfy Provisions

- (b) In a Class 9c building, the following facilities must be provided for every 60 beds or part thereof on each storey containing *resident use areas*—
- (i) one slop-hopper or other device other than a water closet pan or urinal for the safe handling and disposal of liquid and solid wastes with a flushing apparatus, tap and grating; and
 - (ii) an appliance for the disinfection of pans or an adequate means to dispose of receptacles.

Tas F2.101, F2.102

Vic F2.101

Explanatory information: Cross-volume considerations

NCC Volume Three contains a number of plumbing and drainage provisions which are relevant to facilities. These include, but may not be limited to, the following:

Access for maintenance of plumbing and drainage	Parts B1, B2, B3, C1, C2, E1, F1 and F2
Heated water temperature control for facilities used for personal hygiene	Part B2

PART **F3** ROOM HEIGHTS

PERFORMANCE REQUIREMENTS

FP3.1

Vic FP3.1

A *habitable room* or space must have sufficient height that does not unduly interfere with its intended function.

PART F3 ROOM HEIGHTS

Deemed-to-Satisfy Provisions

F3.0 Deemed-to-Satisfy Provisions

Vic F3.0

- (a) Where a *Deemed-to-Satisfy Solution* is proposed, *Performance Requirement FP3.1* is satisfied by complying with—
 - (i) **F3.1**; and
 - (ii) for *farm sheds*, **Part H3**.
- (b) Where a *Performance Solution* is proposed, the relevant *Performance Requirements* must be determined in accordance with **A0.7**.

F3.1 Height of rooms and other spaces

The height of rooms and other spaces must be not less than—

- (a) in a Class 2 or 3 building or Class 4 part of a building—
 - (i) a kitchen, laundry, or the like — 2.1 m; and
 - (ii) a corridor, passageway or the like — 2.1 m; and
 - (iii) a *habitable room* excluding a kitchen — 2.4 m; and
 - (iv) in a room or space with a sloping ceiling or projections below the ceiling line within—
 - (A) a *habitable room*—
 - (aa) in an attic — a height of not less than 2.2 m for not less than two-thirds of the *floor area* of the room or space; and
 - (bb) in other rooms — a height of not less than 2.4 m for not less than two-thirds of the *floor area* of the room or space; and
 - (B) a non-*habitable room* — a height of not less than 2.1 m for not less than two-thirds of the *floor area* of the room or space; and
- when calculating the *floor area* of a room or space, any part that has a ceiling height of less than 1.5 m is not included; and
- (b) in a Class 5, 6, 7 or 8 building—
 - (i) except as allowed in **(ii)** and **(f)** — 2.4 m; and
 - (ii) a corridor, passageway, or the like — 2.1 m; and
- (c) in a Class 9a *health-care building*—
 - (i) a *patient care area* — 2.4 m; and
 - (ii) an operating theatre or delivery room — 3 m; and
 - (iii) a treatment room, clinic, waiting room, passageway, corridor, or the like — 2.4 m; and

Deemed-to-Satisfy Provisions

- (d) in a Class 9b building—
 - (i) a *school* classroom or other *assembly building* or part that accommodates not more than 100 persons — 2.4 m; and
 - (ii) a theatre, public hall or other *assembly building* or part that accommodates more than 100 persons — 2.7 m; and
 - (iii) a corridor—
 - (A) that serves an *assembly building* or part that accommodates not more than 100 persons — 2.4 m; or
 - (B) that serves an *assembly building* or part that accommodates more than 100 persons — 2.7 m; and
 - (iv) the number of persons accommodated must be calculated according to **D1.13**; and
- (e) in a Class 9c building—
 - (i) a kitchen, laundry, or the like — 2.1 m; and
 - (ii) a corridor, passageway or the like — 2.4 m; and
 - (iii) a *habitable room* excluding a kitchen — 2.4 m; and
- (f) in any building—
 - (i) a bathroom, shower room, *sanitary compartment*, airlock, tea preparation room, pantry, store room, garage, car parking area, or the like — 2.1 m; and
 - (ii) a commercial kitchen — 2.4 m; and
 - (iii) above a stairway, ramp, landing or the like — 2 m measured vertically above the nosing line of stairway treads or the floor surface of the ramp, landing or the like.

Vic F3.101 — F3.103

PART F4 LIGHT AND VENTILATION

PERFORMANCE REQUIREMENTS

FP4.1

Sufficient openings must be provided and distributed in a building so that natural light, when available, provides a level of *illuminance* appropriate to the function or use of that part of the building.

FP4.2

Artificial lighting must be installed to provide a level of *illuminance* appropriate to the function or use of the building to enable safe movement by occupants.

FP4.3

A space in a building used by occupants must be provided with means of ventilation with *outdoor air* which will maintain adequate air quality.

FP4.4

A mechanical air-handling system installed in a building must control—

- (a) the circulation of objectionable odours; and
- (b) the accumulation of harmful contamination by micro-organisms, pathogens and toxins.

FP4.5

Contaminated air must be disposed of in a manner which does not unduly create a nuisance or hazard to people in the building or *other property*.

VERIFICATION METHODS

FV4.1 Verification of suitable indoor air quality

For a Class 2, 3, 5, 6, 9b or 9c building or Class 4 part of a building, compliance with **FP4.3** and **FP4.4(a)** is verified when it is determined that the building under typical conditions in use is provided with sufficient ventilation with *outdoor air* such that contaminant levels do not exceed the limits specified in **Table FV4.1**.

Table FV4.1 MAXIMUM CONTAMINANT LIMITS FOR ACCEPTABLE INDOOR AIR QUALITY

Pollutant	Averaging time	Maximum air quality value
Carbon dioxide, CO ₂	8 hours	850 ppm ^{Note 1}

Table FV4.1 MAXIMUM CONTAMINANT LIMITS FOR ACCEPTABLE INDOOR AIR QUALITY— continued

Pollutant	Averaging time	Maximum air quality value
Carbon monoxide, CO	15 minutes	90 ppm
	30 minutes	50 ppm
	1 hour	25 ppm
	8 hours	10 ppm
Formaldehyde, CH ₂ O	30 minutes	0.1 mg/m ³
Nitrogen dioxide, NO ₂	1 year	40 µg/m ³ (0.0197 ppm) ^{Note 2}
	1 hour	200 µg/m ³ (0.0987 ppm)
Ozone, O ₃	8 hour, daily maximum	100 µg/m ³ (0.0473 ppm)
Particulate matter, PM	1 year	10 µg/m ³
PM _{2.5}	1 year	20 µg/m ³
PM ₁₀	1 year	20 µg/m ³
Total volatile organic compounds	1 hour	500 µg/m ³
Notes:		
1. Based on body odour metric (i.e. 450 ppm above ambient CO ₂ level of 400 ppm and demand control ventilation provisions in AS 1668.2).		
2. Based on pressure of 101.325 kPa and temperature of 25°C (i.e. the conversion is mg/m ³ = ppm (molecular weight/24.4)).		

FV4.2 Verification of suitable indoor air quality for carparks

For a Class 7a building, compliance with **FP4.3** and **FP4.4(a)** is verified when it is determined that the building is provided with sufficient ventilation with *outdoor air* such that carbon monoxide exposure levels do not exceed the limits specified in **Table FV4.2**.

Table FV4.2 MAXIMUM CARBON MONOXIDE EXPOSURE FOR CARPARKS

Concentration, ppm	Total exposure duration per day
100	Not to be exceeded
90	15 minutes
60	1 hour
30	8 hours
Note: Various government work, health and safety regulations specify workplace exposure limits for airborne contaminants in the workplace.	

PART F4 LIGHT AND VENTILATION

Deemed-to-Satisfy Provisions

F4.0 Deemed-to-Satisfy Provisions

- (a) Where a *Deemed-to-Satisfy Solution* is proposed, *Performance Requirements FP4.1* to *FP4.5* are satisfied by complying with—
- (i) **F4.1** to **F4.12**; and
 - (ii) for *farm buildings* and *farm sheds*, **Part H3**.
- (b) Where a *Performance Solution* is proposed, the relevant *Performance Requirements* must be determined in accordance with **A0.7**.

F4.1 Provision of natural light

Natural light must be provided in:

- (a) **Class 2 buildings and Class 4 parts of buildings** — to all *habitable rooms*.
- (b) **Class 3 buildings** — to all bedrooms and dormitories.
- (c) **Class 9a and 9c buildings** — to all rooms used for sleeping purposes.

Vic F4.1(d)

- (d) **Class 9b buildings** — to all general purpose classrooms in primary or secondary *schools* and all playrooms or the like for the use of children in an *early childhood centre*.

F4.2 Methods and extent of natural light

- (a) *Required* natural light must be provided by—
- (i) *windows*, excluding *roof lights*, that—
 - (A) have an aggregate light transmitting area measured exclusive of framing members, glazing bars or other obstructions of not less than 10% of the *floor area* of the room; and
 - (B) are open to the sky or face a court or other space open to the sky or an open verandah, carport or the like; or
 - (ii) *roof lights*, that—
 - (A) have an aggregate light transmitting area measured exclusive of framing members, glazing bars or other obstructions of not less than 3% of the *floor area* of the room; and
 - (B) are open to the sky; or
 - (iii) a proportional combination of *windows* and *roof lights required* by (i) and (ii).

Vic F4.2(b)

- (b) Except in a Class 9c building, in a Class 2, 3 or 9 building or Class 4 part of a building a *required window* that faces a boundary of an adjoining allotment or a wall of the same building or another building on the allotment must not be less than a horizontal distance from that boundary or wall that is the greater of—

Deemed-to-Satisfy Provisions

- (i) generally — 1 m; and
- (ii) in a *patient care area* or other room used for sleeping purposes in a Class 9a building — 3 m; and
- (iii) 50% of the square root of the exterior height of the wall in which the *window* is located, measured in metres from its sill.

Vic F4.2(c)

- (c) In a Class 9c building, a *required window* must be transparent and located—
 - (i) in an *external wall* with the *window* sill not more than 1 m above the floor level; and
 - (ii) where the *window* faces an adjoining allotment, another building or another wall of the same building, it must not be less than a horizontal distance of 3 m from the adjoining allotment, other building or wall.

Vic F4.2(d)

- (d) In a Class 9b *early childhood centre*, the sills of 50% of *windows* in children's rooms must be located not more than 500 mm above the floor level.

F4.3 Natural light borrowed from adjoining room

- (a) Natural light to a room in a Class 2 building or Class 4 part of a building or in a *sole-occupancy unit* of a Class 3 building, may come through one or more glazed panels or openings from an adjoining room (including an enclosed verandah) if—
 - (i) both rooms are within the same *sole-occupancy unit* or the enclosed verandah is on common property; and
 - (ii) the glazed panels or openings have an aggregate light transmitting area of not less than 10% of the *floor area* of the room to which it provides light; and
 - (iii) the adjoining room has—
 - (A) *windows*, excluding *roof lights*, that—
 - (aa) have an aggregate light transmitting area of not less than 10% of the combined *floor areas* of both rooms; and
 - (bb) are open to the sky or face a court or other space open to the sky or an open verandah, carport or the like; or
 - (B) *roof lights*, that—
 - (aa) have an aggregate light transmitting area of not less than 3% of the combined *floor areas* of both rooms; and
 - (bb) are open to the sky; or
 - (C) a proportional combination of *windows* and *roof lights required* by (A) and (B).
- (b) The areas specified in (a)(ii) and (a)(iii) may be reduced as appropriate if direct natural light is provided from another source.

F4.4 Artificial lighting

- (a) Artificial lighting must be provided—
 - (i) in *required* stairways, passageways, and ramps; and

Deemed-to-Satisfy Provisions

- (ii) if natural light of a standard equivalent to that *required* by **F4.2** is not available, and the periods of occupation or use of the room or space will create undue hazard to occupants seeking egress in an emergency, in—
 - (A) Class 4 parts of a building — to *sanitary compartments*, bathrooms, shower rooms, airlocks and laundries; and
 - (B) Class 2 buildings — to *sanitary compartments*, bathrooms, shower rooms, airlocks, laundries, common stairways and other spaces used in common by the occupants of the building; and
 - (C) Class 3, 5, 6, 7, 8 and 9 buildings — to all rooms that are frequently occupied, all spaces *required* to be *accessible*, all corridors, lobbies, internal stairways, other circulation spaces and paths of egress.
- (b) The artificial lighting system must comply with AS/NZS 1680.0.
- (c) The system may provide a lesser level of illumination to the following spaces during times when the level of lighting would be inappropriate for the use:
 - (i) A theatre, cinema or the like, when performances are in progress, with the exception of aisle lighting *required* by **Part H1**.
 - (ii) A museum, gallery or the like, where sensitive displays require low lighting levels.
 - (iii) A discotheque, nightclub or the like, where to create an ambience and character for the space, low lighting levels are used.

F4.5 Ventilation of rooms

A *habitable room*, office, shop, factory, workroom, *sanitary compartment*, bathroom, shower room, laundry and any other room occupied by a person for any purpose must have—

- (a) natural ventilation complying with **F4.6**; or

NSW F4.5(b)

- (b) a mechanical ventilation or air-conditioning system complying with AS 1668.2 and AS/NZS 3666.1.

F4.6 Natural ventilation

- (a) Natural ventilation provided in accordance with **F4.5(a)** must consist of openings, *windows*, doors or other devices which can be opened—
 - (i) with a ventilating area not less than 5% of the *floor area* of the room *required* to be ventilated; and
 - (ii) open to—
 - (A) a suitably sized court, or space open to the sky; or
 - (B) an open verandah, carport, or the like; or
 - (C) an adjoining room in accordance with **F4.7**.
- (b) The requirements of **(a)(i)** do not apply to a Class 8 *electricity network substation*.

Deemed-to-Satisfy Provisions

F4.7 Ventilation borrowed from adjoining room

Natural ventilation to a room may come through a *window*, opening, door or other device from an adjoining room (including an enclosed verandah) if both rooms are within the same *sole-occupancy unit* or the enclosed verandah is common property, and—

- (a) in a Class 2 building, a *sole-occupancy unit* of a Class 3 building or Class 4 part of a building—
 - (i) the room to be ventilated is not a *sanitary compartment*; and
 - (ii) the *window*, opening, door or other device has a ventilating area of not less than 5% of the *floor area* of the room to be ventilated; and
 - (iii) the adjoining room has a *window*, opening, door or other device with a ventilating area of not less than 5% of the combined *floor areas* of both rooms; and
- (b) in a Class 5, 6, 7, 8 (except a Class 8 *electricity network substation*) or 9 building—
 - (i) the *window*, opening, door or other device has a ventilating area of not less than 10% of the *floor area* of the room to be ventilated, measured not more than 3.6 m above the floor; and
 - (ii) the adjoining room has a *window*, opening, door or other device with a ventilating area of not less than 10% of the combined *floor areas* of both rooms; and
- (c) the ventilating areas specified in (a) and (b) may be reduced as appropriate if direct natural ventilation is provided from another source.

F4.8 Restriction on location of sanitary compartments

Sanitary compartments must not open directly into—

- (a) a kitchen or pantry; or
- (b) a public dining room or restaurant; or
- (c) a dormitory in a Class 3 building; or
- (d) a room used for public assembly (which is not an *early childhood centre*, primary *school* or *open spectator stand*); or
- (e) a workplace normally occupied by more than one person.

F4.9 Airlocks

If a *sanitary compartment* is prohibited under F4.8 from opening directly to another room—

- (a) in a *sole-occupancy unit* in a Class 2 or 3 building or Class 4 part of a building—
 - (i) access must be by an airlock, hallway or other room; or
 - (ii) the *sanitary compartment* must be provided with mechanical exhaust ventilation; and
- (b) in a Class 5, 6, 7, 8 or 9 building (which is not an *early childhood centre*, primary *school* or *open spectator stand*)—
 - (i) access must be by an airlock, hallway or other room with a *floor area* of not less than 1.1 m² and fitted with *self-closing* doors at all access doorways; or

Deemed-to-Satisfy Provisions

- (ii) the *sanitary compartment* must be provided with mechanical exhaust ventilation and the doorway to the room adequately screened from view.

F4.10 * * * * *

This clause has deliberately been left blank.

F4.11 Carparks

Every *storey* of a *carpark*, except an *open-deck carpark*, must have—

- (a) a system of mechanical ventilation complying with AS 1668.2; or
- (b) a system of natural ventilation complying with Section 4 of AS 1668.4.

F4.12 Kitchen local exhaust ventilation

A commercial kitchen must be provided with a kitchen exhaust hood complying with AS/NZS 1668.1 and AS 1668.2 where—

- (a) any cooking apparatus has—
 - (i) a total maximum electrical power input exceeding 8 kW; or
 - (ii) a total gas power input exceeding 29 MJ/h; or
- (b) the total maximum power input to more than one apparatus exceeds—
 - (i) 0.5 kW electrical power; or
 - (ii) 1.8 MJ gas,per m² of *floor area* of the room or enclosure.

PART F5 SOUND TRANSMISSION AND INSULATION

NT Part F5

PERFORMANCE REQUIREMENTS

FP5.1

Floors separating—

- (a) *sole-occupancy units*; or
- (b) a *sole-occupancy unit* from a plant room, lift *shaft*, stairway, *public corridor*, public lobby, or the like, or a part of a different classification,

must provide insulation against the transmission of airborne and impact generated sound sufficient to prevent illness or loss of amenity to the occupants.

Application:

FP5.1 only applies to a Class 2 or 3 building.

FP5.2

Walls separating *sole-occupancy units* or a *sole-occupancy unit* from a plant room, lift *shaft*, stairway, *public corridor*, public lobby, or the like, or parts of a different classification, must provide insulation against the transmission of—

- (a) airborne sound; and
- (b) impact generated sound, if the wall is separating a bathroom, *sanitary compartment*, laundry or kitchen in one *sole-occupancy unit* from a *habitable room* (other than a kitchen) in an adjoining unit,

sufficient to prevent illness or loss of amenity to the occupants.

Application:

FP5.2 only applies to a Class 2 or 3 building.

FP5.3

The *required* sound insulation of a floor or a wall must not be compromised by—

- (a) the incorporation or penetration of a pipe or other service element; or
- (b) a door assembly.

Application:

FP5.3 only applies to a Class 2 or 3 building.

FP5.4

Floors separating *sole-occupancy units* must provide insulation against the transmission of airborne and impact generated sound sufficient to prevent illness or loss of amenity to the occupants.

Application:

FP5.4 only applies to a Class 9c building.

FP5.5

Walls separating *sole-occupancy units*, or a *sole-occupancy unit* from a kitchen, bathroom, *sanitary compartment* (not being an associated ensuite), laundry, plant room or utilities room, must provide insulation against the transmission of—

- (a) airborne sound; and
- (b) impact generated sound, if the wall separates a *sole-occupancy unit* from a kitchen or laundry,

sufficient to prevent illness or loss of amenity to the occupants.

Application:

FP5.5 only applies to a Class 9c building.

FP5.6

The *required* sound insulation of a floor or a wall must not be compromised by the incorporation or penetration of a pipe or other service element.

Application:

FP5.6 only applies to a Class 9c building.

VERIFICATION METHODS

FV5.1

Compliance with **FP5.1** and **FP5.3** to avoid the transmission of airborne and impact generated sound through floors is verified when it is measured in-situ that the separating floor has—

- (a) airborne: a weighted standardised level difference with spectrum adaptation term ($D_{nT,w} + C_{tr}$) not less than 45 when determined under AS/NZS 1276.1 or ISO 717.1; and
- (b) impact: a weighted standardised impact sound pressure level with ($L_{nT,w}$) not more than 62 when determined under AS ISO 717.2.

FV5.2

Compliance with **FP5.2(a)** and **FP5.3** to avoid the transmission of airborne sound through walls is verified when it is measured in-situ that—

- (a) a wall separating *sole-occupancy units* has a weighted standardised level difference with spectrum adaptation term ($D_{nT,w} + C_{tr}$) not less than 45 when determined under AS/NZS 1276.1 or ISO 717.1; or
- (b) a wall separating a *sole-occupancy unit* from a plant room, lift *shaft*, stairway, *public corridor*, public lobby, or the like, or parts of a different classification, has a weighted standardised level difference ($D_{nT,w}$) not less than 45 when determined under AS/NZS 1276.1 or ISO 717.1; or
- (c) any door assembly located in a wall that separates a *sole-occupancy unit* from a stairway, public corridor, public lobby, or the like, has a weighted standardised level difference ($D_{nT,w}$) not less than 25 when determined under AS/NZS 1276.1 or ISO 717.1.

PART F5

SOUND TRANSMISSION AND INSULATION

Deemed-to-Satisfy Provisions

NT Part F5

F5.0 Deemed-to-Satisfy Provisions

- (a) Where a *Deemed-to-Satisfy Solution* is proposed, *Performance Requirements FP5.1 to FP5.6* are satisfied by complying with **F5.1** to **F5.7**.
- (b) Where a *Performance Solution* is proposed, the relevant *Performance Requirements* must be determined in accordance with **A0.7**.

F5.1 Application of Part

The *Deemed-to-Satisfy Provisions* of this Part apply to Class 2 and 3 buildings and Class 9c buildings.

F5.2 Determination of airborne sound insulation ratings

A form of construction *required* to have an airborne sound insulation rating must—

- (a) have the *required* value for weighted sound reduction index (R_w) or weighted sound reduction index with spectrum adaptation term ($R_w + C_{tr}$) determined in accordance with AS/NZS 1276.1 or ISO 717.1 using results from laboratory measurements; or
- (b) comply with **Specification F5.2**.

F5.3 Determination of impact sound insulation ratings

(a) A floor in a building *required* to have an impact sound insulation rating must—

- (i) have the *required* value for weighted normalised impact sound pressure level ($L_{n,w}$) determined in accordance with AS ISO 717.2 using results from laboratory measurements; or
- (ii) comply with **Specification F5.2**.

(b) A wall in a building *required* to have an impact sound insulation rating must—

- (i) for a Class 2 or 3 building be of discontinuous construction; and
- (ii) for a Class 9c building, must—
 - (A) for other than masonry, be two or more separate leaves without rigid mechanical connection except at the periphery; or
 - (B) be identical with a prototype that is no less resistant to the transmission of impact sound when tested in accordance with **Specification F5.5** than a wall listed in Table 2 of **Specification F5.2**.

(c) For the purposes of this Part, discontinuous construction means a wall having a minimum 20 mm cavity between 2 separate leaves, and

- (i) for masonry, where wall ties are required to connect leaves, the ties are of the resilient type; and

Deemed-to-Satisfy Provisions

- (ii) for other than masonry, there is no mechanical linkage between leaves except at the periphery.

F5.4 Sound insulation rating of floors

- (a) A floor in a Class 2 or 3 building must have an $R_w + C_{tr}$ (airborne) not less than 50 and an $L_{n,w}$ (impact) not more than 62 if it separates—
 - (i) *sole-occupancy units*; or
 - (ii) a *sole-occupancy unit* from a plant room, lift *shaft*, stairway, *public corridor*, public lobby or the like, or parts of a different classification.
- (b) A floor in a Class 9c building separating *sole-occupancy units* must have an R_w not less than 45.

F5.5 Sound insulation rating of walls

- (a) A wall in a Class 2 or 3 building must—
 - (i) have an $R_w + C_{tr}$ (airborne) not less than 50, if it separates *sole-occupancy units*; and
 - (ii) have an R_w (airborne) not less than 50, if it separates a *sole-occupancy unit* from a plant room, lift *shaft*, stairway, *public corridor*, public lobby or the like, or parts of a different classification; and
 - (iii) comply with **F5.3(b)** if it separates—
 - (A) a bathroom, *sanitary compartment*, laundry or kitchen in one *sole-occupancy unit* from a *habitable room* (other than a kitchen) in an adjoining unit; or
 - (B) a *sole-occupancy unit* from a plant room or lift *shaft*.
- (b) A door may be incorporated in a wall in a Class 2 or 3 building that separates a *sole-occupancy unit* from a stairway, *public corridor*, public lobby or the like, provided the door assembly has an R_w not less than 30.
- (c) A wall in a Class 9c building must have an R_w not less than 45 if it separates—
 - (i) *sole-occupancy units*; or
 - (ii) a *sole-occupancy unit* from a kitchen, bathroom, *sanitary compartment* (not being an associated ensuite), laundry, plant room or utilities room.
- (d) In addition to (c), a wall separating a *sole-occupancy unit* in a Class 9c building from a kitchen or laundry must comply with **F5.3(b)**.
- (e) Where a wall *required* to have sound insulation has a floor above, the wall must continue to—
 - (i) the underside of the floor above; or
 - (ii) a ceiling that provides the sound insulation *required* for the wall.
- (f) Where a wall *required* to have sound insulation has a roof above, the wall must continue to—
 - (i) the underside of the roof above; or
 - (ii) a ceiling that provides the sound insulation *required* for the wall.

Deemed-to-Satisfy Provisions

F5.6 Sound insulation rating of internal services

- (a) If a duct, soil, waste or water supply pipe, including a duct or pipe that is located in a wall or floor cavity, serves or passes through more than one *sole-occupancy unit*, the duct or pipe must be separated from the rooms of any *sole-occupancy unit* by construction with an $R_w + C_{tr}$ (airborne) not less than—
 - (i) 40 if the adjacent room is a *habitable room* (other than a kitchen); or
 - (ii) 25 if the adjacent room is a kitchen or non-*habitable room*.
- (b) If a storm water pipe passes through a *sole-occupancy unit* it must be separated in accordance with **(a)(i)** and **(ii)**.

F5.7 Sound isolation of pumps

A flexible coupling must be used at the point of connection between the service pipes in a building and any circulating or other pump.

SPECIFICATION **F5.2** SOUND INSULATION FOR BUILDING ELEMENTS

Deemed-to-Satisfy Provisions

1. Scope

- (a) This Specification lists the weighted sound reduction index R_w for some common forms of construction.
- (b) Wall systems listed in Table 2 having a minimum 20 mm cavity between 2 separate leaves, with—
- (i) for masonry, where wall ties are required to connect leaves, the ties are of the resilient type; and
 - (ii) for other than masonry, there is no mechanical linkage between leaves except at the periphery,
- are deemed to be discontinuous construction.

2. Construction Deemed-to-Satisfy

The forms of construction listed in Table 2 for wall construction and Table 3 for floor construction, are considered to have the R_w , $R_w + C_{tr}$ and $L_{n,w}$ stated in that Table. The forms of construction must be installed as follows:

- (a) **Masonry** — Units must be laid with all joints filled solid, including those between the masonry and any adjoining construction.
- (b) **Concrete slabs** — Joints between concrete slabs or panels and any adjoining construction must be filled solid.
- (c) **Sheeting materials**—
- (i) if one layer is *required* on both sides of a wall, it must be fastened to the studs with joints staggered on opposite sides; and
 - (ii) if two layers are *required*, the second layer must be fastened over the first layer so that the joints do not coincide with those of the first layer; and
 - (iii) joints between sheets or between sheets and any adjoining construction must be taped and filled solid.
- (d) **Timber or steel-framed construction** — perimeter framing members must be securely fixed to the adjoining structure and—
- (i) bedded in resilient compound; or
 - (ii) the joints must be caulked so that there are no voids between the framing members and the adjoining structure.
- (e) **Services**—
- (i) Services must not be chased into concrete or masonry elements.
 - (ii) A door or panel *required* to have a certain $R_w + C_{tr}$ that provides access to a duct, pipe or other service must—

Deemed-to-Satisfy Provisions



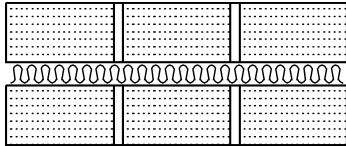
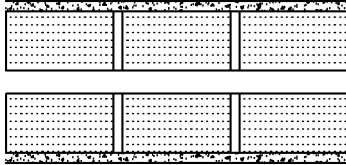

- (A) not open into any *habitable room* (other than a kitchen); and
- (B) be firmly fixed so as to overlap the frame or rebate of the frame by not less than 10 mm, be fitted with a sealing gasket along all edges and be constructed of—
 - (aa) wood, particleboard or blockboard not less than 33 mm thick; or
 - (bb) compressed fibre-reinforced cement sheeting not less than 9 mm thick; or
 - (cc) other suitable material with a mass per unit area not less than 24.4 kg/m².
- (iii) A water supply pipe must—
 - (A) only be installed in the cavity of discontinuous construction; and
 - (B) in the case of a pipe that serves only one *sole-occupancy unit*, not be fixed to the wall leaf on the side adjoining any other *sole-occupancy unit* and have a clearance not less than 10 mm to the other wall leaf.
- (iv) Electrical outlets must be offset from each other—
 - (A) in masonry walling, not less than 100 mm; and
 - (B) in timber or steel framed walling, not less than 300 mm.

Table 2 ACCEPTABLE FORMS OF CONSTRUCTION FOR WALLS

Description	$R_w + C_{tr}$ (not less than)	R_w (not less than)	Construction
Wall construction type: Masonry			
Two leaves of 110 mm clay brick masonry with— (a) cavity not less than 50 mm between leaves; and (b) 50 mm thick glass wool insulation with a density of 11 kg/m ³ or 50 mm thick polyester insulation with a density of 20 kg/m ³ in the cavity.	50	50	
Two leaves of 110 mm clay brick masonry with— (a) cavity not less than 50 mm between leaves and; (b) 13 mm cement render on each outside face.	50	50	

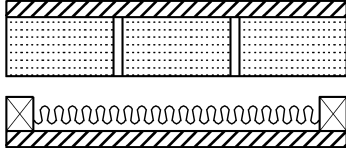
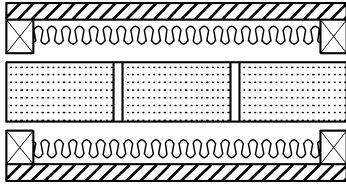
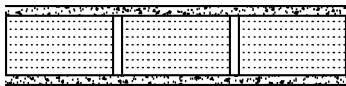

Deemed-to-Satisfy Provisions

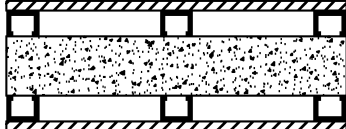
Table 2 ACCEPTABLE FORMS OF CONSTRUCTION FOR WALLS — continued

Description	$R_w + C_{tr}$ (not less than)	R_w (not less than)	Construction
Single leaf of 110 mm clay brick masonry with— (a) a row of 70 mm × 35 mm timber studs or 64 mm steel studs at 600 mm centres, spaced 20 mm from the masonry wall; and (b) 50 mm thick glass or mineral wool insulation with a density of 11 kg/m ³ positioned between studs; and (c) one layer of 13 mm plasterboard fixed to outside face of studs and outside face of masonry.	50	50	
Single leaf of 90 mm clay brick masonry with— (a) a row of 70 mm × 35 mm timber studs or 64 mm steel studs at 600 mm centres, spaced 20 mm from each face of the masonry wall; and (b) 50 mm thick glass or mineral wool insulation with a density of 11 kg/m ³ positioned between studs in each row; and (c) one layer of 13 mm plasterboard fixed to studs on each outside face.	50	50	
Single leaf of 150 mm brick masonry with 13 mm cement render on each face.	-	50	
Single leaf of 220 mm brick masonry with 13 mm cement render on each face.	50	50	
110 mm thick brick masonry with 13 mm cement render on each face.	-	45	
110 mm thick concrete brickwork.	-	45	
Wall construction type: Concrete			
150 mm thick concrete panel.	50	50	
150 mm thick concrete panel with one layer of 10 mm plasterboard fixed to 28 mm metal furring channels on each face.	-	50	

Deemed-to-Satisfy Provisions

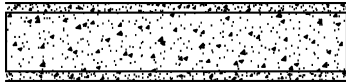
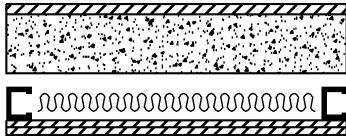
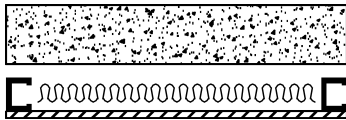
Table 2 ACCEPTABLE FORMS OF CONSTRUCTION FOR WALLS — continued

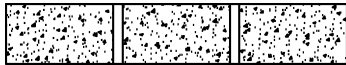
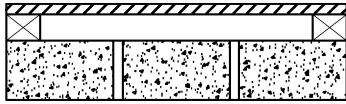
Description	$R_w + C_{tr}$ (not less than)	R_w (not less than)	Construction
200 mm thick concrete panel with one layer of 13 mm plasterboard or 13 mm cement render on each face.	50	50	
100 mm thick concrete panel with— (a) a row of 64 mm steel studs at 600 mm centres, spaced 25 mm from the concrete panel; and (b) 80 mm thick polyester insulation or 50 mm thick glass wool insulation with a density of 11 kg/m ³ , positioned between studs; and (c) two layers of 13 mm plasterboard fixed to outside face of studs and one layer of 13 mm plasterboard fixed to outside face of concrete panel.	50	50	
125 mm thick concrete panel with— (a) a row of 64 mm steel studs at 600 mm centres, spaced 20 mm from the concrete panel; and (b) 70 mm polyester insulation with a density of 9 kg/m ³ , positioned between studs; and (c) one layer of 13 mm plasterboard fixed to the outside face of the studs.	50	50	
125 mm thick concrete panel.	-	50	
100 mm concrete panel with 13 mm cement render or one layer of 13 mm plasterboard on each face.	-	50	
190 mm thick concrete blockwork.	-	45	
140 mm thick concrete blockwork, the face shell thickness of the blocks being not less than 44 mm and with— (a) 50 mm x 50 mm timber battens spaced at not more than 610 mm centres screw-fixed on one face of the blocks into resilient plugs with rubber inserts between battens and the wall; and (b) the face of the battens clad with 13 mm plasterboard.	-	45	

Deemed-to-Satisfy Provisions

Table 2 ACCEPTABLE FORMS OF CONSTRUCTION FOR WALLS — continued

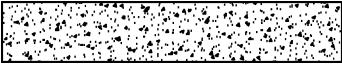
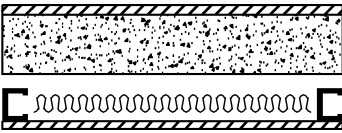
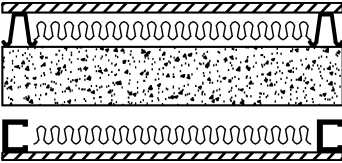
Description	$R_w + C_{tr}$ (not less than)	R_w (not less than)	Construction
Concrete panel - 100 mm thick.	-	45	
Note: For the purposes of this table the term "concrete panel" is a reference to a solid in-situ concrete panel or solid precast concrete panel.			
Wall construction type: Autoclaved aerated concrete			
75 mm thick autoclaved aerated concrete wall panel with— (a) a row of 64 mm steel studs at 600 mm centres, spaced 20 mm from the autoclaved aerated concrete wall panel; and (b) 75 mm thick glass wool insulation with a density of 11 kg/m ³ positioned between studs; and (c) one layer of 10 mm moisture resistant plasterboard or 13 mm fire protective grade plasterboard fixed to outside face of studs and outside face of autoclaved aerated concrete wall panel.	50	50	
75 mm thick autoclaved aerated concrete wall panel with— (a) a row of 64 mm steel studs at 600 mm centres, spaced 35 mm from the autoclaved aerated concrete panel wall; and (b) 28 mm metal furring channels fixed to the outside face of the autoclaved aerated concrete wall panel, with 50 mm thick polyester insulation with a density of 9 kg/m ³ positioned between furring channels and one layer of 13 mm fire protective grade plasterboard fixed to furring channels; and (c) 105 mm thick glass wool insulation with a density of 7 kg/m ³ positioned between studs; and (d) one layer of 13 mm fire protective grade plasterboard fixed to the outside face of the studs.	50	50	

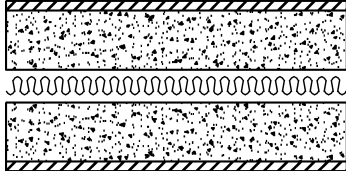
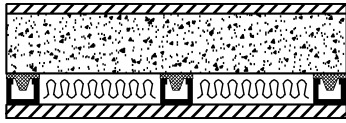
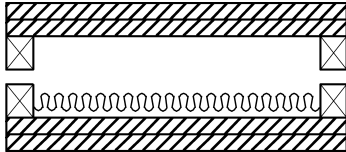
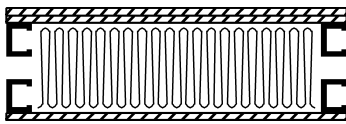

Deemed-to-Satisfy Provisions

Table 2 ACCEPTABLE FORMS OF CONSTRUCTION FOR WALLS — continued

Description	$R_w + C_{tr}$ (not less than)	R_w (not less than)	Construction
<p>Two leaves of 75 mm autoclaved aerated concrete wall panel with—</p> <p>(a) a cavity not less than 30 mm between panels containing 50 mm glass wool insulation with a density of 11 kg/m³; and</p> <p>(b) one layer of 10 mm plasterboard fixed to outside face of each panel.</p>	50	50	
<p>75 mm thick autoclaved aerated concrete wall panel with—</p> <p>(a) one layer of 10 mm moisture resistant plasterboard on one face; and</p> <p>(b) 28 mm metal furring channels and resilient mounts, 75 mm polyester insulation with a density of 9 kg/m³ and 13 mm fire-protective grade plasterboard fixed to the other face.</p>	-	50	
Wall construction type: Timber and steel framing			
<p>Two rows of 90×35 mm timber studs or two rows of 64 mm steel studs at 600 mm centres with—</p> <p>(a) an air gap not less than 20 mm between the rows of studs; and</p> <p>(b) 50 mm thick glass wool insulation or 60 mm thick polyester insulation with a density of 11 kg/m³; positioned between one row of studs; and</p> <p>(c) two layers of 13 mm fire-protective grade plasterboard or one layer of 6 mm fibre cement sheet and one layer of 13 mm fire-protective grade plasterboard, fixed to outside face of studs.</p>	50	50	
<p>Two rows of 64 mm steel studs at 600 mm centres with—</p> <p>(a) an air gap not less than 80 mm between the rows of studs; and</p> <p>(b) 200 mm thick polyester insulation with a density of 14 kg/m³; positioned between studs; and</p> <p>(c) one layer of 13 mm fire-protective grade plasterboard and one layer 13 mm plasterboard on one outside face and one layer of 13 mm fire-protective grade plasterboard on the other outside face.</p>	50	50	

Deemed-to-Satisfy Provisions

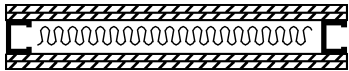
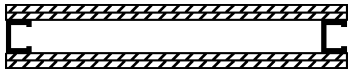
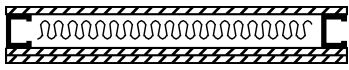
Table 2 ACCEPTABLE FORMS OF CONSTRUCTION FOR WALLS — continued

Description	$R_w + C_{tr}$ (not less than)	R_w (not less than)	Construction
One row of 92 mm steel studs at 600 mm centres with— (a) 50 mm thick glass wool insulation with a density of 11 kg/m ³ or 60 mm thick polyester insulation with a density of 8 kg/m ³ , positioned between studs; and (b) two layers of 13 mm fire-protective grade plasterboard or one layer of 6 mm fibre-cement sheet and one layer of 13 mm fire-protective grade plasterboard, fixed to each face.	-	50	
One row of 64 mm steel studs with 2 layers of 16 mm fire-protective grade plasterboard fixed to each face.	-	45	
One row of 64 mm steel studs with— (a) one layer of 16 mm fire-protective grade plasterboard fixed to one face; and (b) 50 mm thick glass or mineral wool insulation with a density of 11 kg/m ³ positioned between the studs; and (c) two layers of fire-protective grade plasterboard fixed to the other face, the inner layer being 16 mm thick and the outer layer being 13 mm.	-	45	
One row of 64 mm steel studs with two layers of 13 mm plasterboard on each face.	-	45	

Deemed-to-Satisfy Provisions

Table 3 ACCEPTABLE FORMS OF CONSTRUCTION FOR FLOORS

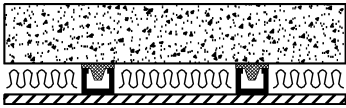
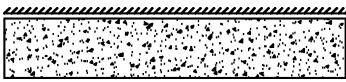
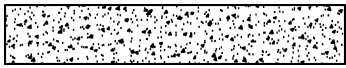
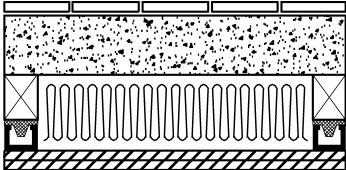
Description	$R_w + C_{tr}$ (not less than)	$L_{n,w}$ (not more than)	R_w (not less than)	Construction
Floor construction type: Concrete				
150 mm thick concrete slab with— (a) 28 mm metal furring channels and isolation mounts fixed to underside of slab, at 600 mm centres; and (b) 65 mm thick polyester insulation with a density of 8 kg/m ³ , positioned between furring channels; and (c) one layer of 13 mm plasterboard fixed to furring channels.	50	62	50	
200 mm thick concrete slab with carpet on underlay.	50	62	50	
100 mm thick concrete slab.	45	-	45	
Floor construction type: Autoclaved aerated concrete				
75 mm thick autoclaved aerated concrete floor panel with— (a) 8 mm ceramic tiles with flexible adhesive and waterproof membrane, located above the slab; and (b) timber joists at 600 mm centres; and (c) R1.5 glass wool insulation positioned between timber joists; and (d) 28 mm metal furring channels and resilient mounts fixed to underside of joists; and (e) two layers of 13 mm plasterboard fixed to furring channels.	50	62	50	

Deemed-to-Satisfy Provisions

Table 3 ACCEPTABLE FORMS OF CONSTRUCTION FOR FLOORS — *continued*

Description	$R_{w + C_{tr}}$ (not less than)	$L_{n,w}$ (not more than)	R_w (not less than)	Construction
Floor construction type: Timber				
<p>19 mm thick chipboard floor sheeting with—</p> <p>(a) 190×45 mm timber joists at 450 mm centres; and</p> <p>(b) R2.5 glass wool insulation positioned between timber joists; and</p> <p>(c) 28 mm metal furring channels and isolation mounts fixed to underside of joists, isolation mounts to be of natural rubber with a dynamic factor of not more than 1.1 and static deflection of not less than 3 mm at actual operating load; and</p> <p>(d) two layers of 16 mm fire-protective grade plasterboard fixed to furring channels.</p>	50	62	50	
<p>19 mm thick tongued and grooved boards with—</p> <p>(a) timber joists not less than 175 mm x 50 mm; and</p> <p>(b) 75 mm thick glass or mineral wool insulation with a density of 11 kg/m³ positioned between joists and laid on 10 mm thick plasterboard fixed to underside of joists; and</p> <p>(c) 25 mm thick glass or mineral wool insulation with a density of 11 kg/m³ laid over entire floor, including tops of joists before flooring is laid; and</p> <p>(d) secured to 75 mm x 50 mm battens; and</p> <p>(e) the assembled flooring laid over the joists, but not fixed to them, with the battens lying between the joists.</p>	45	-	45	

SPECIFICATION **F5.5** IMPACT SOUND — TEST OF
EQUIVALENCE

Deemed-to-Satisfy Provisions

1. Scope

This Specification describes a method of test to determine the comparative resistance of walls to the transmission of impact sound.

2. Construction to be tested

- (a) The test is conducted on a specimen of prototype wall construction and on a specimen of one or other of the constructions specified in **Table 2 of Specification F5.2**.
- (b) The testing of a construction specified in **Table 2 of Specification F5.2** need not be repeated for subsequent comparisons provided complete records of the results, the test equipment and the technique of testing are kept so that identical equipment can be employed and an identical technique can be adopted in the testing of specimens of prototype wall construction.

3. Method

- (a) The wall constructions to be compared must be tested in accordance with AS 1191.
- (b) A horizontal steel platform 510 mm x 460 mm x 10 mm thick must be placed with one long edge in continuous and direct contact with the wall to be tested on the side of the wall on which the impact sound is to be generated.
- (c) A tapping machine complying with ISO 140/6 — 1998 (E) must be mounted centrally on the steel platform.
- (d) The sound transmission through the wall must be determined in accordance with AS 1191 except that the tapping machine as mounted on the steel platform must be used as the source of sound.
- (e) The impact sound pressure levels measured in the receiving room must be converted into normalised levels using a reference equivalent absorption area of 10 m².

ANCILLARY PROVISIONS

- G1** **Minor Structures and Components**

- G2** **Boilers, Pressure Vessels, Heating Appliances,
Fireplaces, Chimneys and Flues**

- G3** **Atrium Construction**

- G4** **Construction in Alpine Areas**

- G5** **Construction in Bushfire Prone Areas**

SECTION G CONTENTS

SECTION G ANCILLARY PROVISIONS

Part G1 Minor Structures and Components

Performance Requirements GP1.1 - GP1.5

G1.0 Deemed-to-Satisfy Provisions

G1.1 Swimming pools

G1.2 Refrigerated chambers, strong-rooms and vaults

G1.3 Outdoor playspaces

Part G2 Boilers, Pressure Vessels, Heating Appliances, Fireplaces, Chimneys and Flues

Performance Requirements GP2.1 - GP2.2

G2.0 Deemed-to-Satisfy Provisions

G2.1 * * * * *

G2.2 Installation of appliances

G2.3 Open fireplaces

G2.4 Incinerator rooms

Specification G2.2 Installation of Boilers and Pressure Vessels

Part G3 Atrium Construction

G3.1 Application of Part

G3.2 Dimensions of atrium well

G3.3 Separation of atrium by bounding walls

G3.4 Construction of bounding walls

G3.5 Construction at balconies

G3.6 Separation at roof

G3.7 Means of egress

G3.8 Fire and smoke control systems

Specification G3.8 Fire and Smoke Control Systems in Buildings Containing Atriums

Part G4 Construction in Alpine Areas

Performance Requirements GP4.1 - GP4.4

G4.0 Deemed-to-Satisfy Provisions

G4.1 Application of Part

G4.2 * * * * *

G4.3 External doorways

G4.4 Emergency lighting

G4.5 External ramps

G4.6 Discharge of exits

G4.7 External trafficable structures

G4.8 Fire-fighting services and equipment

G4.9 Fire orders

Part G5 Construction in Bushfire Prone Areas

Performance Requirements GP5.1
G5.0 Deemed-to-Satisfy Provisions
G5.1 Application of Part
G5.2 Protection

PART G1

MINOR STRUCTURES AND COMPONENTS

PERFORMANCE REQUIREMENTS

GP1.1

NT GP1.1

A *swimming pool* must have adequate means of draining the pool in a manner which will not—

- (a) cause illness to people; or
- (b) affect *other property*.

GP1.2

ACT GP1.2(a)

NSW GP1.2(a)

NT GP1.2(a)

Qld GP1.2(a)

SA GP1.2(a), (b)

Tas GP1.2(a)

Vic GP1.2(a)

- (a) A barrier must be provided to a *swimming pool* and must—
 - (i) be continuous for the full extent of the hazard; and
 - (ii) be of a strength and rigidity to withstand the foreseeable impact of people; and
 - (iii) restrict the access of young children to the pool and the immediate pool surrounds; and
 - (iv) have any gates and doors fitted with latching devices not readily operated by young children, and constructed to automatically close and latch.
- (b) A *swimming pool* water recirculation system must incorporate safety measures to avoid entrapment of, or injury to, a person.

Application

GP1.2(b) only applies to a *swimming pool* with a depth of water more than 300 mm.

GP1.3

Any refrigerated or cooling chamber, or the like which is of sufficient size for a person to enter must—

- (a) have adequate means of communicating with or alerting other occupants in the building in the case of an emergency; and

- (b) have a door which is—
 - (i) of adequate dimensions to allow occupants to readily escape; and
 - (ii) openable from inside without a key at all times.

GP1.4

Any strong-room, vault or the like which is of sufficient size for a person to enter must—

- (a) have adequate means of communicating with or alerting other occupants in the building in the case of an emergency; and
- (b) have internal lighting controllable only from within the room; and
- (c) have an external indicator that the room is occupied.

GP1.5

Fencing or other barriers must be provided around any outdoor play space, in which the design and height of the fencing or other barriers, including the—

- (a) design of gates and fittings; and
- (b) proximity of the barriers to any permanent structure on the property,

must ensure that children cannot go through, over or under the fencing or other barriers.

Application

GP1.5 only applies to a Class 9b *early childhood centre*.

Tas GP1.6

PART G1

MINOR STRUCTURES AND COMPONENTS

Deemed-to-Satisfy Provisions

G1.0 Deemed-to-Satisfy Provisions

- (a) *Performance Requirement GP1.1* must be complied with.

There is no *Deemed-to-Satisfy Provision* for this *Performance Requirement*.

Tas G1.0(b)

- (b) Where a *Deemed-to-Satisfy Solution* is proposed, *Performance Requirements GP1.2* to *GP1.5* are satisfied by complying with *G1.1* to *G1.3*.
- (c) Where a *Performance Solution* is proposed, the relevant *Performance Requirements* must be determined in accordance with *A0.7*.

G1.1 Swimming pools

NSW G1.1(a)

NT G1.1(a)

Qld G1.1(a)

Vic G1.1(a)

- (a) * * * * *

- (b) A *swimming pool* with a depth of water more than 300 mm and which is associated with a Class 2 or 3 building or Class 4 part of a building, must have suitable barriers to restrict access by young children to the immediate pool surrounds in accordance with AS 1926 Parts 1 and 2.

SA G1.1(b)

- (c) A water recirculation system in a *swimming pool* with a depth of water more than 300 mm must comply with AS 1926.3.

ACT G1.1(d)–(e)

SA G1.1(d)

Tas G1.1(d)–(h)

Explanatory information: Cross-volume considerations

Part C2 of NCC Volume Three sets out the requirements for pumped discharge from *swimming pools*.

G1.2 Refrigerated chambers, strong-rooms and vaults

- (a) A refrigerated or cooling chamber, strongroom or vault which is of sufficient size for a person to enter must have—
- (i) a door which is capable of being opened by hand from inside without a key; and

Deemed-to-Satisfy Provisions

- (ii) internal lighting controlled only by a switch which is located adjacent to the entrance doorway inside the chamber, strongroom or vault; and
- (iii) an indicator lamp positioned outside the chamber, strongroom or vault which is illuminated when the interior lights *required* by (a)(ii) are switched on; and
- (iv) an alarm that is—
 - (A) located outside but controllable only from within the chamber, strongroom or vault; and
 - (B) able to achieve a sound pressure level outside the chamber, strongroom or vault of 90 dB(A) when measured 3 m from the sounding device.
- (b) A door *required* by (a)(i) in a refrigerated or cooling chamber must have a doorway with a clear width of not less than 600 mm and a clear height not less than 1.5 m.

G1.3 Outdoor play spaces

- (a) Any outdoor play space in a Class 9b *early childhood centre* must be enclosed on all sides with a barrier which complies with AS 1926.1.
- (b) For the purposes of (a), AS 1926.1 is applied as if there is a *swimming pool* located outside the outdoor play space, so that the barrier restricts children from exiting the premises without the knowledge of staff in the centre.
- (c) The requirements of (a) do not apply to a wall, including doors and *windows*, which form part of the Class 9b *early childhood centre*.

NSW G1.101

PART G2

BOILERS, PRESSURE VESSELS, HEATING APPLIANCES, FIREPLACES, CHIMNEYS AND FLUES

PERFORMANCE REQUIREMENTS

GP2.1

Where provided in a building, a combustion appliance and its associated components, including an open fire-place, chimney, flue, chute, hopper or the like, must be installed—

- (a) to withstand the temperatures likely to be generated by the appliance; and
- (b) so that it does not raise the temperature of any building element to a level that would adversely affect the element's physical or mechanical properties or function; and
- (c) so that hot products of combustion will not—
 - (i) escape through the walls of the associated components; and
 - (ii) discharge in a position that will cause fire to spread to nearby *combustible* materials or allow smoke to penetrate through nearby *windows*, ventilation inlets, or the like.

GP2.2

When located in a building, *boilers* and *pressure vessels* must be installed to avoid, during reasonably foreseeable conditions, the likelihood of—

- (a) leakage from the vessel which could cause damage to the building; and
- (b) rupture or other mechanical damage of the vessel which could cause damage to the building or injury to occupants.

PART G2

BOILERS, PRESSURE VESSELS, HEATING APPLIANCES, FIREPLACES, CHIMNEYS AND FLUES

Deemed-to-Satisfy Provisions

G2.0 Deemed-to-Satisfy Provisions

- (a) Where a *Deemed-to-Satisfy Solution* is proposed, *Performance Requirements GP2.1* and *GP2.2* are satisfied by complying with *G2.1* to *G2.4*.
- (b) Where a *Performance Solution* is proposed, the relevant *Performance Requirements* must be determined in accordance with *A0.7*.

G2.1 * * * * *

This clause has deliberately been left blank.

G2.2 Installation of appliances

The installation of a stove, heater or similar appliance in a building must comply with:

- (a) * * * * *
- (b) Domestic solid-fuel burning appliances — Installation: AS/NZS 2918.
- (c) For *boilers* and *pressure vessels*: **Specification G2.2**.

ACT G2.2(d), (e)

G2.3 Open fireplaces

An open fireplace, or solid-fuel burning appliance in which the fuel-burning compartment is not enclosed must have—

- (a) a hearth constructed of stone, concrete, masonry or similar *non-combustible* material so that—
 - (i) it extends not less than 300 mm beyond the front of the fireplace opening and not less than 150 mm beyond each side of that opening; and
 - (ii) it extends beyond the limits of the fireplace or appliance not less than 300 mm if the fireplace or appliance is free-standing from any wall of the room; and
 - (iii) its upper surface does not slope away from the grate or appliance; and
 - (iv) *combustible* material situated below the hearth but not below that part *required* to extend beyond the fireplace opening or the limits of the fireplace is not less than 150 mm from the upper surface of the hearth; and
- (b) walls forming the sides and back of the fireplace up to not less than 300 mm above the underside of the arch or lintel which—
 - (i) are constructed in 2 separate leaves of solid masonry not less than 180 mm thick, excluding any cavity; and

Deemed-to-Satisfy Provisions

- (ii) do not consist of concrete block masonry in the construction of the inner leaf; and
- (c) walls of the chimney above the level referred to in (b)—
 - (i) constructed of masonry units with a net volume, excluding cored and similar holes, not less than 75% of their gross volume, measured on the overall rectangular shape of the units, and with an actual thickness of not less than 100 mm; and
 - (ii) lined internally to a thickness of not less than 12 mm with rendering consisting of 1 part cement, 3 parts lime, and 10 parts sand by volume, or other suitable material; and
- (d) suitable damp-proof courses or flashings to maintain weatherproofing.

G2.4 Incinerator rooms

- (a) If an incinerator is installed in a building any hopper giving access to a charging chute must be—
 - (i) *non-combustible*; and
 - (ii) gas-tight when closed; and
 - (iii) designed to return to the closed position after use; and
 - (iv) not attached to a chute that connects directly to a flue unless the hopper is located in the open air; and
 - (v) not located in a *required exit*.
- (b) A room containing an incinerator must be separated from other parts of the building by construction with an FRL of not less than 60/60/60.

SPECIFICATION **G2.2** INSTALLATION OF BOILERS AND PRESSURE VESSELS

Deemed-to-Satisfy Provisions

1. SCOPE

This Specification sets out the requirements for the installation of *boilers* and *pressure vessels* in buildings.

2. BOILERS AND PRESSURE VESSELS

2.1 Explosion relief

The distance between the vent of any explosion relief device and any adjacent wall, roof, ceiling or other solid construction shall be calculated in accordance with **Table 2.1**.

Table 2.1 MINIMUM CLEARANCES FOR EXPLOSION RELIEF

Clearance from —	Minimum Clearance (metres)
Adjacent wall or ceiling/roof	$0.4(V/3)^{1/3}$ or 0.4 m, whichever is the greater
Two walls at right angles; or one wall and a ceiling/roof	$0.6(V/3)^{1/3}$ or 0.6 m, whichever is the greater

Note: V is the internal volume of the *boiler* or *pressure vessel* being vented up to the connection of the flue.

2.2 Floors and drainage

- (a) Floor surfaces beneath *boilers* and *pressure vessels* shall be *water resistant* and formed to drain away from supports and structural building elements.
- (b) Where a safe tray is provided to trap liquids, it must be manufactured from a material resistant to corrosion from the contents of the *boiler* or *pressure vessel*.

2.3 Protection from heat

Building elements surrounding a *boiler* must be protected from any surface heat by refractory material or effective air spaces so that—

- (a) steel elements do not exceed a temperature of more than 300°C; and
- (b) concrete elements do not exceed a temperature of more than 200°C; and
- (c) timber elements do not exceed a temperature of more than 150°C.

PART G3

ATRIUM CONSTRUCTION

Deemed-to-Satisfy Provisions

Note:

Part G3 contains *Deemed-to-Satisfy Provisions* additional to those contained in **Sections C, D and E** for *Atrium* Construction.

G3.1 Application of Part

This Part does not apply to an *atrium* which—

- (a) connects only 2 *storeys*; or
- (b) connects only 3 *storeys* if—
 - (i) each *storey* is provided with a sprinkler system complying with **Specification E1.5** throughout; and
 - (ii) one of those *storeys* is situated at a level at which there is direct egress to a road or *open space*.

G3.2 Dimensions of atrium well

An *atrium well* must have a width throughout the well that is able to contain a cylinder having a horizontal diameter of not less than 6 m.

G3.3 Separation of atrium by bounding walls

An *atrium* must be separated from the remainder of the building at each *storey* by bounding walls set back not more than 3.5 m from the perimeter of the *atrium well* except in the case of the walls at no more than 3 consecutive *storeys* if—

- (a) one of those *storeys* is at a level at which direct egress to a road or *open space* is provided; and
- (b) the sum of the *floor areas* of those *storeys* that are contained within the *atrium* is not more than the maximum area that is permitted in **Table C2.2**.

G3.4 Construction of bounding walls

Bounding walls must—

- (a) have an FRL of not less than 60/60/60, and—
 - (i) extend from the floor of the *storey* to the underside of the floor next above or to the underside of the roof; and
 - (ii) have any door openings protected with *self-closing* or *automatic* –/60/30 fire doors; or
- (b) be constructed of fixed toughened safety glass, or wired safety glass in *non-combustible* frames, with—
 - (i) any door openings fitted with a *self-closing* smoke door complying with **Specification C3.4**; and

Deemed-to-Satisfy Provisions

- (ii) the walls and doors protected with wall-wetting systems in accordance with **Specification G3.8**; and
- (iii) a fire barrier with an FRL of not less than $-/60/30$ installed in any ceiling spaces above the wall.

G3.5 Construction at balconies

If a bounding wall separating an *atrium* from the remainder of the building is set back from the perimeter of the *atrium well*, a barrier that is imperforate and *non-combustible*, and not less than 1 m high must be provided.

G3.6 Separation at roof

In an *atrium*—

- (a) the roof must have the FRL prescribed in **Table 3 of Specification C1.1**; or
- (b) the roof structure and membrane must be protected by a sprinkler system complying with **Specification E1.5**.

G3.7 Means of egress

All areas within an *atrium* must have access to at least 2 *exits*.

G3.8 Fire and smoke control systems

Sprinkler systems, smoke control, fire detection and alarm systems, and sound systems and intercom system for emergency purposes must be installed in compliance with **Specification G3.8**.

SPECIFICATION **G3.8** FIRE AND SMOKE CONTROL SYSTEMS IN BUILDINGS CONTAINING ATRIUMS

Deemed-to-Satisfy Provisions

1. SCOPE

This Specification sets out the requirements for the design and operation of systems of fire and smoke control in buildings containing an *atrium*.

2. AUTOMATIC FIRE SPRINKLER SYSTEM

2.1 General requirement

A sprinkler system complying with **Specification E1.5** must be installed in every building containing an *atrium*, except where varied or superseded by this Specification.

2.2 Roof protection

A roof of an *atrium* which does not have the FRL prescribed in **Specification C1.1** or the *Deemed-to-Satisfy Provisions* of **Part C2** must be protected by *automatic* sprinklers arranged to wet both the covering membrane and supporting structure if the roof is—

- (a) less than 12 m above the floor of the *atrium* or the floor of the highest *storey* where the bounding construction is set back more than 3.5 m from the *atrium well* if a Class 2, 3, 5 or 9 part of a building is open to the *atrium*; or
- (b) less than 20 m above the floor of the *atrium* or the floor of the highest *storey* where the bounding construction is set back more than 3.5 m from the *atrium well* if a Class 6, 7 or 8 part of a building is open to the *atrium*,

and the temperature rating of sprinkler heads providing roof protection must be within the range 79°C–100°C.

2.3 Atrium floor protection

The floor of the *atrium* must be protected by sprinklers with—

- (a) the use of sidewall pattern sprinkler heads together with overhead sprinklers where dictated by the dimensions of the *atrium*; and
- (b) sprinkler heads of the fast response type, installed with suitable *non-combustible* heat collector plates of 200 mm minimum diameter to ensure activation by a rising fire plume.

2.4 Sprinkler systems to glazed walls

2.4.1 Location of protection

Where an *atrium* is separated from the remainder of the building by walls or doors incorporating glazing, a wall wetting system with suitable *non-combustible* heat collector plates of 200 mm diameter must be provided to protect the glazing as follows:

Deemed-to-Satisfy Provisions

- (a) On the *atrium* side of the glazing — to all glazed walls which are set back more than 3.5 m from the *atrium well*.
- (b) On the *atrium* side of the glazing — to all glazed walls which are not set back, or are set back 3.5 m or less, from the *atrium well*, for all levels which are less than—
 - (i) 12 m above the floor of an *atrium* or the floor of the highest *storey* where the bounding wall is set back more than 3.5 m from the *atrium well* if a Class 2, 3, 5 or 9 part of the building is open to the *atrium*; or
 - (ii) 20 m above the floor of an *atrium* or the floor of the highest *storey* where the bounding wall is set back more than 3.5 m from the *atrium well* if a Class 6, 7 or 8 part of the building is open to the *atrium*.
- (c) On the side of the glazing away from the *atrium well*—to all glazing forming part of the bounding wall at each *storey*.

2.4.2 Sprinkler head location

Sprinklers must be located in positions allowing full wetting of the glazing surfaces without wetting adjacent sprinkler heads.

2.4.3 Head rating and response time

Sprinkler heads must be of the fast response type and have a maximum temperature rating of 74°C.

2.4.4 Water discharge rate

The rate of water discharge to protect glazing must be not less than—

- (a) on the *atrium* side of the glazing—
 - (i) 0.25 L/s.m² where glazing is not set back from the *atrium well*; or
 - (ii) 0.167 L/s.m² where glazing is set back from the *atrium well*; and
- (b) on the side away from the *atrium well*—0.167 L/s.m².

2.4.5 Water supply

In addition to that of the basic sprinkler protection for the building, the water supply to *required* wall wetting systems must be of adequate capacity to accommodate the following on the *atrium* side of the glazing:

- (a) Where the bounding walls are set back less than 3.5 m from the *atrium well*—wall wetting of a part not less than 6 m long for a height of not less than—
 - (i) 12 m above the floor of an *atrium* or the floor of the highest *storey* where the bounding wall is set back more than 3.5 m from the *atrium well* if a Class 2, 3, 5 or 9 part of the building is open to the *atrium*; or
 - (ii) 20 m above the floor of an *atrium* or the floor of the highest *storey* where the bounding wall is set back more than 3.5 m from the *atrium well* if a Class 6, 7 or 8 part of the building is open to the *atrium*; and
- (b) Where the walls are set back 3.5 m or more from the *atrium well* — wetting of a part not less than 12 m long on one *storey*.

Deemed-to-Satisfy Provisions

2.5 Stop valves

- (a) Basic sprinkler and wall wetting systems protecting a building containing an *atrium* must be provided with easily accessible and identified stop valves.
- (b) Sprinkler and wall wetting systems must be provided with independent stop valves.
- (c) Sprinkler heads protecting the roof of the *atrium* must be provided with a stop valve.
- (d) Stop valve to wall wetting and roof sprinklers may be of the gate type.
- (e) All sprinkler and wall wetting stop valves must be monitored to detect unauthorised closure.

3. SMOKE CONTROL SYSTEM

3.1 General requirements

Except where varied or superseded by this Specification, mechanical air-handling systems in a building containing an *atrium* must comply with AS/NZS 1668.1.

3.2 Operation of atrium mechanical air-handling systems

Mechanical air-handling systems serving an *atrium* must be designed to operate so that during a fire—

- (a) a tenable atmosphere is maintained in all paths of travel along balconies to *required exits* during the period of evacuation; and
- (b) smoke exhaust fans serving the *atrium* are only activated when smoke enters the *atrium*; and
- (c) central plant systems do not use the *atrium* as a return air path; and
- (d) central plant systems which use return air paths remote from the *atrium*—
 - (i) cycle to the full outside air mode; and
 - (ii) stop supply air to the fire affected *storey* or *fire compartment*; and
 - (iii) continue to fully exhaust the fire affected *storey* or *fire compartment* and reduce the exhaust from other *storeys* or *fire compartments* by at least 75%; and
 - (iv) continue to supply air to *fire compartments* or *storeys* other than the fire affected *storey* or *fire compartment*; and
- (e) fans performing relief or exhaust duty from the *atrium* stop normal operation; and
- (f) floor by floor, or unitary, air-handling plant serving a single *fire compartment* or *storey*—
 - (i) ceases normal operation in the fire affected *storey* or *fire compartment*; and
 - (ii) commences full relief or exhaust from that fire affected *storey* or *fire compartment*; and
 - (iii) continue to supply air to *fire compartments* or *storeys* other than the fire affected *storey* or *fire compartment*.

3.3 Activation of smoke control system

- (a) The smoke control system must be activated by—

Deemed-to-Satisfy Provisions

- (i) operation of an *automatic* fire alarm; or
 - (ii) operation of the sprinkler system; or
 - (iii) a manual start switch.
- (b) All controls for the smoke control system must be located—
- (i) in the fire control room; or
 - (ii) in the emergency control centre, (if any); or
 - (iii) adjacent to the sprinkler control valves; or
 - (iv) incorporated in the Fire Indicator Panel.

3.4 Smoke exhaust system

A smoke exhaust system serving an *atrium* must be designed on the basis of—

- (a) the sprinkler system limiting the size of a fire to—
- (i) a heat output of 1.5 MW and perimeter of 7.5 m if a Class 2, 3, 5 or 9 part of the building is open to the *atrium*; or
 - (ii) a heat output of 5 MW and perimeter of 12 m if a Class 6, 7 or 8 part of the building is open to the *atrium*; and
- (b) a smoke plume reaching a level 3 m above the highest *storey* having a path of travel to a *required exit* along a balcony bounding the *atrium well*, and not less than—
- (i) 12 m above the floor of an *atrium* or the floor of the highest *storey* where the bounding wall is set back more than 3.5 m from the *atrium well* if a Class 2, 3, 5 or 9 part of the building is open to the *atrium*; or
 - (ii) 20 m above the floor of an *atrium* or the floor of the highest *storey* where the bounding construction is set back more than 3.5 m from the *atrium well* if a Class 6, 7 or 8 part of the building is open to the *atrium*; and
- (c) the smoke exhaust system discharging smoke at a rate of not less than that shown in **Figure 3.4** for the appropriate height of smoke plume and fire size—
- (i) from the top of the *atrium*; or
 - (ii) horizontally where calculations of wind velocity induced pressure profiles for the building verify that the exhaust system will operate effectively for all wind directions.

Deemed-to-Satisfy Provisions

Figure 3.4

SMOKE EXHAUST RATE

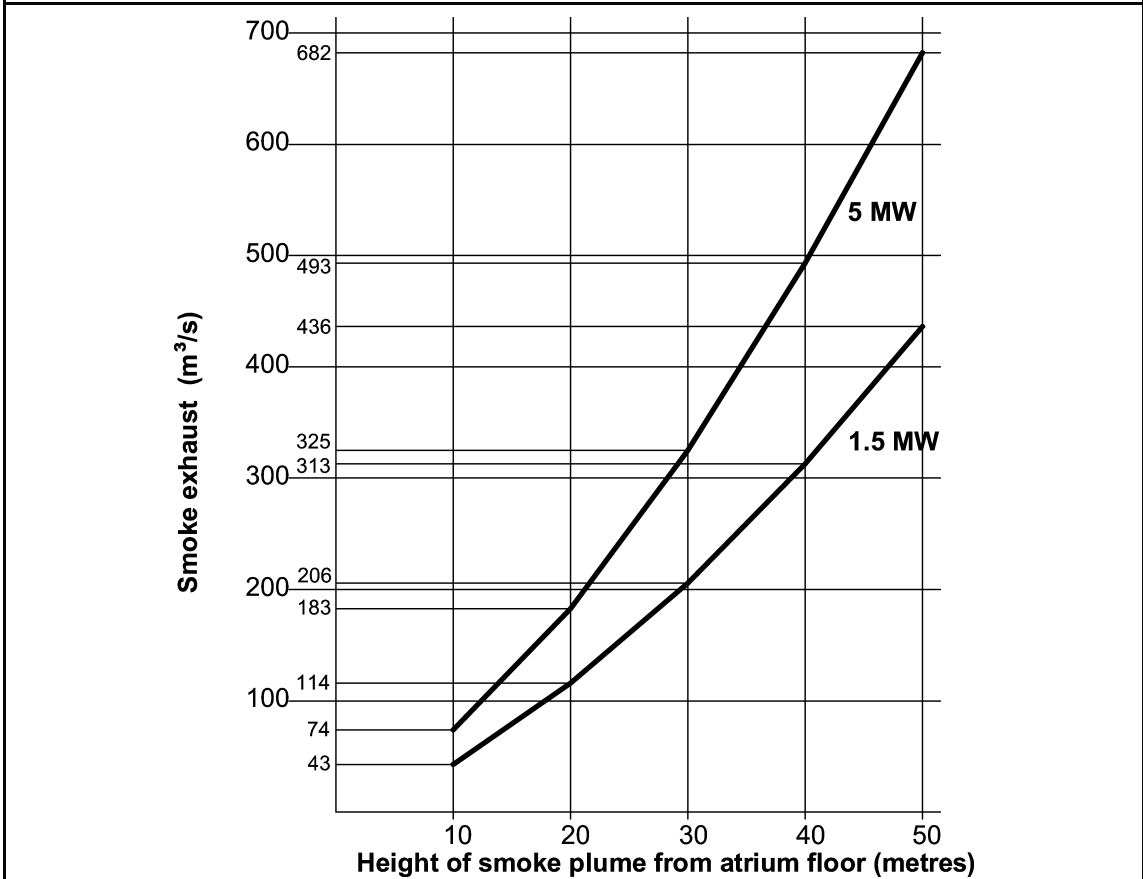

3.5 Upward air velocity

Notwithstanding 3.4(c), the average upward air velocity in the atrium, due to the required smoke exhaust quantity must—

- (a) be not less than 0.2 m/s at any level over an 18 m height above the floor of the atrium; and
- (b) not exceed the following maximum velocities in atriums of constant cross sectional plan area—
 - (i) for occupancy classification qualifying for 1.5 MW fire size — 3.5 m/s.
 - (ii) for occupancy classifications qualifying for 5 MW fire size — 5 m/s.

3.6 Exhaust fans

- (a) Smoke exhaust must be provided by fans capable of continuous and required operation for a period of not less than 1 hour when handling exhaust gases at 200°C.

Deemed-to-Satisfy Provisions

- (b) Where a Class 2, 3 or 9 part of a building adjoins an *atrium*, the *atrium* must be provided with a minimum of 3 fans each capable of 50% of the total *required* smoke exhaust capacity.
- (c) *Atriums* other than those referred to in (b) must be provided with a minimum of 2 fans each capable of 50% of the total *required* smoke exhaust capacity.

3.7 Smoke and heat vents

Notwithstanding **Clause 3.6**, *automatic* vents complying with AS 2665 may be used, except where a Class 6 part of a building adjoins the *atrium*, in lieu of exhaust fans provided that—

- (a) the height from the *atrium* floor to the bottom of the highest vent is not more than 12 m; and
- (b) the vents are fitted with a remote manual operation switch located adjacent to the sprinkler control valves or incorporated in the Fire Indicator Panel.

3.8 Make-up air supply

- (a) Uniformly distributed make-up air must be provided to the *atrium* exhaust system from—
 - (i) outside the *atrium* at or near the lowest *storey* level; and
 - (ii) relief air from non-fire *storeys*.
- (b) A discharge volume sufficient to maintain a velocity of not less than 0.1 m/s towards the *atrium well* must be provided on all *storeys* where the bounding wall is set back from the *atrium well*.
- (c) The requirements of (a)(i) are satisfied if make-up air is provided to the *atrium* exhaust system in such a manner as to prevent, as far as possible, disturbance of the smoke layer due to turbulence created by the incoming air, through—
 - (i) openings directly from the outside air to the *atrium* and located as close as practicable to the lowest level of the *atrium*; or
 - (ii) ducts from the outside air to the *atrium* which deliver air as close as practicable to the lowest level of the *atrium* and, where passing through any other *fire compartment* having an FRL of at least 60/60/60; or
 - (iii) a combination of (i) or (ii).

4. FIRE DETECTION AND ALARM SYSTEM

4.1 General requirements

Except where superseded by this Specification, *automatic* fire detection and alarm systems in a building containing an *atrium* must comply with AS 1670.1.

4.2 Smoke detection system

Smoke detection within an *atrium*—

- (a) must be provided within all outside air intakes and at individual floor return air intakes of all air-handling systems to initiate *automatic* fire mode operation, and where applicable, comply with the restart facilities in AS/NZS 1668.1; and

Deemed-to-Satisfy Provisions

- (b) must operate at an obscuration level not greater than 0.5% per metre with compensation for external airborne contamination as necessary; and
- (c) must sample air within the *atrium* and in *storeys* where the bounding wall is set back more than 3.5 m from the *atrium well*; and
- (d) must be calibrated to compensate for smoke dilution where sampling occurs within return air path common to more than one room; and
- (e) may incorporate beam type detectors to sense smoke in an *atrium* in a Class 5, 6, 7 or 8 building with an *effective height* of not more than 25 m if—
 - (i) the beam detectors are located at intervals of not more than 3 *storeys*; and
 - (ii) arranged to scan at 90 degrees orientation to adjacent beam units.

4.3 Smoke detection in spaces separated from the atrium by bounding walls

Smoke detection systems must be located at all return and relief air openings associated with the building air-handling systems and be—

- (a) of the sampling type system as *required* in 4.2; or
- (b) of the point type photoelectric smoke detector.

4.4 Alarm systems

- (a) A break-glass fire alarm point must be provided at each door to a *fire-isolated stairway*, *fire-isolated ramp*, or *fire-isolated passageway*.
- (b) A staged alarm must be provided where an air sampling type smoke detection system is provided for the *atrium*, and must operate as follows:
 - (i) Alert building management when abnormal smoke levels of 0.03% obscuration per metre are detected.
 - (ii) Initiate a second alarm to management and start all smoke control systems including pressurisation of escape routes when smoke levels of 0.07% obscuration per metre are detected.
 - (iii) Automatically call the *fire brigade*, activate the sound system and intercom system for emergency purposes, and de-activate all plant not necessary for fire safety within the building when smoke levels of 0.09% obscuration per metre are detected.
- (c) Beam and point type smoke detectors *required* must simultaneously operate all functions referred to above and activate at the level set out in AS 1670.1.

5. SOUND SYSTEMS AND INTERCOM SYSTEMS FOR EMERGENCY PURPOSES

All buildings containing an *atrium* must be provided with a sound system and intercom system for emergency purposes which—

- (a) complies with AS 1670.4; and
- (b) incorporates visual warning devices that—
 - (i) operate upon the evacuation signal; and

Deemed-to-Satisfy Provisions

- (ii) display the words “EVACUATE” in red with letters conforming with the requirements of the *Deemed-to-Satisfy Provisions* of **Part E4** for *exit* signs.

6. STANDBY POWER SYSTEM

- (a) If a *required* path of travel to an *exit* is within an *atrium*, a suitable alternative power supply must be provided to operate *required* safety systems, including sprinkler systems and fire hydrant pumps, air handling systems, alarms, warning and communication systems and emergency lighting circuits.
- (b) The alternative power supply must—
 - (i) be connected *automatically* if the normal power supply fails; and
 - (ii) if located within the building, be separated from the remainder of the building by an enclosure with an FRL of at least 120/120/120; and
 - (iii) be connected to the safety systems by means of cabling complying with **C2.13(c)(iii)** and **(iv)**.
- (c) The requirements of **(a)** are satisfied by—
 - (i) a single medium voltage supply taken from an electricity substation situated within, or adjacent to, the building concerned where the power supply to the substation consists of two or more high voltage cables each taking electricity from separate transformers; or
 - (ii) two or more medium voltage supplies each taking electricity from separate electricity substations situated—
 - (A) outside the building concerned; and
 - (B) at a suitable distance from each other; or
 - (iii) a single medium voltage supply taken from an electricity substation together with an electricity generating plant capable of—
 - (A) generating a medium voltage supply; and
 - (B) starting and taking the *required* electrical load within a period of not more than 30 seconds from the time of normal supply failure.

7. SYSTEM FOR EXCLUDING SMOKE FROM FIRE-ISOLATED EXITS

Required fire-isolated *exits* in a building containing an *atrium* must be protected from the entry of smoke in accordance with **E2.2**.

PART G4 CONSTRUCTION IN ALPINE AREAS

PERFORMANCE REQUIREMENTS

GP4.1

An external doorway from a building in an *alpine area* must be installed so that opening the door is not obstructed by snow or ice.

Application

GP4.1 applies to a building constructed in an *alpine area* and overrules other provisions of the BCA.

GP4.2

A building in an *alpine area* containing external trafficable structures forming part of the means of egress must be constructed so that those structures remain, as far as practicable, useable under snow conditions.

Application

GP4.2 applies to a building constructed in an *alpine area* and overrules other provisions of the BCA.

GP4.3

A building in an *alpine area* must be constructed so that snow or ice is not shed from the building onto the allotment, any adjoining allotment, road or public space in a location or manner that will—

- (a) obstruct a means of egress from any building to a road or *open space*; or
- (b) otherwise endanger people.

Application

GP4.3 applies to a building constructed in an *alpine area* and overrules other provisions of the BCA.

GP4.4

A building in an *alpine area* must have a *fire safety system* installed to—

- (a) facilitate fire-fighting operations; and
- (b) alert occupants in the event of an emergency.

Application

GP4.4 applies to a building constructed in an *alpine area* and overrules other provisions of the BCA.

PART G4 CONSTRUCTION IN ALPINE AREAS

Deemed-to-Satisfy Provisions

G4.0 Deemed-to-Satisfy Provisions

- (a) Where a *Deemed-to-Satisfy Solution* is proposed, *Performance Requirements GP4.1 to GP4.4* are satisfied by complying with **G4.1** to **G4.9**.
- (b) Where a *Performance Solution* is proposed, the relevant *Performance Requirements* must be determined in accordance with **A0.7**.

G4.1 Application of Part

- (a) The *Deemed-to-Satisfy Provisions* of this Part apply to any building constructed in an *alpine area* in addition to other *Deemed-to-Satisfy Provisions* of the BCA.
- (b) Where any *Deemed-to-Satisfy Provisions* are in conflict, the provisions of this Part take precedence.

G4.2 * * * * *

This clause has deliberately been left blank.

G4.3 External doorways

- (a) A door fitted to an external doorway which may be subject to the build-up of snow must—
 - (i) only be capable of opening inwards; and
 - (ii) be marked “OPEN INWARDS” on the inside face of the door in letters not less than 75 mm high and in a colour contrasting with that of the background; and
 - (iii) if it serves a corridor or stairway, be positioned in an alcove or recess with—
 - (A) no horizontal dimension less than twice the width of the door; and
 - (B) the door positioned to open against a wall such that the distance from any part of its swing to the nearest point of entry of the stairway or corridor is not less than the width of the door.
- (b) Every threshold of a *required exit* doorway must be located so that snow or ice is not deposited in a manner that will obstruct means of egress from that doorway.

G4.4 Emergency lighting

In a Class 2, 3, 5, 6, 7, 8 or 9 building or Class 4 part of a building, a system of emergency lighting must be installed in accordance with the *Deemed-to-Satisfy Provisions* of **Part E4**—

- (a) in every stairway (other than those within a *sole-occupancy unit* in a Class 2 or 3 building or Class 4 part of a building); and
- (b) in every *public corridor* or the like leading to an *exit*; and
- (c) externally above every doorway opening to a road or *open space*; and

Deemed-to-Satisfy Provisions

- (d) in any *storey* of the building if illumination sufficient for safe egress will not be available under conditions of emergency.

G4.5 External ramps

An external ramp serving as an *exit* must—

- (a) where a ramp is also serving as an *accessible* ramp under **Part D3**, be in accordance with AS 1428.1; or
- (b) in any other case, have a gradient not steeper than 1:12.

G4.6 Discharge of exits

A building in an *alpine area* must be so constructed that—

- (a) if any part of an *external wall* is more than 3.6 m above the natural ground level — the distance of that part from a boundary other than a road alignment is not less than 2.5 m plus 100 mm for each 300 mm or part by which that part of the wall exceeds a height of 3.6 m; and
- (b) if an *exit* doorway discharges into a court between wings of a building — the wings are not less than 6 m apart; and
- (c) if an *exit* doorway is opposite a barrier which is more than 900 mm above the threshold of the doorway — the threshold is at a distance from that barrier of not less than twice the height of the barrier or 6 m, whichever is the lesser.

G4.7 External trafficable structures

External stairways, ramps, access bridges or other trafficable structures must have—

- (a) a floor surface that consists of steel mesh or other suitable material if it is used as a means of egress; and
- (b) any *required* barrier constructed so that its sides are not less than 75% open.

G4.8 Fire-fighting services and equipment

- (a) Every Class 2, 3, 5, 6, 7, 8 or 9 building must have—
- (i) a manually operated fire alarm system with call-points complying with AS 1670.1; and
- (ii) fire hydrants installed in accordance with **E1.3(b)**; and
- (iii) fire hose reels installed in accordance with **E1.4(b)** to **(g)**, except that—
- (A) in a Class 2 or 3 building—
- (aa) for the purpose of **E1.4(b)**, a *sole-occupancy unit* is considered to be a *fire compartment*; and
- (bb) for the purpose of **E1.4(c)(ii)**, a *sole-occupancy unit* may be served by a single fire hose reel located at the level of egress from that *sole-occupancy unit*; and
- (cc) for the purpose of **E1.4(f)**, a fire hose may pass through a doorway in bounding construction referred to in **C3.11**.

Deemed-to-Satisfy Provisions

- (b) The requirements of (a)(iii) do not apply to a Class 8 *electricity network substation*.

G4.9 Fire orders

Every Class 2, 3 or 9 building must display a notice clearly marked "FIRE ORDERS" in suitable locations near the main entrance and on each *storey*, explaining—

- (a) the method of operation of the fire alarm system and the location of all call-points; and
- (b) the location and methods of operation of all fire-fighting equipment; and
- (c) the location of all *exits*; and
- (d) the procedure for evacuation of the building.

PART **G5**

CONSTRUCTION IN BUSHFIRE PRONE
AREAS

PERFORMANCE REQUIREMENTS

NSW GP5.1

Qld GP5.1

Tas GP5.1

GP5.1

A building that is constructed in a *designated bushfire prone area* must, to the degree necessary, be designed and constructed to reduce the risk of ignition from a bushfire, appropriate to the—

- (a) potential for ignition caused by burning embers, radiant heat or flame generated by a bushfire; and
- (b) intensity of the bushfire attack on the building.

Application

GP5.1 only applies to—

- (a) a Class 2 or 3 building; or
- (b) a Class 10a building or deck associated with a Class 2 or 3 building, located in a *designated bushfire prone area*.

PART G5

CONSTRUCTION IN BUSHFIRE PRONE AREAS

Deemed-to-Satisfy Provisions

G5.0 Deemed-to-Satisfy Provisions

- (a) Where a *Deemed-to-Satisfy Solution* is proposed, *Performance Requirements GP5.1* is satisfied by complying with **G5.1** and **G5.2**.
- (b) Where a *Performance Solution* is proposed, the relevant *Performance Requirements* must be determined in accordance with **A0.7**.

G5.1 Application of Part

SA G5.1

Qld G5.1

The *Deemed-to-Satisfy Provisions* of this Part apply to—

- (a) a Class 2 or 3 building; or
- (b) a Class 10a building or deck associated with a Class 2 or 3 building, located in a *designated bushfire prone area*.

G5.2 Protection

NSW G5.2

SA G5.2

In a *designated bushfire prone area*—

- (a) a Class 2 or 3 building; or
- (b) a Class 10a building or deck associated with a Class 2 or 3 building, must comply with AS 3959.

SA G5.3

Tas G5.3 and Tas G5.4

SPECIAL USE BUILDINGS

- H1 Class 9b Buildings**
- H2 Public Transport Buildings**
- H3 Farm Buildings and Farm Sheds**

SECTION H CONTENTS

SECTION H SPECIAL USE BUILDINGS

Part H1 Class 9b Buildings

- H1.1 Application of Part
- H1.2 Separation
- H1.3 Proscenium wall construction
- H1.4 Seating area
- H1.5 Exits from theatre stages
- H1.6 Access to platforms and lofts
- H1.7 Aisle lights
- Specification H1.3 Construction of Theatres with Proscenium Walls

Part H2 Public Transport Buildings

- H2.1 Application of Part
- H2.2 Accessways
- H2.3 Ramps
- H2.4 Handrails and grabrails
- H2.5 Doorways and doors
- H2.6 Lifts
- H2.7 Stairways
- H2.8 Unisex accessible toilet
- H2.9 Location of accessible toilets
- H2.10 Symbols and signs
- H2.11 Tactile ground surface indicators
- H2.12 Lighting
- H2.13 Hearing augmentation
- H2.14 Emergency warning systems
- H2.15 Controls

Part H3 Farm Buildings and Farm Sheds

- H3.1 Application of Part
- H3.2 Fire resistance and separation
- H3.3 Provision for escape
- H3.4 Construction of exits
- H3.5 Fixed platforms, walkways, stairways and ladders
- H3.6 Thresholds
- H3.7 Swinging doors
- H3.8 Fire fighting equipment
- H3.9 Fire hydrants and water supplies
- H3.10 Fire hose reels
- H3.11 Portable fire extinguishers
- H3.12 Emergency lighting requirements
- H3.13 Exit signs
- H3.14 Directions signs
- H3.15 Design and operation of exit signs

ARCHIVED
SPECIAL USE BUILDINGS

H3.16 Sanitary facilities
H3.17 Height of rooms and other spaces
H3.18 Artificial lighting

PART H1 CLASS 9b BUILDINGS

Deemed-to-Satisfy Provisions

Note.

Part H1 contains *Deemed-to-Satisfy Provisions* additional to those contained in Sections **C**, **D** and **E** for Class 9b buildings.

H1.1 Application of Part

NSW H1.1

- (a) The *Deemed-to-Satisfy Provisions* of this Part apply to every enclosed Class 9b building or part of a building which—
- (i) is a *school* assembly, church or community hall with a *stage* and any *backstage* area with a total *floor area* of more than 300 m²; or
 - (ii) otherwise, has a *stage* and any *backstage* area with a total *floor area* of more than 200 m²; or
 - (iii) has a *stage* with an associated rigging loft.
- (b) Notwithstanding (a)—
- (i) **H1.4** applies to every open or enclosed Class 9b building; and
 - (ii) **H1.7** applies to every enclosed Class 9b building.

H1.2 Separation

A theatre, public hall or the like must—

- (a) have a sprinkler system complying with **Specification E1.5**; or
- (b) have the *stage*, *backstage* area and accessible under-*stage* area separated from the audience by a proscenium wall in accordance with **H1.3**.

H1.3 Proscenium wall construction

A proscenium wall must comply with **Specification H1.3**.

H1.4 Seating area

In a seating area—

- (a) the gradient of the floor surface must not be steeper than 1 in 8, or the floor must be stepped so that—
 - (i) a line joining the nosings of consecutive steps does not exceed an angle of 30° to the horizontal; and
 - (ii) the height of each step in the stepped floor is not more than 600 mm; and
 - (iii) the height of any opening in such a step is not more than 125 mm; and
- (b) if an aisle divides the stepped floor and the difference in level between any 2 consecutive steps—

Deemed-to-Satisfy Provisions

- (i) exceeds 230 mm but not 400 mm — an intermediate step must be provided in the aisle; and
 - (ii) exceeds 400 mm — 2 equally spaced intermediate steps must be provided in the aisle; and
 - (iii) the going of intermediate steps must be not less than 270 mm and such as to provide as nearly as practicable equal treads throughout the length of the aisle; and
- (c) the clearance between rows of fixed seats used for viewing performing arts, sport or recreational activities must be not less than—
- (i) 300 mm if the distance to an aisle is not more than 3.5 m; or
 - (ii) 500 mm if the distance to an aisle is more than 3.5 m.

H1.5 Exits from stages

- (a) The path of travel to an *exit* from a *stage* or performing area must not pass through the proscenium wall if the *stage* area is separated from the audience area with a proscenium wall.
- (b) *Required exits* from *backstage* and under-*stage* areas must be independent of those provided for the audience area.

H1.6 Access to platforms and lofts

A stairway that provides access to a service platform, rigging loft, or the like, must comply with AS 1657.

H1.7 Aisle lights

In every enclosed Class 9b building, where in any part of the auditorium, the general lighting is dimmed or extinguished during public occupation and the floor is stepped or is inclined at a slope steeper than 1 in 12, aisle lights must be provided to illuminate the full length of the aisle and tread of each step.

PART H2 PUBLIC TRANSPORT BUILDINGS

Deemed-to-Satisfy Provisions

Note.

Part H2 contains *Deemed-to-Satisfy Provisions* for Class 9b and Class 10 public transport buildings additional to those contained in **Parts D3, E3** and **F2** that apply to public transport buildings.

H2.1 Application of Part

- (a) The *Deemed-to-Satisfy Provisions* of this Part apply to the passenger use areas of a Class 9b or Class 10 building used for public transport.
- (b) The *Deemed-to-Satisfy Provisions* of this Part take precedence where there is a difference to the *Deemed-to-Satisfy Provisions* of **Parts D3, E3** and **F2**.
- (c) For an airport that does not accept regular public transport services, as defined in the Disability Standards for Accessible Public Transport 2002, only **H2.8, H2.9, H2.10, H2.11, H2.12** and **H2.13** of this Part apply.
- (d) **A3.3(a)(i)** does not apply to this Part.

H2.2 Accessways

- (a) An *accessway* must comply with AS 1428.2.
- (b) If an *accessway* branches into 2 or more parallel tracks—
 - (i) the ends of each track must be on the main pedestrian traffic routes; and
 - (ii) the parallel tracks must have equal convenience and be located as close as practicable to the main pedestrian branch.
- (c) The minimum unobstructed width of an *accessway* must be 1.2 m, except that—
 - (i) the minimum unobstructed width of a moving walkway forming part of an *accessway* may be not less than 850 mm; and
 - (ii) the minimum unobstructed width of a doorway in an *accessway* may be not less than 850 mm.
- (d) Poles, columns, stanchions, bollards and fixtures must not project into an *accessway*.
- (e) Obstacles that abut an *accessway* must have a *luminance contrast* with a background of not less than 30%.
- (f) Manoeuvring areas that allow a 180 degree wheelchair turn must comply with clause 6.2 of AS 1428.2.
- (g) A passing area must be provided at least every 6 m along any two-way *accessway* that is less than 1 800 mm wide.
- (h) Ground and floor surfaces must comply with clause 9 of AS 1428.2 and AS 1428.1. Supplement 1 provides criteria for the selection of floor surfaces.
- (i) The requirements of **D3.3(c)(ii)** do not apply to Class 9b or Class 10 public transport buildings.

Deemed-to-Satisfy Provisions

H2.3 Ramps

- (a) A ramp forming part of an [accessway](#) must comply with clause 8 of AS 1428.2.
- (b) The requirements of [D3.11\(a\)](#) do not apply to Class 9b or Class 10 public transport buildings.

H2.4 Handrails and grabrails

- (a) A handrail must comply with clause 10.1 of AS 1428.2.
- (b) Handrails must be placed along an [accessway](#) wherever passengers are likely to require additional support or passive guidance.
- (c) A grabrail must comply with clause 10.2 of AS 1428.2.
- (d) A grabrail or handrail must be provided at fixed locations where passengers are required to pay fares.

H2.5 Doorways and doors

Doorways and doors must comply with clause 11 (except clause 11.5.2) of AS 1428.2.

H2.6 Lifts

Lift facilities must comply with AS 1735.12.

H2.7 Stairways

Stairs must comply with—

- (a) clause 9.1 of AS 1428.1, including the notes; and
- (b) clause 9.2 of AS 1428.1; and
- (c) clause 13.2, 13.3 and Figures 8 and 9 of AS 1428.2.

H2.8 Unisex accessible toilet

If toilets are provided, there must be at least one unisex [accessible](#) toilet without an airlock that complies with AS 1428.1 clause 10, sanitary facilities.

H2.9 Location of accessible toilets

[Accessible](#) toilets must be in the same location as other toilets.

H2.10 Symbols and signs

- (a) The international symbols for accessibility and deafness in accordance with clauses 14.2 and 14.3 of AS 1428.1 must be used to identify an [accessway](#) and which facilities and boarding points are [accessible](#).
- (b) Signs must be placed in accordance with clause 17.4 of AS 1428.2.
- (c) The size of accessibility symbols must comply with Table 1 of AS 1428.2.

Deemed-to-Satisfy Provisions

- (d) The symbol for accessibility must incorporate directional arrows and words or, if possible, pictograms, to show passengers the way to [accessible](#) facilities such as toilets.
- (e) Signs must comply with clause 17.1 and Figure 30 of AS 1428.2.
- (f) If a sign incorporates raised lettering or symbols, they must be at least 0.8 mm above the surface of the sign.
- (g) If an operator or provider supplements a notice with braille characters, they must be placed to the left of the raised characters.

H2.11 Tactile ground surface indicators

Tactile ground surface indicators must be installed in accordance with AS 1428.4 on an [accessway](#) and must indicate changes of direction in accordance with clause 18.1 of AS 1428.2.

H2.12 Lighting

Any lighting provided must comply with minimum levels of maintenance illumination for various situations shown in the notes to clause 19.1 of AS 1428.2.

H2.13 Hearing augmentation

If a public address system is installed, it must comply with clause 21.1 of AS 1428.2.

H2.14 Emergency warning systems

- (a) If an emergency warning system is installed, it must comply with clause 18.2.1, 18.2.2 and 18.2.3 of AS 1428.2.
- (b) In the event of an emergency, provision must be made for people with vision impairment to locate the [exit](#) path.

H2.15 Controls

Controls must comply with clause 11 of AS 1428.1.

PART H3 FARM BUILDINGS AND FARM SHEDS

SA Part H3

Deemed-to-Satisfy Provisions

Note.

Part H3 contains *Deemed-to-Satisfy Provisions* additional to those contained in Sections **C**, **D**, **E** and **F** for *farm buildings* and *farm sheds*.

H3.1 Application of Part

- (a) The *Deemed-to-Satisfy Provisions* of this Part apply to *farm buildings* and *farm sheds*.
- (b) The *Deemed-to-Satisfy Provisions* of this Part take precedence where there is a difference to the *Deemed-to-Satisfy Provisions* of Sections **C**, **D**, **E** and **F**.
- (c) **H3.1** to **H3.5**, **H3.8** and **H3.11** to **H3.18** apply to a *farm shed*.
- (d) **H3.1**, **H3.3**, **H3.5** to **H3.7**, **H3.9** to **H3.12**, **H3.14**, **H3.15** and **H3.18** apply to a *farm building*.

H3.2 Fire resistance and separation

A *farm shed* need not comply with the provisions of Parts **C1**, **C2** and **C3**, except for **C1.11**, if it is separated from any other building or allotment boundary by a distance of not less than 6 m.

H3.3 Provision for escape

- (a) Except for **D1.2**, **D1.4** to **D1.6**, **D1.9**, **D1.10(a)**, **D1.13(c)**, **D1.14** and **D1.15**, the *Deemed-to-Satisfy Provisions* of **D1** do not apply to a *farm shed*.
- (b) An *open space* adjacent to a *farm building* or a *farm shed* need not be directly connected with a public road.

H3.4 Construction of exits

Except for **D2.13**, **D2.14**, **D2.16**, **D2.17** and **D2.24**, the *Deemed-to-Satisfy Provisions* of **Part D2** do not apply to a *farm shed*.

H3.5 Fixed platforms, walkways, stairways and ladders

A fixed platform, stairway, ladder and any going and riser, landing, handrail or barrier may comply with AS 1657 in lieu of **D2.13**, **D2.14**, **D2.16** and **D2.17** where it serves a *farm building* or a *farm shed*.

H3.6 Thresholds

The threshold of a doorway that serves an area not *required* to be *accessible* by **D3.1** in a *farm building* need not comply with **D2.15** where the door sill is not more than 700 mm above the finished surface of the ground, floor or the like, to which the doorway opens.

Deemed-to-Satisfy Provisions

H3.7 Swinging doors

A swinging door in a *required exit* or forming part of a *required exit* need not swing in the direction of egress if it serves a *farm building*.

H3.8 Fire fighting equipment

The *Deemed-to-Satisfy Provisions* of E1 do not apply to a *farm shed*.

H3.9 Fire hydrants and water supplies

- (a) A *farm building*—
- (i) with a total *floor area* greater than 500 m²; and
 - (ii) located where a *fire brigade* is available to attend a building fire,
- must be—
- (iii) provided with a fire hydrant system installed in accordance with AS 2419.1, except reference to '4 hours' water supply in clause 4.2 is replaced with '2 hours'; or
 - (iv) located on the same allotment as an access point to a water supply which—
 - (A) has a minimum total capacity of 144 000 litres; and
 - (B) is situated so as to enable emergency services vehicles access to within 4 m; and
 - (C) is located within 60 m of the building and not more than 90 m from any part of the building.
- (b) For the purposes of (a)(iv), water supply for a *farm building* must consist of one or any number of the following:
- (i) A water storage tank.
 - (ii) A dam.
 - (iii) A reservoir.
 - (iv) A river.
 - (v) A lake.
 - (vi) A bore.
 - (vii) A sea.
- (c) If the whole or part of the water supply referred to in (a)(iv) is contained in a water storage tank, it must be—
- (i) located not less than 10 m from the building; and
 - (ii) fitted with at least one small bore suction connection and one large bore suction connection where—
 - (A) each suction connection is located in a position so as to enable emergency service vehicles access to within 4 m; and
 - (B) the suction connections are located not less than 10 m from the building; and
 - (C) 'small bore suction connection' and 'large bore suction connection' have the meanings contained in AS 2419.1.

Deemed-to-Satisfy Provisions

H3.10 Fire hose reels

A fire hose reel system need not be provided to serve a *farm building* where portable fire extinguishers are installed in accordance with H3.11.

H3.11 Portable fire extinguishers

- (a) A *farm building* not provided with a fire hose reel system in accordance with E1.4 must be provided with—
 - (i) one portable fire extinguisher rated at not less than 5ABE in each room containing flammable materials or electrical equipment; and
 - (ii) one portable fire extinguisher rated at not less than 4A60BE adjacent to every *required exit* door; and
 - (iii) location signs complying with clauses 3.3 to 3.9 of AS 2444 above each *required* portable fire extinguisher.
- (b) A *farm shed* must be provided with not less than one portable fire extinguisher for every 500 m² of *floor area* or part thereof, distributed as evenly as practicable throughout the building.
- (c) A portable fire extinguisher required by (b) must be—
 - (i) of ABE type; and
 - (ii) not less than 4.5 kg in size; and
 - (iii) installed in accordance with Section 3 of AS 2444.

H3.12 Emergency lighting requirements

- (a) An emergency lighting system need not be installed in a *farm building*—
 - (i) with no artificial lighting as permitted by H3.18; or
 - (ii) with artificial lighting where, if that lighting fails due to an emergency, automatic power supply to the building is provided by a fuel-driven generator.
- (b) An emergency lighting system need not be installed in a *farm shed*.

H3.13 Exit signs

An *exit* serving a *farm shed* need not be provided with an *exit* sign where the *exit* is a permanent opening not less than 2 m wide.

H3.14 Direction signs

In a *farm building* or a *farm shed*, if an *exit* is not readily apparent to persons occupying or visiting the building, *exit* signs complying with H3.15 must be installed in appropriate positions in corridors, hallways, lobbies, and the like, indicating the direction to a *required exit*.

H3.15 Design and operation of exit signs

- (a) In a *farm building*, each *required exit* sign provided under E4.5 and H3.14 need not comply with E4.8 if—

Deemed-to-Satisfy Provisions

- (i) the use of illuminated *exit* signs may adversely impact the behaviour or welfare of animals being kept in the building; and
 - (ii) *non-illuminated exit signs* are installed in accordance with clauses 6.5, 6.6, 6.8 and 6.9 of AS 2293.1.
- (b) In a *farm shed*, each *required exit* sign provided under **E4.5** and **H3.14** need not comply with **E4.8** if *exit* signs complying with Section 6 and Appendix D of AS 2293.1 are provided except—
- (i) the *exit* sign need not be illuminated; and
 - (ii) the maximum viewing distance in clause 6.6 of AS 2293.1 must be not more than 24 m; and
 - (iii) clauses 6.3 and 6.7 of AS 2293.1 do not apply.

H3.16 Sanitary facilities

F2.3 does not apply to a *farm shed*.

H3.17 Height of rooms and other spaces

F3.1 does not apply to a *farm shed* which has ceiling heights not less than—

- (a) in a room, corridor, passageway or the like — 2.1 m; and
- (b) in a room or space with a sloping ceiling or projections — a height of not less than 2.1 m for at least two-thirds of the *floor area* of the room or space, and when calculating the *floor area* of the room or space, any part that has a ceiling height of less than 1.5 m is not included; and
- (c) in a stairway, ramp, landing or the like — 2.0 m measured vertically above the nosing line of stairway treads or the floor surface of the ramp, landing or the like.

H3.18 Artificial lighting

- (a) An artificial lighting system need not be provided in a *farm building* where—
 - (i) occupants are provided with visibility sufficient for safe movement through suitable alternative means; and
 - (ii) the use of artificial lighting could adversely affect the function of the building including, but not limited to—
 - (A) the behaviour or welfare of animals being kept in the building; or
 - (B) the cultivating or propagating of plants or fungi.
- (b) An artificial lighting system need not be provided in a *farm shed*.

SPECIFICATION H1.3 CONSTRUCTION OF PROSCENIUM WALLS

Deemed-to-Satisfy Provisions

1. Scope

This Specification contains the requirements for the construction of proscenium walls for theatres, public halls, or the like.

2. Separation of stage areas, etc

- (a) Dressing rooms, scene docks, property rooms, workshops, associated store rooms and other ancillary areas must be—
 - (i) located on the *stage* side of the proscenium wall; and
 - (ii) separated from corridors and the like by construction having an FRL of not less than 60/60/60, and if of *lightweight construction*, complying with **Specification C1.8**.
- (b) The *stage* and *backstage* must be separated from other parts of the building other than the audience seating area by construction having an FRL of not less than 60/60/60, and if of *lightweight construction*, complying with **Specification C1.8**.
- (c) Any doorway in the construction referred to in paragraphs (a) and (b) must be protected by a *self-closing* - /60/30 fire door.

3. Proscenium wall construction

A proscenium wall must—

- (a) extend to the underside of the roof covering or the underside of the structural floor next above; and
- (b) have an FRL of not less than 60/60/60, and if of *lightweight construction*, comply with **Specification C1.8**.

4. Combustible materials not to cross proscenium wall

Timber purlins or other *combustible* material must not pass through or cross any proscenium wall.

5. Protection of openings in proscenium wall

Every opening in a proscenium wall must be protected—

- (a) at the principal opening, by a curtain in accordance with **Clause 6** which is—
 - (i) capable of closing the proscenium opening within 35 seconds either by gravity slide or motor assisted mechanisms; and
 - (ii) operated by a system of *automatic* heat activated devices, manually operated devices or push button emergency devices; and

Deemed-to-Satisfy Provisions

- (iii) able to be operated from either the *stage* side or the audience side of the curtain; and
- (b) at any doorway in the wall, by a *self-closing* - /60/30 fire door.

6. Proscenium curtains

A curtain *required* by **Clause 5** must be—

- (a) a fire safety curtain—
 - (i) made of *non-combustible* material; and
 - (ii) capable of withstanding a pressure differential of 0.5 kPa over its entire surface area; and
 - (iii) so fitted that when fully lowered it inhibits the penetration of smoke around the perimeter of the opening, from the *stage*; or
- (b) a curtain—
 - (i) having *fire hazard properties* complying with **Specification C1.10**; and
 - (ii) protected by a deluge system of open sprinklers installed along the full width of the curtain.

SECTION 

I1 *****

I2 *****

SECTION I CONTENTS

SECTION I MAINTENANCE

Part I1 *****

Part I2 *****

PART I1

* * * * *

The content of **Part I1**, which existed in BCA 2013, has been removed. The Part number **Part I1** has been retained so as not to change the numbering of the current BCA from that of BCA 2013.

PART 12

* * * * *

The content of **Part 12**, which existed in BCA 2013, has been removed. The Part number **Part 12** has been retained so as not to change the numbering of the current BCA from that of BCA 2013.

ENERGY EFFICIENCY

- J0** **Energy Efficiency**
- J1** **Building Fabric**
- J2** **Glazing**
- J3** **Building Sealing**
- J4** *** * * * ***
- J5** **Air-conditioning and Ventilation Systems**
- J6** **Artificial Lighting and Power**
- J7** **Heated Water Supply and Swimming Pool and Spa
Pool Plant**
- J8** **Facilities for Energy Monitoring**

SECTION J CONTENTS

SECTION J ENERGY EFFICIENCY

Section J Energy Efficiency

Performance Requirements JP1 - JP3
Verification Methods JV1 - JV3
Specification JV Annual energy consumption criteria

Part J0 Energy Efficiency

J0.0 Deemed-to-Satisfy Provisions
J0.1 Application of Section J
J0.2 Heating and cooling loads of sole-occupancy units of a Class 2 building or a Class 4 Part
J0.3 Ceiling fans

Part J1 Building Fabric

J1.0 Deemed-to-Satisfy Provisions
J1.1 Application of Part
J1.2 Thermal construction — general
J1.3 Roof and ceiling construction
J1.4 Roof Lights
J1.5 Walls
J1.6 Floors

Part J2 Glazing

J2.0 Deemed-to-Satisfy Provisions
J2.1 Application of Part
J2.2 * * * * *
J2.3 * * * * *
J2.4 Glazing
J2.5 Shading

Part J3 Building Sealing

J3.0 Deemed-to-Satisfy Provisions
J3.1 Application of Part
J3.2 Chimneys and flues
J3.3 Roof lights
J3.4 Windows and doors
J3.5 Exhaust fans
J3.6 Construction of roofs, walls and floors
J3.7 Evaporative coolers

Part J4 * * * * *

Part J5 Air-Conditioning and Ventilation Systems

- J5.0 Deemed-to-Satisfy Provisions
- J5.1 Application of Part
- J5.2 Air-conditioning systems
- J5.3 Mechanical ventilation systems
- J5.4 Miscellaneous exhaust systems

Part J6 Artificial Lighting and Power

- J6.0 Deemed-to-Satisfy Provisions
- J6.1 Application of Part
- J6.2 Artificial lighting
- J6.3 Interior artificial lighting and power control
- J6.4 Interior decorative and display lighting
- J6.5 Artificial lighting around the perimeter of a building
- J6.6 Boiling water and chilled water storage units

Part J7 Heated Water Supply and Swimming Pool and Spa Pool Plant

- J7.0 Deemed-to-Satisfy Provisions
- J7.1 * * * * *
- J7.2 Heated water supply
- J7.3 Swimming pool heating and pumping
- J7.4 Spa pool heating and pumping

Part J8 Facilities for Energy Monitoring

- J8.0 Deemed-to-Satisfy Provisions
- J8.1 Application of Part
- J8.2 * * * * *
- J8.3 Facilities for energy monitoring

Specifications

- Specification J1.2 Material Properties
- Specification J1.3 Roof and Ceiling Construction
- Specification J1.5 Wall Construction
- Specification J1.6 Floor Construction
- Specification J5.2a Fans
- Specification J5.2b Ductwork Insulation and Sealing
- Specification J5.2c Piping, Vessel, Heat Exchanger and Tank Insulation
- Specification J5.2d Space Heating
- Specification J5.2e Energy Efficiency Ratios
- Specification J6 Lighting and Power Control Devices

SECTION J ENERGY EFFICIENCY

NSW Section J

NT Section J

Qld Section J

PERFORMANCE REQUIREMENTS

JP1

A building, including its *services*, must have, to the degree necessary, features that facilitate the efficient use of energy appropriate to—

- (a) the function and use of the building and *services*; and
- (b) the internal environment; and
- (c) the geographic location of the building; and
- (d) the effects of nearby permanent features such as topography, structures and buildings; and
- (e) solar radiation being—
 - (i) utilised for heating; and
 - (ii) controlled to minimise energy for cooling; and
- (f) the sealing of the building *envelope* against air leakage; and
- (g) the utilisation of air movement to assist heating and cooling; and
- (h) the energy source of the *services*.

JP2 * * * * *

This clause has deliberately been left blank.

JP3

Heating such as for a *conditioned space* must, to the degree necessary, obtain energy from—

- (a) a source that has a greenhouse gas intensity that does not exceed 100 g CO₂-e/MJ of thermal energy load; or
- (b) an on-site *renewable energy* source; or
- (c) another process as reclaimed energy.

VERIFICATION METHODS

JV1 * * * * *

This clause has deliberately been left blank.

JV2 * * * * *

This clause has deliberately been left blank.

JV3 Verification using a reference building

- (a) For a Class 3, 5, 6, 7, 8 or 9 building, compliance with **JP1** is verified when it is determined that the *annual energy consumption* of the proposed building with its *services* is not more than the *annual energy consumption* of a *reference building* when—
 - (i) the proposed building is modelled with the proposed *services*; and
 - (ii) the proposed building is modelled with the same *services* as the *reference building*.
- (b) The *annual energy consumption* of the proposed building in (a) may be reduced by the amount of energy obtained from—
 - (i) an on-site *renewable energy* source; or
 - (ii) another process as reclaimed energy.
- (c) The *annual energy consumption* calculation method must comply with the ABCB Protocol for Building Energy Analysis Software.
- (d) The *annual energy consumption* in (a) must be calculated—
 - (i) for the *reference building*, using—
 - (A) the *Deemed-to-Satisfy Provisions* for **Parts J1** to **J7** but including only the minimum amount of mechanical ventilation *required* by **Part F4**; and
 - (B) a solar absorptance of 0.6 for *external walls* and 0.7 for roofs; and
 - (C) the maximum *illumination power density* without any increase for a control device *illumination power density* adjustment factor; and
 - (D) *air-conditioning* with the *conditioned space* temperature within the range of 18° CDB to 26° CDB for 98% of the plant operation time; and
 - (E) the profiles for occupancy, *air-conditioning*, lighting and internal heat gains from people, hot meals, appliances, equipment and heated water supply systems—
 - (aa) of the actual building—
 - (AA) if the operating hours per year are not less than 2 500; or
 - (BB) if the daily operating profiles are not listed in **Specification JV**;
or
 - (bb) of **Specification JV**; and
 - (F) infiltration values—

- (aa) for a perimeter zone of depth equal to the floor-to-ceiling height, when pressurising plant is operating, 1.0 air change per hour; and
- (bb) for the whole building, when pressurising plant is not operating, 1.5 air change per hour; and
- (ii) for both the proposed building and the *reference building* using the same—
 - (A) *annual energy consumption* calculation method; and
 - (B) location, being either the location where the building is to be constructed if appropriate climatic data is available, or the nearest location with similar climatic conditions, for which climatic data is available; and
 - (C) adjacent structures and features; and
 - (D) environmental conditions such as ground reflectivity, sky and ground form factors, temperature of external bounding surfaces, air velocities across external surfaces and the like; and
 - (E) orientation; and
 - (F) building form, including—
 - (aa) the roof geometry; and
 - (bb) the floor plan; and
 - (cc) the number of *storeys*; and
 - (dd) the ground to lowest floor arrangements; and
 - (ee) the size and location of *glazing*; and
 - (G) external doors; and
 - (H) testing standards including for insulation, *glazing*, water heater and package *air-conditioning* equipment; and
 - (I) thermal resistance of air films including any adjustment factors, moisture content of materials and the like; and
 - (J) dimensions of external, internal and separating walls; and
 - (K) surface density of *envelope* walls over 220 kg/m²; and
 - (L) quality of insulation installation; and
 - (M) assumptions and means of calculating the temperature difference across *air-conditioning* zone boundaries; and
 - (N) floor coverings and furniture and fittings density; and
 - (O) internal shading devices, their colour and their criteria for operation; and
 - (P) number, sizes and floors served by lifts and escalators; and
 - (Q) range and type of *services* and energy sources other than energy generated on-site from sources that do not emit greenhouse gases such as solar and wind power; and
 - (R) internal artificial lighting levels; and
 - (S) internal heat gains including people, lighting, appliances, meals and other electric power loads; and
 - (T) *air-conditioning* system configuration and zones; and

-
- (U) daily and annual profiles of the—
 - (aa) building occupancy; and
 - (bb) operation of *services*; and
 - (V) range of internal temperatures and plant operating times; and
 - (W) supply heated water temperature and rate of use; and
 - (X) infiltration values unless there are specific additional sealing provisions or pressure testing to be undertaken; and
 - (Y) unit capacity and sequencing for water heaters, refrigeration chillers and heat rejection equipment such as cooling towers; and
 - (Z) metabolic rate for people; and
 - (iii) for the proposed building using a solar absorptance for the roof and walls 0.05 higher than that proposed; and
 - (e) Where the *annual energy consumption* of the heated water supply or the lifts and escalators are the same in the proposed building and the *reference building*, they may be omitted from the calculation of both the proposed building and the *reference building*.
 - (f) A lift in a building with more than one classification may be proportioned according to the number of *storeys* of the part for which the *annual energy consumption* is being calculated.
 - (g) The design must include—
 - (i) the ability to achieve all the criteria used in the *annual energy consumption* calculation method such as having an automatic operation controlling device capable of turning lighting, and *air-conditioning* plant on and off in accordance with the occupancy and operating profiles used; and
 - (ii) compliance with—
 - (A) **J1.2** for general thermal construction; and
 - (B) **J1.3(c)** for compensation for a loss of ceiling insulation; and
 - (C) **J1.6(a)(ii)**, **J1.6(c)**, **J1.6(d)** and **J1.6(e)** for floor edge insulation; and
 - (D) BS 7190 for testing a water heater; and
 - (E) AS/NZS 3823.1.2 at test condition T1 for testing package *air-conditioning* equipment not less than 65 kW_r; and
 - (F) AHRI 550/590 for testing a refrigeration chiller; and
 - (G) **Part J8** for facilities for energy monitoring.

SPECIFICATION **JV**

ANNUAL ENERGY CONSUMPTION
CRITERIA

1. Scope

This Specification contains the requirements for calculating the *annual energy consumption of services* in a building.

2. Annual energy consumption of services

The *annual energy consumption*—

- (a) for *air-conditioning*, must be calculated on the basis of—
 - (i) the daily occupancy and operation profiles in **Tables 2a to 2g**; and
 - (ii) plant serving public areas of a Class 3 or 9c building being available on thermostatic control 24 hours per day; and
 - (iii) the internal heat gains in a building—
 - (A) from occupants and hot meals, in accordance with one of the options in **Table 2j**; and
 - (B) from appliances and equipment, in accordance with **Table 2h**; and
 - (C) from artificial lighting, that is calculated in **(b)**; and
- (b) for artificial lighting, must be calculated on the basis of the proposed level of artificial lighting in the building with the daily profile in **Tables 2a to 2g**; and
- (c) for heated water supply, must be calculated on the basis of the consumption rates of **Table 2i**.

Table 2a OCCUPANCY AND OPERATION PROFILES OF A CLASS 3 OR 9c BUILDING

Time period (local standard time)	Occupancy		Artificial lighting	<i>Air-conditioning</i>	
	Monday to Friday	Saturday, Sunday and holidays		Monday to Friday	Saturday, Sunday and holidays
12:00am to 1:00am	85%	85%	5%	On	On
1:00am to 2:00am	85%	85%	5%	On	On
2:00am to 3:00am	85%	85%	5%	On	On
3:00am to 4:00am	85%	85%	5%	On	On
4:00am to 5:00am	85%	85%	5%	On	On
5:00am to 6:00am	85%	85%	25%	On	On
6:00am to 7:00am	85%	85%	80%	On	On
7:00am to 8:00am	80%	85%	80%	On	On
8:00am to 9:00am	50%	50%	50%	On	On
9:00am to 10:00am	10%	50%	20%	Off	On

Table 2a OCCUPANCY AND OPERATION PROFILES OF A CLASS 3 OR 9c BUILDING — continued

Time period (local standard time)	Occupancy		Artificial lighting	Air-conditioning	
	Monday to Friday	Saturday, Sunday and holidays		Monday to Friday	Saturday, Sunday and holidays
10:00am to 11:00am	10%	20%	20%	Off	Off
11:00am to 12:00pm	10%	20%	20%	Off	Off
12:00pm to 1:00pm	10%	20%	20%	Off	Off
1:00pm to 2:00pm	10%	20%	20%	Off	Off
2:00pm to 3:00pm	10%	20%	20%	Off	Off
3:00pm to 4:00pm	10%	30%	20%	Off	Off
4:00pm to 5:00pm	50%	50%	20%	On	On
5:00pm to 6:00pm	50%	50%	50%	On	On
6:00pm to 7:00pm	70%	50%	50%	On	On
7:00pm to 8:00pm	70%	70%	50%	On	On
8:00pm to 9:00pm	80%	80%	50%	On	On
9:00pm to 10:00pm	85%	80%	50%	On	On
10:00pm to 11:00pm	85%	85%	50%	On	On
11:00pm to 12:00am	85%	85%	5%	On	On

Note: The occupancy profile is expressed as a percentage of the maximum number of people that can be accommodated in the Class 3 or 9c building. The artificial lighting profile is expressed as a percentage of the maximum *illumination power density* permitted under **Part J6**.

Table 2b OCCUPANCY AND OPERATION PROFILES OF A CLASS 5 BUILDING, A CLASS 7 WAREHOUSE, A CLASS 8 LABORATORY OR A CLASS 9a CLINIC, DAY SURGERY OR PROCEDURE UNIT

Time period (local standard time)	Occupancy (Monday to Friday)	Artificial lighting (Monday to Friday)	Appliances and equipment (Monday to Friday)	Air- conditioning (Monday to Friday)
12:00am to 1:00am	0%	10%	10%	Off
1:00am to 2:00am	0%	10%	10%	Off
2:00am to 3:00am	0%	10%	10%	Off
3:00am to 4:00am	0%	10%	10%	Off
4:00am to 5:00am	0%	10%	10%	Off
5:00am to 6:00am	0%	10%	10%	Off
6:00am to 7:00am	0%	10%	10%	Off
7:00am to 8:00am	15%	40%	25%	On

Table 2b OCCUPANCY AND OPERATION PROFILES OF A CLASS 5 BUILDING, A CLASS 7 WAREHOUSE, A CLASS 8 LABORATORY OR A CLASS 9a CLINIC, DAY SURGERY OR PROCEDURE UNIT— continued

Time period (local standard time)	Occupancy (Monday to Friday)	Artificial lighting (Monday to Friday)	Appliances and equipment (Monday to Friday)	<i>Air-conditioning</i> (Monday to Friday)
8:00am to 9:00am	60%	80%	70%	On
9:00am to 10:00am	100%	100%	100%	On
10:00am to 11:00am	100%	100%	100%	On
11:00am to 12:00pm	100%	100%	100%	On
12:00pm to 1:00pm	100%	100%	100%	On
1:00pm to 2:00pm	100%	100%	100%	On
2:00pm to 3:00pm	100%	100%	100%	On
3:00pm to 4:00pm	100%	100%	100%	On
4:00pm to 5:00pm	100%	100%	100%	On
5:00pm to 6:00pm	50%	80%	60%	On
6:00pm to 7:00pm	15%	60%	25%	Off
7:00pm to 8:00pm	5%	40%	15%	Off
8:00pm to 9:00pm	5%	20%	15%	Off
9:00pm to 10:00pm	0%	10%	10%	Off
10:00pm to 11:00pm	0%	10%	10%	Off
11:00pm to 12:00am	0%	10%	10%	Off

Notes:

- The occupancy profile is expressed as a percentage of the maximum number of people that can be accommodated in the building. The artificial lighting profile is expressed as a percentage of the maximum *illumination power density* permitted under **Part J6**. The appliances and equipment profile is expressed as a percentage of the maximum internal heat gain in **Table 2h**. The *air-conditioning* profile is expressed as the plant status.
- Saturday and Sunday profiles are 10% continuous artificial lighting and 10% continuous appliances and equipment. There is no occupancy and the *air-conditioning* is "off".

Table 2c OCCUPANCY AND OPERATION PROFILES OF A CLASS 6 SHOP OR SHOPPING CENTRE

Time period (local standard time)	Occupancy (Daily)	Artificial lighting (Daily)	Appliances and equipment (Daily)	<i>Air-conditioning</i> (Daily)
12:00am to 1:00am	0%	10%	10%	Off
1:00am to 2:00am	0%	10%	10%	Off

Table 2c OCCUPANCY AND OPERATION PROFILES OF A CLASS 6 SHOP OR SHOPPING CENTRE— continued

Time period (local standard time)	Occupancy (Daily)	Artificial lighting (Daily)	Appliances and equipment (Daily)	<i>Air- conditioning</i> (Daily)
2:00am to 3:00am	0%	10%	10%	Off
3:00am to 4:00am	0%	10%	10%	Off
4:00am to 5:00am	0%	10%	10%	Off
5:00am to 6:00am	0%	10%	10%	Off
6:00am to 7:00am	0%	10%	10%	Off
7:00am to 8:00am	10%	100%	70%	On
8:00am to 9:00am	20%	100%	70%	On
9:00am to 10:00am	20%	100%	70%	On
10:00am to 11:00am	15%	100%	70%	On
11:00am to 12:00pm	25%	100%	70%	On
12:00pm to 1:00pm	25%	100%	70%	On
1:00pm to 2:00pm	15%	100%	70%	On
2:00pm to 3:00pm	15%	100%	70%	On
3:00pm to 4:00pm	15%	100%	70%	On
4:00pm to 5:00pm	15%	100%	70%	On
5:00pm to 6:00pm	5%	100%	70%	On
6:00pm to 7:00pm	5%	100%	70%	Off
7:00pm to 8:00pm	0%	10%	10%	Off
8:00pm to 9:00pm	0%	10%	10%	Off
9:00pm to 10:00pm	0%	10%	10%	Off
10:00pm to 11:00pm	0%	10%	10%	Off
11:00pm to 12:00am	0%	10%	10%	Off

Note: The occupancy profile is expressed as a percentage of the maximum number of people that can be accommodated in the building. The artificial lighting profile is expressed as a percentage of the maximum *illumination power density* permitted under **Part J6**. The appliances and equipment profile is expressed as a percentage of the maximum internal heat gain in **Table 2h**. The *air-conditioning* profile is expressed as the plant status.

Table 2d OCCUPANCY AND OPERATION PROFILES OF A CLASS 6 RESTAURANT OR CAFE

Time period (local standard time)	Occupancy (Monday to Saturday)	Artificial lighting (Monday to Saturday)	Appliances and equipment (Monday to Saturday)	<i>Air-conditioning</i> (Monday to Saturday)
12:00am to 1:00am	0%	5%	15%	Off
1:00am to 2:00am	0%	5%	15%	Off
2:00am to 3:00am	0%	5%	15%	Off
3:00am to 4:00am	0%	5%	15%	Off
4:00am to 5:00am	0%	5%	15%	Off
5:00am to 6:00am	0%	5%	15%	Off
6:00am to 7:00am	5%	40%	40%	Off
7:00am to 8:00am	5%	40%	40%	On
8:00am to 9:00am	5%	60%	60%	On
9:00am to 10:00am	5%	60%	60%	On
10:00am to 11:00am	20%	90%	90%	On
11:00am to 12:00pm	50%	90%	90%	On
12:00pm to 1:00pm	80%	90%	90%	On
1:00pm to 2:00pm	70%	90%	90%	On
2:00pm to 3:00pm	40%	90%	90%	On
3:00pm to 4:00pm	20%	90%	90%	On
4:00pm to 5:00pm	25%	90%	90%	On
5:00pm to 6:00pm	50%	90%	90%	On
6:00pm to 7:00pm	80%	90%	90%	On
7:00pm to 8:00pm	80%	90%	90%	On
8:00pm to 9:00pm	80%	90%	90%	On
9:00pm to 10:00pm	50%	90%	90%	On
10:00pm to 11:00pm	35%	50%	50%	On
11:00pm to 12:00am	20%	30%	30%	On

Notes:

1. The occupancy profile is expressed as a percentage of the maximum number of people that can be accommodated in the building. The artificial lighting profile is expressed as a percentage of the maximum *illumination power density* permitted under **Part J6**. The appliances and equipment profile is expressed as a percentage of the maximum internal heat gain in **Table 2h**. The *air-conditioning* profile is expressed as the plant status.
2. Sunday profiles is 5% continuous artificial lighting and 5% continuous appliances and equipment. There is no occupancy and the *air-conditioning* is "off".

Table 2e OCCUPANCY AND OPERATION PROFILES OF A CLASS 9a WARD AREA

Time period (local standard time)	Occupancy		Artificial lighting	<i>Air-conditioning</i>	
	Monday to Friday	Saturday and Sunday		Monday to Friday	Saturday and Sunday
12:00am to 1:00am	85%	85%	5%	On	On
1:00am to 2:00am	85%	85%	5%	On	On
2:00am to 3:00am	85%	85%	5%	On	On
3:00am to 4:00am	85%	85%	5%	On	On
4:00am to 5:00am	85%	85%	5%	On	On
5:00am to 6:00am	85%	85%	25%	On	On
6:00am to 7:00am	85%	85%	80%	On	On
7:00am to 8:00am	85%	85%	80%	On	On
8:00am to 9:00am	85%	85%	50%	On	On
9:00am to 10:00am	85%	85%	20%	On	On
10:00am to 11:00am	85%	85%	20%	On	On
11:00am to 12:00pm	85%	85%	20%	On	On
12:00pm to 1:00pm	85%	85%	20%	On	On
1:00pm to 2:00pm	85%	85%	20%	On	On
2:00pm to 3:00pm	85%	85%	20%	On	On
3:00pm to 4:00pm	85%	85%	20%	On	On
4:00pm to 5:00pm	85%	85%	20%	On	On
5:00pm to 6:00pm	85%	85%	50%	On	On
6:00pm to 7:00pm	85%	85%	50%	On	On
7:00pm to 8:00pm	85%	85%	50%	On	On
8:00pm to 9:00pm	85%	85%	50%	On	On
9:00pm to 10:00pm	85%	85%	50%	On	On
10:00pm to 11:00pm	85%	85%	50%	On	On
11:00pm to 12:00am	85%	85%	5%	On	On

Note: The occupancy profile is expressed as a percentage of the maximum number of people that can be accommodated in the building. The artificial lighting profile is expressed as a percentage of the maximum *illumination power density* permitted under **Part J6**. The *air-conditioning* profile is expressed as the plant status.

Table 2f OCCUPANCY AND OPERATION PROFILES OF A CLASS 9b THEATRE OR CINEMA

Time period (local standard time)	Occupancy		Artificial lighting		<i>Air-conditioning</i>	
	Monday to Friday	Sat. & Sun.	Monday to Friday	Sat. & Sun.	Monday to Friday	Sat. & Sun.
12:00am to 1:00am	0%	0%	5%	5%	Off	Off
1:00am to 2:00am	0%	0%	5%	5%	Off	Off
2:00am to 3:00am	0%	0%	5%	5%	Off	Off
3:00am to 4:00am	0%	0%	5%	5%	Off	Off
4:00am to 5:00am	0%	0%	5%	5%	Off	Off
5:00am to 6:00am	0%	0%	5%	5%	Off	Off
6:00am to 7:00am	0%	0%	5%	5%	Off	Off
7:00am to 8:00am	0%	0%	5%	5%	Off	On
8:00am to 9:00am	0%	20%	100%	100%	Off	On
9:00am to 10:00am	0%	80%	10%	10%	Off	On
10:00am to 11:00am	0%	80%	10%	10%	Off	On
11:00am to 12:00pm	0%	80%	10%	10%	On	On
12:00pm to 1:00pm	20%	20%	100%	100%	On	On
1:00pm to 2:00pm	80%	80%	5%	5%	On	On
2:00pm to 3:00pm	80%	80%	5%	5%	On	On
3:00pm to 4:00pm	80%	80%	5%	5%	On	On
4:00pm to 5:00pm	80%	80%	5%	5%	On	On
5:00pm to 6:00pm	20%	20%	100%	100%	On	On
6:00pm to 7:00pm	20%	20%	100%	100%	On	On
7:00pm to 8:00pm	80%	80%	100%	100%	On	On
8:00pm to 9:00pm	80%	80%	5%	5%	On	On
9:00pm to 10:00pm	80%	80%	5%	5%	On	On
10:00pm to 11:00pm	80%	80%	5%	5%	On	On
11:00pm to 12:00am	10%	10%	100%	100%	On	On

Note: The occupancy profile is expressed as a percentage of the maximum number of people that can be accommodated in the building. The artificial lighting profile is expressed as a percentage of the maximum *illumination power density* permitted under **Part J6**. The *air-conditioning* profile is expressed as the plant status.

Table 2g OCCUPANCY AND OPERATION PROFILES OF A CLASS 9b SCHOOL

Time period (local standard time)	Occupancy (Monday to Friday)	Artificial lighting (Monday to Friday)	Appliances and equipment (Monday to Friday)	<i>Air-conditioning</i> (Monday to Friday)
12:00am to 1:00am	0%	5%	5%	Off
1:00am to 2:00am	0%	5%	5%	Off
2:00am to 3:00am	0%	5%	5%	Off
3:00am to 4:00am	0%	5%	5%	Off
4:00am to 5:00am	0%	5%	5%	Off
5:00am to 6:00am	0%	5%	5%	Off
6:00am to 7:00am	0%	5%	5%	Off
7:00am to 8:00am	5%	30%	30%	On
8:00am to 9:00am	75%	85%	85%	On
9:00am to 10:00am	90%	95%	95%	On
10:00am to 11:00am	90%	95%	95%	On
11:00am to 12:00pm	90%	95%	95%	On
12:00pm to 1:00pm	50%	80%	70%	On
1:00pm to 2:00pm	50%	80%	70%	On
2:00pm to 3:00pm	90%	95%	95%	On
3:00pm to 4:00pm	70%	90%	80%	On
4:00pm to 5:00pm	50%	70%	60%	On
5:00pm to 6:00pm	20%	20%	20%	Off
6:00pm to 7:00pm	20%	20%	20%	Off
7:00pm to 8:00pm	20%	20%	20%	Off
8:00pm to 9:00pm	10%	10%	10%	Off
9:00pm to 10:00pm	5%	5%	5%	Off
10:00pm to 11:00pm	5%	5%	5%	Off
11:00pm to 12:00am	5%	5%	5%	Off

Notes:

- The occupancy profile is expressed as a percentage of the maximum number of people that can be accommodated in the building. The artificial lighting profile is expressed as a percentage of the maximum *illumination power density* permitted under **Part J6**. The appliances and equipment profile is expressed as a percentage of the maximum internal heat gain in **Table 2h**. The *air-conditioning* profile is expressed as the plant status.
- Saturday and Sunday profiles are 5% continuous artificial lighting and 5% continuous appliances and equipment. There is no occupancy and the *air-conditioning* is "off".

Table 2h INTERNAL HEAT GAINS FOR APPLIANCES AND EQUIPMENT

Application	Internal sensible heat gain rate (W/m ²)
<i>Sole-occupancy unit</i> of a Class 3 building, a Class 9a building <i>ward area</i> or Class 9c building	5 W/m ² averaged for 24 hours per day, 7 days per week, continuous operation
Class 5 building, Class 8 laboratory and a Class 9a clinic, day surgery and a procedure unit	15 W/m ²
Class 6 shop and shopping centre, Class 6 cafe and restaurant and Class 9b <i>school</i>	5 W/m ²
Other applications	No load

Table 2i HEATED WATER SUPPLY CONSUMPTION RATES

Application	Daily consumption rate
Residential part of a hotel or motel	75 L/ <i>sole-occupancy unit</i>
Dormitory, boarding house, guest house, hostel, lodginghouse and backpackers accommodation	50 L/person
Residential part of a <i>school</i> , accommodation for the aged, children or people with a disability and a <i>detention centre</i> or a <i>health care building</i> which accommodates members of staff	
Class 9c building	
Office, laboratory, shop and <i>assembly building</i>	4 L/person
Dining room, restaurant and cafe	9 L/meal
<i>Health care building ward area</i>	70 L/patient
<i>School</i>	7 L/person
Other applications	4 L/person

Table 2j INTERNAL HEAT GAINS FOR OCCUPANTS AND HOT MEALS

Application	Internal heat gains per person
Dining room, restaurant or cafe	(a) 80 W <i>sensible heat gain</i> and 80 W <i>latent heat gain</i>
	(b) The average adjusted metabolic rate for sedentary work from Table 45 of AIRAH-DA09
	(c) The heat emission rate for sedentary work from Table 6.3 of CIBSE Guide A
Other applications	(a) 75 W <i>sensible heat gain</i> and 55 W <i>latent heat gain</i>
	(b) An average adjusted metabolic rate from Table 45 of AIRAH-DA09
	(c) A heat emission rate from Table 6.3 of CIBSE Guide A

Notes:

- The number of people must be calculated in accordance with **D1.13**.

Table 2j INTERNAL HEAT GAINS FOR OCCUPANTS AND HOT MEALS— continued

Application	Internal heat gains per person
2.	For a dining room, restaurant or cafe, the internal heat gains per person account for heat gains from both occupants and hot meals. For other applications, the internal heat gains per person only account for heat gains from occupants.

PART J0

ENERGY EFFICIENCY

Deemed-to-Satisfy Provisions

J0.0 Deemed-to-Satisfy Provisions

- (a) Where a *Deemed-to-Satisfy Solution* is proposed, *Performance Requirements JP1* and *JP3* are satisfied by complying with—
- (i) **J0.1** to **J0.3**; and
 - (ii) **J1.1** to **J1.6**; and
 - (iii) **J2.1** to **J2.5**; and
 - (iv) **J3.1** to **J3.7**; and
 - (v) **J5.1** to **J5.4**; and
 - (vi) **J6.1** to **J6.6**; and
 - (vii) **J7.1** to **J7.4**; and
 - (viii) **J8.1** to **J8.3**.
- (b) Where a *Performance Solution* is proposed, the relevant *Performance Requirements* must be determined in accordance with **A0.7**.

J0.1 Application of Section J

Performance Requirements JP1 and *JP3* are satisfied by complying with—

- (a) for reducing the heating or cooling loads—
- (i) of *sole-occupancy units* of a Class 2 building or a Class 4 part of a building, **J0.2** and **J0.3**; and
 - (ii) of a Class 2 to 9 building, other than the *sole-occupancy units* of a Class 2 building or a Class 4 part of a building, **Parts J1**, **J2** and **J3**; and
- (b) for *air-conditioning* and ventilation, **Part J5**; and
- (c) for artificial lighting and power, **Part J6**; and
- (d) for heated water supply and *swimming pool* and spa pool plant, **Part J7**; and
- (e) for facilities for monitoring, **Part J8**.

J0.2 Heating and cooling loads of sole-occupancy units of a Class 2 building or a Class 4 part

The *sole-occupancy units* of a Class 2 building or a Class 4 part of a building must—

- (a) for reducing the heating or cooling loads—
- (i) collectively achieve an average energy rating of not less than 6 stars; and
 - (ii) individually achieve an energy rating of not less than 5 stars, using *house energy rating software*; and
- (b) for general thermal construction, comply with **J1.2**; and

Deemed-to-Satisfy Provisions

- (c) for thermal breaks, comply with **J1.3(d)** and **J1.5(c)**; and
- (d) for compensating for a loss of ceiling insulation, comply with **J1.3(c)**, other than where the *house energy rating software* used can automatically compensate for a loss of ceiling insulation; and
- (e) for floor edge insulation, comply with **J1.6(c)** and **J1.6(d)**; and
- (f) for building sealing, comply with **Part J3**.

J0.3 Ceiling fans

Ceiling fans *required* as part of compliance with **J0.2(a)**, must—

- (a) be permanently installed; and
- (b) have a speed controller; and
- (c) serve the whole room, with the *floor area* that a single fan serves not exceeding—
 - (i) 15 m² if it has a blade rotation diameter of not less than 900 mm; and
 - (ii) 25 m² if it has a blade rotation diameter of not less than 1200 mm.

PART J1 BUILDING FABRIC

Deemed-to-Satisfy Provisions

J1.0 Deemed-to-Satisfy Provisions

- (a) Where a *Deemed-to-Satisfy Solution* is proposed, *Performance Requirements JP1* and *JP3* are satisfied by complying with—
- (i) **J0.1** to **J0.3**; and
 - (ii) **J1.1** to **J1.6**; and
 - (iii) **J2.1** to **J2.5**; and
 - (iv) **J3.1** to **J3.7**; and
 - (v) **J5.1** to **J5.4**; and
 - (vi) **J6.1** to **J6.6**; and
 - (vii) **J7.1** to **J7.4**; and
 - (viii) **J8.1** to **J8.3**.
- (b) Where a *Performance Solution* is proposed, the relevant *Performance Requirements* must be determined in accordance with **A0.7**.

J1.1 Application of Part

The *Deemed-to-Satisfy Provisions* of this Part apply to building elements forming the *envelope* of a Class 2 to 9 building.

J1.2 Thermal construction — general

- (a) Where *required*, insulation must comply with AS/NZS 4859.1 and be installed so that it—
- (i) abuts or overlaps adjoining insulation other than at supporting members such as studs, noggings, joists, furring channels and the like where the insulation must be against the member; and
 - (ii) forms a continuous barrier with ceilings, walls, bulkheads, floors or the like that inherently contribute to the thermal barrier; and
 - (iii) does not affect the safe or effective operation of a *service* or fitting.
- (b) Where *required*, *reflective insulation* must be installed with—
- (i) the necessary airspace to achieve the *required R-Value* between a reflective side of the *reflective insulation* and a building lining or cladding; and
 - (ii) the *reflective insulation* closely fitted against any penetration, door or *window* opening; and
 - (iii) the *reflective insulation* adequately supported by framing members; and
 - (iv) each adjoining sheet of roll membrane being—
 - (A) overlapped not less than 50 mm; or
 - (B) taped together.

Deemed-to-Satisfy Provisions

- (c) Where *required*, bulk insulation must be installed so that—
 - (i) it maintains its position and thickness, other than where it is compressed between cladding and supporting members, water pipes, electrical cabling or the like; and
 - (ii) in a ceiling, where there is no bulk insulation or *reflective insulation* in the wall beneath, it overlaps the wall by not less than 50 mm.
- (d) Roof, ceiling, wall and floor materials, and associated surfaces are deemed to have the thermal properties listed in **Specification J1.2**.

J1.3 Roof and ceiling construction

- (a) A roof or ceiling that is part of the *envelope*, other than of a *sole-occupancy unit* of a Class 2 building or a Class 4 part of a building, must achieve the *Total R-Value* specified in **Table J1.3a** for the direction of heat flow.

Table J1.3a ROOFS AND CEILINGS - MINIMUM TOTAL R-VALUE FOR EACH CLIMATE ZONE

<i>Climate zone</i>	1, 2, 3, 4 and 5	6	7	8
Direction of heat flow	Downwards		Upwards	
Minimum <i>Total R-Value</i> for a roof or ceiling with a roof upper surface solar absorptance value of not more than 0.4	3.2	3.2	3.7	4.8
Minimum <i>Total R-Value</i> for a roof or ceiling with a roof upper surface solar absorptance value of more than 0.4 but not more than 0.6	3.7	3.2	3.7	4.8
Minimum <i>Total R-Value</i> for a roof or ceiling with a roof upper surface solar absorptance value of more than 0.6	4.2	3.2	3.7	4.8

- (b) For compliance with **Table J1.3a**, roof and ceiling construction is deemed to have the thermal properties listed in **Specification J1.3**.
- (c) Where, for operational or safety reasons associated with exhaust fans, flues or recessed downlights, the area of *required* ceiling insulation is reduced, the loss of insulation must be compensated for by increasing the *R-Value* of the insulation in the remainder of the ceiling in accordance with **Table J1.3b**.

Table J1.3b ADJUSTMENT OF MINIMUM R-VALUE FOR LOSS OF CEILING INSULATION

Percentage of ceiling area uninsulated	Minimum <i>R-Value</i> of ceiling insulation <i>required</i> to satisfy J1.3(a)										
	1.0	1.5	2.0	2.5	3.0	3.5	4.0	4.5	5.0	5.5	6.0
	Adjusted minimum <i>R-Value</i> of ceiling insulation <i>required</i> to compensate for loss of ceiling insulation area										
0.5% to less than 1.0%	1.0	1.6	2.2	2.8	3.4	4.0	4.7	5.4	6.2	6.9	
1.0% to less than 1.5%	1.1	1.7	2.3	2.9	3.6	4.4	5.2	6.1	7.0		

Deemed-to-Satisfy Provisions

Table J1.3b ADJUSTMENT OF MINIMUM R-VALUE FOR LOSS OF CEILING INSULATION — continued

Percentage of ceiling area uninsulated	Minimum <i>R-Value</i> of ceiling insulation <i>required</i> to satisfy J1.3(a)										
	1.0	1.5	2.0	2.5	3.0	3.5	4.0	4.5	5.0	5.5	6.0
	Adjusted minimum <i>R-Value</i> of ceiling insulation <i>required</i> to compensate for loss of ceiling insulation area										
1.5% to less than 2.0%	1.1	1.7	2.4	3.1	3.9	4.8	5.8	6.8	Not Permitted		
2.0% to less than 2.5%	1.1	1.8	2.5	3.3	4.2	5.3	6.5				
2.5% to less than 3.0%	1.2	1.9	2.6	3.6	4.6	5.9					
3.0% to less than 4.0%	1.2	2.0	3.0	4.2	5.7						
4.0% to less than 5.0%	1.3	2.2	3.4	5.0							
5.0% or more											

Note: Where the minimum *R-Value* of ceiling insulation *required* to satisfy J1.3(a) is between the values stated, interpolation may be used to determine the adjusted minimum *R-Value*.

- (d) A roof that—
- (i) is *required* to achieve a minimum *Total R-Value*; and
 - (ii) has metal sheet roofing fixed to metal purlins, metal rafters or metal battens; and
 - (iii) does not have a ceiling lining or has a ceiling lining fixed directly to those metal purlins, metal rafters or metal battens (see **Specification J1.3 Figure 2(c) and (f)**),
- must have a thermal break, consisting of a material with an *R-Value* of not less than R0.2, installed between the metal sheet roofing and its supporting metal purlins, metal rafters or metal battens.

SA J1.3(e)

J1.4 Roof lights

Roof lights, including any associated shaft and diffuser, that form part of the *envelope*, other than of a *sole-occupancy unit* of a Class 2 building or a Class 4 part of a building, must—

- (a) if the *roof lights* are not *required* for compliance with **Part F4**, comply with **Table J1.4**; or
- (b) if the *roof lights* are *required* for compliance with **Part F4**—
 - (i) have an area not more than 150% of the minimum area *required* by **F4.6**; and
 - (ii) have transparent and translucent elements, including any imperforate ceiling diffuser, with a combined performance of not more than—
 - (A) 0.29 *Total System SHGC*; and
 - (B) 2.9 *Total System U-Value*.

Deemed-to-Satisfy Provisions

Table J1.4 ROOF LIGHTS - THERMAL PERFORMANCE OF TRANSPARENT AND TRANSLUCENT ELEMENTS

<i>Roof light shaft index (see Note 1)</i>	Constant	Total area of <i>roof lights</i> serving the room or space as a percentage of the <i>floor area</i> of the room or space			
		Up to 2%	More than 2% to and up to 3%	More than 3% and up to 4%	More than 4% and up to 5%
Less than 0.5	<i>Total System SHGC</i>	Not more than 0.83	Not more than 0.57	Not more than 0.43	Not more than 0.34
	<i>Total System U-Value</i>	Not more than 8.5	Not more than 5.7	Not more than 4.3	Not more than 3.4
0.5 to less than 1.0	<i>Total System SHGC</i>	Not more than 0.83	Not more than 0.72	Not more than 0.54	Not more than 0.43
	<i>Total System U-Value</i>	Not more than 8.5	Not more than 5.7	Not more than 4.3	Not more than 3.4
1.0 to less than 2.5	<i>Total System SHGC</i>	Not more than 0.83	Not more than 0.83	Not more than 0.69	Not more than 0.55
	<i>Total System U-Value</i>	Not more than 8.5	Not more than 5.7	Not more than 4.3	Not more than 3.4
2.5 and more	<i>Total System SHGC</i>	Not more than 0.83	Not more than 0.83	Not more than 0.83	Not more than 0.83
	<i>Total System U-Value</i>	Not more than 8.5	Not more than 5.7	Not more than 4.3	Not more than 3.4

Notes:

1. The *roof light* shaft index is determined by measuring the distance from the centre of the shaft at the roof to the centre of the shaft at the ceiling level and dividing it by the average internal dimension of the shaft opening at the ceiling level (or the diameter for a circular shaft) in the same units of measurement.
2. The total area of *roof lights* is the combined area for all *roof lights* serving the room or space.
3. The area of a *roof light* is the area of the roof opening that allows light to enter the building.
4. The thermal performance of an imperforate ceiling diffuser may be included in the *Total System U-Value* and *Total System SHGC* of the *roof light*.
5. The total area of *roof lights* serving the room or space as a percentage of the *floor area* of the room or space must not exceed 5% unless allowed by **J1.4(b)**.

J1.5 Walls

- (a) Each part of an *external wall* that is part of the *envelope*, other than of a *sole-occupancy unit* of a Class 2 building or a Class 4 part of a building, must satisfy one of the options in **Table J1.5a** except for—
- (i) opaque non-glazed openings in *external walls* such as doors (including garage doors), vents, penetrations, shutters and the like; and
 - (ii) *glazing*; and
 - (iii) an earth retaining wall or earth-berm, in other than *climate zone* 8.

Deemed-to-Satisfy Provisions

Table J1.5a OPTIONS FOR EACH PART OF AN EXTERNAL WALL THAT IS PART OF AN ENVELOPE

<i>Climate zone</i>	Options
1, 2 and 3	<p>(a) (i) Achieve a minimum <i>Total R-Value</i> of 3.3.</p> <p>(ii) The minimum <i>Total R-Value</i> in (i) is reduced—</p> <p>(A) for a wall with a surface density of not less than 220 kg/m², by 0.5; and</p> <p>(B) for a wall that is—</p> <p>(aa) facing the south orientation as described in Figure J2.3, by 0.5; or</p> <p>(bb) shaded with a projection shade angle in accordance with Figure J1.5 of—</p> <p>(AA) 15 degrees to not more than 45 degrees, by 0.5; or</p> <p>(BB) more than 45 degrees, by 1.0; and</p> <p>(C) if the outer surface solar absorptance value is not more than 0.6, by 0.5.</p>
	<p>(b) Where the only space for insulation is provided by a furring channel, top hat section, batten or the like—</p> <p>(i) achieve a minimum <i>Total R-Value</i> of 1.4; and</p> <p>(ii) satisfy <i>glazing</i> energy index Option B of Table J2.4a.</p>
4, 5 and 6	<p>(a) (i) Achieve a minimum <i>Total R-Value</i> of 2.8.</p> <p>(ii) The minimum <i>Total R-Value</i> in (i) is reduced—</p> <p>(A) for a wall with a surface density of not less than 220 kg/m², by 0.5; and</p> <p>(B) for a wall that is—</p> <p>(aa) facing the south orientation as described in Figure J2.3, by 0.5; or</p> <p>(bb) shaded with a projection shade angle in accordance with Figure J1.5 of—</p> <p>(AA) 30 degrees to not more than 60 degrees, by 0.5; or</p> <p>(BB) more than 60 degrees, by 1.0.</p>
	<p>(b) Where the only space for insulation is provided by a furring channel, top hat section, batten or the like—</p> <p>(i) achieve a minimum <i>Total R-Value</i> of 1.4; and</p> <p>(ii) satisfy <i>glazing</i> energy index Option B of Table J2.4a.</p>

Deemed-to-Satisfy Provisions

Table J1.5a OPTIONS FOR EACH PART OF AN EXTERNAL WALL THAT IS PART OF AN ENVELOPE— continued

<i>Climate zone</i>	Options
7	(a) Achieve a minimum <i>Total R-Value</i> of 2.8. (b) Where the only space for insulation is provided by a furring channel, top hat section, batten or the like— (i) achieve a minimum <i>Total R-Value</i> of 1.4; and (ii) satisfy <i>glazing</i> energy index Option B of Table J2.4a .
8	(a) Achieve a minimum <i>Total R-Value</i> of 3.8. (b) Where the wall is an earth retaining wall or earth-berm, achieve a minimum <i>Total R-Value</i> of 2.0.

Figure J1.5

MEASUREMENT OF PROJECTION FOR WALL SHADING

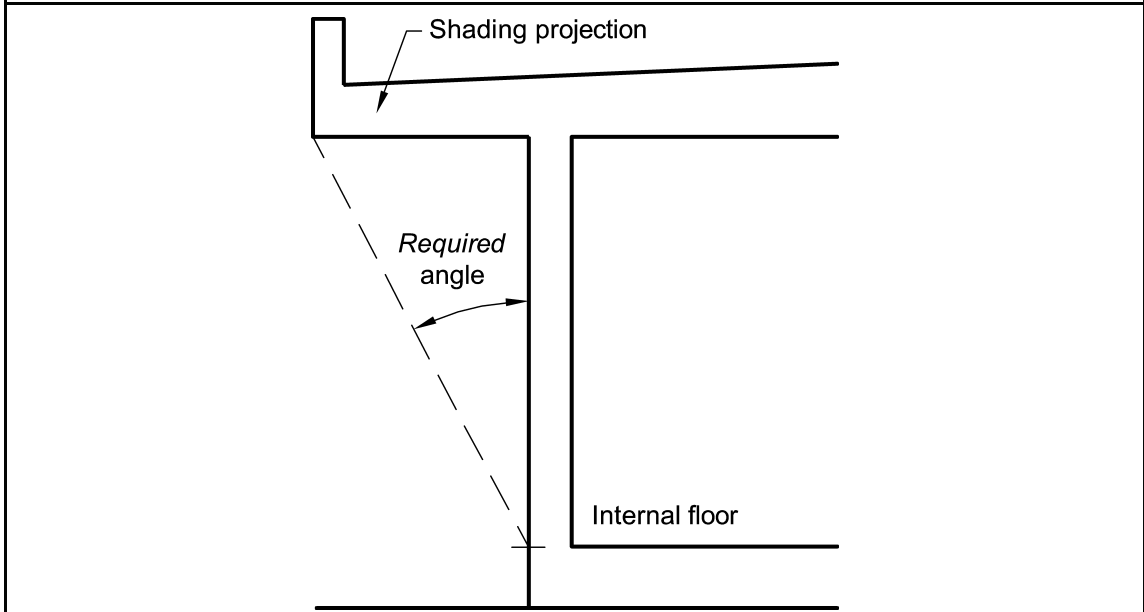

(b) Any wall, other than an *external wall*, that is part of the *envelope* must achieve the *Total R-Value* in **Table J1.5b**.

Deemed-to-Satisfy Provisions

Table J1.5b AN ENVELOPE WALL OTHER THAN AN EXTERNAL WALL – MINIMUM TOTAL R-VALUE

Location	<i>Climate zone</i>							
	1	2	3	4	5	6	7	8
(a) Where the adjacent enclosed non- <i>conditioned space</i> has—								
(i) ventilation of not more than 1.5 air changes per hour of outside air during occupied hours; and	1.0	1.0	Nil	Nil	1.0	1.0	1.5	2.5
(ii) glazing in the external <i>fabric</i> as <i>required</i> by Part J2 ; and								
(iii) <i>roof lights</i> in the external <i>fabric</i> as <i>required</i> by J1.4 .								
(b) For other than (a)	2.3	2.3	2.3	1.8	1.8	1.8	2.8	3.8
Note: When assessing the glazing and <i>roof lights</i> as <i>required</i> by Part J2 and J1.4 , assess the glazing and <i>roof lights</i> as if the non- <i>conditioned space</i> is the same separate <i>conditioned space</i> .								

- (c) A wall that—
- (i) is *required* to achieve a minimum *Total R-Value*; and
 - (ii) has lightweight external cladding such as weatherboards, fibre-cement or metal sheeting fixed to a metal frame; and
 - (iii) does not have a wall lining or has a wall lining that is fixed directly to the same metal frame,
- must have a thermal break, consisting of a material with an *R-Value* of not less than R0.2, installed between the external cladding and the metal frame.
- (d) For compliance with **Table J1.5a** and **Table J1.5b**, wall construction is deemed to have the thermal properties listed in **Specification J1.5**.

J1.6 Floors

- (a) A floor that is part of the *envelope* of a building, other than a *sole-occupancy unit* of a Class 2 building or a Class 4 part of a building, including a floor above or below a *carpark* or a plant room—
- (i) must achieve the *Total R-Value* specified in **Table J1.6**; and
 - (ii) with an in-slab or in-screed heating or cooling system, must be insulated around the vertical edge of its perimeter with insulation having an *R-Value* of not less than 1.0.
- (b) In *climate zones* 1 to 6, the minimum *Total R-Value required* in (a) may be reduced by R0.5 provided R0.75 is added to the *Total R-Value required* for the roof and ceiling construction.
- (c) A concrete slab-on-ground—
- (i) with an in-slab or in-screed heating or cooling system; or

Deemed-to-Satisfy Provisions

- (ii) located in *climate zone* 8,
must have insulation installed around the vertical edge of its perimeter.
- (d) Insulation *required* by (c) must—
 - (i) have an *R-Value* of not less than 1.0; and
 - (ii) be water resistant; and
 - (iii) be continuous from the adjacent finished ground level—
 - (A) to a depth of not less than 300 mm; or
 - (B) for the full depth of the vertical edge of the concrete slab-on-ground.
- (e) The requirements of (a)(ii) and (c)(i) do not apply to an in-screed heating or cooling system used solely in a bathroom, amenity area or the like.
- (f) Floor construction is deemed to have the thermal properties listed in **Specification J1.6**.

Table J1.6 FLOORS — MINIMUM TOTAL R-VALUE

Location	<i>Climate zone</i>							
	1	2	3	4	5	6	7	8
Direction of heat flow	Upwards	Downwards and upwards		Downwards				
(a) A slab on ground:								
(i) Without an in-slab or in-screed heating or cooling system	Nil	Nil	Nil	Nil	Nil	Nil	1.0	2.0
(ii) With an in-slab or in-screed heating or cooling system	1.25	1.25	1.25	1.25	1.25	1.25	1.25	2.25
(b) A suspended floor without an in-slab or in-screed heating or cooling system where the non- <i>conditioned space</i> is—	1.0	1.0	Nil	Nil	1.0	1.0	1.5	2.5
(i) enclosed; and								
(ii) where mechanically ventilated by not more than 1.5 air changes per hour.								

Deemed-to-Satisfy Provisions

Table J1.6 FLOORS — MINIMUM TOTAL R-VALUE — continued

Location	Climate zone							
	1	2	3	4	5	6	7	8
Direction of heat flow	Upwards	Downwards and upwards		Downwards				
(c) A suspended floor with an in-slab or in-screed heating or cooling system where the non-conditioned space is— (i) enclosed; and (ii) where mechanically ventilated by not more than 1.5 air changes per hour	1.25	1.25	1.25	1.25	1.25	1.25	1.75	2.75
(d) For other than (a), (b) or (c)	2.0	2.0	2.0	2.0	2.0	2.0	2.0	3.5

Note: A subfloor space with not more than 150% of the *required* subfloor ventilation is considered enclosed.

PART J2 GLAZING

Deemed-to-Satisfy Provisions

J2.0 Deemed-to-Satisfy Provisions

- (a) Where a *Deemed-to-Satisfy Solution* is proposed, *Performance Requirements JP1* and *JP3* are satisfied by complying with—
- (i) **J0.1** to **J0.3**; and
 - (ii) **J1.1** to **J1.6**; and
 - (iii) **J2.1** to **J2.5**; and
 - (iv) **J3.1** to **J3.7**; and
 - (v) **J5.1** to **J5.4**; and
 - (vi) **J6.1** to **J6.6**; and
 - (vii) **J7.1** to **J7.4**; and
 - (viii) **J8.1** to **J8.3**.
- (b) Where a *Performance Solution* is proposed, the relevant *Performance Requirements* must be determined in accordance with **A0.7**.

J2.1 Application of Part

The *Deemed-to-Satisfy Provisions* of this Part apply to elements forming the *envelope* of a building other than a *sole-occupancy unit* of a Class 2 building or a Class 4 part of a building.

J2.2 * * * * *

This clause has deliberately been left blank.

J2.3 * * * * *

This clause has deliberately been left blank.

J2.4 Glazing

- (a) The *glazing* in each *storey*, including any *mezzanine*, of a building must be assessed separately in accordance with **(b)** and **(c)** for—
- (i) *glazing* in the external *fabric* facing each orientation; and
 - (ii) *glazing* in the internal *fabric*.
- (b) The aggregate *air-conditioning* energy value attributable to the *glazing* must not exceed the allowance obtained by multiplying the facade area that is exposed to the *conditioned space* for the orientation by the energy index in **Table J2.4a**.

Deemed-to-Satisfy Provisions

Table J2.4a ENERGY INDEX

Application	Energy index option	Climate zone							
		1	2	3	4	5	6	7	8
<i>Glazing</i> in a Class 3 building	A	0.067	0.132	0.091	0.086	0.092	0.090	0.059	0.027
	B	0.060	0.124	0.078	0.063	0.071	0.061	0.037	Not applicable
<i>Glazing</i> in a Class 9c building	A	0.080	0.158	0.109	0.103	0.110	0.108	0.071	0.032
	B	0.072	0.149	0.094	0.076	0.085	0.073	0.044	Not applicable
Display <i>glazing</i> in a shop or showroom	A	0.180	0.217	0.221	0.227	0.257	0.220	0.170	0.046
	B	0.173	0.209	0.208	0.204	0.236	0.191	0.148	Not applicable
<i>Glazing</i> in other than, a Class 3 building, a Class 9c building or display <i>glazing</i> in a shop or showroom	A	0.130	0.181	0.172	0.142	0.175	0.116	0.083	0.023
	B	0.123	0.173	0.159	0.113	0.145	0.082	0.058	Not applicable

Note: Option A applies to all *glazing* other than where compliance with Option B is *required* by [Table J1.5a](#).

- (c) The aggregate *air-conditioning* energy value must be calculated by adding the *air-conditioning* energy value through each *glazing* element in accordance with the following formula:

$$A_1[\text{SHGC}_1(C_A \times S_{H1} + C_B \times S_{C1}) + C_C \times U_1] + A_2[\text{SHGC}_2(C_A \times S_{H2} + C_B \times S_{C2}) + C_C \times U_2] + \dots$$

where—

- $A_{1, 2, \text{ etc}}$ = the area of each *glazing* element; and
- $C_{A, B \text{ and } C}$ = the energy constants A, B and C for the specific orientation from [Table J2.4b](#); and
- $\text{SHGC}_{1, 2, \text{ etc}}$ = the *Total System SHGC* of each *glazing* element; and
- $S_{H1, 2, \text{ etc}}$ = the heating shading multiplier for each *glazing* element obtained from [Table J2.4c](#); and
- $S_{C1, 2, \text{ etc}}$ = the cooling shading multiplier for each *glazing* element obtained from [Table J2.4d](#); and
- $U_{1, 2, \text{ etc}}$ = the *Total System U-Value* of each *glazing* element.

- (d) For the purposes of (c)—
- (i) where the *air-conditioning* energy value of a *glazing* element is calculated to be negative, it must be taken to be zero; and
 - (ii) where *glazing* is in the internal *fabric*, the aggregate *air-conditioning* energy value must be calculated using—

Deemed-to-Satisfy Provisions

- (A) the energy constants A, B and C for the south orientation sector in [Table J2.4b](#); and
- (B) the shading multipliers in [Table J2.4e](#).

Table J2.4b ENERGY CONSTANTS (C_A , C_B AND C_C)

Climate zone	Energy constants	Orientation Sector (refer Figure J2.3)							
		North	North east	East	South east	South	South west	West	North west
1	C_A	0.00	0.00	0.00	0.00	0.00	0.00	0.00	0.00
	C_B	0.80	0.92	0.91	0.67	0.48	0.67	0.88	0.91
	C_C	0.02	0.02	0.02	0.02	0.02	0.02	0.02	0.02
2	C_A	0.00	0.00	0.00	0.00	0.00	0.00	0.00	0.00
	C_B	1.20	1.40	1.31	0.84	0.48	0.70	1.03	1.17
	C_C	-0.01	-0.01	-0.01	0.00	0.00	0.00	-0.01	-0.01
3	C_A	0.00	0.00	0.00	0.00	0.00	0.00	0.00	0.00
	C_B	1.01	1.16	1.08	0.69	0.41	0.67	1.01	1.09
	C_C	0.01	0.01	0.01	0.02	0.01	0.01	0.01	0.01
4	C_A	-0.16	-0.18	-0.30	-0.44	-0.45	-0.46	-0.40	-0.26
	C_B	1.25	1.37	1.18	0.68	0.35	0.60	0.98	1.20
	C_C	0.00	0.00	0.03	0.07	0.09	0.08	0.04	0.02
5	C_A	-0.06	-0.09	-0.18	-0.41	-0.47	-0.43	-0.28	-0.14
	C_B	1.46	1.55	1.32	0.75	0.41	0.68	1.13	1.38
	C_C	-0.02	-0.01	0.00	0.05	0.07	0.05	0.02	-0.01
6	C_A	-0.37	-0.38	-0.59	-0.82	-0.87	-0.90	-0.85	-0.61
	C_B	1.53	1.66	1.39	0.80	0.38	0.66	1.07	1.34
	C_C	-0.01	-0.01	0.03	0.11	0.15	0.13	0.08	0.03
7	C_A	-0.41	-0.43	-0.70	-0.76	-0.74	-0.85	-0.92	-0.71
	C_B	1.32	1.39	1.09	0.59	0.25	0.47	0.81	1.09
	C_C	0.00	0.01	0.06	0.13	0.16	0.15	0.11	0.05
8	C_A	-0.87	-0.81	-0.75	-0.61	-0.73	-0.75	-0.87	-0.92
	C_B	0.55	0.61	0.52	0.28	0.10	0.26	0.46	0.54
	C_C	0.13	0.12	0.14	0.17	0.20	0.19	0.22	0.15

Deemed-to-Satisfy Provisions

Table J2.4c HEATING SHADING MULTIPLIER (S_H)

G (refer Figure J2.4)	P/H (refer Figure J2.4)	Orientation Sector (refer Figure J2.3)							
		North	North east	East	South east	South	South west	West	North west
CLIMATE ZONES 1, 2 AND 3									
In <i>climate zones</i> 1, 2 and 3, the heating shading multiplier is to be taken as 1.0									
CLIMATE ZONES 4 AND 5									
Not more than 100 mm	0.0	1.00	1.00	1.00	1.00	1.00	1.00	1.00	1.00
	0.2	0.96	0.95	0.92	0.90	0.94	0.92	0.92	0.95
	0.4	0.86	0.83	0.79	0.78	0.87	0.83	0.80	0.85
	0.6	0.66	0.65	0.63	0.69	0.81	0.74	0.66	0.70
	0.8	0.30	0.41	0.43	0.62	0.77	0.66	0.50	0.47
	1.0	0.00	0.08	0.22	0.56	0.74	0.60	0.35	0.15
	1.2	0.00	0.00	0.08	0.52	0.71	0.54	0.21	0.00
	1.4	0.00	0.00	0.04	0.48	0.69	0.50	0.12	0.00
	1.6	0.00	0.00	0.02	0.45	0.67	0.46	0.08	0.00
	1.8	0.00	0.00	0.01	0.42	0.66	0.43	0.04	0.00
	2.0	0.00	0.00	0.00	0.39	0.64	0.39	0.00	0.00
More than 100 mm but not more than 500 mm	0.0	1.00	1.00	1.00	1.00	1.00	1.00	1.00	1.00
	0.2	0.99	0.99	0.98	0.97	0.98	0.97	0.98	0.99
	0.4	0.97	0.95	0.92	0.89	0.93	0.91	0.92	0.96
	0.6	0.91	0.88	0.84	0.81	0.88	0.85	0.85	0.90
	0.8	0.79	0.78	0.73	0.70	0.84	0.79	0.75	0.81
	1.0	0.59	0.63	0.62	0.67	0.80	0.73	0.65	0.69
	1.2	0.27	0.45	0.48	0.63	0.78	0.68	0.54	0.50
	1.4	0.03	0.28	0.35	0.59	0.75	0.63	0.44	0.31
	1.6	0.02	0.19	0.25	0.56	0.74	0.59	0.34	0.21
	1.8	0.01	0.09	0.14	0.52	0.72	0.55	0.25	0.10
	2.0	0.00	0.00	0.03	0.49	0.70	0.51	0.15	0.00

Deemed-to-Satisfy Provisions

Table J2.4c HEATING SHADING MULTIPLIER (S_H)— continued

G (refer Figure J2.4)	P/H (refer Figure J2.4)	Orientation Sector (refer Figure J2.3)							
		North	North east	East	South east	South	South west	West	North west
More than 500 mm but not more than 1200 mm	0.0	1.00	1.00	1.00	1.00	1.00	1.00	1.00	1.00
	0.2	1.00	1.00	0.99	0.99	0.99	0.99	0.99	0.99
	0.4	0.99	0.98	0.97	0.97	0.97	0.96	0.97	0.99
	0.6	0.98	0.97	0.94	0.92	0.95	0.93	0.94	0.97
	0.8	0.95	0.94	0.90	0.88	0.92	0.89	0.90	0.94
	1.0	0.91	0.89	0.84	0.83	0.89	0.85	0.84	0.90
	1.2	0.82	0.82	0.78	0.78	0.86	0.82	0.78	0.84
	1.4	0.67	0.71	0.70	0.73	0.84	0.78	0.71	0.75
	1.6	0.45	0.58	0.60	0.70	0.81	0.74	0.64	0.62
	1.8	0.22	0.44	0.51	0.66	0.79	0.71	0.56	0.48
	2.0	0.00	0.30	0.42	0.62	0.77	0.67	0.49	0.35
More than 1200 mm but less than 1800 mm	0.0	1.00	1.00	1.00	1.00	1.00	1.00	1.00	1.00
	0.2	1.00	1.00	1.00	1.00	1.00	1.00	1.00	1.00
	0.4	1.00	0.99	0.99	0.98	0.99	0.98	0.98	0.99
	0.6	0.99	0.98	0.97	0.96	0.97	0.96	0.97	0.98
	0.8	0.98	0.97	0.95	0.93	0.95	0.93	0.94	0.97
	1.0	0.97	0.95	0.92	0.90	0.93	0.91	0.91	0.95
	1.2	0.94	0.92	0.88	0.87	0.91	0.88	0.87	0.93
	1.4	0.88	0.87	0.83	0.83	0.89	0.85	0.83	0.88
	1.6	0.77	0.80	0.77	0.80	0.87	0.82	0.77	0.83
	1.8	0.66	0.73	0.71	0.77	0.86	0.79	0.72	0.77
	2.0	0.56	0.66	0.66	0.73	0.84	0.77	0.67	0.71

Deemed-to-Satisfy Provisions

Table J2.4c HEATING SHADING MULTIPLIER (S_H)— continued

G (refer Figure J2.4)	P/H (refer Figure J2.4)	Orientation Sector (refer Figure J2.3)							
		North	North east	East	South east	South	South west	West	North west
CLIMATE ZONES 6 AND 7									
Not more than 100 mm	0.0	1.00	1.00	1.00	1.00	1.00	1.00	1.00	1.00
	0.2	0.95	0.93	0.91	0.90	0.93	0.91	0.91	0.93
	0.4	0.82	0.82	0.78	0.79	0.86	0.81	0.78	0.80
	0.6	0.61	0.66	0.64	0.70	0.80	0.71	0.64	0.62
	0.8	0.31	0.46	0.49	0.63	0.74	0.63	0.52	0.41
	1.0	0.02	0.23	0.35	0.58	0.70	0.56	0.40	0.17
	1.2	0.00	0.04	0.23	0.53	0.66	0.51	0.30	0.02
	1.4	0.00	0.00	0.14	0.49	0.63	0.47	0.22	0.00
	1.6	0.00	0.00	0.10	0.45	0.60	0.44	0.16	0.00
	1.8	0.00	0.00	0.05	0.41	0.58	0.41	0.11	0.00
	2.0	0.00	0.00	0.01	0.37	0.55	0.38	0.05	0.00
More than 100 mm but not more than 500 mm	0.0	1.00	1.00	1.00	1.00	1.00	1.00	1.00	1.00
	0.2	0.99	0.99	0.98	0.97	0.97	0.97	0.97	0.98
	0.4	0.96	0.94	0.91	0.89	0.93	0.91	0.91	0.94
	0.6	0.88	0.87	0.83	0.82	0.87	0.84	0.82	0.86
	0.8	0.75	0.78	0.73	0.70	0.83	0.76	0.71	0.75
	1.0	0.57	0.66	0.62	0.68	0.78	0.69	0.61	0.60
	1.2	0.33	0.51	0.51	0.64	0.75	0.63	0.52	0.44
	1.4	0.14	0.37	0.42	0.60	0.72	0.59	0.44	0.30
	1.6	0.10	0.25	0.33	0.57	0.69	0.55	0.36	0.20
	1.8	0.05	0.12	0.25	0.53	0.67	0.51	0.29	0.10
	2.0	0.00	0.00	0.17	0.50	0.64	0.48	0.21	0.00

Deemed-to-Satisfy Provisions

Table J2.4c HEATING SHADING MULTIPLIER (S_H)— continued

G (refer Figure J2.4)	P/H (refer Figure J2.4)	Orientation Sector (refer Figure J2.3)							
		North	North east	East	South east	South	South west	West	North west
More than 500 mm but not more than 1200 mm	0.0	1.00	1.00	1.00	1.00	1.00	1.00	1.00	1.00
	0.2	1.00	0.99	0.99	0.99	0.99	0.99	0.99	0.99
	0.4	0.99	0.98	0.97	0.96	0.97	0.96	0.96	0.98
	0.6	0.97	0.96	0.93	0.92	0.94	0.92	0.92	0.96
	0.8	0.94	0.93	0.89	0.87	0.91	0.88	0.87	0.92
	1.0	0.88	0.88	0.83	0.82	0.87	0.83	0.81	0.86
	1.2	0.79	0.82	0.77	0.77	0.85	0.79	0.75	0.79
	1.4	0.66	0.73	0.69	0.73	0.82	0.75	0.68	0.69
	1.6	0.48	0.63	0.62	0.69	0.79	0.70	0.61	0.57
	1.8	0.30	0.53	0.54	0.66	0.76	0.66	0.55	0.45
	2.0	0.13	0.42	0.47	0.63	0.74	0.62	0.48	0.33
More than 1200 mm but less than 1800 mm	0.0	1.00	1.00	1.00	1.00	1.00	1.00	1.00	1.00
	0.2	1.00	1.00	1.00	1.00	1.00	0.99	0.99	1.00
	0.4	0.99	0.99	0.98	0.98	0.98	0.98	0.98	0.99
	0.6	0.99	0.98	0.97	0.96	0.96	0.95	0.96	0.98
	0.8	0.98	0.96	0.94	0.93	0.94	0.93	0.93	0.96
	1.0	0.96	0.94	0.91	0.89	0.92	0.90	0.89	0.93
	1.2	0.92	0.91	0.87	0.86	0.90	0.86	0.84	0.89
	1.4	0.85	0.87	0.82	0.82	0.87	0.83	0.80	0.84
	1.6	0.76	0.81	0.77	0.79	0.85	0.80	0.74	0.77
	1.8	0.67	0.75	0.72	0.75	0.83	0.77	0.69	0.69
	2.0	0.57	0.69	0.67	0.72	0.81	0.74	0.64	0.62

Deemed-to-Satisfy Provisions

Table J2.4c HEATING SHADING MULTIPLIER (S_H)— continued

G (refer Figure J2.4)	P/H (refer Figure J2.4)	Orientation Sector (refer Figure J2.3)							
		North	North east	East	South east	South	South west	West	North west
CLIMATE ZONE 8									
Not more than 100 mm	0.0	1.00	1.00	1.00	1.00	1.00	1.00	1.00	1.00
	0.2	0.90	0.91	0.90	0.93	0.93	0.91	0.92	0.91
	0.4	0.73	0.77	0.77	0.89	0.85	0.80	0.80	0.77
	0.6	0.55	0.63	0.68	0.83	0.77	0.72	0.68	0.62
	0.8	0.37	0.50	0.61	0.75	0.71	0.67	0.57	0.48
	1.0	0.19	0.35	0.53	0.67	0.66	0.64	0.49	0.37
	1.2	0.07	0.22	0.44	0.60	0.62	0.62	0.43	0.29
	1.4	0.00	0.12	0.36	0.53	0.59	0.59	0.38	0.21
	1.6	0.00	0.08	0.29	0.48	0.56	0.56	0.34	0.15
	1.8	0.00	0.04	0.23	0.43	0.53	0.52	0.31	0.09
2.0	0.00	0.00	0.16	0.38	0.51	0.48	0.27	0.04	
More than 100 mm but not more than 500 mm	0.0	1.00	1.00	1.00	1.00	1.00	1.00	1.00	1.00
	0.2	0.96	0.96	0.95	0.95	0.96	0.95	0.96	0.96
	0.4	0.87	0.89	0.87	0.91	0.90	0.87	0.89	0.88
	0.6	0.73	0.79	0.78	0.87	0.85	0.81	0.81	0.78
	0.8	0.57	0.67	0.70	0.81	0.79	0.73	0.72	0.66
	1.0	0.42	0.56	0.64	0.79	0.75	0.69	0.63	0.54
	1.2	0.27	0.45	0.59	0.74	0.71	0.66	0.55	0.43
	1.4	0.17	0.32	0.52	0.67	0.67	0.63	0.49	0.35
	1.6	0.10	0.22	0.46	0.62	0.64	0.62	0.44	0.28
	1.8	0.03	0.13	0.39	0.57	0.62	0.61	0.40	0.22
2.0	0.00	0.00	0.00	0.10	0.50	0.50	0.00	0.00	

Deemed-to-Satisfy Provisions

Table J2.4c HEATING SHADING MULTIPLIER (S_H)— continued

G (refer Figure J2.4)	P/H (refer Figure J2.4)	Orientation Sector (refer Figure J2.3)							
		North	North east	East	South east	South	South west	West	North west
More than 500 mm but not more than 1200 mm	0.0	1.00	1.00	1.00	1.00	1.00	1.00	1.00	1.00
	0.2	0.99	0.99	0.99	0.98	0.99	0.99	0.99	0.99
	0.4	0.97	0.97	0.96	0.95	0.96	0.95	0.96	0.97
	0.6	0.93	0.94	0.92	0.92	0.93	0.91	0.93	0.92
	0.8	0.85	0.89	0.87	0.88	0.90	0.86	0.88	0.87
	1.0	0.75	0.82	0.79	0.86	0.86	0.82	0.83	0.80
	1.2	0.65	0.73	0.74	0.86	0.82	0.78	0.77	0.72
	1.4	0.54	0.65	0.69	0.85	0.79	0.73	0.71	0.64
	1.6	0.42	0.56	0.66	0.81	0.76	0.70	0.65	0.55
	1.8	0.31	0.48	0.62	0.76	0.73	0.66	0.60	0.47
	2.0	0.20	0.39	0.58	0.72	0.70	0.63	0.54	0.39
More than 1200 mm but less than 1800 mm	0.0	1.00	1.00	1.00	1.00	1.00	1.00	1.00	1.00
	0.2	1.00	1.00	0.99	0.99	1.00	0.99	0.99	0.99
	0.4	0.98	0.98	0.98	0.98	0.98	0.98	0.98	0.98
	0.6	0.96	0.97	0.96	0.96	0.96	0.95	0.96	0.96
	0.8	0.93	0.94	0.92	0.94	0.94	0.91	0.93	0.93
	1.0	0.88	0.91	0.89	0.91	0.91	0.89	0.90	0.89
	1.2	0.80	0.86	0.84	0.88	0.89	0.86	0.86	0.84
	1.4	0.72	0.80	0.78	0.87	0.86	0.83	0.81	0.78
	1.6	0.63	0.74	0.75	0.87	0.84	0.80	0.77	0.72
	1.8	0.54	0.67	0.71	0.86	0.82	0.77	0.72	0.65
	2.0	0.45	0.60	0.67	0.86	0.79	0.74	0.68	0.58

Notes:

1. In *climate zones* 4 to 8, where G is 1800 mm or more, the heating shading multiplier is to be taken as 1.0.
2. The heating shading multiplier for P/H values between those shown in **Table J2.4c** can be interpolated.

Deemed-to-Satisfy Provisions

Table J2.4d COOLING SHADING MULTIPLIER (S_c)

G (refer Figure J2.4)	P/H (refer Figure J2.4)	Orientation Sector (refer Figure J2.3)							
		North	North east	East	South east	South	South west	West	North west
CLIMATE ZONES 1, 2 AND 3									
Not more than 100 mm	0.0	1.00	1.00	1.00	1.00	1.00	1.00	1.00	1.00
	0.2	0.79	0.84	0.86	0.85	0.87	0.87	0.87	0.84
	0.4	0.57	0.66	0.71	0.70	0.76	0.73	0.72	0.67
	0.6	0.41	0.52	0.58	0.58	0.68	0.62	0.60	0.53
	0.8	0.32	0.40	0.47	0.48	0.62	0.54	0.50	0.43
	1.0	0.26	0.32	0.39	0.42	0.58	0.48	0.43	0.35
	1.2	0.22	0.28	0.33	0.38	0.56	0.43	0.37	0.30
	1.4	0.20	0.24	0.29	0.34	0.53	0.39	0.33	0.25
	1.6	0.19	0.22	0.26	0.32	0.52	0.36	0.29	0.22
	1.8	0.18	0.20	0.23	0.30	0.50	0.33	0.26	0.20
More than 100 mm but not more than 500 mm	0.0	1.00	1.00	1.00	1.00	1.00	1.00	1.00	1.00
	0.2	0.92	0.94	0.95	0.94	0.93	0.94	0.95	0.94
	0.4	0.72	0.81	0.85	0.83	0.84	0.84	0.85	0.81
	0.6	0.54	0.68	0.73	0.72	0.77	0.75	0.74	0.68
	0.8	0.42	0.56	0.63	0.57	0.71	0.66	0.64	0.56
	1.0	0.34	0.46	0.54	0.54	0.66	0.59	0.56	0.47
	1.2	0.29	0.38	0.46	0.48	0.62	0.54	0.49	0.41
	1.4	0.25	0.32	0.40	0.43	0.60	0.50	0.44	0.35
	1.6	0.23	0.29	0.35	0.40	0.57	0.46	0.39	0.31
	1.8	0.21	0.26	0.32	0.37	0.56	0.42	0.36	0.28
2.0	0.20	0.24	0.29	0.34	0.54	0.39	0.32	0.25	

Deemed-to-Satisfy Provisions

Table J2.4d COOLING SHADING MULTIPLIER (S_c)— continued

G (refer Figure J2.4)	P/H (refer Figure J2.4)	Orientation Sector (refer Figure J2.3)							
		North	North east	East	South east	South	South west	West	North west
More than 500 mm but not more than 1200 mm	0.0	1.00	1.00	1.00	1.00	1.00	1.00	1.00	1.00
	0.2	0.97	0.98	0.98	0.98	0.96	0.98	0.98	0.98
	0.4	0.89	0.93	0.94	0.93	0.91	0.93	0.94	0.92
	0.6	0.74	0.85	0.88	0.86	0.86	0.86	0.87	0.84
	0.8	0.59	0.76	0.81	0.79	0.81	0.80	0.80	0.74
	1.0	0.49	0.66	0.73	0.72	0.77	0.73	0.72	0.66
	1.2	0.41	0.58	0.66	0.65	0.73	0.68	0.66	0.58
	1.4	0.35	0.51	0.59	0.59	0.69	0.63	0.60	0.51
	1.6	0.31	0.44	0.53	0.54	0.66	0.59	0.55	0.46
	1.8	0.28	0.39	0.48	0.50	0.64	0.55	0.50	0.41
	2.0	0.25	0.35	0.43	0.46	0.61	0.51	0.45	0.37
More than 1200 mm but less than 1800 mm	0.0	1.00	1.00	1.00	1.00	1.00	1.00	1.00	1.00
	0.2	0.98	0.99	0.99	0.99	0.98	0.99	0.99	0.99
	0.4	0.94	0.96	0.97	0.96	0.94	0.96	0.96	0.95
	0.6	0.86	0.92	0.93	0.92	0.90	0.91	0.92	0.90
	0.8	0.73	0.85	0.88	0.86	0.86	0.86	0.87	0.83
	1.0	0.59	0.87	0.83	0.80	0.82	0.81	0.81	0.76
	1.2	0.51	0.70	0.76	0.75	0.79	0.76	0.75	0.69
	1.4	0.44	0.63	0.71	0.70	0.76	0.71	0.70	0.62
	1.6	0.38	0.57	0.65	0.64	0.73	0.67	0.64	0.56
	1.8	0.34	0.52	0.60	0.60	0.70	0.63	0.60	0.51
	2.0	0.30	0.46	0.55	0.56	0.67	0.60	0.55	0.46

Deemed-to-Satisfy Provisions

Table J2.4d COOLING SHADING MULTIPLIER (S_c)— continued

G (refer Figure J2.4)	P/H (refer Figure J2.4)	Orientation Sector (refer Figure J2.3)								
		North	North east	East	South east	South	South west	West	North west	
CLIMATE ZONES 4 AND 5										
Not more than 100 mm	0.0	1.00	1.00	1.00	1.00	1.00	1.00	1.00	1.00	1.00
	0.2	0.81	0.85	0.87	0.86	0.90	0.88	0.87	0.84	0.84
	0.4	0.61	0.68	0.72	0.72	0.81	0.75	0.72	0.67	0.67
	0.6	0.46	0.54	0.59	0.61	0.74	0.64	0.60	0.53	0.53
	0.8	0.35	0.42	0.49	0.53	0.68	0.57	0.51	0.42	0.42
	1.0	0.28	0.34	0.42	0.47	0.64	0.50	0.44	0.34	0.34
	1.2	0.24	0.29	0.37	0.43	0.62	0.46	0.38	0.29	0.29
	1.4	0.22	0.26	0.33	0.39	0.59	0.42	0.34	0.26	0.26
	1.6	0.20	0.23	0.30	0.36	0.57	0.39	0.31	0.24	0.24
	1.8	0.20	0.21	0.27	0.34	0.56	0.37	0.29	0.22	0.22
	2.0	0.19	0.20	0.25	0.32	0.54	0.34	0.26	0.21	0.21
More than 100 mm but not more than 500 mm	0.0	1.00	1.00	1.00	1.00	1.00	1.00	1.00	1.00	1.00
	0.2	0.93	0.95	0.96	0.95	0.96	0.95	0.95	0.95	0.95
	0.4	0.77	0.83	0.86	0.85	0.89	0.86	0.85	0.82	0.82
	0.6	0.62	0.70	0.74	0.74	0.82	0.77	0.74	0.68	0.68
	0.8	0.48	0.58	0.64	0.60	0.76	0.68	0.64	0.56	0.56
	1.0	0.37	0.48	0.55	0.58	0.72	0.61	0.56	0.46	0.46
	1.2	0.32	0.40	0.48	0.52	0.68	0.56	0.50	0.39	0.39
	1.4	0.28	0.35	0.43	0.48	0.66	0.52	0.44	0.34	0.34
	1.6	0.25	0.30	0.39	0.45	0.64	0.48	0.40	0.30	0.30
	1.8	0.23	0.27	0.35	0.42	0.62	0.45	0.37	0.27	0.27
	2.0	0.21	0.25	0.32	0.39	0.60	0.42	0.34	0.25	0.25

Deemed-to-Satisfy Provisions

Table J2.4d COOLING SHADING MULTIPLIER (S_c)— continued

G (refer Figure J2.4)	P/H (refer Figure J2.4)	Orientation Sector (refer Figure J2.3)							
		North	North east	East	South east	South	South west	West	North west
More than 500 mm but not more than 1200 mm	0.0	1.00	1.00	1.00	1.00	1.00	1.00	1.00	1.00
	0.2	0.97	0.98	0.98	0.98	0.98	0.98	0.98	0.98
	0.4	0.90	0.94	0.94	0.94	0.95	0.94	0.94	0.93
	0.6	0.81	0.86	0.88	0.87	0.91	0.88	0.88	0.85
	0.8	0.70	0.77	0.81	0.81	0.87	0.81	0.80	0.75
	1.0	0.58	0.68	0.74	0.74	0.82	0.76	0.73	0.66
	1.2	0.47	0.60	0.67	0.68	0.79	0.70	0.66	0.58
	1.4	0.40	0.52	0.61	0.62	0.75	0.65	0.60	0.50
	1.6	0.35	0.46	0.55	0.58	0.73	0.61	0.55	0.44
	1.8	0.31	0.41	0.50	0.54	0.70	0.57	0.50	0.39
	2.0	0.27	0.36	0.45	0.50	0.68	0.54	0.46	0.35
More than 1200 mm but less than 1800 mm	0.0	1.00	1.00	1.00	1.00	1.00	1.00	1.00	1.00
	0.2	0.98	0.99	0.99	0.99	0.99	0.99	0.99	0.99
	0.4	0.94	0.97	0.97	0.96	0.97	0.96	0.97	0.96
	0.6	0.88	0.92	0.93	0.93	0.94	0.92	0.93	0.91
	0.8	0.82	0.87	0.88	0.88	0.91	0.88	0.88	0.85
	1.0	0.72	0.80	0.83	0.82	0.88	0.83	0.82	0.77
	1.2	0.63	0.72	0.77	0.77	0.85	0.78	0.76	0.70
	1.4	0.53	0.65	0.72	0.73	0.82	0.74	0.71	0.63
	1.6	0.45	0.59	0.67	0.67	0.79	0.70	0.66	0.56
	1.8	0.40	0.53	0.62	0.63	0.77	0.66	0.61	0.50
	2.0	0.36	0.48	0.57	0.59	0.74	0.62	0.56	0.45

Deemed-to-Satisfy Provisions

Table J2.4d COOLING SHADING MULTIPLIER (S_c)— continued

G (refer Figure J2.4)	P/H (refer Figure J2.4)	Orientation Sector (refer Figure J2.3)								
		North	North east	East	South east	South	South west	West	North west	
CLIMATE ZONES 6 AND 7										
Not more than 100 mm	0.0	1.00	1.00	1.00	1.00	1.00	1.00	1.00	1.00	1.00
	0.2	0.82	0.86	0.87	0.87	0.90	0.88	0.87	0.84	0.84
	0.4	0.63	0.69	0.72	0.74	0.80	0.74	0.72	0.67	0.67
	0.6	0.49	0.56	0.60	0.64	0.73	0.64	0.61	0.54	0.54
	0.8	0.40	0.46	0.51	0.56	0.68	0.57	0.52	0.44	0.44
	1.0	0.35	0.38	0.44	0.51	0.64	0.51	0.45	0.38	0.38
	1.2	0.32	0.34	0.39	0.48	0.61	0.47	0.41	0.35	0.35
	1.4	0.31	0.32	0.36	0.45	0.59	0.44	0.37	0.32	0.32
	1.6	0.30	0.30	0.33	0.42	0.57	0.42	0.34	0.31	0.31
	1.8	0.30	0.29	0.31	0.41	0.56	0.40	0.32	0.30	0.30
2.0	0.30	0.28	0.29	0.39	0.55	0.38	0.31	0.29	0.29	
More than 100 mm but not more than 500 mm	0.0	1.00	1.00	1.00	1.00	1.00	1.00	1.00	1.00	1.00
	0.2	0.93	0.95	0.95	0.95	0.95	0.95	0.95	0.95	0.95
	0.4	0.79	0.84	0.86	0.86	0.88	0.86	0.85	0.82	0.82
	0.6	0.64	0.71	0.75	0.76	0.81	0.76	0.74	0.68	0.68
	0.8	0.52	0.60	0.65	0.63	0.75	0.68	0.65	0.57	0.57
	1.0	0.43	0.51	0.57	0.61	0.71	0.61	0.57	0.48	0.48
	1.2	0.38	0.44	0.50	0.56	0.68	0.56	0.50	0.42	0.42
	1.4	0.35	0.39	0.45	0.52	0.65	0.52	0.46	0.38	0.38
	1.6	0.33	0.35	0.41	0.49	0.63	0.49	0.42	0.35	0.35
	1.8	0.32	0.33	0.38	0.47	0.62	0.46	0.39	0.33	0.33
2.0	0.31	0.31	0.36	0.45	0.60	0.44	0.36	0.32	0.32	

Deemed-to-Satisfy Provisions

Table J2.4d COOLING SHADING MULTIPLIER (S_c)— continued

G (refer Figure J2.4)	P/H (refer Figure J2.4)	Orientation Sector (refer Figure J2.3)							
		North	North east	East	South east	South	South west	West	North west
More than 500 mm but not more than 1200 mm	0.0	1.00	1.00	1.00	1.00	1.00	1.00	1.00	1.00
	0.2	0.97	0.98	0.98	0.98	0.98	0.98	0.98	0.98
	0.4	0.91	0.94	0.94	0.94	0.94	0.94	0.94	0.93
	0.6	0.82	0.87	0.88	0.88	0.90	0.88	0.87	0.85
	0.8	0.72	0.79	0.81	0.82	0.85	0.81	0.80	0.75
	1.0	0.62	0.70	0.74	0.76	0.81	0.75	0.73	0.66
	1.2	0.53	0.62	0.67	0.70	0.77	0.70	0.67	0.58
	1.4	0.47	0.55	0.62	0.65	0.74	0.65	0.61	0.51
	1.6	0.42	0.49	0.56	0.61	0.72	0.61	0.56	0.46
	1.8	0.38	0.44	0.51	0.57	0.69	0.57	0.51	0.42
	2.0	0.35	0.40	0.47	0.54	0.67	0.54	0.47	0.38
More than 1200 mm but less than 1800 mm	0.0	1.00	1.00	1.00	1.00	1.00	1.00	1.00	1.00
	0.2	0.99	0.99	0.99	0.99	0.99	0.99	0.99	0.99
	0.4	0.95	0.97	0.97	0.96	0.97	0.96	0.97	0.96
	0.6	0.89	0.93	0.93	0.93	0.94	0.92	0.93	0.91
	0.8	0.82	0.87	0.88	0.88	0.90	0.88	0.87	0.85
	1.0	0.75	0.81	0.83	0.83	0.87	0.83	0.82	0.78
	1.2	0.67	0.74	0.78	0.79	0.83	0.78	0.76	0.70
	1.4	0.59	0.68	0.72	0.74	0.80	0.74	0.71	0.63
	1.6	0.52	0.61	0.67	0.70	0.77	0.70	0.66	0.57
	1.8	0.47	0.56	0.63	0.66	0.75	0.66	0.61	0.52
	2.0	0.43	0.51	0.58	0.62	0.73	0.63	0.57	0.47

Deemed-to-Satisfy Provisions

Table J2.4d COOLING SHADING MULTIPLIER (S_c)— continued

G (refer Figure J2.4)	P/H (refer Figure J2.4)	Orientation Sector (refer Figure J2.3)								
		North	North east	East	South east	South	South west	West	North west	
CLIMATE ZONE 8										
Not more than 100 mm	0.0	1.00	1.00	1.00	1.00	1.00	1.00	1.00	1.00	1.00
	0.2	0.78	0.83	0.86	0.85	0.87	0.86	0.86	0.86	0.83
	0.4	0.58	0.65	0.70	0.71	0.75	0.73	0.71	0.71	0.65
	0.6	0.47	0.52	0.58	0.61	0.67	0.63	0.60	0.60	0.53
	0.8	0.43	0.44	0.49	0.54	0.62	0.56	0.52	0.52	0.45
	1.0	0.42	0.40	0.44	0.50	0.59	0.51	0.47	0.47	0.41
	1.2	0.41	0.39	0.41	0.48	0.57	0.48	0.43	0.43	0.39
	1.4	0.41	0.38	0.39	0.46	0.56	0.46	0.40	0.40	0.38
	1.6	0.40	0.37	0.37	0.45	0.55	0.45	0.39	0.39	0.37
	1.8	0.40	0.37	0.36	0.44	0.54	0.44	0.38	0.38	0.37
	2.0	0.40	0.36	0.36	0.43	0.53	0.44	0.37	0.37	0.37
More than 100 mm but not more than 500 mm	0.0	1.00	1.00	1.00	1.00	1.00	1.00	1.00	1.00	1.00
	0.2	0.91	0.94	0.95	0.94	0.94	0.95	0.95	0.95	0.94
	0.4	0.74	0.81	0.84	0.83	0.85	0.84	0.85	0.85	0.80
	0.6	0.58	0.66	0.73	0.73	0.77	0.75	0.74	0.74	0.67
	0.8	0.48	0.55	0.62	0.60	0.70	0.66	0.65	0.65	0.56
	1.0	0.44	0.47	0.54	0.58	0.65	0.60	0.57	0.57	0.48
	1.2	0.43	0.42	0.49	0.54	0.62	0.55	0.51	0.51	0.44
	1.4	0.42	0.40	0.45	0.51	0.60	0.52	0.47	0.47	0.41
	1.6	0.41	0.39	0.42	0.49	0.58	0.49	0.44	0.44	0.39
	1.8	0.41	0.38	0.40	0.47	0.57	0.48	0.42	0.42	0.38
	2.0	0.41	0.37	0.38	0.46	0.56	0.46	0.40	0.40	0.38

Deemed-to-Satisfy Provisions

Table J2.4d COOLING SHADING MULTIPLIER (S_c)— continued

G (refer Figure J2.4)	P/H (refer Figure J2.4)	Orientation Sector (refer Figure J2.3)							
		North	North east	East	South east	South	South west	West	North west
More than 500 mm but not more than 1200 mm	0.0	1.00	1.00	1.00	1.00	1.00	1.00	1.00	1.00
	0.2	0.97	0.98	0.98	0.98	0.97	0.98	0.98	0.97
	0.4	0.88	0.93	0.94	0.93	0.93	0.93	0.93	0.92
	0.6	0.78	0.84	0.87	0.86	0.87	0.86	0.87	0.83
	0.8	0.66	0.74	0.79	0.79	0.81	0.80	0.80	0.74
	1.0	0.56	0.64	0.71	0.72	0.75	0.73	0.73	0.64
	1.2	0.49	0.56	0.65	0.66	0.71	0.68	0.66	0.57
	1.4	0.46	0.50	0.59	0.61	0.68	0.64	0.61	0.51
	1.6	0.44	0.45	0.54	0.57	0.66	0.60	0.56	0.47
	1.8	0.43	0.42	0.49	0.54	0.63	0.57	0.52	0.44
	2.0	0.42	0.40	0.46	0.52	0.61	0.53	0.49	0.42
More than 1200 mm but less than 1800 mm	0.0	1.00	1.00	1.00	1.00	1.00	1.00	1.00	1.00
	0.2	0.98	0.99	0.99	0.99	0.99	0.99	0.99	0.99
	0.4	0.93	0.96	0.96	0.96	0.95	0.96	0.96	0.95
	0.6	0.86	0.91	0.93	0.91	0.91	0.91	0.92	0.90
	0.8	0.78	0.84	0.87	0.86	0.87	0.86	0.87	0.83
	1.0	0.69	0.77	0.82	0.80	0.82	0.81	0.81	0.76
	1.2	0.60	0.69	0.75	0.75	0.78	0.76	0.76	0.68
	1.4	0.54	0.62	0.69	0.70	0.74	0.72	0.70	0.62
	1.6	0.49	0.55	0.65	0.65	0.71	0.68	0.66	0.56
	1.8	0.47	0.50	0.60	0.62	0.69	0.64	0.61	0.52
	2.0	0.45	0.46	0.55	0.58	0.67	0.61	0.57	0.48

Notes:

1. Where G is 1800 mm or more, the cooling shading multiplier is to be taken as 1.0.
2. The cooling shading multiplier for P/H values between those shown in **Table J2.4d** can be interpolated.

Deemed-to-Satisfy Provisions

Table J2.4e SHADING MULTIPLIERS FOR GLAZING IN THE INTERNAL FABRIC

<i>Climate zone</i>	Shading multiplier	
	Heating (S_H)	Cooling (S_C)
1, 2 and 3	1.0	0.49
4 and 5	0.64	0.54
6 and 7	0.55	0.55
8	0.51	0.53

Figure J2.3

ORIENTATION SECTORS

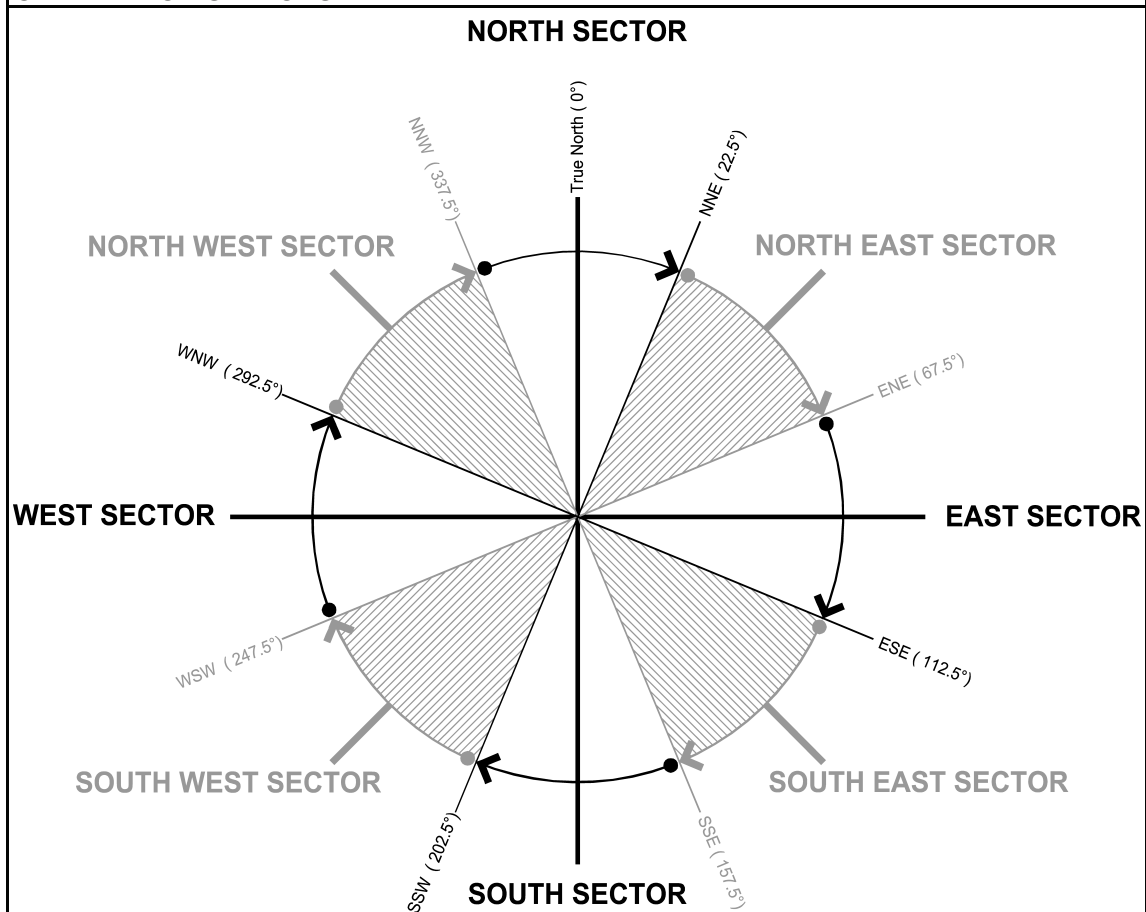

Note: The orientation sector for a wall or *glazing* element is the sector that contains a line drawn perpendicular to the face of the wall or *glazing* element.

Deemed-to-Satisfy Provisions

Figure J2.4

METHOD OF MEASURING P AND H

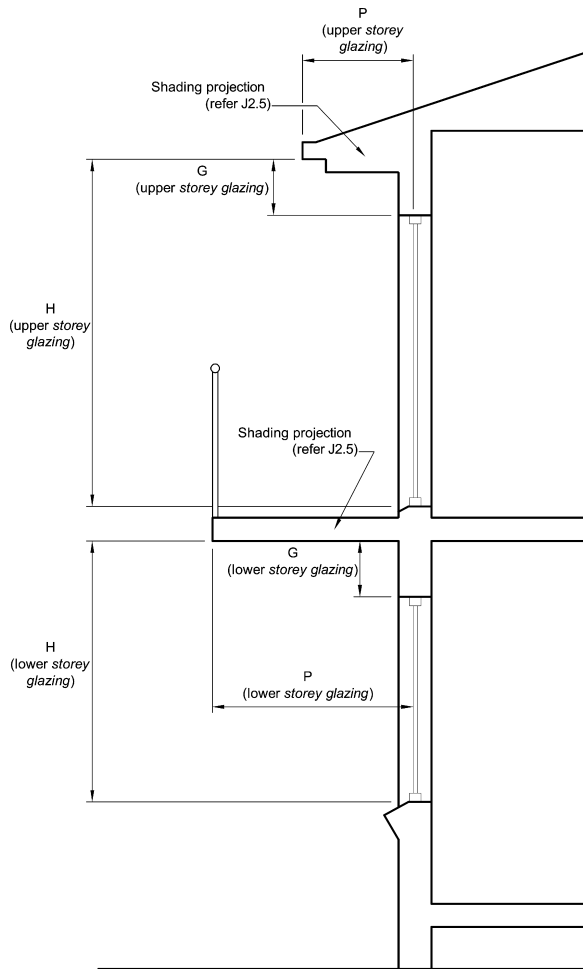

Note: An external shading device that complies with **J2.5(b)** is considered to achieve a P/H value of 2.

J2.5 Shading

Where shading is *required* to comply with **J2.4**, it must—

- (a) be provided by an external permanent projection, such as a verandah, balcony, fixed canopy, eaves or shading hood, which—
 - (i) extends horizontally on both sides of the *glazing* for the same projection distance P in **Figure J2.4**; or
 - (ii) provides the equivalent shading to (i) with a reveal or the like; or
- (b) be provided by an external shading device, such as a shutter, blind, vertical or horizontal building screen with blades, battens or slats, which—

Deemed-to-Satisfy Provisions

- (i) is capable of restricting at least 80% of summer solar radiation; and
- (ii) if adjustable, is operated automatically in response to the level of solar radiation.

PART J3 BUILDING SEALING

Deemed-to-Satisfy Provisions

J3.0 Deemed-to-Satisfy Provisions

- (a) Where a *Deemed-to-Satisfy Solution* is proposed, *Performance Requirements JP1* and **JP3** are satisfied by complying with—
- (i) **J0.1** to **J0.3**; and
 - (ii) **J1.1** to **J1.6**; and
 - (iii) **J2.1** to **J2.5**; and
 - (iv) **J3.1** to **J3.7**; and
 - (v) **J5.1** to **J5.4**; and
 - (vi) **J6.1** to **J6.6**; and
 - (vii) **J7.1** to **J7.4**; and
 - (viii) **J8.1** to **J8.3**.
- (b) Where a *Performance Solution* is proposed, the relevant *Performance Requirements* must be determined in accordance with **A0.7**.

J3.1 Application of Part

The *Deemed-to-Satisfy Provisions* of this Part apply to elements forming the *envelope* of a Class 2 to 9 building, other than—

- (a) a building in *climate zones* 1, 2, 3 and 5 where the only means of *air-conditioning* is by using an evaporative cooler; or
- (b) a permanent building opening, in a space where a gas appliance is located, that is necessary for the safe operation of a gas appliance; or
- (c) a building or space where the mechanical ventilation *required* by **Part F4** provides sufficient pressurisation to prevent infiltration.

NSW J3.1(d)

J3.2 Chimneys and flues

The chimney or flue of an open solid-fuel burning appliance must be provided with a damper or flap that can be closed to seal the chimney or flue.

J3.3 Roof lights

- (a) A *roof light* must be sealed, or capable of being sealed, when serving—
 - (i) a *conditioned space*; or
 - (ii) a *habitable room* in *climate zones* 4, 5, 6, 7 or 8.
- (b) A *roof light required* by (a) to be sealed, or capable of being sealed, must be constructed with—

Deemed-to-Satisfy Provisions

- (i) an imperforate ceiling diffuser or the like installed at the ceiling or internal lining level; or
- (ii) a weatherproof seal; or
- (iii) a shutter system readily operated either manually, mechanically or electronically by the occupant.

J3.4 Windows and doors

- (a) A seal to restrict air infiltration must be fitted to each edge of a door, openable *window* or the like forming part of—
 - (i) the *envelope* of a *conditioned space*; or
 - (ii) the external fabric of a *habitable room* or public area in *climate zones* 4, 5, 6, 7 or 8.
- (b) The requirements of (a) do not apply to—
 - (i) a *window* complying with AS 2047; or
 - (ii) a fire door or smoke door; or
 - (iii) a roller shutter door, roller shutter grille or other security door or device installed only for out-of-hours security.
- (c) A seal *required* by (a)—
 - (i) for the bottom edge of an external swing door, must be a draft protection device; and
 - (ii) for the other edges of an external door or the edges of an openable *window* or other such opening, may be a foam or rubber compression strip, fibrous seal or the like.
- (d) An entrance to a building, if leading to a *conditioned space* must have an airlock, *self-closing* door, revolving door or the like, other than—
 - (i) where the *conditioned space* has a *floor area* of not more than 50 m²; or
 - (ii) where a café, restaurant, open front shop or the like has—
 - (A) a 3 m deep un-conditioned zone between the main entrance, including an open front, and the *conditioned space*; and
 - (B) at all other entrances to the café, restaurant, open front shop or the like, *self-closing* doors.

J3.5 Exhaust fans

A miscellaneous exhaust fan, such as a bathroom or domestic kitchen exhaust fan, must be fitted with a sealing device such as a self-closing damper or the like when serving—

- (a) a *conditioned space*; or
- (b) a *habitable room* in *climate zones* 4, 5, 6, 7 or 8.

Deemed-to-Satisfy Provisions

J3.6 Construction of roofs, walls and floors

- (a) Roofs, ceilings, walls, floors and any opening such as a *window* frame, door frame, *roof light* frame or the like must be constructed to minimise air leakage in accordance with (b) when forming part of—
 - (i) the *envelope*; or
 - (ii) the external *fabric* of a *habitable room* or a public area in *climate zones* 4, 5, 6, 7 or 8.
- (b) Construction *required* by (a) must be—
 - (i) enclosed by internal lining systems that are close fitting at ceiling, wall and floor junctions; or
 - (ii) sealed by caulking, skirting, architraves, cornices or the like.
- (c) The requirements of (a) do not apply to openings, grilles or the like *required* for smoke hazard management.

J3.7 Evaporative coolers

An evaporative cooler must be fitted with a self-closing damper or the like when serving—

- (a) a heated space; or
- (b) a *habitable room* or a public area of a building in *climate zones* 4, 5, 6, 7 or 8.

PART J4

* * * * *

This Part has deliberately been left blank.

PART J5

AIR-CONDITIONING AND VENTILATION SYSTEMS

Deemed-to-Satisfy Provisions

J5.0 Deemed-to-Satisfy Provisions

- (a) Where a *Deemed-to-Satisfy Solution* is proposed, *Performance Requirements JP1* and *JP3* are satisfied by complying with—
- (i) **J0.1** to **J0.3**; and
 - (ii) **J1.1** to **J1.6**; and
 - (iii) **J2.1** to **J2.5**; and
 - (iv) **J3.1** to **J3.7**; and
 - (v) **J5.1** to **J5.4**; and
 - (vi) **J6.1** to **J6.6**; and
 - (vii) **J7.1** to **J7.4**; and
 - (viii) **J8.1** to **J8.3**.
- (b) Where a *Performance Solution* is proposed, the relevant *Performance Requirements* must be determined in accordance with **A0.7**.

J5.1 Application of Part

The *Deemed-to-Satisfy Provisions* of this Part do not apply to a Class 8 *electricity network substation*.

J5.2 Air-conditioning systems

- (a) **Control** —
- (i) An *air-conditioning* system—
 - (A) must be capable of being deactivated when the building or part of a building served by that system is not occupied; and
 - (B) when serving more than one *air-conditioning* zone or area with different heating or cooling needs, must—
 - (aa) thermostatically control the temperature of each zone or area; and
 - (bb) not control the temperature by mixing actively heated air and actively cooled air; and
 - (cc) limit reheating to not more than—
 - (AA) for a fixed supply air rate, a 7.5 K rise in temperature; and
 - (BB) for a variable supply air rate, a 7.5 K rise in temperature at the nominal supply air rate but increased or decreased at the same rate that the supply air rate is respectively decreased or increased; and

Deemed-to-Satisfy Provisions

- (C) which provides the *required* mechanical ventilation, other than in process-related applications where humidity control is needed, must have an *outdoor air economy cycle*—
 - (aa) in *climate zones* 2 or 3, when the *air-conditioning* system capacity is more than 50 kW_r; or
 - (bb) in *climate zones* 4, 5, 6, 7 or 8, when the *air-conditioning* system capacity is more than 35 kW_r; and
 - (D) which contains more than one water heater, chiller or coil, must be capable of stopping the flow of water to those not operating; and
 - (E) except for a packaged *air-conditioning* system, must have a variable speed fan when its supply air quantity is capable of being varied; and
 - (F) when serving a *sole-occupancy unit* in a Class 3 building, must not operate when any external door of the *sole-occupancy unit* that opens to a balcony or the like, is open for more than one minute.
- (ii) When an *air-conditioning* system is deactivated, any motorised outside air and return dampers must close.
 - (iii) Compliance with (i) must not adversely affect—
 - (A) smoke hazard management measures *required* by **Part E2**; and
 - (B) ventilation *required* by **Part E3** and **Part F4**.
- (b) **Fans** — Fans of an *air-conditioning* system must comply with **Specification J5.2a**.
- (c) **Pumps** —
- (i) An *air-conditioning* system, where water is circulated by pumping at more than 2 L/s, must be designed so that the maximum *pump power* to the pump complies with **Table J5.2**.
 - (ii) An *air-conditioning* system pump that is rated at more than 3 kW of *pump power* and circulates water at more than 2 L/s must be capable of varying its speed in response to varying load.
 - (iii) A spray water pump of an *air-conditioning* system's closed circuit cooler or evaporative condenser must not use more than 150 W of *pump power* for each L/s of spray water circulated.

Table J5.2 MAXIMUM PUMP POWER

Cooling or heating load (W/m ² of the <i>floor area</i> of the <i>conditioned space</i>)	Maximum <i>pump power</i> (W/m ² of the <i>floor area</i> of the <i>conditioned space</i>)		
	Chilled water	Condenser water	Heating water
Up to 100	1.3	0.9	1.0
101 to 150	1.9	1.2	1.3
151 to 200	2.2	2.2	1.7
201 to 300	4.3	3.0	2.5
301 to 400	5.0	3.6	3.2

Deemed-to-Satisfy Provisions

Table J5.2 MAXIMUM PUMP POWER— continued

Cooling or heating load (W/m ² of the floor area of the conditioned space)	Maximum pump power (W/m ² of the floor area of the conditioned space)		
	Chilled water	Condenser water	Heating water
More than 400	5.6	5.6	3.6

Note: Values do not include any motor losses.

- (d) **Insulation** —
- (i) The ductwork of an *air-conditioning* system must be insulated and sealed in accordance with **Specification J5.2b**.
 - (ii) *Piping*, vessels, heat exchangers and tanks containing heating or cooling fluid that are part of an *air-conditioning* system, other than those with insulation levels covered by MEPS, must be insulated in accordance with **Specification J5.2c**.
- (e) **Space heating** — A heater used for *air-conditioning* or as part of an *air-conditioning* system must comply with **Specification J5.2d**.
- (f) **Energy efficiency ratios** —
- (i) refrigerant chillers used as part of an *air-conditioning* system; and
 - (ii) packaged *air-conditioning* equipment, must comply with **Specification J5.2e**.
- (g) **Time switches** —
- (i) A time switch complying with **Specification J6** must be provided to control—
 - (A) an *air-conditioning* system of more than 10 kW_r; and
 - (B) a heater of more than 10 kW_{heating} used for *air-conditioning*.
 - (ii) The requirements of (i) do not apply to—
 - (A) an *air-conditioning* system that serves—
 - (aa) only one *sole-occupancy unit* in a Class 2 or 3 building; or
 - (bb) a Class 4 part of a building; or
 - (cc) only one *sole-occupancy unit* in a Class 9c building; or
 - (B) a building where *air-conditioning* is needed for 24 hour occupancy.

J5.3 Mechanical ventilation systems

- (a) **Control** —
- (i) A mechanical ventilation system, including one that is part of an *air-conditioning* system, except where the mechanical system serves only one *sole-occupancy unit* in a Class 2 building or serves only a Class 4 part of a building, must—
 - (A) be capable of being deactivated when the building or part of the building served by that system is not occupied; and
 - (B) when serving a *conditioned space*—

Deemed-to-Satisfy Provisions

- (aa) not exceed the minimum *outdoor air* quantity *required* by **Part F4**, where relevant, by more than 20%; and
- (bb) in other than *climate zone* 2, where the number of square metres per person is not more than 1 as specified in **D1.13** and the air flow rate is more than 1000 L/s, have—
 - (AA) an energy reclaiming system that preconditions outside air; or
 - (BB) the ability to automatically modulate the mechanical ventilation *required* by **Part F4** in proportion to the number of occupants.
- (ii) The requirements of **(a)(i)(B)(aa)** do not apply where—
 - (A) additional unconditioned outside air is supplied for free cooling or to balance process exhaust; or
 - (B) additional exhaust ventilation is needed to balance the *required* mechanical ventilation; or
 - (C) an energy reclaiming system preconditions all the outside air.
- (iii) Compliance with **(a)(i)** must not adversely affect—
 - (A) smoke hazard management measures *required* by **Part E2**; and
 - (B) ventilation *required* by **Part E3** and **Part F4**.
- (b) **Fans** — Fans of a mechanical ventilation system covered by **(a)** must comply with **Specification J5.2a**.
- (c) **Time switches** —
 - (i) A time switch complying with **Specification J6** must be provided to control a mechanical ventilation system with an air flow rate of more than 1000 L/s.
 - (ii) The requirements of **(i)** do not apply to—
 - (A) a mechanical ventilation system that serves—
 - (aa) only one *sole-occupancy unit* in a Class 2 or 3 building; or
 - (bb) a Class 4 part of a building; or
 - (cc) only one *sole-occupancy unit* in a Class 9c building; or
 - (B) a building where mechanical ventilation is needed for 24 hour occupancy.

J5.4 Miscellaneous exhaust systems

- (a) A miscellaneous exhaust system with an air flow rate of more than 1000 L/s, that is associated with equipment having a variable demand, must—
 - (i) be capable of stopping the motor when the system is not needed; and
 - (ii) have a variable speed fan or the like.
- (b) The requirements of **(a)** do not apply—
 - (i) to a miscellaneous exhaust system in—
 - (A) a *sole-occupancy unit* in a Class 2, 3 or 9c building; or
 - (B) a Class 4 part of a building; or

Deemed-to-Satisfy Provisions

- (ii) where additional exhaust ventilation is needed to balance the *required* outside air for ventilation.

PART J6

ARTIFICIAL LIGHTING AND POWER

Deemed-to-Satisfy Provisions

J6.0 Deemed-to-Satisfy Provisions

- (a) Where a *Deemed-to-Satisfy Solution* is proposed, *Performance Requirements JP1* and *JP3* are satisfied by complying with—
- (i) **J0.1** to **J0.3**; and
 - (ii) **J1.1** to **J1.6**; and
 - (iii) **J2.1** to **J2.5**; and
 - (iv) **J3.1** to **J3.7**; and
 - (v) **J5.1** to **J5.4**; and
 - (vi) **J6.1** to **J6.6**; and
 - (vii) **J7.1** to **J7.4**; and
 - (viii) **J8.1** to **J8.3**.
- (b) Where a *Performance Solution* is proposed, the relevant *Performance Requirements* must be determined in accordance with **A0.7**.

J6.1 Application of Part

J6.2, **J6.3** and **J6.5(a)(ii)** do not apply to a Class 8 *electricity network substation*.

J6.2 Artificial lighting

- (a) In a *sole-occupancy unit* of a Class 2 building or a Class 4 part of a building—
- (i) the *lamp power density* or *illumination power density* of artificial lighting must not exceed the allowance of—
 - (A) 5 W/m² within a *sole-occupancy unit*; and
 - (B) 4 W/m² on a verandah, balcony or the like attached to a *sole-occupancy unit*; and
 - (ii) the *illumination power density* allowance in (i) may be increased by dividing it by the *illumination power density* adjustment factor for a control device in **Table J6.2b** as applicable; and
 - (iii) when designing the *lamp power density* or *illumination power density*, the power of the proposed installation must be used rather than nominal allowances for exposed batten holders or luminaires; and
 - (iv) halogen lamps must be separately switched from fluorescent lamps.
- (b) In a building other than a *sole-occupancy unit* of a Class 2 building or a Class 4 part of a building—
- (i) for artificial lighting, the aggregate design illumination power load must not exceed the sum of the allowances obtained by multiplying the area of each space by the maximum *illumination power density* in **Table J6.2a**; and

Deemed-to-Satisfy Provisions

- (ii) the aggregate design illumination power load in (i) is the sum of the design illumination power loads in each of the spaces served; and
- (iii) in determining the design illumination power load for (ii) the following must be used:
 - (A) Where there are multiple lighting systems serving the same space—
 - (aa) the total illumination power load of all systems; or
 - (bb) for a control system that permits only one system to operate at a time, the design illumination power load is—
 - (AA) based on the highest illumination power load; or
 - (BB) determined by the formula—

$$[H \times T/2 + P \times (100 - T/2)] / 100$$
 Where:
 - H = the highest illumination power load; and
 - T = the time for which the maximum illumination power load will occur, expressed as a percentage; and
 - P = the predominant illumination power load.
 - (B) Where there is adjustable position lighting such as trapeze lighting or track lighting other than trunking systems that accept fluorescent lamps—
 - (aa) the rating of the circuit breaker protecting the track; or
 - (bb) of extra low voltage, 80% of the power rating of the transformer; or
 - (cc) of mains voltage, 100 W per metre of track.
- (c) The requirements of (a) and (b) do not apply to the following:
 - (i) Emergency lighting in accordance with **Part E4**.
 - (ii) Signage and display lighting within cabinets and display cases that are fixed in place.
 - (iii) Lighting for accommodation within the residential part of a *detention centre*.
 - (iv) A heater where the heater also emits light, such as in bathrooms.
 - (v) Lighting of a specialist process nature such as in an operating theatre, fume cupboard or clean workstation.
 - (vi) Lighting of performances such as theatrical or sporting.
 - (vii) Lighting for the permanent display and preservation of works of art or objects in a museum or gallery other than for retail sale, purchase or auction.

Deemed-to-Satisfy Provisions

Table J6.2a MAXIMUM ILLUMINATION POWER DENSITY

Space	Maximum <i>illumination</i> <i>power</i> <i>density</i> (W/m ²)
Auditorium, church and public hall	10
Board room and conference room	10
<i>Carpark</i> - general	6
<i>Carpark</i> - entry zone (first 20 m of travel)	25
Common rooms, spaces and corridors in a Class 2 building	8
Control room, switch room, and the like	9
Corridors	8
Courtroom	12
Dormitory of a Class 3 building used for sleeping only	6
Dormitory of a Class 3 building used for sleeping and study	9
Entry lobby from outside the building	15
Health-care - children's ward	10
Health-care - examination room	10
Health-care - patient ward	7
Health-care - all patient care areas including corridors where cyanosis lamps are used	13
Kitchen and food preparation area	8
Laboratory - artificially lit to an ambient level of 400 lx or more	12
Library - stack and shelving area	12
Library - reading room and general areas	10
Lounge area for communal use in a Class 3 or 9c building	10
Museum and gallery - circulation, cleaning and service lighting	8
Office - artificially lit to an ambient level of 200 lx or more	9
Office - artificially lit to an ambient level of less than 200 lx	7
Plant room	5
Restaurant, café, bar, hotel lounge and a space for the serving and consumption of food or drinks	18
Retail space including a museum and gallery whose purpose is the sale of objects	22
<i>School</i> - general purpose learning areas and tutorial rooms	8
<i>Sole-occupancy unit</i> of a Class 3 building	5

Deemed-to-Satisfy Provisions

Table J6.2a MAXIMUM ILLUMINATION POWER DENSITY— continued

Space	Maximum <i>illumination power density</i> (W/m ²)
<i>Sole-occupancy unit</i> of a Class 9c building	7
Storage with shelving no higher than 75% of the height of the aisle lighting	8
Storage with shelving higher than 75% of the height of the aisle lighting	10
Service area, cleaner's room and the like	5
Toilet, locker room, staff room, rest room and the like	6
Wholesale storage and display area	10
Notes:	
<p>1. In areas not listed above, the maximum <i>illumination power density</i> is—</p> <ul style="list-style-type: none"> (a) for an illuminance of not more than 80 lx, 7.5 W/m²; and (b) for an illuminance of more than 80 lx and not more than 160 lx, 9 W/m²; and (c) for an illuminance of more than 160 lx and not more than 240 lx, 10 W/m²; and (d) for an illuminance of more than 240 lx and not more than 320 lx, 11 W/m²; and (e) for an illuminance of more than 320 lx and not more than 400 lx, 12 W/m²; and (f) for an illuminance of more than 400 lx and not more than 480 lx, 13 W/m²; and (g) for an illuminance of more than 480 lx and not more than 540 lx, 14 W/m²; and (h) for an illuminance of more than 540 lx and not more than 620 lx, 15 W/m². <p>2. For illuminance levels greater than 620 lx, the average <i>light source efficacy</i> must not be less than 80 Lumens/W.</p> <p>3. For enclosed spaces with a Room Aspect Ratio of less than 1.5, the maximum <i>illumination power density</i> may be increased by dividing it by an adjustment factor for room aspect which is:</p> $0.5 + (\text{Room Aspect Ratio}/3)$ <p>The Room Aspect Ratio of the enclosed space is determined by the formula:</p> $A/(H \times C)$ <p>Where:</p> <ul style="list-style-type: none"> A is the area of the enclosed space H is the height of the space measured from the floor to the highest part of the ceiling C is the perimeter of the enclosed space at floor level <p>4. In addition to 3, the maximum <i>illumination power density</i> may be increased by dividing it by the <i>illumination power density</i> adjustment factor in Table J6.2b where applicable and where the control device is not installed to comply with J6.3.</p> <p>5. Circulation spaces are included in the allowances listed in the Table.</p>	

Deemed-to-Satisfy Provisions

Table J6.2b ILLUMINATION POWER DENSITY ADJUSTMENT FACTOR FOR A CONTROL DEVICE

Item	Description	<i>Illumination power density adjustment factor</i>
Lighting timer in accordance with Specification J6	For corridor lighting	0.7
Motion detector in accordance with Specification J6	(a) Where— (i) at least 75% of the area of a space is controlled by one or more motion detectors; or (iii) an area of less than 200 m ² is switched as a block by one or more detectors.	0.9
	(b) Where up to 6 lights are switched as a block by one or more detectors.	0.7
	(c) Where up to 2 lights are switched as a block by one or more detectors.	0.55
Manual dimming system ^{Note 1}	(a) Where at least 75% of the area of a space, in other than a <i>sole-occupancy unit</i> of a Class 2 building or a Class 4 part of a building, is controlled by manually operated dimmers.	0.95
	(b) Where at least 75% of the area of a space, in a <i>sole-occupancy unit</i> of a Class 2 building or a Class 4 part of a building, is controlled by manually operated dimmers.	0.85
Programmable dimming system ^{Note 2}	Where at least 75% of the area of a space is controlled by programmable dimmers.	0.85
Dynamic dimming system ^{Note 3}	Automatic compensation for lumen depreciation.	The design lumen depreciation factor of not less than— (i) for fluorescent lights, 0.9; or (ii) for high pressure discharge lights, 0.8.
Fixed dimming ^{Note 4}	Where at least 75% of the area is controlled by fixed dimmers that reduce the overall lighting level and the power consumption of the lighting.	% of full power to which the dimmer is set divided by 0.95.

Deemed-to-Satisfy Provisions

Table J6.2b ILLUMINATION POWER DENSITY ADJUSTMENT FACTOR FOR A CONTROL DEVICE— continued

Item	Description	<i>Illumination power density adjustment factor</i>
Daylight sensor and dynamic lighting control device in accordance with Specification J6 – dimmed or stepped switching of lights adjacent <i>windows</i>	(a) Lights within the space adjacent to <i>windows</i> other than <i>roof lights</i> for a distance from the <i>window</i> equal to the depth of the floor to window head height.	0.5 <small>Note 5</small>
	(b) Lights within the space adjacent to <i>roof lights</i> .	0.6 <small>Note 5</small>
<p>Notes:</p> <ol style="list-style-type: none"> Manual dimming is where lights are controlled by a knob, slider or other mechanism or where there are pre-selected scenes that are manually selected. Programmed dimming is where pre-selected scenes or levels are automatically selected by the time of day, photoelectric cell or occupancy sensor. Dynamic dimming is where the lighting level is varied automatically by a photoelectric cell to either proportionally compensate for the availability of daylight or the lumen depreciation of the lamps. Fixed dimming is where lights are controlled to a level and that level cannot be adjusted by the user. The <i>illumination power density</i> adjustment factor is only applied to lights controlled by that item. This adjustment factor does not apply to tungsten halogen or other incandescent sources. A maximum of two other <i>illumination power density</i> adjustment factors for a control device can be applied to an area. Where more than one <i>illumination power density</i> adjustment factor (other than for room aspect) apply to an area, they are to be combined using the following formula: $A \times (B + [(1 - B) / 2])$ Where: A is the lowest applicable <i>illumination power density</i> adjustment factor; and B is the second lowest applicable <i>illumination power density</i> adjustment factor. 		

J6.3 Interior artificial lighting and power control

- Artificial lighting of a room or space must be individually operated by a switch or other control device.
- An occupant activated device, such as a room security device, a motion detector in accordance with **Specification J6**, or the like, must be provided in the *sole-occupancy unit* of a Class 3 building, other than where providing accommodation for people with a disability or the aged, to cut power to the artificial lighting, air-conditioner, local exhaust fans and bathroom heater when the *sole-occupancy unit* is unoccupied.
- An artificial lighting switch or other control device in (a) must—

Deemed-to-Satisfy Provisions

- (i) if an artificial lighting switch, be located in a visible position—
 - (A) in the room or space being switched; or
 - (B) in an adjacent room or space from where the lighting being switched is visible; and
- (ii) for other than a single functional space such as an auditorium, theatre, *swimming pool*, sporting stadium or warehouse—
 - (A) not operate lighting for an area of more than 250 m² if in a Class 5 building or a Class 8 laboratory; or
 - (B) not operate lighting for an area of more than—
 - (aa) 250 m² for a space of not more than 2000 m²; or
 - (bb) 1000 m² for a space of more than 2000 m²,
if in a Class 3, 6, 7, 8 (other than a laboratory) or 9 building.
- (d) 95% of the light fittings in a building or *storey* of a building, other than a Class 2 or 3 building or a Class 4 part of a building, of more than 250 m² must be controlled by—
 - (i) a time switch in accordance with **Specification J6**; or
 - (ii) an occupant sensing device such as—
 - (A) a security key card reader that registers a person entering and leaving the building; or
 - (B) a motion detector in accordance with **Specification J6**.
- (e) In a Class 5, 6 or 8 building of more than 250 m², artificial lighting in a natural lighting zone adjacent to *windows* must be separately controlled from artificial lighting not in a natural lighting zone in the same *storey* except where—
 - (i) the room containing the natural lighting zone is less than 20 m²; or
 - (ii) the room's natural lighting zone contains less than 4 luminaires; or
 - (iii) 70% or more of the luminaires in the room are in the natural lighting zone.
- (f) The requirements of **(a)**, **(b)**, **(c)**, **(d)** and **(e)** do not apply to the following:
 - (i) Emergency lighting in accordance with **Part E4**.
 - (ii) Where artificial lighting is needed for 24 hour occupancy such as for a manufacturing process, parts of a hospital, an airport control tower or within a *detention centre*.
- (g) The requirements of **(d)** do not apply to the following:
 - (i) Artificial lighting in a space where the sudden loss of artificial lighting would cause an unsafe situation such as in a *patient care area* in a Class 9a building or in a Class 9c building.
 - (ii) A heater where the heater also emits light, such as in bathrooms.

J6.4 Interior decorative and display lighting

- (a) Interior decorative and display lighting, such as for a foyer mural or art display, must be controlled—

Deemed-to-Satisfy Provisions

- (i) separately from other artificial lighting; and
 - (ii) by a manual switch for each area other than when the operating times of the displays are the same in a number of areas such as in a museum, art gallery or the like, in which case they may be combined; and
 - (iii) by a time switch in accordance with **Specification J6** where the display lighting exceeds 1 kW.
- (b) Window display lighting must be controlled separately from other display lighting.

J6.5 Artificial lighting around the perimeter of a building

- (a) Artificial lighting around the perimeter of a building, must—
- (i) be controlled by—
 - (A) a daylight sensor; or
 - (B) a time switch that is capable of switching on and off electric power to the system at variable pre-programmed times and on variable pre-programmed days; and
 - (ii) when the total perimeter lighting load exceeds 100 W—
 - (A) have an average *light source efficacy* of not less than 60 Lumens/W; or
 - (B) be controlled by a motion detector in accordance with **Specification J6**; and
 - (iii) when used for decorative purposes, such as facade lighting or signage lighting, have a separate time switch in accordance with **Specification J6**.
- (b) The requirements of **(a)(ii)** do not apply to the following:
- (i) Emergency lighting in accordance with **Part E4**.
 - (ii) Lighting around a *detention centre*.

J6.6 Boiling water and chilled water storage units

Power supply to a boiling water or chilled water storage unit must be controlled by a time switch in accordance with **Specification J6**.

PART J7

HEATED WATER SUPPLY AND SWIMMING POOL AND SPA POOL PLANT

Deemed-to-Satisfy Provisions

J7.0 Deemed-to-Satisfy Provisions

- (a) Where a *Deemed-to-Satisfy Solution* is proposed, *Performance Requirements JP1* and *JP3* are satisfied by complying with—
- (i) **J0.1** to **J0.3**; and
 - (ii) **J1.1** to **J1.6**; and
 - (iii) **J2.1** to **J2.5**; and
 - (iv) **J3.1** to **J3.7**; and
 - (v) **J5.1** to **J5.4**; and
 - (vi) **J6.1** to **J6.6**; and
 - (vii) **J7.1** to **J7.4**; and
 - (viii) **J8.1** to **J8.3**.
- (b) Where a *Performance Solution* is proposed, the relevant *Performance Requirements* must be determined in accordance with **A0.7**.

J7.1 * * * * *

This clause has deliberately been left blank.

J7.2 Heated water supply

A heated water supply system for food preparation and sanitary purposes must be designed and installed in accordance with Part B2 of NCC Volume Three — Plumbing Code of Australia.

J7.3 Swimming pool heating and pumping

- (a) Heating for a *swimming pool* must be by—
- (i) a solar heater not boosted by electric resistance heating; or
 - (ii) a heater using reclaimed energy; or
 - (iii) a gas heater; or
 - (iv) a heat pump; or
 - (v) a combination of (i) to (iv).
- (b) Where some or all of the heating *required* by (a) is by a gas heater or a heat pump, the *swimming pool* must have—
- (i) a cover unless located in a *conditioned space*; and
 - (ii) a time switch in accordance with **Specification J6** to control the operation of the heater.

Deemed-to-Satisfy Provisions

- (c) A time switch must be provided in accordance with **Specification J6** to control the operation of a circulation pump for a *swimming pool*.
- (d) For the purpose of **J7.3**, a *swimming pool* does not include a spa pool.

J7.4 Spa pool heating and pumping

- (a) Heating for a spa pool that shares a water recirculation system with a *swimming pool* must be by—
 - (i) a solar heater; or
 - (ii) a heater using reclaimed energy; or
 - (iii) a gas heater; or
 - (iv) a heat pump; or
 - (v) a combination of **(i)** to **(iv)**.
- (b) Where some or all of the heating *required* by **(a)** is by a gas heater or a heat pump, the spa pool must have—
 - (i) a cover; and
 - (ii) a push button and a time switch in accordance with **Specification J6** to control the operation of the heater.
- (c) A time switch must be provided in accordance with **Specification J6** to control the operation of a circulation pump for a spa pool having a capacity of 680 L or more.

PART J8

FACILITIES FOR ENERGY MONITORING

Deemed-to-Satisfy Provisions

J8.0 Deemed-to-Satisfy Provisions

- (a) Where a *Deemed-to-Satisfy Solution* is proposed, *Performance Requirements JP1* and *JP3* are satisfied by complying with—
- (i) **J0.1** to **J0.3**; and
 - (ii) **J1.1** to **J1.6**; and
 - (iii) **J2.1** to **J2.5**; and
 - (iv) **J3.1** to **J3.7**; and
 - (v) **J5.1** to **J5.4**; and
 - (vi) **J6.1** to **J6.6**; and
 - (vii) **J7.1** to **J7.4**; and
 - (viii) **J8.1** to **J8.3**.
- (b) Where a *Performance Solution* is proposed, the relevant *Performance Requirements* must be determined in accordance with **A0.7**.

J8.1 Application of Part

The *Deemed-to-Satisfy Provisions* of this Part do not apply—

- (a) within a *sole-occupancy unit* of a Class 2 building or a Class 4 part of a building; or
- (b) to a Class 8 *electricity network substation*.

J8.2 * * * * *

This clause has deliberately been left blank.

J8.3 Facilities for energy monitoring

- (a) A building or *sole-occupancy unit* with a *floor area* of more than 500 m² must have the facility to record the consumption of gas and electricity.
- (b) A building with a *floor area* of more than 2,500 m² must have the facility to record individually the energy consumption of—
 - (i) *air-conditioning* plant including, where appropriate, heating plant, cooling plant and air handling fans; and
 - (ii) artificial lighting; and
 - (iii) appliance power; and
 - (iv) central hot water supply; and
 - (v) internal transport devices including lifts, escalators and travelators where there is more than one serving the building; and

Deemed-to-Satisfy Provisions

- (vi) other ancillary plant.
- (c) The provisions of (b) do not apply to a Class 2 building with a *floor area* of more than 2,500 m² where the total area of the common areas is less than 500 m².

SPECIFICATION **J1.2** MATERIAL PROPERTIES

Deemed-to-Satisfy Provisions

1. Scope

This Specification lists the thermal properties of some common construction materials.

2. Construction Deemed-to-Satisfy

- (a) **Table 2a** lists the thermal conductivity considered to be achieved by some common construction materials.

Table 2a THERMAL CONDUCTIVITY OF TYPICAL WALL, ROOF/CEILING AND FLOOR MATERIALS

Material description	Material density kg/m ³	Thermal conductivity W/m.K
1. Framing		
(a) Steel	7850	47.5
(b) Timber – kiln dried hardwood (across the grain)	677	0.16
(c) Timber – Radiata pine (across the grain)	506	0.10
2. Roof Cladding		
(a) Aluminium sheeting	2680	210
(b) Concrete or terra cotta tiles	1922	0.81
(c) Steel sheeting	7850	47.5
3. Wall Cladding		
(a) Aluminium sheeting	2680	210
(b) Autoclaved aerated concrete	350	0.10
	900	0.27
(c) Cement render (1 cement : 4 sand)	1570	0.53
(d) Clay bricks		
(i) Clay brick – 2.75 kg	1430	0.55
(ii) Clay brick – 3.25 kg	1690	0.65
(iii) Clay brick – 3.75 kg	1950	0.78
(e) Concrete blocks		
(i) 190 mm dense or 90 mm dense solid	1100/2200	1.1
(ii) 140 mm dense or 190 mm lightweight	1250/910	0.85
(iii) 90 mm dense hollow or 90 mm lightweight solid	1650/1800	0.75

Deemed-to-Satisfy Provisions

Table 2a THERMAL CONDUCTIVITY OF TYPICAL WALL, ROOF/CEILING AND FLOOR MATERIALS— continued

Material description	Material density kg/m ³	Thermal conductivity W/m.K
(iv) 140 mm lightweight	1050	0.67
(v) 90 mm lightweight	1360	0.55
(f) Fibre-cement	1360	0.25
(g) Gypsum plasterboard	880	0.17
(h) Pine weatherboards	506	0.10
(i) Plywood	530	0.14
(j) Solid concrete	2400	1.44
(k) Steel sheeting	7850	47.5
(l) Prestressed hollow core concrete panel	1680	0.80
4. Flooring Materials		
(a) Carpet underlay	-	0.04
(b) Carpet	-	0.05
(c) Prestressed hollow core concrete planks	1680	0.80
(d) Particleboard	640	0.12
(e) Plywood	530	0.14
(f) Timber – kiln dried hardwood (across the grain)	677	0.16
(g) Timber – Radiata pine (across the grain)	506	0.10
(h) Solid concrete	2400	1.44
(i) Vinyl floor tiles	2050	0.79
5. Other Materials		
(a) Clay soil (10% moisture content)	1300	0.6
(b) PMMA (polymethylmethacrylate)	1180	1.00
(c) Polycarbonates	1200	0.2
(d) Sand (6% moisture content)	1800	1.64
(e) Soda lime glass	2500	1.0
Notes:		
1. For materials which incorporate cores or hollows in regular patterns (such as cored brickwork, hollow blockwork and cored floor or wall panels), the tabulated material densities and thermal conductivities are based on the gross density (mass divided by external dimensions).		
2. The <i>R-Value</i> of a material is determined by dividing the thickness of the material in metres by the thermal conductivity in W/m.K.		

(b) **Table 2b** lists the *R-Values* considered to be achieved by air films and airspaces.

Deemed-to-Satisfy Provisions

Table 2b TYPICAL R-VALUES FOR AIRSPACES AND AIR FILMS

Position of airspace	Direction of heat flow	<i>R-Value</i>
1. Airspaces non-reflective unventilated		
In a roof with a pitch of not more than 5°	Up	0.15
	Down	0.22
In a roof with a ceiling that is parallel with a roof with a pitch more than 5° and not more than 15°	Up	0.15
	Down	0.21
In a roof with a ceiling that is parallel with a roof with a pitch more than 22° and not more than 45°	Up	0.15
	Down	0.18
In any roof space with a horizontal ceiling, with a pitch more than 5°	Up	0.18
	Down	0.28
In a wall	Horizontal	0.17
2. Airspaces non-reflective ventilated		
In any roof with a pitch not more than 5° and 100 mm deep airspace	Up	Nil
	Down	0.19
In any roof space with a horizontal ceiling, with a pitch more than 5°	Up	Nil
	Down	0.46
In a wall	Horizontal	0.14
3. Air films – Still air		
On a surface with a pitch of not more than 5°	Up	0.11
	Down	0.16
On a surface with a pitch of more than 5° and not more than 30°	Up	0.11
	Down	0.15
On a surface with a pitch of more than 30° and not more than 45°	Up	0.11
	Down	0.13
On a wall	Horizontal	0.12
4. Air films – Moving air		
Not more than 3 m/s wind	Any direction	0.04
More than 3 m/s wind speed and not more than 7 m/s wind speed	Any direction	0.03
Note: <i>R-Values</i> are for a temperature of 10°C and temperature difference of 15K.		

- (c) The thermal properties considered to be achieved by reflective surfaces are—
- (i) within a wall—
 - (A) with an inner reflective surface of 0.05 emittance and a 20 mm airspace to the wall lining, an added *R-Value* of 0.48; and

Deemed-to-Satisfy Provisions

- (B) with an inner reflective surface of 0.05 emittance and a 70 mm airspace to the wall lining, an added *R-Value* of 0.43; and
 - (C) with an inner reflective surface of 0.05 emittance and a 70 mm airspace to the wall lining and an outer anti-glare reflective surface of 0.20 emittance and a 25 mm airspace to the wall cladding, an added *R-Value* of 0.95; and
 - (D) with an outer anti-glare reflective surface of 0.20 emittance and a 35 mm airspace to the wall cladding, an added *R-Value* of 0.50; and
- (ii) within a roof where the *reflective insulation* is laid directly under the roof, those in **Table 2c**.

Table 2c TYPICAL THERMAL PROPERTIES FOR REFLECTIVE SURFACES WITH AIRSPACES IN ROOFS

Emittance of added <i>reflective insulation</i>	Direction of heat flow	<i>R-Value</i> added by a reflective surface					
		Pitched roof (>10°) with horizontal ceiling		Flat, skillion or pitched roof (≤10°) with horizontal ceiling	Pitched roof with cathedral ceiling		
		Ventilated roof space	Non-ventilated roof space		15° to not more than 25° pitch	more than 25° to not more than 35° pitch	more than 35° to 45° pitch
0.2 outer 0.05 inner	Downwards	1.21	1.12	1.28	0.96	0.86	0.66
0.2 outer 0.05 inner	Upwards	0.59	0.75	0.68	0.72	0.74	0.77
0.9 outer 0.05 inner	Downwards	1.01	0.92	1.06	0.74	0.64	0.44
0.9 outer 0.05 inner	Upward	0.40	0.55	0.49	0.51	0.52	0.53

- (d) A ventilated roof space is a roof space with—
- (i) gable vents, ridge vents, eave vents, roof vents or the like that—
 - (A) are evenly distributed to allow an unobstructed flow of air; and
 - (B) are located to ensure, where practicable, there are no dead airspaces; and
 - (C) have an aggregate fixed open area of not less than 1.0% of the ceiling area; or
 - (ii) not less than 2 wind-driven roof ventilators having an aggregate opening area of not less than 0.14 m² in conjunction with gable vents, ridge vents, eave vents, roof vents or the like having an aggregate fixed open area of not less than 0.2% of the ceiling area; or
 - (iii) a tiled roof without *sarking-type material* at roof level.

SPECIFICATION **J1.3** ROOF AND CEILING CONSTRUCTION

Deemed-to-Satisfy Provisions

1. Scope

This Specification describes the thermal performance of some common forms of roof and ceiling construction.

2. Construction Deemed-to-Satisfy

Figure 2 details the *R-Values* considered to be achieved by some common forms of roof and ceiling construction.

Figure 2 TYPICAL R-VALUES FOR ROOF AND CEILING CONSTRUCTION

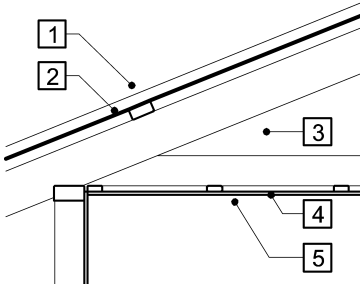
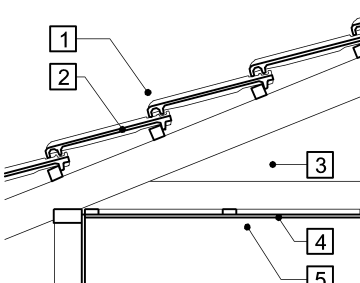
Roof construction description	Item	Item description	<i>R-Value</i> Unventilated		<i>R-Value</i> Ventilated	
			Up	Down	Up	Down
(a) Roof 15° to 45° pitch – Horizontal ceiling – Metal cladding 	1.	Outdoor air film (7 m/s)	0.04	0.04	0.04	0.04
	2.	Metal cladding	0.00	0.00	0.00	0.00
	3.	Roof airspace (non-reflective)	0.18	0.28	0.00	0.46
	4.	Plasterboard, gypsum (10 mm, 880 kg/m ³)	0.06	0.06	0.06	0.06
	5.	Indoor air film (still air)	0.11	0.16	0.11	0.16
	<i>Total R-Value</i>			0.39	0.54	0.21
(b) Roof 15° to 45° pitch – Horizontal ceiling – Clay tiles 19 mm 	1.	Outdoor air film (7 m/s)	0.04	0.04	0.04	0.04
	2.	Roof tile, clay or concrete (1922 kg/m ³)	0.02	0.02	0.02	0.02
	3.	Roof airspace (non-reflective)	0.18	0.28	0.00	0.46
	4.	Plasterboard, gypsum (10 mm, 880 kg/m ³)	0.06	0.06	0.06	0.06
	5.	Indoor air film (still air)	0.11	0.16	0.11	0.16
	<i>Total R-Value</i>			0.41	0.56	0.23

Deemed-to-Satisfy Provisions

Figure 2 TYPICAL R-VALUES FOR ROOF AND CEILING CONSTRUCTION

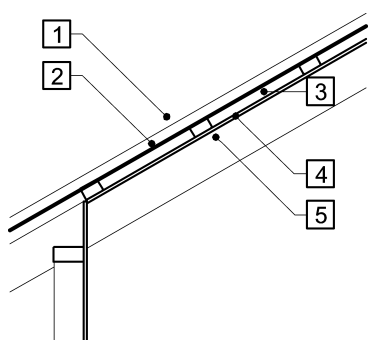
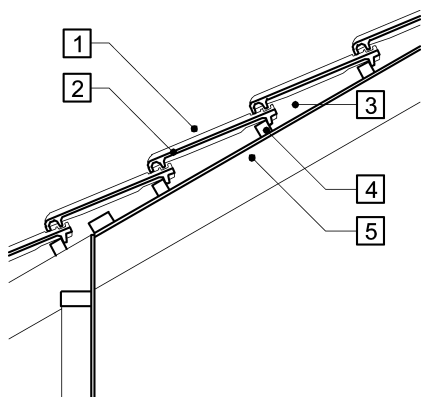
Roof construction description	Item	Item description	<i>R-Value</i> Unventilated	
			Up	Down
(c) Cathedral ceiling 15° to 45° pitch – 10 mm plaster on top of rafters – Metal external cladding 	1.	Outdoor air film (7 m/s)	0.04	0.04
	2.	Metal cladding	0.00	0.00
	3.	Roof airspace (30 mm to 100 mm, non-reflective)	0.15	0.18
	4.	Plasterboard, gypsum (10 mm, 880 kg/m ³)	0.06	0.06
	5.	Indoor air film (still air)	0.11	0.14
	<i>Total R-Value</i>			0.36
(d) Cathedral ceiling 15° to 45° pitch – 10 mm plaster on top of rafters – Tiles external cladding 	1.	Outdoor air film (7 m/s)	0.04	0.04
	2.	Roof tile, clay or concrete (1922 kg/m ³)	0.02	0.02
	3.	Roof airspace (30 mm to 100 mm, non-reflective)	0.15	0.18
	4.	Plasterboard, gypsum (10 mm, 880 kg/m ³)	0.06	0.06
	5.	Indoor air film (still air)	0.11	0.14
	<i>Total R-Value</i>			0.38

Deemed-to-Satisfy Provisions

Figure 2 TYPICAL R-VALUES FOR ROOF AND CEILING CONSTRUCTION— continued

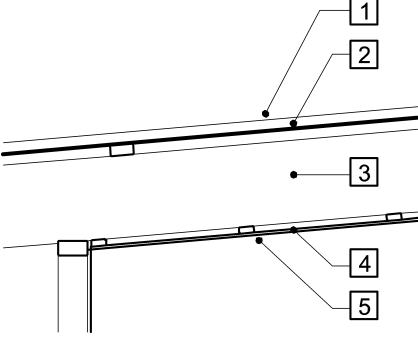
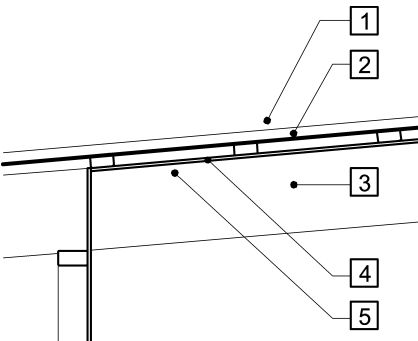
Roof construction description	Item	Item description	<i>R-Value Unventilated</i>	
			Up	Down
(e) Skillion roof less than 5° pitch – 10 mm plaster below rafters – Metal external cladding 	1.	Outdoor air film (7 m/s)	0.04	0.04
	2.	Metal cladding	0.00	0.00
	3.	Roof airspace (100 mm to 300 mm, non-reflective)	0.15	0.22
	4.	Plasterboard, gypsum (10 mm, 880 kg/m ³)	0.06	0.06
	5.	Indoor air film (still air)	0.11	0.16
	<i>Total R-Value</i>			0.36
(f) Skillion roof 5° to 15° pitch – 10 mm plaster on top of rafters – Metal external cladding 	1.	Outdoor air film (7 m/s)	0.04	0.04
	2.	Metal cladding	0.00	0.00
	3.	Roof airspace (30 mm to 100 mm non-reflective)	0.15	0.21
	4.	Plasterboard, gypsum (10 mm, 880 kg/m ³)	0.06	0.06
	5.	Indoor air film (still air)	0.11	0.16
	<i>Total R-Value</i>			0.36

Deemed-to-Satisfy Provisions

Figure 2 TYPICAL R-VALUES FOR ROOF AND CEILING CONSTRUCTION— continued

Roof construction description	Item	Item description	R-Value Unventilated	
			Up	Down
(g) 100 mm solid concrete roof to 5° – 10 mm plaster, suspended ceiling – Applied external waterproof membrane 	1.	Outdoor air film (7 m/s)	0.04	0.04
	2.	Waterproof membrane, rubber synthetic (4 mm, 961 kg/m ³)	0.03	0.03
	3.	Solid concrete, (100 mm, 2400 kg/m ³)	0.07	0.07
	4.	Ceiling airspace (100 mm to 300 mm, non-reflective)	0.15	0.22
	5.	Plasterboard, gypsum (10 mm, 880 kg/m ³)	0.06	0.06
	6.	Indoor air film (still air)	0.11	0.16
	<i>Total R-Value</i>			0.46

Notes:

1. The *R-Value* of an item, other than an airspace, air film or air cavity, may be increased in proportion to the increased thickness of the item.
2. The *Total R-Value* of a form of construction may be increased by the amount that the *R-Value* of an individual item is increased.
3. Where an airspace is filled, the *R-Value* listed for the airspace must be deducted from the *Total R-Value* of the roof construction.
4. For information on a roof space that is considered to be ventilated, see **Specification J1.2, Clause 2(d)**.

SPECIFICATION J1.5 WALL CONSTRUCTION

Deemed-to-Satisfy Provisions

1. Scope

This Specification describes the thermal performance of some common forms of external wall construction.

2. Construction Deemed-to-Satisfy

Figure 2 details the *R-Values* considered to be achieved by some common forms of wall construction.

Figure 2 TYPICAL R-VALUES FOR WALL CONSTRUCTION

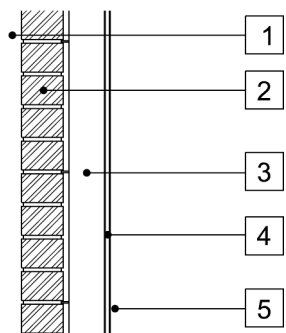
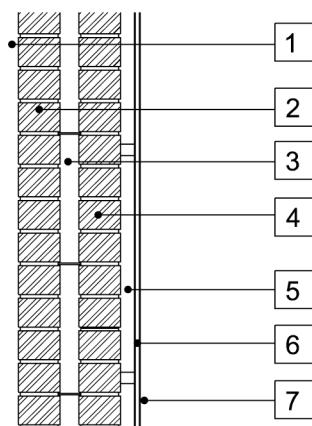
External wall construction description	Item	Item description	<i>R-Value</i>
(a) Masonry veneer – 25 mm to 50 mm cavity, 10 mm internal plaster on 90 mm stud frame 	1.	Outdoor air film (7 m/s)	0.04
	2.	Masonry (See Notes 3 and 4)	0.09
	3.	Cavity and airspace (115 to 140 mm, made up of 90 mm stud + 25 mm to 50 mm airspace non-reflective and unventilated)	0.17
	4.	Plasterboard, gypsum (10 mm, 880 kg/m ³)	0.06
	5.	Indoor air film (still air)	0.12
	<i>Total R-Value</i>		
(b) Cavity masonry – 20 mm to 50 mm cavity, 10 mm internal plaster on battens or furring channels 	1.	Outdoor air film (7 m/s)	0.04
	2.	Masonry (See Notes 3 and 4)	0.09
	3.	Masonry cavity (20 mm to 50 mm, non-reflective and unventilated)	0.17
	4.	Masonry (See Note 4)	0.09
	5.	Airspace (20 mm to 35 mm, non-reflective and unventilated)	0.17
	6.	Plasterboard, gypsum (10 mm, 880 kg/m ³)	0.06
	7.	Indoor air film (still air)	0.12
<i>Total R-Value</i>			0.74

Deemed-to-Satisfy Provisions

Figure 2 TYPICAL R-VALUES FOR WALL CONSTRUCTION— continued

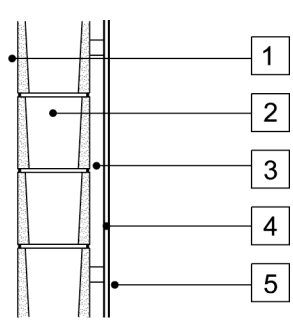
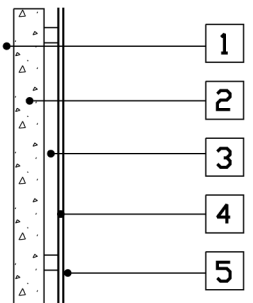
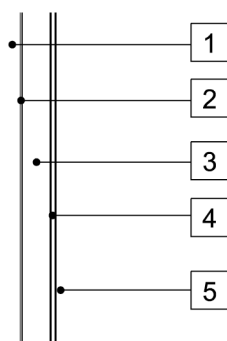
External wall construction description	Item	Item description	R-Value
<p>(c) Dense weight hollow concrete block with internal plaster on battens or furring channels</p> 	1.	Outdoor air film (7 m/s)	0.04
	2.	Dense weight hollow concrete block (See Notes 3 and 4)	0.15
	3.	Airspace (20 mm to 40 mm non-reflective and unventilated)	0.17
	4.	Plasterboard, gypsum (10 mm, 880 kg/m ³)	0.06
	5.	Indoor air film (still air)	0.12
	<i>Total R-Value</i>		0.54
<p>(d) 125 mm solid reinforced concrete (dense weight) – 10 mm internal plaster on battens or furring channels</p> 	1.	Outdoor air film (7 m/s)	0.04
	2.	125 mm minimum solid reinforced concrete (See Note 3)	0.09
	3.	Airspace (20 mm to 40 mm non-reflective and unventilated)	0.17
	4.	Plasterboard, gypsum (10 mm, 880 kg/m ³)	0.06
	5.	Indoor air film (still air)	0.12
	<i>Total R-Value</i>		0.48
<p>(e) Timber wall – external 6 mm cement sheet cladding, 90 mm stud frame, 10 mm plaster</p> 	1.	Outdoor air film (7 m/s)	0.04
	2.	Fibre-cement (6 mm, 1360 kg/m ³)	0.03
	3.	Airspace (90 mm nonreflective and unventilated)	0.17
	4.	Plasterboard, gypsum (10 mm, 880 kg/m ³)	0.06
	5.	Indoor air film (still air)	0.12
	<i>Total R-Value</i>		0.42

Deemed-to-Satisfy Provisions

Figure 2 TYPICAL R-VALUES FOR WALL CONSTRUCTION— continued

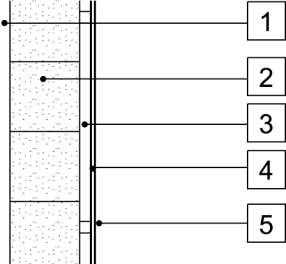
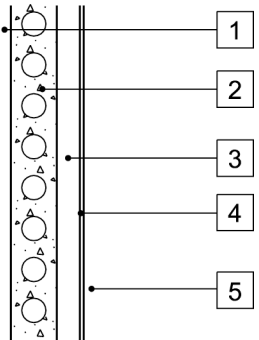
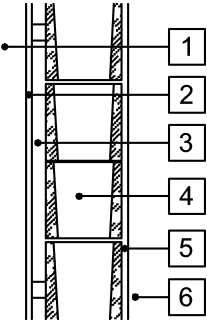
External wall construction description	Item	Item description	R-Value
(f) 200 mm autoclaved aerated concrete block – 10 mm internal plaster on battens or furring channels 	1.	Outdoor air film (7 m/s)	0.04
	2.	Autoclaved aerated concrete block (200 mm, 350 kg/m ³)	2.00
	3.	Airspace (20 mm to 40 mm non-reflective and unventilated)	0.17
	4.	Plasterboard, gypsum (10 mm, 880 kg/m ³)	0.06
	5.	Indoor air film (still air)	0.12
	<i>Total R-Value</i>		
(g) 150 mm hollow-core concrete panels – 10 mm internal plaster on battens or furring channels 	1.	Outdoor air film (7 m/s)	0.04
	2.	Prestressed hollow-core concrete panels (150 mm, 1,680 kg/m ³ , 30% cores)	0.14
	3.	Airspace (20 mm to 40 mm non-reflective and unventilated)	0.17
	4.	Plasterboard, gypsum (10 mm, 880 kg/m ³)	0.06
	5.	Indoor air film (still air)	0.12
	<i>Total R-Value</i>		
(h) Dense weight hollow concrete block with external 6 mm cement sheet cladding on battens or furring channels 	1.	Outdoor air film (7 m/s)	0.04
	2.	Fibre-cement (6 mm, 1360 kg/m ³)	0.03
	3.	Airspace (20 mm to 40 mm non-reflective and unventilated)	0.17
	4.	Dense weight hollow concrete block (See Note 4)	0.15
	5.	10 mm render	0.02
	6.	Indoor air film (still air)	0.12
	<i>Total R-Value</i>		

Deemed-to-Satisfy Provisions

Figure 2 TYPICAL R-VALUES FOR WALL CONSTRUCTION— continued

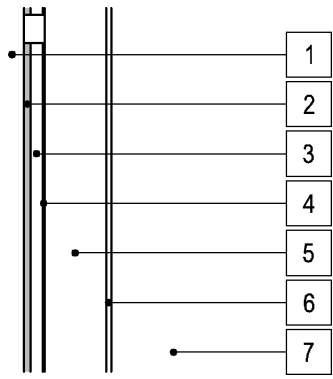
External wall construction description	Item	Item description	<i>R-Value</i>
(i) Glazed construction within a metal frame – 10 mm internal plaster on battens or furring channels 	1.	Outdoor air film (7 m/s)	0.04
	2.	Clear or opaque glass (10 mm, 2500 kg/m ³)	0.01
	3.	Airspace (20 mm to 40 mm non-reflective and unventilated)	0.17
	4.	Steel sheet (1 mm to 3 mm, 7850 kg/m ³)	0.00
	5.	Airspace (2 mm to 100 mm non-reflective and unventilated)	0.17
	6.	Plasterboard, gypsum (10 mm, 880 kg/m ³)	0.06
	7.	Indoor air film (still air)	0.12
			<i>Total R-Value</i>

Deemed-to-Satisfy Provisions

Figure 2 TYPICAL R-VALUES FOR WALL CONSTRUCTION— continued

External wall construction description	Item	Item description	R-Value
Notes:			
1. The <i>R-Value</i> of an item, other than an airspace, air film or air cavity, may be increased in proportion to the increased thickness of the item.			
2. The <i>Total R-Value</i> of a form of construction may be increased by the amount that an individual item is increased.			
3. The addition of 10 mm of render to a concrete or masonry wall will increase the <i>Total R-Value</i> by 0.02.			
4. (a) The typical <i>R-Value</i> in Figure 2(a) and (b) is for 90 mm dense weight concrete block.			
(b) The typical <i>R-Value</i> in Figure 2(c) and (h) is for 140 mm dense weight hollow concrete block.			
(c) The typical <i>R-Value</i> in Figure 2(d) is for 125 mm solid reinforced concrete (2400 kg/m ³).			
(d) Other typical <i>R-Values</i> for masonry and concrete are as follows and may be substituted for those above:			
90 mm clay brick:			
		(density 1430 kg/m ³)	0.16
		(density 1690 kg/m ³)	0.14
		(density 1950 kg/m ³)	0.12
110 mm clay brick:			
		(density 1430 kg/m ³ , 2.75 kg/brick)	0.20
		(density 1690 kg/m ³ , 3.25 kg/brick)	0.17
		(density 1950 kg/m ³ , 3.75 kg/brick)	0.14
Dense weight hollow concrete block:			
		110 mm	0.12
		190 mm	0.20
5. The <i>Total R-Values</i> in this Figure are for <i>external walls</i> . The <i>Total R-Value</i> for an internal wall of the same construction would be 0.08 greater because the <i>R-Value</i> for an outdoor air film would be replaced by that of an indoor air film.			
6. Where a cavity or airspace is filled, the <i>R-Value</i> listed for the cavity must be deducted from the <i>Total R-Value</i> of the wall.			

SPECIFICATION J1.6 FLOOR CONSTRUCTION

Deemed-to-Satisfy Provisions

1. Scope

This Specification describes the thermal performance of some common forms of floor construction.

2. Construction Deemed-to-Satisfy

Figure 2 details the *R-Values* considered to be achieved by some common forms of floor construction.

Figure 2 TYPICAL R-VALUES FOR FLOOR CONSTRUCTION

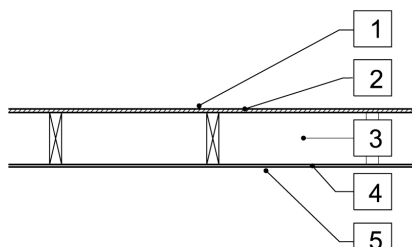
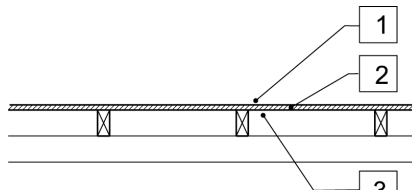
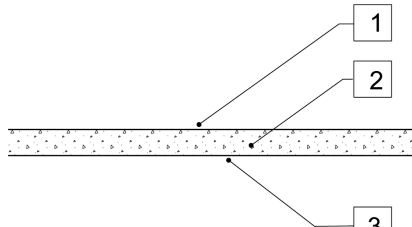
Floor construction description	Item	Item description	<i>R-Value</i>	
			Up	Down
(a) Timber internal floor, 10 mm internal plaster 	1.	Indoor air film (still air)	0.11	0.16
	2.	Particleboard flooring (19 mm, 640 kg/m ³)	0.15	0.15
	3.	Floor airspace, 100 mm to 300 mm (non reflective)	0.15	0.22
	4.	Plasterboard, gypsum (10 mm, 880 kg/m ³)	0.06	0.06
	5.	Indoor air film (still air)	0.11	0.16
	<i>Total R-Value</i>			0.58
(b) Timber, suspended ground floor, open subfloor 	1.	Indoor air film (still air)	0.11	0.16
	2.	Particleboard flooring (19 mm, 640 kg/m ³)	0.15	0.15
	3.	Outdoor air film (7 m/s)	0.04	0.04
	<i>Total R-Value</i>			0.30
(c) Solid concrete suspended slab 	1.	Indoor air film (still air)	0.11	0.16
	2.	Solid concrete (150 mm, 2400 kg/m ³)	0.10	0.10
	3.	Outdoor air film (7 m/s)	0.04	0.04
	<i>Total R-Value</i>			0.25

Deemed-to-Satisfy Provisions

Figure 2 TYPICAL R-VALUES FOR FLOOR CONSTRUCTION— continued

Floor construction description	Item	Item description	R-Value	
			Up	Down
(d) 150 mm hollow-core concrete planks 	1.	Indoor air film (still air)	0.11	0.16
	2.	Concrete topping (60 mm, 2,400 kg/m ³)	0.04	0.04
	3.	Hollow-core concrete planks (150 mm, 1,680 kg/m ³ , 30% cores)	0.14	0.14
	4.	Outdoor air film (7 m/s)	0.04	0.04
	<i>Total R-Value</i>		0.33	0.38
(e) 100 mm solid concrete slab-on-ground 	1.	Indoor air film (still air)	0.11	0.16
	2.	Solid concrete (100 mm, 2400 kg/m ³)	0.07	0.07
	3.	Ground thermal resistance	-	-
	<i>Total R-Value</i>		0.18	0.23
(f) 150 mm solid concrete slab-on-ground 	1.	Indoor air film (still air)	0.11	0.16
	2.	Solid concrete (150 mm, 2400 kg/m ³)	0.10	0.10
	3.	Ground thermal resistance	-	-
	<i>Total R-Value</i>		0.21	0.26

Notes:

1. The *R-Value* of an item, other than an airspace, air film or air cavity, may be increased in proportion to the increased thickness of the item.
2. The *Total R-Value* of a form of construction may be increased by the amount that an individual item is increased.
3. For floor types (c) and (d) that are located over an internal space, the *Total R-Value* can be calculated by replacing the value for outdoor air film (R0.04) on the underside of the floor with the value for indoor air film (R0.11 for heat flow up or R0.16 for heat flow down).
4. For floor types (b), (c) and (d) located over ground with an enclosed perimeter, the *Total R-Value* can be calculated by replacing the value for outdoor air film (R0.04) on the underside of the floor with the value for indoor air film plus ground thermal resistance (i.e. R0.11+R0.56=R0.67 for heat flow up, or R0.16+R0.58=R0.74 for heat flow down).
5. Where reflective building membrane is attached beneath the floor with a 100 mm reflective airspace, add R0.38 for heat flow up and R1.14 for heat flow down.
6. Where ground floor construction with an enclosed perimeter makes the airspace adjacent to the ground reflective, the face down subfloor air films will be R0.23 instead of R0.11 for heat flow up, and R0.80 instead of R0.16 for heat flow down.
7. The addition of 10 mm of render to the ceiling of a suspended internal concrete floor will increase the *Total R-Value* by 0.02.
8. Solid concrete slab includes concrete beam and infill floors and concrete precast permanent formwork panels. For the purposes of calculating the *Total R-Value* of a floor, the *R-Value* attributable to an in-slab or in-screed heating or cooling system is ignored.

Deemed-to-Satisfy Provisions

Figure 2 TYPICAL R-VALUES FOR FLOOR CONSTRUCTION— continued

Floor construction description	Item	Item description	R-Value	
			Up	Down
9. Where an airspace is filled, the <i>R-Value</i> listed for the airspace must be deducted from the <i>Total R-Value</i> of the floor construction.				

SPECIFICATION J5.2a FANS

Deemed-to-Satisfy Provisions

1. Scope

This Specification contains the requirements for fans used as part of an *air-conditioning* system or a mechanical ventilation system.

2. Application

- (a) This Specification does not apply to—
- (i) fans in unducted *air-conditioning* systems with a supply air capacity of less than 1000 L/s; or
 - (ii) the power for a fan in an energy reclaiming system that preconditions outside air; or
 - (iii) the power for process related components.
- (b) Compliance with this Specification must not adversely affect—
- (i) smoke hazard management measures *required* by **Part E2**; and
 - (ii) ventilation *required* by **Part E3** and **Part F4**.

3. Air-conditioning system fans

- (a) An *air-conditioning* system must be designed so that the *fan motor power* of—
- (i) the supply and return air fans as a combined total is in accordance with **Table 3a**; and
 - (ii) the fan in a cooling tower, closed circuit cooler or an evaporative condenser is in accordance with **Table 3b**; and
 - (iii) the fan in an air-cooled condenser does not use more than 42 W of *fan motor power* for each kW of heat rejected from the refrigerant, when determined in accordance with AHRI 460.
- (b) The requirements of (a)(iii) do not apply to the fan of an air-cooled condenser that is part of—
- (i) a refrigerant chiller in an *air-conditioning* system that complies with the energy efficiency ratios in **Specification J5.2e**; or
 - (ii) packaged *air-conditioning* equipment that complies with the energy efficiency ratios in **Specification J5.2e**.

Deemed-to-Satisfy Provisions

Table 3a MAXIMUM FAN MOTOR POWER – SUPPLY AND RETURN AIR FANS

<i>Air-conditioning</i> sensible heat load (W/m ² of the <i>floor area</i> of the <i>conditioned space</i>)	Maximum <i>fan motor power</i> (W/m ² of the <i>floor area</i> of the <i>conditioned space</i>)	
	For an <i>air-conditioning</i> system serving not more than 500 m ²	For an <i>air-conditioning</i> system serving more than 500 m ²
Up to 100	5.3	8.3
101 to 150	9.5	13.5
151 to 200	13.7	18.3
201 to 300	22.2	28.0
301 to 400	30.7	37.0
More than 400	See Note	

Note: Where the *air-conditioning* sensible heat load is more than 400 W/m², the maximum *fan motor power* must be determined—

- (a) in a building of not more than 500 m² *floor area*, using 0.09 W of *fan motor power* for each Watt of *air-conditioning* sensible heat load; and
- (b) in a building of more than 500 m² *floor area*, using 0.12 W of *fan motor power* for each Watt of *air-conditioning* sensible heat load.

Table 3b MAXIMUM FAN MOTOR POWER – COOLING TOWER, CLOSED CIRCUIT COOLER AND EVAPORATIVE CONDENSERS

Type of fan	Maximum <i>fan motor power</i> per L/s of cooling fluid circulated		Maximum <i>fan motor power</i> per kW of heat rejected
	Cooling tower	Closed circuit cooler	Evaporative condenser
Propeller or axial	310 W	500 W	18 W
Centrifugal	590 W	670 W	22 W

Note: The cooling fluid circulated may be refrigerant, chilled water, brines or glycol mixtures.

4. Mechanical ventilation system fans

- (a) When the air flow rate of a mechanical ventilation system is more than 1000 L/s, the system must—
 - (i) have a *fan motor power* to air flow rate ratio in accordance with—
 - (A) for general mechanical ventilation systems, **Table 4a**; or
 - (B) for *carpark* mechanical ventilation systems, **Table 4b**; and
 - (ii) for *carpark* exhaust, when serving a *carpark* with more than 40 vehicle spaces, have an atmospheric contaminant monitoring system in accordance with AS 1668.2.
- (b) The requirements of (a) do not apply to—

Deemed-to-Satisfy Provisions

- (i) a mechanical ventilation system that is part of an *air-conditioning* system; or
- (ii) the power for a miscellaneous exhaust system complying with **J5.4**; or
- (iii) a *sole-occupancy unit* in a Class 2 building or a Class 4 part of a building.

Table 4a MAXIMUM FAN MOTOR POWER TO AIR FLOW RATE RATIO – GENERAL MECHANICAL VENTILATION SYSTEMS

Filtration	Maximum <i>fan motor power</i> to air flow rate ratio (W/(L/s))
With filters	0.98
Without filters	0.65

Table 4b MAXIMUM FAN MOTOR POWER TO AIR FLOW RATE RATIO – CARPARK MECHANICAL VENTILATION SYSTEMS

Filtration	Maximum <i>fan motor power</i> to air flow rate ratio (W/(L/s))		
	Air flow rate (L/s)		
	1,000 to less than 5,000	5,000 to 50,000	More than 50,000
With filters	0.78	1.12	1.81
Without filters	0.52	0.74	1.2

SPECIFICATION **J5.2b** DUCTWORK INSULATION AND SEALING

Deemed-to-Satisfy Provisions

1. Scope

- (a) This Specification contains the requirements for the sealing and insulating of supply and return ductwork and fittings used in an *air-conditioning* system.
- (b) For the purposes of this Specification, fittings—
 - (i) include passive components of a ductwork system; and
 - (ii) exclude active components such as air-handling unit components.

2. Sealing of ductwork

- (a) Ductwork in an *air-conditioning* system must be sealed against air loss in accordance with the duct sealing requirements of AS 4254 Parts 1 and 2 for the static pressure in the system.
- (b) The requirements of (a) do not—
 - (i) apply to ductwork located within the only or last room served by the system; and
 - (ii) include the air leakage testing requirements of clause 2.2.4 of AS 4254.2.

3. Insulation of ductwork and fittings

- (a) Ductwork and fittings in an *air-conditioning* system must be provided with insulation—
 - (i) complying with AS/NZS 4859.1; and
 - (ii) having a material *R-Value* not less than—
 - (A) that specified in **Table 3**; or
 - (B) 1.0, for flexible ductwork with a length to an outlet or from an inlet of not more than 3 m.
- (b) Insulation must—
 - (i) be protected against the effects of weather and sunlight; and
 - (ii) be installed so that it—
 - (A) abuts adjoining insulation to form a continuous barrier; and
 - (B) maintains its position and thickness, other than at flanges and supports; and
 - (iii) when conveying cooled air—
 - (A) be protected by a vapour barrier on the outside of the insulation; and
 - (B) where the vapour barrier is a membrane, be installed so that adjoining sheets of the membrane—
 - (aa) overlap by 50 mm; and
 - (bb) are bonded or taped together.

Deemed-to-Satisfy Provisions

- (c) The requirements of (a) do not apply to—
- (i) ductwork and fittings located within the only or last room served by the system; or
 - (ii) fittings that form part of the interface with the *conditioned space*; or
 - (iii) return air ductwork in, or passing through, a *conditioned space*; or
 - (iv) ductwork for outside air and exhaust air associated with an *air-conditioning* system; or
 - (v) the floor of an in-situ air-handling unit; or
 - (vi) packaged *air-conditioning* equipment complying with MEPS; or
 - (vii) flexible fan connections.

Table 3 DUCTWORK AND FITTINGS - MINIMUM MATERIAL R-VALUE

Location of ductwork and fittings	<i>Climate zone</i>	
	1, 2, 3, 4, 5, 6 and 7	8
Within a <i>conditioned space</i>	1.2	1.6
Where exposed to direct sunlight	3.0	3.4
All other locations	2.0	2.4

SPECIFICATION **J5.2c** PIPING, VESSEL, HEAT EXCHANGER AND TANK INSULATION

Deemed-to-Satisfy Provisions

1. Scope

- (a) This Specification contains the requirements for the insulating of *piping*, vessels, heat exchangers and tanks containing heating fluids or cooling fluids used in an *air-conditioning* system.
- (b) For the purposes of this Specification—
 - (i) heating fluids include heated water, steam and condensate; and
 - (ii) cooling fluids include refrigerant, chilled water, brines and glycol mixtures, but do not include condenser cooling water.

2. Insulation

- (a) *Piping*, vessels, heat exchangers and tanks must be provided with insulation—
 - (i) complying with AS/NZS 4859.1; and
 - (ii) for heated or chilled water *piping*, having a material *R-Value* not less than that specified in **Table 2a**; and
 - (iii) for refrigerant, steam or condensate *piping*, having a material *R-Value* not less than that specified in **Table 2b**; and
 - (iv) for vessels, heat exchangers or tanks, having a material *R-Value* not less than that specified in **Table 2c**.
- (b) Insulation must—
 - (i) be protected against the effects of weather and sunlight; and
 - (ii) be able to withstand the temperatures within the *piping*, vessel, heat exchanger or tank.
- (c) Insulation provided to *piping*, vessels, heat exchangers or tanks containing cooling fluid must be protected by a vapour barrier on the outside of the insulation.
- (d) The requirements of (a) and (b) do not apply to *piping*—
 - (i) located within the only or last room served by the system; or
 - (ii) encased within a concrete slab or panel which is part of a heating or cooling system; or
 - (iii) supplied as an integral part of a piece of plant; or
 - (iv) inside an air-handling unit, fan-coil unit or the like.

Table 2a WATER PIPING - MINIMUM MATERIAL R-VALUE

Type of water <i>piping</i>	Minimum material <i>R-Value</i>
Heated water <i>piping</i> of all diameters	1.5

Deemed-to-Satisfy Provisions

Table 2a WATER PIPING - MINIMUM MATERIAL R-VALUE— continued

Type of water <i>pipng</i>	Minimum material <i>R-Value</i>
Chilled water <i>pipng</i> with nominal diameters not more than 40 mm	1.0
Chilled water <i>pipng</i> with nominal diameters more than 40 mm but not more than 80 mm	1.5
Chilled water <i>pipng</i> with nominal diameters more than 80 mm	2.0
Notes:	
<ol style="list-style-type: none"> 1. <i>Pipng required</i> to be insulated includes all supply and return <i>pipng</i>, chilled water supply <i>pipng</i> within 500 mm of the connection to the <i>air-conditioning</i> system and pressure relief <i>pipng</i> within 500 mm of the connection to the <i>air-conditioning</i> system. 2. The <i>required</i> minimum material <i>R-Value</i> may be halved— <ol style="list-style-type: none"> (a) for <i>pipng</i> with nominal diameters not more than 40 mm, for the last 750 mm adjoining items of plant; and (b) for <i>pipng</i> penetrating a structural member; and (c) for supply and return chilled water <i>pipng</i> located internally, if the chilled water supply temperature is more than 14°C. 	

Table 2b REFRIGERANT, STEAM AND CONDENSATE PIPING— MINIMUM MATERIAL R-VALUE

Temperature range	Nominal pipe size				
	15 mm to 40 mm	41 mm to 80 mm	81 mm to 125 mm	126 mm to 150 mm	151 mm to 200 mm
Refrigerant not more than 2°C	1.3	1.7	2.0	2.0	2.7
Refrigerant more than 2°C but not more than 20°C	1.0	1.5	2.0	2.0	2.0
Steam and condensate not more than 120°C	1.0	1.0	1.3	1.3	1.3
Steam more than 120°C	1.5	1.5	1.5	1.8	2.1

Table 2c VESSELS, HEAT EXCHANGERS AND TANKS – MINIMUM MATERIAL R-VALUE

Content of vessel, heat exchanger or tank	Minimum material <i>R-Value</i>
Refrigerant, brine or glycol that is not more than 2°C	2.7
Refrigerant or chilled water that is more than 2°C but not more than 20°C	1.8
Heated water	1.4

Deemed-to-Satisfy Provisions

Table 2c VESSELS, HEAT EXCHANGERS AND TANKS – MINIMUM MATERIAL R-VALUE— continued

Content of vessel, heat exchanger or tank	Minimum material <i>R-Value</i>
Steam	2.5

SPECIFICATION J5.2d SPACE HEATING

Deemed-to-Satisfy Provisions

1. Scope

This Specification contains the requirements for heaters used for *air-conditioning* or as part of an *air-conditioning* system.

2. Heaters

- (a) A heater used for *air-conditioning* must be—
- (i) a solar heater; or
 - (ii) a gas heater; or
 - (iii) an oil heater, but only if reticulated gas is not available at the allotment boundary; or
 - (iv) a heat pump heater; or
 - (v) a solid-fuel burning heater; or
 - (vi) a heater using reclaimed heat from another process such as reject heat from a refrigeration plant; or
 - (vii) an electric heater if—
 - (A) the heating capacity is not more than—
 - (aa) 10 W/m² of the *floor area* of the *conditioned space* in *climate zone 1*; or
 - (bb) 40 W/m² of the *floor area* of the *conditioned space* in *climate zone 2*; or
 - (cc) the value specified in **Table 2a** where reticulated gas is not available at the allotment boundary; or
 - (B) the annual energy consumption for heating is not more than 15 kWh/m² of the *floor area* of the *conditioned space* in *climate zones 1* to 5; or
 - (C) the in-duct heater complies with **J5.2(a)(i)(B)(cc)**; or
 - (viii) any combination of (i) to (vii).
- (b) An electric heater may be used for heating a bathroom in a Class 3 building or Class 9c building if the heating capacity is not more than 1.2 kW.
- (c) A fixed space heating appliance installed outdoors must be capable of automatic shutdown.
- (d) A water heater, such as a boiler, that is used as part of an *air-conditioning* system must—
- (i) achieve a thermal efficiency complying with **Table 2b** when tested in accordance with BS 7190; and
 - (ii) use reticulated gas where it is available at the allotment boundary.

Deemed-to-Satisfy Provisions

Table 2a MAXIMUM ELECTRIC HEATING CAPACITY

<i>Floor area of the conditioned space</i>	<i>Climate zone</i>				
	3	4	5	6	7
	<i>W/m² of floor area</i>				
Not more than 500 m ²	50	60	55	65	70
More than 500 m ²	40	50	45	55	60

Table 2b MINIMUM THERMAL EFFICIENCY OF A WATER HEATER

Fuel type	Rated capacity (kW_{heating})	Minimum gross thermal efficiency (%)
Gas	Not more than 750	80
	More than 750	83
Oil	All capacities	80

SPECIFICATION J5.2e ENERGY EFFICIENCY RATIOS

Deemed-to-Satisfy Provisions

1. Scope

- (a) This Specification contains the requirements for the energy efficiency ratios of—
- (i) refrigerant chillers used as part of an *air-conditioning* system; and
 - (ii) packaged *air-conditioning* equipment.

2. Energy efficiency ratios

- (a) An *air-conditioning* system refrigerant chiller with a capacity not more than 350 kW_r must have an energy efficiency ratio complying with **Table 2a** when determined in accordance with AHRI 550/590.

Table 2a MINIMUM ENERGY EFFICIENCY RATIO FOR REFRIGERANT CHILLERS

Equipment	Minimum energy efficiency ratio ($W_r/W_{\text{input power}}$)	
	For full load operation	For integrated part load
Water cooled chiller	4.2	5.2
Air cooled or evaporatively cooled chiller	2.5	3.4

- (b) Package *air-conditioning* equipment with a capacity of not less than 65 kW_r, including a split unit and a heat pump, must have a minimum energy efficiency ratio when cooling complying with **Table 2b** when tested in accordance with AS/NZS 3823.1.2 at test condition T1.

Table 2b MINIMUM ENERGY EFFICIENCY RATIO FOR PACKAGED AIR-CONDITIONING EQUIPMENT

Equipment	Minimum energy efficiency ratio ($W_r/W_{\text{input power}}$)	
	65 kW _r to 95 kW _r capacity	More than 95 kW _r capacity
Air-conditioner — cooling	2.70	2.80
Heat pump — cooling	2.60	2.70

SPECIFICATION J6

LIGHTING AND POWER CONTROL DEVICES

Deemed-to-Satisfy Provisions

1. Scope

This Specification contains the requirements for lighting and power control devices including timers, time switches, motion detectors and daylight control devices.

2. Lighting timers

A lighting timer must—

- (a) be located within 2 m of every entry door to the space; and
- (b) have an indicator light that is illuminated when the artificial lighting is off; and
- (c) not control more than—
 - (i) an area of 100 m² with a single push button timer; and
 - (ii) 95% of the lights in spaces of area more than 25 m²; and
- (d) be capable of maintaining the artificial lighting—
 - (i) for not less than 5 minutes and not more than 15 minutes unless it is reset; and
 - (ii) without interruption if the timer is reset.

3. Time switch

- (a) A time switch must be capable of switching on and off electric power at variable pre-programmed times and on variable pre-programmed days.
- (b) A time switch for internal lighting must be capable of being overridden by—
 - (i) a means of turning the lights on, either by—
 - (A) a manual switch or an occupant sensing device that on sensing a person's presence, overrides the time switch for a period of up to 2 hours, after which there is no further presence detected, the time switch must resume control; or
 - (B) an occupant sensing device that overrides the time switch upon a person's entry and returns control to the time switch upon the person's exiting, such as a security card reader; and
 - (ii) a manual "off" switch.
- (c) A time switch for external lighting must be capable of—
 - (i) limiting the period the system is switched on to between 30 minutes before sunset and 30 minutes after sunrise is determined or detected including any pre-programmed period between these times; and
 - (ii) being overridden by a manual switch or a security access system for a period of up to 30 minutes, after which the time switch must resume control.

Deemed-to-Satisfy Provisions

- (d) A time switch for boiling water and chilled water storage units must be capable of being overridden by a manual switch or a security access system that senses a person's presence, overrides for a period of up to 2 hours, after which if there is no further presence detected, the time switch must resume control.

4. Motion detectors

- (a) In a Class 2, 3 or 9c *aged care building* other than within a *sole-occupancy unit*, a motion detector must—
- (i) be capable of sensing movement such as by infra-red, ultrasonic or microwave detection or by a combination of these means; and
 - (ii) be capable of detecting a person before they are 1 m into the space; and
 - (iii) other than within a *sole-occupancy unit* of a Class 3 building, not control more than—
 - (A) an area of 100 m²; and
 - (B) 95% of the lights in spaces of area more than 25 m²; and
 - (iv) be capable of maintaining the artificial lighting when activated—
 - (A) for not less than 5 minutes and not more than 15 minutes unless it is reset; and
 - (B) without interruption if the motion detector is reset by movement.
- (b) In a Class 5, 6, 7, 8, 9a or 9b building, a motion detector must—
- (i) be capable of sensing movement such as by infra-red, ultrasonic or microwave detection or by a combination of these means; and
 - (ii) be capable of detecting—
 - (A) a person before they have entered 1 m into the space; and
 - (B) movement of 500 mm within the useable part of the space; and
 - (iii) not control more than—
 - (A) in other than a *carpark*, an area of 500 m² with a single sensor or group of parallel sensors; and
 - (B) 75% of the lights in spaces using high intensity discharge; and
 - (iv) be capable of maintaining the artificial lighting when activated—
 - (A) for a maximum of 30 minutes unless it is reset; and
 - (B) without interruption if the motion detector is reset by movement; and
 - (v) not be overridden by a manual switch to permanently leave the lights on.
- (c) When outside a building, a motion detector must—
- (i) be capable of sensing movement such as by infra-red, ultrasonic or microwave detection or by a combination of these means; and
 - (ii) be capable of detecting a person within a distance from the light equal to—
 - (A) twice the mounting height; or
 - (B) 80% of the ground area covered by the light's beam; and

Deemed-to-Satisfy Provisions

- (iii) not control more than five lights; and
- (iv) be operated in series with a photoelectric cell or astronomical time switch so that the light will not operate in daylight hours; and
- (v) be capable of maintaining the artificial lighting when the switch is on for a maximum of 10 minutes unless it is reset; and
- (vi) have a manual override switch which is reset after a maximum period of 4 hours.

5. Daylight sensor and dynamic lighting control device

- (a) A daylight sensor and dynamic control device for artificial lighting must—
 - (i) for switching on and off—
 - (A) be capable of having the switching level set point adjusted between 50 and 1000 Lux; and
 - (B) have—
 - (aa) a delay of more than 2 minutes; and
 - (bb) a differential of more than 100 Lux for a sensor controlling high pressure discharge lighting, and 50 Lux for a sensor controlling other than high pressure discharge lighting; and
 - (ii) for dimmed or stepped switching, be capable of reducing the power consumed by the controlled lighting in proportion to the incident daylight on the working plane either—
 - (A) continuously down to a power consumption that is less than 50% of full power; or
 - (B) in no less than 4 steps down to a power consumption that is less than 50% of full power.
- (b) Where a daylight sensor and dynamic control device has a manual override switch, the manual override switch must not be able to switch the lights permanently on or bypass the lighting controls.

STATE & TERRITORY APPENDICES

Commonwealth of Australia

Australian Capital Territory

New South Wales

Northern Territory

Queensland

South Australia

Tasmania

Victoria

Western Australia

COMMONWEALTH OF AUSTRALIA

APPENDIX CONTENTS

APPENDIX COMMONWEALTH OF AUSTRALIA

Commonwealth of Australia

Footnote: Other Legislation and Policies Affecting Buildings

Footnote: OTHER LEGISLATION AND POLICIES AFFECTING BUILDINGS

In addition to any applicable provisions of this Code, there are a number of other legislative technical requirements and policies affecting the design, construction and/or performance of buildings that practitioners may need to be aware of, including, but not necessarily limited to, the following list. Additional legislative instruments such as regulations, codes and standards may exist under the legislation listed.

1. Aged Care Buildings

1.1 Administering Agency

Department of Social Services

Relevant Legislation

Aged Care Act 1997

1999 Certification Assessment Instrument

2. Australian Capital Territory

2.1 Administering Agency

Department of Finance

Relevant Legislation

Australian Capital Territory (Planning and Land Management) Act 1988

Parliament Act 1974

3. Child Care

3.1 Administering Agency

Department of Education

Relevant Legislation

Child Care Benefit (Eligibility of Child Care Services for Approval and Continued Approval) Determination 2000

4. Christmas Island

4.1 Administering Agency

Department of Infrastructure and Regional Development

Relevant Legislation

Casino Control Ordinance 1988

Casino Control Regulations 1988

Christmas Island Space Centre (APSC Proposal) Ordinance 2001

Christmas Island Space Centre (APSC Proposal) Regulations 2001

Gambling (Clubs) Ordinance 1978

Christmas Island Act 1958

5. Communications and Information Technology

5.1 Administering Agency

Department of Communications

Relevant Legislation

Australian Postal Corporation Act 1989

National Transmission Network Sale Act 1998

Telecommunications Act 1997

Telstra Corporation Act 1991

Telecommunications (Consumer Protection and Service Standards) Act 1999

6. Defence Buildings

6.1 Administering Agency

Department of Defence

Relevant Legislation

Defence Act 1903

Relevant Regulations

Defence (Areas Control) Regulations 1989

Relevant Codes, Standards and Publications

Manual of Fire Protection Engineering

Requirements for the Provision of Disabled Access and other Facilities for People with a Disability in Defence

Heating, Ventilation and Air Conditioning Policy

Microbial Control in Air Handling and Water Systems of Defence Buildings

Building Energy Performance Manual

Manual of Infrastructure Engineering - Electrical

Manual of Infrastructure Engineering - Bulk Fuel Installation Design

Defence Communications Cabling Standard

Defence Training Area Management Manual

Defence Safety Manual

Defence Security Manual

Defence Explosive Ordinance Publications

The Defence Estate Quality Management System (<http://www.defence.gov.au/im/>) contains further requirements including the principles of development, zone planning, site selection, engineering requirements and environmental impact assessment and approval requirements.

7. Disability Discrimination

7.1 Administering Agency

Attorney-General's Department

Relevant Legislation

Disability (Access to Premises - Buildings) Standards 2010

Disability Discrimination Act 1992

Disability Standards for Accessible Public Transport 2002

8. Environment

8.1 Administering Agency

Department of the Environment

Relevant Legislation

Environmental Protection and Biodiversity Conservation Act 1999

8.2 Administering Agency

Department of Industry

Relevant Policy

Energy Efficiency in Government Operations (2006)

9. Federal Airports

9.1 Administering Agency

Department of Infrastructure and Regional Development

Relevant Legislation

Airports Act 1996

Airports Regulations 1997

Airports (Building Control) Regulations 1996

Airports (Control of On-Airport Activities) Regulations 1997

Airports (Environmental Protection) Regulations 1997

Airports (Protection of Airspace) Regulations 1996

10. Jervis Bay Territory

10.1 Administering Agency

Department of Infrastructure and Regional Development

Relevant Legislation

Jervis Bay Territory Acceptance Act 1915

11. Occupational Health and Safety

11.1 Administering Agency

Department of Employment

Relevant Legislation

Work Health and Safety Act 2011

Work Health and Safety Regulations 2011

12. Australian Antarctic Territory

12.1 Administering Agency

Australian Antarctic Division of the Department of the Environment

Relevant Legislation

Antarctic Treaty (Environment Protection) Act 1980

Antarctic Treaty (Environment Protection) (Environmental Impact Assessment) Regulations 1993

Antarctic Treaty (Environment Protection) (Waste Management) Regulations 1994

Environment Protection and Biodiversity Conservation Act 1999

Environment Protection and Biodiversity Conservation Regulations 2000

13. Territory of Heard Island and McDonald Islands

13.1 Administering Agency

Australian Antarctic Division of the Department of the Environment

Relevant Legislation

Environment Protection and Management Ordinance 1987

Antarctic Treaty (Environment Protection) (Environmental Impact Assessment) Regulations 1993

Environment Protection and Biodiversity Conservation Act 1999

Heard Island and McDonald Islands Marine Reserve management plan in operation under the Environment Protection and Biodiversity Conservation Act 1999

Environment Protection and Biodiversity Conservation Regulations 2000

14. National or World Heritage Places

14.1 Administering Agency

Department of the Environment

Relevant Legislation

Environment Protection and Management Ordinance 1987

Antarctic Treaty (Environment Protection) (Environmental Impact Assessment) Regulations 1993

Environment Protection and Biodiversity Conservation Act 1999

Heard Island and McDonald Islands Marine Reserve management plan in operation under the Environment Protection and Biodiversity Conservation Act 1999

Environment Protection and Biodiversity Conservation Regulations 2000

15. National Parks

15.1 Administering Agency

Director of National Parks

Relevant Legislation

Commonwealth Reserve management plans in operation under the Environment Protection and Biodiversity Conservation Act 1999

Environment Protection and Biodiversity Conservation Act 1999

Environment Protection and Biodiversity Conservation Regulations 2000

16. Commonwealth funding for building work

16.1 Administering Agency

Department of Employment

Relevant Legislation

Fair Work (Building Industry) Act 2012

Fair Work (Building Industry) Regulations 2005

Fair Work (Building Industry - Accreditation Scheme) Regulations 2005

Building Code 2013 (issued under Section 27 of the Fair Work (Building Industry) Act 2012)

17. Commonwealth buildings

17.1 Administering Agency

Department of Employment

Relevant Legislation

Fair Work (Building Industry) Act 2012

Fair Work (Building Industry) Regulations 2005

Fair Work (Building Industry - Accreditation Scheme) Regulations 2005

Building Code 2013 (issued under Section 27 of the Fair Work (Building Industry) Act 2012)

AUSTRALIAN CAPITAL TERRITORY

INTRODUCTION

The Australian Capital Territory BCA Appendix forms part of the ACT Building Code published in accordance with the provisions of the ACT Building Act 2004. This Appendix contains variations and additions to the Building Code of Australia which are necessary for the effective application of the Code in the Australian Capital Territory.

IMPORTANT INFORMATION – THIS APPENDIX MAY HAVE BEEN SUPERSEDED

This version of the Australian Capital Territory BCA Appendix may have been repealed, superseded or amended since being drafted for inclusion in this edition of the BCA. Therefore, users of this version of the BCA should check to see if the following appendix is the version that is currently in force. Amendments or newer versions of the Appendix are notified on the ACT legislation register at www.legislation.act.gov.au.

APPENDIX CONTENTS

APPENDIX AUSTRALIAN CAPITAL TERRITORY

Australian Capital Territory

A GENERAL PROVISIONS

ACT Specification A1.3 Documents Adopted by Reference
ACT AO2 Objective
ACT AF2.1 - AF2.2 Functional Statements
ACT AP2.1 - ACT AP2.2 Performance Requirements
ACT A2.0 Deemed-to-Satisfy Provisions
ACT A2.101 Control of litter on building sites
ACT A2.102 Waste management

D ACCESS AND EGRESS

ACT DPO.1 - ACT DPO.5 Performance Requirements
ACT D1.101 Notices on fire-isolated stairs
ACT D1.102 Access for people with disabilities
ACT D3.4 Exemptions

G ANCILLARY PROVISIONS

ACT GO1 Objective
ACT GF1.2 Functional Statements
ACT GP1.2 Performance Requirements
ACT G1.1 Swimming pools
ACT G2.2 Installation of appliances

J ENERGY EFFICIENCY

ACT J1.1 Sustainability

Footnote: Other Legislation Affecting Buildings

SECTION A GENERAL PROVISIONS

PART A1 INTERPRETATION

ACT Specification A1.3 DOCUMENTS ADOPTED BY REFERENCE

Insert in Table 1 of Specification A1.3 the following:

ACT Table 1: SCHEDULE OF REFERENCED DOCUMENTS

No.	Date	Title	BCA Clause(s)
AS 1375	2013	Industrial fuel-fired appliances	ACT G2.2
AS 1692	2006 Amdt 1	Tanks for flammable and combustible liquids	ACT G2.2
Development Control Code for Best Practice Waste Management in the ACT			ACT A2.102

PART A2 ACCEPTANCE OF DESIGN AND CONSTRUCTION

Add ACT AO2 as follows:

OBJECTIVE

ACT AO2

The *Objective* of this Part is to—

- (a) prevent windblown litter from building sites fouling roads and public land; and
- (b) safeguard people from injury caused by infection or contamination from solid waste.

Add ACT AF2.1 to ACT AF2.2 as follows:

FUNCTIONAL STATEMENTS

ACT AF2.1

Building litter must be prevented from spreading around and beyond the allotment boundary.

ACT AF2.2

Buildings must be provided with space and facilities for the collection, and safe, hygienic holding prior to disposal of solid waste arising from the intended use of the building.

Add ACT AP2.1 to ACT AP2.2 as follows:

PERFORMANCE REQUIREMENTS

ACT AP2.1

Sufficient containers must be provided on building sites to store building waste that is likely to become windblown.

ACT AP2.2

Provision must be made within buildings for the collection and temporary holding of solid waste. The design must accommodate screening, volume of waste, disposal, logistics and access.

Add ACT A2.0 as follows:

DEEMED-TO-SATISFY PROVISIONS

ACT A2.0 Deemed-to-Satisfy Provisions

Performance Requirements **ACT AP2.1** to **ACT AP2.2** are satisfied by complying with **ACT A2.101** to **ACT A2.102**.

Add ACT A2.101 to ACT A2.103 as follows:

ACT A2.101 Control of litter on building sites

- (a) On-site building waste must be stored in suitable size plastic or metal bins and removed from the allotment at regular intervals.
- (b) For the purpose of this clause, building waste includes plastic containers, plastic and paper wrappings, or any waste that can be carried by wind.

ACT A2.102 Waste management

Garbage facilities must be designed and constructed in accordance with the Development Control Code for Best Practice Waste Management in the ACT.

SECTION D ACCESS AND EGRESS

Add ACT DP0.1 to ACT DP0.5 as follows:

PERFORMANCE REQUIREMENTS

ACT DP0.1 Existing passenger lift or existing toilet concession

Access to passenger lifts or toilets need not be provided in accordance with the requirements of Sections **D**, **E** or **F**, insofar as they relate to matters covered by **DP0.2** or **DP0.3**, and specifically only relate to people with a disability, if the relevant concession in **DP0.2** or **DP0.3** applies.

ACT DP0.2 Lift concession

- (a) The requirement in **Table E3.6(b)** that a lift is to have a floor dimension of not less than 1400 mm x 1600 mm does not apply to an existing passenger lift that is in a new part, or an affected part, of a building, if the lift—
- (i) travels more than 12 m; and
 - (ii) has a lift floor that is not less than 1100 mm x 1400 mm.

ACT DP0.3 Toilet concession

- (a) The requirements in **F2.4** Accessible sanitary fixtures, to the extent that they require compliance with AS 1428.1 — 2009, Design for access and mobility, Part 1: General requirements for access — New building work, do not apply to—
- (i) existing *accessible sanitary compartments*; and
 - (ii) existing *sanitary compartments* suitable for use by people with a disability; and
- (b) the *sanitary compartment* mentioned in paragraph (i) or (ii) complies with AS 1428.1—2001, Design for access and mobility, Part 1: General requirements for access — New building work.

ACT DP0.4 Application to Class 1b buildings

- (a) Where the BCA applies to the following kinds of Class 1b buildings, the provisions of NCC Volume One that indicate they apply to Class 1b buildings, apply only to the following kinds of Class 1b buildings, insofar as they specifically only relate to people with a disability—
- (i) a new building with 1 or more bedrooms used for rental accommodation; or
 - (ii) an existing building with 4 or more bedrooms used for rental accommodation; or
 - (iii) a building that comprises 4 or more single dwellings that are—
 - (A) on the same allotment; and
 - (B) used for short-term holiday accommodation.

ACT DP0.5 Meaning of certain terms

Terms in **ACT DP0.1**, **ACT DP0.2**, **ACT DP0.3** or **ACT DP 0.4** that also have their meaning defined in the Disability (Access to Premises — Buildings) Standards 2010, determined under the Disability Discrimination Act 1992 (Commonwealth), have that meaning.

Explanatory information:

ACT DP0.1 to **ACT DP0.4** mirror the respective provisions of the Disability (Access to Premises — Buildings) Standards 2010, determined under the Disability Discrimination Act 1992 (Commonwealth). Where a provision of **ACT DP0.1**, **ACT DP0.2**, **ACT DP0.3** or **ACT DP0.4** indicates it applies to something in the NCC, insofar as the thing specifically only relates to people with a disability, the provision does not permit other relevant NCC provisions to not apply.

Note:

ACT legislation other than the BCA also regulates for access and mobility.

Practitioners should ensure they check the latest version of relevant legislation, and the latest version of this Appendix, available through the ACT legislation register at www.legislation.act.gov.au.

PART D1 PROVISION FOR ESCAPE

Add ACT D1.101 and ACT D1.102 as follows:

ACT D1.101 Notices on fire-isolated stairs

- (a) Every *fire-isolated stairway* must have a notice displayed in a conspicuous position at the landing on each *storey* level to the effect of the following:

OFFENCES RELATING TO FIRE STAIRS

Under the Emergencies Act 2004 it is an offence to:

1. Place anything in this stairway or any associated passageway leading to the exterior of the building which may impede the free passage of persons; or
2. Interfere with or cause obstruction or impediment to the normal operation of fire doors providing access to this stairway; or
3. Remove, damage or otherwise interfere with this notice.

- (b) In any notice displayed in accordance with (a)—
- (i) the words “OFFENCES RELATING TO FIRE STAIRS” must be in letters not less than 20 mm in height; and
 - (ii) all other letters and figures in the remainder of the notice must be not less than 3 mm in height; and
 - (iii) the notice must be clearly legible with lettering of a colour contrasting with the background embossed or cast into a permanent plate securely and permanently fixed to the wall.

ACT D1.102 Access for people with disabilities

Other requirements must be considered in respect of requirements for people with disabilities, including the ACT Territory Plan under the Planning and Development Act 2008 (ACT) and the Disability Discrimination Act 2004 (Commonwealth), and any further applicable amendments to this Appendix. Where additional provisions of the ACT Appendix to NCC Volume One have been made by instrument under the Building Act 2004 (ACT), relevant building work or buildings may comply with the applicable provisions, as permitted by the provisions. NCC Volume One

users should check the latest ACT BCA appendices made under the Building Act 2004 (ACT) at: <http://www.legislation.act.gov.au/a/2004-11/di.asp>.

PART D3 ACCESS FOR PEOPLE WITH A DISABILITY

Add ACT D3.4(d) as follows:

ACT D3.4 Exemptions

- (d) an area covered by, and in the respective circumstances covered by, and to the relevant extent provided for by, [ACT DP0.1](#), [ACT DP0.2](#), [ACT DP0.3](#) or [ACT DP0.4](#).

SECTION G ANCILLARY PROVISIONS

PART G1 MINOR STRUCTURES AND COMPONENTS

Delete GO1(c) and insert ACT GO1(c) as follows:

OBJECTIVE

ACT GO1

- (c) safeguard young children from drowning or injury in a *swimming pool*; and

Application:

[ACT GO1\(c\)](#) only applies to a *swimming pool* associated with a Class 2 or 3 building or Class 4 part of a building, with a depth of water more than 300 mm.

Delete GF1.2(a) and insert ACT GF1.2(a) as follows:

FUNCTIONAL STATEMENTS

ACT GF1.2

A *swimming pool* is to be provided with—

- (a) means of restricting access by young children to it; and

Application:

[ACT GF1.2\(a\)](#) only applies to a *swimming pool* associated with a Class 2 or 3 building or Class 4 part of a building, with a depth of water more than 300 mm.

Delete GP1.2(a) and insert ACT GP1.2(a) as follows:

PERFORMANCE REQUIREMENTS

ACT GP1.2

- (a) A barrier must be provided to a *swimming pool* and must—
- (i) be continuous for the full extent of the hazard; and
 - (ii) be of a strength and rigidity to withstand the foreseeable impact of people; and
 - (iii) restrict the access of young children to the pool and the immediate pool surrounds; and
 - (iv) have any gates and doors fitted with latching devices not readily operated by young children, and constructed to automatically close and latch.

Application:

ACT GP1.2(a) only applies to a *swimming pool* associated with a Class 2 or 3 building or Class 4 part of a building, with a depth of water more than 300 mm.

Add ACT G1.1(d) and (e) as follows:

ACT G1.1 Swimming pools

- (d) Indoor or outdoor permanent bathing, wading and *swimming pools* must—
- (i) where the capacity of the pool exceeds 10 m³—
 - (A) be of the recirculation type in which the water circulation is maintained through the pool by pumps, the water drawn from the pool being clarified and disinfected before being returned to the pool; and
 - (B) have means of egress provided in the form of ladders, steps in the floor of the pool or a ramp; and
 - (ii) be capable of being completely emptied and any discharge or overflow and pool backwash filter must be connected to the sewer drainage system.
- (e) Pools in or forming part of buildings other than Class 1 buildings—
- (i) where in any part of the pool the depth is less than 1500 mm, the floor grade must not exceed a slope of 1 in 20; and
 - (ii) permanent signs must be displayed on the side of the pool (or adjacent concourse for flush concourse waterline pools), showing the depth at 300 mm change intervals for the length of the pool and the depth at the deep and shallow ends.

PART G2 HEATING APPLIANCES, CHIMNEYS AND FLUES

Add ACT G2.2 as follows:

ACT G2.2 Installation of appliances

- (d) An industrial fuel-fired appliance: AS 1375.
- (e) Storage tanks and other associated fittings: AS 1692.

SECTION J ENERGY EFFICIENCY

ACT J1.1 SUSTAINABILITY

Note:

Other ACT legislation also regulates for sustainability when constructing or altering buildings, including their services. For example, the Water and Sewerage Act 2000 has relevant provisions in relation to water and sanitary plumbing, and sanitary drainage, which are intended to facilitate a reduction in water usage and energy used to heat water, and greenhouse gas emission. The Building (General) Regulation 2004 has provisions about applying certain BCA provisions, and alternatives to those provisions, to pre-existing parts of certain buildings, aimed at increasing the energy efficiency of the pre-existing part, amongst other things, when the pre-existing building is substantially altered or extended.

Practitioners should ensure they check the latest version of relevant legislation, and the latest version of the ACT BCA appendix, available through the ACT legislation register at www.legislation.act.gov.au.

Footnote: OTHER LEGISLATION AFFECTING BUILDINGS

In addition to any applicable provisions of the Building Act 2004 and this Code, there are a number of other legislative technical requirements affecting the design, construction and/or performance of buildings that practitioners may need to be aware of, including, but not necessarily limited to, the following list. Additional legislative instruments such as regulations, codes and standards may exist under the legislation listed.

1. Construction Occupations

1.1 Administering Agency

Chief Minister, Treasury and Economic Development Directorate

Relevant Legislation

Construction Occupations (Licensing) Act 2004

2. Dangerous Substances

2.1 Administering Agency

Chief Minister, Treasury and Economic Development Directorate

Relevant Legislation

Dangerous Substances Act 2004

3. Electricity and Gas Safety

3.1 Administering Agency

Chief Minister, Treasury and Economic Development Directorate

Relevant Legislation

Electricity Safety Act 1971

Gas Safety Act 2000

4. Environmental Protection and Nature Conservation

4.1 Administering Agency

Environment and Planning Directorate

Relevant Legislation

Environment Protection Act 1997

Nature Conservation Act 2014

5. Fences and Party Walls

5.1 Administering Agency

Justice and Community Safety Directorate

Relevant Legislation

Common Boundaries Act 1981

6. Fire Safety

6.1 Administering Agency

Justice and Community Safety Directorate

Chief Minister, Treasury and Economic Development Directorate

Relevant Legislation

Emergencies Act 2004

7. Heritage Conservation

7.1 Administering Agency

Environment and Planning Directorate

Relevant Legislation

Heritage Act 2004

8. Land Use and Development Control

8.1 Administering Agency

Environment and Planning Directorate

Relevant Legislation

Planning and Development Act 2007

Unit Titles Act 2001

9. Liquor Premises

9.1 Administering Agency

Justice and Community Safety Directorate

Relevant Legislation

Liquor Act 2010

10. Machinery, Scaffolding and Lifts

10.1 Administering Agency

Chief Minister, Treasury and Economic Development Directorate

Relevant Legislation

Machinery Act 1949

Scaffolding and Lifts Act 1912

11. Occupational Health and Safety

11.1 Administering Agency

Chief Minister, Treasury and Economic Development Directorate

Relevant Legislation

Work Health and Safety Act 2011

12. Plumbing and Drainage

12.1 Administering Agency

Chief Minister, Treasury and Economic Development Directorate

Relevant Legislation

Water and Sewerage Act 2000

13. Public Health

13.1 Administering Agency

Health Directorate

Relevant Legislation

Public Health Act 1997

14. Public Unleased Land and Roads

14.1 Administering Agency

Territory and Municipal Services Directorate

Relevant Legislation

Public Unleased Land Act 2013

15. Utilities

15.1 Administering Agency

Justice and Community Safety Directorate

Territory and Municipal Services Directorate

Chief Minister, Treasury and Economic Development Directorate

Relevant Legislation

Utilities Act 2000

16. Waste

16.1 Administering Agency

Territory and Municipal Services Directorate

Relevant Legislation

Waste Minimisation Act 2001

17. Water and Sewerage

17.1 Administering Agency

Chief Minister, Treasury and Economic Development Directorate

Relevant Legislation

Water and Sewerage Act 2000

NEW SOUTH WALES

INTRODUCTION

The NSW Building Code technical package consists of-

- (i) the Building Code of Australia (BCA) Volume One and Volume Two; and
- (ii) the New South Wales BCA Appendix which contains variations to the requirements of the BCA and additional provisions applicable in New South Wales.

The technical package is accompanied by administrative provisions contained within the Environmental Planning and Assessment (EP & A) Act 1979 and the Environmental Planning and Assessment (EP & A) Regulation 2000.

APPENDIX CONTENTS

APPENDIX NEW SOUTH WALES

New South Wales

A GENERAL PROVISIONS

NSW A1.1 Definitions
NSW A3.2 Classifications
NSW Specification A1.3 Standards Adopted by Reference

C FIRE RESISTANCE

NSW C1.10 Fire hazard properties
NSW C2.5 Class 9a and 9c buildings
NSW C3.11 Bounding construction: Class 2, 3, 4 and 9b buildings
NSW Specification C1.10 Fire Hazard Properties

D ACCESS AND EGRESS

NSW D1.2 Number of exits required
NSW D1.6 Dimensions of exits
NSW D1.10 Discharge from exits
NSW Table D1.13 Area per person according to use
NSW D2.1 Application of Part
NSW D2.13 Treads and risers
NSW D2.15 Thresholds
NSW D2.16 Barriers
NSW D2.19 Doorways and doors
NSW D2.21 Operation of latch
NSW D2.101 Doors in path of travel in an entertainment venue

E SERVICES AND EQUIPMENT

NSW EP1.4
NSW Table E1.5
NSW Table E2.2a General Provisions
NSW Table E2.2b Specific Provisions
NSW Specification E2.2a Smoke Detectors and Alarm Systems
NSW E4.6 Direction signs

F HEALTH AND AMENITY

NSW FP2.6 Performance Requirements
NSW F2.7 Microbial (legionella) control
NSW F4.5 Ventilation of rooms

G ANCILLARY PROVISIONS

- NSW GP1.2 Performance Requirements
- NSW G1.1 Swimming pools
- NSW G1.101 Provision for cleaning windows
- NSW GP5.1 Performance Requirements
- NSW G5.2 Protection

H SPECIAL USE BUILDINGS

- NSW H1.1 Application of Part

**NSW Part H101 ENTERTAINMENT VENUES OTHER THAN TEMPORARY
STRUCTURES AND DRIVE-IN THEATRES**

- NSW H101.1 Application of Part
- NSW H101.2 Fire separation
- NSW H101.3 Foyer space
- NSW H101.4 Sprinkler systems for common foyers
- NSW H101.5 Conventional stages
- NSW H101.6 Non-conventional stages
- NSW H101.7 Flying scenery
- NSW H101.8 Load notice
- NSW H101.9 * * * * *
- NSW H101.10 Safety curtains
- NSW H101.11 Seating in rows
- NSW H101.12 Continental seating
- NSW H101.13 Provision of guardrails
- NSW H101.14 Guardrails
- NSW H101.15 Dressing rooms
- NSW H101.16 Storerooms
- NSW H101.17 Projection suites
- NSW H101.18 Basement storeys
- NSW H101.19 Electric mains installation
- NSW H101.20 Lighting
- NSW H101.21 * * * * *
- NSW H101.22 Automatic smoke-and-heat vents for stages
- NSW H101.23 Solid fuel burning stoves and open fire places
- NSW H101.24 Fuel gas cylinders

NSW Part H102 TEMPORARY STRUCTURES

- NSW H102.1 Application of Part
- NSW H102.2 Exits — Exclusions
- NSW H102.3 Location of exits
- NSW H102.4 Exits to be provided
- NSW H102.5 Vertical clearances for exits
- NSW H102.6 Curtains across exits
- NSW H102.7 Curtains and blinds
- NSW H102.8 Fabrics
- NSW H102.9 Guardrails
- NSW H102.10 Seating
- NSW H102.11 Sanitary accommodation
- NSW H102.12 Projection suites
- NSW H102.13 Fireplaces and heating
- NSW H102.14 Electrical services

NSW H102.15 Artificial lighting
NSW H102.16 Exit signs
NSW H102.17 Fire-fighting services

NSW Part H103 DRIVE-IN THEATRES

NSW H103.1 Application of Part
NSW H103.2 Speaker standards
NSW H103.3 Electrical services
NSW H103.4 Vehicular entrances
NSW H103.5 Lighting

J ENERGY EFFICIENCY

NSW SUBSECTION J(A) ENERGY EFFICIENCY - CLASS 2 BUILDINGS AND CLASS 4 PARTS

NSW J(A)P1 to NSW J(A)P3 Performance Requirements

NSW J(A)1 BUILDING FABRIC

NSW J(A)1.0 Deemed-to-Satisfy Provisions
NSW J(A)1.1 Application of Part
NSW J(A)1.2 Compliance with BCA provisions

NSW J(A)2 BUILDING SEALING

NSW J(A)2.0 Deemed-to-Satisfy Provisions
NSW J(A)2.1 Application of Part
NSW J(A)2.2 Compliance with BCA provisions

NSW J(A)3 AIR-CONDITIONING AND VENTILATION SYSTEMS

NSW J(A)3.0 Deemed-to-Satisfy Provisions
NSW J(A)3.1 Application of Part
NSW J(A)3.2 Compliance with BCA provisions

NSW J(A)4 HEATED WATER SUPPLY

NSW J(A)4.0 Deemed-to-Satisfy Provisions
NSW J(A)4.1 Application of Part
NSW J(A)4.2 Compliance with BCA provisions

NSW J(A)5 FACILITIES FOR ENERGY MONITORING

NSW J(A)5.0 Deemed-to-Satisfy Provisions
NSW J(A)5.1 Application of Part
NSW J(A)5.2 * * * * *
NSW J(A)5.3 Compliance with BCA provisions

NSW SUBSECTION J(B) ENERGY EFFICIENCY - CLASS 3 AND CLASS 5 TO 9 BUILDINGS

NSW J(B)1 Compliance with BCA provisions
NSW J3.1 Application of Part

Footnote: Other Legislation Affecting Buildings

SECTION A GENERAL PROVISIONS

PART A1 INTERPRETATION

NSW A1.1 Definitions

Insert definition for *aisle* as follows:

Aisle means a walkway at the end of *rows* of seating, not being *continental seating*, leading to a cross-over or to an egress doorway.

Vary definition of *appropriate authority* as follows:

Appropriate authority means the relevant authority with the responsibility to determine the particular matter.

Insert definition of *assembly building* as follows:

Assembly building means a building where people may assemble for—

- (a) civic, theatrical, social, political or religious purposes including a library, theatre, public hall or place of worship; or
- (b) educational purposes in a *school*, *early childhood centre*, preschool, or the like; or
- (c) entertainment, recreational or sporting purposes including—
 - (i) a cinema; or
 - (ii) a sports stadium, sporting or other club; or
- (d) transit purposes including a bus station, railway station, airport or ferry terminal.

Insert definition for *auditorium* as follows:

Auditorium means a part of an *entertainment venue* used or intended to be used for the purposes of accommodating an audience to an entertainment.

Insert definition of *continental seating* as follows:

Continental seating means *rows* of seating in which the *rows* extend the full width of an *auditorium* without intervening *aisles*.

Insert definition of *cross-over* as follows:

Cross-over in relation to an *entertainment venue* or *temporary structure*, means a walkway between *aisles* or between an *aisle* and an egress doorway.

Vary definition for *designated bushfire prone area* as follows:

Designated bushfire prone area means land that:

- (a) has been designated under legislation; or
- (b) has been identified under an environmental planning instrument, development control plan or in the course of processing and determining a development application,

as land that can support a bushfire or is likely to be subject to bushfire attack.

Vary definition for *early childhood centre* as follows:

Early childhood centre means a preschool, kindergarten or child-minding centre for the care or training of more than 5 children.

Insert definition for *entertainment venue* as follows:

Entertainment venue is as defined in the Environmental Planning and Assessment Regulation 2000.

Insert definition of *film* as follows:

Film means a cinematograph *film* of a size of 35 mm or greater.

Insert definition of *flying scenery* as follows:

Flying scenery means scenery of a kind that is lifted above the *stage* floor by means of lines run from a *grid*.

Insert definition of *grid* as follows:

Grid means a framework from which lines are run for the purpose of lifting *flying scenery* above the *stage* floor.

Insert definition of *minimum lateral clearance* as follows:

Minimum lateral clearance means a permanently unobstructed space having a height above floor level of not less than 2000 mm and a width of not less than the specified measurement.

Insert definition of *projection suite* as follows:

Projection suite means such part of an *entertainment venue* as is designed to accommodate apparatus used for projecting *films*.

Insert definition of *row* as follows:

Row means a *row* of seating—

- (a) between a wall or other barrier and an *aisle*; or
- (b) between 2 *aisles*.

Insert definition of *special fire protection purpose* as follows:

Special fire protection purpose (as per Section 100B(6) of the Rural Fires Act 1997) means any of the following purposes:

- (a) a school,
- (b) a child care centre,
- (c) a hospital (including a hospital for the mentally ill or mentally disordered),
- (d) a hotel, motel or other tourist accommodation,
- (e) a building wholly or principally used as a home or other establishment for mentally incapacitated persons,
- (f) seniors housing within the meaning of State Environmental Planning Policy (Housing for Seniors or People with a Disability) 2004,
- (g) a group home within the meaning of State Environmental Planning Policy No 9 - Group Homes (now SEPP (Affordable Rental Housing) 2009),
- (h) a retirement village,
- (i) any other purpose prescribed by the regulations (Rural Fires Regulation 2013).

Note: For application of this definition in the BCA, the term "school" does not include a college, university or similar tertiary educational establishment.

Insert definition of *temporary structure* as follows:

Temporary structure means—

- (a) a booth, tent or other temporary enclosure, whether or not a part of the booth, tent or enclosure is permanent; or
- (b) a mobile structure.

NSW A3.2 Classifications

In A3.2 replace the definition of **Class 6** as follows:

Class 6: a shop or other building for the sale of goods by retail or the supply of services direct to the public, including—

- (a) an eating room, cafe, restaurant, milk or soft-drink bar; or
- (b) a dining room, bar, shop or kiosk part of a hotel or motel; or
- (c) a hairdresser's or barber's shop, public laundry, or undertaker's establishment; or
- (d) market or sale room, showroom, or *service station*.

NSW Specification A1.3 DOCUMENTS ADOPTED BY REFERENCE

In Table 1, insert additional reference as follows:

NSW Table 1: SCHEDULE OF REFERENCED DOCUMENTS

No.	Date	Title	BCA Clause
AS/NZS 1596	2008	The Storage and Handling of LP Gas	NSW H101.24.1
AS 2001 Part 5.4	1987	Methods of test for textiles Determination of dimensional change in laundering of textile fabrics and garments — Automatic machine method	NSW Specification C1.10
AS/NZS 3000	2000	Electrical installations — Buildings, structures and premises (SAA wiring rules)	NSW H102.14
AS 3002	1985	Electrical installations — Shows and carnivals	NSW H102.14
SSL		Appraisal Specification FAS102	NSW H101.17.1
NSW Legislation	1979	Environmental Planning and Assessment Act	NSW G5.2, NSW J(A)P1, NSW J(A)1.1
NSW Legislation	2000	Environmental Planning and Assessment Regulation	NSW A1.1, NSW H101.1, NSW H101.17.1
NSW Legislation	1997	Rural Fires Act	NSW A1.1, NSW G5.2
NSW Legislation	1992	Swimming Pools Act	NSW GP1.2, NSW G1.1

NSW Table 1: SCHEDULE OF REFERENCED DOCUMENTS — continued

No.	Date	Title	BCA Clause
NSW Legislation	2008	Swimming Pools Regulation	NSW GP1.2, NSW G1.1

SECTION C FIRE RESISTANCE

PART C1 FIRE RESISTANCE AND STABILITY

Delete C1.10(a)(v), C1.10(b) and C1.10(c)(xiii) and insert NSW C1.10(a)(v), NSW C1.10(b) and NSW C1.10(c)(xiii) as follows:

NSW C1.10 Fire hazard properties

- (a) The *fire hazard properties* of the following linings, materials and assemblies in a Class 2 to 9 building must comply with **Specification C1.10**:
 - (v) In Class 9b buildings used as—
 - (A) an *entertainment venue*, a material used to cover closed back upholstered seats; and
 - (B) a public hall or the like, a proscenium curtain *required* by **Specification H1.3**.
- (b) Paint or fire-retardant coatings must not be used in order to make a material comply with a *required fire hazard property*, except in respect of a material referred to in **NSW Specification C1.10**, **NSW Table 4** and to which Notes 4 and 5 are applicable.
- (c) The requirements of (a) do not apply to a material or assembly if it is—
 - (xiii) an attached non-building fixture and fitting such as—
 - (A) a curtain, blind, or similar decor, other than—
 - (aa) a proscenium curtain *required* by **Specification H1.3**; or
 - (bb) in a Class 9b building used as an *entertainment venue*, a material that is regulated under **NSW Table 4**; and
 - (B) a whiteboard, *window* treatment or the like; or

PART C2 COMPARTMENTATION AND SEPARATION

Delete C2.5(b) and insert NSW C2.5(b) as follows:

NSW C2.5 Class 9a and 9c buildings

- (b) A Class 9c building must comply with the following:
 - (i) A building must be divided into areas not more than 500 m² by smoke proof walls complying with **Specification C2.5**.
 - (ii) A *fire compartment* must be separated from the remainder of the building by *fire walls* and notwithstanding **C2.7** and **Specification C1.1**, floors with an FRL of not less than 60/60/60.
 - (iii) Except for walls provided in accordance with (b)(i) and (ii), non-loadbearing *internal walls*, and if a building is of Type C construction — all *internal walls*, between and

bounding *sole-occupancy-units* and bounding a *public corridor* in a *resident use area* must:

- (A) be lined on each side with standard grade plasterboard not less than 13 mm thick or a material with at least an equivalent level of fire protection; and
 - (B) if provided with cavity insulation, contain only *non-combustible* insulation; and
 - (C) extend to the underside of—
 - (aa) the floor next above; or
 - (bb) a ceiling lined with standard grade plasterboard not less than 13 mm thick or an equivalent non-combustible material; or
 - (cc) a *non-combustible* roof covering; and
 - (D) not incorporate any penetrations above door head height unless the penetrations are adequately stopped to prevent the free passage of smoke; and
 - (E) be smoke sealed with intumescent putty or other suitable material at any construction joint, space or the like between the top of the wall and the floor, ceiling or roof.
- (iv) *Loadbearing internal walls* must comply with the requirements of **Specification C1.1** and **paragraphs (iii)(B), (C), (D) and (E)** above.
- (v) Ancillary use areas containing equipment or materials that are a high potential *fire hazard*, must be separated from the *sole-occupancy-units* by smoke proof walls complying with **Specification C2.5**.
- (vi) The ancillary use areas referred to in (v) include, but are not limited to, the following:
- (A) A kitchen and related food preparation areas having a combined *floor area* of more than 30 m².
 - (B) A laundry, where items of equipment are of the type that are potential fire sources (e.g. gas fire dryers).
 - (C) Storage rooms greater than 10 m² used predominantly for the storage of administrative records.
- (vii) Openings in *fire walls* must be protected as follows:
- (A) Doorways — *self-closing* or *automatic* closing –/60/30 fire doors.
 - (B) Windows — *automatic* or permanently fixed closed –/60/– fire windows or –/60/– *automatic* fire shutters.
 - (C) Other openings — construction having an FRL not less than –/60/–.

PART C3 PROTECTION OF OPENINGS

Delete C3.11(d) and insert NSW C3.11(d) as follows:

NSW C3.11 Bounding construction: Class 2, 3, 4 and 9b buildings

- (d) Protection for a doorway *required* under (a), (b) or (c) must be at least—
- (i) in a building of Type A construction — a *self-closing* –/60/30 fire door; and

(ii) in a building of Type B or C construction — a *self-closing*, tight fitting, solid core door not less than 35 mm thick,

except—

(iii) in a Class 3 building used as a *residential aged care building* protected with a sprinkler system complying with **Specification E1.5**, a tight fitting solid core door not less than 35 mm thick that is—

(A) *self-closing*; or

(B) fitted with a free-arm action closing device which closes the door or causes the door to remain closed (without preventing manual re-opening), upon the detection of smoke by a detector located within the room.

Insert NSW C3.11(h) as follows:

(h) In a Class 9b building used as an *entertainment venue*, openings in construction *required* to separate one space from another must be protected in accordance with **C3.4**.

NSW Specification C1.10 FIRE HAZARD PROPERTIES

Delete Clause 7 and Table 4 and insert NSW Clause 7 and NSW Table 4

NSW 7. Other materials

Materials and assemblies in a Class 2 to 9 building not included in **Clauses 3, 4, 5 or 6** must not exceed the indices set out in **NSW Table 4**.

NSW Table 4 OTHER MATERIALS

Material or assembly location	Flammability Index	Spread-of-Flame Index	Smoke-Developed Index
Fire control rooms subject to Specification E1.8 and fire-isolated <i>exits</i> , other than a <i>sarking-type material</i> used in a ceiling or used as an attachment or part of an attachment to a building element. ^{Note 1}	—	0	2
Class 9b buildings used as an <i>entertainment venue</i> : ^{Note 4}			
(a) A material used to cover closed back upholstered seats in any part available to the public where—			
(i) smoking is permitted; or	—	6	5
(ii) flame is exposed in connection with the preparation of meals.	—	6	5
(b) A material used as a curtain, blind or similar decor in any part available to the public. ^{Note 5}	6	—	—
(c) A material used to form a cinematograph screen ^{Note 5 and 6}	12	0	7

NSW Table 4 OTHER MATERIALS— continued

Material or assembly location	Flammability Index	Spread-of-Flame Index	Smoke-Developed Index
Class 9b buildings used as a public hall or the like, a proscenium curtain <i>required</i> by Specification H1.3	—	0	3
Escalators, moving walkways or non- <i>required</i> non- <i>fire-isolated stairways</i> or pedestrian ramps subject to Specification D1.12 .	—	0	5
<i>Sarking-type material:</i>			
(a) In a fire control room subject to Specification E1.8 or a fire-isolated <i>exit</i> used in the form of an exposed wall or ceiling.	0	—	—
(b) In other locations. ^{Note 2}	5	—	—
Other materials or locations and insulation materials other than <i>sarking-type materials</i> . ^{Notes 2 and 3}	—	9	8 if the <i>Spread-of-Flame Index</i> is more than 5

Notes:

1. In a fire control room or *fire-isolated stairway*, a material used as an attachment or part of an attachment to a building element must, if *combustible*, be attached directly to a *non-combustible* substrate and not exceed 1 mm finished thickness.
2. A material, other than one located within a fire-isolated *exit* or fire control room, may be covered on all faces by concrete or masonry not less than 50 mm thick, as an alternative to meeting the specified indices.
3. In the case of a composite member or assembly, the member or assembly must be constructed so that when assembled as proposed in a building—
 - (a) any material which does not comply with this Table is protected on all sides and edges from exposure to the air; and
 - (b) the member or assembly, when tested in accordance with **Specification A2.4**, has a *Spread-of-Flame Index* and a *Smoke-Developed Index* not exceeding those prescribed in this Table; and
 - (c) the member or assembly retains the protection in position so that it prevents ignition of the material and continues to screen it from access to free air for a period of not less than 10 minutes.
4. Any fire-retardant coating used in an *entertainment venue* to make a material subject to (a), (b) or (c) comply with a *required Flammability Index*, *Spread-of-Flame Index* or *Smoke-Developed Index* must be certified by—
 - (a) its manufacturer or distributor—
 - (i) as approved for use with the fabric to achieve the *required* indices; and
 - (ii) to retain its retardancy effect after a minimum of 5 commercial dry cleaning or laundering operations carried out in accordance with AS 2001.5.4, Procedure 7A, using ECE reference detergent; and

NSW Table 4 OTHER MATERIALS— continued

Material or assembly location	Flammability Index	Spread-of-Flame Index	Smoke-Developed Index
<p>(b) the applicator as having been carried out in accordance with the manufacturer's specification.</p> <p>5. Materials subject to (b) or (c) must have a label affixed to a representative sample of each different material indicating, in legible characters—</p> <p>(a) name of manufacturer; and</p> <p>(b) trade name and description of material's composition; and</p> <p>(c) retardant treatment (if any), name of applicator and date of application; and</p> <p>(d) AS 1530 Part 2 and/or AS/NZS 1530 Part 3 test number and its <i>Flammability Index</i>, <i>Spread-of-Flame Index</i> and <i>Smoke-Developed Index</i>; and</p> <p>(e) approved methods of cleaning.</p> <p>6. A cinematograph screen must have a supporting frame of metal construction.</p>			

SECTION D ACCESS AND EGRESS

PART D1 PROVISION FOR ESCAPE

Add D1.2(d)(vii) as follows:

NSW D1.2 Number of exits required

- (d)
- (vii) any *storey* or *mezzanine* within an *auditorium* in an *entertainment venue*.

Insert NSW D1.6(f)(vi), and (j) as follows:

NSW D1.6 Dimensions of exits

- (f)
- (vi) in a Class 9b building used as an *entertainment venue*—
- (A) in parts of the building used by the public, the width of the *required exit* or path of travel, and the unobstructed width of each doorway must not be less than 1 m and not more than 3 m; and
- (B) in other parts of the building, doorways must comply with **D1.6(f)**.
- (j) in a Class 9b building used as an *entertainment venue*—
- (i) the aggregate width must be not less than 2 m plus 500 mm for every 50 persons or part in excess of 200; and
- (ii) **D1.6(b)**, **(c)** and **(d)** do not apply; and
- (iii) where one or more paths of travel merge, the width of the combined path of travel must be not less than the sum of the *required* widths of those paths of travel; and

- (iv) the *required* widths of the paths of travel connecting the *exits* from the building to a public road or *open space* must comply with (iii).

Delete D1.10(f) and insert NSW D1.10(f) as follows:

NSW D1.10 Discharge from exits

- (f) In a Class 9b building used as an *entertainment venue*, at least half of the *required* number of *exits* from each *storey* or *mezzanine*, and at least half of the aggregate width of such *exits* must discharge otherwise than through the main entrance, or the area immediately adjacent to the main entrance of the building.

Vary Table D1.13 as follows:

NSW Table D1.13 AREA PER PERSON ACCORDING TO USE

Type of use	m ² per person
Delete "Theatre and public hall" and insert the following:	
<i>Entertainment venue—</i>	
other than <i>auditorium</i>	1.2
<i>Auditorium—</i>	
standing area	0.5
removable seating	1.0
fixed seating	count seats
bench seating	450 mm/person

PART D2 CONSTRUCTION OF EXITS

Add NSW D2.1(c) as follows:

NSW D2.1 Application of Part

In addition—

- (c) in a Class 9b building used as an *entertainment venue—*
- (i) **Clauses NSW D2.13(a)(ix), (a)(x), and (a)(xi), NSW D2.15(d), NSW Table D2.16a 1(d), and NSW D2.19(b)(v)** apply to only those parts of the building used by the public; and
 - (ii) the general requirements of **Part D2** apply to all other parts of the building.

Insert NSW D2.13(a)(ix), (a)(x) and (a)(xi) as follows:

NSW D2.13 Treads and risers

- (a)
- (ix) conspicuous edges to the treads of steps in a Class 9b building used as an *entertainment venue*; and
 - (x) in a Class 9b building used as an *entertainment venue*, not more than one helical stairway serving as a *required exit* and that stairway must—
 - (A) have a width of not less than 1500 mm; and
 - (B) be of constant radius; and

- (C) be constructed so that each tread, when measured 500 mm in from its narrow end, has a width of at least 280 mm; and
- (xi) in a Class 9b building used as an *entertainment venue*, in a curved stairway serving as a *required exit*— an internal radius of not less than twice the width of the stair.

Renumber D2.15(d) to (e) and insert NSW D2.15(d) as follows:

NSW D2.15 Thresholds

- (d) in a Class 9b building used as an *entertainment venue*, the door sill of a doorway opening to a road, *open space*, external stair landing or external balcony is not more than 50 mm above the finished floor level to which the doorway opens; or
- (e) in other cases—
 - (i) the doorway opens to a road or *open space*, external stair landing or external balcony; and
 - (ii) the door sill is not more than 190 mm above the finished surface of the ground, balcony, or the like, to which the doorway opens.

Delete Table D2.16a 1 and substitute NSW Table D2.16a 1 as follows:

NSW D2.16 Barriers

NSW Table D2.16a BARRIER CONSTRUCTION

1. Barrier heights	
Location	Minimum height
(a) Stairways or ramps with a gradient of 1:20 or steeper.	865 mm
(b) Landings to a stair or ramp where the barrier is provided along the inside edge of the landing and does not exceed 500 mm in length.	
(c) In front of fixed seating on a <i>mezzanine</i> or balcony within an auditorium in a Class 9b building.	1 m; or 700 mm and a horizontal projection that extends not less than 1 m outwards from the top of the barrier; or in a Class 9b building used as an <i>entertainment venue</i> , the height prescribed for guardrails in NSW H101.14.2 and NSW H102.9 .
(d) In a Class 9b building used as an <i>entertainment venue</i> — (i) stairways or ramps; and (ii) the floor of any access path, balcony, landing or the like.	1 m when provided inside the building; and 1200 mm when provided externally to the building.
(e) In all other locations.	1 m.

NSW Table D2.16a BARRIER CONSTRUCTION— continued

Notes:

1. Heights are measured vertically from the surface beneath, except that for stairways the height must be measured above the nosing line of the stair treads.
2. A transition zone may be incorporated where the barrier height changes from 865 mm on a stair flight or ramp to 1 m at a landing or floor.

Insert NSW D2.19(b)(v) as follows:

NSW D2.19 Doorways and doors

(b)

- (v) in a Class 9b building used as an *entertainment venue*—
 - (A) must not be fitted with a collapsible gate, accordion door, turnstile or rigid barrier; and
 - (B) if fitted with a door, must be—
 - (aa) a swing door which opens in the direction of egress; and
 - (bb) doors hung in two folds where the unobstructed width of the doorway is more than 1 m; and
 - (C) a doorway or opening within sight of the audience but not intended for egress must have a notice displayed clearly indicating its purpose and such a notice must not be internally illuminated; and
 - (D) notwithstanding (b)(iii), a sliding door may be fitted where—
 - (aa) it leads directly to a road or *open space* and forms a main entrance; and
 - (bb) it is capable of swinging in the direction of egress when pressure is applied to the inside face of the door; and
 - (cc) the door is provided with signage that clearly indicates to persons seeking egress, the potential for swinging the door open in an emergency.

Delete D2.21(c) and insert NSW D2.21(c) and (d) as follows:

NSW D2.21 Operation of latch

- (c) The requirements of (a) do not apply in a Class 9b building (other than a *school*, an *early childhood centre* or a building used for religious purposes) to a door in a *required exit*, forming part of a *required exit* or in the path of travel to a *required exit* serving a *storey* or room accommodating more than 100 persons, determined in accordance with **D1.13**, in which case it must be readily openable—
 - (i) without a key from the side that faces a person seeking egress; and
 - (ii) by a single hand pushing action on a single device such as a panic bar located between 900 mm and 1.2 m from the floor; and
 - (iii) where a two-leaf door is fitted, the provisions of (i) and (ii) need only apply to one door leaf if the appropriate requirements of **D1.6** are satisfied by the opening of that one leaf; and

- (iv) where the door is a door in a path of travel providing re-entry to the building from a balcony, terrace or the like, it may be fitted with key-operated fastenings only, the tongues of which must be locked in the retracted position whenever the building is occupied by the public, so the door can yield to pressure.
- (d) The requirements of (a) and (c) do not apply to a door serving a Class 9b building used as an *entertainment venue* where the following provisions apply to a door or gate used by the public—
 - (i) on a door, the single device operating the latch or bolts must be a panic bar if those doors are to be secured; or
 - (ii) an *exit* door or gate used by the public as the main entrance may be fitted with key-operated fastenings only, the tongues of which must be locked in the retracted position whenever the building is occupied by the public so the door or gate can yield to pressure from within; or
 - (iii) a door from a balcony, terrace or the like, being a door in a path of travel providing re-entry to the building, may comply with the locking provision of (ii) above.

Add NSW D2.101 as follows:

NSW D2.101 Doors in path of travel in an entertainment venue

In a Class 9b building used as an *entertainment venue*, a doorway in a path of travel must comply with **NSW D2.19(b)(v)**.

SECTION E SERVICES AND EQUIPMENT

PART E1 FIRE FIGHTING EQUIPMENT

NSW EP1.4

Note:

NSW has requirements for fire sprinkler systems in certain residential aged care facilities. See the Department of Planning and Environment website www.planning.nsw.gov.au.

NSW Table E1.5

Note:

NSW has requirements for fire sprinkler systems in certain residential aged care facilities. See the Department of Planning and Environment website www.planning.nsw.gov.au.

PART E2 SMOKE HAZARD MANAGEMENT

NSW Table E2.2a General Provisions

BCA Table E2.2a is applicable in NSW except for subclause (a) of the "Large isolated buildings" provisions.

Delete Table E2.2b Class 9b Assembly buildings and substitute NSW Table E2.2b Class 9b buildings as follows:

NSW Table E2.2b SPECIFIC PROVISIONS

CLASS 6 BUILDINGS IN FIRE COMPARTMENTS MORE THAN 2000 m²:
The provisions of BCA Table E2.2b for Class 6 buildings are applicable in NSW.
CLASS 9b BUILDINGS
CLASS 9b ASSEMBLY BUILDINGS
The following provisions apply to all Class 9b <i>assembly buildings</i> :
(a) Automatic shutdown: A building or part of a building used as an <i>assembly building</i> must be provided with <i>automatic</i> shutdown of any air-handling system (other than non-ducted individual room units with a capacity not more than 1000 L/s and miscellaneous exhaust air systems installed in accordance with Sections 5 and 6 of AS/NZS 1668.1) which does not form part of the smoke hazard management system, on the activation of— (i) smoke detectors installed complying with Clause 5 of Specification E2.2a ; and (ii) any other installed fire detection and alarm system, including a sprinkler system complying with Specification E1.5 .
(b) Basements: A basement not counted in the <i>rise in storeys</i> in accordance with C1.2 , less than 2000 m ² used as an <i>assembly building</i> or part of an <i>assembly building</i> containing an <i>auditorium</i> or other public area, must be equipped with— (i) an <i>automatic</i> smoke detection system in accordance with Specification E2.2a ; or (ii) an <i>automatic</i> zone smoke control system in accordance with AS/NZS 1668.1 if the basement has more than one <i>fire compartment</i> ; or if the basement forms part of a multi <i>fire compartmented</i> building served by the zone smoke control system; or (iii) a sprinkler system complying with Specification E1.5 .

NSW Table E2.2b SPECIFIC PROVISIONS — continued

(c) Stages and backstages:

- (i) For the purposes of this Table, where a *stage* is separated from the *auditorium* by a proscenium wall incorporating a proscenium opening, a backstage room or area that is not separated from the *stage* by construction having an FRL of not less than 60/60/60, is taken to form part of the *stage*.
- (ii) A building or part of a building used as an *assembly building* which has a *stage*—
 - (A) with a *floor area* of more than 50 m² and not more than 150 m² must, over the *stage*, be provided with—
 - (aa) an *automatic* smoke exhaust system complying with **Specification E2.2b** (including **Figure 2**); or
 - (bb) roof mounted *automatic smoke-and-heat vents* complying with **NSW H101.22**, in a single *storey* building or the top *storey* of a multi *storey* building; or
 - (B) with a *floor area* of more than 150 m² must, over the *stage*, be provided with an *automatic* smoke exhaust system complying with **Specification E2.2b** (including **Figure 2**); or
 - (C) equipped with means of *flying scenery* must, over the *stage*, be provided with an *automatic* smoke exhaust system complying with **Specification E2.2b** (including **Figure 2**).

NIGHT CLUBS, DISCOTHEQUES, AND THE LIKE

A building or part of a building being a night club, discotheque or the like, must be provided with—

- (a) in an auditorium—
 - (i) an *automatic* smoke exhaust system complying with **Specification E2.2b**; or
 - (ii) roof mounted *automatic smoke-and-heat vents* complying with **Specification E2.2c**, in a single *storey* building or the top *storey* of a multi *storey* building; or
 - (iii) a sprinkler system complying with **Specification E1.5** with fast response sprinkler heads; and
- (b) in all other areas—
 - (i) where a building or part of a building has a *floor area* not more than 2000 m²—
 - (A) one of the smoke hazard management measures listed under (a) above; or
 - (B) an *automatic* smoke detection and alarm system complying with **Specification E2.2a**; or
 - (ii) where a building or part of a building has a *floor area* of more than 2000 m², smoke hazard management measures as provided for under 'Other Assembly Buildings' in **NSW Table E2.2b**.

Note: Paragraph (a) applies only to an auditorium designed principally to accommodate an audience to an entertainment.

NSW Table E2.2b SPECIFIC PROVISIONS — continued

EXHIBITION HALLS, MUSEUMS AND ART GALLERIES

A building or part of a building used as an exhibition hall, museum, art gallery or the like, must be provided with—

- (a) where the *floor area* is more than 2000 m² and not more than 3500 m²—
 - (i) an *automatic* smoke exhaust system complying with **Specification E2.2b**; or
 - (ii) roof mounted *automatic smoke-and-heat vents* complying with **Specification E2.2c** in a single *storey* building or the top *storey* of a multi *storey* building; or
 - (iii) a sprinkler system complying with **Specification E1.5**; and
- (b) where the *floor area* is more than 3500 m², a sprinkler system complying with **Specification E1.5** and—
 - (i) an *automatic* smoke exhaust system complying with **Specification E2.2b**; or
 - (ii) roof mounted *automatic smoke-and-heat vents* complying with **Specification E2.2c**, in a single *storey* building or the top *storey* of a multi *storey* building.

OTHER ASSEMBLY BUILDINGS

- (a) Unless otherwise described in (b), in a building or part of a building used as an *assembly building* (not being a night club, discotheque or the like; or an exhibition hall, museum or art gallery) where the *floor area* of a *fire compartment* is more than 2000 m², the *fire compartment* must be provided with—
 - (i) an *automatic* smoke exhaust system complying with **Specification E2.2b**; or
 - (ii) roof mounted *automatic smoke-and-heat vents* complying with **Specification E2.2c**, in a single *storey* building or the top *storey* of a multi *storey* building; or
 - (iii) if the *floor area* of the *fire compartment* is not more than 5000 m² and the building has a *rise in storeys* of not more than 2—
 - (A) an *automatic* smoke detection and alarm system complying with **Specification E2.2a**; or
 - (B) a sprinkler system complying with **Specification E1.5**.
- (b) The following buildings are exempt from the provisions of (a):
 - (i) Sporting complexes, (including sports halls, gymnasiums, *swimming pools*, ice and roller rinks, and the like) other than indoor sports stadiums with total spectator seating for more than 1000 persons.
 - (ii) Churches and other places used solely for religious worship.
 - (iii) *School* classrooms.

Note: Smoke hazard management provisions for an *assembly building* used for multiple purposes must comply with all the relevant provisions of **NSW Table E2.2b** according to usage.

NSW Specification E2.2a SMOKE DETECTORS AND ALARM SYSTEMS

Delete Clause 7(e) as follows:

7. System Monitoring

(e) (deleted)

PART E4 EMERGENCY LIGHTING, EXIT SIGNS AND WARNING SYSTEMS

Delete E4.6 and insert NSW E4.6 as follows:

NSW E4.6 Direction signs

If an *exit* is not readily apparent to persons occupying or visiting the building, then *exit* signs must be installed—

- (a) in appropriate positions in corridors, hallways, lobbies, foyers, auditoria, and the like, indicating the direction to a *required exit*; and
- (b) in a Class 9b building used as an *entertainment venue* — in any external egress path to a road where the *exit* does not open directly onto a road.

SECTION F HEALTH AND AMENITY

PART F2 SANITARY AND OTHER FACILITIES

Delete FP2.6 (and Limitation) and replace with NSW FP2.6:

PERFORMANCE REQUIREMENTS

NSW FP2.6

(deleted).

Note.

This Performance Requirement is deleted from the BCA in NSW, as the installation of hot water, warm water and cooling water systems (and their operation and maintenance) is regulated in the Public Health Regulation, 2012, under the Public Health Act, 2010.
--

Delete F2.7:

DEEMED-TO-SATISFY PROVISIONS

NSW F2.7 Microbial (legionella) control

(deleted).

Note.

This clause is deleted from the BCA in NSW, as the installation of hot water, warm water and cooling water systems (and their operation and maintenance) is regulated in the Public Health Regulation, 2012, under the Public Health Act, 2010.

PART F4 LIGHT AND VENTILATION

Delete F4.5(b) and insert NSW F4.5(b) as follows:

NSW F4.5 Ventilation of rooms

(b) a mechanical ventilation or air-conditioning system complying with AS 1668.2.

Note.

The reference to AS/NZS 3666.1 is deleted from the BCA in NSW, as the need to comply with this standard is regulated in the Public Health Regulation, 2012, under the Public Health Act, 2010.

SECTION G ANCILLARY PROVISIONS

PART G1 MINOR STRUCTURES AND COMPONENTS

Delete GP1.2(a) and insert NSW GP1.2(a) as follows:

PERFORMANCE REQUIREMENTS

NSW GP1.2

- (a) A barrier must be provided to a *swimming pool* and must—
- (i) be continuous for the full extent of the hazard; and
 - (ii) be of a strength and rigidity to withstand the foreseeable impact of people; and
 - (iii) restrict the access of young children to the pool and the immediate pool surrounds; and
 - (iv) have any gates and doors fitted with latching devices not readily operated by young children, and constructed to automatically close and latch.

Application:

NSW GP1.2(a) only applies to a *swimming pool* with a depth of water of more than 300 mm, in conjunction with the Swimming Pools Act 1992 and the Swimming Pools Regulation 2008.

Delete G1.1(a) and insert NSW G1.1(a) as follows:

DEEMED-TO-SATISFY PROVISIONS

NSW G1.1 Swimming pools

- (a) **G1.1(b)** applies to the technical construction requirements for barriers to restrict access to *swimming pools*, subject to out-of-ground pool walls and the walls of above ground pools, including inflatable pools, not being considered to be effective barriers.

Note:

The Swimming Pools Act 1992 and the Swimming Pools Regulation 2008, applicable to *swimming pools* with a depth of water of more than 300 mm, regulate the circumstances in which a barrier is required and prevail in the case of any inconsistency.

Add NSW G1.101 as follows:

NSW G1.101 Provision for cleaning windows

- (a) A building must provide for a safe manner of cleaning any *windows* located 3 or more *storeys* above ground level.
- (b) A building satisfies (a) where—
- the *windows* can be cleaned wholly from within the building; or
 - provision is made for the cleaning of the *windows* by a method complying with the Work Health and Safety Act 2011 and regulations made under that Act.

PART G5 CONSTRUCTION IN BUSHFIRE PRONE AREAS

Delete GP5.1 and insert NSW GP5.1 as follows:

PERFORMANCE REQUIREMENTS

NSW GP5.1

A building that is constructed in a *designated bushfire prone area* must, to the degree necessary, be designed and constructed to reduce the risk of ignition from a bushfire appropriate to the—

- potential for ignition caused by burning embers, radiant heat or flame generated by a bushfire; and
- intensity of the bushfire attack on the building.

Application:

NSW GP5.1 only applies in a *designated bushfire prone area*, to—

- (a) a Class 2 or 3 building;
- (b) a Class 4 part of a building;
- (c) a Class 9 building that is a *special fire protection purpose*; or
- (d) a Class 10a building or deck associated with a building or part referred to in (a), (b) or (c).

Delete G5.2 and insert NSW G5.2 as follows:

DEEMED-TO-SATISFY PROVISIONS

NSW G5.2 Protection

In a *designated bushfire prone area*, a Class 2 building, a Class 3 building, a Class 4 part of a building or a Class 9 building that is a *special fire protection purpose* or a Class 10a building or deck associated with such a building or part, must comply with the following—

- (a) AS 3959 except for Section 9 Construction for Bushfire Attack Level FZ (BAL-FZ). Buildings subject to BAL-FZ must comply with specific conditions of development consent for construction at this level; or
- (b) the requirements of (a) above as modified by the development consent following consultation with the NSW Rural Fire Service under section 79BA of the Environmental Planning and Assessment Act 1979; or
- (c) the requirements of (a) above as modified by development consent with a bushfire safety authority issued under section 100B of the Rural Fires Act 1997 for the purposes of integrated development.

SECTION H SPECIAL USE BUILDINGS

PART H1 CLASS 9b BUILDINGS

Delete H1.1 and insert NSW H1.1 as follows:

NSW H1.1 Application of Part

- (a) For a Class 9b building or part of a building that is not an *entertainment venue*—
 - (i) The *Deemed-to-Satisfy Provisions* of Part H1 apply to every enclosed Class 9b building or part of a building which—
 - (A) is a *school* assembly, church or community hall with a *stage* and any *backstage* area with a total *floor area* of more than 300m²; or
 - (B) otherwise, has a *stage* and any *backstage* area with a total *floor area* of more than 200m²; or
 - (C) has a *stage* with an associated rigging loft.

- (ii) Notwithstanding (a)(i)—
 - (A) **H1.4** applies to every open or enclosed Class 9b building; and
 - (B) **H1.7** applies to every enclosed Class 9b building.
- (b) For a Class 9b building that is an *entertainment venue*, **NSW Part H101**, as follows, applies in replacement of Part H1:

NSW PART H101 ENTERTAINMENT VENUES OTHER THAN TEMPORARY STRUCTURES AND DRIVE-IN THEATRES

Note.

NSW Part H101 contains *Deemed-to-Satisfy Provisions* additional to those contained in **Sections C, D, E, F** and **G** for buildings containing or used as *entertainment venues* other than temporary structures and drive-in theatres.

NSW H101.1 Application of Part

This Part applies to every *entertainment venue* as described in the Environmental Planning and Assessment Regulation 2000.

NSW H101.2 Fire separation

If an *entertainment venue* forms part only of a building, then—

- (a) the whole of the *entertainment venue*; or
- (b) the part containing the *stage, backstage* area and *auditorium*,

must be separated from the other parts of the building by construction having an FRL of not less than 60/60/60.

NSW H101.3 Foyer space

Where an *entertainment venue* is used principally for the purpose of—

- (a) exhibiting *films*; or
- (b) conducting live *stage* productions,

foyer space (excluding stairways and concession areas) must be provided on the basis of at least 0.25 m² for each person that the *auditorium* accommodates.

NSW H101.4 Sprinkler systems for common foyers

In an *entertainment venue*, where multiple *auditoriums* have a foyer in common, the following applies—

- (a) If the foyer serves not more than 2 *auditoriums*; that foyer must be separated from any adjoining foyer by construction having an FRL of not less than 60/60/60.
- (b) If the foyer serves more than 2 *auditoriums*, a sprinkler system complying with **Specification E1.5** must be installed—

- (i) throughout the *storey* containing the foyer; and
- (ii) throughout each *storey* in the building below that *storey*.

NSW H101.5 Conventional stages

This clause applies to a conventional *stage*, that is, a *stage* which is separated from the *auditorium* by a proscenium wall incorporating a proscenium opening.

NSW H101.5.1 Extent of stage area

If a room or area is not separated from the remainder of a conventional *stage* by construction having an FRL of not less than 60/60/60, the room or area is, for the purposes of this Part, to be taken to form part of the *stage*.

NSW H101.5.2 Small stages

A *stage* which is more than 50 m² but not more than 150 m² in area must have 2 or more means of egress from the *stage* and *backstage* area provided otherwise than through the proscenium wall.

NSW H101.5.3 Large stages

A *stage* which is more than 150 m² in area—

- (a) must have installed directly above the *stage* a suitable sprinkler system complying with **Specification E1.5**; and
- (b) must have the proscenium opening protected by a safety curtain that complies with **NSW H101.10**; and
- (c) must have a line of open drenchers or open sprinklers provided above the proscenium opening on the *stage* side and in such a position as to be able to discharge over the inside face of the safety curtain; and
- (d) must have 2 or more means of egress from the *stage* and *backstage* area provided otherwise than through the proscenium wall.

NSW H101.5.4 Fire separation of stages

A *stage* which is more than 50 m² in area, and all areas below such a *stage*, must (with the exception of the proscenium opening) be separated from the *backstage* and the remainder of the building by construction having an FRL of not less than 60/60/60.

NSW H101.6 Non-conventional stages

This clause applies to a *stage* that is not a conventional *stage* within the meaning of **NSW H101.5**.

NSW H101.6.1 Small stages

A *stage* which is more than 50 m² but not more than 150 m² in area must have at least 2 means of egress from the *backstage* area.

NSW H101.6.2 Large stages

A *stage* which is more than 150 m² in area must have at least 2 means of egress from the *backstage* area.

NSW H101.7 Flying scenery

Where there is a *grid* or other means of *flying scenery* over—

- (a) a conventional *stage* or non-conventional *stage*—
 - (i) the *stage* must be provided with a sprinkler system complying with **Specification E1.5**; and
 - (ii) a fly gallery, bridge *grid*, rigging loft, tie gallery or electric light perch must—
 - (A) comply with AS 1657; and
 - (B) be of *non-combustible* construction;
 - (iii) a fly gallery must be provided with at least 2 means of egress, one on each side of the *stage*;
 - (iv) a *grid* or rigging loft must be provided with at least 2 means of egress;
 - (v) if exposed steel is used in the construction of a roof, fly or tie gallery, the roof, fly or tie gallery must be so designed that, in the event of its structural failure due to fire, the wall structure of the building will not be affected.
 - (vi) structural steel supporting the *stage* tower must be enclosed by masonry or concrete and have an FRL of not less than 120/120/120; and
- (b) in the case of a conventional *stage*, the following additional requirements apply:
 - (i) The proscenium wall must—
 - (A) have an FRL of not less than 120/120/120; and
 - (B) have the proscenium opening protected by a rigid safety curtain in accordance with **NSW H101.10.1**;
 - (ii) the walls forming the *stage* area, and the area beneath the *stage*, must be constructed of masonry or concrete and have an FRL of not less than 120/120/120.

NSW H101.8 Load notice

A notice indicating the actual distributed and concentrated load for which the *stage* floor has been designed must be conspicuously and permanently displayed in a position adjacent to the *stage* floor.

This notice must be in legible letters and figures—

- (a) at least 50 mm high; and
- (b) on a contrasting background.

NSW H101.9 * * * * *

This clause has been deliberately left blank.

NSW H101.10 Safety curtains

A safety curtain *required* by **NSW H101.5.3** must—

- (a) be made of *non-combustible* material; and
- (b) be so fitted that, when it is closed, it forms an efficient smoke seal between the *stage* and the *auditorium*; and
- (c) be capable of withstanding a pressure differential of 0.5 kPa over its entire surface area; and
- (d) be run on steel guides located on each side of the proscenium opening; and
- (e) remain engaged in its guides if the guides, together with their fittings and attachments and that part of the curtain engaged in the guides, are subjected to a pressure differential of 1 kPa; and
- (f) be of sufficiently robust construction to withstand damage by scenery, *stage* properties and falling debris; and
- (g) be capable of closing the proscenium opening within 30 seconds, either by gravity slide or by motor assisted mechanisms; and
- (h) have manual controls, located on each side of the *stage*, for the closing of the curtains; and
- (i) have a notice displayed adjacent to the operating controls, in clear and legible letters and symbols of adequate size, indicating its use and operation; and
- (j) when operated, actuate a distinctive warning alarm audible to persons on the *stage* and must not be reliant for its operation solely on the primary electricity supply; and
- (k) have the words “Safety Curtain” exhibited on the curtain in clear and legible letters of adequate size to enable them to be read from all parts of the *auditorium*.

NSW H101.10.1 Safety curtains—Additional requirements

A rigid safety curtain *required* by **NSW H101.7** must comply with the requirements of **NSW H101.10** and it must—

- (a) be vertically hung from steel cables;
- (b) be framed with structural steel that complies with AS 4100;
- (c) be sheeted and finished on both faces with sheet steel or other *non-combustible* material of such gauge, and so fastened to its frame, as to ensure that its frame is capable of withstanding distortion arising from heat; and
- (d) when closed, overlap the proscenium opening by not less than 300 mm at each side and by not less than 600 mm at the top.

NSW H101.11 Seating in rows

This clause does not apply to *continental seating* or seating at tables.

NSW H101.11.1 Number of seats

Subject to **NSW H101.11.5**, where seating is arranged in *rows*, the maximum of seats in each *row* must not exceed—

- (a) 8 where there is an *aisle* at one end only of the *row*; or

- (b) 16 where there are *aisles* on both ends of the *row*.

NSW H101.11.2 Chairs used for seating

Chairs used for seating must—

- (a) where they have arms, be at least 500 mm from centre to centre; and
- (b) where they do not have arms, be at least 450 mm from centre to centre; and
- (c) have a *minimum lateral clearance* of at least 300 mm between—
 - (i) the front of each chair and the back of the chair in front; or
 - (ii) if a guardrail is provided in front of the chairs, between the front of each chair and the guardrail; and
- (d) have a distance of at least 950 mm between the back of each chair and the back of the chair in front.

NSW H101.11.3 Chairs in auditoriums—Level floors

Chairs in an *auditorium* that has a level floor must be—

- (a) securely fastened to the floor; or
- (b) secured together in groups of not less than 4 and not more than 16.

NSW H101.11.4 Chairs in auditoriums—Sloping floors

Chairs in an *auditorium* having a sloping floor, or having stepped or inclined platforms, must be securely fastened to the floor or platform.

NSW H101.11.5 Radiating aisles in seating areas

Where seating is securely fastened to the floor and arranged in *rows* of concentric circles, semi-circles or segments of circles, with radiating *aisles*—

- (a) the number of seats in each row between 2 *aisles* must not exceed 24; and
- (b) each seat must—
 - (i) have a *minimum lateral clearance* of at least 325 mm between the front of the seat and the back of the seat in front; and
 - (ii) have a distance of at least 975 mm between the back of the seat and the back of the seat in front; and
- (c) the *rows* may be curved or straight.

NSW H101.11.6 Aisles and cross-overs

Where *aisles* and *cross-overs* are provided—

- (a) each *aisle* must have a width of at least 1000 mm and each *cross-over* must have a width of at least 1500 mm; and
- (b) the floor of each *aisle* must not have a grade of more than 1 in 8 at any part; and
- (c) if there is a step from a *row* to an *aisle* or from a landing to an *aisle*, the step must not project into the *aisle*.

NSW H101.11.7 Platforms and steps

Where an *aisle* contains platforms or steps—

- (a) the platforms and steps must extend for the full width of the *aisle*; and
- (b) if there are no intervening steps between levels of platforms, the height of the platform riser must not be more than 200 mm; and
- (c) if there are one or more intervening steps between levels of platforms—
 - (i) each riser must be at least 100 mm but not more than 200 mm high; and
 - (ii) each going must be at least 250 mm deep; and
 - (iii) risers and goings must be uniform; and
- (d) goings which are more than 450 mm deep at platform level must not have a grade of more than 1 in 50; and
- (e) at the entrance from the *aisle* to each *row* there must be a clear level floor space, extending the full width of the *aisle*, of at least 300 mm, measured from the back of the *row* in front; and
- (f) any going projecting in front of a seat adjacent to an *aisle* must be protected by a guardrail.

NSW H101.11.8 Stepped platforms

Where stepped platforms without chairs or stepped platforms with bench seats, are used for seating—

- (a) each platform must be at least 700 mm deep; and
- (b) each seating space must be at least 450 mm wide, measured along the front of the platform or bench seat; and
- (c) each seating space must be numbered consecutively; and
- (d) at the entrance from the *aisle* to each *row* there must be a clear level floor space, extending the full width of the *aisle*, of at least 300 mm, measured from the back of the *row* in front; and
- (e) any going projecting in front of a seat adjacent to an *aisle* must be protected by a guardrail; and
- (f) in the case of stepped platforms with bench seats, there must be at least 300 mm between the back of each seat and the front of the platform behind, or the front of the bench seat behind, whichever is the closer.

NSW H101.12 Continental seating

This Clause applies to *continental seating*.

NSW H101.12.1 Seating to be fastened

Seating must be securely fastened to the floor.

NSW H101.12.2 Maximum seats per row

The number of seats in a *row* must not exceed 120.

NSW H101.12.3 Depths of seating rows

The depth of each *row* of seating (that is, the distance between the back of the *row* in front or, if there is a guardrail in front, between the back of the *row* and the guardrail) must, in respect of a *row* containing a number of seats specified in Column 1 of [Table H101.12](#) be not less than the distance specified in Column 2 of that Table in respect of that number of seats.

NSW H101.12.4 Clearance between rows

The *minimum lateral clearance* between each *row* of seating must, in respect of a *row* containing a number of seats specified in Column 1 of [Table H101.12](#) be not less than the clearance specified in Column 3 of that Table in respect of that number of seats.

NSW H101.12.5 Chairs used for seating

Chairs used for seating must comply with [NSW H101.11.2\(a\)](#) and [\(b\)](#).

NSW H101.12.6 Egress Doorways

Egress doorways through the walls of the *auditorium*—

- (a) must have an aggregate width of at least twice the sum of the clearances specified in Column 3 of [Table H101.12](#) for each *row* of the *auditorium* to be served by those doorways; and
- (b) must be provided at each end of every fifth *row*, excluding the first 2 *rows* and the last 2 *rows* in the *auditorium* if those *rows* each contain no more than 16 seats; and
- (c) must lead—
 - (i) directly to a road or *open space*; or
 - (ii) into a foyer or other area giving access to a road or *open space*; and
- (d) must be provided with *exit* signs if the egress doorways are not sufficiently conspicuous.

NSW H101.12.7 Clear Areas

A clear area—

- (a) must be provided from each end of each *row* to an egress doorway in the wall of the *auditorium*; and
- (b) must have a width of at least—
 - (i) the sum of the clearances specified in Column 3 of [Table H101.12](#) for each such *row*; or
 - (ii) 500 mm, whichever is the greater; and
- (c) if it contains platforms or steps, must comply with [NSW H101.11.7\(a\)](#), [\(b\)](#), [\(c\)](#), [\(d\)](#) and [\(f\)](#).

NSW H101.12.8 Minimum clear space

At the entrance from a *row* to a clear area, there must be a clear level floor space having a width of at least the clearance specified for the *row* in Column 3 of [Table H101.12](#).

NSW H101.12.9 Doors

A door fitted to the egress doorway in the wall of an *auditorium* must comply with [NSW D2.15](#) and [NSW D2.19](#).

Table H101.12 SPACING OF AUDITORIUM SEATING

Column 1 Number of seats in <i>Rows</i>	Column 2 Depth of <i>Rows</i> (mm)	Column 3 Clearance between <i>Rows</i> (mm)
Not exceeding 16	950	300
17 - 30	975	325
31 - 45	1000	350
46 - 60	1025	375
61 - 75	1050	400
76 - 90	1075	425
91 - 105	1100	450
106 - 120	1125	475

NSW H101.13 Provision of guardrails

NSW H101.13.1 Location

Guardrails must be provided—

- (a) along the fascia of each balcony or box;
- (b) if there is a stepped floor, along the front edge of each *cross-over*; and
- (c) where [NSW H101.13.2](#) and [NSW H101.13.3](#) apply.

NSW H101.13.2 Fixed back seats

If seats with fixed backs are provided, guardrails that extend for the full width of the seating, must be provided at least 500 mm above the platform unless—

- (a) fixed seat backs of the next lower level project at least 500 mm above the level of the stepped platform; and
- (b) there is only one riser between the platform and the next lower *cross-over*.

NSW H101.13.3 Steps between platforms

If—

- (a) there is more than one intervening step in an *aisle* between levels of platforms, a guardrail must be provided (at a vertical height of at least 660 mm measured above the nosing of each tread and of the upper platform) to the sides of the *aisle* adjacent to those steps; and
- (b) there is more than one intervening step in an *aisle* between levels of platforms, and that *aisle* is along a wall, a continuous guardrail must be affixed to that wall at a height of at least 865 mm above the nosing of each tread; and

- (c) the end of a platform or the back of the highest platform does not abut a wall that extends at least 660 mm above the floor level of the platform, a guard rail not less than 660 mm high must be provided—
 - (i) at the ends of the platform, extending from the front of the first riser to the back of the highest platform; and
 - (ii) at the back of the highest platform, extending the full width of the platform; and
- (d) there is an inclined floor, the raised section of which is not bounded by walls at least 660 mm high, a guard rail must be provided that extends around the perimeter of the raised section at a height of at least 660 mm above the inclined floor level; and
- (e) seating at tables is provided on a stepped platform, a guardrail at least 500 mm high must be provided along the front edge of the platform.

NSW H101.14 Guardrails

This clause applies to seating areas.

NSW H101.14.1 Continental seating

Where a guardrail is provided in front of a *row* of chairs—

- (a) the distance between the back of each chair in that *row*, and the guardrail must be not less than the distance specified in Column 2 of [Table H101.12](#) for the number of chairs in that *row*;
- (b) the *minimum lateral clearance* between the front of each chair in that *row* and the guardrail must be not less than the clearance specified in Column 3 of [Table H101.12](#) for the number of chairs in that *row*.

NSW H101.14.2 Balconies and boxes

A guardrail provided along the fascia of a balcony or box—

- (a) if it is located at the foot of a stepped *aisle*, must have its top surface at least 900 mm above the floor of the balcony or box; and
- (b) if it is not located at the foot of a stepped *aisle*, must have its top surface at least 750 mm above the floor; and
- (c) if it has a ledge more than 70 mm wide, must have the top surface of the ledge sloping downwards towards the floor of the balcony or box at an angle of at least 30 degrees from the horizontal; and
- (d) must have an unperforated kerb or toe guard extending for at least 300 mm above the floor.

NSW H101.14.3 Cross-overs

A guardrail provided along the front edge of a cross-over on a stepped floor—

- (a) must be at least 750 mm high; and
- (b) must extend for the full distance between *aisles*, or between a wall and an *aisle*, or for such other distance as considered necessary.

NSW H101.15 Dressing rooms

A dressing room or 2 or more adjoining dressing rooms, having a total *floor area* of more than 50 m², must—

- (a) be separated from other parts of the building by construction having an FRL of not less than 60/60/60;
- (b) have at least 2 means of egress as remote from each other as possible, one of which must discharge—
 - (i) directly to a road or *open space*; or
 - (ii) through a fire-isolated *exit* to a road or *open space*.

NSW H101.16 Storerooms

A storeroom must be separated from other parts of the building by construction having an FRL of not less than 60/60/60.

NSW H101.17 Projection suites

- (a) This clause applies to *projection suites*.
- (b) A *projection suite* must be provided in an *entertainment venue* intended to be used for the showing of *films*.

NSW H101.17.1 Rooms to be provided

A *projection suite* in accordance with the staffing requirements of Schedule 3A of the Environmental Planning and Assessment Regulation 2000 must contain either—

- (a) a projection room and sanitary accommodation comprising at least 1 closet pan and 1 washbasin, where the *projection suite* is continually staffed; or
- (b) a projection room fitted with the following equipment—
 - (i) an *automatic* fire suppression system in accordance with SSL Appraisal Specification FAS 102 or a sprinkler system complying with AS 2118; and
 - (ii) a smoke detection system which will—
 - (A) comply with AS 1670.1 except for the provisions of Clause 3.28(f) - location where detectors not *required*; and
 - (B) be connected to a fire station or other approved monitoring service where arrangements are in place to initiate *fire brigade* response; and
 - (C) close down all shutters fitted to projection or observation ports; and
 - (D) activate sufficient general lighting to provide a minimum of 40 lux measured at floor level in any *auditorium* affected; and
 - (E) operate a public address system to automatically announce a suitable message from the management of the premises; and
 - (F) activate an audible alarm to immediately indicate to management the presence of smoke in the projection room.

NSW H101.17.2 Fire separation

A *projection suite* must be separated from all other internal parts of the building in which it is located by construction having an FRL of not less than 60/60/60.

NSW H101.17.3 Concession for protection of some openings

If a projection or observation port is not more than 0.1 m² in area—

- (a) a metal shutter not less than 1.5 mm thick may be fitted thereto instead of the protection *required* under **NSW C3.11**; and
- (b) any metal shutter or protection system provided must be equipped with a device to permit the closing of the shutter or protection system from easily accessible operating positions adjacent to each egress doorway from the projection room.

NSW H101.18 Basement storeys

Where an *entertainment venue* includes not more than 2 basement *storeys*—

- (a) all *required exits* from the basement must be enclosed in *non-combustible* construction, with the exception of the main entry or *exit*; and
- (b) any *auditorium* and other public areas in the basement must be equipped with an air-handling system that complies with AS 1668.2.

NSW H101.18.1 Basement storeys — More than two

If the *entertainment venue* includes more than 2 basement *storeys*—

- (a) the construction must be of at least Type B; and
- (b) all *required exits* from the basement must be enclosed in a *fire-resisting shaft* having an FRL as *required* by the relevant Type of construction; and
- (c) the building must be equipped with a sprinkler system complying with **Specification E1.5**.

NSW H101.19 Electric mains installation

NSW H101.19.1 Main switchboard

The switchboard containing the main isolation switch must—

- (a) be located in a position that is readily accessible to authorised persons, and to the *Fire Brigade* in the case of an emergency; and
- (b) be enclosed by construction having an FRL not less than 60/60/60.

NSW H101.19.2 Circuit protection

Protection of a final sub-circuit originating at a switchboard or distribution board must be by means of circuit breakers.

NSW H101.19.3 Separate sub-mains

Where an *entertainment venue* has its mains supply in common with that of another building or where it is a part of a building—

- (a) the *entertainment venue* must be served by a separate and independent sub-main from the main switchboard; and
- (b) each such sub-main, the consumer's main and the supply authority's conductors within the building must be protected against fire by means of—
 - (i) mineral-insulated metal-sheathed cables or other cables that provide at least 2 hours' fire protection; or
 - (ii) heavy-duty PVC conduit or metallic pipe, concrete encased in walls or slabs with a minimum of 50 mm cover; or
 - (iii) heavy-duty PVC conduit or metallic pipe, buried at least 500 mm below ground level, for underground cabling.

NSW H101.20 Lighting

NSW H101.20.1 Lighting switches

- (a) Any switch controlling the lighting system must not be accessible.
- (b) Where, during normal use, general lighting may be dimmed or switched off, an override switch to switch on all the general lighting instantaneously must be installed in the *auditorium* in a position accessible to management.

NSW H101.20.2 Lighting levels

Where the lamps utilised in the general lighting are of a type that will not relight immediately after the restoration of the primary electricity supply to those lamps—

- (a) a time delay or other suitable means must be provided to maintain the emergency lighting for a period not less than that necessary to allow the general lighting lamps to restrike; or
- (b) lamps of a type that will provide immediate lighting must be installed and—
 - (i) arranged in such a manner as to ensure visual conditions not inferior to those *required* to be provided by the emergency lighting; and
 - (ii) capable of being switched in common with the general lighting and of being controlled also by the override switch *required* by **NSW H101.20.1(b)**.

NSW H101.20.3 Provision of aisle lighting

Where general lighting is to be either dimmed or extinguished when the public is in attendance and where the floor is stepped or at an inclination greater than 1 in 12, *aisle* lights must be provided to illuminate the length of each *aisle* and the tread of each step therein.

NSW H101.20.4 Aisle lighting power supply

Where an *aisle* light is installed in a seat frame, it must be supplied at a voltage of not more than 32 volts AC or 115 volts DC.

NSW H101.20.5 Aisle lighting alternative power supply

Aisle lighting must be provided with an alternative electricity supply that—

- (a) is capable of being *automatically* energised in the event of failure of the primary lighting electricity supply; and

- (b) complies with the provisions applying to emergency lighting.

NSW H101.21 * * * * *

This clause has deliberately been left blank.

NSW H101.22 Automatic smoke-and-heat vents for stages

An automatic *smoke-and-heat vent* system *required* by **NSW Table E2.2b** “*Stages and backstage*” must—

- (a) be capable of *automatic* operation by the inclusion of a heat sensing device designed to activate the system at a temperature of not more than 71°C; and
- (b) be capable of being released manually from positions at each side of the *stage* and of being fully activated from either position; and
- (c) have a notice, prominently displayed at each position referred to in **(b)**, clearly indicating the method of activation; and
- (d) have an openable area of not less than 1/10 of the total area of the *stage*.

NSW H101.23 Solid fuel burning stoves and open fire places.

Solid fuel burning stoves and open fire places must not be installed in premises designed for the purpose of—

- (a) exhibiting *films*; or
- (b) conducting live theatre productions.

NSW H101.24 Fuel gas cylinders

NSW H101.24.1 General

Fuel gas cylinders must—

- (a) be housed in an enclosure that is located outside the building; and
- (b) comply with the ventilation requirements of AS/NZS 1596.

NSW H101.24.2 Fuel gas cylinder enclosures

An enclosure referred to in **NSW H101.24.1**—

- (a) must be located not less than 3 m from any *window*, door, vent or other opening; and
- (b) if located 3 m or more from a building must—
 - (i) have a concrete base; and
 - (ii) be constructed from heavy-gauge chain-wire mesh or other suitable material; and
 - (iii) be at least 1.8 m high; and
 - (iv) be so designed as to securely contain the fuel gas cylinders in a single line; and
 - (v) must be so designed as to allow cross ventilation; and
- (c) if located less than 3 m from a building must—
 - (i) have a concrete base; and

- (ii) have 3 sides constructed from concrete or masonry; and
- (iii) have a concrete roof; and
- (iv) be so designed as to securely contain the fuel gas cylinders in a single line; and
- (v) have a hinged, heavy-gauge chain-wire door capable of being secured against unauthorised entry; and
- (vi) have its roof at least 600 mm above the uppermost fitting on any fuel gas cylinder housed therein.

NSW PART H102 TEMPORARY STRUCTURES

NSW H102.1 Application of Part

This Part applies to *temporary structures* used as *entertainment venues*.

NSW H102.2 Exits—Exclusions

In this clause, a reference to an entrance or *exit* does not include a reference to an entrance or *exit* provided for persons or animals performing in a *temporary structure*.

NSW H102.3 Location of exits

Exits must be so provided and arranged as to afford a ready means of egress from all parts of a *temporary structure*.

NSW H102.4 Exits to be provided

Without limiting the generality of **NSW H102.3**—

- (a) the number of *exits* to be provided for a *temporary structure* designed to accommodate a number of persons specified in Column 1 of **Table H102.4** must be not less than the number of *exits* specified in Column 2 of that Table in respect of that number of persons; and
- (b) the aggregate width of the *exits* to a *temporary structure* designed to accommodate a number of persons specified in Column 1 of **Table H102.4** must not be less than the width specified in Column 3 of that Table in respect of that number of persons.

NSW H102.5 Vertical clearances for exits

Every part of an entrance or *exit* must provide a minimum unobstructed height of 2000 mm and, where the entrance or *exit* is beneath a stepped seating platform, infilled risers or other approved overhead protection must be provided above the entrance or *exit*.

NSW H102.6 Curtains across exits

A flap or curtain used to cover an *exit* must be so designed that, when it is secured, it will not obstruct or impede egress.

NSW H102.7 Curtains and blinds

Curtains and blinds for use in a *temporary structure* must comply with **Table 4 of NSW Specification C1.10**.

Table H102.4 NUMBER OF EXITS AND WIDTHS

Column 1 Accommodation provided	Column 2 Number of <i>exits required</i>	Column 3 Aggregate width of <i>exits</i>
1-25 persons	*1-2	1 000
26-50 persons	2	1 500
51-75 persons	2	2 000
76-100 persons	2	2 500
100-200 persons	2	3 000
201-400 persons	3	4 500
401-600 persons	4	6 000
601-800 persons	5	7 500
801-1000 persons	5	9 000
over 1000 persons	5 plus one additional <i>exit</i> for each additional 450 persons or part thereof.	9 000 plus 500 mm for each additional 50 persons or part thereof.
*Note:	(a) Where only one <i>exit</i> is provided that <i>exit</i> must be at least 1000 mm wide.	
	(b) Where 2 <i>exits</i> are provided each must be at least 500 mm wide.	

NSW H102.8 Fabrics

Fabric that is used in the construction of a *temporary structure* must have—

- (a) a *Flammability Index* of not more than 6 where used—
 - (i) within a height of 4 m of the base of the *temporary structure*; or
 - (ii) in an air-supported *temporary structure* without other supporting framework; and
- (b) a *Flammability Index* of not more than 25 in every other case.

NSW H102.9 Guardrails

A rigid guardrail must—

- (a) be provided at each end of a stepped or inclined platform, at least 750 mm high above the floor of the platform, and must extend—
 - (i) in the case of a stepped platform, from the front of the first riser; and
 - (ii) in the case of an inclined platform, from the front of the first *row* of seating, to the back of the highest platform and along the rear of that platform for its full width; and
- (b) not obstruct any *aisle*, *cross-over* or *exit*.

NSW H102.10 Seating

Seating must be provided in accordance with [NSW H101.11.1](#), [NSW H101.11.2](#), [NSW H101.11.3\(b\)](#), [NSW H101.11.5\(a\)](#), (c), [NSW H101.11.6\(a\)](#) and [NSW H101.11.8\(a\)](#), (b), (c) and (d).

NSW H102.11 Sanitary accommodation

Suitable sanitary accommodation must be provided at a location convenient to the *temporary structure*.

NSW H102.12 Projection suites

Any *projection suite* must comply with [NSW H101.17.2](#) and [NSW H101.17.3](#).

NSW H102.13 Fireplaces and heating

No fireplace or other form of heating equipment may be installed in a *temporary structure*, without the consent of the approval authority.

NSW H102.14 Electrical services

Electrical services connected to the local supply authority's mains, to a generating plant or to a battery supply must comply with—

- (a) the requirements of the local supply authority; and
- (b) AS 3002; and
- (c) where applicable, AS/NZS 3000; and
- (d) [NSW H101.19.1\(a\)](#) and [NSW H101.19.3\(a\)](#).

NSW H102.15 Artificial lighting

Artificial lighting must be provided, and must comply with [NSW H101.20.1](#) and [NSW H101.20.2](#).

NSW H102.15.1 Emergency lighting levels

Emergency lighting must be provided to the areas provided with artificial lighting under [NSW H102.15](#) and must include a sufficient number of lamps to give a minimum illumination of 0.2 lux at floor level.

NSW H102.15.2 Emergency lighting power supply

Where emergency lighting is provided, the capacity of the battery and charging system must be sufficient to provide the illumination *required* by [NSW H102.15.1](#) for—

- (a) half an hour, in respect of a *temporary structure* designed to accommodate not more than 1000 persons; and
- (b) 1 hour, in respect of a *temporary structure* designed to accommodate more than 1000 persons.

NSW H102.16 Exit signs

Exit signs must be provided above all *exits* and in such other locations as may be *required* by **NSW E4.6** and must comply with **E4.5** and **E4.8**.

NSW H102.17 Fire-fighting services

- (a) Fire-fighting services and appliances must be so provided as to afford adequate protection and must be so located as the approving authority, on the advice of the Director-General of New South Wales Fire Brigades, may require.
- (b) Where *required* by the approving authority, the fire-fighting services and appliances must comply with **Part E1**.

NSW PART H103 DRIVE-IN THEATRES

NSW H103.1 Application of Part

This Part applies to drive-in theatres.

NSW H103.2 Speaker standards

Speaker standards must—

- (a) be placed at a minimum of 5.5 m centres in a line along each parking ramp; and
- (b) be capable of being illuminated throughout any performance so as to be easily distinguishable at all times.

NSW H103.2.1 Lines of speaker standards

Lines of speaker standards along parking ramps must be placed at a distance of not less than 12.2 m apart.

NSW H103.3 Electrical services

The following electrical services must be installed underground—

- (a) the supply authority's conductors within the site and the consumer's mains, unless otherwise approved; and
- (b) electrical wiring external to any building on the site; and
- (c) all wiring to the speaker standards.

NSW H103.4 Vehicular entrances

Each public vehicular entrance to or exit from the drive-in theatre must be capable of being fully illuminated by flood lights that are so placed and so focussed as not to interfere with the vision of the driver of any motor vehicle.

NSW H103.5 Lighting

- (a) Driveways — Entrance and exit driveways, and the perimeter of the holding area, must be capable of being continuously illuminated by lamps capable of producing a minimum illumination of 0.5 lux at ground level.

- (b) Ramp areas — The whole of the ramp area of a drive-in theatre must be capable of being floodlit by means of area flood lights to an illumination of at least 10 lux.

NSW SECTION J ENERGY EFFICIENCY

Replace Section J with NSW Section J as follows:

Note 1.

NSW Section J consists of two Subsections J(A) and J(B).

NSW Subsection J(A) Energy Efficiency - Class 2 buildings and Class 4 parts

This Subsection contains energy efficiency requirements for Class 2 buildings and Class 4 parts of buildings.

The need for separating these requirements from the requirements for Class 3 buildings arises because, in NSW, Class 2 buildings and Class 4 parts of buildings are subject to BASIX (the Building Sustainability Index), however Class 3 buildings are not.

BASIX is the web-based planning tool designed to assess the potential performance of certain residential buildings against a range of sustainability indices including thermal comfort and energy. Commitments made under BASIX become a condition of the relevant development consent or complying development certificate.

BASIX applies in NSW to all new Class 1 and 2 buildings, and Class 4 parts of buildings; and to alterations and additions to buildings of those classes where the work is subject to BASIX and also where an applicant elects to comply with BASIX.

The provisions of NSW Subsection J(A) are therefore designed to complement requirements that arise under BASIX and which are implemented via the development consent. Where BASIX is not applied to alterations and additions to Class 1 and 2 buildings, and Class 4 parts of buildings, these provisions will also complement council development controls that require energy efficiency measures to be incorporated as part of the alterations and additions.

NSW Subsection J(B) Energy Efficiency - Class 3 and Class 5 to 9 buildings

This subsection contains energy efficiency requirements for Class 3 and Class 5 to 9 buildings.

As Class 3 and Class 5 to 9 buildings are not subject to BASIX, NSW Subsection J(B) applies the provisions of the national Section J relevant to Class 3 and Class 5 to 9 buildings, with minor variations.

Note 2.

All definitions in Part A1 that are applicable to the national Section J are also applicable to NSW Section J.

NSW SUBSECTION J(A) ENERGY EFFICIENCY - CLASS 2 BUILDINGS AND CLASS 4 PARTS

PERFORMANCE REQUIREMENTS

NSW J(A)P1

- (a) Thermal insulation in a building must be installed in a manner and have characteristics, which facilitate the efficient use of energy for artificial heating and cooling.
- (b) A building must have, to the degree necessary, thermal breaks installed between the framing and external cladding, to facilitate efficient thermal performance of the building envelope.

Application:

- (a) NSW J(A)P1(a) only applies to thermal insulation in a Class 2 building or Class 4 part of a building where a development consent specifies that the insulation is to be provided as part of the development.
- (b) In (a), the term development consent has the meaning given by the Environmental Planning and Assessment Act 1979.
- (c) NSW J(A)P1(b) only applies to a metal framed roof and a metal framed wall.

NSW J(A)P2

A building must have, to the degree necessary, a level of building sealing against air leakage to facilitate the efficient use of energy for artificial heating and cooling appropriate to—

- (a) the function and use of the building; and
- (b) the internal environment; and
- (c) the geographic location of the building.

Application:

NSW J(A)P2 only applies to a Class 2 building or Class 4 part of a building, except—

- (a) a building in *climate zones* 2 and 5 where the only means of *air-conditioning* is by using an evaporative cooler; and
- (b) a permanent building opening in a space where a gas appliance is located, that is necessary for the safe operation of a gas appliance; and
- (c) parts that cannot be fully enclosed

NSW J(A)P3

A building's *services* must have features that, to the degree necessary, facilitate the efficient use of energy appropriate to—

- (a) the function and use of the *service*; and
- (b) the internal environment; and
- (c) the geographic location of the building; and
- (d) the energy source of the *service*.

Application:

NSW J(A)P3 only applies to a Class 2 building or Class 4 part of a building.

NSW PART J(A)1 BUILDING FABRIC

NSW J(A)1.0 Deemed-to-Satisfy Provisions

- (a) Where a *Deemed-to-Satisfy Solution* is proposed, *Performance Requirement NSW J(A)P1* is satisfied by complying with **NSW J(A)1.1** and **NSW J(A)1.2**.
- (b) Where a *Performance Solution* is proposed, the relevant *Performance Requirements* must be determined in accordance with **A0.7**.

NSW J(A)1.1 Application of Part

- (a) The *Deemed-to-Satisfy Provisions* only apply to thermal insulation in a Class 2 building or Class 4 part of a building where a development consent or complying development certificate specifies that the insulation is to be provided as part of the development.
- (b) In (a), development consent and complying development certificate, have the meaning given to these terms by the Environmental Planning and Assessment Act 1979.
- (c) The *Deemed-to-Satisfy* provisions of this Part for thermal breaks apply to all Class 2 buildings and Class 4 parts.

NSW J(A)1.2 Compliance with BCA provisions

The *sole-occupancy units* of a Class 2 building and a Class 4 part of a building must comply with the national BCA provisions of **J0.2(b)** to **(e)** - except that the reference to “Where *required*” in **J1.2** is deemed to refer to “Where a development consent or a complying development certificate specifies that insulation is to be provided as part of the development.”

Note: Compliance is not *required* with the national BCA provisions of **J0.2(a)** as those matters are regulated under BASIX and national BCA provisions of **J0.2(f)** are covered by **NSW J(A)2.2**.

NSW PART J(A)2 BUILDING SEALING

NSW J(A)2.0 Deemed-to-Satisfy Provisions

- (a) Where a *Deemed-to-Satisfy Solution* is proposed, *Performance Requirement NSW J(A)P2* is satisfied by complying with **NSW J(A)2.1** and **NSW J(A)2.2**.
- (b) Where a *Performance Solution* is proposed, the relevant *Performance Requirements* must be determined in accordance with **A0.7**.

NSW J(A)2.1 Application of Part

The *Deemed-to-Satisfy Provisions* of this Part apply to elements forming the *envelope* of a Class 2 building and a Class 4 part of a building, other than—

- (a) a building in *climate zones* 2 and 5 where the only means of *air-conditioning* is by using an evaporative cooler; or

- (b) a permanent building opening, in a space where a gas appliance is located, that is necessary for the safe operation of a gas appliance; or
- (c) parts of buildings that cannot be fully enclosed.

NSW J(A)2.2 Compliance with BCA provisions

Class 2 buildings and Class 4 parts of buildings must comply with the following national BCA provisions, as applicable—

- (a) **J3.2** Chimneys and flues; and
- (b) **J3.3** Roof lights; and
- (c) **J3.4** Windows and doors; and
- (d) **J3.5** Exhaust fans; and
- (e) **J3.6** Construction of roofs, walls and floors; and
- (f) **J3.7** Evaporative coolers.

NSW PART J(A)3 AIR-CONDITIONING AND VENTILATION SYSTEMS

NSW J(A)3.0 Deemed-to-Satisfy Provisions

- (a) Where a *Deemed-to-Satisfy Solution* is proposed, *Performance Requirement NSW J(A)P3* is satisfied by complying with **NSW J(A)3.1** and **NSW J(A)3.2**.
- (b) Where a *Performance Solution* is proposed, the relevant *Performance Requirements* must be determined in accordance with **A0.7**.

NSW J(A)3.1 Application of Part

The *Deemed-to-Satisfy Provisions* of this Part apply to a Class 2 building and a Class 4 part of a building.

NSW J(A)3.2 Compliance with BCA provisions

Class 2 buildings and Class 4 parts of buildings must comply with the following national BCA provisions, as applicable—

- (a) **J5.2 (a) to (d)** and **(f) to (g)** Air conditioning systems; and
- (b) **J5.3** Mechanical ventilation systems; and
- (c) **J5.4** Miscellaneous exhaust systems.

Note: Compliance is not *required* with the national BCA provisions of **J5.2(e)** as those matters are regulated under BASIX.

NSW PART J(A)4 HEATED WATER SUPPLY

NSW J(A)4.0 Deemed-to-Satisfy Provisions

- (a) Where a *Deemed-to-Satisfy Solution* is proposed, *Performance Requirement NSW J(A)P3* is satisfied by complying with **NSW J(A)4.1** and **NSW J(A)4.2**.
- (b) Where a *Performance Solution* is proposed, the relevant *Performance Requirements* must be determined in accordance with **A0.7**.

NSW J(A)4.1 Application of Part

The *Deemed-to-Satisfy Provisions* of this Part apply to a Class 2 building and a Class 4 part of a building.

NSW J(A)4.2 Compliance with BCA provisions

Class 2 buildings and Class 4 parts of buildings must comply with the national BCA provisions of **J7.2** Heated water supply.

Note: Compliance is not *required* with the national BCA provisions of **J7.3** and **J7.4** as those matters are regulated under BASIX.

NSW PART J(A)5 FACILITIES FOR ENERGY MONITORING

NSW J(A)5.0 Deemed-to-Satisfy Provisions

- (a) Where a *Deemed-to-Satisfy Solution* is proposed, *Performance Requirement NSW J(A)P3* is satisfied by complying with **NSW J(A)5.1** and **NSW J(A)5.3**.
- (b) Where a *Performance Solution* is proposed, the relevant *Performance Requirements* must be determined in accordance with **A0.7**.

NSW J(A)5.1 Application of Part

The *Deemed-to-Satisfy Provisions* of this Part apply to a Class 2 building except within a *sole-occupancy unit*.

NSW J(A)5.2 * * * * *

NSW J(A)5.3 Compliance with BCA provisions

Class 2 buildings must comply with the national BCA provisions of **J8.3**.

NSW SUBSECTION J(B) ENERGY EFFICIENCY - CLASS 3 AND CLASS 5 TO 9 BUILDINGS

For buildings of Class 3 and Class 5 to 9, the energy efficiency provisions of the national BCA as varied by the NSW Appendix, are applicable, as follows—

NSW J(B)1 Compliance with BCA provisions

Class 3 and Class 5 to 9 buildings must comply with all of the provisions of the national **Section J** that are applicable to the relevant classifications, except as varied by **NSW J3.1** Application of Part.

Add NSW J3.1(d) as follows:

NSW J3.1 Application of Part

(d) parts of buildings that cannot be fully enclosed.

Footnote: OTHER LEGISLATION AFFECTING BUILDINGS

In addition to any applicable provisions of the Environmental Planning and Assessment Act 1979, the Environmental Planning and Assessment Regulation 2000 and this Code, there is a variety of other regulatory provisions, including legislation, regulation and departmental policies that impose requirements affecting the design, construction and/or performance of buildings in NSW.

The following is a non-definitive list of such provisions. It does not include Commonwealth provisions that may apply in NSW, nor planning and environmental standards that may impose building requirements in individual circumstances. It is meant as an indicative guide only and is not to be relied upon in any way as a substitute for further research, investigation and legal advice needed to determine building standards in individual circumstances.

1. Abattoirs, Knackeries and Meat Premises

1.1 Administering Agency

NSW Food Authority

Relevant Legislation

Food Regulation 2010

2. Boarding Houses

2.1 Administering Agency

Department of Family and Community Services – Ageing, Disability and Home Care

Relevant Legislation

Boarding Houses Regulation 2013

3. Children's Services

3.1 Administering Agency

NSW Department of Education

Relevant Legislation

Children (Education and Care Services National Law Application) Act 2010

Children (Education and Care Services) Supplementary Provisions Regulation 2012

4. Crematoria, Vaults, Mortuary Churches etc.

4.1 Administering Agency

NSW Ministry of Health

Relevant Legislation

Public Health Regulation 2012

5. Crown Land — Construction Approval

5.1 Administering Agency

Department of Primary Industries – Lands

Relevant Legislation

Crown Lands Act 1989

Crown Lands Regulation 2006

5.2 Administering Agency

NSW Rural Fire Service

Relevant Legislation

Rural Fires Act 1997

6. Dairies

6.1 Administering Agency

NSW Food Authority

Relevant Legislation

Food Regulation 2010

7. Dangerous Goods (including Gas Installations)

7.1 Administering Agency

Department of Industry, Skills and Regional Development – Resources and Energy

Relevant Legislation

Explosives Regulation 2013

Gas Supply Act 1996

Gas Supply (Safety and Network Management) Regulation 2013

7.2 Administering Agency

WorkCover Authority of NSW

Relevant Legislation

Explosives Regulation 2013

Work Health and Safety Regulation 2011

7.3 Administering Agency

NSW Fair Trading

Relevant Legislation

Gas Supply (Consumer Safety) Regulation 2012

8. Dining Rooms and Bars

8.1 Administering Agency

NSW Food Authority

Relevant Legislation

Food Regulation 2010

9. Electrical Installations

9.1 Administering Agency

NSW Fair Trading

Relevant Legislation

Electricity (Consumer Safety) Regulation 2015

Electricity (Consumer Safety) Act 2004

9.2 Administering Agency

WorkCover Authority of NSW

Relevant Legislation

Work Health and Safety Regulation 2011

10. Fire Prevention in Existing Buildings

10.1 Administering Agency

Department of Planning and Environment

Relevant Legislation

Environmental Planning and Assessment Act 1979

Environmental Planning and Assessment Regulation 2000

11. Food Premises

11.1 Administering Agency

NSW Food Authority

Relevant Legislation

Food Regulation 2010

12. Foundries

12.1 Administering Agency

Department of Industry, Skills and Regional Development – Resources and Energy

Relevant Legislation

Gas Supply Act 1996

12.2 **Administering Agency**

WorkCover Authority of NSW

Relevant Legislation

Work Health and Safety Regulation 2011

13. Historic Buildings

13.1 **Administering Agency**

Office of Environment and Heritage

Relevant Legislation

Heritage Regulation 2012

14. Hospitals, Nursing Homes and Health Care Buildings

14.1 **Administering Agency**

NSW Ministry of Health

Relevant Legislation

Private Health Facilities Regulation 2010

Poisons and Therapeutic Goods Regulation 2008

15. Hot or Warm Water Systems and Air Handling Systems

15.1 **Administering Agency**

NSW Ministry of Health

Relevant Legislation

Public Health Regulation 2012

16. Lift Installations

16.1 **Administering Agency**

WorkCover Authority of NSW

Relevant Legislation

Work Health and Safety Regulation 2011

17. Moveable Dwellings (in Caravan Parks)

17.1 **Administering Agency**

Office of Local Government

Relevant Legislation

Local Government Act 1993

17.2 **Administering Agency**

Department of Planning and Environment

Relevant Legislation

Local Government (Manufactured Home Estates, Caravan Parks, Camping Grounds and Moveable Dwellings) Regulation 2005

18. Work Health and Safety

18.1 Administering Agency

WorkCover Authority of NSW

Relevant Legislation

Work Health and Safety Regulation 2011

19. Pharmacies

19.1 Administering Agency

Pharmacy Council of New South Wales

Relevant Legislation

Health Practitioner Regulation National Law (NSW)

Health Practitioner Regulation (New South Wales) Regulation 2010

20. Planning Controls

20.1 Administering Agency

Department of Planning and Environment

Relevant Legislation

Environmental Planning and Assessment Act 1979

Environmental Planning and Assessment Regulation 2000

21. Premises for Activities Involving Skin Penetration

21.1 Administering Agency

NSW Ministry of Health

Relevant Legislation

Public Health Regulation 2012

22. Sanitary Plumbing, Water Supply and Sewerage

22.1 Administering Agency

Office of Local Government

Relevant Legislation

Local Government Act 1993

Local Government (General) Regulation 2005

22.2 Administering Agency

NSW Fair Trading

Relevant Legislation

Plumbing and Drainage Act 2011

Plumbing and Drainage Regulation 2012

Approval to Connect to Network Utility Operator's System

Refer to the Network Utility Operator for the current Act & Regulation

Hunter Water Act 1991

Sydney Water Act 1994

Water Industry Competition Act (WICA) 2006

23. Septic Tank Installations

23.1 Administering Agency

Office of Local Government

Relevant Legislation

Local Government Act 1993

Local Government (General) Regulation 2005

24. Sleeping Accommodation

24.1 Administering Agency

NSW Ministry of Health

Relevant Legislation

Public Health Regulation 2012

25. Smoking Restrictions

25.1 Administering Agency

NSW Ministry of Health

Relevant Legislation

Smoke Free Environment Regulation 2007

Smoke-free Environment Act 2000

Public Health (Tobacco) Act 2008

26. Subdivision of Buildings

26.1 Administering Agency

Department of Finance, Services and Innovation – Land and Property Information

Relevant Legislation

Conveyancing Act 1919

Conveyancing (General) Regulation 2013

Strata Schemes (Freehold Development) Act 1973

Strata Schemes (Freehold Development) Regulation 2012

Strata Schemes (Leasehold Development) Act 1986
Strata Schemes (Leasehold Development) Regulation 2012
Community Land Development Act 1989
Community Land Development Regulation 2007

27. Swimming Pool Fences

27.1 Administering Agency

Office of Local Government

Relevant Legislation

Swimming Pools Act 1992
Swimming Pools Regulation 2008

28. Temporary Structures

28.1 Administering Agency

Department of Planning and Environment

Relevant Legislation

Environmental Planning and Assessment Act 1979
Environmental Planning and Assessment Regulation 2000

NORTHERN TERRITORY

INTRODUCTION

This Appendix contains variations and additions to the Building Code of Australia (BCA) provisions which are considered necessary for the effective application of the Code in the Northern Territory.

APPENDIX CONTENTS

APPENDIX NORTHERN TERRITORY

Northern Territory

A GENERAL PROVISIONS

NT Specification A1.3 Standards Adopted by Reference

B STRUCTURE

NT B1.4 Determination of structural resistance of materials and forms of construction

NT addition to Specification B1.2

E SERVICES AND EQUIPMENT

NT E1.5 Sprinklers

F HEALTH AND AMENITY

NT FP5.1 - NT FP5.4 Performance Requirements

NT F5.0 Deemed-to-Satisfy Provisions

NT F5.1 Application of Part

NT F5.2 Weighted sound reduction index: Interpretation

NT F5.3 Sound insulation of floors between units

NT F5.4 Sound insulation of walls between units

NT F5.5 Walls between a bathroom, sanitary compartment, laundry or kitchen and a habitable room in adjoining unit

NT F5.6 Soil and waste pipes to be separated

NT F5.7 Isolation of pumps

NT F5.8 Walls between a bedroom and kitchen or laundry in a Class 9c building

NT Specification F5.2 Sound Insulation for Building Elements

NT Specification F5.5 Impact Sound - Test of Equivalence

G ANCILLIARY PROVISIONS

NT GP1.1 - GP1.2 Performance Requirements

NT G1.1 Swimming pools

H SPECIAL USE BUILDINGS

NT Part H101 * * * * *

NT Part H102 Premises to be used for Activities Involving Skin Penetration

NT H102.1 Application of Part

NT H102.2 * * * * *

NT H102.3 Washbasins

NT Part H103 Mortuaries

- NT H103.1 Application of Part
- NT H103.2 Layout of mortuary
- NT H103.3 Construction of body preparation room
- NT H103.4 Water supply and sewerage

J ENERGY EFFICIENCY

NT SECTION J Energy Efficiency

Footnote: Other Legislation Affecting Buildings

SECTION A GENERAL PROVISIONS

PART A1 INTERPRETATION

NT Specification A1.3 STANDARDS ADOPTED BY REFERENCE

Insert in Table 1 of Specification A1.3 the following:

NT Table 1 SCHEDULE OF REFERENCED DOCUMENTS

No	Date	Title	BCA Clause(s)
AS/NZS 1170 Part 2	2011	Structural design actions Wind actions Amdt 1	NT Spec B1.2
AS 3660 Part 1	2000	Termite management New building work	NT B1.4
BCA 2009	May 2009	Building Code of Australia	NT Section J

SECTION B STRUCTURE

PART B1 STRUCTURAL PROVISIONS

Delete B1.4(i) and insert NT B1.4(i) as follows:

NT B1.4 Determination of structural resistance of materials and forms of construction

- (i) Termite Risk Management: Where a *primary building element* is subject to attack by subterranean termites—
- (i) AS 3660.1 with additional protection measures to be used in areas where *Mastotermes darwiniensis* are prevalent; and
- (ii) for the purpose of this provision, a *primary building element* consisting entirely of, or a combination of, any of the following materials is considered not to be subject to termite attack:
- (A) Steel, aluminium or other metals.
- (B) Concrete.
- (C) Masonry.
- (D) Fibre-reinforced cement.
- (E) Timber in areas where *Mastotermes darwiniensis* are not prevalent—naturally termite resistant in accordance with Appendix C of AS 3660.1.
- (F) Timber — preservative treated in accordance with Appendix D of AS 3660.1; and

- (iii) where a termite risk management system in accordance with AS 3660.1 is used, a durable notice must be permanently fixed to the building in a prominent location, such as a meter box or the like, indicating—
 - (A) the method of termite risk management; and
 - (B) the date of installation of the system; and
 - (C) where a chemical barrier is used, its life expectancy as listed on the *Appropriate authority's* pesticide register label; and
 - (D) the installer's or manufacturer's recommendations for the scope and frequency of future inspections for termite activity.

NT ADDITION TO SPECIFICATION B1.2

Add clause NT3 and clause NT4 as follows—

NT3 Strengthened area

Where a residential building of Class 2, 3, 9a or 9c, in Region C as defined by AS/NZS 1170.2, is designed to be used by the Aged or Infirm it shall incorporate a "strengthened area" for use as shelter during cyclonic conditions and must comply with the following criteria:

("strengthened area" is defined as the strengthening of an area to increase its potential to facilitate debris protection)

- (a) The *floor area* of the "strengthened area" is to be calculated at the rate of 1.2 m² per person normally accommodated within the building.
- (b) The design wind pressure for the overall "strengthened area" is for an Importance Level 3 building.
- (c) The minimum standard of debris protection to walls, floors and ceilings (or roof) bounding the "strengthened area" shall be that which resists (without complete penetration) the impact loading specified in AS/NZS 1170.2, using a regional wind speed associated with an Importance Level 3 building.
- (d) All doors, windows, vents and the like in walls bounding the "strengthened area" are to be protected against windborne debris with permanently installed screens in accordance with (c).
- (e) Consideration must be given to the selection of materials and fittings to ensure doors, windows and vents can withstand the required design wind pressures.
- (f) All doors serving as required entries/exits to a "strengthened area" are to be inward opening with locking devices suitably noted for use in a cyclone emergency.
- (g) Examples of suitable materials and systems meeting the requirements of **NT3** can be found at <http://www.hpw.qld.gov.au/construction/Projects/CycloneShelters/Pages/ShelterMaterials.aspx>

NT4 Masonry veneer construction

Masonry veneer construction must be designed so that the structural framing, to which the masonry veneer is tied, will ensure the stability of the masonry veneer.

SECTION E SERVICES AND EQUIPMENT

PART E1 FIRE-FIGHTING EQUIPMENT

NT E1.5 Sprinklers

Insert provisions for Class 9a buildings in Table E1.5 as follows:

NT Table E1.5 REQUIREMENTS FOR SPRINKLERS

Occupancy	When sprinklers are required
Class 9a	if more than one <i>storey</i>

SECTION F HEALTH AND AMENITY

PART F5 SOUND TRANSMISSION AND INSULATION

PERFORMANCE REQUIREMENTS

NT FP5.1

Floors separating *sole-occupancy units* must provide insulation against the transmission of airborne and impact generated sound sufficient to prevent illness or loss of amenity to the occupants.

Application:

NT FP5.1 only applies to a Class 2 or 3 building or a Class 9c building.

NT FP5.2

Walls separating—

- (a) *sole-occupancy units*; or
- (b) a *sole-occupancy unit* from a plant room, lift *shaft*, stairway, *public corridor*, public lobby or the like,

must provide insulation against the transmission of airborne and impact generated sound sufficient to prevent illness or loss of amenity to the occupants.

Application:

NT FP5.2 only applies to a Class 2 or 3 building.

NT FP5.3

The *required* sound insulation of floors or walls must not be compromised by the incorporation or penetration of a pipe or other service element.

Application:

NT FP5.3 only applies to a Class 2 or 3 building or a Class 9c building.

NT FP5.4

Walls separating—

- (a) *sole-occupancy units*; or
- (b) a *sole-occupancy unit* from a kitchen, bathroom, *sanitary compartment* (not being an associated ensuite), laundry, plant room or utilities room,

must provide insulation against the transmission of airborne sound sufficient to prevent illness or loss of amenity to the occupants; and

- (c) a *sole-occupancy unit* from a kitchen or laundry,

must provide insulation against the transmission of impact generated sound sufficient to prevent illness or loss of amenity to the occupants.

Application:

NT FP5.4 only applies to a Class 9c building.

DEEMED-TO-SATISFY PROVISIONS

NT F5.0 Deemed-to-Satisfy Provisions

- (a) Where a *Deemed-to-Satisfy Solution* is proposed, *Performance Requirements NT FP5.1 to NT FP5.4* are satisfied by complying with **NT F5.1 to NT F5.8**.
- (b) Where a *Performance Solution* is proposed, the relevant *Performance Requirements* must be determined in accordance with **A0.7**.

NT F5.1 Application of Part

The *Deemed-to-Satisfy Provisions* of this Part apply to Class 2 and 3 buildings and Class 9c *aged care buildings*.

NT F5.2 Weighted sound reduction index: Interpretation

A form of construction *required* to have a certain weighted sound reduction index (R_w) must—

- (a) have the *required* value determined under AS/NZS 1276.1, or ISO 717.1; or
- (b) comply with **NT Specification F5.2**.

NT F5.3 Sound insulation of floors between units

A floor separating *sole-occupancy units* must have an R_w not less than 45.

NT F5.4 Sound insulation of walls between units

A wall must have an R_w not less than 45 if it separates—

- (a) *sole-occupancy units*; or
- (b) a *sole-occupancy unit* not within a Class 9c building from a plant room, lift *shaft*, stairway, *public corridor*, hallway or the like.
- (c) a *sole-occupancy unit* in a Class 9c building from a kitchen, bathroom, *sanitary compartment* (not being an associated ensuite), laundry, plant room or utilities room.

NT F5.5 Walls between a bathroom, sanitary compartment, laundry or kitchen and a habitable room in adjoining unit

- (a) Except for a Class 9c building, a wall separating a bathroom, *sanitary compartment*, laundry or kitchen in one *sole-occupancy unit* from a *habitable room* (other than a kitchen) in an adjoining unit must—
 - (i) have an R_w of not less than 50; and
 - (ii) provide a satisfactory level of insulation against impact sound; and
 - (iii) not incorporate a duct which reduces the R_w of the wall to less than 50.
- (b) A wall satisfies (a)(i) and (a)(ii) if it is—
 - (i) in accordance with **NT Table F5.5**; or
 - (ii) for other than masonry, in 2 or more separate leaves without rigid mechanical connection except at their periphery; or
 - (iii) identical with a prototype that is no less resistant to the transmission of impact sound when tested in accordance with **NT Specification F5.5** than a wall listed in **NT Table F5.5**.

NT Table F5.5 CONSTRUCTION OF WALLS TO REDUCE IMPACT SOUND

<p>Cavity brickwork—</p> <p>Two leaves of 90 mm brick masonry with—</p> <ul style="list-style-type: none"> (i) all joints filled solid with mortar; and (ii) an air space not less than 40 mm between the leaves; and (iii) the leaves connected only by ties in accordance with AS 3700.
<p>Single leaf brickwork—</p> <p>110 mm thick brick masonry with—</p> <ul style="list-style-type: none"> (i) each face rendered 13 mm thick; and (ii) 50 mm x 12 mm thick timber battens at not more than 610 mm centres fixed to each face but not recessed into the render; and (iii) one layer of 12 mm thick softboard nailed to the battens; and (iv) 6 mm thick medium density hardboard adhesive-fixed to the softboard.
<p>Concrete blockwork—</p> <p>190 mm thick concrete block masonry with—</p> <ul style="list-style-type: none"> (i) each face of the blocks fitted with 50 mm x 50 mm timber battens, spaced at not more than 610 mm centres, screw-fixed into resilient plugs with rubber inserts; and

NT Table F5.5 CONSTRUCTION OF WALLS TO REDUCE IMPACT SOUND — continued

- (ii) the space between the battens completely filled with mineral or glass wool blanket or batts not less than 50 mm thick; and
- (iii) the outer face of the battens finished with plasterboard not less than 10 mm thick or other material with a mass per unit area not less than 7.3 kg/m².

NT F5.6 Soil and waste pipes to be separated

If a soil or waste pipe, including a pipe that is embedded in or passes through a floor, serves or passes through more than one *sole-occupancy unit*—

- (a) the pipe must be separated from the rooms of any *sole-occupancy unit* by construction with an R_w not less than—
 - (i) 45 if the adjacent room is a *habitable room* (other than a kitchen); or
 - (ii) 30 if the adjacent room is a kitchen or any other room; and
- (b) a door or panel providing access to the pipe must not open into any *habitable room* (other than a kitchen); and
- (c) an access door or panel in any other part must be firmly fixed so as to overlap the frame or rebate of the frame by not less than 10 mm, be fitted with a sealing gasket along all edges and constructed of—
 - (i) wood, particleboard or blockboard not less than 38 mm thick; or
 - (ii) compressed fibre reinforced cement sheeting not less than 9 mm thick; or
 - (iii) other suitable material with a mass per unit area not less than 24.4 kg/m².

NT F5.7 Isolation of pumps

A flexible coupling must be used at the point of connection between the service pipes in a building and any circulating or other pump.

NT F5.8 Walls between a bedroom and kitchen or laundry in a Class 9c building

In addition to **NT F5.4**, a wall separating a *sole-occupancy unit* in a Class 9c building from a kitchen or laundry must—

- (a) for other than masonry, be two or more separate leaves without rigid mechanical connection except at their periphery; or
- (b) be identical with a prototype that is no less resistant to the transmission of impact sound when tested in accordance with **NT Specification F5.5** than a wall listed in **Table 2 of NT Specification F5.2**.

SPECIFICATION **F5.2** SOUND INSULATION FOR BUILDING ELEMENTS

Deemed-to-Satisfy Provisions

1. Scope

This Specification lists the weighted sound reduction index (R_w) for some common forms of construction.

2. Construction deemed-to-satisfy

The forms of construction listed in **Table 2** are considered to have the R_w stated in that Table if installed as follows:

- (a) **Masonry**—Units must be laid with all joints filled solid, including those between the masonry and any adjoining construction.
- (b) **Concrete slabs**—Joints between concrete slabs and any adjoining construction must be filled solid.
- (c) **Plasterboard**—
 - (i) if one layer is *required* under this Specification, it must be screw-fixed to the studs with joints staggered on opposite faces; and
 - (ii) if 2 layers are *required*, the first layer must be fixed according to (i) and the second layer must be fixed to the first layer with nails, screws or adhesive so that the joints do not coincide with those of the first layer; and
 - (iii) joints between sheets or between sheets and any adjoining construction must be taped and filled solid; and
 - (iv) fire-protective grade plasterboard must be the special grade manufactured for use in *fire-resisting construction*.
- (d) **Steel studs and perimeter members**—
 - (i) the section of steel must be not less than 0.6 mm thick; and
 - (ii) studs must be not less than 63 mm in depth unless another depth is listed in **Table 2**; and
 - (iii) studs must be fixed to steel top and bottom plates of sufficient depth to permit secure fixing of the plasterboard; and
 - (iv) all steel members at the perimeter of the wall must be securely fixed to the adjoining structure and bedded in resilient compound or the joints must be caulked so that there are no voids between the steel members and the wall.

Deemed-to-Satisfy Provisions

Table 2 R_w APPLICABLE TO CONSTRUCTION

Construction	R_w (not less than)
WALLS	
Clay brickwork—	
(a) 230 mm thick in one or more leaves and with a mass per unit area of not less than 290 kg/m ²	45
(b) 110 mm thick rendered 13 mm thick on both sides with a mass per unit area of the unrendered wall being not less than 190 kg/m ²	45
(c) 110 mm thick, of semi-dry-pressed bricks and rendered 13 mm on one side, the mass per unit area of the unrendered wall being not less than 215 kg/m ²	45
(d) 110 mm thick, of extruded brick and rendered 13 mm on one side, the mass per unit area of the unrendered wall being not less than 180 kg/m ²	45
Concrete brickwork — 110 mm thick with a mass per unit area of not less than 195 kg/m ²	45
Concrete blockwork—	
(a) 190 mm thick with a mass per unit area of not less than 215 kg/m ²	45
(b) (i) 140 mm thick, the wall thickness of the blocks being not less than 44 mm and with— 50 mm x 50 mm timber battens spaced at not more than 610 mm centres screw-fixed on one face of the blocks into resilient plugs with rubber inserts between battens and the wall;	
(ii) the face of the battens clad with 13 mm thick standard plasterboard; and	
(iii) a mass per unit area of the whole system of not less than 220 kg/m ²	45
Concrete—	
(a) In-situ concrete — 125 mm thick and with a density of not less than 2200 kg/m ³	45
(b) In-situ concrete — 100 mm thick and with a density of not less than 2500 kg/m ³	45
(c) Precast concrete — 100 mm thick and without joints	45
Steel stud walling—	
(a) with 2 layers of 16 mm thick fire-protective grade plasterboard fixed to each face	45

Deemed-to-Satisfy Provisions

Table 2 R_w APPLICABLE TO CONSTRUCTION — continued

Construction	R_w (not less than)
(b) with—	45
(i) 1 layer of 13 mm thick fire-protective grade plasterboard fixed to one face, and before fixing, 50 mm thick mineral or glass wool blanket or batts stapled to the back of each sheet so that the sheet is completely covered; and	
(ii) 2 layers of 13 mm thick fire-protective grade plasterboard fixed to the other face	
(c) with—	45
(i) 1 layer of 16 mm fire-protective grade plasterboard fixed to one face; and	
(ii) 50 mm thick mineral or glass wool blanket or batts wedged firmly between the studs; and	
(iii) 2 layers of fire-protective grade plasterboard fixed to the other face, the inner layer being 16 mm thick and the outer layer being 13 mm	
(d) with 2 layers of 13 mm plasterboard on both sides of 75 mm studs	45
FLOORS—	
Concrete—	
(a) In-situ concrete slab — 125 mm thick and with a density of not less than 2200 kg/m ³	45
(b) In-situ concrete slab — 100 mm thick and with a density of not less than 2500 kg/m ³	45
(c) Pre-cast concrete slab — 100 mm thick and without joints	45
Timber — comprising—	
(a) timber joists not less than 175 mm x 50 mm; and	45
(b) 75 mm thick mineral or glass wool blanket or batts cut to fit tightly between joists and laid on 10 mm thick plasterboard fixed to underside of joists; and	
(c) 25 mm thick mineral or glass wool blanket or batts laid over entire floor, including tops of joists before flooring is laid; and	
(d) tongued-and-grooved boards not less than 19 mm thick, secured to 75 mm x 50 mm battens; and	
(e) the assembled flooring laid over the joists, but not fixed to them, with the battens lying between the joists	

Deemed-to-Satisfy Provisions

Table 2 R_w APPLICABLE TO CONSTRUCTION — continued

Construction	R_w (not less than)
DUCTS OR OTHER CONSTRUCTION SEPARATING SOIL AND WASTE PIPES FROM UNITS	
Masonry — not less than 90 mm thick	30
Plasterboard — 2 layers of plasterboard—	
(a) each 10 mm thick, fixed to timber studs not less than 75 mm x 50 mm and spaced at not more than 400 mm centres.	30
(b) each 13 mm thick, one on each side of steel studs not less than 50 mm deep and spaced at not more than 400 mm centres	30

SPECIFICATION **F5.5** IMPACT SOUND — TEST OF
EQUIVALENCE

Deemed-to-Satisfy Provisions

1. Scope

This Specification describes a method of test to determine the comparative resistance of walls to the transmission of impact sound.

2. Construction to be tested

- (a) The test is conducted on a specimen of prototype wall construction and on a specimen of one or other of the constructions specified in **NT Table F5.5**.
- (b) The testing of a construction specified in **NT Table F5.5** need not be repeated for subsequent comparisons provided complete records of the results, the test equipment and the technique of testing are kept so that identical equipment can be employed and an identical technique can be adopted in the testing of specimens of prototype wall construction.

3. Method

- (a) The wall constructions to be compared must be tested in accordance with AS 1191.
- (b) A horizontal steel platform 510 mm x 460 mm x 10 mm thick must be placed with one long edge in continuous and direct contact with the wall to be tested on the side of the wall on which the impact sound is to be generated.
- (c) A tapping machine complying with *ISO 140/6—1998 (E)* must be mounted centrally on the steel platform.
- (d) The sound transmission through the wall must be determined in accordance with AS 1191 except that the tapping machine as mounted on the steel platform must be used as the source of sound.
- (e) The impact sound pressure levels measured in the receiving room must be converted into normalised levels using a reference equivalent absorption area of 10 m².

SECTION G ANCILLARY PROVISIONS

PART G1 MINOR STRUCTURES AND COMPONENTS

Delete GP1.1 and GP1.2 insert NT GP1.1 and NT GP1.2 as follows:

PERFORMANCE REQUIREMENTS

NT GP1.1 * * * * *

NT GP1.2

- (a) * * * * *
- (b) A *swimming pool* water recirculation system must incorporate safety measures to avoid entrapment of, or injury to, a person.

Delete G1.1(a) and (b) and insert NT G1.1(a) and (b) as follows:

DEEMED-TO-SATISFY PROVISIONS

NT G1.1 Swimming pools

- (a) * * * * *
- (b) * * * * *

Note:

Barriers and fences for *swimming pools* are regulated by the Northern Territory of Australia Swimming Pool Safety Act 2004.

SECTION H SPECIAL USE BUILDINGS

NT PART H101 * * * * *

This clause has deliberately been left blank.

Insert NT Part H102 as follows:

NT PART H102 PREMISES TO BE USED FOR ACTIVITIES INVOLVING SKIN PENETRATION

NT H102.1 Application of Part

This part applies to premises for tattooing, ear-piercing, acupuncture and like activities.

NT H102.2 * * * * *

This clause has deliberately been left blank.

NT H102.3 Washbasins

The area in which skin penetration is done must be provided with—

- (a) one wash basin for each 10, or part of 10 employees; and
- (b) an adequate supply of hot and cold water controlled by foot-operated or elbow-operated taps.

Insert NT Part H103 as follows:

NT PART H103 MORTUARIES

NT H103.1 Application of Part

This Part applies to any premises used for storage or preparation for burial, cremation or disposal by other means, of bodies of deceased persons.

NT H103.2 Layout of mortuary

- (a) A mortuary may be integral with the remainder of a building but must be separated physically from all public areas of that building.
- (b) Each mortuary at which bodies are prepared for burial, cremation or other disposal must be provided with a body preparation room that is capable of being isolated from the remainder of the premises.
- (c) A vehicle reception area or garage must be provided adjacent to and with direct access to the storage room or body preparation room to ensure that the transfer of uncoffined bodies is screened from public view.
- (d) Access to toilet and shower facilities from any other part of the mortuary premises must be only by way of an air lock.

NT H103.3 Construction of body preparation room

- (a) The floor must be—
 - (i) of impervious material with a smooth, unbroken surface; and
 - (ii) uniformly graded to a floor drain.
- (b) All walls and partitions must be of concrete or masonry with a smooth, unbroken finish for ease of cleaning.

- (c) All joints between the floor, walls, partitions, ceiling, ventilation grilles, fittings, pipework, *windows* and light fittings must be sealed with impervious material for ease of cleaning.
- (d) All joints between the floor and walls or partitions must be coved for ease of cleaning.
- (e) The body preparation room must be provided with at least one washbasin, fitted with elbow or foot-operated taps, and an adequate supply of hot and cold water.
- (f) The body preparation room must be provided with refrigerated storage facilities—
 - (i) with sufficient capacity for the storage of at least two adult bodies; and
 - (ii) capable of maintaining an internal temperature between 1°C and 5°C.

NT H103.4 Water supply and sewerage

Each mortuary with a body preparation room must be connected to—

- (a) a permanent water supply with a physical discontinuity between the water supply and all equipment, appliances, fittings and areas in the mortuary; and
- (b) a water carriage sewerage system.

SECTION J ENERGY EFFICIENCY

SECTION J ENERGY EFFICIENCY

Delete Section J and insert the following:

NT Section J Energy Efficiency

For a Class 2 building and a Class 4 part of a building, **Section J** is replaced with **Section J** of BCA 2009.

Section J does not apply to Class 3 and 5 - 9 buildings.

Footnote: OTHER LEGISLATION AFFECTING BUILDINGS

In addition to any applicable provisions of the Building Act, Building Regulations and this Code, there are a number of other legislative technical requirements affecting the design, construction and/or performance of buildings that practitioners may need to be aware of, including, but not necessarily limited to, the following list. Additional legislative instruments such as regulations, codes and standards may exist under the legislation listed.

1. **Accommodation/Food Premises/Skin Penetration Activities/Mortuaries**
 - 1.1 **Administering Agency**

Department of Health

Relevant Legislation

Public Health Act

2. Child Care

2.1 Administering Agency

Department of Health

Relevant Legislation

Community Welfare Act

Community Welfare (Child Care) Regulations

3. Crown Land

3.1 Administering Agency

Department of Lands, Planning and the Environment

Relevant Legislation

Crown Lands Act

4. Dangerous Goods

4.1 Administering Agency

NT Worksafe

Relevant Legislation

Dangerous Goods Act

5. Electrical Installations

5.1 Administering Agency

Department of Business

Relevant Legislation

Electrical Workers and Contractors Act

Electricity Reform Act

Electricity Reform (Safety and Technical) Regulations

6. Fences — dividing

6.1 Administering Agency

Department of Attorney-General and Justice

Relevant Legislation

Fences Act

7. Fire Prevention

7.1 Administering Agency

Northern Territory Fire and Rescue Service

Relevant Legislation

Fire and Emergency Act

8. Gas Installations

8.1 Administering Agency

NT Worksafe

Relevant Legislation

Work Health Act

Work Health (Occupational Health and Safety) Regulations

9. Historic Building

9.1 Administering Agency

Department of Lands, Planning and the Environment

Relevant Legislation

Heritage Conservation Act

10. Liquor — licensing

10.0 Administering Agency

Department of Justice

Relevant Legislation

Liquor Act

11. Occupational Health and Safety

11.1 Administering Agency

NT Worksafe

Relevant Legislation

Work Health Act

12. Places of Public Entertainment

12.1 Administering Agency

Department of Local Government

Council or Municipality

Relevant Legislation

Places of Public Entertainment Act

13. Planning Controls

13.1 Administering Agency

Department of Lands, Planning and the Environment

Relevant Legislation

Planning Act

Planning Scheme

14. Plumbing Installations

14.1 Administering Agency

Department of Lands, Planning and the Environment

Relevant Legislation

Plumbers and Drainers Licensing Act

Building Act

15. Stormwater Drainage (Municipal Roads)

15.1 Administering Agency

Council or Municipality in which building is located

Relevant Legislation

Local Government Act

16. Stormwater Drainage (Territory Roads)

16.1 Administering Agency

Department of Transport

Relevant Legislation

Control of Roads Act

17. Swimming Pools

17.1 Administering Agency

Department of Lands, Planning and the Environment

Relevant Legislation

Swimming Pool Safety Act

18. Water Supply and Sewage Services

18.1 Administering Agency

Power and Water Corporation

Relevant Legislation

Water Supply and Sewerage Services Act

QUEENSLAND

INTRODUCTION

This Appendix contains variations and additions to the Building Code of Australia (BCA) provisions which are considered necessary for the effective application of the Code in Queensland and shall be treated as amendments to the Code.

APPENDIX CONTENTS

APPENDIX QUEENSLAND

Queensland

A GENERAL PROVISIONS

Qld Specification A1.3 Standards Adopted by Reference

B STRUCTURE

Qld BP1.4 * * * * *

Qld B1.4 Determination of structural resistance of materials and forms of construction

Qld B1.6 Construction of buildings in flood hazard areas

G ANCILLARY PROVISIONS

Qld GP1.2 Performance Requirements

Qld G1.1 Swimming pools

Qld GP5.1 Performance Requirements

Qld G5.1 Deemed-to-Satisfy Provisions

J ENERGY EFFICIENCY

Footnote: Other Legislation Affecting Buildings

SECTION A GENERAL PROVISIONS

Qld Specification A1.3 STANDARDS ADOPTED BY REFERENCE

Insert in Table 1 of Specification A1.3 additional standards as follows:

Qld Table 1 SCHEDULE OF REFERENCED DOCUMENTS

No.	Date	Title	BCA clause(s)
BCA 2009	May 2009	Building Code of Australia	Qld Section J
		Queensland Government, Department of Agriculture, Fisheries and Forestry- Construction timbers in Queensland: Book 1 and Book 2: Properties and specifications for satisfactory performance of construction timbers in Queensland - Class 1 and 10 buildings (Houses, carports, garages, greenhouses and sheds).	Qld B1.4

SECTION B STRUCTURE

PART B1 STRUCTURAL PROVISIONS

Delete BP1.4 and insert Qld BP1.4 as follows:

PERFORMANCE REQUIREMENTS

Qld BP1.4 * * * * *

Note:

Building work in designated flood hazard areas is regulated by the Building Act 1975 and the Queensland Development Code 3.5 - Construction of buildings in flood hazard areas.

After B1.4(f)(iv) insert Qld B1.4(f)(v) as follows:

Qld B1.4 Determination of structural resistance of materials and forms of construction

- (f) Timber Construction:
- (v) Timber used for structural purposes: a species scheduled for the appropriate use in Schedules A, B or C of Book 2 of the 'Queensland Government, Department of Agriculture, Fisheries and Forestry - Construction timbers in Queensland, Book 1 and Book 2 - Properties and specifications for satisfactory performance of construction timbers in Queensland - Class 1 and 10 buildings (Houses, carports, garages, greenhouses and sheds)'.

Delete B1.6 and insert Qld B1.6 as follows:

Qld B1.6 Construction of buildings in flood hazard areas

* * * * *

Note:

Building work in designated flood hazard areas is regulated by the Building Act 1975, and the Queensland Development Code 3.5 - Construction of buildings in flood hazard areas.

SECTION G ANCILLARY PROVISIONS

PART G1 MINOR STRUCTURES AND COMPONENTS

Delete GP1.2(a) and insert Qld GP1.2(a) as follows:

PERFORMANCE REQUIREMENTS

Qld GP1.2

(a) * * * * *

Delete G1.1(a) and (b) and insert Qld G1.1(a) and (b) as follows:

Qld G1.1 Swimming pools

(a) * * * * *

(b) * * * * *

Note:

Barriers and fences for *swimming pools* are regulated by the Building Act 1975 and the Building Regulation 2006.

QLD PART G5 CONSTRUCTION IN BUSHFIRE PRONE AREAS

Delete GP5.1 and insert Qld GP5.1 as follows:

PERFORMANCE REQUIREMENTS

Qld GP5.1

A building that is constructed in a *designated bushfire prone area* must be designed and constructed to reduce the risk of ignition from a bushfire while the fire front passes.

Application

Qld GP5.1 only applies to—

- (a) a Class 2 or 3 building; or
- (b) a Class 10a building or deck associated with a Class 2 or 3 building, located in a *designated bushfire prone area*, but does not apply when the classified vegetation is Group F rainforest (excluding wet sclerophyll forest types), mangrove communities and grasslands under 300 mm high.

Delete G5.1 and insert Qld G5.1 as follows:

DEEMED-TO-SATISFY PROVISIONS

Qld G5.1

The *Deemed-to-Satisfy Provisions* of this Part apply to—

- (a) a Class 2 or 3 building; or
- (b) a Class 10a building or deck associated with a Class 2 or 3 building, located in a *designated bushfire prone area*, but does not apply when the classified vegetation is Group F rainforest (excluding wet sclerophyll forest types), mangrove communities and grasslands under 300 mm high.

Insert SECTION J ENERGY EFFICIENCY

SECTION J ENERGY EFFICIENCY

Insert the following:

In Queensland, for a Class 2 building, **Section J** is replaced with **Section J** of BCA 2009.

Footnote: OTHER LEGISLATION AFFECTING BUILDINGS

All legislative technical requirements affecting the design, construction and/or performance of buildings are consolidated into the Building Act 1975 and other legislative instruments under that Act, such as regulations, codes (including this Code) and standards.

SOUTH AUSTRALIA

INTRODUCTION

This Appendix contains variations and additions to the BCA provisions which are considered necessary for the effective application of the Code in South Australia.

These variations and additions are to be treated as amendments to the BCA and apply to the construction or alteration of all buildings requiring approval under the Development Act 1993 and Regulations 2008.

APPENDIX CONTENTS

APPENDIX SOUTH AUSTRALIA

INTRODUCTION

A GENERAL PROVISIONS

SA A1.1 Definitions
SA Specification A1.3 Standards Adopted by Reference
SA A3.2 Classifications

B STRUCTURE

SA BP1.4 Performance Requirements
SA B1.6 Construction of buildings in flood hazard areas

C FIRE RESISTANCE

SA C1.1 Type of construction required
SA C2.15 Class 2 external walls exposed to brush fences

D ACCESS AND EGRESS

SA D1.2 Number of exits required
SA D2.21 Operation of latch
SA D3.1 General building access requirements
SA Table D3.1a Additional requirements for access for people with a disability

F HEALTH AND AMENITY

SA FP1.5, SA FP1.6 and SA FP1.8 Performance Requirements
SA F1.0 Deemed-to-Satisfy Provisions
SA F1.7 Waterproofing of wet areas in buildings
SA Table F1.7 Waterproofing and water-resistance requirements for building elements in wet areas
SA F1.9 Damp-proofing
SA F1.10 Damp-proofing of floors on the ground
SA F1.11 Provision of floor wastes
SA F2.4 Accessible sanitary facilities
SA Table F2.4(a)(i) Additional accessible unisex sanitary compartments
SA Table F2.4(b)(i) Additional accessible unisex showers

G ANCILLARY PROVISIONS

SA GP1.2 Performance Requirements
SA G1.1 Swimming pools
SA G5.1 Application of Part
SA G5.2 Bushfire attack levels
SA G5.3 Construction requirements

SA Part G7 ACCESS FOR MAINTENANCE

- SA GO7 Objective
- SA GF7.1 and SA GF7.2 Functional Statements
- SA GP7.1 and SA GP7.2 Performance Requirements
- SA G7.0 Deemed-to-Satisfy Provisions
- SA G7.1 Application of Part
- SA G7.2 Access for window cleaning
- SA G7.3 Access for inspection and maintenance between buildings

SA Part G8 MISCELLANEOUS PROVISIONS

- SA GP8.1 Performance Requirements
- SA G8.0 Deemed-to-Satisfy Provisions
- SA G8.1 Application of Part
- SA G8.2 Attachments to buildings

H SPECIAL USE BUILDINGS

SA Part H2 BULK GRAIN STORAGE FACILITIES

- SA H2.1 Application of Part
- SA H2.2 Concessions for bulk grain storage facilities

SA Part H3 FARM BUILDINGS

- SA H3.1 Application of Part
- SA H3.2 Concessions and additions for farm buildings

J ENERGY EFFICIENCY

SA PART J1 BUILDING FABRIC

- SA J1.3 Roof and ceiling construction

Footnote: Other Legislation Affecting Buildings

SECTION A GENERAL PROVISIONS

PART A1 INTERPRETATION

SA A1.1 Definitions

Vary definition for *assembly building* as follows:

Assembly building means a building where people may assemble for—

- (a) civic, theatrical, social, political or religious purposes including a library, theatre, public hall or place of worship; or
- (b) educational purposes in a *school*, *early childhood centre*, preschool, or the like; or
- (c) entertainment, recreational or sporting purposes including—
 - (i) a discotheque or nightclub; or
 - (ii) a cinema; or
 - (iii) a sports stadium, sporting or other club; or
- (d) transit purposes including a bus station, railway station, airport or ferry terminal.

Insert definition for *brush fence* as follows:

Brush fence means a fence or gate that is primarily constructed of Broombrush (*Melaluca Uncinata*).

Vary definition for *farming* as follows:

Farming * * * * *

Vary definition for *farm building* as follows:

Farm building * * * * *

Vary definition for *farm shed* as follows:

Farm shed * * * * *

Vary definition for *farm vehicle* as follows:

Farm vehicle * * * * *

Insert definition for *small arts venue* as follows:

Small arts venue means the whole or the only part of a building that has a rise in storeys of not more than 2—

- (a) in which cultural activities including live music, visual arts displays, dancing, poetry and spoken word performances are provided to the public; and
- (b) the floor area does not exceed 300 m²; and
- (c) no pyrotechnics or theatrical smoke (smoke machines, hazers or the like) are used.

Insert in Table 1 of Specification A1.3 additional standards as follows:

SA Specification A1.3 STANDARDS ADOPTED BY REFERENCE

SA Table 1 SCHEDULE OF REFERENCED DOCUMENTS

No	Date	Title	BCA clause(s)
AS 1530.8		Test on elements of construction for buildings exposed to simulated bushfire attack	
Part 1	2007	Radiant heat and small flaming sources	SA G5.3
Part 2	2007	Large flaming sources	SA G5.3
AS/NZS 1891		Industrial fall-arrest systems and devices	
Part 4	2000	Selection, use and maintenance	SA G7.2
Minister's Specifications			
SA H2.2	1997	Construction of bulk grain storage facilities	SA H2.2
SA H3.2	2015	Concessions for farm buildings	SA H3.2

PART A3 CLASSIFICATION OF BUILDINGS AND STRUCTURES

SA A3.2 Classifications

In A3.2 replace the definition of **Class 6** as follows:

Class 6: a shop or other building for the sale of goods by retail or the supply of services direct to the public, including—

- (a) an eating room, café, restaurant, milk or soft-drink bar; or
- (b) a dining room, bar, shop or kiosk part of a hotel or motel; or
- (c) a hairdresser's or barber's shop, public laundry, or undertaker's establishment; or
- (d) market or sale room, showroom, or *service station*; or
- (e) a *small arts venue*.

SECTION B STRUCTURE

PART B1 STRUCTURAL PROVISIONS

Delete BP1.4 and replace with SA BP1.4:

PERFORMANCE REQUIREMENTS

SA BP1.4

(deleted).

Delete B1.6 and replace with SA B1.6:

SA B1.6 Construction of buildings in flood hazard areas

(deleted).

SECTION C FIRE RESISTANCE

PART C1 FIRE RESISTANCE AND STABILITY

After C1.1(a)(iv) add SA C1.1(a)(v), and after C1.1(b) add SA C1.1(c) and (d) as follows:

SA C1.1 Type of construction required

- (a) The minimum Type of *fire-resisting construction* of a building must be that specified in **Table C1.1** and **Specification C1.1**, except as allowed for—
 - (v) Class 2 buildings located within 3 m of a *brush fence* and Class 10b *brush fences* located within 3 m of a Class 2 building in **C1.1(c)** and **(d)**.
- (c) In addition to the minimum *fire-resisting construction* requirements of **Table C1.1** and **Specification C1.1** a Class 2 buildings must not be constructed within 3 m of a Class 10b *brush fence* unless any part of the building within 3 m of the *brush fence* complies with the *fire resisting* requirements of **SA C2.15**.
- (d) A Class 10b *brush fence* must not be constructed within 3 m of a Class 2 building unless any part of the building within 3 m of the *brush fence* complies with the *fire resisting* requirements of **SA C2.15**.

PART C2 COMPARTMENTATION AND SEPARATION

After C2.14 add SA C2.15 as follows:

SA C2.15 Class 2 external walls exposed to brush fences

Where the distance between the *external wall* of a Class 2 building and a *brush fence* is less than 3 m, the Class 2 building must comply with the following:

- (a) An *external wall* or part of an *external wall* exposed to the *brush fence* must be *fire resisting* and extend to the underside of a *non-combustible* roof covering or a *non-combustible* eaves lining or to a point at which exposure to the *brush fence* no longer exists and must—
 - (i) have a FRL of at least 60/60/60 when tested from the outside; or
 - (ii) be of masonry veneer construction in which the external masonry veneer is not less than 90 mm thick; or
 - (iii) be of masonry construction not less than 90 mm thick; and
 - (iv) have any exposed openings protected in accordance with **C3.4**.

- (b) Where an *external wall* is *required* by (a) to be *fire resisting*, only that part of the wall, including openings within the specified distance, need to be constructed in that manner.
- (c) The requirements of (a) do not apply to subfloor vents, roof vents, weepholes, control joints, construction joints and penetrations for pipes, conduits and the like.
- (d) The following are permitted to encroach within 3 m of a *brush fence*—
 - (i) *non-combustible* fascias, gutters, downpipes; and
 - (ii) eaves with *non-combustible* roof cladding and *non-combustible* lining; and
 - (iii) flues, chimneys, pipes, domestic fuel tanks, cooling or heating appliances or other services; and
 - (iv) light fittings, electricity or gas meters, aerials or antennas; and
 - (v) pergolas, sun blinds or water tanks; and
 - (vi) unroofed terraces, landings, steps and ramps, not more than 1 m in height.
- (e) The distance from any point on an *external wall* of a building to a *brush fence* is measured in any direction from the *external wall*.

SECTION D ACCESS AND EGRESS

PART D1 PROVISION FOR ESCAPE

Insert D1.2(h) as follows:

SA D1.2 Number of exits required

- (h) In addition to any *horizontal exit*, not less than 2 *exits* must be provided from any *small arts venue* that accommodates more than 50 persons, calculated under **D1.13**.

PART D2 CONSTRUCTION OF EXITS

Delete D2.21(c) and insert SA D2.21(c) as follows:

SA D2.21 Operation of latch

- (c) The requirements of (a) do not apply in a Class 9b building (other than a *school*, an *early childhood centre* or a building used for religious purposes) or a Class 6 *small arts venue* to a door in a *required exit* serving a *storey* or room accommodating more than 100 persons, determined in accordance with **D1.13**, in which case it must be readily openable—
 - (i) without a key from the side that faces a person seeking egress; and
 - (ii) by a single hand pushing action on a single device such as a panic bar located between 900 mm and 1.2 m from the floor; and
 - (iii) where a two-leaf door is fitted, the provisions of (i) and (ii) need only apply to one door leaf if the appropriate requirements of **D1.6** are satisfied by the opening of that one leaf.

PART D3 ACCESS FOR PEOPLE WITH A DISABILITY

Delete D3.1 and substitute:

SA D3.1 General building access requirements

Buildings and parts of buildings must be *accessible* as *required* by **Table D3.1** and **SA Table D3.1a**, unless exempt by **D3.4**.

SA Table D3.1a ADDITIONAL REQUIREMENTS FOR ACCESS FOR PEOPLE WITH A DISABILITY

Class of building	Access requirements
Class 2 In developments consisting of 20 or more residential <i>sole-occupancy units</i>	To and within one residential <i>sole-occupancy unit</i> or 5% of the total number of residential <i>sole-occupancy units</i> provided, whichever is the greater

SECTION F HEALTH AND AMENITY

PART F1 DAMP AND WEATHERPROOFING

Delete FP1.5 and add SA FP1.5 as follows:

PERFORMANCE REQUIREMENTS

SA FP1.5

- (a) Moisture from the ground must be prevented from causing—
 - (i) undue dampness or deterioration of building elements; and
 - (ii) unhealthy or dangerous conditions, or loss of amenity for occupants.
- (b) Barriers installed to prevent transfer of moisture from the ground must have—
 - (i) high resistance to moisture penetration; and
 - (ii) high resistance to damage during construction; and
 - (iii) high resistance to degradation by dissolved salts.

Delete FP1.6 add SA FP1.6 as follows:

SA FP1.6

Accidental water overflow from a bathroom, laundry facility or the like must be prevented from penetrating to adjoining rooms or spaces.

After FP1.7 add SA FP1.8 as follows:

SA FP1.8

In laundries, bathrooms or rooms containing shower facilities the floors must be installed in a manner that will prevent accumulation of surface water which could create unhealthy or hazardous conditions.

Delete F1.0(b) and add SA F1.0(b) as follows:

SA F1.0 Deemed-to-Satisfy Provisions

- (b) With the exception of (a), *Performance Requirements FP1.1 to FP1.4, SA FP1.5, SA FP1.6, FP1.7 and SA FP1.8* are satisfied by complying with **F1.1 to F1.6, SA F1.7, SA F1.9 to SA F1.11, F1.12 and F1.13**.

Delete F1.7(a) and insert SA F1.7(a) as follows:

SA F1.7 Waterproofing of wet areas in buildings

- (a) In a Class 2 and 3 building and a Class 4 part of building, building elements in *wet areas* must—
- (i) be *water resistant* or *waterproof* in accordance with **Table F1.7**, except that—
 - (A) in any room containing a washing machine, the wall area from finished floor to a minimum of 75 mm above and 75 mm each side of the washing machine tap outlets must be *water resistant*; and
 - (B) where a *vessel* is inset into a bench top in a kitchen, bar area, kitchenette or domestic food and beverage preparation area—
 - (aa) wall junctions and joints within 150 mm above the *vessel* must be *water resistant* for the extent of the *vessel*; and
 - (bb) the perimeter edges of the *vessel* must be *water resistant* for the extent of the *vessel*; and
 - (C) penetrations in horizontal surfaces for tap and spout outlets in kitchens, bar areas, kitchenettes or domestic food and beverage preparation areas must be *waterproof*; and
 - (ii) comply with AS 3740; and
 - (iii) have floor wastes provided in accordance with **SA F1.11**.

Vary Table F1.7 as follows:

SA Table F1.7 Waterproofing and water-resistance requirements for building elements in wet areas

Vessels or area where the fixture is installed	Floors and horizontal surfaces	Walls	Wall junctions and joints	Wall / floor junctions	Penetrations
Area outside shower area					
For concrete and compressed fibre-cement sheet flooring	<i>Water resistant</i> floor of the room.	N/A	N/A	<i>Water resistant</i> wall / floor junctions.	N/A
For timber floors including particleboard, plywood and other timber based flooring materials	<i>Waterproof</i> floor of the room.			<i>Waterproof</i> wall / floor junctions.	
Other areas					
Walls adjoining other <i>vessel</i> (e.g. sink, basin or laundry tub)	N/A	<i>Water resistant</i> to a height of not less than 150 mm above the <i>vessel</i> , for the extent of the <i>vessel</i> , where the <i>vessel</i> is within 75 mm of a wall.	<i>Waterproof</i> wall junctions where a <i>vessel</i> is fixed to a wall.	N/A	<i>Waterproof</i> tap and spout penetrations where they occur in surfaces <i>required</i> to be <i>waterproof</i> or <i>water resistant</i> .
Laundries and WCs	<i>Water resistant</i> floor of the room.	N/A	N/A	<i>Water resistant</i> wall / floor junctions.	<i>Waterproof</i> penetrations where they occur in surfaces <i>required</i> to be <i>waterproof</i> .
Bathrooms and laundries <i>required</i> to be graded to a floor waste by SA F1.11 .	<i>Waterproof</i> floor of the room.	N/A	N/A	<i>Waterproof</i> wall / floor junctions.	<i>Waterproof</i> penetrations where they occur through the floor.
Note: N/A means not applicable.					

Delete F1.9(b) and insert SA F1.9(b) as follows:

SA F1.9 Damp-proofing

- (b) Damp-proof courses must exhibit long term resistance to degradation by dissolved salts in groundwater and consist of—
 - (i) embossed black polyethylene film meeting the requirements of clause 7.6 of AS/NZS 2904; or
 - (ii) polyethylene coated aluminium meeting the requirements of clause 7.4 of AS/NZS 2904; or
 - (iii) bitumen impregnated materials of not less than 2.5 mm thickness, meeting the requirements of clause 7.5 of AS/NZS 2904, when used in walls not higher than 7.8 m above the level of the damp-proof course.

Delete F1.10 and insert SA F1.10 as follows:

SA F1.10 Damp-proofing of floors on the ground

- (a) If a floor of a room is laid on the ground or on fill, a damp-proofing membrane complying with Section 5.3.3 of AS 2870 must be installed.
- (b) A damp-proofing membrane need not be provided if—
 - (i) weatherproofing is not *required*; or
 - (ii) the floor is the base of a stair, lift or similar *shaft* which is adequately drained by gravitation or mechanical means.

Delete F1.11 and insert SA F1.11 as follows:

SA F1.11 Provision of floor wastes

- (a) Floors in the following rooms or areas must be graded to a floor waste:
 - (i) A bathroom.
 - (ii) Areas adjacent to baths and spas (including the floor area under a free standing bath).
 - (iii) A room containing a *vessel*.
- (b) Floors need not be graded to a floor waste in accordance with (a) if all *vessels*—
 - (i) are provided with in-built overflow protection; or
 - (ii) have permanent open trapped connection to the waste system.
- (c) The fall of the floor surface to a floor waste *required* by (a) must be—
 - (i) between 1:60 and 1:80 in the *shower area*; and
 - (ii) between 1:80 and 1:100 in other areas.

PART F2 SANITARY AND OTHER FACILITIES

Delete F2.4(a) to F2.4(b) and insert SA F2.4(a) to SA F2.4(b) as follows:

SA F2.4 Accessible sanitary facilities

- (a) *accessible* unisex *sanitary compartments* must be provided in *accessible* parts of the building in accordance with **Table F2.4(a)** and **SA Table F2.4(a)(i)**; and

SA Table F2.4(a)(i) ADDITIONAL ACCESSIBLE UNISEX SANITARY COMPARTMENTS

Class of building	Minimum facility for use by people with a disability
Class 2 In every <i>sole-occupancy unit required</i> by SA Table D3.1a to be <i>accessible</i>	Not less than 1

- (b) *accessible* unisex showers must be provided in accordance with **Table F2.4(b)** and **SA Table F2.4(b)(i)**; and

SA Table F2.4(b)(i) ADDITIONAL ACCESSIBLE UNISEX SHOWERS

Class of building	Minimum facility for use by people with a disability
Class 2 In every <i>sole-occupancy unit required</i> by SA Table D3.1a to be <i>accessible</i>	Not less than 1

SECTION G ANCILLARY PROVISIONS

PART G1 MINOR STRUCTURES AND COMPONENTS

Delete GP1.2(a) and insert SA GP1.2(a) as follows:

PERFORMANCE REQUIREMENTS

SA GP1.2

- (a) In order to safeguard young children from drowning or injury in a *swimming pool*, a barrier must be provided to a *swimming pool* and must—
- (i) be continuous for the full extent of the hazard; and
 - (ii) be of a strength and rigidity to withstand the foreseeable impact of people; and
 - (iii) restrict the access of young children to the pool and the immediate pool surrounds; and
 - (iv) have any gates and doors fitted with latching devices not readily operated by young children, and constructed to automatically close and latch.

- (b) In order to safeguard people from drowning or injury due to suction by a *swimming pool* water recirculation system, a *swimming pool* water recirculation system must incorporate safety measures to avoid entrapment of, or injury to, a person.

Application:

SA GP1.2(a) and (b) only apply to a *swimming pool* associated with a Class 2 or 3 building or Class 4 part of a building, with a depth of water more than 300 mm.

Delete G1.1(b) and add SA G1.1(b) as follows:

SA G1.1 Swimming pools

- (b) A *swimming pool* associated with a Class 2 or 3 building or Class 4 part of a building, with a depth of water more than 300 mm, must have suitable barriers to restrict access by young children to the immediate pool surrounds in accordance with AS 1926 Parts 1 and 2.
- (i) This requirement also applies to any *habitable room* or a building with a *habitable room* within the pool area.
 - (ii) If a building or structure could allow access by young children from outside the pool area to inside the pool area, a barrier must be installed in accordance with AS 1926 Parts 1 and 2 to restrict access from the building or structure to the pool area.

Add SA G1.1(d) as follows:

- (d) For the purpose of clause 6.1.1 of AS 1926.3, a skimmer box is an outlet, and must have a means of releasing the vacuum pressure should the suction become blocked.

SA PART G5 CONSTRUCTION IN BUSHFIRE PRONE AREAS

Delete G5.1 and insert SA G5.1:

SA G5.1 Application of Part

The *Deemed-to-Satisfy Provisions* of this Part apply to—

- (a) a Class 2 or 3 building; or
- (b) a Class 10a building or deck located within 6 m of an associated Class 2 or 3 building that is *required* to comply with this Part,

located in a *designated bushfire prone area*.

Delete G5.2 and insert SA G5.2

SA G5.2 Bushfire attack levels

Where a *site* is located in a *designated bushfire prone area*, the bushfire attack level that applies to the *site* is—

- (a) for areas identified as General Bushfire Risk areas in South Australian Development Plans, the BAL — Low bushfire attack level; and
- (b) for areas identified as Medium Bushfire Risk areas in South Australian Development Plans, the BAL — 12.5 bushfire attack level; and

- (c) for areas identified as High Bushfire Risk areas in South Australian Development Plans, the bushfire attack level assessed for the *site* in accordance with AS 3959; and
- (d) for Excluded Areas within 500 m of a High Bushfire Risk area, as identified in South Australian Development Plans, the BAL — Low bushfire attack level; and
- (e) for Excluded Areas within 100 m of a High Bushfire Risk area, as identified in South Australian Development Plans, the bushfire attack level assessed for the site in accordance with AS 3959.

Add SA G5.3 as follows:

SA G5.3 Construction requirements

- (a) A Class 2 or 3 building, or a Class 10a building or deck *required* to comply with this Part, must be constructed in accordance with **SA Table G5.1** for the bushfire attack level for the *site*.
- (b) A Class 10a building or deck is not *required* to comply with **SA G5.3(a)** if it is separated from a Class 2 or 3 building by—
 - (i) for a Class 10a building or deck attached to or sharing a common roof space with a Class 2 or 3 building, a wall that extends from the footings or concrete slab to the underside of a *non-combustible* roof covering and complies with one of the following:
 - (A) The wall has an FRL of not less than 60/60/60 for *loadbearing* walls, and -/60/60 for non-*loadbearing* walls when tested from the Class 10 side; or
 - (B) The wall is of masonry, earth wall or masonry-veneer construction where the masonry leaf is not less than 90 mm in thickness.
 - (ii) for a Class 10a building or deck located below a Class 2 or 3 building, separating floor and/or wall construction that complies with one of the following:
 - (A) The floor and/or wall has an FRL of not less than 60/60/60 for *loadbearing* construction, and -/60/60 for non-*loadbearing* construction when tested from the Class 10 side; or
 - (B) Where part or all of the separating construction is a wall, the wall need not comply with **(A)** if it complies with **SA G5.3(b)(i)(B)**.
 - (iii) for a Class 10a building or deck located within 6 m of a Class 2 or 3 building, comply with **SA G5.3(b)(i)**.
- (c) Openings in separating construction referred to in **SA G5.3(b)(i)** and **(ii)** must comply with the following:
 - (i) Doorways must be protected by -/60/30 *self-closing* fire doors.
 - (ii) *Windows* must be protected by -/60/- fire *windows* permanently fixed in the closed position.
 - (iii) Other openings (excluding control and construction joints, subfloor vents, weepholes and penetrations for pipes and conduits) must be protected by construction with an FRL of not less than -/60/-.
- (d) For the purposes of **SA Table G5.1** bushfire-resisting timber is timber that is in solid, laminated or reconstituted form that meets the criteria specified in Appendix F of AS 3959.

- (e) Where any material, element of construction or system satisfies the test criteria of either AS 1530.8.1, for BAL — 12.5, BAL — 19, BAL — 29 and BAL — 40 and AS 1530.8.2 for BAL — FZ it satisfies the requirements of that BAL.
- (f) If any material, element of construction or system satisfies the test criteria without screening for ember protection, the requirements for screening of openable parts of *windows* must still apply.
- (g) Polycarbonate may be used as roof sheeting for Class 10a buildings located within 6 m of a Class 2 or 3 building for BAL – Low, BAL – 12.5, BAL – 19 and BAL – 29 *sites*.

SA TABLE G5.1 CONSTRUCTION REQUIREMENTS FOR BAL — LOW, BAL — 12.5, BAL — 19, BAL — 29, BAL — 40 and BAL – FZ SITES

FLOOR SYSTEMS	
1.	BAL — Low
<p>A flooring system must comply with one or a combination of the following:</p> <ul style="list-style-type: none"> (a) A concrete slab-on-ground. (b) A suspended concrete floor. (c) A framed floor where, if the underside is greater than 600 mm above finished ground or paving level, the subfloor space is enclosed with— <ul style="list-style-type: none"> (i) a <i>non-combustible</i> sheet material. If fibre reinforced cement sheets are used for this purpose, the sheets must have a minimum thickness of 6 mm; or (ii) a wall that extends around the perimeter of the floor from the underside of the lowest framing member to finished ground or paving level and is constructed in accordance with clauses 7.4.1 and 7.4.2 of the BAL — 29 requirements of AS 3959. <i>Sarking-type material</i> must have a <i>Flammability Index</i> of not more than 5; or (iii) a vertical <i>non-combustible</i> sheet material that extends around the perimeter of the floor from the underside of the lowest framing member to finished ground or paving level. If fibre reinforced cement sheets are used for this purpose, the sheets must have a minimum thickness of 6 mm. (d) A framed floor where, if any joist and/or bearer is less than 600 mm above finished ground or paving level, the subfloor space is— <ul style="list-style-type: none"> (i) if unenclosed, constructed from flooring materials, including bearers, joists and flooring that comply with clause 7.3.2.2 (a) and (b) of the BAL — 29 requirements of AS 3959; or (ii) enclosed with a wall complying with (c)(ii); or (iii) enclosed with <i>non-combustible</i> sheet material that extends not less than 400 mm above finished ground or paving level and to the bottom of the wall sheeting material. If fibre reinforced cement sheets are used for this purpose, the sheets must have a minimum thickness of 6 mm. <p>A flooring system complying with (c) or (d)(ii) or (iii) must have all of the joints in the external surface of walls covered, sealed, overlapped, backed or butt-jointed to prevent gaps greater than 3 mm. Alternatively, <i>sarking-type material</i> can be applied over the frame prior to fixing any external sheeting.</p>	
2.	BAL — 12.5
As per BAL — Low requirements of this table, with the following variation—	

SA TABLE G5.1 CONSTRUCTION REQUIREMENTS FOR BAL — LOW, BAL — 12.5, BAL — 19, BAL — 29, BAL — 40 and BAL — FZ SITES — continued

(a)	Aluminium mesh or aluminium perforated sheet must not be used to enclose a subfloor space.
3.	BAL — 19
As per BAL — Low requirements of this table, with the following variation—	
(a)	Aluminium mesh or aluminium perforated sheet must not be used to enclose a subfloor space.
4.	BAL — 29
As per BAL — Low requirements of this table, with the following variation—	
(a)	Aluminium mesh or aluminium perforated sheet must not be used to enclose a subfloor space.
5.	BAL — 40
A flooring system must comply with clause 8.3 of the BAL — 40 requirements of AS 3959 with the following variation—	
(a)	Where a wall is used to enclose the subfloor space, any <i>required sarking-type material</i> must have a <i>Flammability Index</i> of not more than 5.
(b)	The subfloor space of a framed floor must not be enclosed with mesh or perforated sheet made from corrosion-resistant steel, bronze or aluminium.
6.	BAL — FZ
A flooring system must comply with clause 9.3 of the BAL — FZ requirements of AS 3959 with the following variation—	
(a)	Where a wall is used to enclose the subfloor space, any <i>required sarking-type material</i> must have a <i>Flammability Index</i> of not more than 5.
(b)	The subfloor space of a framed floor must not be enclosed with mesh or perforated sheet made from corrosion-resistant steel, bronze or aluminium.
SUPPORTING POSTS, COLUMNS, STUMPS, PIERS AND POLES (except in subfloor spaces enclosed by aluminium mesh or aluminium perforated sheet as described in FLOORING SYSTEMS 1 BAL — Low (d))	
1.	BAL — Low
Supporting posts, columns, stumps piers and poles must comply with one or a combination of the following:	
(a)	A <i>non-combustible</i> material.
(b)	Bushfire-resisting timber for not less than 400 mm above finished ground or paving level.
(c)	Timber mounted on metal stirrups with a clearance of not less than 75 mm above finished ground or paving level.
2.	BAL — 12.5
As per BAL — Low requirements in this table.	
3.	BAL — 19
As per BAL — Low requirements in this table.	

SA TABLE G5.1 CONSTRUCTION REQUIREMENTS FOR BAL — LOW, BAL — 12.5, BAL — 19, BAL — 29, BAL — 40 and BAL — FZ SITES — continued

4. BAL — 29
Supporting posts, columns, stumps, piers and poles must comply with clause 7.2 of the BAL — 29 requirements of AS 3959.
5. BAL — 40
Supporting posts, columns, stumps, piers and poles must comply with clause 8.2 of the BAL — 40 requirements of AS 3959.
6. BAL — FZ
Supporting posts, columns, stumps, piers and poles must comply with clause 9.2 of the BAL — FZ requirements of AS 3959.
EXTERNAL WALLS
1. BAL — Low
No requirements.
2. BAL — 12.5
The exposed components of <i>external walls</i> must comply with one or a combination of the following:
(a) Clauses 7.4.1(a) and 7.4.2 of the BAL — 29 requirements of AS 3959 and any <i>sarking-type material</i> must have a <i>Flammability Index</i> of not more than 5.
(b) A timber or steel-framed wall that—
(i) is sarked on the outside of the frame with <i>sarking-type material</i> having a <i>Flammability Index</i> of not more than 5; and
(ii) complies with clauses 5.4.1 and 5.4.2 of the BAL — 12.5 requirements of AS 3959.
3. BAL — 19
The exposed components of <i>external walls</i> must comply with one or a combination of the following:
(a) Clauses 7.4.1(a) and 7.4.2 of the BAL — 29 requirements of AS 3959 and any <i>sarking-type material</i> must have a <i>Flammability Index</i> of not more than 5.
(b) A timber or steel-framed wall that—
(i) is sarked on the outside of the frame with <i>sarking-type material</i> having a <i>Flammability Index</i> of not more than 5; and
(ii) complies with clauses 6.4.1 and 6.4.2 of the BAL — 19 requirements of AS 3959.
4. BAL — 29
The exposed components of <i>external walls</i> must comply with clauses 7.4.1 and 7.4.2 of the BAL — 29 requirements of AS 3959 and any <i>sarking-type material</i> must have a <i>Flammability Index</i> of not more than 5.
5. BAL — 40

SA TABLE G5.1 CONSTRUCTION REQUIREMENTS FOR BAL — LOW, BAL — 12.5, BAL — 19, BAL — 29, BAL — 40 and BAL — FZ SITES — continued

The exposed components of <i>external walls</i> must comply with clauses 8.4.1 and 8.4.2 of the BAL — 40 requirements of AS 3959 and any <i>sarking-type material</i> must have a <i>Flammability Index</i> of not more than 5.	
6.	BAL — FZ
The exposed components of <i>external walls</i> must comply with clauses 9.4.1 and 9.4.2 of the BAL — FZ requirements of AS 3959 and any <i>sarking-type material</i> must have a <i>Flammability Index</i> of not more than 5.	
WINDOWS	
1.	BAL — Low
No requirements.	
2.	BAL — 12.5
<i>Window</i> assemblies, and shutters and screens where fitted, must comply with clauses 5.5.1, 5.5.1A and 5.5.2 of the BAL — 12.5 requirements of AS 3959.	
3.	BAL — 19
<i>Window</i> assemblies, and shutters and screens where fitted, must comply with clauses 6.5.1, 6.5.1A and 6.5.2 of the BAL — 19 requirements of AS 3959 with the following variations:	
(a) Aluminium mesh must not be used in the <i>window</i> screens.	
(b) Where leadlight <i>windows</i> are installed they must be protected by <i>non-combustible</i> shutters or toughened glass.	
(c) Where timber is used, it must be bushfire-resisting timber.	
4.	BAL — 29
<i>Window</i> assemblies, and shutters and screens where fitted, must comply with clauses 7.5.1, 7.5.1A and 7.5.2(a) or (b)(i), (ii), (iii) and (v) of the BAL — 29 requirements of AS 3959 with the following variation:	
(a) Aluminium mesh must not be used in the <i>window</i> screens.	
5.	BAL — 40
<i>Window</i> assemblies, and shutters and screens where fitted, must comply with clauses 8.5.1, 8.5.1A and 8.5.2 of the BAL — 40 requirements of AS 3959.	
6.	BAL — FZ
<i>Window</i> assemblies, and shutters and screens where fitted, must comply with clauses 9.5.1, 9.5.1A and 9.5.2 of the BAL — FZ requirements of AS 3959.	
EXTERNAL DOORS	
(including side-hung external doors such as French doors, panel fold and bi-fold doors, sliding doors and garage doors)	
1.	BAL — Low
No requirements.	
2.	BAL — 12.5
Doors and door frames, and shutters and screens, where fitted must comply with clauses 5.5.1, 5.5.1A and 5.5.3, 5.5.4 and 5.5.5 of the BAL — 12.5 requirements of AS 3959.	

SA TABLE G5.1 CONSTRUCTION REQUIREMENTS FOR BAL — LOW, BAL — 12.5, BAL — 19, BAL — 29, BAL — 40 and BAL — FZ SITES — continued

3. BAL — 19
Doors and door frames, and shutters and screens where fitted, must comply with clauses 6.5.1, 6.5.1A and 6.5.3, 6.5.4 and 6.5.5 of the BAL — 19 requirements of AS 3959, with the following variation: (a) Aluminium mesh must not be used in the door screens.
4. BAL — 29
Doors and door frames, and shutters and screens where fitted, must comply with clauses 7.5.1, 7.5.1A and 7.5.3(a) or (b) or (c)(i)(A), (C) or (D), (ii), (iii), (iv), (v), (vi) and (vii), 7.5.4 and 7.5.5 of the BAL — 29 requirements of AS 3959, with the following variations: (a) Aluminium mesh must not be used in the door screens. (b) If shutters are used for side-hung or sliding doors, they must be <i>non-combustible</i> . (c) Side-hung doors must be solid-core with a minimum thickness of 35 mm.
5. BAL — 40
Doors and door frames, and shutters and screens where fitted, must comply with clauses 8.5.1, 8.5.1A and 8.5.3(a) or (b)(i)(A), (ii), (iii), (v), (vii) and (viii), 8.5.4 and 8.5.5 of the BAL — 40 requirements of AS 3959.
6. BAL — FZ
Doors and door frames, and shutters and screens where fitted, must comply with clauses 9.5.1, 9.5.1A and 9.5.3, 9.5.4 and 9.5.5 of the BAL — FZ requirements of AS 3959.
VENTS AND WEEPHOLES
(including vents and weepholes located in <i>external walls</i> and subfloor spaces)
1. BAL — Low
Vents to subfloor spaces and weepholes must be fitted with ember guards made from corrosion-resistant steel, bronze or aluminium mesh or perforated sheet with a maximum aperture size of 2 mm.
2. BAL — 12.5
As per the BAL — Low requirements of this table.
3. BAL — 19
As per the BAL — Low requirements of this table with the following variation: (a) Aluminium mesh or aluminium perforated sheet must not be used for the ember guards.
4. BAL — 29
As per the BAL — 19 requirements of this table.
5. BAL — 40
As per the BAL — 19 requirements of this table.
6. BAL — FZ
As per the BAL — 19 requirements of this table.

SA TABLE G5.1 CONSTRUCTION REQUIREMENTS FOR BAL — LOW, BAL — 12.5, BAL — 19, BAL — 29, BAL — 40 and BAL — FZ SITES — continued

ROOFS	
(including verandahs and attached carport roofs, eaves linings, fascias, gables)	
1. BAL — Low	No requirements.
2. BAL — 12.5	<p>Roofs must comply with clauses 5.6.1, 5.6.2, 5.6.3, 5.6.4 and 5.6.6 of the BAL — 12.5 requirements of AS 3959 with the following variations:</p> <p>(a) Aluminium mesh or aluminium perforated sheet must not be used for screening purposes.</p> <p>(b) Any <i>sarking-type material</i> must have a <i>Flammability Index</i> of not more than 5.</p>
3. BAL — 19	<p>Roofs must comply with clauses 6.6.1, 6.6.2, 6.6.3, 6.6.4 and 6.6.6 of the BAL — 19 requirements of AS 3959 with the following variations:</p> <p>(a) Aluminium mesh or aluminium perforated sheet must not be used for screening purposes.</p> <p>(b) Any <i>sarking-type material</i> must have a <i>Flammability Index</i> of not more than 5.</p> <p>(c) Fascias and bargeboards must be—</p> <ul style="list-style-type: none"> (i) <i>non-combustible</i>; or (ii) bushfire-resisting timber; or (iii) a combination of (i) and (ii). <p>(d) Timber eaves linings and joining strips in linings, fascias and gables must be of bushfire-resisting timber.</p>
4. BAL — 29	<p>Roofs must comply with clauses 7.6.1, 7.6.2, 7.6.3, 7.6.4 and 7.6.6 of the BAL — 29 requirements of AS 3959 with the following variations:</p> <p>(a) Aluminium mesh or aluminium perforated sheet must not be used for screening purposes.</p> <p>(b) Any <i>sarking-type material</i> must have a <i>Flammability Index</i> of not more than 5.</p> <p>(c) Fascias and bargeboards must be—</p> <ul style="list-style-type: none"> (i) <i>non-combustible</i>; or (ii) bushfire-resisting timber; or (iii) a combination of (i) and (ii). <p>(d) Joining strips in linings, fascias and gables must be of bushfire-resisting timber.</p> <p>(e) Fibre-reinforced cement or aluminium must not be used for roof sheeting or fascias.</p> <p>(f) Aluminium must not be used for eaves linings.</p>

SA TABLE G5.1 CONSTRUCTION REQUIREMENTS FOR BAL — LOW, BAL — 12.5, BAL — 19, BAL — 29, BAL — 40 and BAL — FZ SITES — continued

5. BAL — 40
Roofs must comply with clauses 8.6.1, 8.6.2, 8.6.3, 8.6.4 and 8.6.6 of the BAL — 40 requirements of AS 3959 with the following variations:
(a) Sheet roofs (metal or fibre-cement sheet) must be fully sarked with a <i>sarking-type material</i> having a <i>Flammability Index</i> of not more than 5.
(b) Joining strips in eaves linings, fascias and gables must be of bushfire-resisting timber.
(c) Fibre-reinforced cement or aluminium must not be used for roof sheeting or fascias.
(d) Aluminium must not be used for eaves linings.
6. BAL — FZ
Roofs must comply with clauses 9.6.1, 9.6.2, 9.6.3 and 9.6.4 of the BAL — FZ requirements of AS 3959 with the following variation:
(a) Joining strips in eaves linings, fascias and gables must be of bushfire-resisting timber.
ROOF LIGHTS
(including vented Roof lights and skylights)
1. BAL — Low
No Requirements.
2. BAL — 12.5
Roof lights must comply with clause 5.6.5 of the BAL — 12.5 requirements of AS 3959 with the following variations:
(a) Aluminium mesh or perforated sheet must not be used for screening purposes.
(b) Roof lights and associated shafts through the roof space must be sealed with a <i>non-combustible</i> sleeve or lining.
3. BAL — 19
Roof lights must comply with clause 6.6.5 of the BAL — 19 requirements of AS 3959 with the following variations:
(a) Aluminium mesh or perforated sheet must not be used for screening purposes.
(b) Roof lights and associated shafts through the roof space must be sealed with a <i>non-combustible</i> sleeve or lining.
4. BAL — 29
Roof lights must comply with clause 7.6.5 of the BAL — 29 requirements of AS 3959 with the following variations:
(a) Aluminium mesh or perforated sheet must not be used for screening purposes.
(b) Roof lights and associated shafts through the roof space must be sealed with a <i>non-combustible</i> sleeve or lining.
5. BAL — 40
Roof lights must comply with clause 8.6.5 of the BAL — 40 requirements of AS 3959 with the following variation:

SA TABLE G5.1 CONSTRUCTION REQUIREMENTS FOR BAL — LOW, BAL — 12.5, BAL — 19, BAL — 29, BAL — 40 and BAL — FZ SITES — continued

(a)	Roof lights and associated shafts through the roof space must be sealed with a <i>non-combustible</i> sleeve or lining.
6.	BAL — FZ
Roof lights must comply with clause 9.6.3 of the BAL — FZ requirements of AS 3959.	
ROOF-MOUNTED EVAPORATIVE COOLING UNITS	
1.	BAL — Low
No requirements.	
2.	BAL — 12.5
Evaporative coolers must comply with clause 5.6.5 of the BAL — 12.5 requirements of AS 3959 with the following variation:	
(a)	Aluminium mesh or aluminium perforated sheet must not be used for screening purposes.
3.	BAL — 19
Evaporative coolers must comply with clause 6.6.5 of the BAL — 19 requirements of AS 3959 with the following variation:	
(a)	Aluminium mesh or aluminium perforated sheet must not be used for screening purposes.
4.	BAL — 29
Evaporative coolers must comply with clause 7.6.5 of the BAL — 29 requirements of AS 3959 with the following variation:	
(a)	Aluminium mesh or aluminium perforated sheet must not be used for screening purposes.
5.	BAL — 40
Evaporative coolers must not be installed where the <i>site</i> has been classified as BAL — 40.	
6.	BAL — FZ
Evaporative coolers must not be installed where the <i>site</i> has been classified as BAL — FZ.	
OTHER ROOF PENETRATIONS	
(including roof ventilators, aerials, vent pipes and supports for solar collectors)	
1.	BAL — Low
No requirements.	
2.	BAL — 12.5
Roof penetrations must comply with clause 5.6.5 of the BAL — 12.5 requirements of AS 3959 with the following variations:	
(a)	Aluminium mesh or aluminium perforated sheet must not be used for screening purposes.
(b)	All components of roof ventilators (including rotary ventilators), aerials, vent pipes and supports for solar collectors must be of <i>non-combustible</i> material.
3.	BAL — 19

SA TABLE G5.1 CONSTRUCTION REQUIREMENTS FOR BAL — LOW, BAL — 12.5, BAL — 19, BAL — 29, BAL — 40 and BAL — FZ SITES — continued

Roof penetrations must comply with clause 6.6.5 of the BAL — 19 requirements of AS 3959 with the following variations:	
(a)	Aluminium mesh or aluminium perforated sheet must not be used for screening purposes.
(b)	All components of roof ventilators (including rotary ventilators), aerials, vent pipes and supports for solar collectors must be of <i>non-combustible</i> material.
4. BAL — 29	
Roof penetrations must comply with clause 7.6.5 of the BAL — 29 requirements of AS 3959 with the following variations:	
(a)	Aluminium mesh or aluminium perforated sheet must not be used for screening purposes.
(b)	All components of roof ventilators (including rotary ventilators), aerials, vent pipes and supports for solar collectors must be of <i>non-combustible</i> material.
5. BAL — 40	
Roof penetrations must comply with clause 8.6.5 of the BAL — 40 requirements of AS 3959 with the following variation:	
(a)	All components of roof ventilators (including rotary ventilators), aerials, vent pipes and supports for solar collectors must be of <i>non-combustible</i> material.
6. BAL — FZ	
Roof penetrations must comply with clause 9.6.3 of the BAL — FZ requirements of AS 3959 with the following variation:	
(a)	All components of roof ventilators (including rotary ventilators), aerials, vent pipes and supports for solar collectors must be of <i>non-combustible</i> material.
GUTTERS AND DOWNPIPES	
1. BAL — Low	
No requirements.	
2. BAL — 12.5	
Gutters and downpipes must comply with clause 5.6.7 of the BAL — 12.5 requirements of AS 3959.	
3. BAL — 19	
Gutters and downpipes must comply with clause 6.6.7 of the BAL — 19 requirements of AS 3959.	
4. BAL — 29	
Gutters and downpipes must comply with clause 7.6.7 of the BAL — 29 requirements of AS 3959.	
5. BAL — 40	
Gutters and downpipes must comply with clause 8.6.7 of the BAL — 40 requirements of AS 3959.	
6. BAL — FZ	

SA TABLE G5.1 CONSTRUCTION REQUIREMENTS FOR BAL — LOW, BAL — 12.5, BAL — 19, BAL — 29, BAL — 40 and BAL — FZ SITES — continued

Gutters and downpipes must comply with clause 9.6.5 of the BAL — FZ requirements of AS 3959.	
WATER AND GAS SUPPLY PIPES	
1. BAL — Low	No requirements.
2. BAL — 12.5	Water and gas supply pipes must comply with clause 5.8 of the BAL — 12.5 requirements of AS 3959.
3. BAL — 19	Water and gas supply pipes must comply with clause 6.8 of the BAL — 19 requirements of AS 3959.
4. BAL — 29	Water and gas supply pipes must comply with clause 7.8 of the BAL — 29 requirements of AS 3959.
5. BAL — 40	Water and gas supply pipes must comply with clause 8.8 of the BAL — 40 requirements of AS 3959.
6. BAL — FZ	Water and gas supply pipes must comply with clause 9.8 of the BAL — FZ requirements of AS 3959.
VERANDAHS, DECKS, STEPS, RAMPS AND LANDINGS (including balustrades, handrails or other barriers)	
1. BAL — Low	Verandahs, decks, steps and trafficable surfaces of ramps and landings must comply with one or a combination of the following: <ul style="list-style-type: none"> (a) A concrete slab-on-ground. (b) A suspended concrete slab. (c) Any supporting posts or columns must comply with the BAL — Low requirements of this table for supporting posts, column stumps, piers and poles. (d) Any supporting walls must comply with the BAL — 12.5 requirements of this table for <i>external walls</i>. (e) Where sheeted or tongued and grooved solid flooring is used, the flooring system must comply with the BAL — Low requirements of this table for flooring systems. (f) Where a timber deck is used— <ul style="list-style-type: none"> (i) the gap between the timber decking must not be less than 5 mm; and (ii) to facilitate access for extinguishment, the perimeter of the deck must not be enclosed or access to the space beneath the deck impeded; and

SA TABLE G5.1 CONSTRUCTION REQUIREMENTS FOR BAL — LOW, BAL — 12.5, BAL — 19, BAL — 29, BAL — 40 and BAL — FZ SITES — continued

(iii)	The timber decking and flooring must be separated from the remainder of the building in a manner that will not spread the fire into the building.
2. BAL — 12.5	
Verandahs, decks, steps and trafficable surfaces of ramps and landings must comply with the BAL — Low requirements of this table with the following variations:	
(a)	Any supporting posts or columns must comply with the BAL — 12.5 requirements of this table for supporting posts, columns, stumps, piers and poles.
(b)	Where sheeted or tongued and grooved solid flooring is used, the flooring system must comply with the BAL — 12.5 requirements of this table for flooring systems.
3. BAL — 19	
Verandahs, decks, steps and trafficable surfaces of ramps and landings must comply with the BAL — Low requirements of this table with the following variations:	
(a)	Any supporting posts or columns must comply with the BAL — 19 requirements of this table for supporting posts, column stumps, piers and poles.
(b)	Any supporting walls must comply with the BAL — 19 requirements of this table for <i>external walls</i> .
(c)	Where sheeted or tongued and grooved solid flooring is used, the flooring system must comply with the BAL — 19 requirements of this table for flooring systems.
(d)	Where spaced timber deck flooring is used, bushfire-resisting timber must be used for the decking material.
4. BAL — 29	
Verandahs, decks, steps and trafficable surfaces of ramps and landings must comply with the BAL — Low requirements of this table with the following variations:	
(a)	Any supporting posts or columns must comply with the BAL — 29 requirements of this table for supporting posts, column stumps, piers and poles.
(b)	Any supporting walls must comply with the BAL — 29 requirements of this table for <i>external walls</i> .
(c)	Where sheeted or tongued and grooved solid flooring is used, the flooring system must comply with the BAL — 29 requirements of this table for flooring system.
(d)	Where spaced timber deck flooring is used, bushfire-resisting timber must be used for the decking material.
(e)	Balustrades and handrails must be <i>non-combustible</i> , or if timber is used, it must be bushfire-resisting timber.
5. BAL — 40	
Verandahs, decks, steps and trafficable surfaces of ramps and landings must comply with the BAL — 40 requirements of AS 3959 with the following variation:	
(a)	Balustrades and handrails must be <i>non-combustible</i> .
6. BAL — FZ	
Verandahs, decks, steps and trafficable surfaces of ramps and landings must comply with BAL — FZ requirements of AS 3959 with the following variations:	

SA TABLE G5.1 CONSTRUCTION REQUIREMENTS FOR BAL — LOW, BAL — 12.5, BAL — 19, BAL — 29, BAL — 40 and BAL — FZ SITES — *continued*

(a) Balustrades and handrails must be *non-combustible*.

Add SA Part G7 as follows:

SA PART G7 ACCESS FOR MAINTENANCE

OBJECTIVE

SA G07

The Objectives of this Part are—

- (a) to safeguard people from injury while cleaning *windows*; and
- (b) to safeguard people from injury or illness resulting from the creation of hazardous spaces between buildings.

FUNCTIONAL STATEMENTS

SA GF7.1

A building is to provide people with safe conditions for carrying out *window* cleaning operations.

SA GF7.2

The space between buildings must not allow hazardous conditions to arise due to accumulation of rubbish that cannot readily be removed.

PERFORMANCE REQUIREMENTS

SA GP7.1

Where any part of a *window* in a building is more than 5.5 m above ground level, provision must be made for safe access to the external surface of the *window* for minor maintenance and cleaning.

SA GP7.2

The space between buildings must be sufficient to allow access for inspection and maintenance, to avoid hazardous conditions arising due to accumulation of rubbish that could—

- (a) bridge termite barriers; or
- (b) harbour vermin; or

- (c) create a *fire hazard*.

SA G7.0 Deemed-to-Satisfy Provisions

Performance Requirements SA GP7.1 and SA GP7.2 are satisfied by complying with SA G7.1 to SA G7.3.

SA G7.1 Application of Part

The following provisions apply to Class 2 to 9 buildings.

SA G7.2 Access for window cleaning

Where any part of a *window* in a building is more than 5.5 m above ground level, access to the external surface of the *window* for minor maintenance and cleaning must be provided. Any of the following methods are acceptable—

- (a) by means of a moveable gantry; or
- (b) by means of reversible pivoting sashes, each of which has catches that secure the sash in either the normal or reversed position and give visual indication that the *window* is secure, provided that where a *window* sill is less than 900 mm above floor level, safety anchorages are provided; or
- (c) by means of safety harness, having all anchorages—
 - (i) designed and installed in accordance with AS/NZS 1891.4; and
 - (ii) constructed of approved corrosion resistant metal; or
- (d) by means of opening sashes, in which case the maximum reach to the farthest part of the *window* must not exceed 500 mm upwards or 1 m sideways or downwards and provided that where the *window* sill is less than 900 mm above floor level, safety anchorages are provided.

SA G7.3 Access for inspection and maintenance between buildings

Every part of an *external wall* of a building must be not less than 600 mm from—

- (a) the *external wall* of any other building on the same allotment, unless the two buildings are abutting; or
- (b) any boundary of the allotment, unless that wall is on or abutting that boundary, unless the space between external columns is not infilled.

Add SA Part G8 as follows:

SA PART G8 MISCELLANEOUS PROVISIONS

PERFORMANCE REQUIREMENTS

SA GP8.1

An attachment to a building must incorporate features that will—

- (a) protect it against corrosion; and
- (b) collect and discharge its rainwater run-off safely; and
- (c) prevent its projection affecting adjacent road safety conditions or pedestrian traffic; and
- (d) provide resistance to the spread of fire if it overhangs a street boundary,

to a degree necessary to avoid creating hazardous conditions that may cause injury to people passing below or driving past.

SA G8.0 Deemed-to-Satisfy Provisions

Performance Requirement SA GP8.1 is satisfied by complying with **SA G8.1** and **SA G8.2**.

SA G8.1 Application of Part

The following provisions apply to Class 2 to 9 buildings.

SA G8.2 Attachments to buildings

- (a) An attachment to a building that is in the nature of a balcony or awning, bridge, gangway, hoarding or trade sign, sky sign, mast, flagpole, tower, aerial or antenna, lantern, cathead, crane, chimney, flue or duct, or an installation for cleaning and maintenance access must—
 - (i) have all metal parts of corrosion resistant metal, or other metal suitably protected;
 - (ii) not overhang any street boundary at a height less than 2.5 m above the footpath, or 4 m above the roadway; and
 - (iii) be provided with drainage to prevent rainwater or condensate falling onto or running across the footpath, unless either it is a retractable awning in the nature of a sun blind, or unless the total catchment area for run-off is less than 1.5 m².
- (b) A balcony or awning that overhangs a street boundary—
 - (i) must not extend closer than 450 mm to the kerb of the roadway; and
 - (ii) must be constructed of *non-combustible* or fire-retardant materials throughout, except that timber battens may be used to support the soffit lining.

SECTION H SPECIAL USE BUILDINGS

SA PART H2 BULK GRAIN STORAGE FACILITIES

SA H2.1 Application of Part

This Part applies to certain Class 7 buildings erected for commercial bulk handling and storage of granular materials such as grain, ore, or the like, where only a small number of occupants are present at one time.

SA H2.2 Concessions for bulk grain storage facilities

Compliance with Minister's Specification SA H2.2 — “Construction of bulk grain storage facilities” is deemed-to-satisfy the *Performance Requirements* of **Sections C, D, E and F**, as applicable, for cell type silos and large grain storage and handling sheds.

SA PART H3 FARM BUILDINGS

SA H3.1 Application of Part

This Part applies to Class 7 or 8 farm buildings as defined in Minister's Specification H3.2.

SA H3.2 Concessions and additions for farm buildings

Class 7 and 8 farm buildings complying with Minister's Specification SA H3.2 — 'Concessions for farm buildings' and all other relevant BCA *Deemed-to-Satisfy Provisions* not varied by the Minister's Specification are deemed to satisfy the *Performance Requirements* of the BCA.

SECTION J ENERGY EFFICIENCY

SA PART J1 BUILDING FABRIC

After J1.3(d) insert SA J1.3(e) as follows:

SA J1.3 Roof and ceiling construction

- (e) If a Class 5, 6, 7, 8 or 9 building, or part of a building—
- (i) is constructed in *climate zone* 4 or 5; and
 - (ii) has a roof pitch of not more than 5 degrees; and
 - (iii) has a *conditioned space*,
- the roofing material must have an upper surface solar absorptance value of not more than 0.4.

Footnote: OTHER LEGISLATION AFFECTING BUILDINGS

In addition to any applicable provisions of the Development Act 1993, the Development Regulations 2008 and this Code, there are a number of other legislative technical requirements affecting the design, construction and/or performance of buildings that practitioners may need to be aware of, including, but not necessarily limited to, the following list. Additional legislative instruments such as regulations, codes and standards may exist under the legislation listed.

1. Abattoirs

1.1 Administering agency

Department for Health and Ageing

Relevant legislation

Food Act 2001

Food Regulations 2002

2. Accommodation

2.1 Administering agency

Department for Communities and Social Inclusion

Relevant legislation

Supported Residential Facilities Act 1992

Supported Residential Facilities Regulations 2009

3. Asbestos Removal

3.1 Administering agency

SafeWork SA, Department of the Premier and Cabinet

Relevant legislation

Work, Health and Safety Act 2012

Work, Health and Safety Regulations 2012

4. Children's Services

4.1 Administering agency

Department of Further Education and Child Development

Relevant legislation

Children's Services Act 1985

5. Crown Land

5.1 Administering agency

Department of Environment, Water and Natural Resources

Relevant legislation

Crown Land Management Act 2009

Crown Land Management Regulations 2010

6. Dangerous Goods

6.1 Administering agency

Department for Health and Ageing

Relevant legislation

Controlled Substances Act 1984

Controlled Substances (Pesticides) Regulations 2003

Controlled Substances (Poisons) Regulations 2011

6.2 Administering agency

Safework SA, Department of the Premier and Cabinet

Relevant legislation

Dangerous Substances Act 1979

Dangerous Substances Regulations 2002

Explosives Act 1936

Explosives Regulations 2011

Explosives (Fireworks) Regulations 2001

Explosives (Security Sensitive Substances) Regulations 2006

7. Electrical Installations

7.1 Administering agency

Office of the Technical Regulator, Department of State Development

Relevant legislation

Electricity Act 1996

Electricity Regulations 2012

Energy Products Act 2012

Energy Products (Safety and Efficiency) Act 2000

Energy Products (Safety and Efficiency) Regulations 2012

8. Encroachments

8.1 Administering agency

Attorney-General's Department

Relevant legislation

Encroachments Act 1944

9. Fences

9.1 Administering agency

Attorney-General's Department

Relevant legislation

Fences Act 1975

Fences Regulations 2003

10. Fire Prevention in Existing Buildings

10.1 Administering agency

Department of Planning, Transport and Infrastructure

Relevant legislation

Development Act 1993

Development Regulations 2008

10.2 Administering agency

SA Fire and Emergency Services Commission

Relevant legislation

Fire and Emergency Services Act 2005

Fire and Emergency Services Regulations 2005

11. Food Premises

11.1 Administering agency

Department for Health and Ageing

Relevant legislation

Food Act 2001

Food Regulations 2002

12. Gas Installations

12.1 Administering agency

Office of the Technical Regulator, Department of State Development

Relevant legislation

Gas Act 1997

Gas Regulations 2012

Energy Products Act 2012

Energy Products (Safety and Efficiency) Act 2000

Energy Products (Safety and Efficiency) Regulations 2012

13. Historic Buildings

13.1 Administering agency

Department of Environment, Water and Natural Resources

Relevant legislation

Heritage Places Act 1993

Heritage Places Regulations 2005

14. Hospitals, Nursing Homes and Health Care Buildings

14.1 Administering agency

Department for Health and Ageing

Relevant legislation

Health Care Act 2008

Health Care Regulations 2008

15. Housing

15.1 Administering agency

Department for Communities and Social Inclusion

Relevant legislation

Housing Improvement Act 1940

Housing Improvement (Standards) Regulations 2007

16. Licensed Premises

16.1 Administering agency

Office of Liquor and Gambling Commissioner, Attorney-General's Department

Relevant legislation

Liquor Licensing Act 1997

Liquor Licensing (General) Regulations 2012

17. Lift Installations

17.1 Administering agency

Safework SA, Department of the Premier and Cabinet

Relevant legislation

Work, Health and Safety Act 2012

Work, Health and Safety Regulations 2012

18. Occupational Health and Safety

18.1 Administering agency

SafeWork SA, Department of the Premier and Cabinet

Relevant legislation

Work, Health and Safety Act 2012

Work, Health and Safety Regulations 2012

19. Pharmacies

19.1 Administering agency

Department for Health and Ageing

Relevant legislation

Health Practitioner Regulation National Law (South Australia) Act 2010

Health Practitioner Regulation National Law (South Australia) Regulations 2010

20. Radiation Safety

20.1 Administering agency

Environment Protection Authority

Relevant legislation

Radiation Protection and Control Act 1982

Radiation Protection and Control (Ionising Radiation) Regulations 2000

21. Sanitary Plumbing, Water Supply and Sewerage

21.1 Administering agency

Office of the Technical Regulator, Department of State Development

Relevant legislation

Water Industry Act 2012

Water Industry Regulations 2012

22. School (non-government)

22.1 Administering agency

Department of Further Education and Child Development

Relevant legislation

Education Act 1972

Education Regulations 2012

23. Septic Tank and Grey Water Installations

23.1 Administering agency

Department for Health and Ageing

Relevant legislation

South Australian Public Health Act 2011

South Australian Public Health (Wastewater) Regulations 2013

24. Smoking Restrictions

24.1 Administering agency

Department for Health and Ageing

Relevant legislation

Tobacco Products Regulation Act 1997

Tobacco Products Regulations 2004

25. Subdivision of Property

25.1 Administering agency

Land Services Group, Department of Planning, Transport and Infrastructure

Relevant legislation

Community Titles Act 1996

Community Titles Regulations 2011

Real Property Act 1886

Real Property Regulations 2009

Strata Titles Act 1988

Strata Titles Regulations 2003

26. Waste Management and Environment Protection

26.1 Administering agency

Environment Protection Authority

Relevant legislation

Environment Protection Act 1993

Environment Protection Regulations 2009

TASMANIA

INTRODUCTION

The Tasmania BCA Appendix includes variations from the requirements of the 2016 edition of the Building Code of Australia (BCA) and additional requirements resulting from the consolidation in Tasmania of all building-related regulations into the BCA.

The variations from the requirements of the BCA apply to the construction or alteration of all buildings in Tasmania and the extra requirements apply to all workplaces and special-use buildings.

APPENDIX CONTENTS

APPENDIX TASMANIA

Tasmania

A GENERAL PROVISIONS

Tas A1.1 Definitions
Tas Specification A1.3 Standards Adopted By Reference

D ACCESS AND EGRESS

Tas DP10 Performance Requirements
Tas D3.0 Deemed-to-Satisfy Provisions
Tas D3.13 Compliance with Premises Standards

E SERVICES AND EQUIPMENT

Tas EP1.7 Performance Requirements
Tas E1.0 Deemed-to-Satisfy Provisions
Tas E1.101 Fire detection and alarm system

F HEALTH AND AMENITY

Tas Table F2.3 Sanitary Facilities in Class 3, 5, 6, 7, 8 and 9 buildings
Tas F2.101 Non-flushed Urinals
Tas F2.102 Installation of Closet Fixtures

G ANCILLARY PROVISIONS

TAS PART G1 MINOR STRUCTURES AND COMPONENTS

Tas GP1.2 and GP1.6 Performance Requirements
Tas G1.0 Deemed-to-Satisfy Provisions
Tas G1.1 Swimming pools

TAS PART G2 * * * * *

TAS PART G5 CONSTRUCTION IN BUSHFIRE PRONE AREAS

Tas GP5.1 Performance Requirements
Tas G5.3 Vehicular access
Tas G5.4 Water supply

H SPECIAL USE BUILDINGS

TAS PART H101 * * * * *

TAS PART H102 FOOD PREMISES

- Tas H102 P1 to H102 P12 Performance Requirements
- Tas H102.0 Application of Part
- Tas H102.1 Deemed-to-Satisfy Provisions
- Tas H102.2 General Requirements
- Tas H102.3 Pests and contaminants
- Tas H102.4 Drains and Pipes
- Tas H102.5 Offensive material and trade waste
- Tas H102.6 Ventilation
- Tas H102.7 Lighting
- Tas H102.8 Floors, walls and ceilings
- Tas H102.9 Separation of work place
- Tas H102.10 Washbasins
- Tas H102.11 Sinks
- Tas H102.12 Design, construction and installation of fixtures, fittings and equipment
- Tas H102.13 Storage of materials and equipment
- Tas H102.14 Food store
- Tas H102.15 Meat Premises
- Tas H102.16 Dairy produce
- Tas H102.17 Refrigerated and cooling chambers

TAS PART H103 DINING ROOMS AND BAR ROOMS

- Tas H103.1 Application of Part
- Tas H103.2 Sanitary facilities
- Tas H103.3 Separation from other areas

TAS PART H104 * * * * *

TAS PART H105 * * * * *

TAS PART H106 MEAT PREMISES

- Tas H106.1 Application of Part
- Tas H106.2 Premises Processing Animals and Meat

TAS PART H107 FARM DAIRY PREMISES

- Tas H107.1 Application of this Part
- Tas H107.2 Milking Sheds and Holding Yards
- Tas H107.3 Milk Receiving Area and Milk Storage Room
- Tas H107.4 Water supply

TAS PART H108 PHARMACIES

- Tas H108.1 Application of Part
- Tas H108.2 Definition
- Tas H108.3 Pharmacy premises
- Tas H108.4 Dispensary
- Tas H108.5 Security of dispensary

TAS PART H109 HEALTH SERVICES ESTABLISHMENTS

Tas H109.1 Application of Part

Tas H109.2 Design and construction of health services establishments

TAS PART H110 * * * * *

TAS PART H111 * * * * *

TAS PART H112 MORTUARIES

Tas H112.1 Application of Part

Tas H112.2 Layout of mortuary

Tas H112.3 Construction of body preparation room

Tas H112.4 Water supply and sewerage

TAS PART H113 FOUNDRIES

Tas H113.1 Application of Part

Tas H113.2 General

Tas H113.3 Cupola charging platform

Tas H113.4 Deep moulds and pits

Tas H113.5 Pot furnaces

TAS PART H114 PREMISES FOR MANUFACTURE OR PROCESSING OF GLASS REINFORCED PLASTICS

Tas H114.1 Application of Part

Tas H114.2 Separation from other buildings

Tas H114.3 Rise in storeys

Tas H114.4 Maximum floor areas

Tas H114.5 Required exits

Tas H114.6 Hand laminating and spray depositing

Tas H114.7 Ventilation

Tas H114.8 Smoke and heat roof vents

TAS PART H115 PREMISES FOR PRODUCTION OR PROCESSING OF ISOCYANATES

Tas H115.1 Application of Part

Tas H115.2 Areas of work places

Tas H115.3 Separation from other areas and buildings

Tas H115.4 Rise in storeys

Tas H115.5 Maximum floor areas

Tas H115.6 Required exits

Tas H115.7 Bulk stores for polyols and isocyanates

Tas H115.8 Curing room

TAS PART H116 PREMISES FOR ELECTRO-PLATING ELECTRO-POLISHING, ANODISING OR ETCHING

Tas H116.1 Application of Part

Tas H116.2 Floors

Tas H116.3 Height of plating area

Tas H116.4 Air space

Tas H116.5 Ceiling construction

TAS PART H117 PREMISES FOR LEAD PROCESSING

- Tas H117.1 Application of Part
- Tas H117.2 Floors
- Tas H117.3 Height of lead processing areas
- Tas H117.4 Air space and floor space
- Tas H117.5 Interior of lead processing areas
- Tas H117.6 Dust collection
- Tas H117.7 Isolation of certain processes
- Tas H117.8 Drying room shelves
- Tas H117.9 Washing facilities
- Tas H117.10 Change rooms

TAS PART H118 * * * * *

TAS PART H119 * * * * *

TAS PART H120 * * * * *

TAS PART H121 * * * * *

TAS PART H122 EARLY CHILDHOOD CENTRES AND SCHOOL AGE CARE FACILITIES

- Tas H122 O1 Objective
- Tas H122 F1 Functional Statements
- Tas H122 P1 to H122 P3 Performance Requirements
- Tas H122.0 Application of Part
- Tas H122.1 Deemed-to-Satisfy Provisions

TAS PART H123 TEMPORARY STRUCTURES

- Tas H123 P1 to H123 P15 Performance Requirements
- Tas H123.0 Application of Part
- Tas H123.1 Deemed-to-Satisfy Provisions
- Tas H123.2 * * * * *
- Tas H123.3 * * * * *
- Tas H123.4 Access
- Tas H123.5 * * * * *
- Tas H123.6 * * * * *
- Tas H123.7 * * * * *
- Tas H123.8 * * * * *
- Tas H123.9 * * * * *
- Tas H123.10 * * * * *
- Tas H123.11 Lighting
- Tas H123.12 Ventilation
- Tas H123.13 Electrical
- Tas H123.14 Heating appliances
- Tas H123.15 * * * * *

TAS PART H124 PREMISES WHERE WORK IS UNDERTAKEN ON GAS-FUELLED VEHICLES

- Tas H124.1 Application of Part
- Tas H124.2 Working Areas

Footnote: Other Legislation Affecting Buildings

SECTION A GENERAL PROVISIONS

PART A1 INTERPRETATION

Tas A1.1 Definitions

Insert definition for *centre-based care class 4 facility* as follows:

Centre-based care class 4 facility is a facility as defined in Centre Based Care Class 4 Standards.

Insert definition for *centre-based care class 5 facility* as follows:

Centre-based care class 5 facility is a facility as defined in Centre Based Care Class 5 Standards.

Vary the definition for *early childhood centre* as follows:

Early childhood centre means any premises or part thereof providing or intending to provide a centre-based education and care service within the meaning of the Education and Care Services National Law Act 2010 (Vic), the Education and Care Services National Regulations and centre-based services that are licensed or approved under State and Territory children's services law, but excludes—

- (a) education and care primarily provided to school aged children in outside school hours settings; and
- (b) services licensed as *centre based care class 4* under the Child Care Act 2001.

Insert definition for *public* as follows:

Public includes any person working in an enclosed public place.

Insert definition for *School age care facility* as follows:

School age care facility is a facility providing care for children (primarily) 5 years or older in an outside of school hours setting, either approved or licenced under Education and Care Services National Law (Application) Act 2011 or the Child Care Act 2001.

Insert definition for *temporary structure* as follows:

Temporary structure includes any—

- (a) booth, tent or other temporary enclosure, whether or not part of the booth, tent or enclosure is permanent; or
- (b) temporary seating structure; or
- (c) other structure prescribed under the *Building Act 2000*.

Tas Specification A1.3 STANDARDS ADOPTED BY REFERENCE

Insert in Table 1 the following:

TAS Table 1 SCHEDULE OF REFERENCED DOCUMENTS

No.	Date	Title	BCA Clause(s)
AS 1187	1996	Farm milk cooling and storage systems	Tas H107.3
AS 1657	2013	Fixed platforms, walkways, stairways and ladders — Design, construction and installation	Tas H113.3

TAS Table 1 SCHEDULE OF REFERENCED DOCUMENTS — continued

No.	Date	Title	BCA Clause(s)
AS/NZS 1668		The use of ventilation and air-conditioning in buildings	
Part 1	1998	Fire and smoke control in multi-compartment buildings	Tas H102.6
AS 1668		The use of ventilation and air-conditioning in buildings	
Part 2	2012	Mechanical ventilation in buildings	Tas H102.6, Tas H123.12
AS/NZS 1680		Interior lighting	Tas H102.7
Part 1	2006	General principles and recommendations	
Part 2.1	2008	Circulation spaces and other general areas	
Part 2.2	2008	Office and screen based tasks	
Part 2.3	2008	Education and training facilities	
Part 2.4	1997	Industrial tasks and processes Amdt 1	
Part 2.5	1997	Hospitals and medical tasks	
AS 2658	2008	LP Gas - Portable and mobile appliances	Tas H123.14
AS 2746	2008	Working areas for gas fuelled vehicles	Tas 124.2
AS/NZS 3000	2007	Electrical installations (known as the Australian / New Zealand Wiring Rules)	Tas H123.13
AS/NZS 3760	2010	In-service safety inspection and testing of electrical equipment	Tas H123.13
AS 4464	2007	Hygienic production of game meat for human consumption	Tas H106.2
AS 4465	2006	Construction of premises and hygienic production of poultry meat for human consumption	Tas H106.2
AS 4466	1998	Hygienic production of rabbit meat for human consumption	Tas H106.2
AS 4674	2004	Design, construction and fit-out of food premises (Clauses 4.2 and 4.3)	Tas H102.12
AS 4696	2007	Hygienic production and transportation of meat and meat products for human consumption	Tas H106.2

TAS Table 1 SCHEDULE OF REFERENCED DOCUMENTS — continued

No.	Date	Title	BCA Clause(s)
AS 5008	2007	Hygienic rendering of animal products	Tas H106.2
AS 5010	2001	Hygienic production of ratite (emu/ostrich) meat for human consumption	Tas H106.2
AS 5011	2001	Hygienic production of natural casings for human consumption	Tas H106.2
ABCB	2015	Temporary Structures Standard	Tas H123.1
Australian Road Research Board	2009	Unsealed Road Manual - Guidelines to good practice 3 rd Edition	Tas G5.3
Centre Based Care Class 4 Standards	2012	Tasmanian Licencing Standards for Centre Based Child Care Class 4	Tas A1.1
Centre Based Care Class 5 Standards	2011	Tasmanian Licencing Standards for Centre Based Child Care Class 5 (0-12 years)	Tas A1.1
Child Care Act (Tas)	2001		Tas A1.1, Tas H122.0
Dairy Industry Act	1994		Tas H102
Disability (Access to Premises – Buildings) Standards (Cwth)	2010		Tas D3.13
Disability Discrimination Act (Cwth)	1992		Tas DP10
Early Childhood Centre and School Age Care Facilities Code	2012		Tas H122.0, Tas H122.1
Education and Care Services National Law (Application) Act	2011		Tas A1.1, Tas H122.0
Export Control (Milk and Dairy) Orders	2005		Tas H102.16
Health Service Establishments Act	2006		Tas H109.1
Health Service Establishments Code	2012		Tas H109.2
Hygienic Production of Pet Meat		Technical Report 88	Tas H106.2
Plumbing Regulations	2014		Tas H102.2

TAS Table 1 SCHEDULE OF REFERENCED DOCUMENTS — continued

No.	Date	Title	BCA Clause(s)
Primary Produce Safety Act	2011		Tas H102

SECTION D ACCESS AND EGRESS

After DP9 add Tas DP10

PERFORMANCE REQUIREMENTS

Tas DP10

A building or part of a building must be *accessible* in accordance with the requirements of a Standard made under the *Disability Discrimination Act 1992*.

PART D3 ACCESS FOR PEOPLE WITH A DISABILITY

Delete D3.0 Deemed-to-Satisfy Provisions and substitute:

Tas D3.0 Deemed-to-Satisfy Provisions

- (a) Where a *Deemed-to-Satisfy Solution* is proposed, *Performance Requirements DP1 to DP6, DP8, DP9 and Tas DP10* are satisfied by complying with—
 - (i) **D1.1 to D1.16, D2.1 to D2.25, D3.1 to D3.12, and Tas D3.13**; and
 - (ii) in a building containing an *atrium*, **Part G3**; and
 - (iii) additional requirements for Class 9b buildings, **Part H1**; and
 - (iv) for public transport buildings, **Part H2**.
- (b) Where a *Performance Solution* is proposed, the relevant *Performance Requirements* must be determined in accordance with **A0.7**.

After D3.12 add Tas D3.13

Tas D3.13 Compliance with Premises Standards

- (a) A *Building Solution* must comply with the Disability (Access to Premises – Buildings) Standards 2010.
- (b) A *Building Solution* complies with **Tas D3.0(a)** if it complies with the applications, exceptions and concessions in the Disability (Access to Premises – Buildings) Standards 2010.

SECTION E SERVICES AND EQUIPMENT

PART E1 FIRE FIGHTING EQUIPMENT

After EP1.6 insert *Performance Requirement* Tas EP1.7 as follows:

PERFORMANCE REQUIREMENTS

Tas EP1.7

An *automatic* fire detection system must be installed to the degree necessary to alert the *fire brigade* of fire so that fire fighting operations may be undertaken at the earliest possible time appropriate to—

- (a) the building functions and use; and
- (b) the *fire hazard*; and
- (c) the height of the building; and
- (d) the building *floor area*.

Limitation:

Tas EP1.7 only applies to:

- (a) a Class 5 building or Class 6 building having an aggregate *floor area* of more than 1000 m²; and
- (b) a Class 7 building having a *floor area* of more than 1000 m² in which furniture is stored; and
- (c) a Class 8 building which is a special *fire hazard* building and in which more than 25 persons are employed; and
- (d) a Class 9b building which is a *school* or *early childhood centre* or a creche which-
 - (A) is of more than 1 *storey*; or
 - (B) has a storey with a *floor area* more than 500 m²; and
- (e) a Class 9b building which is a theatre.

Delete E1.0 and insert Tas E1.0 as follows:

Tas E1.0 Deemed-to-Satisfy Provisions

Performance Requirements EP1.1 to EP 1.6 and Tas EP1.7 are satisfied by complying with E1.1 to E1.10, Tas E1.101, and for *farm buildings* and *farm sheds*, Part H3.

After E1.10 insert Tas E1.101 as follows:

Tas E1.101 Fire detection and alarm system

An *automatic* fire detection and alarm system must comply with **Clauses 4 and 7 of Specification E2.2a**.

SECTION F HEALTH AND AMENITY

PART F2 SANITARY FACILITIES

Tas Table F2.3 Sanitary Facilities in Class 3, 5, 6, 7, 8 and 9 Buildings

Delete the Note in Table F2.3 alongside *early childhood centres* and replace it with the following:

- Note: If the centre accommodates children under 4 years of age the facilities for use by those children must be—
- (a) junior pans; and
 - (b) wash basins with a rim height not exceeding 600 mm.

After F2.8 insert Tas F2.101 as follows:

Tas F2.101 Non-flushed Urinals

Non-flushed urinals not connected to a sewerage system must comply with **Tas F2.102**.

After Tas F2.101 insert Tas F2.102 as follows:

Tas F2.102 Installation of Closet Fixtures

- (a) If a sufficient sewerage system is not available, an authorised alternative means of disposal of sewage, may be installed.
- (b) If sanitary facilities are not water-flushed, the following provisions apply:
 - (i) A pit latrine, an incinerating toilet, a chemical toilet, a removable pan or a non-flushing urinal must not be within 2 m of a building containing habitable rooms.
 - (ii) The floor on which a removable pan is placed must be impervious.
 - (iii) A room containing a composting toilet must be separated from habitable rooms by way of a permanently ventilated air lock (which may be a circulation space).
 - (iv) The minimum ventilation *required* under (iii) shall be the greater of—
 - (A) 8000 mm²; or
 - (B) 1/500th of the *floor area* of the circulation space.
 - (v) Access for maintenance or removal of waste from a composting toilet must be by way of an access door which opens directly to the outside of the building.

SECTION G ANCILLARY PROVISIONS

PART G1 MINOR STRUCTURES AND COMPONENTS

Delete GP1.2(a) and insert Tas GP1.2(a) as follows:

PERFORMANCE REQUIREMENTS

Tas GP1.2

- (a) A barrier must be provided to a *swimming pool* and must—
- (i) be continuous for the full extent of the hazard; and
 - (ii) be of a strength and rigidity to withstand the foreseeable impact of people; and
 - (iii) restrict the access of young children to the pool and the immediate pool surrounds; and
 - (iv) have any gates and doors fitted with latching devices not readily operated by young children, and constructed to automatically close and latch.

Application:

Tas GP1.2(a) only applies to a *swimming pool* associated with a Class 2 or 3 building or Class 4 part of a building, with a depth of water more than 300 mm.

After GP1.5 insert *Performance Requirements* Tas GP1.6 as follows:

Tas GP1.6

Swimming pools must be suitable and safe to use and be provided with appropriate facilities.

Limitation:

Tas GP1.6 does not apply to a *swimming pool* associated with a Class 2 building.

Delete G1.0(b) and insert Tas G1.0(b) as follows:

Tas G1.0(b) Deemed-to-Satisfy Provisions

Performance Requirements **GP1.2** to **GP1.5**, **Tas GP1.2** and **Tas GP1.6** are satisfied by complying with **G1.1** to **G1.3** and **Tas G1.1**.

After G1.1(c) insert Tas G1.1(d) to (i) as follows:

Tas G1.1 Swimming Pools

- (d) *Swimming pools* for the use of the public, a club, or an association, or in connection with Class 3, 5, 6, 7, 8 or 9 buildings must—
- (i) be constructed of durable materials with smooth finishes; and
 - (ii) have sides vertical; and
 - (iii) in that part of the pool where the water depth is not more than 1.5 m, have the bottom or floor slope not steeper than 1 vertical to 15 horizontal; and
 - (iv) have the depth of water marked clearly and conspicuously on each side of the pool (at the shallow end and at the deep end); and
 - (v) not have diving boards installed where the water depth is less than 3.5 m; and
 - (vi) have scum-gutters with opening not less than 150 mm if they are to provide hand-holds; and

- (vii) have the floor or bottom of the pool, except for the guide lines, of such colours that the light reflectance is not less than 60%.
- (e) For a public *swimming pool* or pool in which competitions are held—
 - (i) all steps into the pool must be recessed; and
 - (ii) fittings must not project into the water area; and
 - (iii) piping must not be bracketed to the sides to provide hand-holds; and
 - (iv) surrounding concourses must be provided not less than 2 m wide, with a suitable non-slip surface, graded away from the pool and drained to waste; and
 - (v) dressing rooms with sanitary accommodation must be so located that bathers pass through that accommodation enroute to the *swimming pool*.
- (f) If the volume of a *swimming pool* exceeds 15 m³—
 - (i) an adequate water recirculation, disinfection and filtration system must be installed; and
 - (ii) the inlet and outlet openings in a *swimming pool* for the purpose of water recirculation must be so located that water movement is continuous from inlet to outlet; and
 - (iii) * * * * *
 - (iv) recirculation of water in a *swimming pool* must be so designed that the pool contents are recirculated not less than once in the period shown in **Tas Table G1.1(f)**; and
 - (v) water filtration rates must not exceed 12 250 L/m² of sand filter bed per hour, or an equivalent rate in other filter media.

Tas TABLE G1.1(f) RECIRCULATION OF WATER IN SWIMMING POOLS

Pool Type	Period
Outdoor <i>Swimming pool</i>	6 hours
Indoor <i>Swimming pool</i>	4 hours
Wading Pool	2 hours

- (g) Where no other suitable sanitary accommodation is provided, sanitary facilities must be provided in accordance with **Tas Table G1.1(g)**.

TAS TABLE G1.1(g) SANITARY FACILITIES AT SWIMMING POOLS

	Maximum Number Served by—					
	Closet Fixtures		Urinals		Wash Basins	
	1	Each Extra	1	Each Extra	1	Each Extra
Males	60	60	60	60	60	60
Females	40	40	-	-	60	60

- (h) Where no other suitable shower facilities are provided, showers must be provided so that each shower serves up to 40 persons.

PART G2 * * * * *

This Part has been deliberately left blank.

TAS PART G5 CONSTRUCTION IN BUSHFIRE PRONE AREAS

Delete *Performance Requirement* GP5.1 and insert Tas GP5.1 as follows:

PERFORMANCE REQUIREMENTS

Tas GP5.1

A building that is constructed in a *designated bushfire prone area* must, to the degree necessary, be—

- (a) designed and constructed to reduce the risk of ignition from a bushfire, appropriate to the—
 - (i) potential for ignition caused by burning embers, radiant heat or flame generated by a bushfire; and
 - (ii) intensity of the bushfire attack on the building; and
- (b) provided with vehicular access to the *site* to assist fire fighting and emergency personnel defend the building or evacuate occupants; and
- (c) provided with access at all times to a sufficient supply of water for fire fighting purposes on the *site*.

Application

Tas GP5.1 only applies to—

- (a) a Class 2 or 3 building; or
- (b) a Class 10a building or deck associated with a Class 2 or 3 building, located in a *designated bushfire prone area*.

Add *Deemed-to-Satisfy Provisions* Tas G5.3 and Tas G5.4 as follows:

DEEMED-TO-SATISFY PROVISIONS

Tas G5.3 Vehicular access

- (a) A Class 2 or 3 building in a *designated bushfire prone area* and the fire fighting water supply access point must be accessible by a private access road which is designed, constructed and maintained to a standard not less than a Modified 4C Access Road.

- (b) **A Modified 4C Access Road** is an all weather road which complies with the Australian Road Research Board "Unsealed Road Manual - Guidelines to good practice", 3rd Edition, March 2009 as a classification 4C Access Road and the following modified requirements:
- (i) Single lane private access roads less than 6 m carriageway width must have 20 m long passing bays of 6 m carriageway width, not more than 100 m apart;
 - (ii) A private access road longer than 100 m, must be provided with a driveway encircling the building or a hammerhead "T" or "Y" turning head 4 m wide and 8 m long, or a trafficable circular turning area of 10 m radius;
 - (iii) Culverts and bridges must be designed for a minimum vehicle load of 20 tonnes; and
 - (iv) Vegetation must be cleared for a height of 4 m, above the carriageway, and 2 m each side of the carriageway.

Tas G5.4 Water Supply

- (a) The external elements of a Class 2 or 3 building in a *designated bushfire prone area* must be within reach of a 120 m long hose connected to:
- (i) a fire hydrant; or
 - (ii) a stored water supply in a water tank, *swimming pool*, dam or lake available for fire fighting at all times which has a capacity of at least 10,000 L for each separate building.
- (b) A water tank and above ground pipes and fittings used for a stored water supply must be made of non-rusting, *non-combustible*, non-heat-deforming materials and must be situated more than 6 m from a building.
- (c) The water tank must have an opening in the top of not less than 250 mm diameter or be fitted with a DIN or NEN standard forged Storz 65 mm adaptor fitted with a suction washer.

SECTION H SPECIAL USE BUILDINGS

TAS PART H101 * * * * *

This Part has deliberately been left blank.

After Tas Part H101 insert Tas Part H102 as follows:

TAS PART H102 FOOD PREMISES

PERFORMANCE REQUIREMENTS

Tas H102 P1

The design and construction of food premises must—

- (a) be appropriate for the activities for which the premises are used; and
- (b) provide adequate space for the activities to be conducted on the food premises and for the fixtures, fittings and equipment used for those activities; and
- (c) permit the food premises to be effectively cleaned and, if necessary, sanitized; and
- (d) to the extent that is practicable:
 - (i) exclude dirt, dust, odours, fumes, smoke and other contaminants; and
 - (ii) not permit the entry of pests; and
 - (iii) not provide harbourage for pests.
- (e) provide that the food premises is able to be used in such a manner that minimises opportunities for food contamination.

Tas H102 P2

- (a) Food premises must have an adequate supply of water if water is to be used at the food premises for any of the activities conducted on the food premises.
- (b) A food business must use potable water for all activities that use water that are conducted on the food premises.

Limitation:

If a food business demonstrates that the use of non-potable water for a purpose will not adversely affect the safety of the food handled by the food business, subclause (b) does not apply.

Tas H102 P3

Food premises must have a sewage and waste water disposal system that—

- (a) will effectively dispose of all sewage and waste water; and
- (b) is constructed and located so that there is no likelihood of the sewage and waste water polluting the water supply or contaminating food.

Tas H102 P4

Food premises must have facilities for the storage of garbage and recyclable matter that—

- (a) adequately contain the volume and type of garbage and recyclable matter on the food premises; and
- (b) enclose the garbage or recyclable matter, if this is necessary to keep pests and animals away from it; and
- (c) are designed and constructed so that they may be easily and effectively cleaned.

Tas H102 P5

Food premises must have sufficient natural or mechanical ventilation to remove fumes, smoke and vapours from the food premises.

Tas H102 P6

Food premises must have lighting systems that provide sufficient natural or artificial light for the activities conducted on the food premises.

Tas H102 P7

- (a) Floors must be designed and constructed in a way that is appropriate for the activities conducted on the food premises.
- (b) Floor must—
 - (i) be able to be effectively cleaned; and
 - (ii) be unable to absorb grease, food particles or water; and
 - (iii) be laid so that there is no ponding of water; and
 - (iv) to the extent that is practicable, be unable to provide harbourage for pests.

Application:

The requirements for floors apply to the floors of all areas used for food handling, cleaning, sanitizing and personal hygiene except the following areas—

- (a) dining areas; and
- (b) drinking areas; and
- (c) other areas to which members of the public usually have access.

Limitation:

The following floors do not have to comply with sub-clause (b)—

- (i) floors of temporary food premises, including ground surfaces, that are unlikely to pose any risk of contamination of food handled on the food premises; and
- (ii) floors of food premises that are unlikely to pose any risk of contamination of food handled on the food premises provided the food business has obtained approval for their use.

Tas H102 P8

Walls and ceilings—

- (a) must be designed and constructed in a way that is appropriate for the activities conducted on the food premises; and
- (b) must be provided where they are necessary to protect food from contamination; and
- (c) provided in accordance with sub-clause (b) must be—
 - (i) sealed to prevent the entry of dirt, dust and pests; and
 - (ii) unable to absorb grease, food particles or water; and
 - (iii) be able to be easily and effectively cleaned; and
- (d) must—
 - (i) be able to be effectively cleaned; and

- (ii) to the extent that is practicable, be unable to provide harbourage for pests.

Application:

The requirements for walls and ceilings apply to the walls and ceilings of all areas used for food handling, cleaning, sanitizing and personal hygiene except the following areas—

- (a) dining areas; and
- (b) drinking areas; and
- (c) other areas to which members of the public usually have access.

Tas H102 P9

- (a) Food premises must have hand washing facilities that are located where they can be easily accessed by food handlers—
 - (i) within areas where food handlers work if their hands are likely to be a source of contamination of food; and
 - (ii) if there are toilets on the food premises—immediately adjacent to the toilets or toilet cubicles.
- (b) Hand washing facilities must be—
 - (i) permanent fixtures; and
 - (ii) provided with a supply of warm running potable water; and
 - (iii) of a size that allows easy and effective hand washing; and
 - (iv) clearly designated for the sole purpose of washing hands, arms and face.

Tas H102 P10

Fixtures, fittings and equipment must—

- (a) be adequate for the production of wholesome food; and
- (b) be fit for their intended use; and
- (c) be designed, constructed, located and installed, and equipment must be located and, if necessary, installed, so that—
 - (i) there is no likelihood that they will cause food contamination; and
 - (ii) they are able to be easily and effectively cleaned; and
 - (iii) adjacent floors, walls, ceilings and other surfaces are able to be easily and effectively cleaned; and
 - (iv) to the extent that is practicable, they do not provide harbourage for pests; and
- (d) have food contact surfaces—
 - (i) able to be easily and effectively cleaned and, if necessary, sanitized if there is a likelihood that they will cause food contamination; and
 - (ii) unable to absorb grease, food particles and water if there is a likelihood that they will cause food contamination; and
 - (iii) made of a material that will not contaminate food.

Tas H102 P11

Food premises must have adequate storage facilities—

- (a) for the storage of items that are likely to be the source of contamination of food, including chemicals, clothing and personal belongings; and
- (b) located where there is no likelihood of stored items contaminating food or food contact surfaces.

Tas H102 P12

All refrigerated or cooling chambers must be constructed so that stored products will not be contaminated.

Application:

- (a) **Tas H102 P1** to **P12** applies to any premises where food intended for human consumption is manufactured, processed, prepared, packed, stored or sold and to which the following apply—
 - (i) *Food Act 2003*; or
 - (ii) *Liquor and Accommodation Act 1990*; or
 - (iii) *Primary Produce Safety Act 2011*; or
 - (iv) *Dairy Industry Act 1994*.
- (b) **Tas H102 P1** to **P12** includes, but is not limited to—
 - (i) bakehouses; and
 - (ii) bar service areas; and
 - (iii) premises for boning, curing, canning, mincing, pre-packing or other similar processes of preparation of meat for sale; and
 - (iv) retail meat premises; and
 - (v) eating houses and tea shops; and
 - (vi) fish shops; and
 - (vii) kitchens in eating houses, restaurants, guest houses, motels and hotels; and
 - (viii) rooms for processing, manufacturing, packing, etc of fruit and vegetables, dairy products, ice blocks, ices, meat-for-sale, or other fish; and
 - (ix) primary produce business premises regulated by or under a Food Safety Scheme made under the *Primary Produce Safety Act 2011*; and
 - (x) take-away-food stores; and
 - (xi) breweries and wineries.
- (c) In **Tas H102 P1** to **P12**, words and meaning as defined in the *Food Act 2003*, *Food Standards Code* and *Liquor and Accommodation Act 1990*, *Dairy Industry Act 1994* and *Primary Produce Safety Act 2011* apply.

Limitations:

Tas H102 P1 to **P12** do not apply to—

- (a) domestic dwellings classified as Class 1 buildings; or
- (b) boarding houses or the like classified as Class 1 buildings; or

- (c) tents, buildings or other structures used temporarily for serving meals to the public at any fair, show, race meeting or other public sports, games or amusements; or
- (d) meat premises covered by **Tas H106**; or
- (e) dairies covered by **Tas H107**; or
- (f) live shellfish premises where live shellfish are being packed or handled for transport or transferral to shellfish processing premises; or
- (g) premises that only sell pre-packaged food that is not potentially hazardous.

DEEMED-TO-SATISFY PROVISIONS

Tas H102.0 Application of Part

- (a) This Part applies to any premises where food intended for human consumption is manufactured, processed or sold and to which the following apply—
 - (i) *Food Act 2003*; or
 - (ii) *Liquor and Accommodation Act 1990*; or
 - (iii) *Primary Produce Safety Act 2011*; or
 - (iv) *Dairy Industry Act 1994*.

- (b) This Part includes, but is not limited to—
 - (i) bakehouses; and
 - (ii) bar service areas; and
 - (iii) premises for boning, curing, canning, mincing, pre-packing or other similar processes of preparation of meat for sale; and
 - (iv) retail meat premises; and
 - (v) eating houses and tea shops; and
 - (vi) fish shops; and
 - (vii) kitchens in eating houses, restaurants, guest-houses, motels and hotels; and
 - (viii) rooms for processing, manufacturing, packing, etc of fruit and vegetables, dairy products, ice blocks, ices, meat-for-sale or other fish; and
 - (ix) primary produce business premises regulated by or under a Food Safety Scheme made under the *Primary Produce Safety Act 2011*; and
 - (x) take-away-food stores; and
 - (xi) breweries and wineries.

- (c) This Part does not apply to—
 - (i) boarding houses or the like classified as Class 1 buildings; or
 - (ii) tents, buildings or other structures used temporarily for serving meals to the public at any fair, show, race meeting or other public sports, games or amusements; or
 - (iii) dairies covered by **Tas Part H107**; or

- (iv) live shellfish premises where live shellfish are being packed or handled for transport or transferral to shellfish processing premises; or
 - (v) premises that only sell pre-packaged food that is not potentially hazardous.
- (d) In this Part, words and meanings as defined in the *Food Act 2003*, *Food Standards Code and Liquor and Accommodation Act 1990*, *Dairy Industry Act 1994* and *Primary Produce Safety Act 2011* apply.

Tas H102.1 Deemed-to-Satisfy Provisions

Performance Requirements Tas H102 P1 to *Tas H102 P12* are satisfied by complying with the relevant provisions of *Tas H102.0* to *Tas H102.17*.

Tas H102.2 General Requirements

- (a) The provision of—
- (i) close-fitting windows and doors; and
 - (ii) air intakes that do not draw in contaminated air; and
 - (iii) air locks and self-closing doors to separate toilet areas, laundries and living areas from food handling areas; or
 - (iv) mechanical ventilation that removes sources of contamination,
- satisfies *Tas H102 P1(d)(i)*.
- (b) The provision of—
- (i) self-closing or pest-screened external doors; and
 - (ii) mesh screens at opening windows or other ventilation openings; and
 - (iii) sealing to drains, grease traps and ventilation pipes; and
 - (iv) sealing to openings where pipes pass through external walls; and
 - (v) the installation of pest-proof flashings to doors,
- satisfies *Tas H102 P1(d)(ii)*.
- (c) The provision of—
- (i) vermin-proof sealing; or
 - (ii) filling; or
 - (iii) access for inspection and cleaning of boxed-in areas,
- satisfies *Tas H102 P1(d)(iii)*.
- (d) The provision of a reticulated water supply from—
- (i) a regulated entity; or
 - (ii) a private water supply with on-site treatment,
- which meets the Australian Drinking Water Guidelines, satisfies *Tas H102 P2(b)*.

Note: ‘Regulated entity’ has the same meaning as the Plumbing Regulations 2004.

Tas H102.3 Pests and contaminants

Premises where customers are served outside the premises through an opening, that has an appliance for the elimination of flies and mechanical ventilation adequate to exhaust air through the opening at a rate of not less than 5 litres per second for each square metre of opening, satisfies [Tas H102 P1\(d\)](#).

Tas H102.4 Drains and Pipes

Premises satisfy [Tas H102 P3](#) where—

- (a) A grease trap, a gully trap or an untrapped opening connected directly with a drain or sewer, is not installed in a room used for preparation, processing, packing or storing of food for sale; and
- (b) as far as is practicable, service pipes are concealed beneath the surface of walls, floors or ceilings, or are fixed clear of the wall, floor or ceiling, at such distance as to facilitate cleaning.

Tas H102.5 Offensive material and trade waste

Where offensive material or trade waste is stored, a separate area or room which—

- (a) is paved and easily cleanable; and
- (b) is graded to drain to a suitable drainage system; and
- (c) has available a supply of water under pressure,

satisfies [Tas H102 P4](#).

Tas H102.6 Ventilation

A mechanical ventilating exhaust system complying with the requirements of AS/NZS 1668.1 and AS 1668.2 satisfies [Tas H102 P5](#).

Tas H102.7 Lighting

A lighting system that—

- (a) complies with AS 1680.1 and AS/NZS 1680.2.4; and
- (b) in areas where open food is handled or stored, has light fittings which are—
 - (i) designed and constructed to prevent contamination of food should the globe or tube shatter; and
 - (ii) free from any features that would harbour dirt, dust, or insects or make the fitting difficult to clean,

satisfies [Tas H102 P6](#).

Tas H102.8 Floors, walls and ceilings

- (a) Floors, walls and ceilings constructed in accordance with Section 3 of AS 4674 (2004), satisfy [Tas H102 P7](#) and [Tas H102 P8](#).
- (b) The wall and ceiling provisions of (a) do not apply to areas in which all food for sale is completely enclosed and otherwise protected from contamination by processing plants, other appliances or other means.

Tas H102.9 Separation of work place

- (a) A room where food for sale is processed, manufactured, prepared, deposited, treated, stored or packed, that does not have direct communication with a room containing sanitary facilities, living quarters, laundry, bathroom or garage or a room where animals are housed, satisfies **Tas H102 P8(b)**.
- (b) 'Direct communication' means a doorway, a window or other opening in a wall between a food preparation or storage area opening directly onto a room described in (a). Access between those areas via another room, a hallway, or an airlock, satisfies **Tas H102 P8(b)**.

Tas H102.10 Washbasins

- (a) Premises or places for preparation or storage of food for sale provided with not less than one washbasin complying with (b) within five metres of any activity where hands are likely to be a source of contamination of food, satisfies **Tas H102 P9**.
- (b) Each washbasin must—
 - (i) have hot and cold water through a common outlet; and
 - (ii) have a capacity of at least 11 litres; and
 - (iii) provide not less than 250 mm between the spout and the bottom of the basin; and
 - (iv) be in a position that is not obstructed.

Tas H102.11 Sinks

- (a) Where equipment and utensils are required to be manually cleaned and sanitized, or food preparation requires a sink, premises that are provided with a suitably sized double bowl sink for equipment washing and a separate suitably sized sink for food preparation of stainless steel supplied with—
 - (i) hot and cold water; and
 - (ii) an integral drainer on at least one side or a third bowl,
 satisfies **Tas H102 P10**.
- (b) A sink installed adjacent to a wall or other vertical surface, that is fitted with an integral flashing to that wall or vertical surface to a height of not less than 150 mm, satisfies **Tas H102 P10**.
- (c) A sink provided with an integral surround not less than 150 mm wide except on sides with an integral flashing as in (b), satisfies **Tas H102 P10**.
- (d) A cleaner's sink separated from food storage and handling areas provided for the emptying of cleaning water, satisfies **Tas H102 P10**.

Tas H102.12 Design, construction and installation of fixtures, fittings and equipment

- (a) The provision of fixtures, fittings and equipment designed, constructed and installed in accordance with clause 4.2 and clause 4.3 of AS 4674 satisfies **Tas H102 P10**.
- (b) The provision of—

- (i) automatic equipment that uses water to sanitize utensils or other equipment and only operate for the purposes of sanitation when the water is at a temperature that will sanitize the utensils or equipment; or
- (ii) a sink that meets [Tas H102.11](#), satisfies [Tas H102 P10](#).

Tas H102.13 Storage of materials and equipment

- (a) Separate areas for the storage of fuel, cleaning compounds and general maintenance equipment provided so as to prevent the contamination of the product in the event of a spillage or any other form of breakdown, satisfies [Tas H102 P11](#).
- (b) A separate area for the storage of staff clothing and personal effects, satisfies [Tas H102 P11](#).

Tas H102.14 Food store

An eating house provided with a dry-food store, satisfies [Tas H102 P11](#).

Tas H102.15 Meat Premises

- (a) Premises used for the preparation or sale of red meat, other than those licensed under the *Meat Hygiene Act 1985*, that comply with—
 - (i) [Tas Part H106](#); or
 - (ii) the provisions of [Tas H102.2](#) to [Tas H102.13](#) and [Tas H102.17](#), satisfy in relation to building construction, the requirements of [Tas H102 P1](#) to [P12](#).

Tas H102.16 Dairy produce

Definition:

- (a) **Dairy produce** products include milk, colostrum, liquid milk products, cream and thickened cream, butter, butter concentrate, buttermilk, concentrated buttermilk, dairy blend, ghee, anhydrous milk fat (butter oil), casein, caseinate, cheese, whey, whey cream, concentrated whey cream, cultured milk, yoghurt, ice cream, ice cream mix, buttermilk powder, lactose powder, milk sugar, powdered milk, skim milk powder, whey powder, milk protein powder and other milk concentrates.
- (b) Premises designed and constructed in compliance with the Export Control (Milk and Dairy) Orders 2005, satisfy the special requirements of this code for premises to be used for the manufacture of *dairy produce*.

Tas H102.17 Refrigerated and cooling chambers

The construction of a refrigerated chamber or cooling chamber installed in premises for storage of food complying with the requirements for that premises, satisfies [Tas H102 P12](#) where they have—

- (a) internal and external panels adhered directly to the insulating core material to form an integral wall section with tight fitting edges resistant to penetration by liquids; and
- (b) every joint caulked with a water-resistant, flexible sealer and finished in such a manner as to prevent migration of liquids into the core; and

- (c) every intersection of walls with floors and walls with walls covered with a radius not less than 25 mm; and
- (d) exposed slot-head screws or open-headed pop rivets filled with sealer; and
- (e) service pipes and conduits concealed in floors, walls or ceilings, if practicable, or fixed on brackets to provide clearances of not less than 25 mm between the pipe and a wall and 100 mm between the pipe and a floor; and
- (f) fittings not fixed over exposed pipes nor in a position to make difficult the cleaning of the pipe and surrounding area; and
- (g) rat proof construction, and any inaccessible spaces between the low temperature room and surrounding walls, ceilings and fixtures proof against rats and vermin; and
- (h) floors graded, as shown in **Tas Table H102.17(h)**, to drains located outside the chamber as near as practicable to the door opening; and
- (i) drainage from cooling units within the chamber constructed in accordance with **Tas Table H102.17(i)**, draining to a trapped outlet located outside the chamber.

Tas TABLE H102.17(h) FLOOR DRAINAGE OF REFRIGERATED OR COOLING CHAMBERS

	FLOOR SLOPE
Active chillers	not less than 1:50
Other chambers	not less than 1:100

Tas TABLE H102.17(i) DRAINAGE FROM COOLING UNITS WITHIN REFRIGERATED CHAMBERS OR COOLING CHAMBERS

<p>Wall-mounted cooling units -</p> <p style="padding-left: 20px;">drain water must be contained and removed by either a wall-mounted channel or a spoon drain located under the coil.</p>
<p>Floor-mounted cooling units -</p> <p style="padding-left: 20px;">drain water must be confined by kerbs, of a height not less than 150 mm, and directed to a trapped drain outlet.</p>
<p>Ceiling-mounted cooling units -</p> <p style="padding-left: 20px;">drain water must be confined by suitable insulated drip trays directly connected to the drainage system.</p>

After Tas Part H102 insert Tas Part H103 as follows:

TAS PART H103 DINING ROOMS AND BAR ROOMS

Tas H103.1 Application of Part

This Part applies to all dining rooms and bar rooms (excluding bar service areas) in licensed premises covered by the *Liquor and Accommodation Act 1990*.

Dining rooms and bar rooms must provide for the comfort, convenience and health of customers.

Tas H103.2 Sanitary facilities

- (a) Separate sanitary facilities for males and females must be provided in close proximity to each dining room and bar room in licensed premises.
- (b) Where the sanitary facilities are not accessed from within the dining room or bar area, reasonable fixed protection from the elements must be provided.

Tas H103.3 Separation from other areas

A dining room must not have direct opening to living quarters, a laundry, bathroom or garage or a room where animals are housed.

TAS PART H104 * * * * *

This Part has been deliberately left blank.

TAS PART H105 * * * * *

This Part has been deliberately left blank.

After Tas Part H105 insert Tas Part H106 as follows:

TAS PART H106 MEAT PREMISES

Tas H106.1 Application of Part

- (a) This Part is applicable to—
 - (i) meat premises processing animals, including game and poultry, and producing meat and meat products for human consumption; and
 - (ii) pet food works licensed under *Meat Hygiene Act 1985*.
- (b) Meat premises must be constructed in such a manner that—
 - (i) does not jeopardise animal welfare; and
 - (ii) provides for hygienic processing of animals; and
 - (iii) ensures the wholesomeness of meat and meat products.

Tas H106.2 Premises Processing Animals and Meat

Premises used for the processing of animals and meat for human consumption must comply with the relevant Parts and Sections of the Australian Standards listed below:

- (a) Hygienic Production and Transportation of Meat and Meat Products for Human Consumption, AS 4696 - Part 7, Sections 19 to 21.
- (b) Hygienic Production of Game Meat for Human Consumption, AS 4464 - Section 6 .
- (c) Construction of Premises and Hygienic Production of Poultry Meat for Human Consumption, AS 4465 - Part A, Sections 3 to 12.
- (d) Hygienic Production of Rabbit Meat for Human Consumption, AS 4466 - Section 5.

- (e) Hygienic Rendering of Animal Products, AS 5008 - Section 3.
- (f) Hygienic Production of Ratite (Emu/Ostrich) Meat for Human Consumption, AS 5010 - Section 5.
- (g) Hygienic Production of Natural Casings for Human Consumption, AS 5011 - Section 4.
- (h) Hygienic Production of Pet Meat, PISC – Technical Report 88 – Sections 6.1 – 6.7, 6.9 and 6.11.

After Tas Part H106 insert Tas Part H107 as follows:

TAS PART H107 FARM DAIRY PREMISES

Tas H107.1 Application of this Part

This part is applicable to every farm dairy as covered by the *Tasmanian Dairy Industry Act 1994*.

Dairies must be constructed in such a manner that contamination of milk can be avoided.

Tas H107.2 Milking Sheds and Holding Yards

- (a) The walls (including the walls of the pit of a herringbone design milking shed) must be non absorbent and easy to clean.
- (b) The floor of a holding yard and a milking shed must be non absorbent, easy to clean and free-draining.
- (c) The lighting of a holding yard and a milking shed must be adequate for proper milking.
- (d) The working space in a milking shed is to be sufficient to minimise the risk of contamination of milk during milking.
- (e) Effluent from a holding yard and a milking shed is to be drained to a suitable point for disposal.
- (f) The requirements of (a), (b) and (c) are satisfied if—
 - (i) the walls are constructed of well-compacted smooth finish concrete or other material sealed to be impervious to moisture; and
 - (ii) the floors are constructed of well-compacted smooth finish concrete and graded to a drain; and
 - (iii) joints between wall sections and walls and floors are sealed to prevent entry of water and pests; and
 - (iv) artificial lighting is designed to comply with AS 1680.

Tas H107.3 Milk Receiving Area and Milk Storage Room

- (a) A Milk Receiving Area and Milk Storage Room must—
 - (i) have internal surfaces that are smooth, non-absorbent, free-draining and easy to clean; and
 - (ii) be constructed so as to prevent the entry of dust, insects, pests, birds and animals; and
 - (iii) have adequate artificial lighting that—

- (A) is located to provide a clear view of the milk for grading and measuring purposes; and
 - (B) the lights over a bulk vat are to be protected to prevent glass entering the vat if the light is broken; and
 - (C) have switches appropriately located at the milk collection areas; and
 - (iv) have adequate ventilation to aid the drying of floors and walls between milkings.
- (b) The requirements of (a) are satisfied if—
- (i) the floors are constructed of well-compacted smooth finish concrete and graded to a drain; and
 - (ii) the internal surfaces are smooth, sealed and washable; and
 - (iii) joints between wall sections and walls and floors are sealed to prevent entry of water and pests; and
 - (iv) artificial lighting is designed to comply with AS 1680; and
 - (v) all openings are fitted with doors, *windows* or screens; and
 - (vi) the milk is stored in a bulk storage tank which complies with AS 1187; and
 - (vii) ventilation is provided in accordance with **F4.5**.

Tas H107.4 Water supply

An adequate and suitable supply of water must be available for plant sanitation, teat washing, milk cooling and vat rinsing.

After Tas Part H107 insert Tas Part H108 as follows:

TAS PART H108 PHARMACIES

Tas H108.1 Application of Part

This Part applies to all pharmacy business premises registered under the *Pharmacy Control Act 2001*.

Pharmacies must be able to be secured against entry and the interior must be able to be supervised by a pharmacist.

Tas H108.2 Definition

In this Part the following meaning applies—

Dispensary means the room or area within a pharmacy or other premises which a registered pharmaceutical chemist uses for the compounding or dispensing of prescriptions, medicines or drugs.

Tas H108.3 Pharmacy premises

- (a) Each premises used as a pharmacy must have—
 - (i) a *dispensary* for the compounding or dispensing of drugs and for the storage of material used in dispensing; and

- (ii) space for the storage of narcotic substances and poisons as *required* by the *Poisons Regulations 1975*; and
 - (iii) a place for unpacking containers or cases and goods; and
 - (iv) a room for storing merchandise not used in dispensing.
- (b) A pharmacy may have an area set aside for retailing merchandise that is not compounded or dispensed.

Tas H108.4 Dispensary

- (a) A *dispensary* must be located—
- (i) within a pharmacy in a position to enable a person in the *dispensary* to supervise the *dispensary*, storage areas for narcotic substances and poisons, the entrances to unpacking areas and areas for storing other substances, and the retail area; and
 - (ii) separate from any place where goods are unpacked or where general merchandise, not used in dispensing, is stored.
- (b) Each *dispensary* must be provided with—
- (i) a sink and drainage board of impervious material moulded or manufactured in one piece; and
 - (ii) a reticulated supply of hot and a cold water capable of providing to the sink adequate quantities of water for dispensing purposes; and
 - (iii) space for a dispensing bench with a working area not less than 1.4 m².

Tas H108.5 Security of dispensary

- (a) Every *dispensary* and enclosure set aside for the storage of narcotic substances and poisons must be able to be secured against entry.
- (b) If a *dispensary* is located in a pharmacy that is capable of being secured against entry at all times while the *dispensary* is not in use, then the *dispensary* is deemed to be secured against entry.

After Tas Part H108 insert Tas Part H109 as follows:

TAS PART H109 HEALTH SERVICE ESTABLISHMENTS

Tas H109.1 Application of Part

- (a) This Part applies to health service establishments as defined in the Health Service Establishment Act 2006 including—
- (i) a day procedure centre; or
 - (ii) a private hospital; or
 - (iii) a residential care service building.
- (b) Health service establishments must be able to be easily cleaned and must have adequate space for patients.

Tas H109.2 Design and construction of health service establishments

Every health service establishment must be constructed and maintained in accordance with the Health Service Establishments Code.

TAS PART H110 * * * * *

This Part has been deliberately left blank.

TAS PART H111 * * * * *

This Part has been deliberately left blank.

After Tas Part H111 insert Tas Part H112 as follows:

TAS PART H112 MORTUARIES

Tas H112.1 Application of Part

This Part applies to any premises used for the storage or preparation for burial, cremation or disposal by other means, of bodies of deceased persons.

Mortuaries must be constructed in a manner that will ensure the health of staff and the general public.

Tas H112.2 Layout of mortuary

- (a) A mortuary may be integral with the remainder of a building but must be separated physically from all public areas of that building.
- (b) Each mortuary at which bodies are prepared for burial, cremation or other disposal must be provided with a body preparation room—
 - (i) capable of being isolated from the remainder of the premises; and
 - (ii) having a *floor area* not less than 10 m².
- (c) A vehicle reception area or garage must be provided adjacent to and with direct access to the storage room or body preparation room to ensure that the transfer of uncoffined bodies is screened from public view.
- (d) Access to toilet and shower facilities from any other part of the mortuary premises must be only by way of an air lock.

Tas H112.3 Construction of body preparation room

- (a) The floor must be—
 - (i) of impervious material with a smooth, unbroken surface; and
 - (ii) uniformly graded to a floor drain.
- (b) All walls and partitions must be of concrete or masonry with a smooth, unbroken finish for ease of cleaning.

- (c) All joints between the floor, walls, partitions, ceiling, ventilation grilles, fittings, pipework, *windows* and light fittings must be sealed with impervious material for ease of cleaning.
- (d) All joints between the floor and walls or partitions must be coved for ease of cleaning.
- (e) The body preparation room must be provided with at least one washbasin, fitted with elbow or foot-operated taps, and an adequate supply of hot and cold water.
- (f) The body preparation room must be provided with refrigerated storage facilities—
 - (i) with sufficient capacity for the storage of at least two adult bodies; and
 - (ii) capable of maintaining an internal temperature between 1° and 5°C.

Tas H112.4 Water supply and sewerage

Each mortuary with a body preparation room must be connected to—

- (a) a permanent water supply with a physical discontinuity, provided by a registered break tank or reduced pressure zone device, between the water supply and all equipment, appliances, fittings and areas in the mortuary; and
- (b) a water carriage sewerage system.

After Tas Part H112 insert Tas Part H113 as follows:

TAS PART H113 FOUNDRIES

Tas H113.1 Application of Part

This Part is applicable to every building or premises in which foundry operations are undertaken.

Foundries must provide for the comfort and safety of workers on the premises.

Tas H113.2 General

- (a) Every floor in a foundry must be level and, in places other than where molten metal is poured, must be composed of concrete or similar material or wooden blocks.
- (b) Every part of a foundry must be not less than 4.2 m high—
 - (i) where a ceiling is provided, measured from the floor to the ceiling; or
 - (ii) where a ceiling is not provided, measured from the floor to the lowest part of the roof.

Tas H113.3 Cupola charging platform

- (a) The floors of cupola charging platforms must be—
 - (i) of heavy timber or non-slip steel plate; and
 - (ii) securely fixed in position; and
 - (iii) level.
- (b) All parts of the cupola charging platform must be covered by a roof not less than 3 m above the platform.
- (c) A cupola charging platform must have—

- (i) a wall, not less than 1 m high, measured from the floor of the platform, constructed to surround the platform; and
 - (ii) the sides between the top of the wall and the roof suitably waterproofed and ventilated.
- (d) A properly constructed access stair or ramp must be provided to give access to every cupola charging platform and must comply with AS 1657.

Tas H113.4 Deep moulds and pits

Deep moulds or pits, for permanent use—

- (a) must be lined with bricks, concrete, or other suitable material in such a manner as to provide adequate reinforcement and to keep the pit or mould in a dry condition; and
- (b) must be securely fenced by means of a wall of adequate construction, railings or chains and stanchions raised, in each case, to a height not less than 1 m above the surface of the surrounding floor.

Tas H113.5 Pot furnaces

Where pot furnaces are below ground level, the pit must be covered by a substantial grating at the point at which metal is removed from the furnace, and must at all other points be securely fenced as in [Tas H113.4\(b\)](#).

After Tas Part H113 insert Tas Part H114 as follows:

TAS PART H114 PREMISES FOR MANUFACTURE OR PROCESSING OF GLASS REINFORCED PLASTICS

Tas H114.1 Application of Part

This Part is applicable to every building in which glass reinforced plastics are manufactured or processed.

Premises for manufacture or processing of glass reinforced plastic must—

- (a) provide for the safety and comfort of workers; and
- (b) be constructed in a manner that will avoid the spread of fire within the building and to other buildings.

Tas H114.2 Separation from other buildings

A building for manufacture or processing of glass fibre plastics must be—

- (a) separated from other buildings or parts of an occupancy by means of impervious walls with FRL at least 120/120/120; or
- (b) separated from all other buildings by a clear space of not less than 6 m.

Tas H114.3 Rise in storeys

The building must be of single *storey* construction.

Tas H114.4 Maximum floor areas

The *floor area* of any building or fire-separated section must not exceed the relevant maximum *floor area* set out in **Tas Table H114.4**.

Tas TABLE H114.4 MAXIMUM FLOOR AREA (m²) OF BUILDINGS FOR MANUFACTURE OR PROCESSING OF GLASS REINFORCED PLASTICS OR ISOCYANATES

	Type of construction of building—		
	Type A	Type B	Type C
Not Sprinklered	1500	1200	1000
Sprinklered	6000	5000	3000

Tas H114.5 Required exits

- (a) Each fire-separated section of a building which is a work place must have at least two *exits* for escape purposes and the number and location of the *exits* must be such that any point on the floor is not further than 20 m from one of the *exits*.
- (b) Only *exits* with vertically hinged swinging doors may be considered as *exits* for the purposes of this clause.

Tas H114.6 Hand laminating and spray depositing

The walls and floors of areas to be used for hand laminating and spray depositing must be constructed of *non-combustible* materials.

Tas H114.7 Ventilation

- (a) Mechanical or natural ventilation must be via low-level, exhaust ducting in a wall and a fixed, open, floor-level, fresh-air inlet ducting in the opposite wall such as to ensure a cross flow of the ventilation air over the complete working area.
- (b) Mechanical ventilation must provide not less than 6 air changes per hour.
- (c) The ventilation fan and exhaust ducting must be arranged in such a manner as to—
 - (i) produce a negative pressure within any exhaust ducting within the work place so that a leak in the ducting will not vent exhaust air back to the work place; and
 - (ii) vent the exhaust air to the atmosphere so as to prevent recirculation of that exhaust air.

Tas H114.8 Smoke and heat roof vents

Each fire-separated section must be provided with *automatic* smoke and heat roof vents.

After Tas Part H114 insert Tas Part H115 as follows:

TAS PART H115 PREMISES FOR PRODUCTION OR PROCESSING OF ISOCYANATES

Tas H115.1 Application of Part

This Part is applicable to every building in which isocyanate production or processing is undertaken.

Premises for the production or processing of isocyanates must—

- (a) provide for the safety and comfort of workers; and
- (b) be constructed in a manner that will avoid the spread of fire within the building and to other buildings.

Tas H115.2 Areas of work places

Work places in which an isocyanate industry is carried on must be divided into the following divisional areas:

- (a) Administration and staff amenities.
- (b) Workshop.
- (c) Bulk stores.
- (d) Curing room.
- (e) Processing plant.
- (f) Raw materials plant.
- (g) Manufacture.

Tas H115.3 Separation from other areas and buildings

- (a) Each of the divisional areas *required* by **Tas H115.2** other than the administration and staff amenities building, must be—
 - (i) separated from each of the other divisional areas by means of an impervious wall with an FRL not less than 120/120/120; or
 - (ii) separated from all other buildings by a clear space of not less than 6 m.
- (b) Notwithstanding the distance requirements of **(a)**, bulk stores of polyols and bulk stores of isocyanates must comply with the requirements of the *Work Health and Safety Act 2012*.

Tas H115.4 Rise in storeys

The building must be of single *storey* construction.

Tas H115.5 Maximum floor areas

The *floor area* of any building or fire-separated section must not exceed the area shown in **Tas Table H114.4**.

Tas H115.6 Required exits

- (a) Every building or divisional area of a work place must have not less than 2 *exits* for escape purposes.

- (b) The number and location of the *exits* must be such that any point on the floor is not more than 20 m from one of the *exits*.
- (c) Only *exits* with vertically hinged swinging doors may be considered as *exits* for the purposes of this clause.

Tas H115.7 Bulk stores for polyols and isocyanates

- (a) A bulk store for polyols must be constructed from *non-combustible* materials and have a smooth impervious concrete floor and it must protect the polyols from direct exposure to the sun's radiation.
- (b) A bulk store for isocyanates must—
 - (i) be constructed from *non-combustible* materials, have a smooth impervious concrete floor, and must protect the isocyanate containers from direct exposure to the sun; and
 - (ii) if it is used for storage of either TDI or HDI and is not an open sided building, be fitted with mechanical ventilation so that the TLV is not exceeded at any time provided that the ventilation must provide not less than 6 air changes per hour.
- (c) The area around both a polyol bulk store and an isocyanate bulk store must be bunded, the bund or bunds must ensure separation of the polyol and isocyanate areas and each bund must have a capacity of 10% more than the storage capacity of the largest tank it protects.

Tas H115.8 Curing room

The curing room for the storage of newly produced flexible polyurethane foam must be constructed of *non-combustible* materials with a smooth impervious concrete floor and fitted *automatic* fire vents in the roof.

After Tas Part H115 insert Tas Part H116 as follows:

TAS PART H116 PREMISES FOR ELECTRO-PLATING ELECTRO-POLISHING, ANODISING OR ETCHING

Tas H116.1 Application of Part

This Part is applicable to every building where any of the processes of electro-plating, electro-polishing, anodising or etching are undertaken.

Premises for electro-plating, electro-polishing, anodising or etching must—

- (a) provide for the safety and comfort of workers; and
- (b) be constructed in a manner that will prevent the escape of liquids and atmospheric contaminants to other areas of the building.

Tas H116.2 Floors

The floor of every plating area must be—

- (a) so graded as to—
 - (i) permit easy flushing with water; and

- (ii) prevent liquids from flowing from the area into other parts of the work place; and
- (b) chemically resistant to the solutions used in the process.

Tas H116.3 Height of plating area

Every part of a plating area must be not less than 2.7 m in height—

- (a) measured from the floor to the ceiling if a ceiling is provided; or
- (b) measured from the floor to the lowest part of the roof if a ceiling is not provided.

Tas H116.4 Air space

In every plating area there must be not less than 14 m³ of air space for each person employed and, in the calculation of such space, the height taken into account must not exceed 4.2 m.

Tas H116.5 Ceiling construction

The ceiling of a plating area must be so constructed as to prevent, so far as is practicable, atmospheric contaminants from escaping into rooms or work places, situated above the level of the ceiling.

After Tas Part H116 insert Tas Part H117 as follows:

TAS PART H117 PREMISES FOR LEAD PROCESSING

Tas H117.1 Application of Part

This Part is applicable to every building in which lead processes are used.

Premises for lead processing must—

- (a) provide for the safety and comfort of workers; and
- (b) be constructed in a manner that will minimise the lodgement of dust and must be capable of being flushed with water.

Tas H117.2 Floors

- (a) The floor of every work place where a lead process is used must be—
 - (i) so constructed of concrete or other suitable material as to be smooth and impervious to fluids; and
 - (ii) graded and properly drained to permit flushing with water.
- (b) The material of which the floor is constructed must be applied to the walls to a height of not less than 75 mm in such a fashion that the angle between the walls and the floor is coved for easy cleaning.

Tas H117.3 Height of lead processing areas

Every part of a lead processing area must be not less than 2.7 m in height—

- (a) where a ceiling is provided, measured from the floor to the ceiling; or
- (b) where a ceiling is not provided, measured from the floor to the lowest part of the roof.

Tas H117.4 Air space and floor space

- (a) In every lead processing area there must be not less than 14 m³ of air space for each person employed therein, and in the calculation of such space the maximum height taken must be not greater than 4.2 m; and
- (b) total floor space for the persons employed in such area, exclusive of space used for storage, must be not less than 3.3 m² for each person so employed.

Tas H117.5 Interior of lead processing areas

- (a) The inner surfaces of the walls of every lead processing area must be of a smooth material impervious to fluids and must not contain any projections on which dust may lodge; and
- (b) the interior construction of the ceiling or roof must, so far as is practicable, be such that dust will not settle on it.

Tas H117.6 Dust collection

Any areas in which dust-forming lead materials are manipulated, moved or treated must be served by a mechanical exhaust ventilation system capable of safely and effectively collecting all dust.

Tas H117.7 Isolation of certain processes

Where any process of pasting of electric accumulator plates or drying of paste plates, or melting down of pasted plates or of formation with tacking in the electric accumulator industry or of manipulation of dry oxide of lead, is to be carried on in the same room as any other lead process, the processes of pasting, drying, melting, formation or manipulation must be isolated from one another and from any other lead process—

- (a) by a partition extending from the floor to the ceiling in the case of a room having a ceiling not more than 3.6 m in height, or to a height of 2.7 m in any other case; or
- (b) by some other suitable method.

Tas H117.8 Drying room shelves

The racks or shelves provided in any drying room must not be more than 2.6 m from the floor nor more than 650 mm in width except that, in the case of racks or shelves set or drawn from both sides, the total width must not exceed 1.3 m.

Tas H117.9 Washing facilities

Washing facilities served with running hot and cold water for the use of all employees engaged in a lead process must be provided consisting of—

- (a) one washbasin for each 5 employees, or part thereof; and
- (b) one shower bath for each 8 employees, or part thereof.

Tas H117.10 Change rooms

In every work place in which lead is processed there must be provided two suitable furnished change rooms for the use of employees as follows—

- (a) one of the change rooms must be used for taking off, storing, and putting on of the street clothing of employees; and
- (b) the other of the change rooms must be used for the taking off, storing, and putting on of overalls and other clothing worn in any work room; and
- (c) each change room must be so constructed and situated as to prevent the entry into the room of dust or fumes generated in a workroom; and
- (d) each change room must be in close proximity to the washing facilities *required* in **Tas H117.9**.

TAS PART H118 * * * * *

This Part has been deliberately left blank.

TAS PART H119 * * * * *

This Part has been deliberately left blank.

TAS PART H120 * * * * *

This Part has been deliberately left blank.

TAS PART H121 * * * * *

This Part has been deliberately left blank.

After Tas Part H121 insert Tas Part H122 as follows:

TAS PART H122 EARLY CHILDHOOD CENTRES AND SCHOOL AGE CARE FACILITIES

PERFORMANCE REQUIREMENTS

Tas H122 P1

The design and construction of an *early childhood centre* and *school age care facility* must to the degree necessary, provide an environment that is spacious enough to prevent overcrowding, and supports a range of daily activities and routines including—

- (a) indoor playing; and
- (b) outdoor playing; and
- (c) sleeping.

Tas H122 P2

An *early childhood centre* and *school age care facility*, must to the degree necessary, have sufficient space and facilities to ensure a healthy, safe and comfortable environment for children, staff and parents including—

- (a) sanitary facilities; and
- (b) nappy changing facilities; and
- (c) laundry facilities; and
- (d) food preparation facilities; and
- (e) reception, administration and staff facilities; and
- (f) storage facilities; and
- (g) suitable—
 - (i) floor surfaces; and
 - (ii) lighting and ventilation; and
 - (iii) fire safety provisions; and
 - (iv) windows and glazing; and
 - (v) heating and cooling.

Tas H122 P3

An *early childhood centre* and *school age care facility* must to the degree necessary, have fencing around the perimeter of any outdoor play space, and any identified hazard isolated by fences, barriers and gates.

Application:

Tas H122 P1 to **Tas H122 P3** apply to *early childhood centres* and *school age care facilities* approved under the *Education and Care Services National Law (Application) Act 2011* or licensed under the *Child Care Act 2001*.

DEEMED-TO-SATISFY PROVISIONS

Tas H122.0 Application of Part

This Part applies to *early childhood centres* and *school age care facilities* approved under the *Education and Care Services National Law (Application) Act 2011* or licensed under the *Child Care Act 2001*.

Tas H122.1 Deemed-to-Satisfy Provisions

- (a) *Performance Requirement Tas H122 P1* is satisfied by complying with the relevant provisions of the Early Childhood Centre and School Age Care Facilities Code.
- (b) *Performance Requirement Tas H122 P2* is satisfied by complying with the relevant provisions of the Early Childhood Centre and School Age Care Facilities Code.

- (c) *Performance Requirement Tas H122 P3* is satisfied by complying with the relevant provisions of the Early Childhood Centre and School Age Care Facilities Code.

After Tas Part H122 insert Tas Part H123 as follows:

TAS PART H123 TEMPORARY STRUCTURES

PERFORMANCE REQUIREMENTS

Tas H123 P1

A *temporary structure* must, to the degree necessary, be capable of sustaining at an acceptable level of safety and serviceability the most adverse combination of loads and other actions to which it may reasonably be expected to be subjected.

Tas H123 P2

The material used in a *temporary structure* must, to the degree necessary, be capable of resisting the spread of fire to limit the generation of smoke and heat, and any toxic gases likely to be produced.

Tas H123 P3

- (a) Access must be provided to the degree necessary, to enable safe, equitable and dignified movement of people to and within a *temporary structure*.
- (b) So that people can move safely to and within a *temporary structure*, it must have—
- (i) walking surfaces with safe gradients; and
 - (ii) stairways and ramps with slip-resistant walking surfaces; and
 - (iii) suitable handrails where necessary to assist and provide stability to people using a stairway or ramp.
- (c) Access for people with disabilities must be provided to and within a *temporary structure*, including to any public sanitary facilities and all areas normally used by the *public*.
- (d) If fixed seating is provided in a *temporary structure*, an appropriate number of wheelchair spaces must be provided.

Tas H123 P4

- (a) *Exits* must be provided to the degree necessary, from a *temporary structure* to enable the safe evacuation of occupants, with their number, location and dimensions being appropriate to the—
- (i) travel distances to *exits*; and
 - (ii) number, mobility and other characteristics of the occupants; and
 - (iii) function or use of the structure.
- (b) So that occupants can safely evacuate a *temporary structure*, paths of travel to *exits* must have dimensions appropriate to the—

- (i) number, mobility and other characteristics of the occupants; and
- (ii) function or use of the structure.

Tas H123 P5

Where a person could fall 1 m or more, due to a sudden change of level within or associated with a *temporary structure*, a barrier must to the degree necessary, be provided which must be—

- (a) continuous and extend for the full extent of the hazard; and
- (b) of a height to protect the people from accidentally falling from the level; and
- (c) constructed to prevent the people from falling through the barrier; and
- (d) capable of restricting the passage of children; and
- (e) of strength and rigidity to withstand the foreseeable impact of the people and where appropriate, the static pressure of the people pressing against it.

Tas H123 P6

A level of illumination for safe evacuation from a *temporary structure* in an emergency must be provided, to the degree necessary, appropriate to the—

- (a) function or use of the structure; and
- (b) size of the structure; and
- (c) distance of travel to an *exit*.

Tas H123 P7

To facilitate evacuation from a *temporary structure* suitable signs or other means of identification must, to the degree necessary—

- (a) be provided to identify the location of *exits*; and
- (b) guide the occupants to *exits*; and
- (c) be clearly visible to the occupants; and
- (d) operate in the event of power failure for sufficient time for the occupants to safely evacuate.

Tas H123 P8

Fire equipment must be installed in a *temporary structure* to the degree necessary, to allow the occupants to undertake initial attack on a fire appropriate to the—

- (a) function or use of the structure; and
- (b) fire hazard.

Tas H123 P9

Sanitary facilities for personal hygiene must be provided in a convenient location associated with a *temporary structure*, to the degree necessary, appropriate to the—

- (a) function or use of the structure; and
- (b) number and gender of the occupants; and

- (c) disability or other particular needs of the occupants.

Tas H123 P10

A *temporary structure* must be provided with natural or artificial lighting to enable the safe use and movement of people using the structure. Lighting must be installed to the degree necessary, to provide a level of illumination appropriate to the function or use of a *temporary structure* to enable safe use and movement by the occupants.

Tas H123 P11

A *temporary structure* must be provided with a means of ventilation which will maintain adequate air quality. Ventilation must be provided to the degree necessary, to a level appropriate to the function or use of a *temporary structure*.

Tas H123 P12

Electrical services must be installed to the degree necessary, to provide a level of safety appropriate to the environment and function or use of a *temporary structure* by the occupants.

Tas H123 P13

Where provided in a *temporary structure*, a heating appliance and its associated components must be installed to the degree necessary—

- (a) to withstand the temperatures likely to be generated by the appliance; and
- (b) so that it does not raise the temperature of any structural element to a level that would adversely affect the element's physical or mechanical properties or function; and
- (c) so that hot products of combustion will not—
 - (i) escape through the walls of the associated components; and
 - (ii) discharge to a position that will cause fire to spread to nearby combustible materials or allow smoke to penetrate the *temporary structure*; and
- (d) to reduce the likelihood of fire and harmful emissions spreading beyond the appliance.

Tas H123 P14

A *temporary structure* of tiered seating must be designed and constructed to the degree necessary, to provide for the safety of the occupants and orderly means of evacuation in an emergency.

Tas H123 P15

A *temporary structure* must, to the degree necessary, be a safe and hazard free environment for the people using the structure.

Application:

Tas H123 P1 to P15 only applies to a *temporary structure* that—

- (a) is used by the *public* as a place of assembly as described in the *Public Health Act 1997*; and
- (b) is a *temporary structure* as described in the *Building Act 2000*.

DEEMED-TO-SATISFY PROVISIONS

Tas H123.0 Application of Part

This Part only applies to a *temporary structure* that—

- (a) is used by the *public* as a place of assembly as described in the *Public Health Act 1997*; and
- (b) is a *temporary structure* as described in the *Building Act 2000*.

Tas H123.1 Deemed-to-Satisfy Provisions

Performance Requirements Tas H123 P1 to *Tas H123 P14* are satisfied by complying with the provisions of the ABCB Temporary Structures Standard, except for the following:

- (a) Disability access requirements, which are included in **Tas H123.4**.
- (b) Lighting requirements, which are included in **Tas H123.11**.
- (c) Ventilation requirements, which are included in **Tas H123.12**.
- (d) Electrical requirements, which are included in **Tas H123.13**.
- (e) Heating appliance requirements, which are included in **Tas H123.14**.

Tas H123.2 * * * * *

Tas H123.3 * * * * *

Tas H123.4 Access

- (a) Access for people with disabilities must be provided to and within a *temporary structure* by means of a continuous path of travel.
- (b) Access for people with disabilities must be provided to—
 - (i) any public sanitary facilities; and
 - (ii) all areas normally used by the *public* but excluding those areas only used by persons working in the *temporary structure*.
- (c) If fixed seating is provided, in a *temporary structure*, wheelchair spaces must be provided not less than—
 - (i) 1 wheelchair space for up to 100 seats; and
 - (ii) 2 wheelchair spaces for 100 - 200 seats; and
 - (iii) an additional wheelchair space for each additional 200 seats or part thereof.
- (d) Parts of the *temporary structure* required to be accessible must comply with AS 1428.1.

Tas H123.5 * * * * *

Tas H123.6 * * * * *

Tas H123.7 * * * * *

Tas H123.8 * * * * *

Tas H123.9 * * * * *

Tas H123.10 * * * * *

Tas H123.11 Lighting

- (a) Natural or artificial lighting must be provided to all enclosed areas in a *temporary structure*.
- (b) Natural lighting must as far as practicable be not less than 10% of the floor area of the enclosed area.
- (c) The artificial lighting system must as far as practicable comply with the relevant provisions of AS 1680 Parts 1, 2.0, 2.1, 2.2 and 2.3.

Tas H123.12 Ventilation

- (a) Natural ventilation or mechanical ventilation must be provided to all enclosed areas in a *temporary structure*.
- (b) Natural ventilation must as far as is practicable consist of openings or devices which can be opened with an aggregate opening of not less than 5% of the floor area of the enclosed area.
- (c) Mechanical ventilation must as far as practicable comply with the relevant provisions of AS 1668.2.

Tas H123.13 Electrical

All electrical installations in a *temporary structure* must be installed in accordance with AS/NZS 3000.

Tas H123.14 Heating appliances

The installation of a stove, heater or similar appliance in a *temporary structure* must as far as practicable comply with the following standards:

- (a) Domestic oil-fired appliances – Installation: AS 1691.
- (b) Domestic solid-fuel burning appliances – Installation: AS/NZS 2918.
- (c) L P gas portable mobile appliances: AS 2658.

Tas H123.15 * * * * *

After Tas Part H123 insert Tas Part H124 as follows:

TAS PART H124 PREMISES WHERE WORK IS UNDERTAKEN ON GAS-FUELLED VEHICLES

Tas H124.1 Application of Part

This Part is applicable to every building where work is undertaken on gas-fuelled vehicles.

Tas H124.2 Working areas

The working area of a building where work is undertaken on a gas-fuelled vehicle is to be designed and constructed to comply with the requirement for premises in AS 2746 Working areas for gas-fuelled vehicles.

Footnote: OTHER LEGISLATION AFFECTING BUILDINGS

In addition to any applicable provisions of the Building Act 2000 and other legislative and regulatory instruments under that Act, such as regulations, codes (including this Code) and standards there are a number of other legislative technical requirements, and regulatory instruments affecting the design, construction and/or performance of buildings that practitioners may need to be aware of, including but not necessarily limited to, the following list. Additional legislative and regulatory instruments such as regulations, codes and standards may exist under the legislation and regulatory instruments listed.

1. Work Places

1.1 Administering agency

WorkSafe Tasmania – Department of Justice

Relevant legislation and regulatory instruments

Work Health and Safety Act 2012

Code of Practice – Managing Risks of Hazardous Chemicals in the Workplace – WorkSafe Tasmania publication CP120

Code of Practice – Managing the Work Environment and Facilities – WorkSafe Tasmania publication CP124

Code of Practice – Safe Design of Structures – WorkSafe Tasmania publication CP128

VICTORIA

INTRODUCTION

This Appendix contains variations and additions to the Building Code of Australia (BCA) provisions which are considered necessary for the effective application of the Code in Victoria and shall be treated as amendments to the Code.

APPENDIX CONTENTS

APPENDIX VICTORIA

Victoria

A GENERAL PROVISIONS

Vic A1.1 Definitions
Vic Specification A1.3 Standards Adopted by Reference

B STRUCTURE

Vic B1.6 Construction of buildings in flood hazard areas

C FIRE RESISTANCE

Vic C1.10 Fire hazard properties

D ACCESS AND EGRESS

Vic D1.4 Exit travel distances
Vic D1.6 Dimensions of exits and paths of travel to exits
Vic D2.21 Operation of latch

E SERVICES AND EQUIPMENT

Vic Table E1.5 Requirements for Sprinklers
Vic Specification E1.5 Fire Sprinkler Systems
Vic Specification E2.2a Smoke Detection and Alarm Systems

F HEALTH AND AMENITY

Vic FP2.2 Performance Requirements
Vic F2.0 Deemed-to-Satisfy Provisions
Vic F2.3 Facilities in Class 3 to 9 buildings
Vic Table F2.3 Sanitary Facilities in Class 3, 5, 6, 7, 8 and 9 Buildings
Vic F2.5 Construction of sanitary compartments
Vic F2.101 First aid rooms
Vic FP3.1 Performance Requirements
Vic F3.0 Deemed-to-Satisfy Provisions
Vic F3.101 Childrens services - size of rooms
Vic F3.102 Class 3 buildings - size of rooms
Vic F3.103 Class 3, 9a and 9c residential aged care buildings - size of rooms
Vic F4.1 Provision of natural light
Vic F4.2 Methods and extent of natural lighting

G ANCILLARY PROVISIONS

Vic GP1.2 Performance Requirements
Vic G1.1 Swimming pools

H SPECIAL USE BUILDINGS

Vic Part H101 CLASS 3, CLASS 9a and CLASS 9c RESIDENTIAL AGED CARE BUILDINGS

- Vic HP101.1 - HP101.3 Performance Requirements
- Vic H101.0 Deemed-to-Satisfy Provisions
- Vic H101.1 Application of Part
- Vic H101.2 Doorway width
- Vic H101.3 Windows
- Vic H101.4 Grab rails
- Vic H101.5 Heated water temperature
- Vic H101.6 Electronic communications system
- Vic H101.7 Electrical power outlets

Vic Part H102 PLACES OF PUBLIC ENTERTAINMENT

- Vic HP102.1 - HP102.3 Performance Requirements
- Vic H102.0 Deemed-to-Satisfy Provisions
- Vic H102.1 Application of Part
- Vic H102.2 Temporary tiered seating, concourses and embankments
- Vic H102.3 Motor vehicle racing
- Vic H102.4 Sanitary and amenity facilities

Vic Part H103 FIRE SAFETY IN CLASS 2 AND CLASS 3 BUILDINGS

- Vic H103.1 Fire safety in Class 2 and Class 3 buildings

Vic Part H104 CLASS 9b CHILDREN'S SERVICES

- Vic HP104.1 Performance Requirements
- Vic H104.0 Deemed-to-Satisfy Provisions
- Vic H104.1 Application of Part
- Vic H104.2 Doorways to a children's room

Footnote: Other Legislation Affecting Buildings

SECTION A GENERAL PROVISIONS

PART A1 INTERPRETATION

Vary A1.1 as follows:

Vic A1.1 Definitions

Add the definition of "*children's service*" as follows:

Children's service has the same meaning as it has under the Children's Services Act 1996, but excludes a service where education and care is primarily provided to school aged children.

Substitute the definition of "*early childhood centre*" as follows:

Early childhood centre means—

- (a) any premises, or part thereof, providing or intending to provide a centre-based education and care service within the meaning of the Education and Care Services National Law Act 2010, and the Education and Care Services National Regulations, excluding a service where education and care is primarily provided to school aged children; and
- (b) a *children's service*.

Substitute the definition of "**flood hazard area**" as follows:

Flood hazard area means the *site* (whether or not mapped) encompassing land in an area liable to flooding within the meaning of regulation 802 of the Building Regulations 2006.

Substitute the definition of "**freeboard**" as follows:

Freeboard means the minimum height of the level of the lowest floor of a building above the *defined flood level*, regulated by the relevant planning scheme, or specified or otherwise determined by the relevant council under Regulation 802 of the Building Regulations 2006.

Add the definition of "*hotel offering shared accommodation*" as follows:

Hotel offering shared accommodation means a hotel which has any *sole-occupancy units* that can be shared by unrelated persons.

Add the definition of "*residential care building*" as follows:

Residential care building means a building which is a place of residence where 10% or more of persons who reside there need physical assistance in conducting their daily activities and to evacuate the building during an emergency (including any residential care service, State funded residential care service or supported residential service as defined in the Supported Residential Services (Private Proprietors) Act 2010 and an *aged care building*) but does not include—

- (a) a hospital; or
- (b) a dwelling in which 2 or more members of the same family and not more than 2 other persons would ordinarily be resident; or
- (c) a place of residence where only one resident needs physical assistance in conducting their daily activities and to evacuate the building during an emergency.

Add the definition of "*restricted children's service*" as follows:

Restricted children’s service means a *children’s service* that is—

- (a) a limited hours Type 1 service; or
- (b) a limited hours Type 2 service; or
- (c) a short term Type 1 service; or
- (d) a short term Type 2 service,

as defined in the Children’s Services Regulations 2009; or

- (e) an associated children’s service within the meaning of the Children’s Services Act 1996 approved to be operated by an approved provider at the same place as an approved education and care service that is required to meet the conditions of a limited hours Type 1 service, a limited hours Type 2 service, a short term Type 1 service, or a short term Type 2 service.

Add the definition of “*shared accommodation building*” as follows:

Shared accommodation building means a Class 3 building having—

- (a) more than one *sole-occupancy unit* of which any *sole-occupancy unit* has sleeping facilities capable of accommodating 3 or more unrelated persons; or
- (b) sleeping facilities capable of accommodating 13 or more unrelated persons,

that is a boarding-house, chalet, guest house, lodging-house, backpacker accommodation or the like, or a residential part of a *hotel offering shared accommodation* but does not include a *residential care building*, a motel or a residential part of a *school*, *health-care building* or detention centre.

Insert in Table 1 of Specification A1.3 the following additional and revised clause references and additional documents:

VIC Specification A1.3 STANDARDS ADOPTED BY REFERENCE

Vic Table 1 SCHEDULE OF REFERENCED DOCUMENTS

No.	Date	Title	BCA Clause(s)
AS 1428		Design for access and mobility	
Part 1	2009	General requirements for access — New building work Amdt 1	Vic H101.4
AS 1926		Swimming pool safety	
Part 1	1993	Fencing for swimming pools Amdt 1	Vic G1.1(a)
Part 2	1995	Location of fencing for private swimming pools	Vic G1.1(a)
AS 2118		Automatic fire sprinkler systems	
Part 1	1999	General requirements	Vic Spec E1.5

Vic Table 1 SCHEDULE OF REFERENCED DOCUMENTS — continued

No.	Date	Title	BCA Clause(s)
		Amdt 1	
Part 4	2012	Sprinkler protection for accommodation buildings not exceeding four storeys in height	Vic Spec E1.5, Vic H103.1
Part 6	2012	Combined sprinkler and hydrant systems in multistorey buildings	Vic Spec E1.5
ABCB	2012	Standard for Construction of Buildings in Flood Hazard Areas, Version 2012.2	Vic B1.6
CAMS—Track operator’s safety guide			
Edition 2	June 1993	Confederation of Australian Motor Sport	Vic H102.3
Residential fire safety systems			
Practice Note 2008–07	May 2008	Victorian Building Authority	Vic Spec E2.2a, Vic H103.1
Emergency communication systems			
Practice Note 2014–08	May 2014	Victorian Building Authority	Vic H103.1

SECTION B STRUCTURE

PART B1 STRUCTURAL PROVISIONS

Substitute B1.6 as follows:

Vic B1.6 Construction of buildings in flood hazard areas

- A Class 2 or 3 building, Class 9a *health-care building*, Class 9c building or Class 4 part of a building, in a *flood hazard area* must comply with the ABCB Standard for Construction of Buildings in Flood Hazard Areas.
- The definitions of *flood hazard area* and *freeboard* in the ABCB Standard for Construction of Buildings in Flood Hazard Areas are replaced with those in **Vic A1.1**.
- The definition of *defined flood level* in the ABCB Standard for Construction of Buildings in Flood Hazard Areas is replaced with that in **A1.1**.

SECTION C Fire Resistance

PART C1 Fire Resistance and Stability

Delete C1.10(c)(xv) as follows:

Vic C1.10 Fire hazard properties

- (c) The requirements of (a) do not apply to a material or assembly if it is—
(xv) * * * * *

SECTION D ACCESS AND EGRESS

PART D1 PROVISION FOR ESCAPE

Substitute the lead-in to D1.4(d) as follows:

Vic D1.4 Exit travel distances

- (d) **Class 9 buildings** — in a *patient care area* in a Class 9a building and in a *children's service*—

Delete D1.6(f)(iv) as follows:

Vic D1.6 Dimensions of exits and paths of travel to exits

- (f)
(iv) (Deleted)

PART D2 CONSTRUCTION OF EXITS

Substitute D2.21 (a) as follows:

Vic D2.21 Operation of latch

- (a) A door in a *required exit*, forming part of a *required exit* or in the path of travel to a *required exit* must be readily openable without a key from the side that faces a person seeking egress, by—
- (i) a single hand downward action on a single device which is located between 900 mm and 1.1 m from the floor and if serving an area *required* to be *accessible* by **Part D3**—
 - (A) be such that the hand of a person who cannot grip will not slip from the handle during the operation of the latch; and
 - (B) have a clearance between the handle and the back plate or door face at the centre grip section of the handle of not less than 35 mm and not more than 45 mm; or
 - (ii) a single hand pushing action on a single device which is located between 900 mm and 1.2 m from the floor,

except that an exit door from a *children's service* which does not open to an outdoor space enclosed in accordance with **G1.3**, must have the device located between 1.5 m and 1.65 m above the floor and the door must be *self-closing*.

SECTION E SERVICES AND EQUIPMENT

PART E1 FIRE FIGHTING EQUIPMENT

Add references to *shared accommodation building* and *residential care building* in **Table E1.5** and substitute Note 4 of **Table E1.5** as follows:

VIC Table E1.5 REQUIREMENTS FOR SPRINKLERS

Occupancy	When sprinklers are required
<i>Residential care building</i> other than— (a) a Class 3 building used as a <i>residential aged care building</i> ; and (b) a Class 9a <i>health care building</i> used as a <i>residential aged care building</i> ; and (c) a Class 9c building.	Throughout the building.
<i>Shared accommodation building</i>	Throughout the building.
4. For the purposes of this Table, occupancies of excessive <i>fire hazard</i> comprise buildings which contain— <ul style="list-style-type: none"> (a) hazardous process risks including the following: <ul style="list-style-type: none"> (i) Aircraft hangars. (ii) Electrical/electronic manufacturing and assembly (predominantly plastic components). (iii) Fire-lighter manufacturing. (iv) Fireworks manufacturing. (v) Flammable liquid spraying. (vi) Foam plastic goods manufacturing and/or processing. (vii) Foam rubber goods manufacturing and/or processing. (viii) Hydrocarbon based sheet product manufacturing and/or processing. (ix) Nitrocellulose and nitrocellulose goods manufacturing. (x) Paint and varnish works, solvent based. (xi) Plastic goods manufacturing and/or processing works. (xii) Resin and turpentine manufacturing. (xiii) Vehicle repair shops. 	

VIC Table E1.5 REQUIREMENTS FOR SPRINKLERS — continued

Occupancy	When sprinklers are required
(b)	combustible goods with an aggregate volume exceeding 2000 m ³ and stored to a height greater than 4 m such as the following: <ul style="list-style-type: none"> (i) Aerosol packs with flammable contents. (ii) Cartons and associated packing material excluding cartons with densely packed non-combustible content. (iii) Electrical appliances where the components are predominantly plastic. (iv) Foamed rubber or plastics including wrappings or preformed containers. (v) Paper products. (vi) Plastic, rubber, vinyl and other sheets in the form of offcuts, random pieces or rolls. (vii) Textiles raw and finished. (viii) Timber products.

Substitute Clause 2 of Specification E1.5 as follows:

Vic Specification E1.5 FIRE SPRINKLER SYSTEMS

2. Adoption of AS 2118

- (a) for a Class 5, 6, 7, 8 or 9b building: AS 2118.1; or
- (b) for a Class 2, 3, 4, 9a or 9c building: AS 2118.1, except clause 5.6.13 of AS 2118.1 does not apply and is replaced with 'Covered balconies shall be sprinkler protected.'; or
- (c) for a Class 2 or 3 building or a *residential care building* other than a Class 9a *health-care building* used as a *residential aged care building* or a Class 9c building: AS 2118.4 as applicable; or
- (d) for a combined sprinkler and fire hydrant system: AS 2118.6; or
- (e) for a Class 9a *health care building* used as a *residential aged care building*: AS 2118.4 as applicable; or
- (f) for a Class 9c building: AS 2118.4 as applicable.

Substitute Clause 4(e) of Specification E2.2a as follows:

Vic Specification E2.2a SMOKE DETECTION AND ALARM SYSTEMS

4. Smoke detection system

- (e) In a Class 9c building—
 - (i) if the building accommodates more than 20 residents, manual call points must be installed in paths of travel so that no point on a floor is more than 30 m from a manual call point; and
 - (ii) indication of the zone where the smoke detection system has actuated must be achieved by one of the following:

- (A)
 - (aa) remote automatic indication of each zone must be given in each smoke compartment; and
 - (bb) indication of (aa) must be indicated on remote annunciator panels with alpha-numeric displays with a minimum of 20 characters of 9 mm minimum height; or
- (B)
 - (aa) indication of the zone where the smoke detection system has actuated must be communicated via a suitable interface with the fire indicator panel to a portable remote communication device; and
 - (bb) at least one such portable remote communication device per smoke compartment must be provided to staff nominated by the owner or operator and properly instructed as to the duties and responsibilities involved; and
 - (cc) the portable remote communication device may be a pager with alpha-numeric display or portable telephone handset with capability of receiving alpha-numeric display.

Substitute Clause 7(b) and (c) of Specification E2.2a as follows:

7. System monitoring

- (b) A smoke detection system in a Class 9a *health-care building*, if the building accommodates more than 20 patients, unless the building is sprinklered and the sprinkler system is permanently connected to a fire station, or other approved monitoring service with a direct data link to a fire station, in accordance with Practice Note 2008-07.
- (c) (deleted).

SECTION F HEALTH AND AMENITY

PART F2 SANITARY AND OTHER FACILITIES

Substitute application of *Performance Requirement* FP2.2 as follows:

PERFORMANCE REQUIREMENTS

Application:

FP2.2 only applies to—

- (a) a Class 2 building or a Class 4 part of a building; and
- (b) a Class 9a *health-care building*; and
- (c) a Class 9c building; and
- (d) an *early childhood centre* other than a *restricted children's service*.

Substitute Vic F2.0 as follows:

DEEMED-TO-SATISFY PROVISIONS

Vic F2.0 Deemed-to-Satisfy Provisions

Performance Requirements FP2.1 to *FP2.6* are satisfied by complying with *F2.1* to *F2.8* and *Vic F2.101*.

Substitute F2.3(g) as follows:

Vic F2.3 Facilities in Class 3 to 9 buildings

- (g) A Class 9b *early childhood centre*, other than a *children's service*, must be provided with—
- (i) a kitchen or food preparation area with a kitchen sink, separate hand washing facilities, space for a refrigerator and space for cooking facilities, with—
 - (A) the facilities protected by a door or gate with child proof latches to prevent unsupervised access to the facilities by children younger than 5 years old; and
 - (B) the ability to facilitate supervision of children from the facilities if the *early childhood centre* accommodates children younger than 2 years old; and
 - (ii) one bath, shower or shower-bath; and
 - (iii) if the centre accommodates children younger than 3 years old—
 - (A) a laundry facility comprising a washtub and space in the same room for a washing machine; and
 - (B) a bench type baby bath, which is within 1 m of the nappy change bench; and
 - (C) a nappy changing bench which—
 - (aa) is within 1 m of separate adult hand washing facilities and bench type baby bath; and
 - (bb) must be not less than 900 mm² in area and at a height of not less than 850 mm, but not more than 900 mm above the finished floor level; and
 - (cc) must have a space not less than 800 mm high, 500 mm wide and 800 mm deep for the storage of steps; and
 - (dd) is positioned to permit a staff member changing a nappy to have visibility of the play area at all times.
- (ga) A *children's service* must be provided with—
- (i) a kitchen or facilities for the preparation and cooking of food for children including washing up facilities and a space for refrigerated food storage facilities; and
 - (ii) except in a *restricted children's service*, if the service accommodates children younger than 3 years of age—
 - (A) a laundry facility comprising a washtub and space in the same room for a washing machine; and

- (B) a bench-type baby bath, with hot and cold water connected, and a nappy change bench in close proximity; and
- (iii) except in a *restricted children's service*, one bath or shower-bath.

Vary Table F2.3 as follows:

Vic Table F2.3 Sanitary Facilities in Class 3, 5, 6, 7, 8 and 9 Buildings

User Group	Closet Pans		Urinals		Washbasins	
	Design Occupancy	Number	Design Occupancy	Number	Design Occupancy	Number
Class 9b — <i>early childhood centre</i>						
Children	1 — 30	2			1 — 30	2
	> 30	Add 1 per 15			>30	Add 1 per 15

Note:

Facilities for use by children must be—

- (a) junior closet pans, except that those in a *restricted children's service* may be adult height toilets if they are fitted with a removable seat suitable for children and a wide and stable step in front; and
- (b) washbasins with a rim height not exceeding 600 mm, except that those in a *restricted children's service* may be adult height washbasins if they are provided with a wide and stable step in front; and
- (c) except in a *children's service*, accessible from both indoor and outdoor play areas; and
- (d) in a *children's service*, other than a *restricted children's service*, the closet pans must be located in relation to children's rooms and outdoor play spaces so that children using toilets can be observed by staff from children's rooms and outdoor play space.

Substitute Vic F2.5(c) as follows:

Vic F2.5 Construction of sanitary compartments

- (c) In an *early childhood centre*, other than a *restricted children's service*, closet pans situated in a group for use by children must be separated from one another by means of a partition, which, except for the doorway, is opaque for a height of not less than 900 mm but not more than 1200 mm above the floor.

Add Vic F2.101 as follows:

Vic F2.101 First aid rooms

- (a) If an *assembly building*, place of public entertainment (as defined in the Building Act 1993) or an *open spectator stand* accommodates more than 5000 spectators at an arena, sportsground, showground, racecourse, cricket ground, football ground, coursing ground, motor racing arena, or the like, a suitable room or rooms must be provided in accordance with **Table F2.101** for use by para-medical attendants for first aid purposes.

Table F2.101 FIRST AID ROOMS

Spectator Capacity	Number of Rooms
5 001–10 000	1
10 001–15 000	2
15 001–30 000	3
each extra 15 000 or part thereof	1

- (b) **Conditions:** First aid rooms *required* by (a) must—
- (i) be distributed as uniformly as possible throughout the *assembly building* or *open spectator stand*; and
 - (ii) be convenient to a public road; and
 - (iii) be readily accessible from within and outside the arena or ground; and
 - (iv) have a *floor area* of not less than 24 m²; and
 - (v) be provided with a suitable wash basin or sink.

PART F3 ROOM SIZES

Substitute FP3.1 as follows:

PERFORMANCE REQUIREMENTS

Vic FP3.1

A *habitable room* or space must have sufficient size to enable the room or space to fulfil its intended use.

Substitute Vic F3.0 as follows:

DEEMED-TO-SATISFY PROVISIONS

Vic F3.0 Deemed-to-Satisfy Provisions

Performance Requirement Vic FP3.1 is satisfied by complying with **F3.1** and **Vic F3.101** to **Vic F3.103**.

Add Vic F3.101 as follows:

Vic F3.101 Children's services — size of rooms

- (a) A children's room in a *children's service* must have a *floor area* allowing a clear space of at least 3.25 m² for each child using that room.
- (b) When calculating the clear space *required* by (a) any passageway or thoroughfare less than 3 metres wide, kitchen, toilet or shower area, storage area (including cupboards),

areas through which doors may swing, cot rooms (including areas where fixed cots will be used or stored) or any other ancillary area must not be included.

Add Vic F3.102 as follows:

Vic F3.102 Class 3 buildings — size of rooms

A *habitable room* in a Class 3 building (other than a *residential aged care building*)—

- (a) must have a *floor area* of at least 7.5 m²; or
- (b) may have a *floor area* less than 7.5 m² provided the room has light and ventilation not less than that *required* for a room having a *floor area* of 7.5 m².

Add Vic F3.103 as follows:

Vic F3.103 Class 3, 9a and 9c residential aged care buildings — size of rooms

In a *residential aged care building*—

- (a) each bedroom must have a *floor area* of not less than 12 m² per occupant; and
- (b) all other common *habitable rooms* (other than kitchens) must have a *floor area* of not less than 7.5 m² with—
 - (i) in a Class 3 hostel or supported residential services building or Class 9c building an aggregate *floor area* of not less than 3.5 m² per occupant; or
 - (ii) in a Class 9a nursing home an aggregate *floor area* of not less than 2.5 m² per occupant.

PART F4 LIGHT AND VENTILATION

Delete F4.1(d) and insert Vic F4.1(d) as follows:

Vic F4.1 Provision of natural light

- (d) **Class 9b buildings** — to all general purpose classrooms in primary or secondary *schools* and all playrooms or the like for the use of children in an *early childhood centre* other than a *restricted children's service*.

Substitute F4.2(b) and F4.2(d) and delete F4.2(c) as follows:

Vic F4.2 Methods and extent of natural lighting

- (b) In a Class 2, 3 or 9 building or Class 4 part of a building a *required window* that faces a boundary of an adjoining allotment or a wall of the same building or another building on the allotment must not be less than a horizontal distance from that boundary or wall that is the greater of—
 - (i) generally — 1 m; and
 - (ii) in a *patient care area* or other room used for sleeping purposes in a Class 9a or Class 9c building — 3 m; and
 - (iii) 50% of the square root of the exterior height of the wall in which the *window* is located, measured in metres from its sill.
- (c) (deleted).

- (d) In a Class 9b *early childhood centre*, other than a *restricted children's service*, the sills of 50% of *windows* in children's rooms must be located not more than 500 mm above the floor level.

SECTION G ANCILLARY PROVISIONS

PART G1 MINOR STRUCTURES AND COMPONENTS

Delete GP1.2(a) and insert Vic GP1.2(a) as follows:

PERFORMANCE REQUIREMENTS

Vic GP1.2

- (a) A barrier must be provided to a *swimming pool* and must—
- (i) be continuous for the full extent of the hazard; and
 - (ii) be of a strength and rigidity to withstand the foreseeable impact of people; and
 - (iii) restrict the access of young children to the pool and the immediate pool surrounds; and
 - (iv) have any gates and doors fitted with latching devices not readily operated by young children, and constructed to automatically close and latch.

Application:

Vic GP1.2(a) only applies to a *swimming pool* with a depth of water more than 300 mm associated with—

- (a) a Class 2 or 3 building or Class 4 part of a building; or
- (b) a *children's service*.

Delete G1.1(a) and Insert Vic G1.1(a) as follows:

DEEMED-TO-SATISFY PROVISIONS

Vic G1.1 Swimming pools

- (a) A *swimming pool* associated with a *children's service*, with a depth of water more than 300 mm, must have fencing or other barriers in accordance with AS 1926 Parts 1 and 2.

SECTION H SPECIAL USE BUILDINGS

Add Vic Part H101 as follows:

Vic Part H101 CLASS 3, CLASS 9a AND CLASS 9c RESIDENTIAL AGED CARE BUILDINGS

Application:

This Part only applies to Class 3, Class 9a and Class 9c *residential aged care buildings*.

Note.

Vic Part H101 — Class 3, Class 9a and Class 9c Residential Aged Care Buildings contains additional *Deemed-to-Satisfy Provisions* for Sections D and F for Class 3, Class 9a and Class 9c *residential aged care buildings* as well as additional *Performance Requirements* and associated *Deemed-to-Satisfy Provisions*.

PERFORMANCE REQUIREMENTS

Vic HP101.1

The temperature of water supplied to baths and showers for use by residents must be controlled to avoid the risk of scalding whilst ensuring the stored water temperature does not encourage the growth of Legionella Bacteria.

Vic HP101.2

An electronic communication system must be provided to enable residents and staff to summon assistance in *habitable rooms* (other than kitchens), water closets, shower rooms and bathrooms.

Vic HP101.3

Sufficient general purpose outlets must be provided for electrical appliances in bedrooms in locations that obviate the need for extension leads.

DEEMED-TO-SATISFY PROVISIONS

Vic H101.0 Deemed-to-Satisfy Provisions

Performance Requirements Vic HP101.1 to HP101.3 and relevant *Performance Requirements* in **Sections D** and **F** are satisfied by complying with **Vic H101.1 to Vic H101.7**.

Vic H101.1 Application of Part

The *Deemed-to-Satisfy Provisions* of this Part apply to Class 3, Class 9a and Class 9c *residential aged care buildings*.

Vic H101.2 Doorway width

(a) The clear width of all bedroom entrance doorways must be not less than 900 mm.

- (b) The clear width of all other doorways must be not less than 800 mm.

Vic H101.3 Windows

- (a) The sill height of *windows* in *habitable rooms* (except kitchens) must be not more than 900 mm above the floor.
- (b) Openable *windows* must be provided with flyscreens.

Vic H101.4 Grab rails

Grab rails must be provided in association with every closet pan, shower or bath in accordance with **AS 1428.1**.

Vic H101.5 Heated water temperature

Heated water must be stored and delivered to baths and showers for use by residents in accordance with the requirements for new heated water installations under the Plumbing Regulations 2008.

Vic H101.6 Electronic communications system

A communication system must—

- (a) contain a back-up power supply; and
- (b) have a control that enables the call to be cancelled manually at the point of origin only; and
- (c) incorporate a device at the point of origin that indicates the system has operated; and
- (d) incorporate an indication panel in the manager's office or staff area that clearly identifies the point of origin of a call; and
- (e) have an audible tone that has a continuous signal until deactivated at the point of origin; and
- (f) be operational at all times; and
- (g) have two call points in each en-suite or combined shower/water closet with one call point located in the shower recess and the other on the wall beside the closet pan ahead of the bowl rim; and
- (h) have call points (other than those mentioned in (g)) which are located—
- (i) within the reach of a resident whilst in bed; and
 - (ii) in all common *habitable rooms*; and
 - (iii) in all bathrooms, *sanitary compartments* and shower rooms where the call point must be of waterproof construction and within reach of any fallen resident.

Vic H101.7 Electrical power outlets

General purpose outlets must be provided as follows:

- (a) In bedrooms with one occupant—two general purpose outlets provided on a minimum of two walls.
- (b) For each additional occupant—two general purpose outlets provided at the head of each additional bed.

Add Vic Part H102 as follows:

Vic Part H102 PLACES OF PUBLIC ENTERTAINMENT

Application:

This Part applies to all places of public entertainment as defined in the Building Act 1993 and prescribed in regulation 1102 of the Building Regulations 2006.

Note.

Vic Part H102 — Places of Public Entertainment contains additional deemed-to-satisfy and *Performance Requirements* for Sections B, D and F for places of public entertainment.

PERFORMANCE REQUIREMENTS

Vic HP102.1

Temporary tiered seating stands and embankments must be designed using engineering principles and constructed to provide for the safety of the patrons and orderly means of evacuation in an emergency.

Vic HP102.2

Every place of public entertainment where motor vehicle racing takes place must be provided with suitable barriers and guard rails to protect the public from injury.

Vic HP102.3

Sufficient sanitary and amenity facilities must be provided at places of public entertainment for use by patrons.

DEEMED-TO-SATISFY PROVISIONS

Vic H102.0 Deemed-to-Satisfy Provisions

Performance Requirements Vic HP102.1 to HP102.3 are satisfied by complying with Vic H102.1 to Vic H102.4.

Vic H102.1 Application of Part

The *Deemed-to-Satisfy Provisions* of this Part apply to all places of public entertainment.

Vic H102.2 Temporary tiered seating, concourses and embankments

Temporary tiered seating stands and embankments must be designed and constructed as follows:

- (a) Temporary tiered seating, concourses and embankments must comply with the *Deemed-to-Satisfy Provisions* of **Section B**, **Section D** and **Clause H1.4(a)(ii), (iii) and (b)**.
- (b) The maximum slope of tiered seating must not exceed 34 degrees when measured from the horizontal plane.
- (c) Aisles must be evenly spaced throughout the structure and have—
 - (i) a minimum width of 1 m; and
 - (ii) the aggregate of aisle widths leading to an *exit* must be not less than the *required* width of that *exit*; and
 - (iii) no one aisle may serve more than—
 - (A) 120 patrons where individual seating with backs is provided; or
 - (B) 200 patrons in any other case.
- (d) When applying the balustrading requirements of the *Deemed-to-Satisfy Provisions* of **Section D**, the height of plat balustrading that directly abuts seating (i.e. with no aisle between the seat and the balustrading) must be measured from the plat or seat base whichever is the higher.
- (e) Transverse aisles must be provided at a horizontal distance of not more than 10 m between any row of seats.
- (f) All individual moveable seats must be—
 - (i) fixed in groups of not less than four; and
 - (ii) not used in stepped or ramped seating areas.
- (g) For any spectators' embankment—
 - (i) where the rear slope exceeds 1 in 5, a guard rail must be installed with no openings except at the heads of steps or ramps; and
 - (ii) where the forward or front slope exceeds 1 in 8, the embankment must be stepped with plats not less than 500 mm wide and risers not greater than 230 mm high.
- (h) Guard rails must be installed to protect any fence, balustrade or railing associated with stepped or ramped standing spaces where excess pressure is expected from spectators.

Vic H102.3 Motor vehicle racing

Motor vehicle racing barriers and guard rails must be provided so as to comply with the following:

- (a) CAMS “Track Operators Safety Guide”.
- (b) For stock car racing, barriers installed—
 - (i) on the outer margin of the track: a continuous concrete, close boarding or long guard barrier having a height of not less than 900 mm; and
 - (ii) on all curved sections of the track within 3 m of the barrier described in (i): a stout welded or woven wire mesh fence adequately supported having a height of not less than 1.8 m above the adjacent spectators viewing areas; and
 - (iii) between the public viewing area and the fence described in (ii): a suitable crowd barrier that will prevent spectators entering within 1.2 m of that fence.

Vic H102.4 Sanitary and amenity facilities

Sanitary and amenity facilities in places of public entertainment must be provided as follows:

- (a) In places other than buildings:
 - (i) One closet fixture for every 200 female patrons or part thereof.
 - (ii) One closet fixture or urinal for every 200 male patrons or part thereof, at least 30% of which must be in the form of closet fixtures.
 - (iii) One washbasin for every 200 patrons or part thereof.
 - (iv) For use by disabled persons, one unisex facility within the meaning of **Part F2** of the BCA for every 100 closet fixtures or part thereof *required* under (i) and (ii).
 - (v) One drinking fountain or drinking tap for every washbasin *required* under (iii).
 - (vi) First aid facilities in accordance with **Vic F2.101**.
- (b) In buildings, as *required* to comply with **Part F2**.

Add Vic Part H103 as follows:

Vic Part H103 FIRE SAFETY IN CLASS 2 AND CLASS 3 BUILDINGS

Note:

There are no *Performance Requirements* for Vic Part H103 — Fire Safety in Class 2 and Class 3 Buildings as the Part contains only additional *Deemed-to-Satisfy Provisions* for **Sections C, D and E** for Class 2 and Class 3 buildings.

Vic H103.1 Fire safety in Class 2 and Class 3 buildings

- (a) A Class 2 or Class 3 building not more than 25 m in *effective height* that has a sprinkler system complying with **Specification E1.5** installed throughout the building may be constructed in accordance with (b), except where the building is constructed using *fire-protected timber* building elements, provided that—
 - (i) where a sprinkler system complying with AS 2118.4, as applicable, is installed in the building, the system must be permanently connected with a direct data link or other approved monitoring system to a fire station or fire station dispatch centre in accordance with Practice Note 2008-07 if—
 - (A) it has more than 100 sprinkler heads; or
 - (B) in the case of a *residential care building*, the building will accommodate more than 32 residents; and
 - (ii) the sprinkler system is fitted with sprinklers complying with Clause 2.6 of AS 2118.4 in bedrooms; and
 - (iii) an *automatic* smoke detection and alarm system is installed in accordance with **Specification E2.2a**, except that it need not be connected to a fire station and in the case of a *residential care building* must be installed in accordance with—
 - (A) **Specification E2.2a Clause 4**; or
 - (B)
 - (aa) **Specification E2.2a Clause 3** provided **Clause 3 (c)(ii)** is applied as if the building was not protected with a sprinkler system; and

- (bb) Practice Note 2008-07; and
- (iv) in a *residential care building*, the *automatic* smoke detection and alarm system and the sprinkler system are connected to an alarm panel constructed in accordance with Practice Note 2008-07; and
- (v) fire orders are provided in a Class 3 building in accordance with **G4.9**.
- (b) Subject to compliance with (a), the following concessions are permissible:
 - (i) **C3.11** — deletion of the requirement for *self-closing* fire doors or solid-core doors (except those opening to fire-isolated *exits*).
 - (ii) **Specification C1.1** — deletion of the requirement for *internal walls* to have an FRL subject to compliance with **Clause 2.2 of Specification C1.1**, except that walls bounding *public corridors* must be—
 - (A) clad in *non-combustible* material; and
 - (B) extend to the underside of a *non-combustible* roof covering or to the underside of the ceiling and be designed to minimise smoke spread to the corridor; and
 - (C) not incorporate any penetrations above door head height unless the penetrations are adequately stopped to prevent the free passage of smoke.
 - (iii) **D1.3** — deletion of the requirement for stairways that serve not more than 5 *storeys* to be *fire-isolated stairways* provided—
 - (A) the stairway is smoke enclosed with construction that complies with **D2.6** (except **D2.6(a)** and **(b)(i)**); and
 - (B) in a Class 3 building, *storeys* 4 and 5 are served by a minimum of 2 smoke enclosed stairways.
 - (iv) **D1.4(a)(i)(A)** — except in a *residential care building*, the maximum distance of travel may be increased from 6 m to 12 m.
 - (v) **D1.5(c)(i)** — except in a *residential care building*, the maximum distance between alternative *exits* may be increased from 45 m to 60 m.
 - (vi) **E1.3** — deletion of the requirement for internal fire hydrants in buildings that have a *rise in storeys* of not more than 5 provided—
 - (A) an external fire hydrant is installed in accordance with **E1.3** except that in a *residential care building*, the nozzle at the end of the length of hose need only reach the entry door of any *sole-occupancy unit* to be considered as covering the floor area within the *sole-occupancy unit*; or
 - (B) a dry fire main fitted with standard fire hydrant heads is installed in the building provided that-
 - (aa) each fire hydrant head is located in accordance with **E1.3** and fitted with a blank cap or plug; and
 - (bb) the pipework is installed in accordance with **E1.3** (as if it were a fire main suitable for that building) except that it does not need to be connected to a water supply; and
 - (cc) a booster inlet connection is provided in accordance with **E1.3**; and
 - (dd) an external fire hydrant is located within 60 m of the booster connection.

(vii) * * * * *

(viii) **E4.9** — deletion of the requirement for a sound system and intercom system for emergency purposes in a *residential care building* provided an intercom system with override public address facility is installed in accordance with Practice Note 2014-08.

Add Vic Part H104 as follows:

Vic Part H104 CLASS 9b CHILDREN'S SERVICES

Application:

This Part only applies to Class 9b *children's services*.

Note:

Vic Part H104 — Class 9b Children's Services contains an additional *Performance Requirement* and *Deemed-to-Satisfy Provisions* for **Section D** for Class 9b *children's services*.

PERFORMANCE REQUIREMENTS

Vic HP104.1

The number and location of doorways to a children's room must take into account the mobility of children in the event that emergency egress or entry is required.

DEEMED-TO-SATISFY PROVISIONS

Vic H104.0 Deemed-to-Satisfy Provisions

Performance Requirement Vic HP104.1 and relevant *Performance Requirements* in **Section D** are satisfied by complying with **Vic H104.1** and **Vic H104.2**.

Vic H104.1 Application of Part

The *Deemed-to-Satisfy Provisions* of this Part apply to Class 9b *children's services*.

Vic H104.2 Doorways to a children's room

A children's room must have a doorway, or in the case of every such room accommodating more than 21 children at least two doorways as widely separated as possible, providing direct access to or from—

- (a) an outdoor play area; or
- (b) a passage leading to the outside; or
- (c) a fire-isolated *exit*.

Footnote: OTHER LEGISLATION AFFECTING BUILDINGS

In addition to any applicable provisions of the Building Act 1993, Building Regulations 2006 and this Code, there are a number of other legislative technical requirements affecting the design, construction and/or performance of buildings that practitioners may need to be aware of, including, but not necessarily limited to, the following list. Additional legislative instruments such as regulations, codes and standards may exist under the legislation listed.

1. **Abattoirs and Knackeries**

1.1 **Administering Agency**

Department of Environment and Primary Industries

Relevant Legislation

Meat Industry Act 1993

2. **Accommodation – Residential (Boarding Houses, Guest Houses, Hostels, Motels)**

2.1 **Administering Agency**

Department of Health and Human Services

Consumer Affairs Victoria

Municipal council

Relevant Legislation

Public Health and Wellbeing Act 2008

Public Health and Wellbeing Regulations 2009

Residential Tenancies Act 1997

Residential Tenancies (Rooming House Standards) Regulations 2012

3. **Accommodation - Supported Residential Services**

3.1 **Administering Agency**

Department of Health and Human Services

Relevant Legislation

Supported Residential Services (Private Proprietors) Act 2010

Supported Residential Services (Private Proprietors) Regulations 2012

4. **Alpine Resorts**

4.1 **Administering Agency**

Department of Environment, Land, Water and Planning

Alpine Resorts Management Boards

Relevant Legislation

Alpine Resorts (Management) Act 1997

5. Asbestos Removal

5.1 Administering Agency

Victorian WorkCover Authority
Environment Protection Authority

Relevant Legislation

Occupational Health and Safety Act 2004
Environment Protection Act 1970

6. Children's Services

6.1 Administering Agency

Department of Education and Training

Relevant Legislation

Children's Services Act 1996
Children's Services Regulations 2009
Education and Care Services National Law Act 2010
Education and Care Services National Regulations

7. Crematoria, Mausolea, Vaults, etc.

7.1 Administering Agency

Department of Health and Human Services, Cemeteries and Crematoria Regulation Unit
Cemetery Trusts

Relevant Legislation

Cemeteries and Crematoria Act 2003
Cemeteries and Crematoria Regulations 2015

8. Crown Land

8.1 Administering Agency

Department of Environment, Land, Water and Planning
Crown Land committees of management

Relevant Legislation

Crown Land (Reserves) Act 1978

9. Dairies

9.1 Administering Agency

Dairy Food Safety Victoria

Relevant Legislation

Dairy Act 2000

10. Dangerous Goods

10.1 Administering Agency

Victorian WorkCover Authority

Relevant Legislation

Dangerous Goods Act 1985

Dangerous Goods (Explosives) Regulations 2011

Dangerous Goods (HCDG) Regulations 2005

Dangerous Goods (Storage and Handling) Regulations 2012

Codes of practice published by the Victorian WorkCover Authority

11. Electrical Installations

11.1 Administering Agency

Energy Safe Victoria

Electrical transmission and distribution companies

Relevant Legislation

Electricity Industry Act 2000

Electricity Industry (Residual Provisions) Act 1993

Electricity Safety Act 1998

State Electricity Commission Act 1958

Electricity Safety (Installations) Regulations 2009

Standards Australia Wiring Rules, AS/NZS 3000/3013

12. Fences - dividing

12.1 Administering Agency

Department of Justice and Regulation

Dispute Settlement Centre of Victoria

Relevant Legislation

Fences Act 1968

13. Fire Prevention in Existing Buildings

13.1 Administering Agency

Municipal council

Relevant Legislation

Building Act 1993

Building Regulations 2006

14. Food Premises

14.1 Administering Agency

Department of Health and Human Services

Municipal council

Relevant Legislation

Food Act 1984

15. Gas Installations

15.1 Administering Agency

Energy Safe Victoria

Relevant Legislation

Gas Industry Act 2001

Gas Safety Act 1997

Gas Safety (Gas Installation) Regulations 2008

AS/NZS 5601 Gas Installations

16. Historic Buildings

16.1 Administering Agency

Department of Environment, Land, Water and Planning

Executive Director under the Heritage Act 1995

Relevant Legislation

Heritage Act 1995

17. Hospitals, Nursing Homes and Health Care Buildings

17.1 Administering Agency

Department of Health and Human Services

Relevant Legislation

Public Health and Wellbeing Act 2008

18. Lift Installations

18.1 Administering Agency

Victorian WorkCover Authority

Relevant Legislation

Occupational Health and Safety Act 2004

Occupational Health and Safety Regulations 2007

AS1735 Lifts, escalators and moving walks

19. Moveable Dwellings (in Caravan Parks)

19.1 Administering Agency

Department of Environment, Land, Water and Planning
Municipal council

Relevant Legislation

Residential Tenancies Act 1997
Residential Tenancies (Caravan Parks and Moveable Dwellings
Registration and Standards) Regulations 2010

20. Occupational Health and Safety

20.1 Administering Agency

Victorian WorkCover Authority

Relevant Legislation

Occupational Health and Safety Act 2004
Occupational Health and Safety Regulations 2007
Codes of practice published by the Victorian WorkCover Authority

21. Pharmacies

21.1 Administering Agency

Department of Health and Human Services
Victorian Pharmacy Authority

Relevant Legislation

Pharmacy Regulation Act 2010
Victorian Pharmacy Authority Guidelines

22. Planning Controls

22.1 Administering Agency

Department of Environment, Land, Water and Planning
Municipal council

Relevant Legislation

Planning and Environment Act 1987
Planning schemes

23. Prisons and Jails

23.1 Administering Agency

Department of Justice and Regulation
Corrections Victoria

Relevant Legislation

Corrections Act 1986

24. Radiation Safety

24.1 Administering Agency

Department of Health and Human Services

Relevant Legislation

Radiation Act 2005

Radiation Regulations 2007

25. Schools (Non-Government)

25.1 Administering Agency

Department of Education and Training

Victorian Registration and Qualifications Authority

Relevant Legislation

Education and Training Reform Act 2006

26. Sanitary Plumbing, Water Supply and Sewerage

26.1 Administering Agency

Victorian Building Authority

Relevant Legislation

Building Act 1993

Plumbing Regulations 2008

National Construction Code Volume Three Plumbing Code of Australia

AS/NZS 3500 Plumbing and Drainage

27 Septic Tank Installations

27.1 Administering Agency

Environment Protection Authority

Municipal council

Relevant Legislation

Environment Protection Act 1970

Guidelines For Environmental Management: Code of Practice-Onsite wastewater management

28. Smoking Restrictions

28.1 Administering Agency

Department of Health and Human Services

Municipal council

Relevant Legislation

Tobacco Act 1987

29. Subdivision of Buildings

29.1 Administering Agency

Department of Environment, Land, Water and Planning

Municipal council

Relevant Legislation

Subdivision Act 1988

WESTERN AUSTRALIA

INTRODUCTION

This Appendix contains variations and additions to the Building Code of Australia (BCA) provisions which are considered necessary for the effective application of the Code in Western Australia.

APPENDIX CONTENTS

APPENDIX WESTERN AUSTRALIA

Western Australia

Footnote: Other Legislation Affecting Buildings

Footnote: Other Legislation Affecting Buildings

Footnote: OTHER LEGISLATION AFFECTING BUILDINGS

In addition to any applicable provisions of the Building Act 2011, Building Regulations 2012 and this Code, there are a number of other legislative technical requirements affecting the design, construction and/or performance of buildings that practitioners may need to be aware of, including, but not necessarily limited to, the following list. Additional legislative instruments such as regulations, codes and standards may exist under the legislation listed.

1. Building

1.1 Administering Agency

Building Commission, Department of Commerce

Relevant Legislation

Building Services (Complaint Resolution and Administration) Act 2011

Building Services (Complaint Resolution and Administration) Regulations 2011

Building Services (Registration) Act 2011

Building Services (Registration) Regulations 2011

2. Caravan Parks and Camping Grounds

2.1 Administering Agency

Department of Local Government

Relevant Legislation

Caravan Park and Camping Grounds Act 1995

Caravan Park and Camping Grounds Regulations 1997

3. Child Care

3.1 Administering Agency

Department for Communities

Relevant Legislation

Child Care Services Act 2007

Child Care Services Regulations 2007

Child Care Services (Child Care) Regulations 2006

Child Care Services (Family Day Care) Regulations 2006

Child Care Services (Outside School Hours Care) Regulations 2006

Child Care Services (Outside School Hours Family Day Care) Regulations 2006

Child Care Services (Rural Family Care) Regulations 2010

4. Fences

4.1 Administering Agency

Building Commission, Department of Commerce

Relevant Legislation

Dividing Fences Act 1961

5. Health

5.1 Administering Agency

Department of Health

Relevant Legislation

Health Act 1911

Health Act (Laundries & Bathrooms) Regulations

Health Act (Swimming Pools) Regulations 1964

Health (Air Handling and Water Systems) Regulations 1994

Health (Asbestos) Regulations 1992

Health (Aquatic Facilities) Regulations 2007

Health (Construction Work) Regulations 1973

Construction Camp Regulations

Health (Public Buildings) Regulations 1992

Health (Treatment of Sewage and Disposal of Effluent and Liquid Waste) Regulations 1974

Health (Rottnest Island) By-laws 1989

Health (Food Hygiene) Regulations 1993

Sewerage (Lighting, Ventilation and Construction) Regulations 1971

Model By-Laws Series 'A' and earlier versions where adopted by Local Government

Health Local Laws where adopted by Local Government

6. Heritage

6.1 Administering Agency

Heritage Council of Western Australia

Relevant Legislation

Heritage of Western Australia Act 1990

Heritage of Western Australia Regulations 1991

7. Hospitals and Health Services

7.1 Administering Agency

Department of Health

Relevant Legislation

Hospitals and Health Services Act 1927

8. Housing

8.1 Administering Agency

Department of Housing

Relevant Legislation

Housing Act 1980

9. Land

9.1 Administering Agency

Western Australian Land Information Authority

Relevant Legislation

Strata Titles Act 1985

10. Occupational Health and Safety

10.1 Administering Agency

WorkSafe, Department of Commerce

Relevant Legislation

Occupational Safety and Health Act 1984

11. Planning Controls

11.1 Administering Agency

Department for Planning

Relevant Legislation

Planning and Development Act 2005

Planning and Development (Consequential and Transitional Provisions) Act 2005

12. Public Works

12.1 Administering Agency

Building Management and Works, Department of Treasury and Finance

Relevant Legislation

Public Works Act 1902

INDEX, ABBREVIATIONS AND SYMBOLS

Index

Abbreviations and Symbols

CONTENTS

INDEX, ABBREVIATIONS AND SYMBOLS

Index

Abbreviations and Symbols

INDEX (TO DEEMED-TO-SATISFY PROVISIONS)

A

Access for people with a disability

- D3.0** Deemed-to-Satisfy Provisions
- D3.1** General building access requirements
- D3.3** Parts of buildings to be accessible
- D3.2** Access to buildings
- D3.4** Exemptions
- D3.5** Accessible carparking
- D3.6** Signage
- D3.7** Hearing augmentation
- D3.8** Tactile indicators
- D3.9** Wheelchair seating spaces in Class 9b assembly buildings
- D3.10** Swimming pools
- D3.11** Ramps
- D3.12** Glazing on an accessway
- SPEC-D3.6** Specification D3.6 Braille and Tactile Signs
- SPEC-D3.10** Specification D3.10 Accessible water entry/exit for swimming pools

Access for people with a disability, Braille

- D3.6** Signage

Access for people with a disability, carpark

- D3.5** Accessible carparking

Access for people with a disability, hearing augmentation

- D3.17** Hearing augmentation

Access for people with a disability, ramps

- D3.11** Ramps
- D3.12** Glazing on an accessway

Access for people with a disability, tactile indicators

- D3.8** Tactile indicators

Access for people with a disability, tactile signs

- D3.6** Signage

Aged care building

- C2.5** Class 9a and 9c buildings
- D2.19** Doorways and doors
- E3.8** Aged care buildings

Aged care building, lift

- E3.8** Aged care buildings

Air movement, energy efficiency

- J0.3** Ceiling fan

Air-conditioning, energy efficiency

- J0.0** Deemed-to-Satisfy Provisions
- J0.1** Application of Section J
- J5.0** Deemed-to-Satisfy Provisions
- J5.2** Air-conditioning systems
- J5.3** Mechanical ventilation systems
- J5.4** Miscellaneous exhaust systems
- SPEC-J5.2a-3** Specification J5.2a Fans 3.

Airlock

- F4.9** Airlocks

Aisle lights

- H1.7** Aisle lights in theatres

Alpine area

- G4.0** Deemed-to-Satisfy Provisions
- G4.1** Application of Part
- G4.3** External doorways
- G4.4** Emergency lighting
- G4.5** External ramps
- G4.6** Discharge of exits
- G4.7** External trafficable structures
- G4.8** Fire-fighting services and equipment
- G4.9** Fire orders

Aluminium construction

- B1.4** Determination of structural resistance of materials and forms of construction

Artificial lighting, energy efficiency

J0.0 Deemed-to-Satisfy Provisions

J0.1 Application of Section J

J6.0 Deemed-to-Satisfy Provisions

J6.2 Artificial lighting

J6.3 Interior artificial lighting and power control

J6.4 Interior decorative and display lighting

J6.5 Artificial lighting around the perimeter of a building

J6.6 Boiling water and chilled water storage units

SPEC-J6 Specification J6 Lighting and Power Control Devices

Atrium

C1.0 Deemed-to-Satisfy Provisions

C2.0 Deemed-to-Satisfy Provisions

C3.0 Deemed-to-Satisfy Provisions

D1.0 Deemed-to-Satisfy Provisions

D2.0 Deemed-to-Satisfy Provisions

D3.0 Deemed-to-Satisfy Provisions

E2.0 Deemed-to-Satisfy Provisions

G3.1 Application of Part

SPEC-G3.8 Specification G3.8 Fire and Smoke Control Systems in Buildings
Containing Atriums

Atrium construction

G3.1 Application of Part

G3.2 Dimensions of atrium well

G3.3 Separation of atrium by bounding walls

G3.4 Construction of bounding walls

G3.5 Construction at balconies

G3.6 Separation at roof

G3.7 Means of egress

G3.8 Fire and smoke control systems

Atrium construction, fire and smoke control

G3.8 Fire and smoke control systems

Atrium, fire and smoke control

SPEC-G3.8 Specification G3.8 Fire and Smoke Control Systems in Buildings
Containing Atriums

Attachments, fire resistance

SPEC-C1.1-2.4 Specification C1.1 Fire-Resisting Construction 2. 2.4

B

Balcony, verandah

SPEC-C1.1-2.5 Specification C1.1 Fire-Resisting Construction 2. 2.5

Barrier

D2.16 Barriers to prevent falls

D2.24 Protection of openable windows

BCA application

A0.1 Compliance with the NCC

A0.3 Performance Solutions

A0.4 Deemed-to-Satisfy Solutions

A0.5 Assessment Methods

A0.6 Defined terms

A0.7 Relevant Performance Requirements

A1.2 Adoption of Standards and other references

A1.3 Referenced Standards, etc

A1.4 Differences between referenced documents and the NCC

A1.5 Compliance with all Performance Requirements

A1.6 Application of the NCC to a particular State or Territory

A1.7 Language

A1.8 Explanatory Information

BCA application, Language

A1.7 Language

BCA application, Standards

A1.2 Adoption of Standards and other references

A1.3 Referenced Standards, etc

A1.4 Differences between referenced documents and the NCC

SPEC-A1.3 Specification A1.3 Documents Adopted By Reference

BCA application, State/Territory Appendices

A1.6 Application of the NCC to a particular State or Territory

Boilers and pressure vessels

SPEC-G2.2 Specification G2.2 Installation of Boilers and Pressure Vessels

Bounding construction

C3.11 Bounding construction: Class 2 and 3 buildings and Class 4 parts

Braille

D3.6 Signage

SPEC-D3.6 Specification D3.6 Braille and Tactile Signs

Building classification

A3.1 Principles of classification

A3.2 Classifications

A3.3 Multiple classification

A3.4 Parts with more than one classification

Building classification, multiple

A3.3 Multiple classification

A3.4 Parts with more than one classification

Building elements, fire resistance

SPEC-A2.3 Specification A2.3 Fire-Resistance of Building Elements

Building fabric, energy efficiency

J0.0 Deemed-to-Satisfy Provisions

J0.1 Application of Section J

J0.2 Heating and cooling loads of sole-occupancy units of a Class 2 building or a Class 4 part

J1.0 Deemed-to-Satisfy Provisions

Building occupant warning system

E2.0 Deemed-to-Satisfy Provisions

SPEC-E2.2a Specification E2.2a Smoke Detection and Alarm Systems

Building sealing, energy efficiency

J0.2 Heating and cooling loads of sole-occupancy units of a Class 2 building or a Class 4 part

J3.0 Deemed-to-Satisfy Provisions

J3.2 Chimneys and flues

J3.3 Roof lights

J3.4 Windows and doors

J3.5 Exhaust fans

J3.6 Construction of roofs, walls and floors

Buildings, united

A4.1 When buildings are united

A4.2 Alterations in a united building

Bushfire prone area

- G5.0** Deemed-to-Satisfy Provisions
- G5.1** Application of Part
- G5.2** Protection

C

Carpark

- D3.5** Accessible carparking
- F4.11** Carparks
- SPEC-C1.1-3.9** Specification C1.1 Fire-Resisting Construction 3. 3.9
- SPEC-C1.1-4.2** Specification C1.1 Fire-Resisting Construction 4. 4.2
- SPEC-C1.1-5.2** Specification C1.1 Fire-Resisting Construction 5. 5.2

Carpark, access for people with a disability

- D3.5** Accessible carparking

Carpark, Class2, 3

- SPEC-C1.1-2.8** Specification C1.1 Fire-Resisting Construction 2. 2.8

Carpark, Type A construction

- SPEC-C1.1-3.9** Specification C1.1 Fire-Resisting Construction 3. 3.9

Carpark, Type B construction

- SPEC-C1.1-4.2** Specification C1.1 Fire-Resisting Construction 4. 4.2

Carpark, Type C construction

- SPEC-C1.1-5.2** Specification C1.1 Fire-Resisting Construction 5. 5.2

Carpark, ventilation

- F4.11** Carparks

Ceilings

- A2.5** Resistance to the incipient spread of fire

Ceilings, fire resisting

- A2.5** Resistance to the incipient spread of fire

Columns

- C3.17** Columns protected with lightweight construction to achieve an FRL

Columns, protected with lightweight construction

- C3.17** Columns protected with lightweight construction to achieve an FRL

Composite steel and concrete construction

- B1.4** Determination of structural resistance of materials and forms of construction

Concrete construction

- B1.4** Determination of structural resistance of materials and forms of construction

Construction joints

C3.16 Construction joints

Construction joints, protection

C3.16 Construction joints

Curtain wall, panel wall

SPEC-C1.1-2.5 Specification C1.1 Fire-Resisting Construction 2. 2.5

D

Damp and weatherproofing

F1.0 Deemed-to-Satisfy Provisions

F1.1 Stormwater drainage

F1.5 Roof coverings

F1.6 Sarking

F1.7 Water proofing of wet areas in buildings

F1.9 Damp-proofing

F1.10 Damp-proofing of floors on the ground

F1.11 Provision of floor wastes

F1.12 Subfloor ventilation

F1.13 Glazed assemblies

Damp and weatherproofing, floor waste

F1.11 Provision of floor wastes

Damp and weatherproofing, glazing

F1.13 Glazed assemblies

Damp and weatherproofing, roof coverings

F1.5 Roof coverings

Damp and weatherproofing, sarking

F1.6 Sarking

Damp and weatherproofing, stormwater drainage

F1.1 Stormwater drainage

Damp and weatherproofing, subfloor ventilation

F1.12 Subfloor ventilation

Damp and weatherproofing, wet areas

F1.7 Water proofing of wet areas in buildings

Definitions

A1.1 Definitions

Door, direction of swing

D2.20 Swinging doors

Door, latch

D2.21 Operation of latch

Door, sign

D2.23 Signs on doors

Door, sliding, revolving etc

D2.19 Doorways and doors

Doorway, protection in bounding construction

C3.11 Bounding construction: Class 2 and 3 buildings and Class 4 parts

Ductwork, energy efficiency

SPEC-J5.2b Specification J5.2b Ductwork Insulation and Sealing

SPEC-J5.2b-1 Specification J5.2b Ductwork Insulation and Sealing 1.

SPEC-J5.2b-2 Specification J5.2b Ductwork Insulation and Sealing 2.

SPEC-J5.2b-3 Specification J5.2b Ductwork Insulation and Sealing 3.

E

Early fire hazard indices

SPEC-A2.4 Specification A2.4 Fire Hazard Properties

SPEC-C1.10 Specification C1.10 Fire Hazard Properties

Electrical supply equipment

C2.13 Electricity supply system

Emergency (electrical) equipment

C2.13 Electricity supply system

Emergency lift

E3.4 Emergency lifts

Emergency lighting

E4.0 Deemed-to-Satisfy Provisions

E4.2 Emergency lighting requirements

E4.3 Measurement of distance

E4.4 Design and operation of emergency lighting

Emergency warning and intercommunication system

E4.0 Deemed-to-Satisfy Provisions

Energy efficiency

J0.0 Deemed-to-Satisfy Provisions

J0.1 Application of Section J

J0.2 Heating and cooling loads of sole-occupancy units of a Class 2 building or a Class 4 part

J1.0 Deemed-to-Satisfy Provisions

Energy efficiency, access for maintenance

J0.1 Application of Section J

J8.0 Deemed-to-Satisfy Provisions

J8.3 Facilities for energy monitoring

Energy efficiency, air movement

J0.3 Ceiling fan

Energy efficiency, air-conditioning

J0.0 Deemed-to-Satisfy Provisions

J0.1 Application of Section J

J5.0 Deemed-to-Satisfy Provisions

J5.2 Air-conditioning systems

J5.3 Mechanical ventilation systems

J5.4 Miscellaneous exhaust systems

J6.6 Boiling water and chilled water storage units

SPEC-J5.2a-3 Specification J5.2a Fans 3.

Energy efficiency, artificial lighting

J0.0 Deemed-to-Satisfy Provisions

J0.1 Application of Section J

J6.0 Deemed-to-Satisfy Provisions

J6.2 Artificial lighting

J6.3 Interior artificial lighting and power control

J6.4 Interior decorative and display lighting

J6.5 Artificial lighting around the perimeter of a building

SPEC-J6 Specification J6 Lighting and Power Control Devices

SPEC-J6-1 Specification J6 Lighting and Power Control Devices 1.

SPEC-J6-2 Specification J6 Lighting and Power Control Devices 2.

SPEC-J6-3 Specification J6 Lighting and Power Control Devices 3.

SPEC-J6-4 Specification J6 Lighting and Power Control Devices 4.

SPEC-J6-5 Specification J6 Lighting and Power Control Devices 5.

Energy efficiency, building fabric

J0.0 Deemed-to-Satisfy Provisions

J0.1 Application of Section J

J0.2 Heating and cooling loads of sole-occupancy units of a Class 2 building or a Class 4 part

J1.0 Deemed-to-Satisfy Provisions

Energy efficiency, building sealing

J0.2 Heating and cooling loads of sole-occupancy units of a Class 2 building or a Class 4 part

J3.0 Deemed-to-Satisfy Provisions

Energy efficiency, ductwork

SPEC-J5.2b Specification J5.2b Ductwork Insulation and Sealing

SPEC-J5.2b-1 Specification J5.2b Ductwork Insulation and Sealing 1.

SPEC-J5.2b-2 Specification J5.2b Ductwork Insulation and Sealing 2.

SPEC-J5.2b-3 Specification J5.2b Ductwork Insulation and Sealing 3.

Energy efficiency, evaporative cooler

J3.7 Evaporative coolers

Energy efficiency, fans

SPEC-J5.2a Specification J5.2a Fans

SPEC-J5.2a-1 Specification J5.2a Fans 1.

SPEC-J5.2a-2 Specification J5.2a Fans 2.

SPEC-J5.2a-3 Specification J5.2a Fans 3.

SPEC-J5.2a-4 Specification J5.2a Fans 4.

Energy efficiency, floor construction

J1.6 Floors

SPEC-J1.6 Specification J1.6 Floor Construction

SPEC-J1.6-1 Specification J1.6 Floor Construction 1.

SPEC-J1.6-2 Specification J1.6 Floor Construction 2.

Energy efficiency, glazing

J2.0 Deemed-to-Satisfy Provisions

J2.1 Application of Part

J2.4 Glazing

Energy efficiency, heated water supply

J7.2 Heated water supply

Energy efficiency, hot water supply

J0.0 Deemed-to-Satisfy Provisions

J0.1 Application of Section J

Energy efficiency, material

SPEC-J1.2-1 Specification J1.2 Material Properties 1.

SPEC-J1.2-2 Specification J1.2 Material Properties 2.

Energy efficiency, material properties

SPEC-J1.2 Specification J1.2 Material Properties

SPEC-J1.2-1 Specification J1.2 Material Properties 1.

SPEC-J1.2-2 Specification J1.2 Material Properties 2.

Energy efficiency, piping, vessels, heat exchangers and tanks

SPEC-J5.2c Specification J5.2c Piping, Vessel, Heat Exchanger and Tank Insulation

SPEC-J5.2c-1 Specification J5.2c Piping, Vessel, Heat Exchanger and Tank Insulation 1.

SPEC-J5.2c-2 Specification J5.2c Piping, Vessel, Heat Exchanger and Tank Insulation 2.

Energy efficiency, power control

J0.0 Deemed-to-Satisfy Provisions

J0.1 Application of Section J

J5.2 Air-conditioning systems

J5.3 Mechanical ventilation systems

J6.0 Deemed-to-Satisfy Provisions

J6.3 Interior artificial lighting and power control

SPEC-J6 Specification J6 Lighting and Power Control Devices

SPEC-J6-1 Specification J6 Lighting and Power Control Devices 1.

SPEC-J6-2 Specification J6 Lighting and Power Control Devices 2.

SPEC-J6-3 Specification J6 Lighting and Power Control Devices 3.

SPEC-J6-4 Specification J6 Lighting and Power Control Devices 4.

SPEC-J6-5 Specification J6 Lighting and Power Control Devices 5.

Energy efficiency, roof and ceiling construction

J1.3 Roof and ceiling construction

SPEC-J1.3 Specification J1.3 Roof and Ceiling Construction

SPEC-J1.3-1 Specification J1.3 Roof and Ceiling Construction 1.

SPEC-J1.3-2 Specification J1.3 Roof and Ceiling Construction 2.

Energy efficiency, roof lights

J1.4 Roof lights

Energy efficiency, sealing of chimneys and flues

J3.2 Chimneys and flues

Energy efficiency, sealing of exhaust fans

J3.5 Exhaust fans

Energy efficiency, sealing of external windows and doors

J3.4 Windows and doors

Energy efficiency, sealing of roof lights

J3.3 Roof lights

Energy efficiency, sealing of roofs, walls and floors

J3.6 Construction of roofs, walls and floors

Energy efficiency, shading

J2.5 Shading

Energy efficiency, spa

J7.0 Deemed-to-Satisfy Provisions

J7.4 Spa pool heating and pumping

Energy efficiency, space heating

SPEC-J5.2d Specification J5.2d Space Heating

SPEC-J5.2d-1 Specification J5.2d Space Heating 1.

SPEC-J5.2d-2b Specification J5.2d Space Heating 2.

Energy efficiency, swimming pool

J7.0 Deemed-to-Satisfy Provisions

J7.3 Swimming pool heating and pumping

Energy efficiency, thermal construction

J1.2 Thermal construction — general

Energy efficiency, ventilation systems

J0.0 Deemed-to-Satisfy Provisions

J0.1 Application of Section J

J5.0 Deemed-to-Satisfy Provisions

J5.2 Air-conditioning systems

J5.3 Mechanical ventilation systems

J5.4 Miscellaneous exhaust systems

SPEC-J5.2a-4 Specification J5.2a Fans 4.

Energy efficiency, Verification Method

JV3 Verification Methods JV1 -

SPEC-JV Specification JV Annual Energy Consumption Criteria

Energy efficiency, wall construction

J1.5 Walls

SPEC-J1.5 Specification J1.5 Wall Construction

SPEC-J1.5-1 Specification J1.5 Wall Construction 1.

SPEC-J1.5-2 Specification J1.5 Wall Construction 2.

Evaporative cooler, energy efficiency

J3.7 Evaporative coolers

Exit

C3.8 Openings in fire-isolated exits

C3.9 Service penetrations in fire-isolated exits

D1.0 Deemed-to-Satisfy Provisions

D1.1 Application of Part

D1.2 Number of exits required

D1.3 When fire-isolated exits are required

D1.4 Exit travel distances

D1.5 Distance between alternative exits

D1.6 Dimensions of exits and paths of travel to exits

D1.7 Travel via fire-isolated exits

D1.8 External stairways or ramps in lieu of fire-isolated exits

D1.9 Travel by non-fire-isolated stairways or ramps

D1.10 Discharge from exits

D1.11 Horizontal exits

D1.13 Number of persons accommodated

D1.14 Measurement of distances

D1.15 Method of measurement

D1.16 Plant rooms and lift machine rooms: Concession

D2.0 Deemed-to-Satisfy Provisions

Exit Signs, Photoluminescent

SPEC-E4.8 Specification E4.8 Photoluminescent Exit Signs

Exit, alternative exit

D1.5 Distance between alternative exits

Exit, construction

- D2.0** Deemed-to-Satisfy Provisions
 - D2.1** Application of Part
 - D2.2** Fire-isolated stairways and ramps
 - D2.3** Non-fire-isolated stairways and ramps
 - D2.4** Separation of rising and descending stair flights
 - D2.5** Open access ramps and balconies
 - D2.6** Smoke lobbies
 - D2.7** Installations in exits and paths of travel
 - D2.8** Enclosure of space under stairs and ramps
 - D2.9** Width of stairways and ramps
 - D2.10** Pedestrian ramps
 - D2.11** Fire-isolated passageways
 - D2.12** Roof as open space
 - D2.13** Goings and risers
 - D2.14** Landings
 - D2.15** Thresholds
 - D2.16** Barriers to prevent falls
 - D2.17** Handrails
 - D2.18** Fixed platforms, walkways, stairways and ladders
 - D2.19** Doorways and doors
 - D2.20** Swinging doors
 - D2.21** Operation of latch
 - D2.22** Re-entry from fire-isolated exits
 - D2.23** Signs on doors
 - D2.24** Protection of openable windows

Exit, construction, barrier

- D2.16** Barriers to prevent falls
- D2.24** Protection of openable windows

Exit, construction, door sign

- D2.23** Signs on doors

Exit, construction, door threshold

- D2.15** Thresholds

Exit, construction, doorway and door

- D2.19** Doorways and doors

Exit, construction, enclosure of space

D2.8 Enclosure of space under stairs and ramps

Exit, construction, fire-isolated passageway

D2.11 Fire-isolated passageways

Exit, construction, fire-isolated stairway and ramp

D2.2 Fire-isolated stairways and ramps

Exit, construction, fixed platforms, walkways, stairways and ladders

D2.18 Fixed platforms, walkways, stairways and ladders

Exit, construction, handrail

D2.17 Handrails

Exit, construction, installations in exits

D2.7 Installations in exits and paths of travel

Exit, construction, installations in path of travel

D2.7 Installations in exits and paths of travel

Exit, construction, landing

D2.14 Landings

Exit, construction, latch

D2.21 Operation of latch

Exit, construction, non-fire-isolated stairway and ramp

D2.3 Non-fire-isolated stairways and ramps

Exit, construction, open access ramp or balcony

D2.5 Open access ramps and balconies

Exit, construction, ramp

D2.10 Pedestrian ramps

Exit, construction, re-entry

D2.22 Re-entry from fire-isolated exits

Exit, construction, rising and descending stair flights

D2.4 Separation of rising and descending stair flights

Exit, construction, smoke lobby

D2.6 Smoke lobbies

Exit, construction, stairway

D2.13 Goings and risers

Exit, construction, swinging door

D2.20 Swinging doors

Exit, construction, use of roof

D2.12 Roof as open space

Exit, construction, width of ramp

D2.9 Width of stairways and ramps

Exit, construction, width of stairway

D2.9 Width of stairways and ramps

Exit, dimensions

D1.6 Dimensions of exits and paths of travel to exits

Exit, discharge

D1.10 Discharge from exits

Exit, external stairs in lieu

D1.8 External stairways or ramps in lieu of fire-isolated exits

Exit, fire-isolated

C3.8 Openings in fire-isolated exits

C3.9 Service penetrations in fire-isolated exits

D1.3 When fire-isolated exits are required

D1.7 Travel via fire-isolated exits

Exit, fire-isolated, protection of openings

C3.8 Openings in fire-isolated exits

Exit, fire-isolated, service penetrations

C3.9 Service penetrations in fire-isolated exits

Exit, horizontal

D1.11 Horizontal exits

Exit, measurement of distance

D1.14 Measurement of distances

Exit, method of measurement of distance

D1.15 Method of measurement

Exit, non-fire-isolated

D1.9 Travel by non-fire-isolated stairways or ramps

Exit, number of persons accommodated

D1.13 Number of persons accommodated

Exit, number required

D1.2 Number of exits required

Exit, plant room lift machine room

D1.16 Plant rooms and lift machine rooms: Concession

Exit, re-entry

D2.22 Re-entry from fire-isolated exits

Exit, sign

- [E4.0](#) Deemed-to-Satisfy Provisions
- [E4.5](#) Exit signs
- [E4.6](#) Direction signs
- [E4.7](#) Class 2 and 3 buildings and Class 4 parts: Exemptions
- [E4.8](#) Design and operation of exit signs

Explanatory information

- [A1.8](#) Explanatory Information

External stairs

- [D1.8](#) External stairways or ramps in lieu of fire-isolated exits

External wall

- [C1.11](#) Performance of external walls in fire
- [C3.2](#) Protection of openings in external walls
- [C3.3](#) Separation of external walls and associated openings in different fire compartments

External wall, fire resistance

- [C1.11](#) Performance of external walls in fire

External wall, protection of path of travel

- [D1.7](#) Travel via fire-isolated exits

F

Fans, energy efficiency

- [SPEC-J5.2a](#) Specification J5.2a Fans
- [SPEC-J5.2a-1](#) Specification J5.2a Fans 1.
- [SPEC-J5.2a-2](#) Specification J5.2a Fans 2.
- [SPEC-J5.2a-3](#) Specification J5.2a Fans 3.
- [SPEC-J5.2a-4](#) Specification J5.2a Fans 4.

Farm building

- H3.2** Fire resistance and separation
- H3.4** Construction of exits
- H3.5** Fixed platforms, walkways, stairways and ladders
- H3.6** Thresholds
- H3.7** Swinging doors
- H3.8** Fire fighting equipment
- H3.9** Fire hydrants and water supplies
- H3.10** Fire hose reels
- H3.11** Portable fire extinguishers
- H3.12** Emergency lighting requirements
- H3.13** Exit signs
- H3.14** Direction signs
- H3.15** Design and operation of exit signs
- H3.16** Sanitary facilities
- H3.17** Height of rooms and other spaces
- H3.18** Artificial lighting

Farm Buildings, Farm Sheds

- H3.1** Application of Part
- H3.3** Provision for escape

Farm shed

- H3.2** Fire resistance and separation
- H3.4** Construction of exits
- H3.5** Fixed platforms, walkways, stairways and ladders
- H3.6** Thresholds
- H3.7** Swinging doors
- H3.8** Fire fighting equipment
- H3.9** Fire hydrants and water supplies
- H3.10** Fire hose reels
- H3.11** Portable fire extinguishers
- H3.12** Emergency lighting requirements
- H3.13** Exit signs
- H3.14** Direction signs
- H3.15** Design and operation of exit signs
- H3.16** Sanitary facilities
- H3.17** Height of rooms and other spaces
- H3.18** Artificial lighting

Fencing, early childhood centres

- G1.3** Fencing for early childhood centres

Fire compartmentation

- C2.2** General floor area and volume limitations

Fire compartmentation and separation

- C2.0** Deemed-to-Satisfy Provisions
- C2.1** Application of Part
- C2.5** Class 9a and 9c buildings
- C2.7** Separation by fire walls

Fire compartmentation and separation, aged care building

- C2.5** Class 9a and 9c buildings

Fire compartmentation and separation, fire wall

- C2.7** Separation by fire walls

Fire compartmentation and separation, health-care building

- C2.5** Class 9a and 9c buildings

Fire control centre

- E1.8** Fire control centres
- SPEC-E1.8** Specification E1.8 Fire Control Centres

Fire door

C3.6 Sliding fire doors

Fire door, sliding

C3.6 Sliding fire doors

Fire extinguisher

E1.6 Portable fire extinguishers

Fire fighting equipment

E1.0 Deemed-to-Satisfy Provisions

E1.3 Fire hydrants

E1.4 Fire hose reels

E1.5 Sprinklers

E1.6 Portable fire extinguishers

E1.8 Fire control centres

E1.9 Fire precautions during construction

E1.10 Provision for special hazards

Fire fighting equipment, fire control centre

E1.8 Fire control centres

Fire fighting equipment, fire extinguisher

E1.6 Portable fire extinguishers

Fire fighting equipment, fire hose reel

E1.4 Fire hose reels

Fire fighting equipment, fire hydrant

E1.3 Fire hydrants

Fire fighting equipment, fire precautions during construction

E1.9 Fire precautions during construction

Fire fighting equipment, fire sprinkler system

E1.5 Sprinklers

Fire fighting equipment, provisions for special hazards

E1.10 Provision for special hazards

Fire hazard properties

A2.4 Fire hazard properties

C1.10 Fire hazard properties

SPEC-A2.4 Specification A2.4 Fire Hazard Properties

SPEC-C1.10 Specification C1.10 Fire Hazard Properties

Fire hose reel

E1.4 Fire hose reels

Fire hydrant

E1.3 Fire hydrants

Fire precautions during construction

E1.9 Fire precautions during construction

Fire resistance

A2.3 Fire-resistance of building elements

C1.0 Deemed-to-Satisfy Provisions

C1.1 Type of construction required

C1.2 Calculation of rise in storeys

C1.3 Buildings of multiple classification

C1.4 Mixed types of construction

C1.5 Two storey Class 2, 3 or 9c buildings

C1.6 Class 4 parts of buildings

C1.7 Open spectator stands and indoor sports stadiums

C1.8 Lightweight construction

C1.11 Performance of external walls in fire

SPEC-A2.3 Specification A2.3 Fire-Resistance of Building Elements

Fire resistance, external wall

C1.11 Performance of external walls in fire

Fire resistance, lightweight construction

C1.8 Lightweight construction

Fire resistance, type of construction

C1.1 Type of construction required

C1.5 Two storey Class 2, 3 or 9c buildings

C1.6 Class 4 parts of buildings

C1.7 Open spectator stands and indoor sports stadiums

Fire separation

C2.6 Vertical separation of openings in external walls

C2.8 Separation of classifications in the same storey

C2.9 Separation of classifications in different storeys

C2.10 Separation of lift shafts

C2.11 Stairways and lifts in one shaft

C2.12 Separation of equipment

C2.13 Electricity supply system

Fire separation, electrical supply equipment

C2.13 Electricity supply system

Fire separation, equipment

C2.12 Separation of equipment

Fire separation, lift and stairway shaft

C2.11 Stairways and lifts in one shaft

Fire separation, lift shaft

C2.10 Separation of lift shafts

Fire separation, multiple classification in different storeys

C2.9 Separation of classifications in different storeys

Fire separation, multiple classification in same storey

C2.8 Separation of classifications in the same storey

Fire separation, openings in external wall

C2.6 Vertical separation of openings in external walls

Fire service drive control switch

E3.10 Lift car fire service drive control switch

Fire sprinkler system

E1.5 Sprinklers

SPEC-E1.5 Specification E1.5 Fire Sprinkler Systems

Fire wall

C2.7 Separation by fire walls

C3.5 Doorways in fire walls

C3.6 Sliding fire doors

Fire wall, protection of doorway

C3.5 Doorways in fire walls

Fire-isolated passageway, construction

D2.11 Fire-isolated passageways

Fire-isolated stairway

D2.25 Timber Stairways: Concession

Fire-protected timber

C1.13 Fire-protected timber: Concession

SPEC-A1.1 Specification A1.1 Fire-protected timber

Fire-resisting construction

SPEC-C1.1 Specification C1.1 Fire-Resisting Construction

Fire-resisting construction, attachments

SPEC-C1.1-2.4 Specification C1.1 Fire-Resisting Construction 2. 2.4

Fire-resisting construction, carpark

SPEC-C1.1-2.8 Specification C1.1 Fire-Resisting Construction 2. 2.8

Fire-resisting construction, concessions

SPEC-C1.1-2.5 Specification C1.1 Fire-Resisting Construction 2. 2.5

Fire-resisting construction, fire-source feature

SPEC-C1.1-2.1 Specification C1.1 Fire-Resisting Construction 2. 2.1

Fire-resisting construction, lintel

SPEC-C1.1-2.3 Specification C1.1 Fire-Resisting Construction 2. 2.3

Fire-resisting construction, mezzanine floor

SPEC-C1.1-2.6 Specification C1.1 Fire-Resisting Construction 2. 2.6

Fire-resisting construction, residential aged care building

SPEC-C1.1-2.9 Specification C1.1 Fire-Resisting Construction 2. 2.9

Fire-resisting construction, shaft

SPEC-C1.1-2.7 Specification C1.1 Fire-Resisting Construction 2. 2.7

Fire-resisting construction, support of another part

SPEC-C1.1-2.2 Specification C1.1 Fire-Resisting Construction 2. 2.2

Fire-resisting construction, Type A

SPEC-C1.1-3 Specification C1.1 Fire-Resisting Construction 3.

Fire-resisting construction, Type B

SPEC-C1.1-4 Specification C1.1 Fire-Resisting Construction 4.

Fire-resisting construction, Type C

SPEC-C1.1-5 Specification C1.1 Fire-Resisting Construction 5.

Fire-retardant coating

C1.10 Fire hazard properties

Fire-source feature

SPEC-C1.1-2.1 Specification C1.1 Fire-Resisting Construction 2. 2.1

Fireplace

G2.0 Deemed-to-Satisfy Provisions

G2.3 Open fireplaces

Flood

B1.6 Construction of buildings in flood hazard areas

Floor area and volume limitations

C2.2 General floor area and volume limitations

C2.3 Large Isolated Buildings

Floor area and volume limitations, type of construction

C2.2 General floor area and volume limitations

C2.3 Large Isolated Buildings

Floor construction, energy

SPEC-J1.6-1 Specification J1.6 Floor Construction 1.

SPEC-J1.6-2 Specification J1.6 Floor Construction 2.

Floor construction, energy efficiency

J1.6 Floors

SPEC-J1.6 Specification J1.6 Floor Construction

Floor waste

F1.11 Provision of floor wastes

Flooring, particle board

B1.4 Determination of structural resistance of materials and forms of construction

G

Glazing

B1.4 Determination of structural resistance of materials and forms of construction

D3.12 Glazing on an accessway

F1.13 Glazed assemblies

Glazing, energy efficiency

J2.0 Deemed-to-Satisfy Provisions

J2.1 Application of Part

J2.4 Glazing

Going and risers, stairway

D2.13 Goings and risers

H

Handrail

D2.17 Handrails

Health-care building

C2.5 Class 9a and 9c buildings

Hearing augmentation

D3.7 Hearing augmentation

Heated water supply, energy efficiency

J7.2 Heated water supply

Heating appliance

G2.0 Deemed-to-Satisfy Provisions

G2.2 Installation of appliances

Heating appliance, fireplace

G2.3 Open fireplaces

Heating appliance, incinerator

G2.4 Incinerator rooms

Horizontal exit

C3.7 Protection of doorways in horizontal exits

D1.11 Horizontal exits

Horizontal exit, protection

C3.7 Protection of doorways in horizontal exits

Hot water supply, energy efficiency

J0.0 Deemed-to-Satisfy Provisions

J0.1 Application of Section J

I

Impact sound

SPEC-F5.5 Specification F5.5 Impact Sound - Test of Equivalence

Incinerator

G2.0 Deemed-to-Satisfy Provisions

G2.4 Incinerator rooms

Indoor air quality

FV4.1 Verification Methods - FV4.2

K

Kitchen exhaust

F4.12 Kitchen local exhaust ventilation

L

Landing, construction

D2.14 Landings

Language

A1.7 Language

Large isolated buildings

C2.3 Large Isolated Buildings

C2.4 Requirements for open spaces and vehicular access

Legionella control

F2.7 Microbial (legionella) control

Lift

C3.10 Openings in fire-isolated lift shafts

E3.0 Deemed-to-Satisfy Provisions

E3.2 Stretcher facility in lifts

E3.3 Warning against use of lifts in fire

E3.4 Emergency lifts

E3.5 Landings

E3.6 Passenger lifts

E3.7 Fire service controls

E3.8 Aged care buildings

E3.9 Fire service recall operation switch

E3.10 Lift car fire service drive control switch

Lift and stairway shaft

C2.11 Stairways and lifts in one shaft

Lift cars

SPEC-C1.10 Specification C1.10 Fire Hazard Properties

Lift installations

SPEC-E3.1 Specification E3.1 Lift Installations

Lift shaft

B1.4 Determination of structural resistance of materials and forms of construction

C2.10 Separation of lift shafts

Lift, aged care building

E3.8 Aged care buildings

Lift, car

E3.10 Lift car fire service drive control switch

Lift, emergency

E3.4 Emergency lifts

Lift, fire service control

E3.7 Fire service controls

Lift, fire service recall operation switch

E3.9 Fire service recall operation switch

Lift, landing

E3.5 Landings

Lift, openings in fire-isolated shaft

C3.10 Openings in fire-isolated lift shafts

Lift, people with a disability

E3.6 Passenger lifts

Lift, stretcher facility

E3.2 Stretcher facility in lifts

Lift, warning

E3.3 Warning against use of lifts in fire

Light

F4.0 Deemed-to-Satisfy Provisions

Light, artificial

F4.4 Artificial lighting

Light, natural

F4.1 Provision of natural light

F4.2 Methods and extent of natural lighting

F4.3 Natural light borrowed from adjoining room

Lightweight construction

C1.8 Lightweight construction

C3.17 Columns protected with lightweight construction to achieve an FRL

SPEC-C1.8 Specification C1.8 Structural Tests for Lightweight Construction

Lightweight construction, protection of columns

C3.17 Columns protected with lightweight construction to achieve an FRL

Lightweight construction, structural tests

SPEC-C1.8 Specification C1.8 Structural Tests for Lightweight Construction

Lintel

SPEC-C1.1-2.3 Specification C1.1 Fire-Resisting Construction 2. 2.3

M

Masonry construction

B1.4 Determination of structural resistance of materials and forms of construction

Materials

- A2.1** Suitability of materials
- A2.2** Evidence of suitability
- A2.3** Fire-resistance of building elements
- A2.4** Fire hazard properties
- C1.10** Fire hazard properties
- C1.12** Non-combustible materials
- SPEC-A2.3** Specification A2.3 Fire-Resistance of Building Elements
- SPEC-A2.4** Specification A2.4 Fire Hazard Properties
- SPEC-C1.10** Specification C1.10 Fire Hazard Properties

Materials, fire hazard properties

- A2.4** Fire hazard properties
- C1.10** Fire hazard properties
- SPEC-A2.4** Specification A2.4 Fire Hazard Properties
- SPEC-C1.10** Specification C1.10 Fire Hazard Properties

Materials, fire resistance

- A2.3** Fire-resistance of building elements
- SPEC-A2.3** Specification A2.3 Fire-Resistance of Building Elements

Materials, non-combustible

- C1.12** Non-combustible materials

Materials, suitability

- A2.1** Suitability of materials
- A2.2** Evidence of suitability

Meeting the performance requirements

- A0.2** Meeting the Performance Requirements

Mezzanine

- C1.2** Calculation of rise in storeys

Mezzanine floor

- SPEC-C1.1-2.6** Specification C1.1 Fire-Resisting Construction 2. 2.6

Minor structure

- G1.0** Deemed-to-Satisfy Provisions
- G1.1** Swimming pools
- G1.2** Refrigerated chambers, strong-rooms and vaults
- G1.3** Fencing for early childhood centres

Minor structure, refrigerated chamber, strong room, vault

- G1.2** Refrigerated chambers, strong-rooms and vaults

Minor structure, swimming pool

G1.1 Swimming pools

Multiple classification

A3.3 Multiple classification

A3.4 Parts with more than one classification

C1.3 Buildings of multiple classification

Multiple classification in different storeys

C2.9 Separation of classifications in different storeys

Multiple classification in same storey

C2.8 Separation of classifications in the same storey

N

Non required, stairway, ramp, escalator

D1.12 Non-required stairways, ramps or escalators

Non-combustible materials

C1.12 Non-combustible materials

Number of persons accommodated

D1.13 Number of persons accommodated

O

Open space

C2.4 Requirements for open spaces and vehicular access

Open spectator stand, indoor sports stadium

C1.7 Open spectator stands and indoor sports stadiums

SPEC-C1.1-3.8 Specification C1.1 Fire-Resisting Construction 3. 3.8

Openings in external wall

C2.6 Vertical separation of openings in external walls

Openings, method of protection

C3.4 Acceptable methods of protection

Openings, protection

- C3.0** Deemed-to-Satisfy Provisions
- C3.1** Application of Part
- C3.2** Protection of openings in external walls
- C3.3** Separation of external walls and associated openings in different fire compartments
- C3.4** Acceptable methods of protection
- C3.5** Doorways in fire walls
- C3.6** Sliding fire doors
- C3.7** Protection of doorways in horizontal exits
- C3.8** Openings in fire-isolated exits
- C3.9** Service penetrations in fire-isolated exits
- C3.10** Openings in fire-isolated lift shafts
- C3.12** Openings in floors and ceilings for services
- C3.13** Openings in shafts
- C3.15** Openings for service installations
- C3.16** Construction joints

Openings, protection, atrium

- C3.0** Deemed-to-Satisfy Provisions

Openings, protection, construction joints

- C3.16** Construction joints

Openings, protection, doorway in fire wall

- C3.5** Doorways in fire walls
- C3.6** Sliding fire doors

Openings, protection, doorway in horizontal exit

- C3.7** Protection of doorways in horizontal exits

Openings, protection, external wall

- C3.2** Protection of openings in external walls
- C3.3** Separation of external walls and associated openings in different fire compartments

Openings, protection, fire-isolated exit

- C3.8** Openings in fire-isolated exits

Openings, protection, in fire-isolated lift shaft

- C3.10** Openings in fire-isolated lift shafts

Openings, protection, openings in shaft

- C3.13** Openings in shafts

Openings, protection, service penetrations

C3.15 Openings for service installations

Openings, protection, service penetrations in fire-isolated exit

C3.9 Service penetrations in fire-isolated exits

Openings, protection, service penetrations in floors and ceilings

C3.12 Openings in floors and ceilings for services

Openings, protection, theatre, stage and public hall

C3.0 Deemed-to-Satisfy Provisions

P

Path of travel

D1.6 Dimensions of exits and paths of travel to exits

D2.7 Installations in exits and paths of travel

Path of travel, dimensions

D1.6 Dimensions of exits and paths of travel to exits

Path of travel, installations within

D2.7 Installations in exits and paths of travel

Path of travel, protection of external wall

D1.7 Travel via fire-isolated exits

People with a disability, lift

E3.6 Passenger lifts

People with a disability, sanitary facilities

F2.2 Calculation of number of occupants and fixtures

F2.4 Accessible sanitary facilities

Piling

B1.4 Determination of structural resistance of materials and forms of construction

Piping, vessels, heat exchangers and tanks, energy efficiency

SPEC-J5.2c Specification J5.2c Piping, Vessel, Heat Exchanger and Tank Insulation

SPEC-J5.2c-1 Specification J5.2c Piping, Vessel, Heat Exchanger and Tank Insulation 1.

SPEC-J5.2c-2 Specification J5.2c Piping, Vessel, Heat Exchanger and Tank Insulation 2.

Power control, energy efficiency

J0.0 Deemed-to-Satisfy Provisions

J0.1 Application of Section J

J5.2 Air-conditioning systems

J5.3 Mechanical ventilation systems

J6.0 Deemed-to-Satisfy Provisions

J6.3 Interior artificial lighting and power control

SPEC-J6 Specification J6 Lighting and Power Control Devices

Proscenium wall

H1.3 Proscenium wall construction

SPEC-H1.3 Specification H1.3 Construction of Proscenium Walls

Public

H2.1 Application of Part

H2.2 Accessways

Public corridor

C2.14 Public corridors in Class 2 and 3 buildings

Public transport

H2.1 Application of Part

H2.2 Accessways

H2.3 Ramps

H2.4 Handrails and grabrails

H2.5 Doorways and doors

H2.6 Lifts

H2.7 Stairways

H2.8 Unisex accessible toilet

H2.9 Location of accessible toilets

H2.10 Symbols and signs

H2.11 Tactile ground surface indicators

H2.12 Lighting

H2.13 Hearing augmentation

H2.14 Emergency warning systems

H2.15 Controls

Pumps

F5.7 Sound isolation of pumps

R

Ramp

- D2.10** Pedestrian ramps
- D2.8** Enclosure of space under stairs and ramps
- D3.11** Ramps

Ramp, construction, width

- D2.9** Width of stairways and ramps

Refrigerated chamber, strong room, vault

- G1.2** Refrigerated chambers, strong-rooms and vaults

Residential aged care building

- SPEC-C1.1-2.9** Specification C1.1 Fire-Resisting Construction 2. 2.9

Resistance to the incipient spread of fire

- A2.5** Resistance to the incipient spread of fire

Rise in storeys

- C1.2** Calculation of rise in storeys

Roof and ceiling construction, energy

- SPEC-J1.3-1** Specification J1.3 Roof and Ceiling Construction 1.
- SPEC-J1.3-2** Specification J1.3 Roof and Ceiling Construction 2.

Roof and ceiling construction, energy efficiency

- J1.3** Roof and ceiling construction
- SPEC-J1.3** Specification J1.3 Roof and Ceiling Construction

Roof construction

- B1.4** Determination of structural resistance of materials and forms of construction

Roof coverings

- F1.5** Roof coverings

Roof lights, energy efficiency

- J1.4** Roof lights

Rooflight

- SPEC-C1.1-3.6** Specification C1.1 Fire-Resisting Construction 3. 3.6

Room heights

- F3.0** Deemed-to-Satisfy Provisions
- F3.1** Height of rooms and other spaces

S

Sanitary and other facilities

- F2.0** Deemed-to-Satisfy Provisions
- F2.1** Facilities in residential buildings
- F2.2** Calculation of number of occupants and fixtures
- F2.3** Facilities in Class 3 to 9 buildings
- F2.4** Accessible sanitary facilities
- F2.5** Construction of sanitary compartments
- F2.6** Interpretation: Urinals and washbasins
- F2.7** Microbial (legionella) control
- F2.8** Waste management

Sanitary and other facilities, construction of sanitary compartment

- F2.5** Construction of sanitary compartments

Sanitary and other facilities, legionella control

- F2.7** Microbial (legionella) control

Sanitary and other facilities, urinals and washbasins

- F2.6** Interpretation: Urinals and washbasins

Sanitary and other facilities, waste management

- F2.8** Waste management

Sarking

- F1.6** Sarking

Service penetrations

- C3.9** Service penetrations in fire-isolated exits
- C3.12** Openings in floors and ceilings for services
- C3.15** Openings for service installations

Service penetrations, fire-isolated exits

- C3.9** Service penetrations in fire-isolated exits

Service penetrations, protection of openings

- C3.12** Openings in floors and ceilings for services
- C3.15** Openings for service installations

Shading, energy efficiency

- J2.5** Shading

Shaft

- C3.13** Openings in shafts
- SPEC-C1.1-2.7** Specification C1.1 Fire-Resisting Construction 2. 2.7

Shaft, enclosure

SPEC-C1.1-2.7 Specification C1.1 Fire-Resisting Construction 2. 2.7

Shaft, protection of openings

C3.13 Openings in shafts

Smoke alarm system

SPEC-E2.2a Specification E2.2a Smoke Detection and Alarm Systems

Smoke and heat vents

SPEC-E2.2c Specification E2.2c Smoke-and-Heat Vents

Smoke detection and alarm system

E2.0 Deemed-to-Satisfy Provisions

SPEC-E2.2a Specification E2.2a Smoke Detection and Alarm Systems

Smoke exhaust system

SPEC-E2.2b Specification E2.2b Smoke Exhaust Systems

Smoke hazard management

E2.0 Deemed-to-Satisfy Provisions

E2.1 Application of Part

E2.2 General requirements

E2.3 Provision for special hazards

Smoke hazard management system

SPEC-E2.2b Specification E2.2b Smoke Exhaust Systems

SPEC-E2.2c Specification E2.2c Smoke-and-Heat Vents

Smoke hazard management system, smoke and heat vents

SPEC-E2.2c Specification E2.2c Smoke-and-Heat Vents

Smoke hazard management system, smoke exhaust system

SPEC-E2.2b Specification E2.2b Smoke Exhaust Systems

Smoke hazard management, special hazards

E2.3 Provision for special hazards

Smoke lobby

D2.6 Smoke lobbies

Smoke separation

C2.14 Public corridors in Class 2 and 3 buildings

Smoke separation, public corridor

C2.14 Public corridors in Class 2 and 3 buildings

Soil and waste pipes

F5.6 Sound insulation rating of services

Sound

E4.9 Sound systems and intercom systems for emergency purposes

Sound transmission and insulation

F5.0 Deemed-to-Satisfy Provisions

F5.1 Application of Part

F5.2 Determination of airborne sound insulation ratings

F5.3 Determination of impact sound insulation ratings

F5.4 Sound insulation rating of floors

F5.5 Sound insulation rating of walls

F5.6 Sound insulation rating of services

F5.7 Sound isolation of pumps

SPEC-F5.2 Specification F5.2 Sound Insulation for Building Elements

SPEC-F5.5 Specification F5.5 Impact Sound - Test of Equivalence

Sound transmission and insulation, impact sound

SPEC-F5.5 Specification F5.5 Impact Sound - Test of Equivalence

Sound transmission and insulation, pumps

F5.7 Sound isolation of pumps

Sound transmission and insulation, soil and waste pipes

F5.6 Sound insulation rating of services

Sound transmission and insulation, sound insulation for building elements

SPEC-F5.2 Specification F5.2 Sound Insulation for Building Elements

Spa, energy efficiency

J7.0 Deemed-to-Satisfy Provisions

J7.4 Spa pool heating and pumping

Space heating, energy efficiency

SPEC-J5.2d Specification J5.2d Space Heating

SPEC-J5.2d-1 Specification J5.2d Space Heating 1.

SPEC-J5.2d-2b Specification J5.2d Space Heating 2.

Special hazards

E1.10 Provision for special hazards

E2.3 Provision for special hazards

Special hazards, smoke hazard management

E2.3 Provision for special hazards

Stairway, construction

- D2.13** Goings and risers
- D2.14** Landings
- D2.8** Enclosure of space under stairs and ramps
- D2.9** Width of stairways and ramps

Stairway, construction, landing

- D2.14** Landings

Stairway, construction, width

- D2.9** Width of stairways and ramps

Stairway, goings and risers

- D2.13** Goings and risers

Stairway, ramp, escalator

- D1.12** Non-required stairways, ramps or escalators
- SPEC-D1.12** Specification D1.12 Non-Required Stairways, Ramps and Escalators

Stairway, ramp, escalator, non-required

- SPEC-D1.12** Specification D1.12 Non-Required Stairways, Ramps and Escalators

Stairway, rising and descending stair flights

- D2.4** Separation of rising and descending stair flights

Standards

- A1.2** Adoption of Standards and other references
- A1.3** Referenced Standards, etc
- A1.4** Differences between referenced documents and the NCC
- SPEC-A1.3** Specification A1.3 Documents Adopted By Reference

State/Territory Appendices

- A1.6** Application of the NCC to a particular State or Territory

Steel column

- SPEC-C1.1-2.5** Specification C1.1 Fire-Resisting Construction 2. 2.5

Steel construction

- B1.4** Determination of structural resistance of materials and forms of construction

Stormwater drainage

- F1.1** Stormwater drainage

Structural

- B1.0** Deemed-to-Satisfy Provisions
- B1.1** Resistance to actions
- B1.2** Determination of individual actions
- B1.4** Determination of structural resistance of materials and forms of construction

Structural Software

B1.5 Structural software

Structures on roof

SPEC-C1.1-2.5 Specification C1.1 Fire-Resisting Construction 2. 2.5

Subfloor ventilation

F1.12 Subfloor ventilation

Suitability of materials

A2.1 Suitability of materials

A2.2 Evidence of suitability

Support of another part

SPEC-C1.1-2.2 Specification C1.1 Fire-Resisting Construction 2. 2.2

Swimming pool, energy efficiency

J7.0 Deemed-to-Satisfy Provisions

J7.3 Swimming pool heating and pumping

Swimming pools

D3.10 Swimming pools

G1.1 Swimming pools

SPEC-D3.10 Specification D3.10 Accessible water entry/exit for swimming pools

System

E4.9 Sound systems and intercom systems for emergency purposes

System and intercom

E4.9 Sound systems and intercom systems for emergency purposes

T

Tactile

D3.6 Signage

Tactile indicators

D3.8 Tactile indicators

Tactile signs

SPEC-D3.6 Specification D3.6 Braille and Tactile Signs

Termites

B1.4 Determination of structural resistance of materials and forms of construction

Theatre, stage and public hall

C1.0 Deemed-to-Satisfy Provisions

C2.0 Deemed-to-Satisfy Provisions

C3.0 Deemed-to-Satisfy Provisions

D1.0 Deemed-to-Satisfy Provisions

D2.0 Deemed-to-Satisfy Provisions

D3.0 Deemed-to-Satisfy Provisions

H1.1 Application of Part

H1.2 Separation

H1.3 Proscenium wall construction

H1.4 Seating area

H1.5 Exits from theatre stages

H1.6 Access to platforms and lofts

H1.7 Aisle lights in theatres

SPEC-H1.3 Specification H1.3 Construction of Proscenium Walls

Theatre, stage and public hall, proscenium wall

SPEC-H1.3 Specification H1.3 Construction of Proscenium Walls

Thermal construction

J1.2 Thermal construction — general

Threshold, doorway

D2.15 Thresholds

Timber column

SPEC-C1.1-2.5 Specification C1.1 Fire-Resisting Construction 2. 2.5

Timber construction

B1.4 Determination of structural resistance of materials and forms of construction

Timber stairways

D2.25 Timber Stairways: Concession

Type A construction

SPEC-C1.1-3 Specification C1.1 Fire-Resisting Construction 3.

Type A construction, carpark

SPEC-C1.1-3.9 Specification C1.1 Fire-Resisting Construction 3. 3.9

Type A construction, open spectator stand, indoor sports

SPEC-C1.1-3.8 Specification C1.1 Fire-Resisting Construction 3. 3.8

Type A construction, rooflight

SPEC-C1.1-3.6 Specification C1.1 Fire-Resisting Construction 3. 3.6

Type B construction

SPEC-C1.1-4 Specification C1.1 Fire-Resisting Construction 4.

Type B construction, carpark

SPEC-C1.1-4.2 Specification C1.1 Fire-Resisting Construction 4. 4.2

Type C construction

SPEC-C1.1-5 Specification C1.1 Fire-Resisting Construction 5.

Type C construction, carpark

SPEC-C1.1-5.2 Specification C1.1 Fire-Resisting Construction 5. 5.2

Type of construction

C1.1 Type of construction required

C1.2 Calculation of rise in storeys

C1.3 Buildings of multiple classification

C1.4 Mixed types of construction

C1.5 Two storey Class 2, 3 or 9c buildings

C1.6 Class 4 parts of buildings

C1.7 Open spectator stands and indoor sports stadiums

C2.2 General floor area and volume limitations

C2.3 Large Isolated Buildings

Type of construction, mixed

C1.4 Mixed types of construction

Type of construction, multiple classification

C1.3 Buildings of multiple classification

Type of construction, rise in storeys

C1.2 Calculation of rise in storeys

U

United buildings

A4.1 When buildings are united

A4.2 Alterations in a united building

V

Vehicular access

C2.4 Requirements for open spaces and vehicular access

Ventilation

- F4.0** Deemed-to-Satisfy Provisions
- F4.5** Ventilation of rooms
- F4.6** Natural ventilation
- F4.7** Ventilation borrowed from adjoining room
- F4.8** Restriction on position of water closets and urinals
- F4.9** Airlocks
- F4.11** Carparks
- F4.12** Kitchen local exhaust ventilation
- FV4.1** Verification Methods - FV4.2

Ventilation systems, energy efficiency

- J0.0** Deemed-to-Satisfy Provisions
- J0.1** Application of Section J
- J5.0** Deemed-to-Satisfy Provisions
- J5.2** Air-conditioning systems
- J5.3** Mechanical ventilation systems
- J5.4** Miscellaneous exhaust systems
- SPEC-J5.2a-4** Specification J5.2a Fans 4.

Ventilation, carpark

- F4.11** Carparks

Ventilation, kitchen exhaust

- F4.12** Kitchen local exhaust ventilation

Verification method

- FV4.1** Verification Methods - FV4.2

Verification Method, energy

- JV3** Verification Methods JV1 -

Verification Method, energy efficiency

- SPEC-JV** Specification JV Annual Energy Consumption Criteria

Visibility in an emergency

- E4.0** Deemed-to-Satisfy Provisions

W

Wall construction, energy

- SPEC-J1.5-1** Specification J1.5 Wall Construction 1.
- SPEC-J1.5-2** Specification J1.5 Wall Construction 2.

Wall construction, energy efficiency

J1.5 Walls

SPEC-J1.5 Specification J1.5 Wall Construction

Water closets and urinals

F4.8 Restriction on position of water closets and urinals

F4.9 Airlocks

Wet areas

F1.7 Water proofing of wet areas in buildings

Wheelchair seating spaces

D3.9 Wheelchair seating spaces in Class 9b assembly buildings

ARCHIVED
INDEX, ABBREVIATIONS AND SYMBOLS

ABBREVIATIONS AND SYMBOLS

Abbreviations and Symbols used in the BCA include:

ABBREVIATIONS

ABCB	Australian Building Codes Board
AISC	Australian Institute of Steel Construction
ALGA	Australian Local Government Association
AS	Australian Standard
ASTM	American Society for Testing and Materials
BCA	Building Code of Australia
BCC	Building Codes Committee
C_{SHGC}	Constant for solar heat gain
CSIRO	Commonwealth Scientific and Industrial Research Organisation
C_u	Constant for conductance
FRL	Fire Resistance Level
GRP	Glass fibre reinforced polyester
ISO	International Organisation for Standardisation
MEPS	Minimum Energy Performance Standards
NATA	National Association of Testing Authorities
ppm	Parts per million
PVC	Polyvinyl chloride
R_w	Weighted sound reduction index
SHGC	Solar Heat Gain Coefficient
STC	Sound Transmission Class
UPVC	Unplasticized polyvinyl chloride
U-Value	Thermal transmittance

SYMBOLS (SI UNITS)

dB(A)	decibels "A" scale weighting network
°C	degree(s) Celsius
°CDB	degree(s) Celsius Dry Bulb
°CWB	degree(s) Celsius Wet Bulb
-e/MJ	equivalent per MegaJoule(s)
J	Joule(s)

ARCHIVED
INDEX, ABBREVIATIONS AND SYMBOLS

J/kg.K	Joules per kilogram per degree Kelvin
J/s.m ²	Joules per second per square metre
K	kelvin(s)
kg	kilogram(s)
kg/m	kilogram(s) per metre
kg/m ²	kilogram(s) per square metre
kg/m ³	kilogram(s) per cubic metre
KJ/hour.m ²	kiloJoules per hour per square metre
kPa	kilopascal(s)
kW/m ²	kilowatt(s) per square metre
kW _{heating}	kilowatt(s) of heating
kWr	kilowatt(s) of refrigeration
L	litre(s)
L/s	litre(s) per second
L/s.m ²	litre(s) per second square metre
Lumens/W	Lumens per Watt
lx	lux
m	metre(s)
m ²	square metre(s)
m ³	cubic metre(s)
mcd/m ²	millicandelas per square metre
MJ/hour	MegaJoules per hour
MJ/m ² .annum	MegaJoules per square metre annum
m/s	metre(s) per second
m ³ /s	cubic metre(s) per second
mm	millimetre(s)
mm ²	square millimetre(s)
µm	micrometre
MW	megawatt(s)
N	newton(s)
Pa	pascal(s)
W	Watt(s)
W _{input power}	Watts of input power
W/m.K	Watts per metre per degree Kelvin
W/m ²	Watts per square metre

HISTORY OF ADOPTION

CONTENTS

HISTORY OF ADOPTION

History of Adoption

- 1.0 Adoption of BCA96
- 1.1 Amendment No. 1
- 1.2 Amendment No. 2
- 1.3 Amendment No. 3
- 1.4 Amendment No. 4
- 1.5 Amendment No. 5
- 1.6 Amendment No. 6
- 1.7 Amendment No. 7
- 1.8 Amendment No. 8
- 1.9 Amendment No. 9
- 1.10 Amendment No. 10
- 1.11 Amendment No. 11
- 1.12 Amendment No. 12
- 1.13 Amendment No. 13
- 2.0 Adoption of BCA 2004
- 3.0 Adoption of BCA 2005
- 4.0 Adoption of BCA 2006
- 5.0 Adoption of BCA 2007
- 6.0 Adoption of BCA 2008
- 7.0 Adoption of BCA 2009
- 8.0 Adoption of BCA 2010
- 9.0 Adoption of BCA 2011
- 10.0 Adoption of BCA 2012
- 11.0 Adoption of BCA 2013
- 12.0 Adoption of BCA 2014
- 13.0 Adoption of BCA 2015
- 14.0 Adoption of NCC Volume One 2016

HISTORY OF ADOPTION

1.0 Adoption of BCA96

The 1996 edition of the BCA was adopted as set out in Table Amdt 1.0.

Table 1.0 History of adoption of BCA96

Administration	Adoption Date
Australian Government	1 July 1997
Australian Capital Territory	1 July 1997
New South Wales	1 July 1997
Northern Territory	7 January 1998
Queensland	1 July 1997
South Australia	1 January 1998
Tasmania	1 July 1997
Victoria	1 August 1997
Western Australia	1 July 1997

1.1 Amendment No. 1

(a) Amendment No. 1 of the 1996 edition of the BCA was adopted as set out in Table 1.1.

Table 1.1 History of adoption of Amendment No. 1 of the BCA96

Administration	Adoption Date
Australian Government	1 July 1997
Australian Capital Territory	1 July 1997
New South Wales	1 July 1997
Northern Territory	7 January 1998
Queensland	1 July 1997
South Australia	1 January 1998
Tasmania	1 July 1997
Victoria	1 August 1997
Western Australia	1 July 1997

(b) The purpose of Amendment No. 1 is to—

- (i) correct minor typographical errors including spelling, punctuation and layout; and
- (ii) include reference to a Certificate of Conformity issued by the ABCB in A2.2; and
- (iii) change the reference to the Standards Mark Certificate to refer to JAS–ANZ in A2.2; and

- (iv) update references to Standards.

Note:

Only substantive typographical corrections are noted in the margin.

1.2 Amendment No. 2

- (a) Amendment No. 2 of the 1996 edition of the BCA was adopted as set out in Table 1.2.

Table 1.2 History of adoption of Amendment No. 2 of the BCA96

Administration	Adoption Date
Australian Government	1 January 1998
Australian Capital Territory	1 January 1998
New South Wales	27 February 1998
Northern Territory	7 January 1998
Queensland	1 January 1998
South Australia	1 January 1998
Tasmania	1 January 1998
Victoria	1 January 1998
Western Australia	1 January 1998

- (b) The purpose of Amendment No. 2 is to—
- (i) correct minor typographical errors; and
 - (ii) update references to Standards.

1.3 Amendment No. 3

- (a) Amendment No. 3 of the 1996 edition of the BCA was adopted as set out in Table 1.3.

Table 1.3 History of adoption of Amendment No. 3 of the BCA96

Administration	Adoption Date
Australian Government	1 July 1998
Australian Capital Territory	1 July 1998
New South Wales	1 July 1998
Northern Territory	1 July 1998
Queensland	1 July 1998
South Australia	13 July 1998
Tasmania	1 July 1998
Victoria	1 July 1998
Western Australia	1 July 1998

- (b) The purpose of Amendment No. 3 is to—
- (i) incorporate the outcomes of the 1997 ABCB Variations Conference; and

- (ii) update references to Standards; and
- (iii) include minor technical changes.

1.4 Amendment No. 4

- (a) Amendment No. 4 of the 1996 edition of the BCA was adopted by the Australian Government, States and Territories as set out in Table 1.4.

Table 1.4 History of adoption of Amendment No. 4 of the BCA96

Administration	Adoption Date
Australian Government	1 January 1999
Australian Capital Territory	17 May 1999
New South Wales	1 February 1999
Northern Territory	1 January 1999
Queensland	1 January 1999
South Australia	1 January 1999
Tasmania	1 January 1999
Victoria	1 January 1999
Western Australia	1 January 1999

- (b) The purpose of Amendment No. 4 is to—
 - (i) update references to Standards; and
 - (ii) include minor technical changes.

Note:

Only substantive typographical corrections are noted in the margin.

1.5 Amendment No. 5

- (a) Amendment No. 5 of the 1996 edition of the BCA was adopted as set out in Table 1.5.

Table 1.5 History of adoption of Amendment No. 5 of the BCA96

Administration	Adoption Date
Australian Government	1 July 1999
Australian Capital Territory	3 November 1999
New South Wales	1 August 1999
Northern Territory	1 July 1999
Queensland	1 July 1999
South Australia	1 July 1999
Tasmania	1 July 1999
Victoria	1 July 1999
Western Australia	1 July 1999

- (b) The purpose of Amendment No. 5 is to—
- (i) update references to Standards; and
 - (ii) include minor technical changes; and
 - (iii) amend clauses to improve clarity and to reduce the possibility of differences in interpretation; and
 - (iv) expand on the requirements for subfloor ventilation based on climatic conditions.

Note:

Only substantive typographical corrections are noted in the margin.

1.6 Amendment No. 6

- (a) Amendment No. 6 of the 1996 edition of the BCA was adopted as set out in Table 1.6.

Table 1.6 History of adoption of Amendment No. 6 of the BCA96

Administration	Adoption Date
Australian Government	1 January 2000
Australian Capital Territory	10 February 2000
New South Wales	1 January 2000
Northern Territory	1 January 2000
Queensland	1 January 2000
South Australia	17 January 2000
Tasmania	1 January 2000
Victoria	1 January 2000
Western Australia	1 January 2000

- (b) The purpose of Amendment No. 6 is to—
- (i) update references to Standards; and
 - (ii) expand on the requirements for carparking for people with disabilities; and
 - (iii) replace Sound Transmission Class (STC) with weighted sound reduction index (R_w) within Part F5; and
 - (iv) include minor technical changes.

Note:

Only substantive typographical corrections are noted in the margin.

1.7 Amendment No. 7

- (a) Amendment No. 7 of the 1996 edition of the BCA was adopted as set out in Table 1.7.

Table 1.7 History of adoption of Amendment No. 7 of the BCA96

Administration	Adoption Date
Australian Government	1 July 2000

Table 1.7 History of adoption of Amendment No. 7 of the BCA96 — continued

Administration	Adoption Date
Australian Capital Territory	10 July 2000
New South Wales	1 July 2000
Northern Territory	1 July 2000
Queensland	1 July 2000
South Australia	1 July 2000
Tasmania	1 July 2000
Victoria	1 July 2000
Western Australia	1 July 2000

- (b) The purpose of Amendment No. 7 is to—
- (i) update references to Standards; and
 - (ii) include requirements for non-required and private stairways; and
 - (iii) include minor technical changes.

Note:

Only substantive typographical corrections are noted in the margin.

1.8 Amendment No. 8

- (a) Amendment No. 8 of the 1996 edition of the BCA was adopted as set out in Table 1.8.

Table 1.8 History of adoption of Amendment No. 8 of the BCA96

Administration	Adoption Date
Australian Government	1 January 2001
Australian Capital Territory	11 January 2001
New South Wales	1 January 2001
Northern Territory	1 January 2001
Queensland	1 January 2001
South Australia	1 January 2001
Tasmania	1 January 2001
Victoria	1 January 2001
Western Australia	1 January 2001

- (b) The purpose of Amendment No. 8 is to—
- (i) update references to Standards; and
 - (ii) include minor technical changes; and

- (iii) achieve greater consistency between both Volumes of the BCA for stairway construction.

Note:

Only substantive typographical corrections are noted in the margin.

1.9 Amendment No. 9

- (a) Amendment No. 9 of the 1996 edition of the BCA was adopted as set out in Table 1.9.

Table 1.9 History of adoption of Amendment No. 9 of the BCA96

Administration	Adoption Date
Australian Government	1 July 2001
Australian Capital Territory	12 July 2001
New South Wales	1 July 2001
Northern Territory	1 July 2001
Queensland	1 July 2001
South Australia	2 July 2001
Tasmania	1 July 2001
Victoria	1 July 2001
Western Australia	1 July 2001

- (b) The purpose of Amendment No. 9 is to—
 - (i) update references to Standards; and
 - (ii) include minor technical changes; and
 - (iii) clarify which glazed assemblies must comply with AS 2047 and which must comply with AS 1288.

Note:

Only substantive typographical corrections are noted in the margin.

1.10 Amendment No. 10

- (a) Amendment No. 10 of the 1996 edition of the BCA was adopted as set out in Table 1.10.

Table 1.10 History of adoption of Amendment No. 10 of the BCA96

Administration	Adoption Date
Australian Government	1 January 2002
Australian Capital Territory	1 January 2002
New South Wales	1 January 2002
Northern Territory	1 January 2002
Queensland	1 January 2002
South Australia	1 January 2002

Table 1.10 History of adoption of Amendment No. 10 of the BCA96 — continued

Administration	Adoption Date
Tasmania	1 January 2002
Victoria	1 January 2002
Western Australia	1 January 2002

- (b) The purpose of Amendment No. 10 is to—
- (i) update references to Standards; and
 - (ii) clarify that windows must comply with AS 2047 for resistance to water penetration; and
 - (iii) subject to certain conditions, allow a non-fire-isolated stairway to connect an additional storey; and
 - (iv) update signage required for people with disabilities, including the need for signs to contain Braille and tactile information; and
 - (v) include minor technical changes.

Note:

Only substantive typographical corrections are noted in the margin.

1.11 Amendment No. 11

- (a) Amendment No. 11 of the 1996 edition of the BCA was adopted as set out in Table 1.11.

Table 1.11 History of adoption of Amendment No. 11 of the BCA96

Administration	Adoption Date
Australian Government	1 July 2002
Australian Capital Territory	1 July 2002
New South Wales	1 July 2002
Northern Territory	1 July 2002
Queensland	1 July 2002
South Australia	1 July 2002
Tasmania	1 July 2002
Victoria	1 July 2002
Western Australia	1 July 2002

- (b) The purpose of Amendment No. 11 is to—
- (i) update references to Standards; and
 - (ii) transfer public policy matters, with respect to structural adequacy, from the AS 1170 series to the BCA; and
 - (iii) introduce Class 7a, 7b and 9c classifications; and
 - (iv) update the provisions for residential buildings used for the accommodation of the aged to align with the Commonwealth Aged Care Act, 1997; and

- (v) include minor technical changes.

Note:

Only substantive typographical corrections are noted in the margin.

1.12 Amendment No. 12

- (a) Amendment No. 12 of the 1996 edition of the BCA was adopted as set out in Table 1.12.

Table 1.12 History of adoption of Amendment No. 12 of the BCA96

Administration	Adoption Date
Australian Government	1 January 2003
Australian Capital Territory	1 January 2003
New South Wales	1 January 2003
Northern Territory	1 January 2003
Queensland	1 January 2003
South Australia	1 January 2003
Tasmania	1 January 2003
Victoria	1 January 2003
Western Australia	1 January 2003

- (b) The purpose of Amendment No. 12 is to—
 - (i) update references to Standards; and
 - (ii) apply the swimming pool safety provisions to swimming pools associated with Class 4 parts as well as Class 2 and 3 buildings; and
 - (iii) allow the use of either the 1989 editions or the 2002 editions of the 1170 series of standards; and
 - (iv) include minor technical changes.

Note:

Only substantive typographical corrections are noted in the margin.

1.13 Amendment No. 13

- (a) Amendment No. 13 of the 1996 edition of the BCA was adopted as set out in Table 1.13.

Table 1.13 History of adoption of Amendment No. 13 of the BCA96

Administration	Adoption Date
Australian Government	1 July 2003
Australian Capital Territory	1 July 2003
New South Wales	1 July 2003
Northern Territory	1 July 2003
Queensland	1 July 2003

Table 1.13 History of adoption of Amendment No. 13 of the BCA96 — continued

Administration	Adoption Date
South Australia	To be advised
Tasmania	1 July 2003
Victoria	1 July 2003
Western Australia	1 July 2003

- (b) The purpose of Amendment No. 13 is to—
- (i) update references to Standards; and
 - (ii) reform the provisions for fire hazard properties of materials; and
 - (iii) revise a requirement for the use of non-combustible materials; and
 - (iv) include additional requirements for the protection of electrical switchboards which sustain electricity supply to emergency equipment; and
 - (v) include minor changes to the requirements for aged care buildings; and
 - (vi) include minor technical changes.

Note:

Only substantive typographical corrections are noted in the margin.

2.0 Adoption of BCA 2004

- (a) The 2004 edition of the BCA was adopted as set out in Table 2.0.

Table 2.0 History of adoption of BCA 2004

Administration	Adoption Date
Australian Government	1 May 2004
Australian Capital Territory	1 May 2004
New South Wales	1 May 2004
Northern Territory	1 May 2004
Queensland	1 May 2004
South Australia	1 May 2004
Tasmania	1 May 2004
Victoria	1 May 2004
Western Australia	1 May 2004

- (b) The purpose of BCA 2004 is to—
- (i) update references to Standards; and
 - (ii) update references from BCA 96 to BCA 2004; and
 - (iii) include a Performance Requirement considering human impact with glazing; and
 - (iv) reform the provisions for sound insulation; and
 - (v) reform the maintenance provisions; and

- (vi) include minor technical changes.

3.0 Adoption of BCA 2005

- (a) The 2005 edition of the BCA was adopted as set out in Table 3.0.

Table 3.0 History of adoption of BCA 2005

Administration	Adoption Date
Australian Government	1 May 2005
Australian Capital Territory	1 May 2005
New South Wales	1 May 2005
Northern Territory	1 May 2005
Queensland	1 May 2005
South Australia	1 May 2005
Tasmania	1 May 2005
Victoria	1 May 2005
Western Australia	1 May 2005

- (b) The purpose of BCA 2005 is to—
 - (i) update references to Standards; and
 - (ii) clarify when fire sprinklers are required to be installed in buildings; and
 - (iii) update the provisions for waterproofing of wet areas; and
 - (iv) include energy efficiency measures for Class 2 and 3 buildings and Class 4 parts; and
 - (v) more closely align the requirements for lifts with those of Occupational Health and Safety legislation; and
 - (vi) include minor technical changes.

4.0 Adoption of BCA 2006

- (a) The 2006 edition of the BCA was adopted as set out in Table 4.0.

Table 4.0 History of adoption of BCA 2006

Administration	Adoption Date
Australian Government	1 May 2006
Australian Capital Territory	1 May 2006
New South Wales	1 May 2006 (except that the date for mandatory compliance with Section J provisions for Class 5 to 9 buildings is 1 November 2006)
Northern Territory	1 May 2006
Queensland	1 May 2006

Table 4.0 History of adoption of BCA 2006 — continued

Administration	Adoption Date
South Australia	1 May 2006, except for Part I2 and Section J which were adopted on 1 August 2006
Tasmania	1 May 2006
Victoria	1 May 2006
Western Australia	1 May 2006

- (b) The purpose of BCA 2006 is to—
- (i) update schedule of referenced documents; and
 - (ii) include a national testing regime for cladding in cyclonic areas; and
 - (iii) withdraw of AS1530.3 tests on floor materials and floor coverings and wall and ceiling linings; and
 - (iv) include energy efficiency measures for Class 5 to 9 buildings; and
 - (v) include minor technical changes.

5.0 Adoption of BCA 2007

- (a) The 2007 edition of the BCA was adopted by the Commonwealth, States and Territories as set out in Table 5.0.

Table 5.0 History of adoption of BCA 2007

Administration	Adoption Date
Australian Government	1 May 2007
Australian Capital Territory	1 May 2007
New South Wales	1 May 2007
Northern Territory	1 May 2007
Queensland	1 May 2007
South Australia	1 May 2007
Tasmania	1 May 2007
Victoria	1 May 2007
Western Australia	1 May 2007

- (b) The purpose of BCA 2007 is to—
- (i) update references to other documents; and
 - (ii) update energy efficiency provisions including providing additional information; and
 - (ii) include minor technical changes.

6.0 Adoption of BCA 2008

- (a) The 2008 edition of the BCA was adopted by the Commonwealth, States and Territories as set out in Table 6.0.

Table 6.0 History of adoption of BCA 2008

Administration	Adoption Date
Australian Government	1 May 2008
Australian Capital Territory	1 May 2008
New South Wales	1 May 2008
Northern Territory	1 May 2008
Queensland	1 May 2008
South Australia	1 May 2008
Tasmania	1 May 2008
Victoria	1 May 2008
Western Australia	1 May 2008

- (b) The purpose of BCA 2008 is to—
- (i) update references to other documents; and
 - (ii) due to changes in the types of detectors now available, rather than only allowing the use of a heat detectors when smoke detector would be unsuitable in the atmosphere, to also allow the use of any type of detector deemed suitable by AS 1670.1; and
 - (iii) clarify the intent of the BCA when a service penetrates a building element required to have an FRL; and
 - (iv) amend the requirements for door handle heights to be consistent with AS 1428.1; and
 - (v) align some BCA terms with current industry terminology; and
 - (vi) include lists of other Commonwealth, State and Territory legislation affecting buildings; and
 - (vii) include suitable provisions for swimming pool water recirculation systems; and
 - (viii) include minor technical changes.

7.0 Adoption of BCA 2009

- (a) The 2009 edition of the BCA was adopted by the Commonwealth, States and Territories as set out in Table 7.0.

Table 7.0 History of adoption of BCA 2009

Administration	Adoption Date
Australian Government	1 May 2009
Australian Capital Territory	1 May 2009
New South Wales	1 May 2009
Northern Territory	1 May 2009
Queensland	1 May 2009
South Australia	1 May 2009

Table 7.0 History of adoption of BCA 2009 — continued

Administration	Adoption Date
Tasmania	1 May 2009
Victoria	1 May 2009
Western Australia	1 May 2009

- (b) The purpose of BCA 2009 is to—
- (i) update references to other documents; and
 - (ii) after expiry of the agreed transition period, except for the 1993 edition of AS 1170.4, delete all references to the older loading standards contained in the AS 1170 series and consequently, all provisions referring to them; and
 - (iii) clarify the application of the vertical separation provisions; and
 - (iv) clarify the intent of separation of equipment; and
 - (v) simplify the wire balustrade provisions, including the addition of a *Verification Method*; and
 - (vi) clarify the provisions for the construction of sanitary compartments to enable an unconscious occupant to be removed; and
 - (vii) clarify the height of rooms in an attic and with a sloping ceiling; and
 - (viii) further update the energy efficiency provisions; and
 - (ix) include minor technical changes.

8.0 Adoption of BCA 2010

- (a) The 2010 edition of the BCA was adopted by the Commonwealth, States and Territories as set out in Table 8.0.

Table 8.0 History of adoption of BCA 2010

Administration	Adoption Date
Australian Government	1 May 2010
Australian Capital Territory	1 May 2010
New South Wales	1 May 2010
Northern Territory	1 May 2010
Queensland	1 May 2010
South Australia	1 May 2010 except for Section J, which was adopted on 1 September 2010, and the restriction on child resistant door sets in G1.1 and the additional bushfire requirements for 'excluded areas' prescribed in SA G5.2(d) and (e), which were adopted on 2 December 2010.
Tasmania	1 May 2010
Victoria	1 May 2010
Western Australia	1 May 2010

- (b) The purpose of BCA 2010 is to—
- (i) update references to other documents; and
 - (ii) delete reference to the 1993 edition of AS 1170.4 and consequently all provisions referring to it; and
 - (iii) increase the stringency of the energy efficiency provisions and, as part of reducing greenhouse gas emissions, introduce provisions for the greenhouse gas intensity of the energy source for services such as water and space heaters; and
 - (iv) update **Part G5**, as a consequence of referencing the 2009 edition of AS 3959 construction in bushfire-prone areas, to include provisions which apply to a Class 10a building or deck associated with a Class 2 or 3 building located in a *designated bushfire prone area*; and
 - (v) include minor technical changes.

9.0 Adoption of BCA 2011

- (a) The 2011 edition of the BCA was adopted by the Commonwealth, States and Territories as set out in **Table 9.0**.

Table 9.0 History of adoption of BCA 2011

Administration	Adoption Date
Australian Government	1 May 2011
Australian Capital Territory	1 May 2011
New South Wales	1 May 2011
Northern Territory	1 May 2011
Queensland	1 May 2011
South Australia	1 May 2011
Tasmania	1 May 2011
Victoria	1 May 2011
Western Australia	1 May 2011

- (b) The purpose of BCA 2011 is to—
- (i) update references to other documents; and
 - (ii) align the BCA with the Access Code in the Disability (Access to Premises — Buildings) Standards; and
 - (iii) restructure the fire hazard property provisions; and
 - (iv) include minor technical changes.

10.0 Adoption of BCA 2012

- (a) The 2012 edition of the BCA was adopted by the Commonwealth, States and Territories as set out in **Table 10.0**.

Table 10.0 History of adoption of BCA 2012

Administration	Adoption Date
Australian Government	1 May 2012
Australian Capital Territory	1 May 2012
New South Wales	1 May 2012
Northern Territory	1 May 2012
Queensland	1 May 2012
South Australia	1 May 2012
Tasmania	1 May 2012
Victoria	1 May 2012
Western Australia	1 May 2012

- (b) The purpose of BCA 2012 is to—
- (i) update references to other documents; and
 - (ii) include revised provisions aimed at reducing slips, trips and falls in buildings; and
 - (iii) include a Verification Method for emergency lighting; and
 - (iv) align the BCA with changes to the National Quality Standard for early childhood education and care; and
 - (v) include exemptions for Class 8 electricity network substations; and
 - (vi) include minor technical changes.

11.0 Adoption of BCA 2013

- (a) The 2013 edition of the BCA was adopted by the Commonwealth, States and Territories as set out in [Table 11.0](#).

Table 11.0 History of adoption of BCA 2013

Administration	Adoption Date
Australian Government	1 May 2013
Australian Capital Territory	1 May 2013
New South Wales	1 May 2013
Northern Territory	1 May 2013
Queensland	1 May 2013
South Australia	1 May 2013
Tasmania	1 May 2013
Victoria	1 May 2013
Western Australia	1 May 2013

- (b) The purpose of BCA 2013 is to—
- (i) update references to other documents; and

- (ii) include new provisions for openable windows to reduce falls in buildings; and
- (iii) include a Performance Requirement and reference a Standard for construction in flood hazard areas; and
- (iv) consolidate the building related components of the AS 1735 lift series into the BCA; and
- (v) enhance the egress provisions for people with disability; and
- (vi) include minor technical changes.

12.0 Adoption of BCA 2014

- (a) The 2014 edition of the BCA was adopted by the Commonwealth, States and Territories as set out in [Table 12.0](#).

Table 12.0 History of adoption of BCA 2014

Administration	Adoption Date
Australian Government	1 May 2014
Australian Capital Territory	1 May 2014
New South Wales	1 May 2014
Northern Territory	1 May 2014
Queensland	1 May 2014
South Australia	1 May 2014
Tasmania	1 May 2014
Victoria	1 May 2014
Western Australia	1 May 2014

- (b) The purpose of BCA 2014 is to—
- (i) update references to other documents; and
 - (ii) quantify slip resistance on ramps, stairways and landings; and
 - (iii) include provisions for photoluminescent exit signs; and
 - (iv) expand the fire-resistance concession for timber framed construction to include Class 3 buildings; and
 - (v) remove the requirement for fire hose reels in a Class 2 or Class 3 building or a Class 4 part of a building; and
 - (vi) include minor technical changes.

13.0 Adoption of BCA 2015

- (a) The 2015 edition of the BCA was adopted by the Commonwealth, States and Territories as set out in [Table 13.0](#).

Table 13.0 History of adoption of BCA 2015

Administration	Adoption Date
Australian Government	1 May 2015

Table 13.0 History of adoption of BCA 2015 — continued

Administration	Adoption Date
Australian Capital Territory	1 May 2015
New South Wales	1 May 2015
Northern Territory	1 May 2015
Queensland	1 May 2015
South Australia	1 May 2015
Tasmania	1 May 2015
Victoria	1 May 2015
Western Australia	1 May 2015

- (b) The purpose of BCA 2015 is to—
- (i) update references to other documents; and
 - (ii) include a Verification Method for structural reliability; and
 - (iii) improve the usability of the barrier provisions; and
 - (iv) expand the requirements for sprinkler protection to aged care buildings; and
 - (v) include a Verification Method for weatherproofing of external walls; and
 - (vi) improve the usability of energy efficiency provisions for air-conditioning and ventilation systems.

14.0 Adoption of NCC Volume One 2016

- (a) The 2016 edition of NCC Volume One was adopted by the Commonwealth, States and Territories as set out in [Table 14.0](#).

Table 14.0 History of adoption of NCC Volume One 2016

Administration	Adoption Date
Australian Government	1 May 2016
Australian Capital Territory	1 May 2016
New South Wales	1 May 2016
Northern Territory	1 May 2016
Queensland	1 May 2016
South Australia	1 May 2016
Tasmania	1 May 2016
Victoria	1 May 2016
Western Australia	1 May 2016

- (b) The purpose of NCC Volume One 2016 is to—
- (i) update references to other documents; and
 - (ii) amend the "Introduction" and "General Requirements" as part of the initiative to increase the use of Performance Solutions; and

- (iii) include new Verification Methods for structural robustness and indoor air quality; and
- (iv) include provisions for fire-protected timber; and
- (v) include requirements for farm-type buildings; and
- (vi) include minor technical changes.

LIST OF AMENDMENTS

ARCHIVED
LIST OF AMENDMENTS

CONTENTS

LIST OF AMENDMENTS

List of Amendments NCC 2016 Volume One

LIST OF AMENDMENTS - NCC 2016 - VOLUME ONE

This set of notes has been prepared by the Australian Building Codes Board to assist NCC users in identifying changes incorporated in the 2016 edition of Volume One.

The notes provide a description of major changes made from the previous edition of Volume One. If additional information is required to assist in understanding, interpreting or applying the provisions of the 2016 edition of Volume One, reference should be made to the Guide to Volume One.

While the Australian Building Codes Board has attempted to include all major changes made from the previous edition of Volume One, the Board does not give any warranty nor accept any liability in relation to the contents of this list of amendments.

List of Amendments

Reference	Changes and Commentary
General notes	
	The Objectives and Functional Statements have been relocated to guidance material.
	The provisions titled "Deemed-to-Satisfy Provisions" at the start of each Part have been restructured and reference to A0.10 amended to A0.7.
	Cross-volume consideration explanatory information has been inserted throughout to advise of relevant NCC Volume Three provisions.
	A number of provisions have been amended for cross-volume consistency as a consequence of a review to assist in the usability of Volume Two.
Introduction	
	The Introduction provisions have been amended as part of the initiative to increase the use of Performance Solutions. The changes emphasise that the NCC is a performance-based code.
Section A	
	Provisions in Part A0 have been amended, restructured and relocated as part of the initiative to increase the use of Performance Solutions.
A0.1	A new provision has been inserted for 'Compliance with the NCC'. The existing provision 'Adoption' has been relocated to 'Introduction'.
A0.2	A new provision has been inserted for 'Meeting the Performance Requirements'. The existing provision 'BCA Volumes' has been relocated to 'Introduction'. Figure A0.2 has been inserted to replace Figure A0.3.
A0.3	A new provision has been inserted for 'Performance Solutions'. The existing provision 'BCA Structure' has been amended and relocated to A0.2.
A0.4	A new provision has been inserted for 'Deemed-to-Satisfy Solutions'. The existing provision 'Compliance with the BCA' has been amended and relocated to A0.1.
A0.5	The existing provision 'Assessment Methods' has been relocated to A0.5. The existing provision 'Meeting the Performance Requirements' is now covered by A0.2.

ARCHIVED
LIST OF AMENDMENTS

List of Amendments— continued

Reference	Changes and Commentary																								
A0.6	The existing provision 'Defined terms' has been relocated from the 'Introduction' to A0.6. The existing provision 'Objectives and Functional Statements' has been deleted as a consequence of relocating the Objectives and Functional Statements into guidance material.																								
A0.7	The existing provision 'Relevant Performance Requirements' has been relocated to A0.7. The existing provision 'Deemed-to-Satisfy Provisions' is now covered by A0.4.																								
A0.8	This provision has been deleted as a consequence of the inclusion of 'Performance Solutions' in A0.3.																								
A0.9	This provision has been deleted as a consequence of the relocation of 'Assessment Methods' to A0.5.																								
A0.10	This provision has been deleted.																								
A1.1	<p>The following definitions have been inserted, amended or deleted:</p> <table style="width: 100%; border-collapse: collapse;"> <tbody> <tr> <td style="width: 30%; vertical-align: top;">Alternative Solution</td> <td style="vertical-align: top;">The defined term has been amended to include reference to a 'Performance Solution'.</td> </tr> <tr> <td style="vertical-align: top;">Assessment Method</td> <td style="vertical-align: top;">The defined term has been amended to include the new defined terms 'Performance Solution' and 'Deemed-to-Satisfy Solution' as a consequence of amendments to Part A0.</td> </tr> <tr> <td style="vertical-align: top;">Boiler</td> <td style="vertical-align: top;">A new defined term has been inserted as a consequence of including Specification G2.2.</td> </tr> <tr> <td style="vertical-align: top;">Deemed-to-Satisfy Solution</td> <td style="vertical-align: top;">A new defined term 'Deemed-to-Satisfy Solution' has been inserted.</td> </tr> <tr> <td style="vertical-align: top;">Effective height</td> <td style="vertical-align: top;">The defined term has been amended to clarify the lowest storey selected for determination.</td> </tr> <tr> <td style="vertical-align: top;">Expert Judgement</td> <td style="vertical-align: top;">The defined term has been amended to include the new defined terms 'Performance Solution' and 'Prescriptive Solution'.</td> </tr> <tr> <td style="vertical-align: top;">Farming</td> <td style="vertical-align: top;">A new defined term has been inserted as a consequence of including provisions for farm buildings and farm sheds.</td> </tr> <tr> <td style="vertical-align: top;">Farm building</td> <td style="vertical-align: top;">A new defined term has been inserted as a consequence of including provisions for farm buildings.</td> </tr> <tr> <td style="vertical-align: top;">Farm shed</td> <td style="vertical-align: top;">A new defined term has been inserted as a consequence of including provisions for farm sheds.</td> </tr> <tr> <td style="vertical-align: top;">Farm vehicle</td> <td style="vertical-align: top;">A new defined term has been inserted as a consequence of including provisions for farm buildings and farm sheds.</td> </tr> <tr> <td style="vertical-align: top;">Fire compartment</td> <td style="vertical-align: top;">The terms 'Objective' and 'Functional Statement' have been removed as these defined terms are no longer used in the NCC.</td> </tr> <tr> <td style="vertical-align: top;">Fire-protected timber</td> <td style="vertical-align: top;">A new defined term has been inserted as a consequence of including provisions for fire-protected timber.</td> </tr> </tbody> </table>	Alternative Solution	The defined term has been amended to include reference to a 'Performance Solution'.	Assessment Method	The defined term has been amended to include the new defined terms 'Performance Solution' and 'Deemed-to-Satisfy Solution' as a consequence of amendments to Part A0.	Boiler	A new defined term has been inserted as a consequence of including Specification G2.2.	Deemed-to-Satisfy Solution	A new defined term 'Deemed-to-Satisfy Solution' has been inserted.	Effective height	The defined term has been amended to clarify the lowest storey selected for determination.	Expert Judgement	The defined term has been amended to include the new defined terms 'Performance Solution' and 'Prescriptive Solution'.	Farming	A new defined term has been inserted as a consequence of including provisions for farm buildings and farm sheds.	Farm building	A new defined term has been inserted as a consequence of including provisions for farm buildings.	Farm shed	A new defined term has been inserted as a consequence of including provisions for farm sheds.	Farm vehicle	A new defined term has been inserted as a consequence of including provisions for farm buildings and farm sheds.	Fire compartment	The terms 'Objective' and 'Functional Statement' have been removed as these defined terms are no longer used in the NCC.	Fire-protected timber	A new defined term has been inserted as a consequence of including provisions for fire-protected timber.
Alternative Solution	The defined term has been amended to include reference to a 'Performance Solution'.																								
Assessment Method	The defined term has been amended to include the new defined terms 'Performance Solution' and 'Deemed-to-Satisfy Solution' as a consequence of amendments to Part A0.																								
Boiler	A new defined term has been inserted as a consequence of including Specification G2.2.																								
Deemed-to-Satisfy Solution	A new defined term 'Deemed-to-Satisfy Solution' has been inserted.																								
Effective height	The defined term has been amended to clarify the lowest storey selected for determination.																								
Expert Judgement	The defined term has been amended to include the new defined terms 'Performance Solution' and 'Prescriptive Solution'.																								
Farming	A new defined term has been inserted as a consequence of including provisions for farm buildings and farm sheds.																								
Farm building	A new defined term has been inserted as a consequence of including provisions for farm buildings.																								
Farm shed	A new defined term has been inserted as a consequence of including provisions for farm sheds.																								
Farm vehicle	A new defined term has been inserted as a consequence of including provisions for farm buildings and farm sheds.																								
Fire compartment	The terms 'Objective' and 'Functional Statement' have been removed as these defined terms are no longer used in the NCC.																								
Fire-protected timber	A new defined term has been inserted as a consequence of including provisions for fire-protected timber.																								

ARCHIVED
LIST OF AMENDMENTS

List of Amendments— continued

Reference	Changes and Commentary	
	Functional Statement	The defined term has been deleted, as it is no longer used in the NCC.
	Massive timber	A new defined term has been inserted as a consequence of including provisions for fire-protected timber.
	Non-illuminated exit sign	A new defined term has been inserted as a consequence of including provisions for farm buildings.
	Objective	The defined term has been deleted, as it is no longer used in the NCC.
	Performance Requirement	The defined term has been amended to include the new defined terms 'Performance Solution' and 'Deemed-to-Satisfy Solution'.
	Performance Solution	A new defined term 'Performance Solution' has been inserted.
	Pressure vessel	A new defined term has been inserted as a consequence of including Specification G2.2.
	Verification Method	The defined term has been amended to include the new defined term 'Performance Solution'.
A1.4 and A1.7	Reference to 'BCA' replaced with 'NCC' as a consequence of the consolidation of the Introduction and General Provisions of the NCC to provide consistency across Volumes One, Two and Three.	
A1.5 and A1.6	Amended to clarify that the NCC is a performance-based code.	
A1.8	A new provision has been inserted for explanatory information, as a consequence of the insertion of cross-volume consideration explanatory information being included throughout the code to advise of relevant NCC Volume Three provisions.	
A2.4	Sub-clause (b) has been amended and a new sub-clause (c) has been inserted as a consequence of the deletion of provisions for the determination of group numbers for wall and ceiling linings from Specification C1.10, deletion of provisions for the determination of a material's smoke growth rate index (SMOGR _{RC}) from Specification A2.4, and the adoption of AS 5637.1.	
Specification A1.1	A new Specification has been inserted as a consequence of new provisions for fire-protected timber.	
Specification A1.3 Table 1	The following references have been inserted, amended or deleted:	
	AS 1170.4	Amdt 1 to AS 1170 Part 4 'Structural design actions — Earthquake actions in Australia' has been referenced.
	AS/NZS 1200	AS/NZS 1200 'Pressure equipment' has been deleted.
	AS/NZS 1428.4.1	Amdt 2 of the 2014 edition of AS/NZS 1428 Part 4.1 'Design for access and mobility — Means to assist the orientation of people with vision impairment — Tactile ground surface indicators' has been referenced.

ARCHIVED
LIST OF AMENDMENTS

List of Amendments— continued

Reference	Changes and Commentary
AS 1530.4	The 2014 edition of AS 1530 Part 4 'Methods for fire tests on building materials, components and structures — Fire-resistance tests for elements of construction' has been referenced.
AS 1668.1	The 2015 edition of AS 1668 Part 1 'The use of ventilation and air conditioning in buildings — Fire and smoke control in buildings' has been referenced.
AS 1670.1	The 2015 edition of AS 1670 Part 1 'Fire detection, warning, control and intercom systems — System design, installation and commissioning — Fire' has been referenced.
AS 1670.4	The 2015 edition of AS 1670 Part 4 'Fire detection, warning, control and intercom systems — System design installation and commissioning — Sound systems and intercom systems for emergency purposes' has been referenced.
AS 1720.1	Amdt 3 to AS 1720 Part 1 'Timber structures — Design methods' has been referenced.
AS 1720.4	The 2006 edition of AS 1720 Part 4 'Timber structures — Fire resistance for structural adequacy of timber members' has been referenced.
AS 1720.5	The 2015 edition of AS 1720 Part 5 'Timber structures — Nailplated timber roof trusses' has been referenced.
AS 1905.1	The 2015 edition of AS 1905 Part 1 'Components for the protection of openings in fire-resistant walls — Fire-resistant doorsets' has been referenced.
AS 2293.3	The 2005 edition of AS 2293 Part 3 'Emergency escape lighting and exit signs for buildings — Emergency escape luminaires and exit signs' has been referenced.
AS/NZS 3500.3	Reference to the 2003 edition of AS 3500 Part 3 'Plumbing and drainage — Stormwater drainage' has been updated to the 2015 edition.
AS 3786	Amdt 1 to AS 3786 'Smoke alarms using scattered light, transmitted light or ionization' has been referenced.
AS 4505	Amdt 1 to AS 4505 'Garage doors and other large access doors' has been referenced.
AS 5146.1	The 2015 edition of AS 5146 Part 1 'Reinforced autoclaved aerated concrete — Structure' has been referenced.
AS 5637.1	The 2015 edition of AS 5637 Part 1 'Determination of fire hazard properties — Wall and ceiling linings' has been referenced.
AS ISO 9705	AS ISO 9705 'Fire test — Full-scale room tests for surface products' has been deleted.
NASH Standard	Amdt A to NASH Standard Part 2 'Residential and low-rise steel framing — Design solutions' has been referenced.

ARCHIVED
LIST OF AMENDMENTS

List of Amendments— continued

Reference	Changes and Commentary
	SA TS 101 The 2015 edition of the Standards Australia Technical Specification 'Design of post-installed and cast-in fastenings for use in concrete' has been referenced.
Specification A2.3 Clause 2	Sub-clause (d)(iii) has been amended to reflect the scope of timber elements to which AS 1720.4 applies, and to exclude fire-protected timber from the sub-clause.
Specification A2.4 Clause 1	Sub-clause (b) has been removed and the clause restructured as a result of the reduction of scope of the Specification.
Specification A2.4 Clause 3 and 4	Clauses 3 and 4 of Specification A2.4 have been deleted as a consequence of referencing AS 5637.1, which is used for the determination of group numbers for wall and ceiling linings.
Section B	
BV2	A new Verification Method has been inserted to verify compliance with Performance Requirement BP1.1(a)(iii). BV2 is a means for verifying the structural robustness of a building.
B1.4(b)	<ul style="list-style-type: none"> • AS 5146.1 'Reinforced autoclaved aerated concrete — Structure' has been included as a referenced document for concrete construction to determine the structural resistance of materials and forms of construction. • SA TS 101 'Design of post-installed and cast-in fastenings for use in concrete' has been included as a referenced document.
B1.4(f)(iv)	A reference to AS 1720.5 has been added for the design of nailplated timber roof trusses in residential and similar buildings.
B1.5(c)	Design software for individual frame members such as electronic tables similar to that provided in NASH Standard – Residential and Low-Rise Steel Framing – Part 2, included as an exemption from the requirements of B1.5(a).
Section C	
C1.10(c)(xiv)	The sub-clause has been amended to include specific fire hazard property requirements for timber treads, risers, landings and associated supporting framework installed in accordance with D2.25. As a consequence, the existing sub-clause (c)(xiv) has been amended to (c)(xv).
C1.13	A new provision has been included to allow fire-protected timber to be used wherever an element is required to be non-combustible, subject to sub-clauses (a) to (e).
C3.1(a)(iv)	C3.1(a)(iv) has been amended to clarify that where the concession for openings formed by a vehicle ramp is used, the floors connected by the vehicle ramp must be treated as a single fire compartment for the purposes of other Deemed-to-Satisfy Provisions in Sections C, D and E.
Specification C1.1 Clause 2.9	The clause has been amended to exclude fire protected timber elements from the residential aged care building concession.

ARCHIVED
LIST OF AMENDMENTS

List of Amendments— continued

Reference	Changes and Commentary
Specification C1.1 Clause 3.1(d)	The sub-clause has been amended to include the option for loadbearing internal walls or loadbearing fire walls to be constructed from fire-protected timber for Type A construction.
Specification C1.1 Clause 4.1(e)	The sub-clause has been amended to include the option for loadbearing internal walls or loadbearing fire walls to be constructed from fire-protected timber for Type B construction.
Specification C1.10 Clause 4	The clause has been amended and restructured as a consequence of provisions for the determination of group numbers for wall and ceiling linings being removed from the NCC and AS 5637.1 being referenced.
Specification C1.10 Clause 6	The clause has been amended as a consequence of provisions for the determination of group numbers for wall and ceiling linings being removed from the NCC and AS 5637.1 being referenced.
Specification C1.13	A new Specification has been inserted for fire-protected timber.
Section D	
D1.6(i)	A sub-clause has been included to clarify that the number of persons accommodated must be calculated in accordance with D1.13.
D1.10(g)	A sub-clause has been included to clarify that the number of persons accommodated must be calculated in accordance with D1.13.
D1.13	The provision has been amended to clarify that it is to be used to determine the number of persons accommodated for certain Deemed-to-Satisfy Provisions. It is not intended to restrict the number of occupants using a building.
D2.13(a) and (b)	The provision has been amended to provide an allowance for conditions such as movement of materials due to atmospheric moisture changes or minor deviations related to variations in materials which affect finished stair dimensions.
D2.21(b)(iii)	D2.21(b)(iii) has been amended and restructured to exempt Australian Government Security Zones 4 and 5 from the requirements of D2.21(a).
D2.25	A new provision has been inserted as a concession to D2.2 for timber stairways. The concession permits the use of timber within a fire-isolated stairway or fire-isolated passageway subject to certain conditions.
Section E	
Table E1.5	A new note 3 included to refer to C1.13 and Specification C1.1 for use of sprinklers in Class 2, 3 and 5 buildings containing fire-protected timber. Consequently the existing note 3 has been renumbered.
Table E2.2a - Buildings more than 25 m in effective height	Note 2 below 'Class 5, 6, 7b, 8 or 9b buildings' has been amended to clarify when this provision does not apply.

ARCHIVED
LIST OF AMENDMENTS

List of Amendments— continued

Reference	Changes and Commentary
Specification E2.2a Clause 4(d)	Clause 4(d) has been amended and restructured to provide a concession to the smoke detector requirements in sprinklered areas in Class 9a health-care buildings where the use of the area is likely to result in spurious signals.
Figure 2 Specification E2.2b	For consistency with the amendment to the title of Part H1, reference to 'theatres, stages, and public halls' has been replaced with 'Class 9b buildings'.
Part E4	As a consequence of amendments to Performance Requirement EP4.1 the Part title has been amended to 'Visibility in an emergency, exit signs and warning systems'.
EP4.1	<ul style="list-style-type: none"> • A new sub-clause (a) has been included to require sufficient visibility of exits and paths of travel to an exit in lieu of a level of illumination. • A new sub-clause (b) has been included to require a system used to provide a sufficient visibility in (a) to activate instantaneously upon the failure of an artificial lighting system. • Consequently, the existing sub-clauses have been renumbered.
Section F	
F1.9(b)(ii)	'Termite shields' has been replaced with 'sheet material' to reflect updated terminology.
F1.12	Provisions amended for consistency with changes to Volume Two of the NCC to improve the usability of the Code.
Table F2.1	<ul style="list-style-type: none"> • A Note has been added to clarify that a reference to 'employees' includes owners, managers, workers and contractors. • Requirements for a washbasin have been relocated to a separate sub-clause to clarify that a washbasin does not need to be associated with a closet pan in a Class 2, 3 building and a Class 4 part of a building.
F2.3(a)	Clarification has been added that sanitary facilities for males and females must be separate unless otherwise permitted.
F2.3(f)	A new sub-clause has been included to exempt ward areas from requiring separate sanitary facilities for males and females. As a consequence the remaining sub-clauses have been renumbered.
Table F2.3	Clarification has been added that sanitary facilities for patrons need not be provided in Class 6 and 9b buildings where the total number of persons accommodated in the building is not more than the given number.
F3.1(d)(iv)	A sub-clause has been included to clarify that the number of persons accommodated must be calculated in accordance with D1.13.
FV4.1	A new Verification Method has been inserted as an option to verify compliance with Performance Requirements FP4.3 and FP4.4(a). FV4.1 is a means for verifying that a building ventilated with outdoor air has suitable indoor air quality. The new Verification Method is applicable to Class 2, 3, 4, 5, 6, 9b and 9c buildings.

ARCHIVED
LIST OF AMENDMENTS

List of Amendments— continued

Reference	Changes and Commentary
FV4.2	A new Verification Method has been inserted as an option to verify compliance with Performance Requirements FP4.3 and FP4.4(a). FV4.2 is a means for verifying that a carpark ventilated with outdoor air has suitable indoor air quality. The new Verification Method is applicable to Class 7a buildings.
F4.3(a)(ii)	F4.3(a)(ii) has been amended to clarify that the aggregate light transmitting area of a glazed panel or opening cannot be less than 10% of the floor area of the room to which it provides light.
F4.6(a)(i)	F4.6(a)(i) has been amended to clarify that the ventilating area must be not less than 5% of the floor area of the room required to be ventilated.
FV5.1(b), F5.3(a)(i), F5.4(a) and Specification F5.2 Clause 2	The spectral adaptation term (C_1 correction) for impact sound insulation rating descriptors $L_{nT,w}$ and $L_{n,w}$ has been deleted to align with international building codes.
Section G	
Part G2	Part G2 has been re-named as a consequence of the inclusion of new provisions for boilers and pressure vessels.
GP2.2	The Performance Requirement has been amended to include new defined terms for 'boilers' and 'pressure vessels'.
G2.2 and Specification G2.2	New provisions for boilers and pressure vessels have been inserted as a result of deleting reference to AS/NZS 1200.
G4.8	G4.8 has been amended and restructured to clarify the requirements for fire hydrants and fire hose reels.
Section H	
Part H1	Part H1 has been re-named 'Class 9b Buildings' to more accurately reflect its content.
Part H3	A new Part has been inserted containing provisions for farm buildings and farm sheds.
Section J	
JV3(g)(ii)(C)	A reference to J1.6(e) has been added to JV3(g)(ii)(C) as a design requirement for floor edge insulation.
J0.2(d)	An exemption has been included for J0.2(d), where the house energy rating software used can automatically compensate for a loss of ceiling insulation.
Abbreviations and Symbols	
ppm	Parts per million (ppm) included as an abbreviation.
Australian Capital Territory Appendix	
Footnote	The Footnote listing other legislation has been updated.
New South Wales Appendix	
Footnote	The Footnote listing other legislation has been updated.

ARCHIVED
LIST OF AMENDMENTS

List of Amendments— continued

Reference	Changes and Commentary
Queensland Appendix	
Qld Specification A3.2	The schedule of referenced documents has been updated.
Qld Part G101	This Part has been deleted.
South Australia Appendix	
SA A1.1	A new defined term has been included for a 'small arts venue'.
SA A3.2 Class 6	A new variation has been included to make a 'small arts venue' Class 6.
SA D1.2(h)	A new addition has been included to require not less than 2 exits from certain small arts venues.
SA D2.21(c)	A new variation has been included to apply egress door requirements to small arts venues.
SA Table F1.7	A new variation has been included to vary Table F1.7.
SA GP1.2	Performance Requirement GP1.2 relating to swimming pools has been amended for clarity.
SA G1.1(a)	A new variation has been included to clarify that access to a swimming pool must be restricted from any habitable room, or building with a habitable room, within a pool area.
SA G1.1(d)	A new addition has been included to clarify that a skimmer box is considered an outlet for the purposes of clause 6.1.1 of AS 1926.3.
SA Part H3	This Part has been amended to provide reference to Minister's Specification H3.2 — Concessions for farm buildings.
Tasmania Appendix	
Tas Part D2	The Tasmanian variations in Part D2 regarding slip-resistance have been deleted.
Tas Section H	Clarification included to a number of application provisions in Section H.
Tas Part H123	This section has been restructured to refer to the ABCB Temporary Structures Standard, except retaining variations for— <ul style="list-style-type: none"> • access for people with disabilities; • lighting; • ventilation; • electrical; and • heating appliances.
Footnote	The Footnote listing other legislation has been updated.

ARCHIVED
LIST OF AMENDMENTS

List of Amendments— continued

Reference	Changes and Commentary
Victoria Appendix	
Vic C1.10(c)(xv)	A new variation has been included, deleting the exemption in C1.10(c)(xv).
Vic Specification E1.5 Clause 2	A new variation has been included to vary clause 5.6.13 of AS 2118.1. The variation requires covered balconies in Class 2, 3, 4, 9a or 9c buildings to be sprinkler protected.
Vic H103.1(a)	Buildings constructed using fire-protected building elements have been excluded from the concession for Class 2 and Class 3 buildings.
Footnote	The Footnote listing other legislation has been updated.
Western Australia Appendix	
WA Section G	WA Section G has been deleted.
History of Adoption	
14.0	New provision added in order to set out the adoption date of the 2016 edition of Volume One in each State and Territory and to summarise the purpose of the changes from the 2015 edition.