



Volume One



Building Code of Australia
2019
Amendment 1

Contents and Introduction

General Table of Contents

Copyright and licence notice

Introduction to the National Construction Code (NCC)

Introduction to NCC Volume One

General Table of Contents

Contents and Introduction	
Copyright and licence notice.....	8
Introduction to the National Construction Code (NCC)	9
Introduction to NCC Volume One	11
Section A Governing Requirements	
Section A Governing Requirements.....	15
Part A1 Interpreting the NCC	16
Part A2 Compliance with the NCC.....	18
Part A3 Application of the NCC in States and Territories.....	22
Part A4 NCC referenced documents	23
Part A5 Documentation of design and construction	25
Part A6 Building classification	30
Part A7 United buildings	42
Section B Structure	
Part B1 Structural provisions	46
Section C Fire resistance	
Section C Fire resistance	61
Part C1 Fire resistance and stability	65
Part C2 Compartmentation and separation.....	71
Part C3 Protection of openings	78
Section D Access and egress	
Section D Access and egress	122
Part D1 Provision for escape	129
Part D2 Construction of exits	140
Part D3 Access for people with a disability.....	155
Section E Services and equipment	
Part E1 Fire fighting equipment.....	175
Part E2 Smoke hazard management	192
Part E3 Lift installations	213
Part E4 Visibility in an emergency, exit signs and warning systems.....	222
Section F Health and amenity	
Part F1 Damp and weatherproofing	232
Part F2 Sanitary and other facilities.....	244
Part F3 Room heights.....	265
Part F4 Light and ventilation.....	268
Part F5 Sound transmission and insulation.....	275
Part F6 Condensation management.....	287
Section G Ancillary provisions	
Part G1 Minor structures and components	292
Part G2 Boilers, pressure vessels, heating appliances, fireplaces, chimneys and flues	296

Part G3	Atrium construction	300
Part G4	Construction in alpine areas	309
Part G5	Construction in bushfire prone areas	313
Part G6	Occupiable outdoor areas	316
Section H Special use buildings		
Part H1	Class 9b buildings	321
Part H2	Public transport buildings	323
Part H3	Farm buildings and farm sheds	326
Section I * * * * *		
Part I1	* * * * *	333
Part I2	* * * * *	334
Section J Energy efficiency		
Section J	Energy efficiency	339
Part J0	Energy efficiency	356
Part J1	Building fabric	358
Part J2	* * * * *	362
Part J3	Building sealing	363
Part J4	* * * * *	365
Part J5	Air-conditioning and ventilation systems	366
Part J6	Artificial lighting and power	378
Part J7	Heated water supply and swimming pool and spa pool plant	385
Part J8	Facilities for energy monitoring	387
Schedule 1 State & Territory Appendices		
Schedule 1	State & Territory Appendices	405
Commonwealth of Australia		
Footnote:	Other legislation and policies affecting buildings	408
Australian Capital Territory		
ACT Appendix	414
Footnote:	Other legislation affecting buildings	415
New South Wales		
Introduction	422
Section A	Governing requirements	423
Section D	Access and egress	428
Section F	Health and amenity	436
Section G	Ancillary provisions	437
Section H	Special use buildings	439
NSW Part H101	Entertainment venues other than temporary structures and drive-in theatres	440
NSW Part H102	Temporary structures	450
NSW Part H103	Drive-in theatres	453
NSW Section J	Energy efficiency	454
Schedule 3	Definitions	462
Schedule 4	Referenced documents	464
Footnote:	Other legislation affecting buildings	465

Northern Territory

Introduction	473
Section E Services and equipment	476
Section G Ancillary provisions	483
Section H Special use buildings.....	484
NT Part H101 * * * * *	485
NT Part H102 Premises to be used for activities involving skin penetration.....	486
NT Part H103 Mortuaries	487
Section J Energy efficiency	488
Schedule 4 Referenced documents	489
Footnote: Other legislation affecting buildings	490

Queensland

Introduction	495
Section B Structure	496
Section G Ancillary provisions	497
Qld Part G5 Construction in bushfire prone areas	498
Section J Energy efficiency	499
Schedule 4 Referenced documents	500
Footnote: Other legislation affecting buildings	501

South Australia

Introduction	506
Section A Governing Requirements.....	507
Section B Structure	508
Section C Fire resistance	509
Section D Access and egress	511
Section E Services and equipment	513
Section F Health and amenity	517
Section G Ancillary provisions	520
SA Part G7 Access for maintenance	521
SA Part G8 Miscellaneous provisions.....	523
Section H Special use buildings.....	524
SA Part H3 Farm buildings.....	525
Section J Energy efficiency	526
Schedule 3 Definitions	527
Schedule 4 Referenced documents	529
Footnote: Other legislation affecting buildings	530

Tasmania

Introduction	542
Section D Access and egress	543
Section E Services and equipment	544
Section F Health and amenity	545
Section G Ancillary provisions	546
Tas Part G2 * * * * *	548
Section H Special use buildings.....	549

Tas Part H101	* * * * *	550
Tas Part H102	Food premises	551
Tas Part H103	Dining rooms and bar rooms	559
Tas Part H104	* * * * *	560
Tas Part H105	* * * * *	561
Tas Part H106	Meat premises	562
Tas Part H107	Farm dairy premises	563
Tas Part H108	Pharmacies	564
Tas Part H109	Health service establishments	565
Tas Part H110	* * * * *	566
Tas Part H111	* * * * *	567
Tas Part H112	Mortuaries	568
Tas Part H113	Foundries	569
Tas Part H114	Premises for manufacture or processing of glass reinforced plastics	570
Tas Part H115	Premises for production or processing of isocyanates	572
Tas Part H116	Premises for electro-plating, electro-polishing, anodising or etching	574
Tas Part H117	Premises for lead processing	575
Tas Part H118	* * * * *	577
Tas Part H119	* * * * *	578
Tas Part H120	* * * * *	579
Tas Part H121	* * * * *	580
Tas Part H122	Early childhood centres and school age care facilities	581
Tas Part H123	Temporary structures	583
Tas Part H124	Premises where work is undertaken on gas-fuelled vehicles	587
Schedule 3	Definitions	588
Schedule 4	Referenced documents	589
Footnote:	Other legislation affecting buildings	591

Victoria

Introduction	596	
Section B	Structure	597
Section C	Fire resistance	598
Section D	Access and egress	599
Section E	Services and equipment	600
Section F	Health and amenity	603
Section G	Ancillary provisions	607
Section H	Special use buildings	608
Schedule 3	Definitions	614
Schedule 4	Referenced documents	616
Footnote:	Other legislation affecting buildings	618

Western Australia

Introduction	625	
Section H	Special use buildings	626
WA Part H101	Public buildings	627
Schedule 3	Definitions	629
Footnote:	Other legislation affecting buildings	630

Schedule 2 Abbreviations and symbols	
Schedule 2 Abbreviations and symbols	635
Schedule 3 Definitions	
Schedule 3 Definitions	640
Schedule 4 Referenced documents	
Schedule 4 Referenced documents	672
Schedule 5 Fire-resistance of building elements	
Schedule 5 Fire-resistance of building elements	688
Schedule 6 Fire hazard properties	
Schedule 6 Fire hazard properties	698
Schedule 7 Fire Safety Verification Method	
1.0 Preface	703
1.1 Purpose.....	704
1.2 How to use this Verification Method	705
1.3 Performance-based design.....	706
1.4 Design scenarios: NCC Performance Requirements	708
1.5 Fire modelling to determine ASET	711
2.1 Design scenario (BE).....	712
2.2 Design scenario (UT).....	713
2.3 Design scenario (CS).....	714
2.4 Design scenario (SF)	715
2.5 Design scenario (HS).....	716
2.6 Design scenario (VS).....	717
2.7 Design scenario (IS)	718
2.8 Design scenario (FI).....	719
2.9 Design scenario (UF).....	720
2.10 Design scenario (CF).....	721
2.11 Design scenario (RC).....	722
2.12 Design Scenario (SS).....	723
History of adoption	
History of adoption	726
List of amendments	
List of amendments—NCC 2019—Volume One Amendment 1.....	743

Copyright and licence notice

© Commonwealth of Australia and the States and Territories of Australia 2020, published by the Australian Building Codes Board



The material in this publication is licensed under a Creative Commons Attribution-NonCommercial—4.0 International licence, with the exception of:

- any third party material
- any trade marks, and
- any images or photographs.

You may not make derivatives of this publication, but may only use a verbatim copy. More information on this CC BY NC license is set out at the [Creative Commons Website](#). Enquiries about this publication can be sent to:

Australian Building Codes Board
GPO Box 2013
CANBERRA ACT 2601
Phone: 1300 134 631
Email: ncc@abcb.gov.au
www.abcb.gov.au.

Attribution

Use of all or part of this publication must include the following attribution:

© Commonwealth of Australia and the States and Territories 2020, published by the Australian Building Codes Board.

Disclaimer

By accessing or using this publication, you agree to the following:

While care has been taken in the preparation of this publication, it may not be complete or up-to-date. You can ensure that you are using a complete and up-to-date version by checking the Australian Building Codes Board website (www.abcb.gov.au).

The Australian Building Codes Board, the Commonwealth of Australia and States and Territories of Australia do not accept any liability, including liability for negligence, for any loss (howsoever caused), damage, injury, expense or cost incurred by any person as a result of accessing, using or relying upon this publication, to the maximum extent permitted by law. No representation or warranty is made or given as to the currency, accuracy, reliability, merchantability, fitness for any purpose or completeness of this publication or any information which may appear on any linked websites, or in other linked information sources, and all such representations and warranties are excluded to the extent permitted by law.

This publication is not legal or professional advice. Persons rely upon this publication entirely at their own risk and must take responsibility for assessing the relevance and accuracy of the information in relation to their particular circumstances.

First Published: February 2019

Print version: 2.1

Release date: July 2020

Introduction to the National Construction Code (NCC)

About the NCC

The NCC is Australia's primary set of technical design and construction provisions for buildings. As a performance-based code, it sets the minimum required level for the safety, health, amenity, accessibility and sustainability of certain buildings. It primarily applies to the design and construction of new buildings, and plumbing and drainage systems in new and existing buildings. In some cases it may also apply to structures associated with buildings and new building work or new plumbing and drainage work in existing buildings.

The Australian Building Codes Board (ABCB), on behalf of the Australian Government and each State and Territory government, produces and maintains the NCC. When determining the content of the NCC, the ABCB seeks to—

- ensure requirements have a rigorously tested rationale; and
- effectively and proportionally address applicable issues; and
- create benefits to society that outweigh costs; and
- consider non-regulatory alternatives; and
- consider the competitive effects of regulation; and
- not be unnecessarily restrictive.

The primary users of the NCC include architects, builders, plumbers, building surveyors, hydraulic consultants, engineers and other building and plumbing related professions and trades.

Format of the NCC

The NCC is published in three volumes. The Building Code of Australia (BCA) is Volumes One and Two of the NCC and the Plumbing Code of Australia (PCA) is Volume Three of the NCC.

Components of the NCC

The NCC provides the technical provisions for the design and construction of buildings and other structures, and plumbing and drainage systems.

NCC Volume One primarily covers the design and construction of multi-residential, commercial, industrial and public assembly buildings and some associated structures.

NCC Volume Two primarily covers the design and construction of smaller scale buildings including houses, small sheds, carports and some associated structures.

NCC Volume Three covers the design, construction and maintenance of plumbing and drainage systems in new and existing buildings.

Each volume contains—

- Governing Requirements; and
- Performance Requirements; and
- compliance options to meet the NCC requirements; and
- State and Territory variations and additions.

The NCC uses building classifications to identify requirements for different intended purposes of buildings or parts of buildings. A building classification relates to the characteristics and the intended use of the building. Information on building classifications is found in [Part A6](#) of the Governing Requirements.

Legislative arrangements and the NCC

The NCC is given legal effect through State and Territory, or other statutory authority, building and plumbing legislation. These Acts and Regulations set out the legal framework and administration mechanisms for the NCC to support the design and construction of buildings.

The dates of adoption of the NCC are determined by State and Territory building and plumbing administrations.

How to use the NCC

Each volume of the NCC is split into two main sections:

1. Administrative requirements contained within the Governing Requirements.
2. Technical requirements contained within the remaining sections of the NCC.

The Governing Requirements provide the rules and instructions for using and complying with the NCC. They are vital in understanding how the technical requirements of the NCC should be applied to any particular situation. The Governing Requirements are also important in understanding how the NCC fits with the building and plumbing regulatory framework within Australia.

NCC resources

The NCC has resources created to make the code easier to understand and apply. These resources are available from the ABCB website at: www.abcb.gov.au.

Introduction to NCC Volume One

About NCC Volume One

NCC Volume One contains technical design and construction requirements for all Class 2 to 9 buildings (multi-residential, commercial, industrial, and public assembly buildings) and their associated structures.

NCC Volume One contains the requirements for—

- all Class 2 to 9 buildings; and
- access requirements for people with a disability in Class 1b and 10a buildings; and
- certain Class 10b structures including access requirements for people with a disability in Class 10b [swimming pools](#).

Components of NCC Volume One

NCC Volume One contains the following Sections:

- Section A – Governing Requirements
- Section B – Structure
- Section C – Fire resistance
- Section D – Access and egress
- Section E – Services and equipment
- Section F – Health and amenity
- Section G – Ancillary provisions
- Section H – Special use buildings
- Section I – * * * * * (Section I provisions were removed in NCC 2014)
- Section J – Energy efficiency
- Schedules—
 - State and Territory appendices
 - Abbreviations and symbols
 - Definitions
 - Referenced documents
 - Fire-resistance of building elements
 - Fire hazard properties
 - Fire Safety Verification Method

Section A contains the mandatory Governing Requirements for the NCC. Sections B to J contain the mandatory [Performance Requirements](#) and the pathways that can be used to comply with the NCC.

Governing Requirements

Section A	Governing Requirements
Part A1	Interpreting the NCC
Part A2	Compliance with the NCC
Part A3	Application of the NCC in States and Territories
Part A4	NCC referenced documents
Part A5	Documentation of design and construction
Part A6	Building classification
Part A7	United buildings

Section A Governing Requirements

Section A Governing Requirements

Introduction to this Section

Part A1 Interpreting the NCC

Introduction to this Part

A1.0 Interpretation

Part A2 Compliance with the NCC

Introduction to this Part

A2.0 Compliance

A2.1 Compliance with the Performance Requirements

A2.2 Performance Solution

A2.3 Deemed-to-Satisfy Solution

A2.4 A combination of solutions

Part A3 Application of the NCC in States and Territories

Introduction to this Part

A3.0 State and Territory compliance

Part A4 NCC referenced documents

Introduction to this Part

A4.0 Referenced documents

A4.1 Differences between referenced documents and the NCC

A4.2 Adoption of referenced documents

Part A5 Documentation of design and construction

Introduction to this Part

A5.0 Suitability

A5.1 Evidence of suitability—Volumes One, Two and Three

A5.2 Evidence of suitability—Volumes One and Two

A5.3 Evidence of suitability—Volume Three

A5.4 Fire-resistance of building elements

A5.5 Fire hazard properties

A5.6 Resistance to the incipient spread of fire

A5.7 Labelling of Aluminium Composite Panels

Part A6 Building classification

Introduction to this Part

A6.0 Determining a building classification

A6.1 Class 1 buildings

A6.2 Class 2 buildings

A6.3 Class 3 buildings

A6.4 Class 4 buildings

A6.5 Class 5 buildings

A6.6 Class 6 buildings

A6.7 Class 7 buildings

A6.8 Class 8 buildings

A6.9 Class 9 buildings

A6.10 Class 10 buildings and structures

A6.11 Multiple classifications

Part A7 United buildings

Introduction to this Part

A7.0 United buildings

A7.1 Alterations in a united building

Section A Governing Requirements

Introduction to this Section

The Governing Requirements of the NCC provide the rules and instructions for using and complying with the NCC. They include the following:

- Interpreting the NCC.
- Complying with the NCC.
- Application of the NCC in States and Territories.
- Applying documents referenced in the NCC.
- Documenting the suitability of the design, construction and/or use of materials to comply with the NCC.
- Classifying buildings by their characteristics and intended use.

Part A1 Interpreting the NCC

Introduction to this Part

This Part explains important concepts on how the NCC must be interpreted and applied. There are certain conventions and approaches that need to be taken into account when using the NCC. This includes interpreting specific language and terms. This is critical in understanding the intended technical and legal meaning of the NCC. This Part also explains the difference between the mandatory parts of the NCC and parts that are only explanatory or guidance in nature.

A1.0 Interpretation

- (1) The following components of the NCC are non-mandatory and informative:
 - (a) Content identified as “explanatory information”.
 - (b) For **Volumes One and Two**, the “Introduction to this Part or Section” information, located at the beginning of each Part or Section.
 - (c) For **Volume Three**, the “Introduction to this Section” information, located at the beginning of each Section.
- (2) Words in italics must be interpreted in accordance with—
 - (a) definitions provided in [Schedule 3](#), unless the contrary intention appears; and
 - (b) additional definitions in State or Territory appendices, as appropriate.

Note:

For **Volume Three**, if a word is not defined in [Schedule 3](#), the meaning (if any) attributed to it under AS/NZS 3500.0 Glossary of Terms should be used unless the contrary intention appears.

- (3) The NCC must be interpreted and applied in accordance with the following:
 - (a) A reference to a building is a reference to an entire building or part of a building (as the case requires).
 - (b) A reference to a *plumbing or drainage solution*, or *product* in Volume Three is a reference to an entire installation, system or *product*, or part of an installation, system or *product* (as the case requires).
 - (c) A reference in a *Performance Requirement* to “the degree necessary” means—
 - (i) that consideration of all the criteria referred to in the *Performance Requirement* will determine the outcome appropriate to the circumstances; and
 - (ii) that in certain cases it may not be necessary to incorporate any specific measures to meet the relevant *Performance Requirement*.
 - (d) For **Volume Three** the “Introduction to this Part” information, located at the beginning of each Part, is mandatory and is provided to specify where each Part applies.
 - (e) An “Application” statement is mandatory and is provided to specify where and when a requirement or provision applies.
 - (f) A “Limitation” statement is mandatory and is provided to specify where and when the application of a requirement or provision is limited to a certain circumstance.
 - (g) An “Exemption” statement is mandatory and is provided to specify where or when a requirement or provision does not need to be complied with.
 - (h) A “Note” is part of a provision or requirement and provides additional mandatory instructions.
 - (i) Figures in the NCC are used to illustrate specific issues referenced in the associated text. They are not to be construed as containing all design information that is *required* for that particular building element or situation.
 - (j) The defined symbols and abbreviations listed in [Schedule 2](#).
- (4) A reference to a building class is understood to be a reference to all the sub-classifications of that class.
- (5) The following sub-classifications apply:
 - (a) Classes 1a and 1b are sub-classifications of Class 1.
 - (b) Classes 7a and 7b are sub-classifications of Class 7.

Governing Requirements

- (c) Classes 9a, 9b and 9c are sub-classifications of Class 9.
 - (d) Classes 10a, 10b and 10c are sub-classifications of Class 10.
- (6) A reference to a sub-classification is solely to that sub-classification.

Tas A1.0(7)

Explanatory information:

Explanatory information and Introduction to this Section information contained in the NCC or Introduction to this Part information contained in Volumes One and Two of the NCC are non-mandatory and are provided for guidance purposes only. This informative material should be read in conjunction with the technical provisions of the NCC. Any statements made in the informative and guidance components of the NCC should not be taken to override the NCC. Unlike the NCC, which is adopted by legislation, the informative and guidance components are not called up into legislation and they do not cover State and Territory variations and additions. Because informative and guidance components of the NCC do not have regulatory force, the ABCB accepts no responsibility for its contents when applied to specific buildings or any liability which may result from its use.

Defined words provide the precise meaning and expressions of key words used for understanding and complying with the NCC. Where a word is not defined in the NCC, the relevant common meaning of the word should be used.

Generally, a reference to a building is a reference to the whole building, regardless of classification. However, when a provision is applicable to a specific class or classes of building, that reference to a building may be a reference to the whole building or part of the building depending on how the building is classified.

Whether a provision applies or not depends on the circumstances of the case and the circumstances in which the reference is made. For example, where a building has a single classification, a reference to a building in the NCC is understandably a reference to a whole building. However, where a building has parts of different classification, unless the contrary intention appears (i.e. there is a specific reference to the whole building), a reference to a building in the NCC is a reference to the relevant part of the building. This means that each part of the building must comply with the relevant provisions for its classification.

A number of the *Performance Requirements* of the NCC use the expression “to the degree necessary” or “appropriate to”. These expressions provide flexibility by allowing *appropriate authorities* to determine the degree of compliance necessary in a particular case. Therefore any part of the NCC that uses these expressions should be referenced against the requirements of the *appropriate authority*. For example, an *appropriate authority* might judge that an item need not be installed, or a particular level of performance be achieved.

Application, Limitation, and Exemption statements are used to identify provisions that may or may not apply in certain situations, to varying degrees.

Classes 1a and 1b, 7a and 7b, 9a, 9b and 9c, and 10a, 10b and 10c are separate classifications. In the NCC, when the designation ‘a’, ‘b’ or ‘c’ is not applied, the reference is to all buildings of the general class. For example, ‘Class 9b’ refers only to Class 9b buildings, but ‘Class 9’ refers to Classes 9a, 9b and 9c.

Figures are used to explain the requirements of a particular clause. To ensure the context of the requirement is clearly understood, adjacent construction elements of the building that would normally be *required* in that particular situation are not always shown. Accordingly, aspects of figures that are not shown should not be interpreted as meaning these construction details are not *required*. Therefore a figure must not be used as an indication of the full construction requirements in a given situation, as the only available option, or a substitute for referencing appropriate construction requirements (in other sources) for a given clause.

Part A2 Compliance with the NCC

Introduction to this Part

This Part explains the possible methods of demonstrating compliance with the NCC. It explains the various compliance pathways within the NCC and the appropriate steps that must be taken for each of these pathways.

A2.0 Compliance

Compliance with the NCC is achieved by complying with—

- (1) the Governing Requirements of the NCC; and
- (2) the *Performance Requirements*.

A2.1 Compliance with the Performance Requirements

Performance Requirements are satisfied by one of the following, as shown in Figure 1:

- (1) A *Performance Solution*.
- (2) A *Deemed-to-Satisfy Solution*.
- (3) A combination of (1) and (2).

Figure 1: NCC compliance option structure

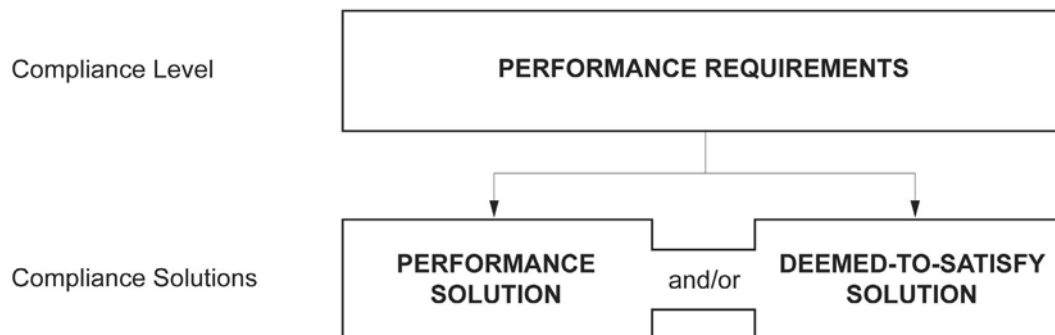

A2.2 Performance Solution

- (1) A *Performance Solution* is achieved by demonstrating—
 - (a) compliance with all relevant *Performance Requirements*; or
 - (b) the solution is at least *equivalent* to the *Deemed-to-Satisfy Provisions*.
- (2) A *Performance Solution* must be shown to comply with the relevant *Performance Requirements* through one or a combination of the following *Assessment Methods*:
 - (a) Evidence of suitability in accordance with Part A5 that shows the use of a material, product, *plumbing* and *drainage product*, form of construction or design meets the relevant *Performance Requirements*.
 - (b) A *Verification Method* including the following:
 - (i) The *Verification Methods* provided in the NCC.
 - (ii) Other *Verification Methods*, accepted by the *appropriate authority* that show compliance with the relevant *Performance Requirements*.
 - (c) *Expert Judgement*.
 - (d) Comparison with the *Deemed-to-Satisfy Provisions*.
- (3) Where a *Performance Requirement* is satisfied entirely by a *Performance Solution*, in order to comply with (1) the

Governing Requirements

following method must be used to determine the *Performance Requirement* or *Performance Requirements* relevant to the *Performance Solution*:

- (a) Identify the relevant *Performance Requirements* from the Section or Part to which the *Performance Solution* applies.
 - (b) Identify *Performance Requirements* from other Sections or Parts that are relevant to any aspects of the *Performance Solution* proposed or that are affected by the application of the *Performance Solution*.
- (4) Where a *Performance Requirement* is proposed to be satisfied by a *Performance Solution*, the following steps must be undertaken:
- (a) Prepare a *performance-based design brief* in consultation with relevant stakeholders.
 - (b) Carry out analysis, using one or more of the *Assessment Methods* listed in (2), as proposed by the *performance-based design brief*.
 - (c) Evaluate results from (b) against the acceptance criteria in the *performance-based design brief*.
 - (d) Prepare a final report that includes—
 - (i) all *Performance Requirements* and/or *Deemed-to-Satisfy Provisions* identified through A2.2(3) or A2.4(3) as applicable; and
 - (ii) identification of all *Assessment Methods* used; and
 - (iii) details of steps (a) to (c); and
 - (iv) confirmation that the *Performance Requirement* has been met; and
 - (v) details of conditions or limitations, if any exist, regarding the *Performance Solution*.

Note:

A2.2(4) does not take effect until 1 July 2021.

A2.3 Deemed-to-Satisfy Solution

- (1) A solution that complies with the *Deemed-to-Satisfy Provisions* is deemed to have met the *Performance Requirements*.
- (2) A *Deemed-to-Satisfy Solution* can show compliance with the *Deemed-to-Satisfy Provisions* through one or more of the following *Assessment Methods*:
 - (a) Evidence of suitability in accordance with Part A5 that shows the use of a material, product, *plumbing* and *drainage product*, form of construction or design meets a *Deemed-to-Satisfy Provision*.
 - (b) *Expert Judgement*.
- (3) For **Volume Two**:
 - (a) Where an acceptable construction manual and an acceptable construction practice contained in the same Part are considered to satisfy the same component of a *Performance Requirement*, in order to comply with the *Deemed-to-Satisfy Provisions* it is only necessary to satisfy—
 - (i) the appropriate acceptable construction manual; or
 - (ii) the appropriate acceptable construction practice.
 - (b) Where an acceptable construction manual and an acceptable construction practice contained in the same Part are deemed to satisfy different components of a *Performance Requirement*, compliance with the *Deemed-to-Satisfy Provisions* may require satisfying both the listed acceptable construction manual and the acceptable construction practice for their specific components unless otherwise stated.

Governing Requirements

A2.4 A combination of solutions

- (1) *Performance Requirements* may be satisfied by using a combination of *Performance Solutions* and *Deemed-to-Satisfy Solutions*.
- (2) When using a combination of solutions, compliance can be shown through the following, as appropriate:
 - (a) *A2.2* for assessment against the relevant *Performance Requirements*.
 - (b) *A2.3* for assessment against the relevant *Deemed-to-Satisfy Provisions*.
- (3) Where a *Performance Requirement* is satisfied by a *Performance Solution* in combination with a *Deemed-to-Satisfy Solution*, in order to comply with (1), the following method must be used to determine the *Performance Requirement* or *Performance Requirements* relevant to the *Performance Solution*:
 - (a) Identify the relevant *Deemed-to-Satisfy Provisions* of each Section or Part that are to be the subject of the *Performance Solution*.
 - (b) Identify the *Performance Requirements* from the same Sections or Parts that are relevant to the identified *Deemed-to-Satisfy Provisions*.
 - (c) Identify *Performance Requirements* from other Sections or Parts that are relevant to any aspects of the *Performance Solution* proposed or that are affected by the application of the *Deemed-to-Satisfy Provisions* that are the subject of the *Performance Solution*.

Explanatory information:

To comply with the NCC, a solution must achieve compliance with the Governing Requirements and the *Performance Requirements*. The Governing Requirements contain requirements about how the *Performance Requirements* must be met.

Performance Requirements outline the minimum necessary standards different buildings or building elements must attain. The *Performance Requirements* are the only NCC technical provisions that must be satisfied.

In some instances, State and Territory variations and additions may also be applicable to certain *Performance Requirements*.

A solution may be partly a *Performance Solution* and partly a *Deemed-to-Satisfy Solution*. However, no matter what method is chosen, building proponents need to always meet the *Performance Requirements* of the NCC.

A2.2(b)(ii) provides for the use of *Verification Methods* that are not listed in the NCC. A *Verification Method* may include—

1. a calculation, using analytical methods or mathematical models; or
2. a test, using a technical procedure, either on-site or in a laboratory, to directly measure the extent to which the *Performance Requirements* have been met; or
3. an inspection (and inspection report); or
4. any other acceptable form of certification.

Any *Verification Method* used must be acceptable to the *appropriate authority*.

A *Performance Solution* must comply with all applicable *Performance Requirements* of the NCC. A *Performance Solution* provides a tailored solution to meet the intended objective of the *Performance Requirements*. A *Performance Solution* must comply with all relevant *Performance Requirements* and must be verified using one or a combination of the following *Assessment Methods*:

- Evidence of suitability.
- *Verification Method*.
- *Expert Judgement*.
- Comparison with the *Deemed-to-Satisfy Provisions*.

For example, building proponents who wish to know what has to be done to satisfy the fire safety *Performance Requirements* for a particular building can either follow the *Deemed-to-Satisfy Provisions* or develop a *Performance Solution*. Guidance on how to develop *Performance Solutions* can be found on the ABCB website at: www.abcb.gov.au. The ABCB Resource Library contains information on the development of *Performance Solutions* for both building and plumbing.

A *Deemed-to-Satisfy Solution* is achieved by following all appropriate *Deemed-to-Satisfy Provisions* in the NCC. The *Deemed-to-Satisfy Provisions* are prescriptive (i.e. like a recipe book, they tell you how, what and in which location things must be done). They include materials, components, design factors, and construction methods that, if used, are deemed to meet the *Performance Requirements*, hence the term “Deemed-to-Satisfy”.

Governing Requirements

A *Deemed-to-Satisfy Solution* may be verified using one or a combination of the following *Assessment Methods*:

- Evidence of suitability.
- *Expert Judgement*.

Some *Performance Requirements* are without *Deemed-to-Satisfy Solutions*. Compliance with these *Performance Requirements* must be achieved by using a *Performance Solution*.

In *Section 3* of Volume Two the *Deemed-to-Satisfy Provisions* are divided into two compliance pathways: “acceptable construction practices” and “acceptable construction manuals”:

- “Acceptable construction practices” are some of the most common forms of national construction practices and are written into *Section 3*.
- “Acceptable construction manuals” are the deemed-to-satisfy referenced documents.

In general, either an “acceptable construction practice” or an “acceptable construction manual” may be used as options when proposing a *Deemed-to-Satisfy Solution*.

Acceptable construction practices are *Deemed-to-Satisfy Provisions* that are considered to meet the legislative requirements for Class 1 and Class 10 buildings.

There is no obligation to adopt any particular option contained in the acceptable construction practices, if it is preferred to meet the *Performance Requirement* in some other way.

However, if one of the options described in these provisions is not complied with, then the *appropriate authority* must be satisfied that the *Performance Requirements* have been met.

When designing a building or *plumbing* or *drainage* system, both *Performance Solutions* and *Deemed-to-Satisfy Solutions* can be used to achieve compliance with *Performance Requirements*. A combination of solutions may be used to satisfy a single *Performance Requirement*. This may include occasions where a specific *Performance Requirement* covers a number of elements of a building or *plumbing* or *drainage* system.

No NCC provision can be considered in isolation. Any departure from the *Deemed-to-Satisfy Provisions* for a *Performance Solution* needs to be assessed against the relevant *Performance Requirements* within the relevant NCC

Section or Part. Additionally, the proposed *Performance Solution* may also impact on other *Performance Requirements* in other Sections or Parts. Thus, these additional *Performance Requirements* need to be considered in relation to the subject *Performance Solution*. *A2.2(3)* and *A2.4(3)* set out the methods for determining which *Performance Requirements* are relevant.

It is important that a holistic approach is used when determining the appropriate *Performance Requirements*.

More information on NCC compliance methods is located at www.abcb.gov.au.

A2.4(2)(a) references *A2.2*. Therefore when using a combination of *Performance Solutions* and *Deemed-to-Satisfy Solutions* it is necessary to comply with *A2.2(4)* where a *Performance Requirement* is proposed to be satisfied by a *Performance Solution*.

Part A3 Application of the NCC in States and Territories

Introduction to this Part

This Part explains applying the NCC in accordance with State or Territory legislation. The NCC has legal effect through references in relevant State and Territory building and plumbing legislation.

Although the NCC is a nationally consistent code, there are some situations where a State or Territory enforce a variation, addition or deletion to it. This Part also explains how these variations, additions and deletions apply.

A3.0 State and Territory compliance

- (1) For application within a particular State or Territory, the Volumes of the NCC comprise inclusively of—
 - (a) Sections A to J and associated schedules of Volume One; and
 - (b) Sections 1 to 3 and associated schedules of Volume Two; and
 - (c) Sections A to E and associated schedules of Volume Three.
- (2) State or Territory variations, additions and deletions must be complied with in conjunction with the NCC.
- (3) The NCC is subject to, and may be overridden by, State or Territory legislation.
- (4) For Volumes One and Three, State and Territory variations, additions and deletions are contained in [Schedule 1](#).
- (5) For Volume Two, State and Territory variations, additions and deletions are contained throughout the Volume and in [Schedule 1](#).
- (6) State and Territory variations and deletions are identified throughout the NCC.

Explanatory information:

The NCC is given legal effect by building regulatory legislation in each State and Territory. This legislation consists of an Act of Parliament and subordinate legislation which empowers the regulation of certain aspects of building and plumbing, and contains the administrative provisions necessary to give effect to the legislation.

Although the NCC is a national code, in some instances it is necessary for a State or Territory to vary or apply additional requirements specific to their jurisdiction. [A3.0\(2\)](#) highlights that these variations, additions or deletions must be applied in conjunction with the NCC provisions. Typically, these variations, additions or deletions override the requirements contained within the NCC.

Any provision of the NCC may be overridden by, or subject to, State or Territory legislation. The NCC must therefore be read in conjunction with that legislation. Any queries on such matters should be referred to the State or Territory authority responsible for building and plumbing regulatory matters.

Where a requirement or provision of the NCC is subject to a State or Territory variation, addition, or deletion, a reference to the appropriate provision in [Schedule 1](#) is included with that requirement or provision.

Part A4 NCC referenced documents

Introduction to this Part

This Part explains how documents referenced in the NCC are adopted and applied. The NCC itself does not contain details of every design and construction requirement for a building or *plumbing* or *drainage* system. As such, the NCC calls upon or “references” other documents with this information. These are called NCC referenced documents. Examples of these are Australian Standards, ABCB protocols, ABCB standards and other publications.

There are multiple types of referenced documents. A primary referenced document is one referenced in [Schedule 4](#) of the NCC. A secondary referenced document is one referenced in a primary referenced document. Other referenced documents are referenced by secondary and subsequently referenced documents.

A4.0 Referenced documents

- (1) A reference in the NCC to a document refers to the edition or issue and any amendment listed in [Schedule 4](#).
- (2) A document referenced in the NCC is only applicable in the context in which the document is quoted.

Volume Three Tas A4.0(3)

- (3) Where a new edition, issue or amendment of a primary referenced document is not listed under [Schedule 4](#), the new edition, issue or amendment is not referenced for the purposes of the NCC.
- (4) Any document referenced in a primary referenced document is known as a secondary referenced document.
- (5) A reference in a primary referenced document to a secondary or other referenced document is a reference to the document as it existed at the time of publication of the primary referenced document.

Exemption 1:

If the secondary or other referenced document is also a primary referenced document, [A4.0\(5\)](#) does not apply.

A4.1 Differences between referenced documents and the NCC

The NCC overrules any difference between the NCC and a primary referenced document, including any secondary referenced document.

Exemption 1:

[A4.1](#) does not apply to acceptable construction manuals when used in their entirety to comply with requirements of the NCC unless otherwise stated.

A4.2 Adoption of referenced documents

The NCC does not require compliance with requirements in relation to the following matters where they are prescribed in a referenced document:

- (1) The rights, responsibilities or obligations between the manufacturer, supplier or purchaser.
- (2) The responsibilities of any trades person or other building operative, architect, engineer, authority, or other person or body.
- (3) The submission for approval of any material, building component, form or method of construction, to any person, authority or body other than those empowered under State or Territory legislation to give that approval.
- (4) The submission of a material, product, form of construction or design to any person, authority or body for an opinion.
- (5) Any departure from the NCC, rule, specification or provision at the sole discretion of the manufacturer or purchaser, or by arrangement or agreement between the manufacturer and purchaser.

Explanatory information:

[Schedule 4](#) is only mandatory to *Deemed-to-Satisfy Provisions*, *Verification Methods* and [Schedules 3, 5 and 6](#). However, referenced documents are only applicable to the NCC provision that references the document.

A proponent undertaking a *Performance Solution* can use any element or edition of any document, if they help satisfy the *Performance Requirements*. They do not need to use the documents listed in [Schedule 4](#).

Governing Requirements

[Schedule 4](#) lists the specific edition of the Standard or other document adopted, including any amendments considered appropriate for [Schedule 3](#), the *Deemed-to-Satisfy Provisions* or *Verification Methods*. Other editions of (or amendments to) the referenced document are not adopted and have no standing under the NCC.

A primary referenced document may refer to a secondary referenced document. [A4.0\(5\)](#) stipulates that the secondary referenced document is the edition of the document that existed at the time of publication of the primary referenced document. When another edition of (or amendment to) a secondary referenced document is released, subject to [A4.0 Exemption 1](#), that edition (or amendment) is not adopted for the purposes of the primary referenced document.

[A4.2](#) means that contractual matters or clauses defining responsibilities of various parties, and matters not appropriate for adoption in the NCC are not included when a document is called up in the NCC.

Part A5 Documentation of design and construction

Introduction to this Part

This Part explains the evidence needed to show that the NCC requirements are met and the solution is “fit for purpose”. It covers the use of materials, products, forms of construction and designs. It details separate requirements for the BCA and PCA.

Examples of evidence to be prepared and retained include certificates, reports, calculations and any other documents or information showing compliance with the NCC requirements.

A5.0 Suitability

- (1) A building and *plumbing* or *drainage* installation must be constructed using materials, products, *plumbing products*, forms of construction and designs fit for their intended purpose to achieve the relevant requirements of the NCC.
- (2) For the purposes of (1), a material, product, *plumbing product*, form of construction or design is fit for purpose if it is—
 - (a) supported by evidence of suitability in accordance with—
 - (i) [A5.1](#); and
 - (ii) [A5.2](#) or [A5.3](#) as appropriate; and
 - (b) constructed or installed in an appropriate manner.

A5.1 Evidence of suitability—Volumes One, Two and Three

- (1) The form of evidence used must be appropriate to the use of the material, product, *plumbing product*, form of construction or design to which it relates.
- (2) Any copy of documentary evidence submitted must be a complete copy of the original certificate, report or document.

A5.2 Evidence of suitability—Volumes One and Two

Application 1:

[A5.2](#) is only applicable to the BCA.

- (1) Subject to [A5.4](#), [A5.5](#) and [A5.6](#), evidence to support that the use of a material, product, form of construction or design meets a *Performance Requirement* or a *Deemed-to-Satisfy Provision* may be in the form of any one, or any combination of the following:
 - (a) A current CodeMark Australia or CodeMark *Certificate of Conformity*.
 - (b) A current *Certificate of Accreditation*.
 - (c) A current certificate, other than a certificate described in (a) and (b), issued by a *certification body* stating that the properties and performance of a material, product, form of construction or design fulfil specific requirements of the BCA.
 - (d) A report issued by an *Accredited Testing Laboratory* that—
 - (i) demonstrates that a material, product or form of construction fulfils specific requirements of the BCA; and
 - (ii) sets out the tests the material, product or form of construction has been subjected to and the results of those tests and any other relevant information that has been relied upon to demonstrate it fulfils specific requirements of the BCA.
 - (e) A certificate or report from a *professional engineer* or other *appropriately qualified person* that—
 - (i) certifies that a material, product, form of construction or design fulfils specific requirements of the BCA; and
 - (ii) sets out the basis on which it is given and the extent to which relevant standards, specifications, rules, codes of practice or other publications have been relied upon to demonstrate it fulfils specific requirements of the BCA.

Governing Requirements

- (f) Another form of documentary evidence, such as but not limited to a *Product Technical Statement*, that—
 - (i) demonstrates that a material, product, form of construction or design fulfils specific requirements of the BCA; and
 - (ii) sets out the basis on which it is given and the extent to which relevant standards, specifications, rules, codes of practice or other publications have been relied upon to demonstrate it fulfils specific requirements of the BCA.
- (2) Evidence to support that a calculation method complies with an ABCB protocol may be in the form of any one, or any combination of the following:
 - (a) A certificate from a *professional engineer* or other *appropriately qualified person* that—
 - (i) certifies that the calculation method complies with a relevant ABCB protocol; and
 - (ii) sets out the basis on which it is given and the extent to which relevant standards, specifications, rules, codes of practice and other publications have been relied upon.
 - (b) Another form of documentary evidence that correctly describes how the calculation method complies with a relevant ABCB protocol.

A5.3 Evidence of suitability—Volume Three

Application 1:

A5.3 is only applicable to the PCA.

- (1) Any *product* that is intended for use in contact with *drinking water* must comply with the relevant requirements of AS/NZS 4020 in the form of either—

Tas A5.3(1)(a)

- (a) a test report provided by a *certification body* or *Accredited Testing Laboratory*, in accordance with AS/NZS 4020; or
- (b) a *WaterMark Licence* issued in accordance with (2), if it includes compliance with AS/NZS 4020.

Tas A5.3(1)(c)

- (2) A *product* of a type listed on the *WaterMark Schedule of Products* is deemed to be fit for its intended purpose if it has a *WaterMark Licence* issued in accordance with the WaterMark Scheme Rules.
- (3) A *product* of a type listed on the *WaterMark Schedule of Excluded Products* requires evidence of suitability in the form of—
 - (a) a current certificate issued by a *certification body* stating that the properties and performance of a *product* can meet the requirements of the PCA; or

Tas A5.3(3)(b)

- (b) a report issued by an *Accredited Testing Laboratory* that—
 - (i) demonstrates that the *product* complies with the relevant requirements of the PCA; and
 - (ii) sets out the tests the *product* has been submitted to and the results of those tests and any other relevant information that has been relied upon to demonstrate suitability for use in a *plumbing* or *drainage* installation.

- (4) Any *product* that is not covered by (2) or (3) must be subjected to a risk assessment in accordance with the WaterMark Scheme Rules.

Tas A5.3(401)

- (5) Evidence to support that a design or system meets the relevant PCA *Performance Requirements* must be in the form of any one or any combination of the following:
 - (a) The design or system complies with a *Deemed-to-Satisfy Provision*.
 - (b) The design or system is a *Performance Solution* from a *professional engineer* or a *recognised expert* that—
 - (i) certifies that the design or system complies with the relevant requirements of the PCA; and
 - (ii) sets out the basis on which it is given and the extent to which relevant standards, specifications, rules, codes of practice or other publications have been relied upon.

Governing Requirements

Tas A5.3(5)(b)(iii)

- (6) Any other form of documentary evidence that—
- (a) demonstrates that a design or system complies with the relevant requirements of the PCA; and
 - (b) sets out the basis on which it is given and the extent to which relevant standards, specifications, rules, codes of practice or other publications have been relied upon.

Tas A5.3(7), (8), (9), (10)

A5.4 Fire-resistance of building elements

Where a *Deemed-to-Satisfy Provision* requires a building element to have an FRL, it must be determined in accordance with [Schedule 5](#).

A5.5 Fire hazard properties

Where a *Deemed-to-Satisfy Provision* requires a building component or assembly to have a *fire hazard property* it must be determined as follows:

- (1) For *average specific extinction area*, *critical radiant flux* and *Flammability Index*, as defined in [Schedule 3](#).
- (2) For *Smoke-Developed Index* and *Spread-of-Flame Index*, in accordance with [Schedule 6](#).
- (3) For a material's *group number* or *smoke growth rate index* (SMOGR_{RC}), in accordance with [Clause 4\(b\)](#) of [Specification C1.10](#).

A5.6 Resistance to the incipient spread of fire

A ceiling is deemed to have a *resistance to the incipient spread of fire* to the space above itself if—

- (1) it is identical with a prototype that has been submitted to the *Standard Fire Test* and the *resistance to the incipient spread of fire* achieved by the prototype is confirmed in a report from an *Accredited Testing Laboratory* that—
 - (a) describes the method and conditions of the test and form of construction of the tested prototype in full; and
 - (b) certifies that the application of restraint to the prototype complies with the *Standard Fire Test*; or
- (2) it differs in only a minor degree from a prototype tested under (1) and the *resistance to the incipient spread of fire* attributed to the ceiling is confirmed in a report from an *Accredited Testing Laboratory* that—
 - (a) certifies that the ceiling is capable of achieving the *resistance to the incipient spread of fire* despite the minor departures from the tested prototype; and
 - (b) describes the materials, construction and conditions of restraint that are necessary to achieve the *resistance to the incipient spread of fire*.

A5.7 Labelling of Aluminium Composite Panels

An *Aluminium Composite Panel* must be labelled in accordance with SA TS 5344.

ACT Appendix

Explanatory information:

[A5.0](#) relates to the quality of work and materials needed to construct a building to meet NCC requirements.

This means that—

- all people involved with construction must work skillfully in accordance with good trade practice; and
- all materials must be of a quality to fulfil their function/s within the building.

[A5.0](#) only applies to matters normally covered by the NCC.

While [A5.0](#) outlines quality of work and material demands, sometimes additional conditions may be required by—

- other Commonwealth, State or Territory legislation; and
- contracts that include either specific quality requirements, or requirements for specific materials and the like.

Example

Permit authorities would ordinarily not apply [A5.0](#) to such matters as—

Governing Requirements

- plastering—other than for fire rating, waterproofing of *wet areas*, and sound insulation; or
- painting—other than that *required* for weatherproofing an *external wall*.

When determining which form of evidence will be used, it is important to consider the appropriateness of the evidence, as some forms of evidence may be more suitable to materials and products and others to designs and forms of construction. The requirement to consider appropriateness of the evidence is specified in [A5.1\(1\)](#).

For further guidance, refer to the ABCB Handbook for Evidence of Suitability.

All copies of documents provided as evidence must be unabridged copies of the originals. No part can be left incomplete. [A5.2](#) represents the minimum level of documentary evidence needed to show that a material, product, form of construction or design meets the relevant NCC requirements. The evidence can be required by:

- an *appropriate authority*;
- a party to a construction contract; or
- a person certifying compliance with the NCC.

If a building proponent does not produce exactly what is required, the evidence may be rejected.

It should be noted that design may refer to engineering design, architectural design as well as product and material design.

[A5.2\(1\)\(f\)](#) allows for the use of alternative forms of documentary evidence to those included in [A5.2\(1\)\(a\)](#) to [\(e\)](#), as long as they comply with certain specified conditions.

An example of this arises when an authority carries out an inspection of a building site. The inspection alone would not be acceptable as evidence. However, if the authority compiled a written report detailing findings and conclusions from the inspection, then it may comply with the requirements of [A5.2\(1\)\(f\)](#).

A *Product Technical Statement* detailing the characteristics and merits of a particular product or system is also an example of another form of documentary evidence.

There is significant reliance by industry on the use of calculation methods, including software programs, for demonstrating compliance with the NCC. While there is no formal recognition of specific methods, [A5.2\(2\)](#) allows suitable evidence to be submitted to demonstrate that a calculation method (including a software program) complies with a relevant ABCB protocol that establishes the characteristics of a suitable calculation method.

[A5.3\(1\)](#) requires any *product* intended for use in contact with *drinking water* to comply with AS/NZS 4020. Compliance is achieved by passing the relevant tests set out in the Standard. Evidence of compliance must then be provided in accordance with [A5.3\(1\)](#), under which there are two options. The first, at [A5.3\(1\)\(a\)](#), recognises test reports and certificates that cover compliance with AS/NZS 4020 only. The second, at [A5.3\(1\)\(b\)](#), recognises *WaterMark Licences* where compliance with AS/NZS 4020 is a requirement of the relevant *product* Standard or WaterMark Technical Specification.

For *products* that are of a type listed on the *WaterMark Schedule of Products*, [A5.3\(2\)](#) requires that these *products* have a *WaterMark Licence*. A *WaterMark Licence* reflects that the *product* has been certified and authorised in accordance with the WaterMark Scheme Rules.

For *products* that are not subject to WaterMark certification (i.e. excluded *products*), evidence that can be used to support that the *product* is fit for its intended purpose is provided in [A5.3\(3\)](#). This may include demonstrating compliance with a *product* specification referenced in the *WaterMark Schedule of Excluded Products*, where one is available.

[A5.3\(4\)](#) provides that any product that is not listed on the *WaterMark Schedule of Products* or the *WaterMark Schedule of Excluded Products* must be subjected to a risk assessment in accordance with the WaterMark Scheme Rules. The risk assessment will determine whether the product in question requires certification and authorisation, or if it should be listed as an “excluded product”. This in turn will determine the form of evidence of suitability applicable to the *product*.

What is WaterMark?

The *WaterMark Certification Scheme* is a mandatory certification scheme for *plumbing* and *drainage products* to ensure that these *products* are fit for purpose and appropriately authorised for use in a *plumbing* or *drainage* system.

The PCA, through [Part A5](#), requires certain *plumbing* and *drainage products* to be certified and authorised for use in a *plumbing* or *drainage* system. These *products* are certified through the *WaterMark Certification Scheme* and listed on the WaterMark Product Database.

The *WaterMark Certification Scheme* is governed by the WaterMark Scheme Rules, which are available for download from the ABCB website at: www.abcb.gov.au. These rules set out the requirements for risk assessments, evaluation, certification, and the drafting of WaterMark Technical Specifications.

When a *product* is listed on the *WaterMark Schedule of Products* then, for it to be certified and authorised, the *product* must—

Governing Requirements

- be tested by an *Accredited Testing Laboratory*; and
- comply with an approved *product* specification (either a relevant existing *product* Standard or a WaterMark Technical Specification); and
- be manufactured in accordance with an approved Quality Assurance Program; and
 - carry a scope of use.

Products that comply fully with the applicable requirements of the *WaterMark Certification Scheme* are then eligible to be certified by a *WaterMark Conformity Assessment Body* and listed on the WaterMark Product Database. Certified *products* are identifiable by the WaterMark certification trade mark, shown below, that must be displayed on the *product* upon granting of a *WaterMark Licence*.

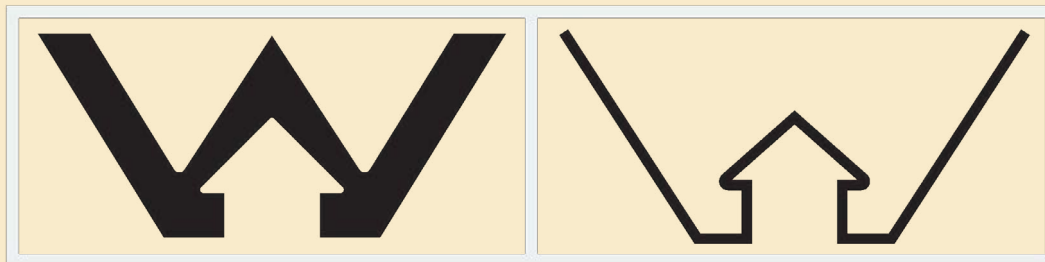

If under a *Deemed-to-Satisfy Provision* a building element is *required* to have an FRL, then *A5.2* may be used to provide evidence to show that the FRL has been determined in accordance with *Schedule 5*.

In the case of a test report from an *Accredited Testing Laboratory*, the report may be either—

- the test report referred to in clause 2.16.2 of AS 1530.4 (also referred to as a full test report); or
- the regulatory information report referred to in clause 2.16.3 of AS 1530.4 (also referred to as a short-form report).

In both cases the report must be an unabridged copy of the original report. A test certificate referred to in clause 2.16.4 of AS 1530.4 on its own is not suitable for showing compliance with the NCC.

If a proposal uses a *Deemed-to-Satisfy Provision* that requires a building element to have *fire hazard properties*, then *A5.2* may be used to provide evidence to support the proposal and show that the *fire hazard properties* have been determined in accordance with *A5.5*.

Refer to the guidance provided in the Guide to Volume One for further information on *fire hazard properties* which includes—

- *Flammability Index*; and
- *Spread-of-Flame Index*; and
- *Smoke-Developed Index*; and
- a material's *group number*; and
- *smoke growth rate index*.

The *Deemed-to-Satisfy Provisions* of the BCA contain a number of provisions requiring a ceiling to have a *resistance to the incipient spread of fire* to the space above itself. *A5.6* sets out the method of determining the incipient spread of fire. The method is based on the method of determining the FRL of a building element and use of the *Standard Fire Test*.

Part A6 Building classification

Introduction to this Part

The NCC groups buildings and structures by the purpose for which they are designed, constructed or adapted to be used, rather than by the function or use they are put to, assigning each type of building or structure with a classification. This Part explains how each building classification is defined and used in the NCC.

The building classifications are labelled “Class 1” through to “Class 10”. Some classifications also have sub-classifications, referred to by a letter after the number (e.g. Class 1a).

The technical building requirements for Class 2 to 9 buildings are mostly covered by Volume One of the NCC and those for Class 1 and 10 buildings are mostly covered by Volume Two of the NCC. Volume Three of the NCC covers *plumbing* and *drainage* requirements for all building classifications.

A building may have parts that have been designed, constructed or adapted for different purposes. In most cases, each of these parts is a separate classification. A building (or part of a building) may also have more than one such purpose and may be assigned more than one classification.

A6.0 Determining a building classification

- (1) The classification of a building or part of a building is determined by the purpose for which it is designed, constructed or adapted to be used.
- (2) Each part of a building must be classified according to its purpose and comply with all the appropriate requirements for its classification.

Exemption 1:

For A6.0(1) where a part of a building has been designed, constructed or adapted for a different purpose and is less than 10% of the *floor area* of the *storey* it is situated on, the classification of the other part of the *storey* may apply to the whole *storey*.

Limitation 1:

Exemption 1 does not apply where the minor use of a building is a laboratory or a Class 2, 3 or 4 part of a building.

- (3) A room that contains a mechanical, thermal or electrical facility or the like that serves the building must have the same classification as the major part or principal use of the building or *fire compartment* in which it is situated.

Exemption 2:

A6.0(3) does not apply to an *electricity network substation*.

- (4) Unless another classification is more suitable an *occupiable outdoor area* must have the same classification as the part of the building to which it is associated.

A6.1 Class 1 buildings

A Class 1 building includes one or more of the following sub-classifications:

- (1) Class 1a is one or more buildings, which together form a single dwelling including the following:
 - (a) A detached house.
 - (b) One of a group of two or more attached dwellings, each being a building, separated by a *fire-resisting* wall, including a row house, terrace house, town house or villa unit.
- (2) Class 1b is one or more buildings which together constitute—
 - (a) a boarding house, guest house, hostel or the like that—
 - (i) would ordinarily accommodate not more than 12 people; and
 - (ii) have a total area of all floors not more than 300 m² (measured over the enclosing walls of the building or buildings); or
 - (b) four or more single dwellings located on one allotment and used for short-term holiday accommodation.

Governing Requirements

Limitation 1:

For A6.1, a Class 1 building cannot be located above or below another dwelling or another Class of building, other than a *private garage*.

See Figures 1, 2 and 3.

Figure 1: Identification of Class 1 buildings

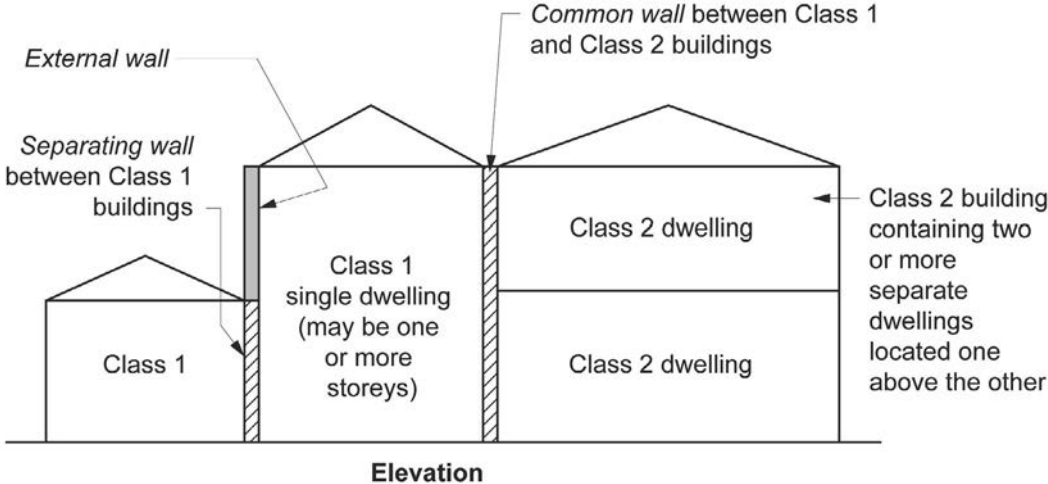

Governing Requirements

Figure 2: Typical Class 1 building configurations

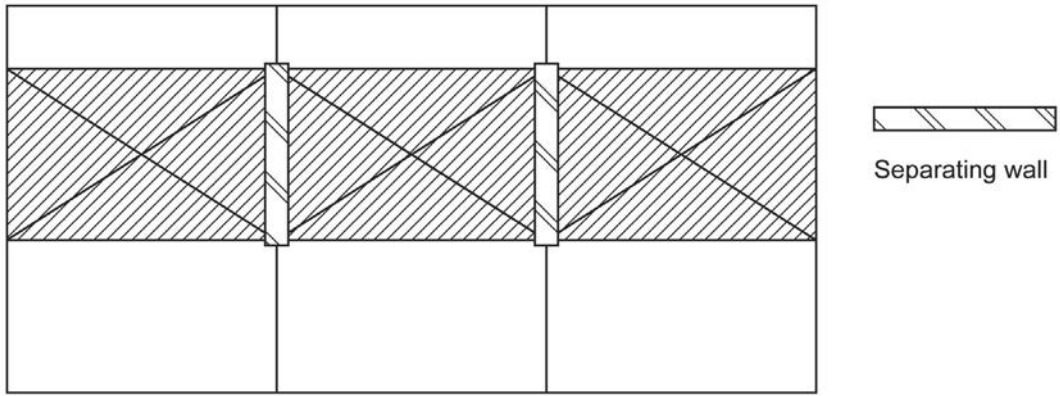

(a) 3 Class 1 buildings
on 3 separate allotments

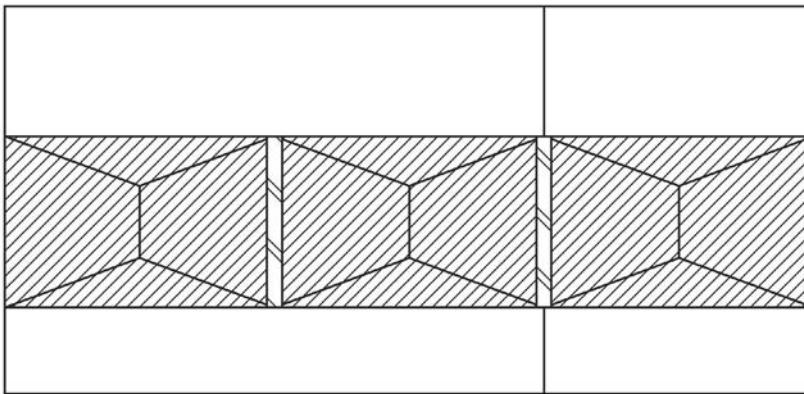

(b) 3 Class 1 buildings
on 2 separate allotments

Plan view

Governing Requirements

Figure 3: Domestic allotment – Classification of buildings and structures

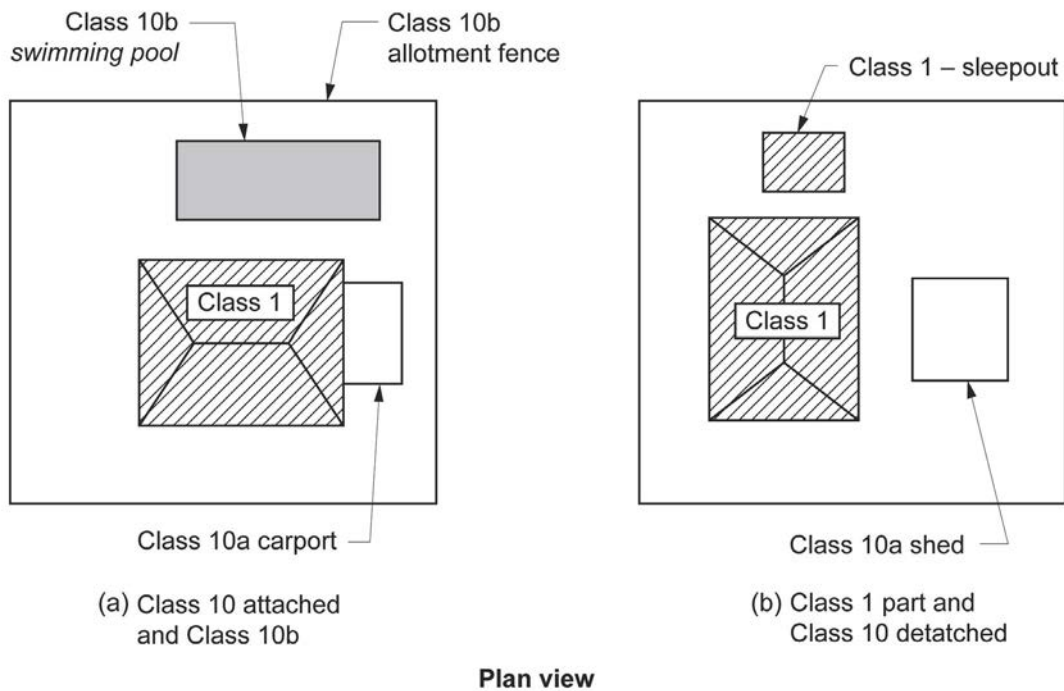

A6.2 Class 2 buildings

- (1) A Class 2 building is a building containing two or more *sole-occupancy units*.
- (2) Each *sole-occupancy unit* in a Class 2 building is a separate dwelling.

A6.3 Class 3 buildings

A Class 3 building is a residential building providing long-term or transient accommodation for a number of unrelated persons, including the following:

- (1) A boarding house, guest house, hostel, lodging house or backpacker accommodation.
- (2) A residential part of a hotel or motel.
- (3) A residential part of a *school*.
- (4) Accommodation for the aged, children, or people with disability.
- (5) A residential part of a *health-care building* which accommodates members of staff.
- (6) A residential part of a *detention centre*.
- (7) A *residential care building*.

Limitation 1:

For A6.3, a Class 3 building is not a Class 1 or 2 residential building. However, a building could be a mixture of Class 3 and another Class.

A6.4 Class 4 buildings

Class 4 is a dwelling in a Class 5, 6, 7, 8 or 9 building.

Application 1:

A6.4 only applies if it is the only dwelling in the building.

A6.5 Class 5 buildings

A Class 5 building is an office building used for professional or commercial purposes.

NSW Class 6

SA Class 6

A6.6 Class 6 buildings

A Class 6 building is a shop or other building used for the sale of goods by retail or the supply of services direct to the public, including—

- (1) an eating room, café, restaurant, milk or soft-drink bar; or
- (2) a dining room, bar area that is not an *assembly building*, shop or kiosk part of a hotel or motel; or
- (3) a hairdresser's or barber's shop, public laundry, or undertaker's establishment; or
- (4) a market or sale room, showroom, or *service station*.

A6.7 Class 7 buildings

A Class 7 building is a storage-type building that includes one or more of the following sub-classifications:

- (1) Class 7a — a *carpark*.
- (2) Class 7b — a building that is used for storage, or display of goods or produce for sale by wholesale.

A6.8 Class 8 buildings

A Class 8 building is a process-type building that includes the following:

- (1) A laboratory.
- (2) A building in which the production, assembling, altering, repairing, packing, finishing, or cleaning of goods or produce for sale takes place.

A6.9 Class 9 buildings

A Class 9 building is a building of a public nature that includes one or more of the following sub-classifications:

- (1) Class 9a — a *health-care building* including any parts of the building set aside as laboratories, and includes a *health-care building* used as a *residential care building*.
- (2) Class 9b — an *assembly building* including a trade workshop or laboratory in a primary or secondary *school*.

Exemption 1:

A6.9(2) excludes any parts of the building that are of another Class.

- (3) Class 9c — a *residential care building*.

A6.10 Class 10 buildings and structures

A Class 10 building includes one or more of the following sub-classifications:

- (1) Class 10a is a non-habitable building including a *private garage*, carport, shed or the like.
- (2) Class 10b is a structure that is a fence, mast, antenna, retaining wall or free-standing wall or *swimming pool* or the like.
- (3) Class 10c is a *private bushfire shelter*.

See [Figure 3](#).

A6.11 Multiple classifications

A building (or part of a building) may be designed, constructed or adapted for multiple purposes and have more than one classification.

Application 1:

For [A6.11](#), a building (or part of a building) must comply with all the relevant requirements that apply to each of the classifications for that building (or part of a building).

Governing Requirements

Explanatory information:

Classification is a process for understanding risks in a building or part, according to its use. It must be correctly undertaken to achieve NCC aims as appropriate to each building in each circumstance.

It is possible for a single building to have parts with different classifications. Part of a building can also have more than one classification. Where there is any conflict between what requirements the part should comply with, the more stringent requirement applies.

Where it is unclear which classification should apply, *appropriate authorities* have the discretion to decide. They base their decision on an assessment of the building proposal.

They will look at what classification the building most closely resembles. They will also take into account the likely *fire load*, plus, the likely consequences of any risks to the safety, health and amenity of people using the building.

Appropriate authorities will also look at any relevant court decisions or determinations of the State or Territory body responsible for considering appeals on building classification matters.

It should be noted that appeals body determinations and, in some States and Territories, certain court decisions are usually not precedent creating. Such decisions are determined on a case-by-case basis.

It should also be noted that State and Territory authorities responsible for building regulatory matters may have issued advice, interpretations or guidelines to assist practitioners in applying the correct classification to a building or part. Advice on such matters should be sought from the relevant authority.

Under [A6.0 Exemption 1](#), if 10% or less of the *floor area* of a *storey* is used for a purpose which could be classified differently to the remainder of that *storey*, that part may be classified as being the same as the remainder. Laboratories and *sole-occupancy units* in Class 2, 3 or 4 parts are excluded from this concession. The reason is that laboratories are considered to have a high *fire hazard* potential and classifying them with the remainder of the building could, in a majority of cases, endanger occupants of the other parts of the building which have a lower *fire hazard* potential. Also, the intent is not to allow *sole-occupancy units* in Class 2, 3 or 4 parts to be regarded as another Class such as Class 6 and then not have any fire or sound insulation between the units and any other classification which may have a high *fire load* and could endanger the occupants of the Class 2, 3 or 4 part.

If [A6.0 Exemption 1](#) is used, it should be remembered that it will still be necessary to use the occupant numbers in Volume One [Table D1.13](#) for the particular use of the area. Likewise, the lighting and equipment levels, people occupancy and load profiles for the area of minor use for the purposes of Volume One [Section J](#) must be in accordance with the use of the area.

If the *storey* has a very large *floor area*, the 10% or less concession area may also be large, even though the rest of the building is classifiable as a building which ordinarily has a lower risk potential. An example of the application of this area concession could be as follows:

- If a single *storey* factory has an office that takes up 8% of the whole *storey's floor area*, the entire building (including the office) can be classified as being Class 8.
- However if that office area takes up 12% of the *storey's floor area*, that area must be classified as Class 5, and the remainder of the building as Class 8.

Under [A6.0\(3\)](#) a plant room, machinery room, lift motor room or *boiler* room, have the same classification as the part of the building they are in. These kinds of rooms do not need to be ancillary or subordinate to the part of the building they are in, that is, the 10% criterion is not applicable.

There are specific provisions for these kinds of rooms. For example, Volume One [Section C](#) requires some of them to be fire separated from the remainder of the building (e.g. see [C2.13](#) with regard to elements of the electricity supply system).

Class 1 buildings are covered in Volumes Two and Three of the NCC. Class 1 buildings are not located above or below another dwelling, or another class of building other than a *private garage*.

A *sole-occupancy unit* used for residential purposes located over another *sole-occupancy unit* used for residential purposes will always be a Class 2 or Class 3 building (depending on the circumstances). It cannot be a Class 1 building.

A single Class 1 dwelling can be made up of more than one building. For example, it may include what is ordinarily called a house, plus one or more habitable 'outbuildings' such as sleepouts. Note that a habitable building such as a sleepout cannot be classified as a Class 10 building.

The height or number of storeys of a Class 1 building makes no difference to its classification.

Class 1b buildings used for short-term holiday accommodation include cabins in caravan parks, tourist parks, farm stay, holiday resorts and similar tourist accommodation. This accommodation itself is typically rented out on a commercial basis for short periods and generally does not require the signing of a lease agreement. Short-term accommodation can also be provided in a boarding house, guest house, hostel, bed and breakfast accommodation or the like.

Governing Requirements

Unlike a Class 1b building described in [A6.1\(2\)\(a\)](#), a Class 1b building described in [A6.1\(2\)\(b\)](#) does not have any *floor area* limitation. Therefore, if 4 or more single dwellings are located on the one allotment and used for short-term holiday accommodation, each single dwelling would be classified as a Class 1b building regardless of the *floor area* of each dwelling or the combined *floor area* of all of the dwellings.

See also Volume One [Table D3.1](#) which contains an explanation of what is considered be “one allotment”.

The Class 1b classification can attract concessions applicable to Class 3 buildings. These concessions allow people to rent out rooms in a house, or run a bed and breakfast, without having to comply with the more stringent Class 3 requirements. The reasoning is that the smaller size of the building and its lower number of occupants represents reduced fire risks.

Apart from their use, the primary difference between Class 1a and Class 1b buildings is that the latter is required to have a greater number of smoke alarms and in some circumstances, access and features for people with a disability.

A Class 2 building is one that includes more than one dwelling, each of which is generally solely occupied by one or more people to the exclusion of others.

Such buildings must not be otherwise classified as a Class 1 or Class 3 building or Class 4 part. See [Figure 4](#) for a typical configuration of Class 1 and Class 2 buildings.

Figure 4: Section showing a typical configuration of Class 1 and Class 2 buildings (with non-combustible roof coverings)

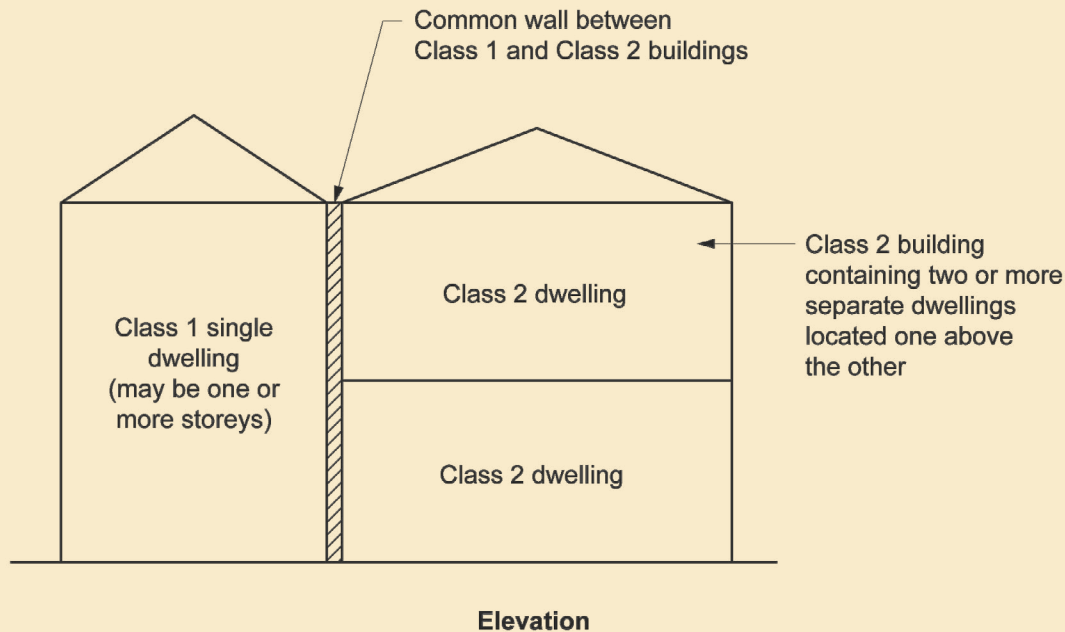

Where a sole-occupancy residential unit is located above another sole-occupancy residential unit, the building containing the units can be either a Class 2 or a Class 3 building, depending on the other circumstances of the building proposal.

Class 2 buildings can be single *storey* attached dwellings. Where there is any common space below such dwellings, they are Class 2 (and cannot be Class 1) irrespective of whether the space below is a *storey* or not (see [Figure 5](#)).

Governing Requirements

Figure 5: Elevation showing a single storey of Class 2 with a common area below

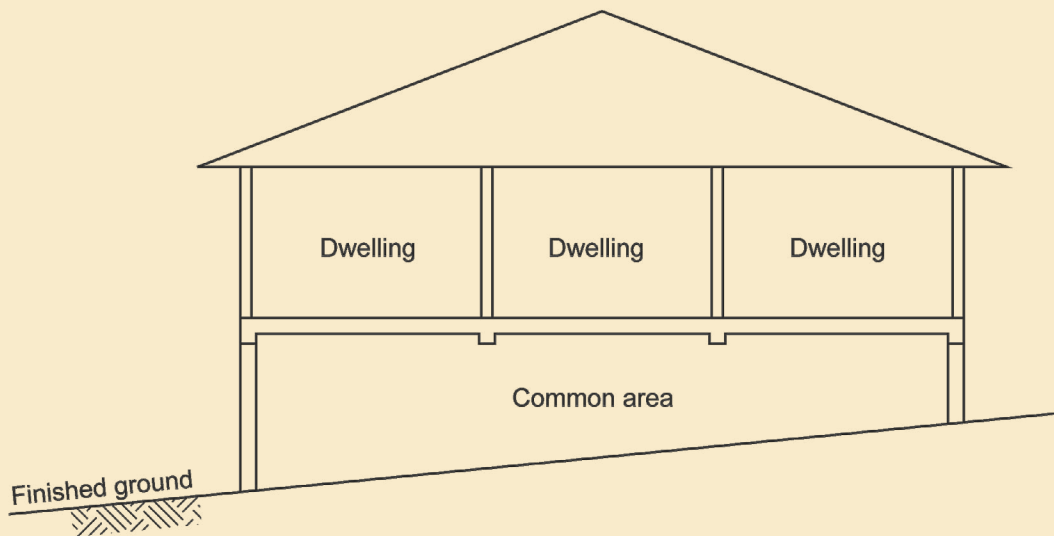

Class 2 buildings can be attached to buildings of another Class. The attached Class 2 buildings need not be attached to one another, and need not be more than a single [storey](#).

When two or more dwellings are attached to another Class, they cannot be Class 4 parts, as any building can only contain one Class 4 dwelling.

Class 3 buildings provide accommodation for unrelated people. The length of stay is unimportant.

Some exceptions to this classification include: certain bed and breakfast accommodation, boarding houses, guest houses, hostels, or lodging houses and the like which fall within the concession provided for Class 1b buildings.

Also, any sized building can be classified as Class 1 or Class 2 if it is used to house any number of unrelated people who jointly own or rent it, or share it on a non-rental basis with an owner or tenant.

It is not unusual for a manager's, owner's or caretaker's dwelling attached to a Class 3 building to be thought of as a Class 4 part of the Class 3 building. However, a Class 4 part of a building can only be part of a Class 5-9 building.

Accordingly, such dwellings are either classified as Class 1, Class 2 or Class 3, depending on the circumstances of the building proposal. However, a building could be a mixture of Class 3 and another Class.

Class 3 buildings include—

- the residential parts of hotels and motels; and
- hotel or motel caretakers', managers' or owners' flats, noting that under certain circumstances such dwellings could be Class 1, Class 2 or Class 3 buildings; and
- dormitory accommodation, in schools or elsewhere, noting that a dormitory is generally (but not always) considered to be a [sole-occupancy unit](#); and
- bed and breakfast accommodation, a boarding house, guest house, hostel, or lodging house; and
- backpackers' accommodation; and
- a building which houses elderly people or other people who require special care. (In some States or Territories it is not acceptable for a Class 1b building to be used to house elderly people or other people who require special care - it is recommended the local building regulatory body be consulted.); and
- workers' quarters, including shearers' or fruit pickers' accommodation, or hotel workers' accommodation.

Class 4 classification applies to some types of accommodation located within a Class 5-9 building. The most common include a caretaker's flat within a building; and accommodation over or otherwise connected to a shop.

A Class 4 part cannot be located within a Class 1, Class 2 or Class 3 building. There can only be one Class 4 dwelling in a building. If there are two or more dwellings, they are Class 1, Class 2, or possibly Class 3. These Class 1, Class 2 or Class 3 parts need not be attached to one another, nor be more than a single [storey](#).

Where a Class 4 part of a building is rented out for accommodation purposes, it retains its Class 4 classification. However, if any other part of the principal building is used for accommodation, for example, the attached shop is converted into an additional flat, both flats become classifiable as Class 2 or, depending on their use, possibly Class 3.

Governing Requirements

Class 5 buildings include professional chambers or suites, lawyers' offices, government offices, advertising agencies and accountants' offices.

A Class 6 building is a building where goods or services are directly sold or supplied to the public. Examples of a Class 6 building may include—

- a place where food or drink may be purchased such as a café or restaurant; or
- a dining room, bar area that is not an [assembly building](#), shop or kiosk part of a hotel or motel; or
- a hairdresser's or barber's shop, public laundry, veterinarian; or
- supermarket or sale room, florist, showroom, or [service station](#).

[Service stations](#) are Class 6 buildings. These are outlets used for the servicing of cars and the selling of fuel or other goods. The expression '[service station](#)' is not intended to cover buildings where panel beating, auto electrical, muffler replacement, tyre replacement and the like are solely carried out. Such buildings should be classified as Class 6, Class 7 or Class 8 buildings as the [appropriate authority](#) sees fit.

There are three basic types of Class 7 building. The first is a [carpark](#) as defined in the NCC. The second is a building used for storage, often referred to as a 'warehouse'. The third is a building used for the display of goods or produce for sale by wholesale. 'Wholesale' means sale to people in the trades or in the business of 'on-selling' goods and services to another party (including the public).

The most common way to describe a Class 8 building is as a 'factory'. However, this can give a simplistic impression of the types of building which can fall within this classification.

For example—

- some laboratories, despite their often small size, have been included as Class 8 buildings principally because of their high [fire hazard](#); and
- buildings used for altering or repairing (except [service stations](#), which are specifically included in [A6.6](#) as Class 6 buildings); and
- potteries; and
- food manufacturers (but not restaurants, which are specifically included in [A6.6](#) as Class 6 buildings); and
- buildings used for the packing or processing of produce, such as a farm or horticultural building.

Class 9a buildings are [health-care buildings](#), including day-care surgeries or procedure units and the like. See definition of [health-care building](#). Laboratories that are part of a Class 9a building are Class 9a, despite the general classification of laboratories as Class 8 buildings.

Class 9b buildings are [assembly buildings](#). These buildings can include—

- theatres, cinemas and halls, churches, schools, early childhood centres, kindergartens, preschools and child-minding centres; and
- indoor cricket, tennis, basketball centres and sport stadiums; and
- nightclubs, discotheques, bar areas providing live entertainment and/or containing a dance floor, public halls, dance halls and other places of entertainment; and
- snooker halls; and
- bus and railway stations.

Regarding [A6.9\(2\) Exemption 1](#), a building could be a mixture of Class 9b and another Class, or a Class 9b building could contain parts that are of another Class, but be taken as a Class 9b building because of [A6.0 Exemption 1](#).

Class 9c buildings are [residential care buildings](#) that may contain residents who have various care level needs.

The Class 9c classification recognises that many residents progress through a continuum of care needs from low to high. Many older people enter residential care with low care needs (typically Class 3 facilities) but, as they age, require higher levels of care. In the past, such progression often necessitated the transfer of a hostel resident (Class 3) to a nursing home (Class 9a). This frequently had negative consequences for the health and well-being of the resident, for whom the hostel accommodation was home. It also led, at times, to the separation of couples with differing care needs.

Building designers should note that Class 3 buildings include hostels for the accommodation of the aged, and Class 9a buildings include nursing homes. It is important to be aware, however, that construction of Class 3 or 9a buildings may restrict the options available to the operators of a facility in relation to the profile of the residents they wish to accommodate. Where the potential exists for residents of varying care needs to be accommodated, consideration of the Class 9c provisions may be appropriate. The Class 9c classification allows for any mix of low and high care residents and is intended to allow the mix to change as the residents' care needs change over time, without the need to obtain any further consent or approval from the [appropriate authority](#).

Governing Requirements

Multi-care level facilities are for residents who may require the full range of care services outlined by the Aged Care Act. Hence, it is not intended to restrict the resident type and provides maximum flexibility for service providers, residents and the community.

The NCC provisions for Class 9c buildings are based on minimal on duty on-site staff being available at any time. However, it is recognised that the staff numbers vary throughout the course of any one day, due to the care needs of the residents and the functioning of the facility. It is also recognised that the specific care needs of the residents may result in a greater minimum number of staff.

Class 10a buildings are non-habitable buildings. See [Figure 6](#) for an indication of some Class 10 building configurations.

Figure 6: Examples of Class 10 buildings and structures

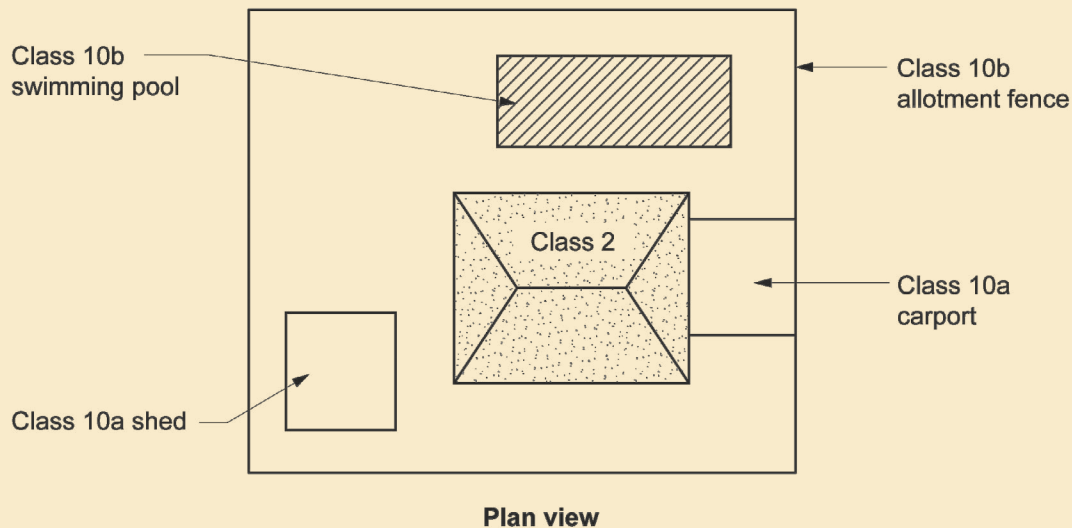

Class 10b structures are non-habitable structures. There is no requirement for Class 10 buildings to be appurtenant to a building of any other Class, for example, a small shed standing on its own on an allotment and a toilet block in a park.

A habitable 'outbuilding' which is appurtenant to another building is generally part of that building. Again, habitable 'outbuildings' cannot be classified as Class 10 buildings.

Typical outbuilding classifications include the following:

- A sleepout on the same allotment as a Class 1 building is part of the Class 1 building.
- A detached entertainment room on the same allotment as a Class 1 building, perhaps associated with a [swimming pool](#), is part of the Class 1 building.
- A small toolshed, used for trade-related hobbies for non-commercial purposes or home repairs, on the same allotment as a Class 1 building, would be classified as a Class 10 building.

Provisions relating to Class 10c structures are only intended to address [private bushfire shelters](#) associated with a single Class 1a dwelling. These provisions are contained in Volume Two of the NCC.

Some States or Territories may exempt some Class 10 buildings or structures (often on the basis of height or size) from the need to have a building permit. Queries on this matter should be referred to the State or Territory body responsible for regulatory matters.

Difficult classifications

Class 2 or Class 3?

There is a fine line between a Class 2 building containing apartments or flats and a Class 3 motel building with units containing bathroom, laundry and cooking facilities, which may both be made available for short term holiday rental. When does a Class 3 motel unit become a Class 2 holiday flat and vice versa?

In general, an assessment will be based on the most likely use of the building by [appropriate authorities](#).

Class 3 buildings, where the occupants are generally unfamiliar with the building and have minimum control over the safety of the building, represent a higher risk level and therefore require higher safety levels. In a case where the classification is unclear, a decision should be made according to the perceived risks inherent in the use of the building.

Class 6 or Class 7?

Governing Requirements

Class 7 buildings include those used to sell goods on the wholesale market, whereas Class 6 buildings are used to sell goods to the public.

Some establishments claim to sell goods to both the wholesale and retail markets. As a rule, however, if the general public has access to the building, it is considered a 'shop', and therefore a Class 6 building.

Hotel bars – Class 6 or 9b

As can be seen from the definition of a Class 6 building, it includes a hotel bar which is not an *assembly building*. The bar includes the bar area and associated standing and seating areas. This clarifies that the bar extends beyond the serving area to include standing and sitting areas where patrons may drink alcohol or other beverages and consume food. The exclusion of an *assembly building* means that a bar providing live entertainment or containing a dance floor is not considered to be Class 6, it must be considered as Class 9b. However, when that use is minor compared with the remainder of the bar, such as a piano bar or the like where patrons only listen to music and there is no dance floor, the *appropriate authority* should exercise judgement on the predominant use and therefore the appropriate classification of the bar.

A Class 9b building is an *assembly building* which is defined to include a building where people may assemble for entertainment, recreational or sporting purposes.

A building may have more than one classification (see A6.11).

Buildings used for farming purposes

Buildings used for *farming*-type purposes are often very diverse in nature, occupancy, use and size. In some States or Territories, *appropriate authorities* may classify *farm buildings* as Class 10a, which covers non-habitable buildings. They would only make this decision if a classification of Class 7 or Class 8 would not be more appropriate.

When making their decision they consider the building's size, purpose, operations and the extent to which people are employed in the building. For example, it may be appropriate to classify a shed which is used to store a tractor as a Class 10a building.

The NCC has definitions of "*farm building*" and "*farm shed*" which are certain Class 7 and 8 buildings used for *farming* purposes. Concessions to specific *Deemed-to-Satisfy Provisions* apply to *farm buildings* and *farm sheds* in recognition of their often low risk features, and it is recommended that reference is made to the definitions of "*farm building*" and "*farm shed*" for further guidance which may assist determination of an appropriate NCC classification.

For example, if people are likely to be employed to stack materials/produce in a storage building or remove materials/produce from a storage building then a classification of Class 7b may be appropriate. Depending upon whether the criteria in the definition of *farm shed* or *farm building* have been met, the associated *Deemed-to-Satisfy Provisions* in NCC Volume One Part H3 may apply.

Similarly if people are likely to be employed to pack or process materials/produce within a building, or employed to feed, clean or collect produce from animals or plants within a building then a classification of Class 8 may be appropriate. Depending upon whether the criteria in the definition of *farm shed* or *farm building* have been met, the associated *Deemed-to-Satisfy Provisions* in NCC Volume One Part H3 may apply.

However identification of low *fire load*, low occupant risk and low risk of fire spread should not be used as justification for choosing a less stringent building classification for a building under the *Deemed-to-Satisfy Provisions*. For example, if the intended use of a building is to grow or store a large amount of tomatoes, such as a large greenhouse, and there is likely to be only one to two persons in the building at any time, it is considered inappropriate to classify the building as a Class 10a under the *Deemed-to-Satisfy Provisions* and a classification of Class 7 or Class 8 would be more appropriate.

The *Deemed-to-Satisfy Provisions* for a Class 7 or Class 8 *farm building* or *farm shed* do not prevent the ability to consider or develop a *Performance Solution* for a particular building where the requirements may not be considered appropriate or are viewed as too stringent. Similarly if a Class 7 or 8 building used for *farming* purposes does not meet all the criteria to be considered a *farm building* or *farm shed* under the *Deemed-to-Satisfy Provisions*, this would not limit the ability to develop a *Performance Solution* which could contain features similar to those allowed under the *Deemed-to-Satisfy Provisions* for *farm buildings* or *farm sheds*.

For example, if a Class 8 commercial poultry building meets all the criteria to be considered a *farm building* under the *Deemed-to-Satisfy Provisions* other than the maximum *floor area* criteria, a *Performance Solution* could be developed to demonstrate that the concessions for a *farm building* under the *Deemed-to-Satisfy Provisions* are appropriate.

In regards to a *farm building* or *farm shed* where the purpose of the building is to park *farm vehicles* when not in use, as well as perhaps clean or polish the vehicle(s), it may be appropriate that this type of building is classified as a Class 7a.

However, a number of *farm buildings* and *farm sheds* are often not only used for the storage of *farm vehicles*, but to store supplies such as fuel, grain or hay. A Class 7a classification may still be appropriate where the majority of the shed's space is intended to be designated for the parking of vehicles. However, it may be more appropriate to classify

Governing Requirements

some types of buildings as Class 7b, rather than Class 7a where a mixed use shed is intended.

Under [A6.11](#) each part of a building (including the entire building) may have more than one classification. This means, for example, that it is permissible to classify part of a building as a Class 6/7 building, or a Class 5/6 building, or whatever is appropriate.

It is expected that this approach may be taken by a builder who is uncertain of what the precise use of a building will be after its sale, or to maximise the flexibility of the building's use.

Under [A6.11 Application 1](#) where a building has more than one classification the more stringent Class requirements will apply.

Part A7 United buildings

Introduction to this Part

This Part explains how multiple buildings can be considered as a united building. Where adjacent buildings are joined through openings in walls, they need not meet additional requirements if they jointly comply with the NCC as if a single building.

A7.0 United buildings

Buildings are deemed united when two or more buildings adjoining each other are connected and used as one building.

Application 1:

For A7.0, two or more buildings are a united building if they are connected through openings in the walls dividing them and together comply with all the requirements of the NCC as though they are a single building.

Application 2:

A7.0 only applies to Class 2 to 9 buildings.

A7.1 Alterations in a united building

If, after *alterations* or any other building work, two or more of the buildings in A7.0 cease to be connected through openings in the dividing walls, each of those buildings not now connected must comply with all the requirements for a single building.

Explanatory information:

It is not unusual for authorities to receive plans proposing the connecting of two or more buildings. Connecting buildings could be achieved by breaking openings through walls, or by joining the buildings by a tunnel, bridge or covered walkway.

When connected, if the buildings jointly comply with all the requirements of the NCC applying as if they were a single building, they become a united building.

United buildings are not required to comply with additional NCC provisions. For example, any new openings do not require any form of fire protection not required of a single building.

Note, however, an *external wall*, which as a result of an interconnection becomes an *internal wall*, must comply with the requirements for an *internal wall*.

Interconnected buildings that do not jointly comply with all the requirements applicable to a single building, remain as separate buildings.

This raises the possible need for fire doors, or other forms of protection to be fitted to connecting openings.

Multiple allotments or ownership

The NCC does not concern itself with actually prohibiting or permitting the uniting of buildings in separate ownership or on separate allotments. Such matters are dealt with by the relevant local bodies.

Example of connection by bridge

In this example, Building A is connected to Building B by bridge C. There are four different options for designing such a proposal.

The first is a united building

A, B and C are considered as a single structure and comply with the NCC.

The second is three separate buildings

A, B and C are a fire-source feature to each of the others, and are separated by fire walls with the openings protected at the points of connection. In this case, C may require independent support and separate egress to a road or open space, that is not through Buildings A or B. In this case, attention should also be paid to the length of the bridge, as regards distance of travel to an exit.

The third option is the bridge as a portion of Building A

In this option, A and C are one building, meeting all requirements of the NCC as a single or united building. B is a separate building, with suitable fire separation, including fire-doors at the point of interconnection. Bridge C could be supported off Building A, but not off Building B.

Governing Requirements

The fourth option is having the bridge as a portion of Building B

In this option, B and C are one building, meeting all requirements of the NCC as a single or united building. A is a separate building, with suitable fire separation, including fire doors at the point of interconnection. Bridge C could be supported off Building B, but not off Building A.

In some cases, C will link A and B across a public road, including laneways and the like. Special approvals may be required from various *appropriate authorities*. However, in such cases—

- if C is supported by means other than off A and B, such support will generally only be permitted if there is no obstruction of the public road; and
- care will need to be taken in calculating the distance of travel to an exit if travel is required to be over C and the road is wide; and
- fire-separation may be necessary at each end of the bridge.

If the last stipulation is the case, the following matters need consideration:

- The bridge would probably need to be of fire-rated construction because *combustible* construction could provide a ready path for the transfer of fire, and *non-combustible* construction could, in a major fire, distort and collapse onto the road.
- The designer needs to take care that the bridge does not negate the fire separation between the *storeys* of the building.

Structure

Part B1 Structural provisions

Section B Structure

Part B1 Structural provisions

Performance Requirements

BP1.1 Structural reliability

BP1.2 Structural resistance

BP1.3 Glass installations at risk of human impact

BP1.4 Buildings in flood areas

Verification Methods

BV1 Structural reliability

BV2 Structural robustness

B1.0 Deemed-to-Satisfy Provisions

B1.1 Resistance to actions

B1.2 Determination of individual actions

B1.3 * * * * *

B1.4 Determination of structural resistance of materials and forms of construction

B1.5 Structural software

B1.6 Construction of buildings in flood hazard areas

Specification B1.2 Design of buildings in cyclonic areas

1. Scope

2. Roof Cladding

Part B1 Structural provisions

Performance Requirements

BP1.1 Structural reliability

- (a) A building or structure, during construction and use, with appropriate degrees of reliability, must—
- (i) perform adequately under all reasonably expected design actions; and
 - (ii) withstand extreme or frequently repeated design actions; and
 - (iii) be designed to sustain local damage, with the structural system as a whole remaining stable and not being damaged to an extent disproportionate to the original local damage; and
 - (iv) avoid causing damage to *other properties*, by resisting the actions to which it may reasonably expect to be subjected.
- (b) The actions to be considered to satisfy (a) include but are not limited to—
- (i) permanent actions (dead loads); and
 - (ii) imposed actions (live loads arising from occupancy and use); and
 - (iii) wind action; and
 - (iv) earthquake action; and
 - (v) snow action; and
 - (vi) liquid pressure action; and
 - (vii) ground water action; and
 - (viii) rainwater action (including ponding action); and
 - (ix) earth pressure action; and
 - (x) differential movement; and
 - (xi) time dependent effects (including creep and shrinkage); and
 - (xii) thermal effects; and
 - (xiii) ground movement caused by—
 - (A) swelling, shrinkage or freezing of the subsoil; and
 - (B) landslip or subsidence; and
 - (C) siteworks associated with the building or structure; and
 - (xiv) *construction activity actions*; and
 - (xv) termite actions.

BP1.2 Structural resistance

The structural resistance of materials and forms of construction must be determined using five percentile characteristic material properties with appropriate allowance for—

- (a) known construction activities; and
- (b) type of material; and
- (c) characteristics of the site; and
- (d) the degree of accuracy inherent in the methods used to assess the structural behaviour; and
- (e) action effects arising from the differential settlement of foundations, and from restrained dimensional changes due to temperature, moisture, shrinkage, creep and similar effects.

BP1.3 Glass installations at risk of human impact

Glass installations that are at risk of being subjected to human impact must have glazing that—

- (a) if broken on impact, will break in a way that is not likely to cause injury to people; and
- (b) resists a reasonably foreseeable human impact without breaking; and
- (c) is protected or marked in a way that will reduce the likelihood of human impact.

BP1.4 Buildings in flood areas

Qld BP1.4

SA BP1.4

- (a) A building in a *flood hazard area*, must be designed and constructed, to the degree necessary, to resist flotation, collapse or significant permanent movement resulting from the action of hydrostatic, hydrodynamic, erosion and scour, wind and other actions during the *defined flood event*.
- (b) The actions and requirements to be considered to satisfy (a) include but are not limited to—
 - (i) flood actions; and
 - (ii) elevation requirements; and
 - (iii) foundation and footing requirements; and
 - (iv) requirements for enclosures below the *flood hazard level*; and
 - (v) requirements for structural connections; and
 - (vi) material requirements; and
 - (vii) requirements for utilities; and
 - (viii) requirements for occupant egress.

Application:

BP1.4 only applies to—

- (a) a Class 2 or 3 building or Class 4 part of a building; and
- (b) a Class 9a *health-care building*; and
- (c) a Class 9c building.

Verification Methods

BV1 Structural reliability

- (a) This *Verification Method* is applicable to components with a resistance coefficient of variation of at least 10% and not more than 40%. For components with a calculated value less than 10%, then a minimum value of 10% must be used.
- (b) Compliance with BP1.1 and BP1.2 is verified for the design of a structural component for strength when—
 - (i) the capacity reduction factor ϕ satisfies—

$$\phi \leq \text{Average}(\phi_G, \phi_Q, \phi_W, \dots),$$
 where—

$\phi_G, \phi_Q, \phi_W, \dots$ are capacity reduction factors for all relevant actions and must contain at least permanent (G), imposed (Q) and wind (W) actions; and
 - (ii) the capacity reduction factors $\phi_G, \phi_Q, \phi_W, \dots$ are calculated for target reliability indices for permanent action β_{TG} , for imposed action β_{TQ} , for wind action β_{TW} , ... in accordance with [Equation 1](#)—

Equation 1

$$\beta = \ln \left[\left(\frac{\bar{R}}{\bar{S}} \right) \sqrt{\frac{C_S}{C_R}} \right] / \sqrt{\ln(C_R \cdot C_S)}$$

where—

$$\left(\frac{\bar{R}}{\bar{S}} \right) = \frac{\left(\frac{\gamma}{\phi} \right) \left(\frac{\bar{R}}{R_N} \right)}{\left(\frac{\bar{S}}{S_N} \right)}$$

$$C_R = 1 + V_R^2$$

$$C_S = 1 + V_S^2$$

where—

$$\frac{\bar{R}}{R_N} = \text{ratio of mean resistance to nominal; and}$$

$$\frac{\bar{S}}{S_N} = \text{ratio of mean action to nominal; and}$$

C_S = correction factor for action; and

C_R = correction factor for resistance; and

V_S = coefficient of variation of the appropriate action as given in [Table BV1.1](#); and

V_R = coefficient of variation of the resistance; and

γ = appropriate load factor for the action as given in AS/NZS 1170.0; and

ϕ = capacity factor for the appropriate action; and

Structure

Table BV1.1 Annual action models

Design Action	Ratio of mean action to nominal	Coefficient of variation of the action
Permanent Action ($Y_G = 1.35$)	$(\bar{G}/G_N) = 1.00$	$V_G = 0.10$
Imposed Action ($Y_Q = 1.50$)	$(\bar{Q}/Q_N) = 0.50$	$V_Q = 0.43$
Wind Action ($Y_W = 1.00$)(Non-cyclonic)	$(\bar{W}/W_N) = 0.33$	$V_W = 0.49$
Wind Action ($Y_W = 1.00$)(Cyclonic)	$(\bar{W}/W_N) = 0.16$	$V_W = 0.71$
Snow Action ($Y_S = 1.00$)	$(\bar{S}/S_N) = 0.29$	$V_S = 0.57$
Earthquake Action ($Y_E = 1.00$)	$(\bar{E}/E_N) = 0.05$	$V_E = 1.98$

(iii) the annual target reliability indices β_{TG} , β_{TQ} , β_{TW} ,... are established as follows:

- (A) For situations where it is appropriate to compare with an equivalent Deemed-to-Satisfy product, a resistance model must be established for the equivalent Deemed-to-Satisfy product and β_{TG} , β_{TQ} , β_{TW} must be calculated for the equivalent Deemed-to-Satisfy product in accordance with Equation 1. The target reliability indices β_{TG} , β_{TQ} , β_{TW} ,...thus established, must not be less than those given in Table BV1.2 minus 0.5.
- (B) For situations where it is not appropriate to compare with an equivalent Deemed-to-Satisfy product, the target reliability index β must be as given in Table BV1.2.

Table BV1.2 Annual target reliability indices

Type of action	Target reliability index β
Permanent action	4.3
Imposed action	4.0
Wind, snow and earthquake action	3.7

Application of Table BV1.2:

- Table BV1.2 is applicable for components that exhibit brittle failure similar to concrete as specified in AS 3600.
- For components with creep characteristics similar to timber as specified in AS 1720.1, the target reliability index for permanent action must be increased to 5.0.
- The above target reliability indices are based on materials or systems that exhibit creep or brittle failure characteristics similar to timber and concrete. Table BV1.2 may also be applicable to materials or systems that exhibit creep or brittle failure differently to steel, timber or concrete provided that the creep or brittle nature of the material or system are properly accounted for in the design model.
- The above target reliability indices are also applicable for materials or systems that exhibit ductile failure characteristics.

(c) The resistance model for the component must be established by taking into account variability due to material properties, fabrication and construction process and structural modelling.

BV2 Structural robustness

Compliance with BP1.1(a)(iii) is verified for structural robustness by—

- (a) assessment of the structure such that upon the notional removal in isolation of—
- any supporting column; or
 - any beam supporting one or more columns; or
 - any segment of a load bearing wall of length equal to the height of the wall, the building remains stable and the resulting collapse does not extend further than the immediately adjacent *storeys*; and
- (b) demonstrating that if a supporting structural component is relied upon to carry more than 25% of the total structure a systematic risk assessment of the building is undertaken and critical high risk components are identified and

Structure

designed to cope with the identified hazard or protective measures chosen to minimise the risk.

Part B1 Structural provisions

Deemed-to-Satisfy Provisions

B1.0 Deemed-to-Satisfy Provisions

- (a) Where a *Deemed-to-Satisfy Solution* is proposed, *Performance Requirements* BP1.1 to BP1.4 are satisfied by complying with B1.1, B1.2, B1.4, B1.5 and B1.6.
- (b) Where a *Performance Solution* is proposed, the relevant *Performance Requirements* must be determined in accordance with A2.2(3) and A2.4(3) as applicable.

B1.1 Resistance to actions

The resistance of a building or structure must be greater than the most critical action effect resulting from different combinations of actions, where—

- (a) the most critical action effect on a building or structure is determined in accordance with B1.2 and the general design procedures contained in AS/NZS 1170.0; and
- (b) the resistance of a building or structure is determined in accordance with B1.4.

B1.2 Determination of individual actions

The magnitude of individual actions must be determined in accordance with the following:

- (a) Permanent actions:
 - (i) the design or known dimensions of the building or structure; and
 - (ii) the unit weight of the construction; and
 - (iii) AS/NZS 1170.1.
- (b) Imposed actions:
 - (i) the known loads that will be imposed during the occupation or use of the building or structure; and
 - (ii) *construction activity actions*; and
 - (iii) AS/NZS 1170.1.
- (c) Wind, snow and ice and earthquake actions:
 - (i) the applicable annual probability of design event for safety, determined by—
 - (A) assigning the building or structure an Importance Level in accordance with Table B1.2a; and
 - (B) determining the corresponding annual probability of exceedance in accordance with Table B1.2b; and
 - (ii) AS/NZS 1170.2; and
 - (iii) AS/NZS 1170.3 and AS 1170.4 as appropriate; and
 - (iv) in cyclonic areas, metal roof cladding, its connections and immediate supporting members must comply with Specification B1.2; and
 - (v) for the purposes of (iv), cyclonic areas are those determined as being located in wind regions C and D in accordance with AS/NZS 1170.2.
- (d) Actions not covered in (a), (b) and (c) above:
 - (i) the nature of the action; and
 - (ii) the nature of the building or structure; and
 - (iii) the Importance Level of the building or structure determined in accordance with Table B1.2a; and
 - (iv) AS/NZS 1170.1.
- (e) For the purposes of (d) the actions include but are not limited to—

Structure

Deemed-to-Satisfy Provisions

- (i) liquid pressure action; and
- (ii) ground water action; and
- (iii) rainwater action (including ponding action); and
- (iv) earth pressure action; and
- (v) differential movement; and
- (vi) time dependent effects (including creep and shrinkage); and
- (vii) thermal effects; and
- (viii) ground movement caused by—
 - (A) swelling, shrinkage or freezing of the subsoil; and
 - (B) landslip or subsidence; and
 - (C) *siteworks* associated with the building or structure; and
- (ix) *construction activity actions*.

Table B1.2a Importance Levels of buildings and structures

Importance Level	Building Types
1	Buildings or structures presenting a low degree of hazard to life and <i>other property</i> in the case of failure.
2	Buildings or structures not included in Importance Levels 1, 3 and 4.
3	Buildings or structures that are designed to contain a large number of people.
4	Buildings or structures that are essential to post-disaster recovery or associated with hazardous facilities.

Table B1.2b Design events for safety

Importance Level	Annual probability of exceedance for non-cyclonic wind	Annual probability of exceedance for cyclonic wind	Annual probability of exceedance for snow	Annual probability of exceedance for earthquake
1	1:100	1:200	1:100	1:250
2	1:500	1:500	1:150	1:500
3	1:1000	1:1000	1:200	1:1000
4	1:2000	1:2000	1:250	1:1500

B1.3 * * * * *

This clause has deliberately been left blank.

B1.4 Determination of structural resistance of materials and forms of construction

The structural resistance of materials and forms of construction must be determined in accordance with the following, as appropriate:

- (a) Masonry (including masonry-veneer, unreinforced masonry and reinforced masonry): AS 3700, except—
 - (i) ‘(for piers—isolated or engaged)’ is removed from Clause 8.5.1(d); and
 - (ii) where Clause 8.5.1 requires design as for unreinforced masonry in accordance with Section 7, the member must also be designed as unreinforced masonry in accordance with Tables 10.3 and 4.1(a)(i)(C) of AS 3700.
- (b) Concrete:
 - (i) Concrete construction (including reinforced and prestressed concrete): AS 3600.
 - (ii) Autoclaved aerated concrete: AS 5146.1.

Structure

Deemed-to-Satisfy Provisions

- (iii) Post-installed and cast-in fastenings: AS 5216.
- (c) Steel construction:
 - (i) Steel structures: AS 4100.
 - (ii) Cold-formed steel structures: AS/NZS 4600.
 - (iii) Residential and low-rise steel framing: NASH Standard – Residential and Low-Rise Steel Framing Part 1 or Part 2.
- (d) Composite steel and concrete: AS/NZS 2327.
- (e) Aluminium construction: AS/NZS 1664.1 or AS/NZS 1664.2.
- (f) Timber construction:
 - (i) Design of timber structures: AS 1720.1.
 - (ii) * * * * *
 - (iii) Timber structures: AS 1684.2, AS 1684.3 or AS 1684.4.
 - (iv) Nailplated timber roof trusses: AS 1720.5.

Qld B1.4(f)(v)

- (g) Piling: AS 2159.
- (h) Glazed assemblies:
 - (i) The following glazed assemblies in an *external wall* must comply with AS 2047:
 - (A) Windows excluding those listed in (ii).
 - (B) Sliding and swinging glazed doors with a frame, including french and bi-fold doors with a frame.
 - (C) Adjustable louvres.
 - (D) Shopfronts.
 - (E) Window walls with one piece framing.
 - (ii) All glazed assemblies not covered by (i) and the following glazed assemblies must comply with AS 1288:
 - (A) All glazed assemblies not in an *external wall*.
 - (B) Revolving doors.
 - (C) Fixed louvres.
 - (D) Skylights, roof lights and windows in other than the vertical plane.
 - (E) Sliding and swinging doors without a frame.
 - (F) Windows constructed on site and architectural one-off windows, which are not design tested in accordance with AS 2047.
 - (G) Second-hand windows, re-used windows and recycled windows.
 - (H) Heritage windows.
 - (I) Glazing used in balustrades and sloping overhead glazing.

NT B1.4(i)

- (i) Termite Risk Management: Where a *primary building element* is subject to attack by subterranean termites: AS 3660.1, and—
 - (i) for the purposes of this provision, a *primary building element* consisting entirely of, or a combination of, any of the following materials is considered not subject to termite attack:
 - (A) Steel, aluminium or other metals.
 - (B) Concrete.
 - (C) Masonry.

Structure

Deemed-to-Satisfy Provisions

- (D) Fibre-reinforced cement.
- (E) Timber — naturally termite resistant in accordance with Appendix C of AS 3660.1.
- (F) Timber — preservative treated in accordance with Appendix D of AS 3660.1; and
- (ii) a durable notice must be permanently fixed to the building in a prominent location, such as a meter box or the like, indicating—
 - (A) the termite management system used; and
 - (B) the date of installation of the system; and
 - (C) where a chemical is used, its life expectancy as listed on the *appropriate authority's* pesticides register label; and
 - (D) the installer's or manufacturer's recommendations for the scope and frequency of future inspections for termite activity.
- (j) Roof construction (except in cyclonic areas):
 - (i) Terracotta, fibre-cement and timber slates and shingles: AS 4597.
 - (ii) Roof tiling: AS 2050.
 - (iii) Cellulose cement corrugated sheets: AS/NZS 2908.1 with safety mesh installed in accordance with AS/NZS 1562.3 clause 2.4.3.2 except for sub-clause (g) for plastic sheeting.
 - (iv) Metal roofing: AS 1562.1.
- (k) Particleboard structural flooring: AS 1860.2.
- (l) Garage doors and other large access doors in openings not more than 3 m in height in *external walls* of buildings determined as being located in wind region C or D in accordance with AS/NZS 1170.2: AS/NZS 4505.
- (m) Lift *shafts* which are not *required* to have an FRL, must—
 - (i) except as required by (ii), be completely enclosed with non-perforated material between the bottom of the pit and the ceiling of the lift *shaft*, other than—
 - (A) at landing doors, emergency doors and pit access doors; and
 - (B) *low-rise, low-speed constant pressure lifts*; and
 - (C) *small-sized, low-speed automatic lifts*; and
 - (ii) in *atrium* and observation areas, be protected with non-perforated material not less than 2.5 m in height—
 - (A) above any places on which a person can stand, which are within 800 mm horizontal reach of any vertical moving lift component including ropes and counterweights; and
 - (B) at the lowest level of the *atrium* area that the lift serves, on all sides except the door opening, for not less than 2.5 m in height, by enclosure with non-perforated material; and
 - (iii) be of non-brittle material; and
 - (iv) where glazing is used—
 - (A) comply with [Table B1.4](#); or
 - (B) not fail the deflection criteria *required* by [Clause 6\(c\)\(iii\) of Specification C1.8](#).

Table B1.4 Material and minimum thickness of glazing and polycarbonate sheet

Application	Lift <i>shaft</i> vision panels more than 65 000 mm ² , door panels, and lift <i>shafts</i>	Lift <i>shaft</i> vision panels less than or equal to 65 000 mm ²
Laminated glass	10 mm (0.76 mm interlayer)	6 mm (0.76 mm interlayer)
Toughened/laminated glass	10 mm (0.76 mm interlayer)	6 mm (0.76 mm interlayer)
Annealed glass with security polyester film coating	10 mm	6 mm
Safety wire glass	Not applicable	Subject to fire test

Structure

Deemed-to-Satisfy Provisions

Application	Lift <i>shaft</i> vision panels more than 65 000 mm ² , door panels, and lift <i>shafts</i>	Lift <i>shaft</i> vision panels less than or equal to 65 000 mm ²
Polycarbonate sheet	13 mm	6 mm

B1.5 Structural software

- (a) Structural software used in computer aided design of a building or structure, that uses design criteria based on the *Deemed-to-Satisfy Provisions* of the BCA, including its referenced documents, for the design of steel or timber trussed roof and floor systems and framed building systems, must comply with the ABCB Protocol for Structural Software.
- (b) Structural software referred to in (a) can only be used for buildings within the following geometrical limits:
- (i) The distance from ground level to the underside of eaves must not exceed 6 m.
 - (ii) The distance from ground level to the highest point of the roof, neglecting chimneys, must not exceed 8.5 m.
 - (iii) The building width including roofed verandahs, excluding eaves, must not exceed 16 m.
 - (iv) The building length must not exceed five times the building width.
 - (v) The roof pitch must not exceed 35 degrees.
- (c) The requirements of (a) do not apply to design software for individual frame members such as electronic tables similar to those provided in—
- (i) AS 1684; or
 - (ii) NASH Standard Residential and Low-Rise Steel Framing Part 2.

B1.6 Construction of buildings in flood hazard areas

Qld B1.6

Vic B1.6

SA B1.6

A Class 2 or 3 building, Class 9a *health-care building*, Class 9c building or Class 4 part of a building, in a *flood hazard area* must comply with the ABCB Standard for Construction of Buildings in Flood Hazard Areas.

Specification B1.2

Design of buildings in cyclonic areas

Deemed-to-Satisfy Provisions

1. Scope

This specification contains requirements for the design of buildings in cyclonic areas in addition to the requirements of AS/NZS 1170.2.

For the purposes of [Specification B1.2](#), cyclonic areas are those determined as being located in wind regions C and D in accordance with AS/NZS 1170.2.

2. Roof Cladding

Test for strength - Metal roof cladding, its connections and immediate supporting members must be capable of remaining in position notwithstanding any permanent distortion, fracture or damage that might occur in the sheet or fastenings under the pressure sequences A to G defined in [Table 1](#).

Table 1 Low-high-low pressure sequence

Sequence	Number of cycles	Load
A	4500	0 to 0.45 Pt
B	600	0 to 0.6 Pt
C	80	0 to 0.8 Pt
D	1	0 to 1.0 Pt
E	80	0 to 0.8 Pt
F	600	0 to 0.6 Pt
G	4500	0 to 0.45 Pt

Notes to Table 1:

1. Pt is the ultimate limit state wind pressure on internal and external surfaces as determined in accordance with AS/NZS 1170.2, modified by an appropriate factor for variability, as determined in accordance with Table B1 of AS/NZS 1170.0.
2. The rate of load cycling must be less than 3 Hz.
3. The single load cycle (sequence D) must be held for a minimum of 10 seconds.

NT Specification B1.2 Clause NT3 — NT4.

Fire resistance

Section C	Fire resistance
Part C1	Fire resistance and stability
Part C2	Compartmentation and separation
Part C3	Protection of openings

Section C Fire resistance

Section C Fire resistance

Performance Requirements

- CP1 Structural stability during a fire
- CP2 Spread of fire
- CP3 Spread of fire and smoke in health and residential care buildings
- CP4 Safe conditions for evacuation
- CP5 Behaviour of concrete external walls in a fire
- CP6 Fire protection of service equipment
- CP7 Fire protection of emergency equipment
- CP8 Fire protection of openings and penetrations
- CP9 Fire brigade access

Verification Methods

- CV1 Fire spread between buildings on adjoining allotments
- CV2 Fire spread between buildings on the same allotment
- CV3 Fire spread via external walls
- CV4 Fire Safety Verification Method

Part C1 Fire resistance and stability

- C1.0 Deemed-to-Satisfy Provisions
- C1.1 Type of construction required
- C1.2 Calculation of rise in storeys
- C1.3 Buildings of multiple classification
- C1.4 Mixed types of construction
- C1.5 Two storey Class 2, 3 or 9c buildings
- C1.6 Class 4 parts of buildings
- C1.7 Open spectator stands and indoor sports stadiums
- C1.8 Lightweight construction
- C1.9 Non-combustible building elements
- C1.10 Fire hazard properties
- C1.11 Performance of external walls in fire
- C1.12 * * * * *
- C1.13 Fire-protected timber: Concession
- C1.14 Ancillary elements

Part C2 Compartmentation and separation

- C2.0 Deemed-to-Satisfy Provisions
- C2.1 Application of Part
- C2.2 General floor area and volume limitations
- C2.3 Large isolated buildings
- C2.4 Requirements for open spaces and vehicular access
- C2.5 Class 9a and 9c buildings
- C2.6 Vertical separation of openings in external walls
- C2.7 Separation by fire walls
- C2.8 Separation of classifications in the same storey
- C2.9 Separation of classifications in different storeys
- C2.10 Separation of lift shafts
- C2.11 Stairways and lifts in one shaft
- C2.12 Separation of equipment
- C2.13 Electricity supply system
- C2.14 Public corridors in Class 2 and 3 buildings

Part C3 Protection of openings

C3.0 Deemed-to-Satisfy Provisions

C3.1 Application of Part

C3.2 Protection of openings in external walls

C3.3 Separation of external walls and associated openings in different fire compartments

C3.4 Acceptable methods of protection

C3.5 Doorways in fire walls

C3.6 Sliding fire doors

C3.7 Protection of doorways in horizontal exits

C3.8 Openings in fire-isolated exits

C3.9 Service penetrations in fire-isolated exits

C3.10 Openings in fire-isolated lift shafts

C3.11 Bounding construction: Class 2 and 3 buildings and Class 4 parts

C3.12 Openings in floors and ceilings for services

C3.13 Openings in shafts

C3.14 * * * * *

C3.15 Openings for service installations

C3.16 Construction joints

C3.17 Columns protected with lightweight construction to achieve an FRL

Specification C1.1 Fire-resisting construction

1. Scope
2. General Requirements
3. Type A Fire-Resisting Construction
4. Type B Fire-Resisting Construction
5. Type C Fire-Resisting Construction

Specification C1.8 Structural tests for lightweight construction

1. Scope
2. Application
3. Tests
4. Test specimens
5. Test methods
6. Criteria for compliance

Specification C1.10 Fire hazard properties

1. Scope
2. Application
3. Floor linings and floor coverings
4. Wall and ceiling linings
5. Air-handling ductwork
6. Lift cars
7. Other materials

Specification C1.11 Performance of external walls in fire

1. Scope
2. Application
3. General requirements for external wall panels
4. Additional requirements for vertically spanning external wall panels adjacent to columns

Specification C1.13 Cavity barriers for fire-protected timber

1. Scope
2. Requirements

Specification C1.13a Fire-protected timber

1. Scope
2. Requirements
 - 2.1 General requirements
 - 2.2 Massive timber
3. Determination of time the timber interface temperature exceeds 300°C for timber at least 75 mm thick
 - 3.1 Form of test
 - 3.2 Smaller specimen permitted
 - 3.3 Acceptance criteria

Specification C2.5 Smoke-proof walls in health-care and residential care buildings

1. Scope
2. Class 9a health-care buildings
3. Class 9c buildings
4. Doorways in smoke-proof walls

Specification C3.4 Fire doors, smoke doors, fire windows and shutters

1. Scope
2. Fire Doors
3. Smoke Doors
 - 3.1 General requirements
 - 3.2 Construction Deemed-to-Satisfy
4. Fire Shutters
5. Fire Windows

Specification C3.15 Penetration of walls, floors and ceilings by services

1. Scope
2. Application
3. Metal pipe systems
4. Pipes penetrating sanitary compartments
5. Wires and cables
6. Electrical switches and outlets
7. Fire-stopping

Section C Fire resistance

Performance Requirements

CP1 Structural stability during a fire

A building must have elements which will, to the degree necessary, maintain structural stability during a fire appropriate to—

- (a) the function or use of the building; and
- (b) the *fire load*; and
- (c) the potential *fire intensity*; and
- (d) the *fire hazard*; and
- (e) the height of the building; and
- (f) its proximity to *other property*; and
- (g) any active *fire safety systems* installed in the building; and
- (h) the size of any *fire compartment*; and
- (i) *fire brigade* intervention; and
- (j) other elements they support; and
- (k) the *evacuation time*.

CP2 Spread of fire

- (a) A building must have elements which will, to the degree necessary, avoid the spread of fire—
 - (i) to *exits*; and
 - (ii) to *sole-occupancy units* and *public corridors*; and

Application:

CP2(a)(ii) only applies to a Class 2 or 3 building or Class 4 part of a building.

- (iii) between buildings; and
- (iv) in a building.
- (b) Avoidance of the spread of fire referred to in (a) must be appropriate to—
 - (i) the function or use of the building; and
 - (ii) the *fire load*; and
 - (iii) the potential *fire intensity*; and
 - (iv) the *fire hazard*; and
 - (v) the number of *storeys* in the building; and
 - (vi) its proximity to *other property*; and
 - (vii) any active *fire safety systems* installed in the building; and
 - (viii) the size of any *fire compartment*; and
 - (ix) *fire brigade* intervention; and
 - (x) other elements they support; and
 - (xi) the *evacuation time*.

CP3 Spread of fire and smoke in health and residential care buildings

A building must be protected from the spread of fire and smoke to allow sufficient time for the orderly evacuation of the

Fire resistance

building in an emergency.

Application:

CP3 only applies to—

- (a) a *patient care area* of a Class 9a *health-care building*; and
- (b) a Class 9c building.

CP4 Safe conditions for evacuation

To maintain tenable conditions during occupant evacuation, a material and an assembly must, to the degree necessary, resist the spread of fire and limit the generation of smoke and heat, and any toxic gases likely to be produced, appropriate to—

- (a) the *evacuation time*; and
- (b) the number, mobility and other characteristics of occupants; and
- (c) the function or use of the building; and
- (d) any active *fire safety systems* installed in the building.

Application:

CP4 applies to linings, materials and assemblies in a Class 2 to 9 building.

CP5 Behaviour of concrete external walls in a fire

A concrete *external wall* that could collapse as a complete panel (e.g. tilt-up and pre-cast concrete) must be designed so that in the event of fire within the building the likelihood of outward collapse is avoided.

Limitation:

CP5 does not apply to a building having more than two *storeys* above ground level.

CP6 Fire protection of service equipment

A building must have elements, which will, to the degree necessary, avoid the spread of fire from service equipment having—

- (a) a high *fire hazard*; or
- (b) a potential for explosion resulting from a high *fire hazard*.

CP7 Fire protection of emergency equipment

A building must have elements, which will, to the degree necessary, avoid the spread of fire so that emergency equipment provided in a building will continue to operate for a period of time necessary to ensure that the intended function of the equipment is maintained during a fire.

CP8 Fire protection of openings and penetrations

Any building element provided to resist the spread of fire must be protected, to the degree necessary, so that an adequate level of performance is maintained—

- (a) where openings, construction joints and the like occur; and
- (b) where penetrations occur for building services.

CP9 Fire brigade access

Access must be provided to and around a building, to the degree necessary, for *fire brigade* vehicles and personnel to facilitate *fire brigade* intervention appropriate to—

- (a) the function or use of the building; and
- (b) the *fire load*; and
- (c) the potential *fire intensity*; and

Fire resistance

- (d) the *fire hazard*; and
- (e) any active *fire safety systems* installed in the building; and
- (f) the size of any *fire compartment*.

Verification Methods

CV1 Fire spread between buildings on adjoining allotments

Compliance with CP2(a)(iii) to avoid the spread of fire between buildings on adjoining allotments is verified when it is calculated that—

- (a) a building will not cause heat flux in excess of those set out in Column 2 of Table CV1 at the location on an adjoining property set out in Column 1 of Table CV1; and
- (b) when located at the distances from the allotment boundary set out in Column 1 of Table CV1, a building is capable of withstanding the heat flux set out in Column 2 of Table CV1 without ignition.

Table CV1

Column 1	Column 2
Location	Heat flux (kW/m ²)
On boundary	80
1 m from boundary	40
3 m from boundary	20
6 m from boundary	10

CV2 Fire spread between buildings on the same allotment

Compliance with CP2(a)(iii) to avoid the spread of fire between buildings on the same allotment is verified when it is calculated that a building—

- (a) is capable of withstanding the heat flux set out in Column 2 of Table CV2 without ignition; and
- (b) will not cause heat flux in excess of those set out in Column 2 of Table CV2, when the distance between the buildings is as set out in Column 1 of Table CV2.

Table CV2

Column 1	Column 2
Distance between buildings on the same allotment (m)	Heat flux (kW/m ²)
0	80
2	40
6	20
12	10

CV3 Fire spread via external walls

Compliance with CP2 to avoid the spread of fire via the *external wall* of a building is verified when—

- (a) compliance with CP2(a)(iii) to avoid the spread of fire between buildings, where applicable, is verified in accordance with CV1 or CV2, as appropriate; and
- (b) the *external wall* system—
 - (i) has been tested for external wall (EW) performance in accordance with AS 5113; and
 - (ii) has achieved the classification EW; and
 - (iii) if containing a cavity, incorporates cavity barriers and these cavity barriers have been included in the test performed under (i) at the perimeter of each floor; and
- (c) in a building of Type A construction, the building is protected throughout by a sprinkler system (other than a

Fire resistance

FPAA101D or FPAA101H system) complying with [Specification E1.5](#) and has—

- (i) sprinkler protection to balconies, patios and terraces, and where overhead sprinkler coverage is not achieved alongside the *external wall*, sidewall sprinkler heads are provided at the *external wall* for the extent of the balcony, patio or terrace where overhead sprinkler coverage is not achieved; and
- (ii) for a building with an *effective height* greater than 25 m—
 - (A) monitored stop valves provided at each floor level arranged to allow the isolation of the floor level containing the stop valve while maintaining protection to the remainder of the building; and
 - (B) the sprinkler system being capable of providing sufficient flow to serve the design area required by AS 2118.1 for the relevant hazard class on each floor level plus the design area required by AS 2118.1 for the floor level above, except where the former level is—
 - (aa) the floor level below the uppermost roof; or
 - (bb) any floor level that is wholly below ground; and
- (d) in a building of Type B construction, the building is—
 - (i) a Class 5, 6, 7 or 8 building or Class 4 part of a building; or
 - (ii) a Class 2, 3 or 9 building that—
 - (A) is protected throughout by a sprinkler system (other than a FPAA101D or FPAA101H system) complying with [Specification E1.5](#); or
 - (B) has any openings in *external walls* separated by a slab or other horizontal construction complying with [C2.6\(a\)\(iv\)](#) as if the building were of Type A construction.

CV4 Fire Safety Verification Method

Compliance with [CP1](#), [CP2](#), [CP3](#), [CP4](#), [CP5](#), [CP6](#), [CP7](#), [CP8](#) and [CP9](#) is verified when a building is designed in accordance with [Schedule 7](#).

Part C1 Fire resistance and stability

Deemed-to-Satisfy Provisions

C1.0 Deemed-to-Satisfy Provisions

- (a) Where a *Deemed-to-Satisfy Solution* is proposed, *Performance Requirements CP1* to *CP9* are satisfied by complying with—
- (i) [C1.1](#) to [C1.14](#), [C2.1](#) to [C2.14](#) and [C3.1](#) to [C3.17](#); and
 - (ii) in a building containing an *atrium*, [Part G3](#); and
 - (iii) for a building containing an *occupiable outdoor area*, [Part G6](#); and
 - (iv) for additional requirement for Class 9b buildings, [Part H1](#); and
 - (v) for *farm sheds*, [Part H3](#).
- (b) Where a *Performance Solution* is proposed, the relevant *Performance Requirements* must be determined in accordance with [A2.2\(3\)](#) and [A2.4\(3\)](#) as applicable.

C1.1 Type of construction required

- (a) The minimum Type of *fire-resisting construction* of a building must be determined in accordance with [Table C1.1](#), except as allowed for—
- (i) certain Class 2, 3 or 9c buildings in [C1.5](#); and
 - (ii) a Class 4 part of a building located on the top *storey* in [C1.3\(b\)](#); and
 - (iii) *open spectator stands* and indoor sports stadiums in [C1.7](#).
- [SA C1.1\(a\)\(iv\)](#) and [\(v\)](#)
- (b) Each building element must comply with [Specification C1.1](#) as applicable.

Table C1.1 Type of construction required

Rise in storeys	Class of building	
	2, 3, 9	5, 6, 7, 8
4 or more	A	A
3	A	B
2	B	C
1	C	C

[SA C1.1\(c\)](#) and [\(d\)](#)

C1.2 Calculation of rise in storeys

- (a) The *rise in storeys* is the sum of the greatest number of *storeys* at any part of the *external walls* of the building and any *storeys* within the roof space—
- (i) above the finished ground next to that part; or
 - (ii) if part of the *external wall* is on the boundary of the allotment, above the natural ground level at the relevant part of the boundary.
- (b) A *storey* is not counted if—
- (i) it is situated at the top of the building and contains only heating, ventilating or lift equipment, water tanks, or similar service units or equipment; or
 - (ii) it is situated partly below the finished ground and the underside of the ceiling is not more than 1 m above the average finished level of the ground at the *external wall*, or if the *external wall* is more than 12 m long, the average for the 12 m part where the ground is lowest.

Fire resistance

Deemed-to-Satisfy Provisions

- (c) In a Class 7 or 8 building, a *storey* that has an average internal height of more than 6 m is counted as—
 - (i) one *storey* if it is the only *storey* above the ground; or
 - (ii) 2 *storeys* in any other case.
- (d) For the purposes of calculating the *rise in storeys* of a building—
 - (i) a *mezzanine* is regarded as a *storey* in that part of the building in which it is situated if its *floor area* is more than 200 m² or more than 1/3 of the *floor area* of the room, whichever is the lesser; and
 - (ii) two or more *mezzanines* are regarded as a *storey* in that part of the building in which they are situated if they are at or near the same level and have an aggregate *floor area* more than 200 m² or more than 1/3 of the *floor area* of the room, whichever is the lesser.

C1.3 Buildings of multiple classification

- (a) In a building of multiple classifications, the Type of construction *required* for the building is the most *fire-resisting* Type resulting from the application of [Table C1.1](#) on the basis that the classification applying to the top *storey* applies to all *storeys*.
- (b) In a building containing a Class 4 part on the top *storey*, for the purpose of (a), the classification applying to the top *storey* must be—
 - (i) when the Class 4 part occupies the whole of the top *storey*, the classification applicable to the next highest *storey*; or
 - (ii) when the Class 4 part occupies part of the top *storey*, the classification applicable to the adjacent part.

C1.4 Mixed types of construction

A building may be of mixed Types of construction where it is separated in accordance with [C2.7](#) and the Type of construction is determined in accordance with [C1.1](#) or [C1.3](#).

C1.5 Two storey Class 2, 3 or 9c buildings

A building having a *rise in storeys* of 2 may be of Type C construction if—

- (a) it is a Class 2 or 3 building or a mixture of these classes and each *sole-occupancy unit* has—
 - (i) access to at least 2 *exits*; or
 - (ii) its own direct access to a road or *open space*; or
- (b) it is a Class 9c building protected throughout with a sprinkler system (other than a FPAA101D or FPAA101H system) complying with [Specification E1.5](#) and complies with the maximum compartment size specified in [Table C2.2](#) for Type C construction.

C1.6 Class 4 parts of buildings

For the Type of construction *required* by [C1.3](#), a Class 4 part of a building requires the same FRL for building elements and the same construction separating the Class 4 part from the remainder of the building as a Class 2 part in the same Type of construction.

C1.7 Open spectator stands and indoor sports stadiums

- (a) An *open spectator stand* or indoor sports stadium may be of Type C construction and need not comply with the other provisions of this Part if it contains not more than 1 tier of seating, is of *non-combustible* construction, and has only changing rooms, sanitary facilities or the like below the tiered seating.
- (b) In (a), one tier of seating means numerous rows of tiered seating incorporating cross-overs but within one viewing level.

C1.8 Lightweight construction

- (a) *Lightweight construction* must comply with [Specification C1.8](#) if it is used in a wall system—
 - (i) that is *required* to have an FRL; or

Fire resistance

Deemed-to-Satisfy Provisions

- (ii) for a lift *shaft*, stair *shaft* or service *shaft* or an *external wall* bounding a *public corridor* including a non *fire-isolated passageway* or non *fire-isolated ramp*, in a spectator stand, sports stadium, cinema or theatre, railway station, bus station or airport terminal.
- (b) If *lightweight construction* is used for the *fire-resisting* covering of a steel column or the like, and if—
 - (i) the covering is not in continuous contact with the column, then the void must be filled solid, to a height of not less than 1.2 m above the floor to prevent indenting; and
 - (ii) the column is liable to be damaged from the movement of vehicles, materials or equipment, then the covering must be protected by steel or other suitable material.

C1.9 Non-combustible building elements

- (a) In a building *required* to be of Type A or B construction, the following building elements and their components must be *non-combustible*:
 - (i) *External walls* and *common walls*, including all components incorporated in them including the facade covering, framing and insulation.
 - (ii) The flooring and floor framing of lift pits.
 - (iii) Non-*loadbearing internal walls* where they are *required* to be *fire-resisting*.
- (b) A *shaft*, being a lift, ventilating, pipe, garbage, or similar *shaft* that is not for the discharge of hot products of combustion, that is non-*loadbearing*, must be of *non-combustible* construction in—
 - (i) a building *required* to be of Type A construction; and
 - (ii) a building *required* to be of Type B construction, subject to C2.10, in—
 - (A) a Class 2, 3 or 9 building; and
 - (B) a Class 5, 6, 7 or 8 building if the *shaft* connects more than 2 *storeys*.
- (c) A *loadbearing internal wall* and a *loadbearing fire wall*, including those that are part of a *loadbearing shaft*, must comply with Specification C1.1.
- (d) The requirements of (a) and (b) do not apply to the following:
 - (i) Gaskets.
 - (ii) Caulking.
 - (iii) Sealants.
 - (iv) Termite management systems.
 - (v) Glass, including laminated glass.
 - (vi) Thermal breaks associated with glazing systems.
 - (vii) Damp-proof courses.
- (e) The following materials may be used wherever a *non-combustible* material is *required*:
 - (i) Plasterboard.
 - (ii) Perforated gypsum lath with a normal paper finish.
 - (iii) Fibrous-plaster sheet.
 - (iv) Fibre-reinforced cement sheeting.
 - (v) Pre-finished metal sheeting having a *combustible* surface finish not exceeding 1 mm thickness and where the *Spread-of-Flame Index* of the product is not greater than 0.
 - (vi) *Sarking-type materials* that do not exceed 1 mm in thickness and have a *Flammability Index* not greater than 5.
 - (vii) Bonded laminated materials where—
 - (A) each lamina, including any core, is *non-combustible*; and
 - (B) each adhesive layer does not exceed 1 mm in thickness and the total thickness of the adhesive layers

Fire resistance

Deemed-to-Satisfy Provisions

does not exceed 2 mm; and

- (C) the *Spread-of-Flame Index* and the *Smoke-Developed Index* of the bonded laminated material as a whole do not exceed 0 and 3 respectively.

C1.10 Fire hazard properties

- (a) The *fire hazard properties* of the following internal linings, materials and assemblies within a Class 2 to 9 building must comply with [Specification C1.10](#):
- (i) Floor linings and floor coverings.
 - (ii) Wall linings and ceiling linings.
 - (iii) Air-handling ductwork.
 - (iv) Lift cars.
- [NSW C1.10\(a\)\(v\)](#)
- (v) In Class 9b buildings used as a theatre, public hall or the like—
- (A) fixed seating in the audience area or auditorium; and
 - (B) a proscenium curtain *required* by [Specification H1.3](#).
- (vi) Escalators, moving walkways and non-*required* non *fire-isolated stairways* or pedestrian ramps subject to [Specification D1.12](#).
- (vii) *Sarking-type materials*.
- (viii) Attachments to floors, ceilings, *internal walls*, *common walls*, *fire walls* and to internal linings of *external walls*.
- (ix) Other materials including insulation materials other than *sarking-type materials*.

[NSW C1.10\(b\)](#)

- (b) Paint or fire-retardant coatings must not be used to achieve compliance with the *required fire hazard properties*.
- (c) The requirements of (a) do not apply to a material or assembly if it is—
- (i) plaster, cement render, concrete, terrazzo, ceramic tile or the like; or
 - (ii) a *fire-protective covering*; or
 - (iii) a timber-framed *window*; or
 - (iv) a solid timber handrail or skirting; or
 - (v) a timber-faced door; or
 - (vi) an electrical switch, socket-outlet, cover plate or the like; or
 - (vii) a material used for—
 - (A) a roof insulating material applied in continuous contact with a substrate; or
 - (B) an adhesive; or
 - (C) a damp-proof course, flashing, caulking, sealing, ground moisture barrier, or the like; or
 - (viii) a paint, varnish, lacquer or similar finish, other than nitro-cellulose lacquer; or
 - (ix) a clear or translucent roof light of glass fibre-reinforced polyester if—
 - (A) the roof in which it is installed forms part of a single *storey* building *required* to be Type C construction; and
 - (B) the material is used as part of the roof covering; and
 - (C) it is not closer than 1.5 m from another roof light of the same type; and
 - (D) each roof light is not more than 14 m² in area; and
 - (E) the area of the roof lights per 70 m² of roof surface is not more than 14 m²; or
 - (x) a face plate or neck adaptor of supply and return air outlets of an air handling system; or

Fire resistance

Deemed-to-Satisfy Provisions

- (xi) a face plate or diffuser plate of light fitting and emergency *exit* signs and associated electrical wiring and electrical components; or
- (xii) a joinery unit, cupboard, shelving, or the like; or
NSW C1.10(c)(xiii)
- (xiii) an attached non-building fixture and fitting such as—
 - (A) a curtain, blind, or similar decor, other than a proscenium curtain *required* by *Specification H1.3*; and
 - (B) a whiteboard, *window* treatment or the like; or
- (xiv) timber treads, risers, landings and associated supporting framework installed in accordance with *D2.25* where the *Spread-of-Flame Index* and the *Smoke-Developed Index* of the timber does not exceed 9 and 8 respectively; or
Vic C1.10(c)(xv)
- (xv) any other material that does not significantly increase the hazards of fire.

C1.11 Performance of external walls in fire

Concrete *external walls* that could collapse as complete panels (e.g. tilt-up and pre-cast concrete), in a building having a *rise in storeys* of not more than 2, must comply with *Specification C1.11*.

C1.12 * * * * *

This clause has deliberately been left blank.

C1.13 Fire-protected timber: Concession

Fire-protected timber may be used wherever an element is *required* to be *non-combustible*, provided—

- (a) the building is—
 - (i) a separate building; or
 - (ii) a part of a building—
 - (A) which only occupies part of a *storey*, and is separated from the remaining part by a *fire wall*; or
 - (B) which is located above or below a part not containing *fire-protected timber* and the floor between the adjoining parts is provided with an FRL not less than that prescribed for a *fire wall* for the lower *storey*; and
- (b) the building has an *effective height* of not more than 25 m; and
- (c) the building has a sprinkler system (other than a FPAA101D or FPAA101H system) throughout complying with *Specification E1.5*; and
- (d) any insulation installed in the cavity of the timber building element *required* to have an FRL is *non-combustible*; and
- (e) cavity barriers are provided in accordance with *Specification C1.13*.

C1.14 Ancillary elements

An *ancillary element* must not be fixed, installed or attached to the internal parts or external face of an *external wall* that is *required* to be *non-combustible* unless it is one of the following:

- (a) An *ancillary element* that is *non-combustible*.
- (b) A gutter, downpipe or other plumbing fixture or fitting.
- (c) A flashing.
- (d) A grate or grille not more than 2 m² in area associated with a building service.
- (e) An electrical switch, socket-outlet, cover plate or the like.
- (f) A light fitting.
- (g) A *required* sign.

Fire resistance

Deemed-to-Satisfy Provisions

- (h) A sign other than one provided under (a) or (g) that—
 - (i) achieves a *group number* of 1 or 2; and
 - (ii) does not extend beyond one *storey*; and
 - (iii) does not extend beyond one *fire compartment*; and
 - (iv) is separated vertically from other signs permitted under (h) by at least 2 *storeys*.
- (i) An awning, sunshade, canopy, blind or shading hood other than one provided under (a) that—
 - (i) meets the relevant requirements of [Table 4 of Specification C1.10](#) as for an internal element; and
 - (ii) serves a *storey*—
 - (A) at ground level; or
 - (B) immediately above a *storey* at ground level; and
 - (iii) does not serve an *exit*, where it would render the *exits* unusable in a fire.
- (j) A part of a security, intercom or announcement system.
- (k) Wiring.
- (l) A paint, lacquer or a similar finish.
- (m) A gasket, caulking, sealant or adhesive directly associated with (a) to (k).

[SA C1.15](#)

Part C2 Compartmentation and separation

Deemed-to-Satisfy Provisions

C2.0 Deemed-to-Satisfy Provisions

- (a) Where a *Deemed-to-Satisfy Solution* is proposed, *Performance Requirements CP1* to *CP9* are satisfied by complying with—
- (i) *C1.1* to *C1.14*, *C2.1* to *C2.14* and *C3.1* to *C3.17*; and
 - (ii) in a building containing an *atrium*, *Part G3*; and
 - (iii) for additional requirements for Class 9b buildings, *Part H1*; and
 - (iv) for *farm sheds*, *Part H3*.
- (b) Where a *Performance Solution* is proposed, the relevant *Performance Requirements* must be determined in accordance with *A2.2(3)* and *A2.4(3)* as applicable.

C2.1 Application of Part

- (a) *C2.2*, *C2.3* and *C2.4* do not apply to a *carpark* provided with a sprinkler system (other than a FPAA101D or FPAA101H system) complying with *Specification E1.5*, an *open-deck carpark* or an *open spectator stand*.
- (b) *C2.12(a)(v)* does not apply to a Class 8 *electricity network substation*.

C2.2 General floor area and volume limitations

- (a) The size of any *fire compartment* or *atrium* in a Class 5, 6, 7, 8 or 9 building must not exceed the relevant maximum *floor area* nor the relevant maximum volume set out in *Table C2.2* and *C2.5* except as permitted in *C2.3*.
- (b) A part of a building which contains only heating, ventilating, or lift equipment, water tanks, or similar service units is not counted in the *floor area* or volume of a *fire compartment* or *atrium* if it is situated at the top of the building.
- (c) In a building containing an *atrium*, the part of the *atrium well* bounded by the perimeter of the openings in the floors and extending from the level of the first floor above the *atrium* floor to the roof covering is not counted in the volume of the *atrium* for the purposes of this clause.

Table C2.2 Maximum size of fire compartments or atria

Classification	Type A construction	Type B construction	Type C construction
5, 9b or 9c	Max <i>floor area</i> —8 000 m ² Max volume—48 000 m ³	Max <i>floor area</i> —5 500 m ² Max volume—33 000 m ³	Max <i>floor area</i> —3 000 m ² max volume—18 000 m ³
6, 7, 8 or 9a (except for <i>patient care areas</i>)	Max <i>floor area</i> —5 000 m ² Max volume—30 000 m ³	Max <i>floor area</i> —3 500 m ² Max volume—21 000 m ³	Max <i>floor area</i> —2 000 m ² Max volume—12 000 m ³

Note to Table C2.2: See *C2.5* for maximum size of compartments in *patient care areas* in Class 9a *health-care buildings*.

C2.3 Large isolated buildings

The size of a *fire compartment* in a building may exceed that specified in *Table C2.2* where—

- (a) the building does not exceed 18 000 m² in *floor area* nor exceed 108 000 m³ in volume, if—
- (i) the building is Class 7 or 8 and—
 - (A) contains not more than 2 *storeys*; and
 - (B) is provided with open space complying with *C2.4(a)* not less than 18 m wide around the building; or
 - (ii) the building is Class 5, 6, 7, 8 or 9 and is—
 - (A) protected throughout with a sprinkler system complying with *Specification E1.5*; and
 - (B) provided with a perimeter vehicular access complying with *C2.4(b)*; or

Fire resistance

Deemed-to-Satisfy Provisions

- (b) the building is Class 5, 6, 7, 8 or 9 and exceeds 18 000 m² in *floor area* or 108 000 m³ in volume, if it is—
 - (i) protected throughout with a sprinkler system complying with [Specification E1.5](#); and
 - (ii) provided with a perimeter vehicular access complying with [C2.4\(b\)](#); or
- (c) there is more than one building on the allotment and—
 - (i) each building complies with (a) or (b); or
 - (ii) if the buildings are closer than 6 m to each other they are regarded as one building and collectively comply with (a) or (b).

C2.4 Requirements for open spaces and vehicular access

- (a) An open space *required* by [C2.3](#) must—
 - (i) be wholly within the allotment except that any road, river, or public place adjoining the allotment, but not the farthest 6 m of it may be included; and
 - (ii) include vehicular access in accordance with (b); and
 - (iii) not be used for the storage or processing of materials; and
 - (iv) not be built upon, except for guard houses and service structures (such as electricity substations and pump houses) which may encroach upon the width of the space if they do not unduly impede fire-fighting at any part of the perimeter of the allotment or unduly add to the risk of spread of fire to any building on an adjoining allotment.
- (b) Vehicular access *required* by this Part—
 - (i) must be capable of providing continuous access for emergency vehicles to enable travel in a forward direction from a public road around the entire building; and
 - (ii) must have a minimum unobstructed width of 6 m with no part of its furthest boundary more than 18 m from the building and in no part of the 6 m width be built upon or used for any purpose other than vehicular or pedestrian movement; and
 - (iii) must provide reasonable pedestrian access from the vehicular access to the building; and
 - (iv) must have a load bearing capacity and unobstructed height to permit the operation and passage of *fire brigade* vehicles; and
 - (v) must be wholly within the allotment except that a public road complying with (i), (ii), (iii) and (iv) may serve as the vehicular access or part thereof.

C2.5 Class 9a and 9c buildings

- (a) A Class 9a *health-care building* must comply with the following:
 - (i) *Patient care areas* must be divided into *fire compartments* not exceeding 2000 m².
 - (ii) A *fire compartment* must be separated from the remainder of the building by *fire walls* and—
 - (A) in Type A construction—floors and roof or ceiling as *required* in [Specification C1.1](#); and
 - (B) in Type B construction—floors with an FRL of not less than 120/120/120 and with the openings in *external walls* bounding *patient care areas* being vertically separated in accordance with the requirements of [C2.6](#) as if the building were of Type A construction.
 - (iii) *Ward areas*—
 - (A) where the *floor area* exceeds 1000 m², must be divided into *floor areas* not more than 1000 m² by walls with an FRL of not less than 60/60/60; and
 - (B) where the *floor area* exceeds 500 m², must be divided into *floor areas* not more than 500 m² by smoke-proof walls complying with [Specification C2.5](#); and
 - (C) where the *floor area* is not more than 500 m², must be separated from the remainder of the *patient care area* by smoke-proof walls complying with [Specification C2.5](#); and
 - (D) where division of *ward areas* by *fire-resisting* walls under (i) or (iii)(A) is not *required*, any smoke-proof wall

Fire resistance

Deemed-to-Satisfy Provisions

required under (iii)(B) or (C) must have an FRL of not less than 60/60/60.

- (iv) *Treatment areas*—
 - (A) where the *floor area* exceeds 1000 m², must be divided into *floor areas* not more than 1000 m² by smoke-proof walls complying with [Specification C2.5](#); and
 - (B) where the *floor area* is not more than 1000 m², must be separated from the remainder of the *patient care area* by smoke-proof walls complying with [Specification C2.5](#).
- (v) Ancillary use areas located within a *patient care area* and containing equipment or materials that are a high potential *fire hazard*, must be separated from the remainder of the *patient care area* by walls with an FRL of not less than 60/60/60.
- (vi) The ancillary use areas referred to in (v) include, but are not limited to, the following:
 - (A) A kitchen and related food preparation areas having a combined *floor area* of more than 30 m².
 - (B) A room containing a hyperbaric facility (pressure chamber).
 - (C) A room used predominantly for the storage of medical records having a *floor area* of more than 10 m².
 - (D) A laundry, where items of equipment are of the type that are potential fire sources (e.g. gas fire dryers).
- (vii) A wall *required* by (v) to separate ancillary use areas from the remainder of the building must extend to the underside of—
 - (A) the floor above; or
 - (B) a *non-combustible* roof covering; or
 - (C) a ceiling having a *resistance to the incipient spread of fire* to the space above itself of not less than 60 minutes.
- (viii) Openings in walls *required* by (iii) and (v) to have an FRL must be protected as follows:
 - (A) Doorways—*self-closing* or *automatic* closing –/60/30 fire doors.
 - (B) Windows—*automatic* or permanently fixed closed –/60/– fire windows or –/60/– *automatic* fire shutters.
 - (C) Other openings—construction having an FRL not less than –/60/–.

NSW C2.5(b)

- (b) A Class 9c building must comply with the following:
 - (i) A building must be divided into areas not more than 500 m² by smoke-proof walls complying with [Specification C2.5](#).
 - (ii) A *fire compartment* must be separated from the remainder of the building by *fire walls* and, notwithstanding [C2.7](#) and [Specification C1.1](#), floors with an FRL of not less than 60/60/60.
 - (iii) Internal walls (other than those bounding lift and stair shafts) supported by floors provided in accordance with [C2.5\(b\)\(ii\)](#) need not comply with [Specification C1.1](#) if they have an FRL not less than 60/–/–.
 - (iv) Ancillary use areas containing equipment or materials that are a high potential *fire hazard*, must be separated from the *sole-occupancy units* by smoke-proof walls complying with [Specification C2.5](#).
 - (v) The ancillary use areas referred to in (iv) include, but are not limited to, the following:
 - (A) A kitchen and related food preparation areas having a combined *floor area* of more than 30 m².
 - (B) A laundry, where items of equipment are of the type that are potential fire sources (e.g. gas fired dryers).
 - (C) Storage rooms greater than 10 m² used predominantly for the storage of administrative records.
 - (vi) Openings in *fire walls* must be protected as follows:
 - (A) Doorways — *self-closing* or *automatic* closing –/60/30 fire doors.
 - (B) Windows — *automatic* or permanently fixed closed –/60/– fire windows or –/60/– *automatic* fire shutters.
 - (C) Other openings — construction having an FRL not less than –/60/–.

Fire resistance

Deemed-to-Satisfy Provisions

C2.6 Vertical separation of openings in external walls

- (a) If in a building of Type A construction, any part of a *window* or other opening in an *external wall* is above another opening in the *storey* next below and its vertical projection falls no further than 450 mm outside the lower opening (measured horizontally), the openings must be separated by—
- (i) a spandrel which—
 - (A) is not less than 900 mm in height; and
 - (B) extends not less than 600 mm above the upper surface of the intervening floor; and
 - (C) is of *non-combustible* material having an FRL of not less than 60/60/60; or
 - (ii) part of a *curtain wall* or *panel wall* that complies with (i); or
 - (iii) construction that complies with (i) behind a *curtain wall* or *panel wall* and has any gaps packed with a *non-combustible* material that will withstand thermal expansion and structural movement of the walling without the loss of seal against fire and smoke; or
 - (iv) a slab or other horizontal construction that—
 - (A) projects outwards from the external face of the wall not less than 1100 mm; and
 - (B) extends along the wall not less than 450 mm beyond the openings concerned; and
 - (C) is *non-combustible* and has an FRL of not less than 60/60/60.
- (b) The requirements of (a) do not apply to—
- (i) an *open-deck carpark*; or
 - (ii) an *open spectator stand*; or
 - (iii) a building which has a sprinkler system (other than a FPAA101D or FPAA101H system) complying with *Specification E1.5* installed throughout; or
 - (iv) openings within the same stairway; or
 - (v) openings in *external walls* where the floor separating the *storeys* does not require an FRL with respect to *integrity* and *insulation*.
- (c) For the purposes of C2.6, *window* or other opening means that part of the *external wall* of a building that does not have an FRL of 60/60/60 or greater.

C2.7 Separation by fire walls

- (a) **Construction** — A *fire wall* must be constructed in accordance with the following:
- (i) The *fire wall* has the relevant FRL prescribed by *Specification C1.1* for each of the adjoining parts, and if these are different, the greater FRL, except where *Tables 3.9, 4.2 and 5.2* of *Specification C1.1* permit a lower FRL on the *carpark* side.
 - (ii) Any openings in a *fire wall* must not reduce the FRL *required* by *Specification C1.1* for the *fire wall*, except where permitted by the *Deemed-to-Satisfy Provisions* of *Part C3*.
 - (iii) Building elements, other than roof battens with dimensions of 75 mm x 50 mm or less or *sarking-type material*, must not pass through or cross the *fire wall* unless the *required fire-resisting* performance of the *fire wall* is maintained.
- (b) **Separation of buildings** — A part of a building separated from the remainder of the building by a *fire wall* may be treated as a separate building for the purposes of the *Deemed-to-Satisfy Provisions* of *Sections C, D and E* if it is constructed in accordance with (a) and the following:
- (i) The *fire wall* extends through all *storeys* and spaces in the nature of *storeys* that are common to that part and any adjoining part of the building.
 - (ii) The *fire wall* is carried through to the underside of the roof covering.
 - (iii) Where the roof of one of the adjoining parts is lower than the roof of the other part, the *fire wall* extends to the underside of—

Fire resistance

Deemed-to-Satisfy Provisions

- (A) the covering of the higher roof, or not less than 6 m above the covering of the lower roof; or
 - (B) the lower roof if it has an FRL not less than that of the *fire wall* and no openings closer than 3 m to any wall above the lower roof; or
 - (C) the lower roof if its covering is *non-combustible* and the lower part has a sprinkler system (other than a FPAA101D or FPAA101H system) complying with [Specification E1.5](#).
- (c) **Separation of fire compartments** — A part of a building separated from the remainder of the building by a *fire wall* may be treated as a separate *fire compartment* if it is constructed in accordance with (a) and the *fire wall* extends to the underside of—
- (i) a floor having an FRL *required* for a *fire wall*; or
 - (ii) the roof covering.

C2.8 Separation of classifications in the same storey

If a building has parts of different classifications located alongside one another in the same *storey*—

- (a) each building element in that *storey* must have the higher FRL prescribed in [Specification C1.1](#) for that element for the classifications concerned; or
- (b) the parts must be separated in that *storey* by a *fire wall* having—
 - (i) the higher FRL prescribed in [Table 3](#) or [4](#); or
 - (ii) the FRL prescribed in [Table 5](#), of [Specification C1.1](#) as applicable, for that element for the Type of construction and the classifications concerned; or
- (c) where one part is a carpark complying with [Table 3.9](#), [4.2](#) or [5.2](#) of [Specification C1.1](#), the parts may be separated by a *fire wall* complying with the appropriate Table.

C2.9 Separation of classifications in different storeys

If parts of different classification are situated one above the other in adjoining *storeys* they must be separated as follows:

- (a) Type A construction — The floor between the adjoining parts must have an FRL of not less than that prescribed in [Specification C1.1](#) for the classification of the lower *storey*.
- (b) Type B or C construction — If one of the adjoining parts is of Class 2, 3 or 4, the floor separating the part from the *storey* below must—
 - (i) be a floor/ceiling system incorporating a ceiling which has a *resistance to the incipient spread of fire* to the space above itself of not less than 60 minutes; or
 - (ii) have an FRL of at least 30/30/30; or
 - (iii) have a *fire-protective covering* on the underside of the floor, including beams incorporated in it, if the floor is *combustible* or of metal.

C2.10 Separation of lift shafts

- (a) Any lift connecting more than 2 *storeys*, or more than 3 *storeys* if the building is sprinklered, (other than lifts which are wholly within an *atrium*) must be separated from the remainder of the building by enclosure in a *shaft* in which—
 - (i) in a building *required* to be of Type A construction—the walls have the relevant FRL prescribed by [Specification C1.1](#); and
 - (ii) in a building *required* to be of Type B construction — the walls—
 - (A) if *loadbearing*, have the relevant FRL prescribed by [Table 4](#) of [Specification C1.1](#); or
 - (B) if non-*loadbearing*, be of *non-combustible* construction.
- (b) Any lift in a *patient care area* in a Class 9a *health-care building* or a *resident use area* in Class 9c building must be separated from the remainder of the building by a *shaft* having an FRL of not less than—
 - (i) in a building of Type A or B construction — 120/120/120; or
 - (ii) in a building of Type C construction — 60/60/60.

Fire resistance

Deemed-to-Satisfy Provisions

- (c) An emergency lift must be contained within a *fire-resisting shaft* having an FRL of not less than 120/120/120.
- (d) Openings for lift landing doors and services must be protected in accordance with the *Deemed-to-Satisfy Provisions* of [Part C3](#).

C2.11 Stairways and lifts in one shaft

A stairway and lift must not be in the same *shaft* if either the stairway or the lift is *required* to be in a *fire-resisting shaft*.

C2.12 Separation of equipment

- (a) Equipment other than that described in (b) and (c) must be separated from the remainder of the building with construction complying with (d), if that equipment comprises—
 - (i) lift motors and lift control panels; or
 - (ii) emergency generators used to sustain emergency equipment operating in the emergency mode; or
 - (iii) central smoke control plant; or
 - (iv) *boilers*; or
 - (v) a *battery system* installed in the building that has a total voltage of 12 volts or more and a storage capacity of 200 kWh or more.
- (b) Equipment need not be separated in accordance with (a) if the equipment comprises—
 - (i) smoke control exhaust fans located in the air stream which are constructed for high temperature operation in accordance with [Specification E2.2b](#); or
 - (ii) stair pressurising equipment installed in compliance with the relevant provisions of AS 1668.1; or
 - (iii) a lift installation without a machine-room; or
 - (iv) equipment otherwise adequately separated from the remainder of the building.
- (c) Separation of on-site fire pumps must comply with the requirements of AS 2419.1.
- (d) Separating construction must have—
 - (i) except as provided by (ii)—
 - (A) an FRL as *required* by [Specification C1.1](#), but not less than 120/120/120; and
 - (B) any doorway protected with a *self-closing* fire door having an FRL of not less than –/120/30; or
 - (ii) when separating a lift *shaft* and lift motor room, an FRL not less than 120/–/–.

C2.13 Electricity supply system

- (a) An electricity substation located within a building must—
 - (i) be separated from any other part of the building by construction having an FRL of not less than 120/120/120; and
 - (ii) have any doorway in that construction protected with a *self-closing* fire door having an FRL of not less than –/120/30.
- (b) A main switchboard located within the building which sustains emergency equipment operating in the emergency mode must—
 - (i) be separated from any other part of the building by construction having an FRL of not less than 120/120/120; and
 - (ii) have any doorway in that construction protected with a *self-closing* fire door having an FRL of not less than –/120/30.
- (c) Electrical conductors located within a building that supply—
 - (i) a substation located within the building which supplies a main switchboard covered by (b); or
 - (ii) a main switchboard covered by (b),

Fire resistance

Deemed-to-Satisfy Provisions

must—

- (iii) have a classification in accordance with AS/NZS 3013 of not less than—
 - (A) if located in a position that could be subject to damage by motor vehicles — WS53W; or
 - (B) otherwise — WS52W; or
- (iv) be enclosed or otherwise protected by construction having an FRL of not less than 120/120/120.
- (d) Where emergency equipment is *required* in a building, all switchboards in the electrical installation, which sustain the electricity supply to the emergency equipment, must be constructed so that emergency equipment switchgear is separated from non-emergency equipment switchgear by metal partitions designed to minimise the spread of a fault from the non-emergency equipment switchgear.
- (e) For the purposes of (d), emergency equipment includes but is not limited to the following:
 - (i) Fire hydrant booster pumps.
 - (ii) Pumps for *automatic* sprinkler systems, water spray, chemical fluid suppression systems or the like.
 - (iii) Pumps for fire hose reels where such pumps and fire hose reels form the sole means of fire protection in the building.
 - (iv) Air handling systems designed to exhaust and control the spread of fire and smoke.
 - (v) Emergency lifts.
 - (vi) Control and indicating equipment.
 - (vii) Emergency warning and intercom systems.

C2.14 Public corridors in Class 2 and 3 buildings

In a Class 2 or 3 building, a *public corridor*, if more than 40 m in length, must be divided at intervals of not more than 40 m with smoke-proof walls complying with [Clause 2 of Specification C2.5](#).

[SA C2.15](#) and [SA C2.16](#)

Part C3 Protection of openings

Deemed-to-Satisfy Provisions

C3.0 Deemed-to-Satisfy Provisions

- (a) Where a *Deemed-to-Satisfy Solution* is proposed, *Performance Requirements CP1* to *CP9* are satisfied by complying with—
- (i) *C1.1* to *C1.14*, *C2.1* to *C2.14* and *C3.1* to *C3.17*; and
 - (ii) in a building containing an *atrium*, *Part G3*; and
 - (iii) for additional requirements for Class 9b buildings, *Part H1*; and
 - (iv) for *farm sheds*, *Part H3*.
- (b) Where a *Performance Solution* is proposed, the relevant *Performance Requirements* must be determined in accordance with *A2.2(3)* and *A2.4(3)* as applicable.

C3.1 Application of Part

- (a) The *Deemed-to-Satisfy Provisions* of this Part do not apply to—
- (i) control joints, weep holes and the like in *external walls* of masonry construction and joints between panels in *external walls* of pre-cast concrete panel construction if, in all cases they are not larger than necessary for the purpose; and
 - (ii) *non-combustible* ventilators for subfloor or cavity ventilation, if each does not exceed 45 000 mm² in face area and is spaced not less than 2 m from any other ventilator in the same wall; and
 - (iii) openings in the vertical plane formed between building elements at the construction edge or perimeter of a balcony or verandah, colonnade, terrace, or the like; and
 - (iv) in a *carpark*—
 - (A) service penetrations through; and
 - (B) openings formed by a vehicle ramp in, a floor other than a floor that separates a part not used as a *carpark*, providing the connected floors comply as a single *fire compartment* for the purposes of all other requirements of the *Deemed-to-Satisfy Provisions* of *Sections C, D* and *E*.
- (b) For the purposes of the *Deemed-to-Satisfy Provisions* of this Part, openings in building elements *required* to be *fire-resisting* include doorways, *windows* (including any associated fanlight), infill panels and fixed or openable glazed areas that do not have the *required* FRL.
- (c) For the purposes of the *Deemed-to-Satisfy Provisions* of this Part, openings, other than those covered under (a)(iii), between building elements such as columns, beams and the like, in the plane formed at the construction edge or perimeter of the building, are deemed to be openings in an *external wall*.

C3.2 Protection of openings in external walls

Openings in an *external wall* that is *required* to have an FRL must—

- (a) if the distance between the opening and the *fire-source feature* to which it is exposed is less than—
- (i) 3 m from a side or rear boundary of the allotment; or
 - (ii) 6 m from the far boundary of a road, river, lake or the like adjoining the allotment, if not located in a *storey* at or near ground level; or
 - (iii) 6 m from another building on the allotment that is not Class 10, be protected in accordance with *C3.4* and if wall-wetting sprinklers are used, they are located externally; and
- (b) if *required* to be protected under (a), not occupy more than 1/3 of the area of the *external wall* of the *storey* in which it is located unless they are in a Class 9b building used as an *open spectator stand*.

Fire resistance

Deemed-to-Satisfy Provisions

C3.3 Separation of external walls and associated openings in different fire compartments

The distance between parts of *external walls* and any openings within them in different *fire compartments* separated by a *fire wall* must not be less than that set out in [Table C3.3](#), unless—

- (a) those parts of each wall have an FRL not less than 60/60/60; and
- (b) any openings protected in accordance with [C3.4](#).

Table C3.3 Distance between external walls and associated openings in different fire compartments

Angle between walls	Minimum distance (m)
0° (walls opposite)	6
more than 0° to 45°	5
more than 45° to 90°	4
more than 90° to 135°	3
more than 135° to less than 180°	2
180° or more	Nil

C3.4 Acceptable methods of protection

- (a) Where protection is *required*, doorways, *windows* and other openings must be protected as follows:
 - (i) Doorways—
 - (A) internal or external wall-wetting sprinklers as appropriate used with doors that are *self-closing* or *automatic closing*; or
 - (B) –/60/30 fire doors that are *self-closing* or *automatic closing*.
 - (ii) *Windows*—
 - (A) internal or external wall-wetting sprinklers as appropriate used with *windows* that are *automatic closing* or permanently fixed in the closed position; or
 - (B) –/60/– fire *windows* that are *automatic closing* or permanently fixed in the closed position; or
 - (C) –/60/– *automatic closing* fire shutters.
 - (iii) Other openings—
 - (A) excluding voids — internal or external wall-wetting sprinklers, as appropriate; or
 - (B) construction having an FRL not less than –/60/–.
- (b) Fire doors, fire *windows* and fire shutters must comply with [Specification C3.4](#).

C3.5 Doorways in fire walls

- (a) The aggregate width of openings for doorways in a *fire wall*, which are not part of a *horizontal exit*, must not exceed ½ of the length of the *fire wall*, and each doorway must be protected by—
 - (i) 2 fire doors or fire shutters, one on each side of the doorway, each of which has an FRL of not less than ½ that *required* by [Specification C1.1](#) for the *fire wall* except that each door or shutter must have an *insulation* level of at least 30; or
 - (ii) a fire door on one side and a fire shutter on the other side of the doorway, each of which complies with (i); or
 - (iii) a single fire door or fire shutter which has an FRL of not less than that *required* by [Specification C1.1](#) for the *fire wall* except that each door or shutter must have an *insulation* level of at least 30.
- (b) A fire door or fire shutter *required* by (a)(i), (ii) or (iii) must be *self-closing*, or *automatic closing* in accordance with (c) and (d).
- (c) The *automatic closing* operation *required* by (b) must be initiated by the activation of a smoke detector, or any other detector deemed suitable in accordance with AS 1670.1 if smoke detectors are unsuitable in the atmosphere, installed in accordance with the relevant provisions of AS 1670.1 and located on each side of the *fire wall* not more than 1.5 m horizontal distance from the opening.

Fire resistance

Deemed-to-Satisfy Provisions

- (d) Where any other *required* suitable fire alarm system, including a sprinkler system (other than a FPAA101D system) complying with [Specification E1.5](#), is installed in the building, activation of the system in either *fire compartment* separated by the *fire wall* must also initiate the *automatic* closing operation.

C3.6 Sliding fire doors

- (a) If a doorway in a *fire wall* is fitted with a sliding fire door which is open when the building is in use—
- (i) it must be held open with an electromagnetic device, which when de-activated in accordance with (b) and (c), allows the door to be fully closed in not less than 20 seconds and not more than 30 seconds after release; and
 - (ii) in the event of power failure to the door — the door must fail safe in the closed position in accordance with (i); and
 - (iii) an audible warning device must be located near the doorway and a red flashing warning light of adequate intensity on each side of the doorway must be activated in accordance with (b) and (c); and
 - (iv) signs must be installed on each side of the doorway located directly over the opening stating—

WARNING — SLIDING FIRE DOOR

in capital letters not less than 50 mm high in a colour contrasting with the background.

- (b) The electromagnetic device *required* by (a)(i) must be de-activated and the warning system activated by heat or smoke detectors, as appropriate, installed in accordance with AS 1905.1 and the relevant provisions of AS 1670.1.
- (c) Where any other *required* suitable fire alarm system, including a sprinkler system (other than a FPAA101D system) complying with [Specification E1.5](#), is installed in the building, activation in either *fire compartment* separated by the *fire wall* must also de-activate the electromagnetic device and activate the warning system.

C3.7 Protection of doorways in horizontal exits

- (a) A doorway that is part of a *horizontal exit* must be protected by either—
- (i) a single fire door that has an FRL of not less than that *required* by [Specification C1.1](#) for the *fire wall* except that the door must have an *insulation* level of at least 30; or
 - (ii) in a Class 7 or 8 building — 2 fire doors, one on each side of the doorway, each with an FRL of not less than ½ that *required* by [Specification C1.1](#) for the *fire wall* except that each door must have an *insulation* level of at least 30.
- (b) Each door *required* by (a) must be *self-closing*, or *automatic-closing* in accordance with the following:
- (i) The *automatic-closing* operation must be initiated by the activation of a smoke detector, or any other detector deemed suitable in accordance with AS 1670.1 if smoke detectors are unsuitable in the atmosphere, installed in accordance with the relevant provisions of AS 1670.1 and located on each side of the *fire wall* not more than 1.5 m horizontal distance from the opening.
 - (ii) Where any other *required* suitable fire alarm system, including a sprinkler system (other than a FPAA101D system) complying with [Specification E1.5](#), is installed in the building, activation of the system in either *fire compartment* separated by the *fire wall* must also initiate the *automatic-closing* operation.

C3.8 Openings in fire-isolated exits

- (a) Doorways that open to *fire-isolated stairways*, *fire-isolated passageways* or *fire-isolated ramps*, and are not doorways opening to a road or *open space*, must be protected by –/60/30 fire doors that are *self-closing*, or *automatic-closing* in accordance with (b) and (c).
- (b) The *automatic-closing* operation *required* by (a) must be initiated by the activation of a smoke detector, or any other detector deemed suitable in accordance with AS 1670.1 if smoke detectors are unsuitable in the atmosphere, installed in accordance with the relevant provisions of AS 1670.1 and located not more than 1.5 m horizontal distance from the approach side of the doorway.
- (c) Where any other *required* suitable fire alarm system, including a sprinkler system (other than a FPAA101D system) complying with [Specification E1.5](#), is installed in the building, activation of the system must also initiate the *automatic-closing* operation.
- (d) A *window* in an *external wall* of a *fire-isolated stairway*, *fire-isolated passageway* or *fire-isolated ramp* must be

Fire resistance

Deemed-to-Satisfy Provisions

protected in accordance with C3.4 if it is within 6 m of, and exposed to, a *window* or other opening in a wall of the same building, other than in the same fire-isolated enclosure.

C3.9 Service penetrations in fire-isolated exits

Fire-isolated *exits* must not be penetrated by any services other than—

- (a) electrical wiring permitted by D2.7(e) to be installed within the *exit*; or
- (b) ducting associated with a pressurisation system if it—
 - (i) is constructed of material having an FRL of not less than –/120/60 where it passes through any other part of the building; and
 - (ii) does not open into any other part of the building; or
- (c) water supply pipes for fire services.

C3.10 Openings in fire-isolated lift shafts

- (a) **Doorways** — If a lift *shaft* is *required* to be fire-isolated, an entrance doorway to that *shaft* must be protected by –/60/– fire doors that—
 - (i) comply with AS 1735.11; and
 - (ii) are set to remain closed except when discharging or receiving passengers, goods or vehicles.
- (b) **Lift indicator panels** — A lift call panel, indicator panel or other panel in the wall of a fire-isolated lift *shaft* must be backed by construction having an FRL of not less than –/60/60 if it exceeds 35 000 mm² in area.

C3.11 Bounding construction: Class 2 and 3 buildings and Class 4 parts

- (a) A doorway in a Class 2 or 3 building must be protected if it provides access from a *sole-occupancy unit* to—
 - (i) a *public corridor*, public lobby, or the like; or
 - (ii) a room not within a *sole-occupancy unit*; or
 - (iii) the landing of an internal non *fire-isolated stairway* that serves as a *required exit*; or
 - (iv) another *sole-occupancy unit*.
- (b) A doorway in a Class 2 or 3 building must be protected if it provides access from a room not within a *sole-occupancy unit* to—
 - (i) a *public corridor*, public lobby, or the like; or
 - (ii) the landing of an internal non *fire-isolated stairway* that serves as a *required exit*.
- (c) A doorway in a Class 4 part of a building must be protected if it provides access to any other internal part of the building.

NSW C3.11(d)

- (d) Protection for a doorway must be at least—
 - (i) in a building of Type A construction — a *self-closing* –/60/30 fire door; and
 - (ii) in a building of Type B or C construction — a *self-closing*, tight fitting, solid core door, not less than 35 mm thick, except—
 - (iii) in a Class 3 building used as a *residential care building* protected with a sprinkler system complying with Specification E1.5—
 - (A) a tight fitting, solid core door not less than 35 mm thick if the building is divided into *floor areas* not exceeding 500 m² with smoke proof walls complying with Clause 2 of Specification C2.5; or
 - (B) a tight fitting, solid core door not less than 35 mm thick fitted with a *self-closing* device, a delayed closing device or an *automatic* closing device.
- (e) Other openings in *internal walls* which are *required* to have an FRL with respect to *integrity* and *insulation* must not reduce the *fire-resisting* performance of the wall.

Fire resistance

Deemed-to-Satisfy Provisions

- (f) A door *required* by (d) may be *automatic*-closing in accordance with the following:
- (i) The *automatic*-closing operation must be initiated by the activation of a smoke detector, or any other detector deemed suitable in accordance with AS 1670.1 if smoke detectors are unsuitable in the atmosphere, installed in accordance with the relevant provisions of AS 1670.1 and located not more than 1.5 m horizontal distance from the approach side of the doorway.
 - (ii) Where any other *required* suitable fire alarm system, including a sprinkler system (other than a FPAA101D system) complying with [Specification E1.5](#), is installed in the building, activation of the system must also initiate the *automatic*-closing operation.
- (g) In a Class 2 or 3 building where a path of travel to an *exit* does not provide a person seeking egress with a choice of travel in different directions to alternative *exits* and is along an open balcony, landing or the like and passes an *external wall* of—
- (i) another *sole-occupancy unit*; or
 - (ii) a room not within a *sole-occupancy unit*, then that *external wall* must—
 - (iii) be constructed of concrete or masonry, or be lined internally with a *fire-protective covering*; and
 - (iv) have any doorway fitted with a *self-closing*, tight-fitting solid core door not less than 35 mm thick; and
 - (v) have any *windows* or other openings—
 - (A) protected internally in accordance with [C3.4](#); or
 - (B) located at least 1.5 m above the floor of the balcony, landing or the like.

NSW C3.11(h)

C3.12 Openings in floors and ceilings for services

- (a) Where a service passes through—
- (i) a floor that is *required* to have an FRL with respect to *integrity* and *insulation*; or
 - (ii) a ceiling *required* to have a *resistance to the incipient spread of fire*, the service must be installed in accordance with (b).
- (b) A service must be protected—
- (i) in a building of Type A construction, by a *shaft* complying with [Specification C1.1](#); or
 - (ii) in a building of Type B or C construction, by a *shaft* that will not reduce the fire performance of the building elements it penetrates; or
 - (iii) in accordance with [C3.15](#).
- (c) Where a service passes through a floor which is *required* to be protected by a *fire-protective covering*, the penetration must not reduce the fire performance of the covering.

C3.13 Openings in shafts

In a building of Type A construction, an opening in a wall providing access to a ventilating, pipe, garbage or other service *shaft* must be protected by—

- (a) if it is in a *sanitary compartment* — a door or panel which, together with its frame, is *non-combustible* or has an FRL of not less than –/30/30; or
- (b) a *self-closing* –/60/30 fire door or hopper; or
- (c) an access panel having an FRL of not less than –/60/30; or
- (d) if the *shaft* is a garbage *shaft* — a door or hopper of *non-combustible* construction.

C3.14 * * * * *

This clause has deliberately been left blank.

Fire resistance

Deemed-to-Satisfy Provisions

C3.15 Openings for service installations

Where an electrical, electronic, plumbing, mechanical ventilation, air-conditioning or other service penetrates a building element (other than an *external wall* or roof) that is *required* to have an FRL with respect to *integrity* or *insulation* or a *resistance to the incipient spread of fire*, that installation must comply with any one of the following:

(a) **Tested systems**

- (i) The service, building element and any protection method at the penetration—
 - (A) are identical with a prototype assembly of the service, building element and protection method which has been tested in accordance with AS 4072.1 and AS 1530.4 and has achieved the *required* FRL or *resistance to the incipient spread of fire*; or
 - (B) differ from a prototype assembly of the service, building element and protection method in accordance with Section 4 of AS 4072.1.
- (ii) It complies with (i) except for the *insulation* criteria relating to the service if—
 - (A) the service is a pipe system comprised entirely of metal (excluding pipe seals or the like); and
 - (B) any *combustible* building element is not located within 100 mm of the service for a distance of 2 m from the penetration; and
 - (C) *combustible* material is not able to be located within 100 mm of the service for a distance of 2 m from the penetration; and
 - (D) it is not located in a *required exit*.
- (iii) The determination of the *required* FRL must be confirmed in a report from an *Accredited Testing Laboratory* in accordance with *Schedule 5*.

(b) **Ventilation and air-conditioning** — In the case of ventilating or air-conditioning ducts or equipment, the installation is in accordance with AS 1668.1.

(c) **Compliance with Specification C3.15**

- (i) The service is a pipe system comprised entirely of metal (excluding pipe seals or the like) and is installed in accordance with *Specification C3.15* and it—
 - (A) penetrates a wall, floor or ceiling, but not a ceiling *required* to have a *resistance to the incipient spread of fire*; and
 - (B) connects not more than 2 *fire compartments* in addition to any *fire-resisting* service *shafts*; and
 - (C) does not contain a flammable or combustible liquid or gas.
- (ii) The service is sanitary plumbing installed in accordance with *Specification C3.15* and it—
 - (A) is of metal or UPVC pipe; and
 - (B) penetrates the floors of a Class 5, 6, 7, 8 or 9b building; and
 - (C) is in a *sanitary compartment* separated from other parts of the building by walls with the FRL *required* by *Specification C1.1* for a stair *shaft* in the building and a *self-closing* –/60/30 fire door.
- (iii) The service is a wire or cable, or a cluster of wires or cables installed in accordance with *Specification C3.15* and it—
 - (A) penetrates a wall, floor or ceiling, but not a ceiling *required* to have a *resistance to the incipient spread of fire*; and
 - (B) connects not more than 2 *fire compartments* in addition to any *fire-resisting* service *shafts*.
- (iv) The service is an electrical switch, outlet, or the like, and it is installed in accordance with *Specification C3.15*.

C3.16 Construction joints

(a) Construction joints, spaces and the like in and between building elements *required* to be *fire-resisting* with respect to *integrity* and *insulation* must be protected in a manner identical with a prototype tested in accordance with AS 1530.4 to achieve the *required* FRL.

Fire resistance

Deemed-to-Satisfy Provisions

- (b) The requirements of (a) do not apply where joints, spaces and the like between *fire-protected timber* elements are provided with cavity barriers in accordance with [Specification C1.13](#).

C3.17 Columns protected with lightweight construction to achieve an FRL

A column protected by *lightweight construction* to achieve an FRL which passes through a building element that is *required* to have an FRL or a *resistance to the incipient spread of fire*, must be installed using a method and materials identical with a prototype assembly of the construction which has achieved the *required* FRL or *resistance to the incipient spread of fire*.

[SA C3.18](#)

Specification C1.1

Fire-resisting construction

Deemed-to-Satisfy Provisions

1. Scope

This Specification contains requirements for the *fire-resisting construction* of building elements.

2. General Requirements

2.1 Exposure to fire-source features

- (a) A part of a building element is exposed to a *fire-source feature* if any of the horizontal straight lines between that part and the *fire-source feature*, or vertical projection of the feature, is not obstructed by another part of the building that—
 - (i) has an FRL of not less than 30/—/—; and
 - (ii) is neither transparent nor translucent.
- (b) A part of a building element is not exposed to a *fire-source feature* if the *fire-source feature* is—
 - (i) an *external wall* of another building that stands on the allotment and the part concerned is more than 15 m above the highest part of that *external wall*; or
 - (ii) a side or rear boundary of the allotment and the part concerned is below the level of the finished ground at every relevant part of the boundary concerned.
- (c) If various distances apply for different parts of a building element—
 - (i) the entire element must have the FRL applicable to that part having the least distance between itself and the relevant *fire-source feature*; or
 - (ii) each part of the element must have the FRL applicable according to its individual distance from the relevant *fire-source feature*,

but this provision does not override or permit any exemption from [Clause 2.2](#).

2.2 Fire protection for a support of another part

- (a) Where a part of a building *required* to have an FRL depends upon direct vertical or lateral support from another part to maintain its FRL, that supporting part, subject to (b), must—
 - (i) have an FRL not less than that *required* by other provisions of this Specification; and
 - (ii) if located within the same *fire compartment* as the part it supports have an FRL in respect of *structural adequacy* the greater of that *required*—
 - (A) for the supporting part itself; and
 - (B) for the part it supports; and
 - (iii) be *non-combustible*—
 - (A) if *required* by other provisions of this Specification; or
 - (B) if the part it supports is *required* to be *non-combustible*.
- (b) The following building elements need not comply with (a)(ii) and (a)(iii)(B):
 - (i) An element providing lateral support to an *external wall* complying with [Clause 5.1\(b\)](#) or [C1.11](#).
 - (ii) An element providing support within a *carpark* and complying with [Clause 3.9](#), [4.2](#) or [5.2](#).
 - (iii) A roof providing lateral support in a building—
 - (A) of Type A construction if it complies with [Clause 3.5\(a\)](#), (b) or (d); and
 - (B) of Type B and C construction.
 - (iv) A column providing lateral support to a wall where the column complies with [Clause 2.5\(a\)](#) and (b).

Fire resistance

Deemed-to-Satisfy Provisions

- (v) An element providing lateral support to a *fire wall* or *fire-resisting* wall, provided the wall is supported on both sides and failure of the element on one side does not affect the fire performance of the wall.

2.3 Lintels

A lintel must have the FRL *required* for the part of the building in which it is situated, unless it does not contribute to the support of a fire door, fire *window* or fire shutter, and—

- (a) it spans an opening in—
 - (i) a wall of a building containing only one *storey*; or
 - (ii) a non-*loadbearing* wall of a Class 2 or 3 building; or
- (b) it spans an opening in masonry which is not more than 150 mm thick and—
 - (i) not more than 3 m wide if the masonry is non-*loadbearing*; or
 - (ii) not more than 1.8 m wide if the masonry is *loadbearing* and part of a solid wall or one of the leaves of a cavity wall.

2.4 Method of attachment not to reduce the fire-resistance of building elements

The method of attaching or installing a finish, lining, *ancillary element* or service installation to the building element must not reduce the fire-resistance of that element to below that *required*.

2.5 General concessions

- (a) **Steel columns** — A steel column, other than one in a *fire wall* or *common wall*, need not have an FRL in a building that contains—
 - (i) only 1 *storey*; or
 - (ii) 2 *storeys* in some of its parts and 1 *storey* only in its remaining parts if the sum of the *floor areas* of the upper *storeys* of its 2 *storey* parts does not exceed the lesser of—
 - (A) 1/8 of the sum of the *floor areas* of the 1 *storey* parts; or
 - (B) in the case of a building to which one of the maximum *floor areas* specified in Table C2.2 is applicable — 1/10 of that area; or
 - (C) in the case of a building to which two or more of the maximum *floor areas* specified in Table C2.2 is applicable — 1/10 of the lesser of those areas.
- (b) **Timber columns** — A timber column may be used in a single *storey* building if—
 - (i) in a *fire wall* or *common wall* the column has an FRL not less than that listed in the appropriate Table 3, 4 or 5; and
 - (ii) in any other case where the column is *required* to have an FRL in accordance with Table 3, 4 or 5, it has an FRL of not less than 30/-/-.
- (c) **Structures on roofs** — A *non-combustible* structure situated on a roof need not comply with the other provisions of this Specification if it only contains—
 - (i) lift motor equipment; or
 - (ii) one or more of the following:
 - (A) Hot water or other water tanks.
 - (B) Ventilating ductwork, ventilating fans and their motors.
 - (C) Air-conditioning chillers.
 - (D) *Window* cleaning equipment.
 - (E) Other service units that are *non-combustible* and do not contain flammable or combustible liquids or gases.
- (d) **Curtain walls and panel walls** — A requirement for an *external wall* to have an FRL does not apply to a *curtain wall* or *panel wall* which is of *non-combustible* construction and fully protected by *automatic* external wall-wetting sprinklers.

Fire resistance

Deemed-to-Satisfy Provisions

- (e) * * * * *
- (f) **Balconies and verandahs** — A balcony, verandah or the like and any incorporated supporting part, which is attached to or forms part of a building, need not comply with Tables 3, 4 and 5 if—
- (i) it does not form part of the only path of travel to a *required exit* from the building; and
 - (ii) in Type A construction—
 - (A) it is situated not more than 2 *storeys* above the lowest *storey* providing direct egress to a road or *open space*; and
 - (B) any supporting columns are of *non-combustible* construction.

2.6 Mezzanine floors: Concession

- (a) This Clause does not apply to a Class 9b building that is a spectator stand or audience viewing area accommodating more than 100 persons as calculated according to D1.13.
- (b) A *mezzanine* and its supports need not have an FRL or be *non-combustible* provided—
 - (i) the total *floor area* of all the *mezzanines* in the same room does not exceed 1/3 of the *floor area* of the room or 200 m², whichever is the lesser; and
 - (ii) the FRL of each wall and column that supports any other part of the building within 6 m of the *mezzanine* is increased by the amount listed in Table 2.6.

Table 2.6 Increased FRLs — Construction surrounding mezzanines

Level otherwise <i>required</i> for any FRL criterion (mins)	Increase in level to not less than (mins):
30	60
60	90
90	120
120	180
180	240

Note to Table 2.6: The increase in level applies to each FRL criterion (*structural adequacy*, *integrity* or *insulation*) relevant to the building element concerned.

2.7 Enclosure of shafts

Shafts required to have an FRL must be enclosed at the top and bottom by construction having an FRL not less than that *required* for the walls of a non-*loadbearing shaft* in the same building, except that these provisions need not apply to—

- (a) the top of a *shaft* extending beyond the roof covering, other than one enclosing a *fire-isolated stairway* or *ramp*; or
- (b) the bottom of a *shaft* if it is *non-combustible* and laid directly on the ground.

2.8 Carparks in Class 2 and 3 buildings

- (a) If a Class 2 building contains not more than 4 *storeys* of which—
 - (i) one *storey* is Class 7 used solely for the purpose of parking motor vehicles or for some other purpose that is ancillary to a Class 2; and
 - (ii) the remaining *storeys* are of Class 2, the *carpark storey* is regarded as Class 2 only for the purpose of determining the relevant *fire-resisting* requirements of this Specification.
- (b) If a Class 3 building or a building of Class 2 and 3 contains not more than 3 *storeys* of which—
 - (i) one *storey* is Class 7 used solely for the purpose of parking motor vehicles or for some other purpose that is ancillary to the other *storeys*; and
 - (ii) the remaining *storeys* are of Class 2 or 3,

Fire resistance

Deemed-to-Satisfy Provisions

the *carpark storey* is regarded as Class 2 or 3 only for the purpose of determining the relevant *fire-resisting* requirements of this Specification.

2.9 Residential care building: Concession

- (a) In a Class 3 building protected with a sprinkler system complying with [Specification E1.5](#) and used as a *residential care building*, any FRL criterion prescribed in [Tables 3, 4 or 5](#)—
 - (i) for any floor and any *loadbearing* wall, may be reduced to 60, except any FRL criterion of 90 for an *external wall* must be maintained when tested from the outside; and
 - (ii) for any non-*loadbearing internal wall*, need not apply if—
 - (A) it is lined on each side with standard grade plasterboard not less than 13 mm thick or similar *non-combustible* material; and
 - (B) it extends—
 - (aa) to the underside of the floor next above; or
 - (bb) to the underside of a ceiling lined with standard grade plasterboard not less than 13 mm thick or a material with at least an equivalent level of fire protection; or
 - (cc) to the underside of a *non-combustible* roof covering; and
 - (C) any insulation installed in the cavity of the wall is *non-combustible*; and
 - (D) any construction joint, space or the like between the top of the wall and the floor, ceiling or roof is smoke sealed with intumescent putty or other suitable material.
- (b) The concession described at (a) does not apply to *fire-protected timber* building elements.

3. Type A Fire-Resisting Construction

3.1 Fire-resistance of building elements

In a building *required* to be of Type A construction—

- (a) each building element listed in [Table 3](#) and any beam or column incorporated in it, must have an FRL not less than that listed in the Table for the particular Class of building concerned; and
- (b) * * * * *
- (c) any *internal wall required* to have an FRL with respect to *integrity* and *insulation* must extend to—
 - (i) the underside of the floor next above; or
 - (ii) the underside of a roof complying with [Table 3](#); or
 - (iii) if under [Clause 3.5](#) the roof is not *required* to comply with [Table 3](#), the underside of the *non-combustible* roof covering and, except for roof battens with dimensions of 75 mm x 50 mm or less or *sarking-type material*, must not be crossed by timber or other *combustible* building elements; or
 - (iv) a ceiling that is immediately below the roof and has a *resistance to the incipient spread of fire* to the roof space between the ceiling and the roof of not less than 60 minutes; and
- (d) a *loadbearing internal wall* and a *loadbearing fire wall* (including those that are part of a *loadbearing shaft*) must be constructed from—
 - (i) concrete; or
 - (ii) masonry; or
 - (iii) *fire-protected timber*, provided that—
 - (A) the building is—
 - (aa) a separate building; or
 - (bb) a part of a building—
 - (AA) which only occupies part of a *storey*, and is separated from the remaining part by a *fire wall*; or

Fire resistance

Deemed-to-Satisfy Provisions

- (BB) which is located above or below a part not containing *fire-protected timber* and the floor between the adjoining parts is provided with an FRL not less than that prescribed for a *fire wall* for the lower *storey*; and
- (B) the building has an *effective height* of not more than 25 m; and
- (C) the building has a sprinkler system (other than a FPAA101D or FPAA101H system) throughout complying with *Specification E1.5*; and
- (D) any insulation installed in the cavity of the timber building element *required* to have an FRL is *non-combustible*; and
- (E) cavity barriers are provided in accordance with *Specification C1.13*; or
- (iv) any combination of (i) to (iii); and
- (e) * * * * *
- (f) the FRLs specified in *Table 3* for an external column apply also to those parts of an internal column that face and are within 1.5 m of a *window* and are exposed through that *window* to a *fire-source feature*.

Table 3 Type A construction: FRL of building elements

Building element	Class of building — FRL: (in minutes)			
	<i>Structural adequacy/Integrity/Insulation</i>			
	2, 3 or 4 part	5, 7a or 9	6	7b or 8
EXTERNAL WALL (including any column and other building element incorporated within it) or other external building element, where the distance from any <i>fire-source feature</i> to which it is exposed is—				
For <i>loadbearing</i> parts—				
less than 1.5 m	90/ 90/ 90	120/120/120	180/180/180	240/240/240
1.5 to less than 3 m	90/ 60/ 60	120/ 90/ 90	180/180/120	240/240/180
3 m or more	90/ 60/ 30	120/ 60/ 30	180/120/ 90	240/180/ 90
For non- <i>loadbearing</i> parts—				
less than 1.5 m	-/ 90/ 90	-/120/120	-/180/180	-/240/240
1.5 to less than 3 m	-/ 60/ 60	-/ 90/ 90	-/180/120	-/240/180
3 m or more	-/-/-	-/-/-	-/-/-	-/-/-
EXTERNAL COLUMN not incorporated in an <i>external wall</i> —				
For <i>loadbearing</i> columns—	90/-/-	120/-/-	180/-/-	240/-/-
For non- <i>loadbearing</i> columns—	-/-/-	-/-/-	-/-/-	-/-/-
COMMON WALLS and FIRE WALLS—	90/ 90/ 90	120/120/120	180/180/180	240/240/240
INTERNAL WALLS—				
<i>Fire-resisting</i> lift and stair <i>shafts</i> —				
<i>Loadbearing</i>	90/ 90/ 90	120/120/120	180/120/120	240/120/120
Non- <i>loadbearing</i>	-/ 90/ 90	-/120/120	-/120/120	-/120/120
Bounding <i>public corridors</i> , public lobbies and the like—				
<i>Loadbearing</i>	90/ 90/ 90	120/-/-	180/-/-	240/-/-
Non- <i>loadbearing</i>	-/ 60/ 60	-/-/-	-/-/-	-/-/-
Between or bounding <i>sole-occupancy units</i> —				
<i>Loadbearing</i>	90/ 90/ 90	120/-/-	180/-/-	240/-/-
Non- <i>loadbearing</i>	-/ 60/ 60	-/-/-	-/-/-	-/-/-
Ventilating, pipe, garbage, and like <i>shafts</i> not used for the discharge of hot products of combustion—				
<i>Loadbearing</i>	90/ 90/ 90	120/ 90/ 90	180/120/120	240/120/120
Non- <i>loadbearing</i>	-/ 90/ 90	-/ 90/ 90	-/120/120	-/120/120
OTHER LOADBEARING INTERNAL WALLS, INTERNAL BEAMS, TRUSSES and COLUMNS—				
	90/-/-	120/-/-	180/-/-	240/-/-
FLOORS	90/ 90/ 90	120/120/120	180/180/180	240/240/240

Fire resistance

Deemed-to-Satisfy Provisions

Building element	Class of building — FRL: (in minutes) <i>Structural adequacy/Integrity/Insulation</i>			
	2, 3 or 4 part	5, 7a or 9	6	7b or 8
ROOFS	90/ 60/ 30	120/ 60/ 30	180/ 60/ 30	240/ 90/ 60

3.2 Concessions for floors

A floor need not comply with [Table 3](#) if—

- (a) it is laid directly on the ground; or
- (b) in a Class 2, 3, 5 or 9 building, the space below is not a *storey*, does not accommodate motor vehicles, is not a storage or work area, and is not used for any other ancillary purpose; or
- (c) it is a timber *stage* floor in a Class 9b building laid over a floor having the *required* FRL and the space below the *stage* is not used as a dressing room, store room, or the like; or
- (d) it is within a *sole-occupancy unit* in a Class 2 or 3 building or Class 4 part of a building; or
- (e) it is an open-access floor (for the accommodation of electrical and electronic services and the like) above a floor with the *required* FRL.

3.3 Floor loading of Class 5 and 9b buildings: Concession

If a floor in a Class 5 or 9b building is designed for a live load not exceeding 3 kPa—

- (a) the floor next above (including floor beams) may have an FRL of 90/90/90; or
- (b) the roof, if that is next above (including roof beams) may have an FRL of 90/60/30.

3.4 Roof superimposed on concrete slab: Concession

A roof superimposed on a concrete slab roof need not comply with [Clause 3.1](#) as to *fire-resisting construction* if—

- (a) the superimposed roof and any construction between it and the concrete slab roof are *non-combustible* throughout; and
- (b) the concrete slab roof complies with [Table 3](#).

3.5 Roof: Concession

A roof need not comply with [Table 3](#) if its covering is *non-combustible* and the building—

- (a) has a sprinkler system (other than a FPAA101D or FPAA101H system) complying with [Specification E1.5](#) installed throughout; or
- (b) has a *rise in storeys* of 3 or less; or
- (c) is of Class 2 or 3; or
- (d) has an *effective height* of not more than 25 m and the ceiling immediately below the roof has a *resistance to the incipient spread of fire* to the roof space of not less than 60 minutes.

3.6 Roof lights

If a roof is *required* to have an FRL or its covering is *required* to be *non-combustible*, roof lights or the like installed in that roof must—

- (a) have an aggregate area of not more than 20% of the roof surface; and
- (b) be not less than 3 m from—
 - (i) any boundary of the allotment other than the boundary with a road or public place; and
 - (ii) any part of the building which projects above the roof unless that part has the FRL *required* of a *fire wall* and any openings in that part of the wall for 6 m vertically above the roof light or the like are protected in accordance with [C3.4](#); and
 - (iii) any roof light or the like in an adjoining *sole-occupancy unit* if the walls bounding the unit are *required* to have an FRL; and

Fire resistance

Deemed-to-Satisfy Provisions

- (iv) any roof light or the like in an adjoining fire-separated section of the building; and
- (c) if a ceiling with a *resistance to the incipient spread of fire* is *required*, be installed in a way that will maintain the level of protection provided by the ceiling to the roof space.

3.7 Internal columns and walls: Concession

For a building with an *effective height* of not more than 25 m and having a roof without an FRL in accordance with [Clause 3.5](#), in the *storey* immediately below that roof, internal columns other than those referred to in [Clause 3.1\(f\)](#) and *internal walls* other than *fire walls* and *shaft* walls may have—

- (a) in a Class 2 or 3 building: FRL 60/60/60; or
- (b) in a Class 5, 6, 7, 8 or 9 building—
 - (i) with *rise in storeys* exceeding 3: FRL 60/60/60; or
 - (ii) with *rise in storeys* not exceeding 3: no FRL.

3.8 Open spectator stands and indoor sports stadiums: Concession

In an *open spectator stand* or indoor sports stadium, the following building elements need not have the FRL specified in [Table 3](#):

- (a) The roof if it is *non-combustible*.
- (b) Columns and *loadbearing* walls supporting only the roof if they are *non-combustible*.
- (c) Any non-*loadbearing* part of an *external wall* less than 3 m—
 - (i) from any *fire-source feature* to which it is exposed if it has an FRL of not less than –/60/60 and is *non-combustible*; or
 - (ii) from an *external wall* of another *open spectator stand* if it is *non-combustible*.

3.9 Carparks

- (a) Notwithstanding [Clause 3.1](#), a *carpark* may comply with [Table 3.9](#) if it is an *open-deck carpark* or is protected with a sprinkler system (other than a FPAA101D or FPAA101H system) complying with [Specification E1.5](#) and is—
 - (i) a separate building; or
 - (ii) a part of a building—
 - (A) which only occupies part of a *storey*, and is separated from the remaining part by a *fire wall*; or
 - (B) which is located above or below another classification, and the floor separating the classifications complies with [C2.9](#); or
 - (C) which is located above another Class 7 part of the building not used for carparking, and the floor separating the parts complies with [Table 3](#) for a Class 7 part other than a *carpark*; or
 - (D) which is located below another Class 7 part of the building not used for carparking, and the floor separating the parts complies with [Table 3.9](#).
- (b) For the purposes of this Clause, a *carpark*—
 - (i) includes—
 - (A) an administration area associated with the functioning of the *carpark*; and
 - (B) where the *carpark* is sprinklered, is associated with a Class 2 or 3 building and provides carparking for separate *sole-occupancy units*, each carparking area with an area not greater than 10% of its *floor area* for purposes ancillary to the *sole-occupancy units*; but
 - (ii) excludes—
 - (A) except for [\(b\)\(i\)](#), any area of another classification, or other part of a Class 7 building not used for carparking; and
 - (B) a building or part of a building specifically intended for the parking of trucks, buses, vans and the like.

Fire resistance

Deemed-to-Satisfy Provisions

Table 3.9 Requirements for carpark

Building element	FRL (not less than) <i>Structural adequacy/Integrity/Insulation</i> ESA/M (not greater than)
Wall	
(a) <i>external wall</i>	
(i) less than 3 m from a <i>fire-source feature</i> to which it is exposed:	
<i>Loadbearing</i>	60/60/60
<i>Non-loadbearing</i>	–/60/60
(ii) 3 m or more from a <i>fire-source feature</i> to which it is exposed	–/–/–
(b) <i>internal wall</i>	
(i) <i>loadbearing</i> , other than one supporting only the roof (not used for carparking)	60/–/–
(ii) supporting only the roof (not used for carparking)	–/–/–
(iii) <i>non-loadbearing</i>	–/–/–
(c) <i>fire wall</i>	
(i) from the direction used as a <i>carpark</i>	60/60/60
(ii) from the direction not used as a <i>carpark</i>	as <i>required</i> by Table 3
Column	
(a) supporting only the roof (not used for carparking) and 3 m or more from a <i>fire-source feature</i> to which it is exposed	–/–/–
(b) steel column, other than one covered by (a) and one that does not support a part of a building that is not used as a <i>carpark</i>	60/–/– or 26 m ² /tonne
(c) any other column not covered by (a) or (b)	60/–/–
Beam	
(a) steel floor beam in continuous contact with a concrete floor slab	60/–/– or 30 m ² /tonne
(b) any other beam	60/–/–
Fire-resisting lift and stair shaft (within the <i>carpark</i> only)	60/60/60
Floor slab and vehicle ramp	60/60/60
Roof (not used for carparking)	–/–/–

Notes to Table 3.9:

1. ESA/M means the ratio of exposed surface area to mass per unit length.
2. Refer to [Specification E1.5](#) for special requirements for a sprinkler system in a *carpark* complying with [Table 3.9](#) and located within a multi-classified building.

3.10 Class 2 and 3 buildings: Concession

- (a) In a Class 2 or 3 building with a *rise in storeys* of not more than 3—
 - (i) notwithstanding [C1.9\(a\)](#) and [\(b\)](#) and [C2.6](#), timber framing may be used for—
 - (A) *external walls*; and
 - (B) *common walls*; and
 - (C) the floor framing of lift pits; and
 - (D) *non-loadbearing internal walls* which are *required* to be *fire-resisting*; and
 - (E) *non-loadbearing shafts*, except *shafts* used for the discharge of hot products of combustion; and

Fire resistance

Deemed-to-Satisfy Provisions

- (F) spandrels or horizontal construction provided for the purposes of C2.6; and
- (ii) notwithstanding Clause 3.1(d) of Specification C1.1, for *loadbearing internal walls* and *loadbearing fire walls*—
 - (A) timber framing may be used; and
 - (B) *non-combustible* materials may be used.
- (b) A Class 2 or 3 building having a *rise in storeys* of not more than 4 may have the top three *storeys* constructed in accordance with (a) provided—
 - (i) the lowest *storey* is used solely for the purpose of parking motor vehicles or for some other ancillary purpose; and
 - (ii) the lowest *storey* is constructed of concrete or masonry including the floor between it and the Class 2 or 3 part of the building above; and
 - (iii) the lowest *storey* and the *storey* above are separated by construction having an FRL of not less than 90/90/90 with no openings or penetrations that would reduce the *fire-resisting* performance of that construction except that a doorway in that construction may be protected by a –/60/30 *self-closing* fire door.
- (c) In a Class 2 or 3 building complying with (a) or (b) and fitted with a sprinkler system (other than a FPAA101D or FPAA101H system) complying with Specification E1.5, any FRL criterion prescribed in Table 3—
 - (i) for any floor and any *loadbearing* wall, may be reduced to 60, except any FRL criterion of 90 for an *external wall* must be maintained when tested from the outside; and
 - (ii) for any non-*loadbearing internal wall*, need not apply if—
 - (A) it is lined on each side with 13 mm standard grade plasterboard or similar *non-combustible* material; and
 - (B) it extends—
 - (aa) to the underside of the floor next above; or
 - (bb) to the underside of a ceiling with a *resistance to the incipient spread of fire* of 60 minutes; or
 - (cc) to the underside of a *non-combustible* roof covering; and
 - (C) any insulation installed in the cavity of the wall is *non-combustible*; and
 - (D) any construction joint, space or the like between the top of the wall and the floor, ceiling or roof is smoke sealed with intumescent putty or other suitable material; and
 - (E) any doorway in the wall is protected by a *self-closing*, tight fitting, solid core door not less than 35 mm thick.

4. Type B Fire-Resisting Construction

4.1 Fire-resistance of building elements

In a building *required* to be of Type B construction—

- (a) each building element listed in [Table 4](#), and any beam or column incorporated in it, must have an FRL not less than that listed in the Table for the particular Class of building concerned; and
- (b) * * * * *
- (c) if a stair *shaft* supports any floor or a structural part of it—
 - (i) the floor or part must have an FRL of 60/—/— or more; or
 - (ii) the junction of the stair *shaft* must be constructed so that the floor or part will be free to sag or fall in a fire without causing structural damage to the *shaft*; and
- (d) any *internal wall* which is *required* to have an FRL with respect to *integrity* and *insulation*, except a wall that bounds a *sole-occupancy unit* in the topmost (or only) *storey* and there is only one unit in that *storey*, must extend to—
 - (i) the underside of the floor next above if that floor has an FRL of at least 30/30/30; or
 - (ii) the underside of a ceiling having a *resistance to the incipient spread of fire* to the space above itself of not less than 60 minutes; or
 - (iii) the underside of the roof covering if it is *non-combustible* and, except for roof battens with dimensions of 75 mm x 50 mm or less or *sarking-type material*, must not be crossed by timber or other *combustible* building elements; or
 - (iv) 450 mm above the roof covering if it is *combustible*; and
- (e) a *loadbearing internal wall* and a *loadbearing fire wall* (including those that are part of a *loadbearing shaft*) must be constructed from—
 - (i) concrete; or
 - (ii) masonry; or
 - (iii) *fire-protected timber*, provided that—
 - (A) the building is—
 - (aa) a separate building; or
 - (bb) a part of a building—
 - (AA) which only occupies part of a *storey*, and is separated from the remaining part by a *fire wall*; or
 - (BB) which is located above or below a part not containing *fire-protected timber* and the floor between the adjoining parts is provided with an FRL not less than that prescribed for a *fire wall* for the lower *storey*; and
 - (B) the building has an *effective height* of not more than 25 m; and
 - (C) the building has a sprinkler system (other than a FPAA101D or FPAA101H system) throughout complying with [Specification E1.5](#); and
 - (D) any insulation installed in the cavity of the timber building element *required* to have an FRL is *non-combustible*; and
 - (E) cavity barriers are provided in accordance with [Specification C1.13](#); or
 - (iv) any combination of (i) to (iii); and

Fire resistance

Deemed-to-Satisfy Provisions

- (f) * * * * *
- (g) in a Class 5, 6, 7, 8 or 9 building, in the *storey* immediately below the roof, internal columns and *internal walls* other than *fire walls* and *shaft* walls, need not comply with [Table 4](#); and
- (h) * * * * *
- (i) in a Class 2 or 3 building, except where within the one *sole-occupancy units*, or a Class 9a *health-care building* or a Class 9b building, a floor separating *storeys* or above a space for the accommodation of motor vehicles or used for storage or any other ancillary purpose, must—
- (i) be constructed so that it is at least of the standard achieved by a floor/ceiling system incorporating a ceiling which has a *resistance to the incipient spread of fire* to the space above itself of not less than 60 minutes; or
 - (ii) have an FRL of at least 30/30/30; or
 - (iii) have a *fire-protective covering* on the underside of the floor, including beams incorporated in it, if the floor is *combustible* or of metal; and
- (j) in a Class 9c building a floor above a space for the accommodation of motor vehicles or used for storage or any other ancillary purpose, and any column supporting the floor must—
- (i) be constructed so that it is at least of the standard achieved by a floor/ceiling system incorporating a ceiling which has a *resistance to the incipient spread of fire* to the space above itself of not less than 60 minutes; or
 - (ii) have an FRL of at least 30/30/30; or
 - (iii) have a *fire-protective covering* on the underside of the floor, including beams incorporated in it, if the floor is *combustible* or of metal.

Fire resistance

Deemed-to-Satisfy Provisions

Table 4 Type B construction: FRL of building elements

Building element	Class of building—FRL: (in minutes)			
	<i>Structural adequacy/Integrity/Insulation</i>			
	2, 3 or 4 part	5, 7a or 9	6	7b or 8
EXTERNAL WALL (including any column and other building element incorporated within it) or other external building element, where the distance from any <i>fire-source feature</i> to which it is exposed is—				
For <i>loadbearing</i> parts—				
less than 1.5 m	90/ 90/ 90	120/120/120	180/180/180	240/240/240
1.5 to less than 3 m	90/ 60/ 30	120/ 90/ 60	180/120/ 90	240/180/120
3 to less than 9 m	90/ 30/ 30	120/ 30/ 30	180/ 90/ 60	240/ 90/ 60
9 to less than 18 m	90/ 30/–	120/ 30/–	180/ 60/–	240/ 60/–
18 m or more	–/–/–	–/–/–	–/–/–	–/–/–
For non- <i>loadbearing</i> parts—				
less than 1.5 m	–/ 90/ 90	–/120/120	–/180/180	–/240/240
1.5 to less than 3 m	–/ 60/ 30	–/ 90/ 60	–/120/ 90	–/180/120
3 m or more	–/–/–	–/–/–	–/–/–	–/–/–
EXTERNAL COLUMN not incorporated in an <i>external wall</i> , where the distance from any <i>fire-source feature</i> to which it is exposed is—				
For <i>loadbearing</i> columns—				
less than 18 m	90/–/–	120/–/–	180/–/–	240/–/–
18 m or more	–/–/–	–/–/–	–/–/–	–/–/–
For non- <i>loadbearing</i> columns—				
For non- <i>loadbearing</i> columns—	–/–/–	–/–/–	–/–/–	–/–/–
COMMON WALLS and FIRE WALLS—	90/ 90 / 90	120/120/120	180/180/180	240/240/240
INTERNAL WALLS—				
<i>Fire-resisting</i> lift and stair <i>shafts</i> —				
<i>Loadbearing</i>	90/ 90/ 90	120/120/120	180/120/120	240/120/120
<i>Fire-resisting</i> stair <i>shafts</i> —				
Non- <i>loadbearing</i>	–/ 90/ 90	–/120/120	–/120/120	–/120/120
Bounding <i>public corridors</i> , public lobbies and the like—				
<i>Loadbearing</i>	60/ 60/ 60	120/–/–	180/–/–	240/–/–
Non- <i>loadbearing</i>	–/ 60/ 60	–/–/–	–/–/–	–/–/–
Between or bounding <i>sole-occupancy units</i> —				
<i>Loadbearing</i>	60/ 60/ 60	120/–/–	180/–/–	240/–/–
Non- <i>loadbearing</i>	–/ 60/ 60	–/–/–	–/–/–	–/–/–
OTHER LOADBEARING INTERNAL WALLS and COLUMNS—	60/–/–	120/–/–	180/–/–	240/–/–
ROOFS	–/–/–	–/–/–	–/–/–	–/–/–

4.2 Carparks

- (a) Notwithstanding [Clause 4.1](#), a *carpark* may comply with [Table 4.2](#) if it is an *open-deck carpark* or is protected with a sprinkler system (other than a FPAA101D or FPAA101H system) complying with [Specification E1.5](#) and is—
- (i) a separate building; or
 - (ii) a part of a building, and if occupying only part of a *storey*, is separated from the remaining part by a *fire wall*.
- (b) For the purposes of this Clause, a *carpark*—
- (i) includes—
 - (A) an administration area associated with the functioning of the *carpark*; and

Fire resistance

Deemed-to-Satisfy Provisions

- (B) where the *carpark* is sprinklered, is associated with a Class 2 or 3 building and provides carparking for separate *sole-occupancy units*, each carparking area with an area not greater than 10% of its *floor area* for purposes ancillary to the *sole-occupancy units*; but
- (ii) excludes—
- (A) except for (b)(i), any area of another classification, or other part of a Class 7 building not used for carparking; and
- (B) a building or part of a building specifically intended for the parking of trucks, buses, vans and the like.

Table 4.2 Requirements for carparks

Building element	FRL (not less than) <i>Structural adequacy/Integrity/Insulation</i> ESA/M (not greater than)
Wall	
(a) <i>external wall</i>	
(i) less than 3 m from a <i>fire-source feature</i> to which it is exposed:	
<i>Loadbearing</i>	60/60/60
<i>Non-loadbearing</i>	–/60/60
(ii) 3 m or more from a <i>fire-source feature</i> to which it is exposed	–/–/–
(b) <i>internal wall</i>	
(i) <i>loadbearing</i> , other than one supporting only the roof (not used for carparking)	60/–/–
(ii) supporting only the roof (not used for carparking)	–/–/–
(iii) <i>non-loadbearing</i>	–/–/–
(c) <i>fire wall</i>	
(i) from the direction used as a <i>carpark</i>	60/60/60
(ii) from the direction not used as a <i>carpark</i>	as <i>required</i> by Table 4
Column	
(a) supporting only the roof (not used for carparking) and 3 m or more from a <i>fire-source feature</i> to which it is exposed	–/–/–
(b) steel column, other than one covered by (a)	60/–/– or 26 m ² /tonne
(c) any other column not covered by (a) or (b)	60/–/–
Beam	
(a) less than 3 m from a <i>fire-source feature</i> :	
(i) steel floor beam in continuous contact with a concrete floor slab	60/–/– or 30 m ² /tonne
(ii) any other beam	60/–/–
(b) 3 m or more from a <i>fire-source feature</i>	–/–/–
Lift shaft	
	–/–/–
Fire-resisting stair shaft (within the <i>carpark</i> only)	
	60/60/60
Roof, floor slab and vehicle ramp	
	–/–/–

Note to Table 4.2: ESA/M means the ratio of exposed surface area to mass per unit length.

4.3 Class 2 and 3 buildings: Concession

- (a) In a Class 2 or 3 building with a *rise in storeys* of not more than 2—
- (i) notwithstanding C1.9(a) and (b), timber framing may be used for—
- (A) *external walls*; and
- (B) *common walls*; and
- (C) the floor framing of lift pits; and
- (D) *non-loadbearing internal walls* which are *required* to be *fire-resisting*; and
- (E) *non-loadbearing shafts*, except *shafts* used for the discharge of hot products of combustion; and

Fire resistance

Deemed-to-Satisfy Provisions

- (ii) notwithstanding [Clause 4.1\(e\)](#) of [Specification C1.1](#), for *loadbearing internal walls* and *loadbearing fire walls*—
 - (A) timber framing may be used; and
 - (B) *non-combustible* materials may be used.
- (b) A Class 2 or 3 building having a *rise in storeys* of not more than 2 may have the top *storey* constructed in accordance with (a) provided—
 - (i) the lowest *storey* is used solely for the purpose of parking motor vehicles or for some other ancillary purpose; and
 - (ii) the lowest *storey* is constructed of concrete or masonry including the floor between it and the Class 2 or 3 part of the building above; and
 - (iii) the lowest *storey* and the *storey* above are separated by construction having an FRL of not less than 90/90/90 with no openings or penetrations that would reduce the *fire-resisting* performance of that construction except that a doorway in that construction may be protected by a *-/60/30 self-closing* fire door.
- (c) In a Class 2 or 3 building complying with (a) or (b) and fitted with a sprinkler system (other than a FPAA101D or FPAA101H system) complying with [Specification E1.5](#), any FRL criterion prescribed in [Table 4](#)—
 - (i) for any *loadbearing* wall, may be reduced to 60, except any FRL criterion of 90 for an *external wall* must be maintained when tested from the outside; and
 - (ii) for any non-*loadbearing internal wall*, need not apply, if—
 - (A) it is lined on both sides with 13 mm standard grade plasterboard or similar *non-combustible* material; and
 - (B) it extends—
 - (aa) to the underside of the floor next above if that floor has an FRL of at least 30/30/30 or is lined on the underside with a *fire-protective covering*; or
 - (bb) to the underside of a ceiling with a *resistance to the incipient spread of fire* of 60 minutes; or
 - (cc) to the underside of a *non-combustible* roof covering; and
 - (C) any insulation installed in the cavity of the wall is *non-combustible*; and
 - (D) any construction joints, spaces and the like between the top of the wall and the floor, ceiling or roof is smoke sealed with intumescent putty or other suitable material.

5. Type C Fire-Resisting Construction

5.1 Fire-resistance of building elements

In a building *required* to be of Type C construction—

- (a) a building element listed in [Table 5](#) and any beam or column incorporated in it, must have an FRL not less than that listed in the Table for the particular Class of building concerned; and
- (b) an *external wall* that is *required* by [Table 5](#) to have an FRL need only be tested from the outside to satisfy the requirement; and
- (c) a *fire wall* or an *internal wall* bounding a *sole-occupancy unit* or separating adjoining units must comply with [Specification C1.8](#) if it is of *lightweight construction* and is *required* to have an FRL; and
- (d) in a Class 2 or 3 building, an *internal wall* which is *required* by [Table 5](#) to have an FRL must extend—
 - (i) to the underside of the floor next above if that floor has an FRL of at least 30/30/30 or a *fire-protective covering* on the underside of the floor; or
 - (ii) to the underside of a ceiling having a *resistance to the incipient spread of fire* to the space above itself of not less than 60 minutes; or

Fire resistance

Deemed-to-Satisfy Provisions

- (iii) to the underside of the roof covering if it is *non-combustible*, and except for roof battens with dimensions of 75 mm x 50 mm or less or *sarking-type material*, must not be crossed by timber or other *combustible* building elements; or
- (iv) 450 mm above the roof covering if it is *combustible*; and
- (e) in a Class 2 or 3 building, except where within the one *sole-occupancy unit*, or a Class 9a *health-care building*, or a Class 9b building, a floor separating *storeys*, or above a space for the accommodation of motor vehicles or used for storage or any other ancillary purpose, and any column supporting the floor, must—
 - (i) have an FRL of at least 30/30/30; or
 - (ii) have a *fire-protective covering* on the underside of the floor including beams incorporated in it and around the column, if the floor or column is *combustible* or of metal; and
- (f) in a Class 9c building a floor above a space for the accommodation of motor vehicles or used for storage or any other ancillary purpose, and any column supporting the floor, must—
 - (i) have an FRL of at least 30/30/30; or
 - (ii) have a *fire-protective covering* on the underside of the floor including beams incorporated in it and around the column, if the floor or column is *combustible* or of metal.

Table 5 Type C construction: FRL of building elements

Building element	Class of building—FRL: (in minutes)			
	<i>Structural adequacy/Integrity/Insulation</i>			
	2, 3 or 4 part	5, 7a or 9	6	7b or 8
EXTERNAL WALL (including any column and other building element incorporated within it) or other external building element, where the distance from any <i>fire-source feature</i> to which it is exposed is—				
Less than 1.5 m	90/ 90/ 90	90/ 90/ 90	90/ 90/ 90	90/ 90/ 90
1.5 to less than 3 m	-/-/-	60/ 60/ 60	60/ 60/ 60	60/ 60/ 60
3 m or more	-/-/-	-/-/-	-/-/-	-/-/-
EXTERNAL COLUMN not incorporated in an <i>external wall</i> , where the distance from any <i>fire-source feature</i> to which it is exposed is—				
Less than 1.5 m	90/-/-	90/-/-	90/-/-	90/-/-
1.5 to less than 3 m	-/-/-	60/-/-	60/-/-	60/-/-
3 m or more	-/-/-	-/-/-	-/-/-	-/-/-
COMMON WALLS and FIRE WALLS—	90/ 90/ 90	90/ 90/ 90	90/ 90/ 90	90/ 90/ 90
INTERNAL WALLS—				
Bounding <i>public corridors</i> , public lobbies and the like—	60/ 60/ 60	-/-/-	-/-/-	-/-/-
Between or bounding <i>sole-occupancy units</i> —	60/ 60/ 60	-/-/-	-/-/-	-/-/-
Bounding a stair if <i>required</i> to be rated—	60/ 60/ 60	60/ 60/ 60	60/ 60/ 60	60/ 60/ 60
ROOFS	-/-/-	-/-/-	-/-/-	-/-/-

5.2 Carparks

- (a) Notwithstanding [Clause 5.1](#), a *carpark* may comply with [Table 5.2](#) if it is an *open-deck carpark* or is protected with a sprinkler system (other than a FPAA101D or FPAA101H system) complying with [Specification E1.5](#) and is—
 - (i) a separate building; or
 - (ii) a part of a building, and if occupying only part of a *storey*, is separated from the remaining part by a *fire wall*.
- (b) For the purposes of this Clause, a *carpark*—
 - (i) includes—

Fire resistance

Deemed-to-Satisfy Provisions

- (A) an administration area associated with the functioning of the *carpark*; and
- (B) where the *carpark* is sprinklered, is associated with a Class 2 or 3 building and provides carparking for separate *sole-occupancy units*, each carparking area with an area not greater than 10% of its *floor area* for purposes ancillary to the *sole-occupancy units*; but
 - (ii) excludes—
 - (A) except for (b)(i), any area of another classification, or other part of a Class 7 building not used for carparking; and
 - (B) a building or part of a building specifically intended for the parking of trucks, buses, vans and the like.

Table 5.2 Requirements for carparks

Building element	FRL (not less than) <i>Structural adequacy/Integrity/Insulation</i> ESAM (not greater than)
Wall	
(a) <i>external wall</i>	
(i) less than 1.5 m from a <i>fire-source feature</i> to which it is exposed:	
<i>Loadbearing</i>	60/60/60
<i>Non-loadbearing</i>	–/60/60
(ii) 1.5 m or more from a <i>fire-source feature</i> to which it is exposed	–/–/–
(b) <i>internal wall</i>	–/–/–
(c) <i>fire wall</i>	
(i) from the direction used as a <i>carpark</i>	60/60/60
(ii) from the direction not used as a <i>carpark</i>	90/90/90
Column	
(a) steel column less than 1.5 m from a <i>fire-source feature</i>	60/–/– or 26 m ² /tonne
(b) any other column less than 1.5 m from a <i>fire-source feature</i>	60/–/–
(c) any other column not covered by (a) or (b)	–/–/–
Beam	
(a) less than 1.5 m from a <i>fire-source feature</i>	
(i) steel floor beam in continuous contact with a concrete floor slab	60/–/– or 30 m ² /tonne
(ii) any other beam	60/–/–
(b) 1.5 m or more from a <i>fire-source feature</i>	–/–/–
Roof, floor slab and vehicle ramp	–/–/–

Note to Table 5.2: ESAM means the ratio of exposed surface area to mass per unit length.

Specification C1.8

Structural tests for lightweight construction

*Deemed-to-Satisfy Provisions***1. Scope**

This Specification describes tests to be applied to and criteria to be satisfied by a wall system of *lightweight construction*.

2. Application

A wall system need not be tested in accordance with this Specification for static pressure or impact if it is designed and constructed in accordance with the *Deemed-to-Satisfy Provisions* of Section B to resist the appropriate pressures and impacts defined in this Specification.

3. Tests**3.1 Walls of certain Class 9b buildings**

Lightweight construction forming—

- (a) a wall of a lift *shaft* and stair *shaft*; and
- (b) an *external* and *internal wall* bounding a *public corridor*, public lobby or the like, including a *fire-isolated* and non *fire-isolated passageway* or *ramp*, in a spectator stand, sports stadium, cinema or theatre, railway or bus station or airport terminal, must be subjected to the following tests and must fulfil the following criteria:
 - (i) The materials tests of [Clause 5\(a\)](#) and the criteria of [Clause 6\(a\)](#).
 - (ii) A static test by the imposition of a uniformly distributed load of 1.0 kPa (or its equivalent) in accordance with [Clause 5\(b\)](#) and the damage and deflection criteria of [Clauses 6\(b\)](#) and [\(c\)](#) respectively.
 - (iii) A dynamic test by the fall of the impact bag through a height of 350 mm in accordance with [Clause 5\(c\)](#) and the damage and deflection criteria of [Clauses 6\(b\)](#) and [\(d\)](#) respectively.
 - (iv) The surface indentation test of [Clause 5\(d\)](#) and the surface indentation criterion of [Clause 6\(e\)](#).

3.2 Walls of shafts and fire-isolated exits generally

A wall of *lightweight construction* that is *required* to be *fire-resisting* and which bounds a lift *shaft*, stair *shaft*, or service *shaft*, *fire-isolated passageway* or *fire-isolated ramp* must be subjected to the following tests and must fulfil the following criteria:

- (a) The materials tests of [Clause 5\(a\)](#) and the criteria of [Clause 6\(a\)](#).
- (b) A static test by the imposition of a uniformly distributed load of 0.35 kPa (or its equivalent) in accordance with [Clause 5\(b\)](#) and the damage and deflection criteria of [Clauses 6\(b\)](#) and [\(c\)](#) respectively.
- (c) A dynamic test by the fall of the impact bag through a height of 150 mm in accordance with [Clause 5\(c\)](#) and the damage and deflection criteria of [Clauses 6\(b\)](#) and [\(d\)](#) respectively.
- (d) The surface indentation test of [Clause 5\(d\)](#) and the surface indentation criterion of [Clause 6\(e\)](#).

3.3 Additional requirements for lift shafts

- (a) In addition to the requirements of [Clauses 3.1](#) and [3.2](#), a wall system for use in a lift *shaft* that is *required* to be *fire-resisting* must be subjected to dynamic test by the imposition of—
 - (i) where the lift car speed is 7 m/s or less — 10^6 cycles of a uniformly distributed load between 0 and 0.2 kPa (or its equivalent); or
 - (ii) where the lift car speed is greater than 7 m/s — 10^6 cycles of a uniformly distributed load between 0 and 0.35 kPa (or its equivalent) in accordance with [Clause 5\(e\)](#) and must fulfil the damage criteria of [Clause 6\(b\)](#).
- (b) The wall system must be subjected to the static test in accordance with [Clause 3.2\(b\)](#) after the successful

Fire resistance

Deemed-to-Satisfy Provisions

conclusion of the dynamic test specified in (a).

3.4 Walls generally

An *external* and *internal wall* of *lightweight construction* that is *required* to be *fire-resisting*, other than one covered by [Clauses 3.1, 3.2](#) or [3.3](#), must be subjected to the following tests and must fulfil the following criteria:

- (a) The materials tests of [Clause 5\(a\)](#) and the criteria of [Clause 6\(a\)](#).
- (b) A static test by the imposition of a uniformly distributed load of 0.25 kPa (or its equivalent) in accordance with [Clause 5\(b\)](#) and the damage and deflection criteria of [Clauses 6\(b\)](#) and (c) respectively.
- (c) A dynamic test by fall of the impact bag through a height of 100 mm in accordance with [Clause 5\(c\)](#) and the damage and deflection criteria of [Clauses 6\(b\)](#) and (d) respectively.
- (d) The surface indentation test of [Clause 5\(d\)](#) and the surface indentation criterion of [Clause 6\(e\)](#).

4. Test specimens

4.1 General

Testing must be carried out on either—

- (a) construction in-situ; or
- (b) a laboratory specimen of the construction.

4.2 Testing in-situ

If testing is carried out in-situ, it must be done on that part of the construction least likely, because of the particular combination of the height of the walls, the support conditions and other aspects of the construction, to resist the loads.

4.3 Testing of specimens

If a laboratory specimen is tested, the specimen must span only in the direction corresponding to the height of the wall and testing must be done in accordance with either (a) or (b) below:

- (a) The test specimen—
 - (i) height (or length, if the specimen is tested horizontally) must be identical with the height between supports in the actual construction; and
 - (ii) must be supported at the top and bottom (or at each end if tested horizontally) by components identical with, and in a manner identical with, the actual construction.
- (b) If the distance between supports of the actual construction is more than 3 m, then a smaller specimen may be tested but—
 - (i) the distance between supports must be not less than 3 m; and
 - (ii) forces, reactions and support conditions must be modelled so as to reproduce the behaviour of the actual construction if it were tested in-situ.

5. Test methods

Tests must be carried out in accordance with the following:

- (a) **Material tests** — The methods specified for the constituent materials of the construction of the standards adopted by reference in the BCA.
- (b) **For resistance to static pressure** — The provisions for testing walls under transverse load in ASTM E72-15, except that—
 - (i) support conditions must be as specified in [Clause 4.3](#); and
 - (ii) equivalent load shall mean the quarter-point load that produces the same deflection or central moment as appropriate; and
 - (iii) the timber species nominated in that standard may be substituted with a different species.

Fire resistance

Deemed-to-Satisfy Provisions

- (c) **For resistance to impact** — The provisions for testing wall systems in ASTM E695-03, except that—
 - (i) the point of impact must be set 1.5 m above finished floor level or 1.5 m above the part of the specimen that corresponds to finished floor level; and
 - (ii) the impact bag must be not less than 225 mm in diameter and not more than 260 mm in diameter and have a mass of not less than 27.2 or more than 27.3 kg; and
 - (iii) the mass must be achieved by putting loose, dry sand into the bag and must be adjusted before each series of impact tests; and
 - (iv) where the impact bag and suspension cannot be vertical at the instant of impact on a curved surface or an inclined surface, the height of drop is the net height at the point of impact.
- (d) **For resistance to surface indentation** — The test for resistance to surface indentation must be carried out at three points on the surface of an undamaged sample sheet as follows:
 - (i) A steel ball of 10 mm diameter with a load of 150 N must be placed gently on the surface of the sheet and allowed to remain in position for 5 minutes.
 - (ii) The ball and load must then be removed and the diameter of each impression of the ball on the surface measured.
- (e) **For resistance of lift shaft construction to repetitive load** — As for 5(b) except that—
 - (i) it is sufficient to test one specimen with the pressure applied from the side of the construction on which the lift will operate; and
 - (ii) the load must be applied dynamically at a frequency not less than 1 Hz and not more than 3 Hz; and
 - (iii) equivalent load shall mean the quarter-point load that produces the same central moment as the distributed load.

6. Criteria for compliance

The wall system or the specimen of it must fulfil the following criteria:

- (a) **Materials** — Materials must comply with the applicable standard adopted by reference in the BCA.
- (b) **Damage** — There must be no crack, penetration or permanent surface-deformation to a depth of more than 0.5 mm or any other non-elastic deformation or fastener failure.
- (c) **Deflection — Static pressure** — Under static pressure the deflection must not be more than—
 - (i) 1/240th of the height between supports; or
 - (ii) for construction other than a lift *shaft* — 30 mm; or
 - (iii) for a lift *shaft* — 20 mm.
- (d) **Deflection — Impact** — Under impact the instantaneous deflection must not be more than—
 - (i) 1/120th of the height of the wall between supports; or
 - (ii) for construction other than a lift *shaft* — 30 mm; or
 - (iii) for a lift *shaft* — 20 mm.
- (e) **Surface indentation** — No impression must be more than 5 mm in diameter.

Specification C1.10

Fire hazard properties

Deemed-to-Satisfy Provisions

1. Scope

This Specification sets out requirements in relation to the *fire hazard properties* of linings, materials and assemblies in Class 2 to 9 buildings as set out in [Table 1](#).

2. Application

Linings, materials and assemblies in Class 2 to 9 buildings must comply with the appropriate requirement described in [Table 1](#).

Table 1 Fire hazard property requirements

Lining, material or assembly	Requirement
Floor linings and floor coverings	Clause 3
Wall linings and ceiling linings	Clause 4
Air-handling ductwork	Clause 5
Lift cars	Clause 6
In fire control rooms subject to Specification C1.8 and fire isolated <i>exits</i>	Clause 7
In Class 9b buildings used as a theatre, public hall or the like— (a) fixed seating in the audience area or auditorium; and (b) a proscenium curtain <i>required</i> by Specification H1.3	Clause 7
Escalators, moving walkways and non- <i>required</i> non- <i>fire-isolated stairways</i> or pedestrian ramps subject to Specification D1.12	Clause 7
<i>Sarking-type material</i>	Clause 7
Attachments to internal floors, walls and ceilings	Clause 7
Other materials including insulation	Clause 7

3. Floor linings and floor coverings

A floor lining or floor covering must have—

- (a) a *critical radiant flux* not less than that listed in [Table 2](#); and
- (b) in a building not protected by a sprinkler system (other than a FPAA101D or FPAA101H system) complying with [Specification E1.5](#), a maximum *smoke development rate* of 750 percent-minutes; and
- (c) a *group number* complying with [Clause 6\(b\)](#), for any portion of the floor covering that is continued more than 150 mm up a wall.

Table 2 Critical radiant flux (CHF in kW/m²) of floor linings and floor coverings

Class of building	Building not fitted with a sprinkler system (other than a FPAA101D or FPAA101H system) complying with Specification E1.5	Building fitted with a sprinkler system (other than a FPAA101D or FPAA101H system) complying with Specification E1.5	Fire-isolated <i>exits</i> and fire control rooms
Class 2, 3, 5, 6, 7, 8 or 9b, excluding— (i) Class 3 accommodation for the aged; and (ii) Class 9b as specified below	2.2 kW/m ²	1.2 kW/m ²	2.2 kW/m ²
Class 3	4.5 kW/m ²	2.2 kW/m ²	4.5 kW/m ²

Fire resistance

Deemed-to-Satisfy Provisions

Class of building	Building not fitted with a sprinkler system (other than a FPAA101D or FPAA101H system) complying with Specification E1.5	Building fitted with a sprinkler system (other than a FPAA101D or FPAA101H system) complying with Specification E1.5	Fire-isolated <i>exits</i> and fire control rooms
Accommodation for the aged			
Class 9a <i>Patient care areas</i>	4.5 kW/m ²	2.2 kW/m ²	4.5 kW/m ²
Class 9a Areas other than <i>patient care areas</i>	2.2 kW/m ²	1.2 kW/m ²	4.5 kW/m ²
Class 9b auditorium or audience seating area used mainly for indoor swimming or ice skating	1.2 kW/m ²	1.2 kW/m ²	2.2 kW/m ²
Class 9b auditorium or audience seating area used mainly for— other sports or multi-purpose functions.	2.2 kW/m ²	1.2 kW/m ²	2.2 kW/m ²
Class 9c <i>resident use areas.</i>	N/A	2.2 kW/m ²	4.5 kW/m ²
Class 9c Areas other than <i>resident use areas.</i>	N/A	1.2 kW/m ²	4.5 kW/m ²

4. Wall and ceiling linings

- (a) A wall or ceiling lining system must comply with the *group number* specified in [Table 3](#) and for buildings not fitted with a sprinkler system (other than a FPAA101D or FPAA101H system) complying with [Specification E1.5](#) have—
- (i) a *smoke growth rate index* not more than 100; or
 - (ii) an *average specific extinction area* less than 250 m²/kg.
- (b) A *group number* of a wall or ceiling lining and the *smoke growth rate index* or *average specific extinction area* must be determined in accordance with AS 5637.1.

Table 3 Wall and ceiling lining materials (material groups permitted)

Class of building	Fire-isolated <i>exits</i> and fire control rooms	Public corridors	Specific areas	Other areas
Class 2 or 3, Unsprinklered Excluding accommodation for the aged, people with disabilities, and children	Walls: 1 Ceilings: 1	Walls: 1, 2 Ceilings: 1, 2	Walls: 1, 2, 3 Ceilings: 1, 2, 3	Walls: 1, 2, 3 Ceilings: 1, 2, 3
Class 2 or 3, Sprinklered Excluding accommodation for the aged, people with disabilities, and children	Walls: 1 Ceilings: 1	Walls: 1, 2, 3 Ceilings: 1, 2, 3	Walls: 1, 2, 3 Ceilings: 1, 2, 3	Walls: 1, 2, 3 Ceilings: 1, 2, 3
Class 3 or 9a, Unsprinklered Accommodation for the aged, people with a disability, children and <i>health-care buildings</i>	Walls: 1 Ceilings: 1	Walls: 1 Ceilings: 1	Walls: 1, 2 Ceilings: 1, 2	Walls: 1, 2, 3 Ceilings: 1, 2, 3
Class 3 or 9a, Sprinklered Accommodation for the aged, people with a disability, children and <i>health-care buildings</i>	Walls: 1 Ceilings: 1	Walls: 1, 2 Ceilings: 1, 2	Walls: 1, 2, 3 Ceilings: 1, 2, 3	Walls: 1, 2, 3 Ceilings: 1, 2, 3
Class 5, 6, 7, 8 or 9b <i>schools</i> , Unsprinklered	Walls: 1 Ceilings: 1	Walls: 1, 2 Ceilings: 1, 2	Walls: 1, 2, 3 Ceilings: 1, 2	Walls: 1, 2, 3 Ceilings: 1, 2,

Fire resistance

Deemed-to-Satisfy Provisions

Class of building	Fire-isolated exits and fire control rooms	Public corridors	Specific areas	Other areas
				3
Class 5, 6, 7, 8 or 9b <i>schools</i> , Sprinklered	Walls: 1 Ceilings: 1	Walls: 1, 2, 3 Ceilings: 1, 2, 3	Walls: 1, 2, 3 Ceilings: 1, 2, 3	Walls: 1, 2, 3 Ceilings: 1, 2, 3
Class 9b other than <i>schools</i> , Unsprinklered	Walls: 1 Ceilings: 1	Walls: 1 Ceilings: 1	Walls: 1, 2 Ceilings: 1, 2	Walls: 1, 2, 3 Ceilings: 1, 2, 3
Class 9b other than <i>schools</i> , Sprinklered	Walls: 1 Ceilings: 1	Walls: 1, 2 Ceilings: 1, 2	Walls: 1, 2, 3 Ceilings: 1, 2, 3	Walls: 1, 2, 3 Ceilings: 1, 2, 3
Class 9c, Sprinklered	Walls: 1 Ceilings: 1	Walls: 1, 2 Ceilings: 1, 2	Walls: 1, 2, 3 Ceilings: 1, 2, 3	Walls: 1, 2, 3 Ceilings: 1, 2, 3

Notes to Table 3:

1. “Sprinklered” means a building fitted with a sprinkler system (other than a FPAA101D or FPAA101H system) complying with [Specification E1.5](#).
2. “Specific areas” means within—
 - a. for Class 2 and 3 buildings, a *sole-occupancy unit*; and
 - b. for Class 5 buildings, open plan offices with a minimum floor dimension/floor to ceiling height ratio > 5; and
 - c. for Class 6 buildings, shops or other building with a minimum floor dimension/floor to ceiling height ratio > 5; and
 - d. for Class 9a *health-care buildings*, *patient care areas*; and
 - e. for Class 9b theatres and halls, etc, an auditorium; and
 - f. for Class 9b *schools*, a classroom; and
 - g. for Class 9c buildings, *resident use area*.

5. Air-handling ductwork

Rigid and flexible ductwork in a Class 2 to 9 building must comply with the *fire hazard properties* set out in AS 4254.1 and AS 4254.2.

6. Lift cars

Materials used as—

- (a) floor linings and floor coverings must have a *critical radiant flux* not less than 2.2; and
- (b) wall and ceiling linings must be a Group 1 material or a Group 2 material in accordance with AS 5637.1.

7. Other materials

NSW Spec C1.10 NSW 7

Materials and assemblies in a Class 2 to 9 building not included in [Clauses 3, 4, 5 or 6](#) must not exceed the indices set out in [Table 4](#).

Table 4 Other materials

Material or assembly location	<i>Flammability Index</i>	<i>Spread-of-Flame Index</i>	<i>Smoke-Developed Index</i>
Fire control rooms subject to Specification E1.8 and fire-isolated <i>exits</i> , other than a <i>sarking-type material</i> used in a	N/A	0	2

Fire resistance

Deemed-to-Satisfy Provisions

Material or assembly location	Flammability Index	Spread-of-Flame Index	Smoke-Developed Index
ceiling or used as an attachment or part of an attachment to a building element. <i>Note 1</i>			
Class 9b buildings used as a theatre, public hall or the like: Any part of fixed seating in the audience area or auditorium.	N/A	0	5
Class 9b buildings used as a theatre, public hall or the like: A proscenium curtain <i>required</i> by <i>Specification H1.3</i> .	N/A	0	3
Escalators, moving walkways or non- <i>required</i> non- <i>fire-isolated stairways</i> or pedestrian ramps subject to <i>Specification D1.12</i> .	N/A	0	5
<i>Sarking-type material</i> : In a fire control room subject to <i>Specification E1.8</i> or a fire-isolated <i>exit</i> or fire control room used in the form of an exposed wall or ceiling.	0	N/A	N/A
<i>Sarking-type material</i> : In other locations. <i>Note 2</i>	5	N/A	N/A
Other materials or locations and insulation materials other than <i>sarking-type materials</i> . <i>Notes 2 and 3</i>	N/A	9	8 if the <i>Spread-of-Flame Index</i> is more than 5

Notes to Table 4:

1. In a fire control room or *fire-isolated stairway*, a material used as an attachment or part of an attachment to a building element must, if *combustible*, be attached directly to a *non-combustible* substrate and not exceed 1 mm finished thickness.
2. A material, other than one located within a fire-isolated *exit* or fire control room, may be covered on all faces by concrete or masonry not less than 50 mm thick, as an alternative to meeting the specified indices.
3. In the case of a composite member or assembly, the member or assembly must be constructed so that when assembled as proposed in a building—
 - a. any material which does not comply with this Table is protected on all sides and edges from exposure to the air; and
 - b. the member or assembly, when tested in accordance with *Schedule 6*, has a *Spread-of-Flame Index* and a *Smoke-Developed Index* not exceeding those prescribed in this Table; and
 - c. the member or assembly retains the protection in position so that it prevents ignition of the material and continues to screen it from access to free air for a period of not less than 10 minutes.

Specification C1.11

Performance of external walls in fire

Deemed-to-Satisfy Provisions

1. Scope

This Specification contains measures to minimise, in the event of fire, the likelihood of *external walls* covered by [Clause 2](#) collapsing outwards as complete panels and the likelihood of panels separating from supporting members.

2. Application

This Specification applies to buildings having a *rise in storeys* of not more than 2 with concrete *external walls* that could collapse as complete panels (e.g. tilt-up and precast concrete) which—

- (a) consist of either single or multiple panels attached by steel connections to lateral supporting members; and
- (b) depend on those connections to resist outward movement of the panels relative to the supporting members; and
- (c) have height to thickness ratio not greater than 50.

3. General requirements for external wall panels

- (a) Cast-in inserts and fixings must be anchored into the panel with welded bars or be fixed to the panel reinforcement.
- (b) Cast-in inserts for top connections and fixings acting together must be able to resist an ultimate load of two times the larger of the forces *required* to develop—
 - (i) the ultimate bending moment capacity of the panel at its base; or
 - (ii) the overturning moment at the base of the panel arising from an outwards lateral displacement at the top of the panel equal to one tenth of the panel height.
- (c) Top connections of the panel exposed to fire, such as clips and drilled-in inserts, acting together must be able to resist an ultimate load of six times the larger of the forces *required* to develop the moment specified in [\(b\)\(i\)](#) or [\(ii\)](#).

Note:

The increased forces specified by use of the multiplier of two or six in [\(b\)](#) and [\(c\)](#) above are to take account of the lower strength of the connections and members at the higher than ambient temperatures expected in a fire.

- (d) Lateral supporting members and their connections must be designed to resist the connection forces specified in [\(b\)](#) and [\(c\)](#) and in the case of an eaves tie member the force in the member must be determined assuming that it deforms in a manner compatible with the lateral displacement of the wall panels, and that it acts in tension only.
- (e) *External wall* panels that span vertically must have at least two upper connections per panel to the supporting member, except that where a number of panels are designed to act as one unit, (e.g. tongue and groove hollow-core panels), only two upper connections are *required* for each unit.
- (f) *External wall* panels that span horizontally between columns must have at least two connections at each column.
- (g) Connections providing lateral support to a panel must be designed to remain engaged to the supported panel both before and during a fire.

4. Additional requirements for vertically spanning external wall panels adjacent to columns

- (a) Where vertically spanning *external wall* panels are located adjacent to columns, connections to the panels must be located and/or detailed to minimise forces that may develop between the panels and columns arising from the restraint of differential displacement.
- (b) The requirements of [\(a\)](#) are satisfied by—
 - (i) detailing the connections and/or the supporting member to sustain a relative outward displacement of [\(d\)](#)

Fire resistance

Deemed-to-Satisfy Provisions

between the panels and columns at the connection height where $d(m)$ is calculated as—

- (A) the square of the connection height (m) divided by one hundred and twenty-five, when the connection height is less than 5 m; or
 - (B) the connection height (m) divided by twenty-five, when the connection height (m) is greater than or equal to 5 m; or
- (ii) in situations where an eaves tie member is used to provide lateral support to *external wall* panels, the tie member is connected to the panels no closer than a distance (s) from the column where $s(m)$ is taken as one quarter of the panel height (m).

Specification C1.13

Cavity barriers for fire-protected timber

Deemed-to-Satisfy Provisions

1. Scope

This Specification sets out requirements for cavity barriers in *fire-protected timber* construction.

2. Requirements

- (a) Cavity barriers must be provided in the following locations where *fire-protected timber* is used in any of the listed elements:
 - (i) At concealed cavities adjacent to junctions between *fire-resisting* floor/ceiling assemblies and *fire-resisting* walls.
 - (ii) At concealed cavities adjacent to junctions between *fire-resisting* floor/ceiling assemblies and *fire-resisting* or *non-combustible external walls*.
 - (iii) At concealed cavities adjacent to junctions between *fire-resisting* walls and *fire-resisting* or *non-combustible external walls*.
 - (iv) Around the perimeter of door and window openings in *fire-resisting* construction.
- (b) Cavity barriers must be installed so they are tight fitting and are able to withstand thermal expansion and structural movement without the loss of seal against fire and smoke.
- (c) In addition to cavity barriers *required* by [Clause 2\(a\)](#), horizontal and vertical cavity barriers are to be provided to wall cavities within, around or adjacent to *fire-protected timber* elements as follows:
 - (i) Horizontal cavity barriers — at not more than 5 m centres.
 - (ii) Vertical cavity barriers — at not more than 10 m centres.
- (d) Cavity barriers must—
 - (i) achieve the performance specified in [Table 1](#) based on the highest FRL of the elements they are mounted within or seal against; or
 - (ii) consist of—
 - (A) timber with the minimum thickness specified in [Table 1](#); or
 - (B) polythene-sleeved mineral wool or mineral wool slabs or strips placed under compression to achieve the minimum thickness specified in [Table 1](#).
- (e) Cavity barriers provided around openings may be formed by the window or door frame if—
 - (i) the frame is constructed of steel or timber with the minimum thickness specified in [Table 1](#) for timber; and
 - (ii) the frame is tightly fitted to rigid construction and mechanically fixed in position.
- (f) The FRL of cavity barriers in *fire-protected timber* construction must be determined in accordance with [Schedule 5](#) applying the criteria for control joint systems specified in Section 10 of AS 1530.4 with the cavity barrier system fitted within an opening between timber members exposed directly to the furnace heating conditions.
- (g) Notwithstanding anything to the contrary in [Schedule 5](#) or AS 1530.4, the test results from (f) may be used when the *fire-protected timber* is constructed from timber having a nominal density at least equal to the tested timber.

Table 1 Cavity barrier requirements

System <i>Required</i> FRL	–/60/60 or –/90/90	–/120/120, –/180/180 or –/240/240
Cavity barrier <i>required</i> FRL	–/45/45	–/60/60
Timber, <i>required</i> minimum thickness	45 mm	60 mm
Mineral wool, <i>required</i> minimum thickness	45 mm	60 mm

Fire resistance

Deemed-to-Satisfy Provisions

Note to Table 1: Minimum thicknesses are to be measured in the direction of heat flow.

Specification C1.13a

Fire-protected timber

1. Scope

This Specification contains requirements for *fire-protected timber* and procedures for determining the time at which the temperature at the interface between the protection system and the timber is exceeded.

2. Requirements

2.1 General requirements

- (a) *Fire-protected timber* must—
 - (i) utilise a *non-combustible fire-protective covering* fixed in accordance with the system requirements to achieve an FRL not less than that *required* for the building element; and
 - (ii) have a *non-combustible fire-protective covering* fixed in accordance with system requirements—
 - (A) to achieve a resistance to the incipient spread of fire of not less than 45 minutes when tested in accordance with—
 - (aa) for horizontal elements — Section 4 of AS 1530.4; and
 - (bb) for other elements — the relevant test procedures from Section 4 of AS 1530.4 applied to the element lining; or
 - (B) which consists of not less than 2 layers of 13 mm thick, fire-protective grade plasterboard.
- (b) For the purposes of (a), the *non-combustible fire-protective covering* provided under (a)(ii) may form all or part of the *non-combustible fire-protective covering* provided under (a)(i).

2.2 Massive timber

- (a) *Fire-protected timber*, where the timber is *massive timber*, need not comply with Clause 2.1 if the *fire-protected timber*—
 - (i) utilises a *non-combustible fire-protective covering* fixed in accordance with system requirements to achieve an FRL not less than that *required* for the building element; and
 - (ii) has a *non-combustible fire-protective covering* fixed in accordance with system requirements—
 - (A) so as the temperature at the interface between the protection system and the timber does not exceed 300°C during a fire resistance test performed in accordance with Clause 3 for the application and periods listed in Table 1; or
 - (B) not less than that specified by Table 1; and
 - (iii) has either—
 - (A) any cavity —
 - (aa) between the surface of the timber and the *fire-protective covering*; or
 - (bb) between timber elements within the *fire-protective covering*, filled with *non-combustible insulation*; or
 - (B) no cavity—
 - (aa) between the surface of the timber and the *fire-protective covering*; or
 - (bb) between timber members within the *fire-protective covering*.
- (b) For the purposes of (a), the *non-combustible fire-protective covering* provided under (a)(ii) may form all or part of the *non-combustible fire-protective covering* provided under (a)(i).

Fire resistance

Table 1 Interface temperature and minimum fire protective grade plasterboard thickness

Application	Time – without timber interface exceeding 300°C (mins)	Minimum thickness of fire-grade plasterboard (mm)
Inside a <i>fire-isolated stairway</i> or lift shaft	20	13
<i>External walls</i> within 1 m of an allotment boundary or 2 m of a building on the same allotment	45	2 x 13
All other applications	30	16

3. Determination of time the timber interface temperature exceeds 300°C for timber at least 75 mm thick

Determination of time the timber interface temperature exceeds 300°C for timber at least 75 mm thick

3.1 Form of test

- (a) Tests must be carried out in accordance with the *Standard Fire Test*, or an equivalent or more severe test, on the timber element with the proposed *non-combustible* coverings fixed in a representative manner, with the time the timber interface temperatures exceeded 300°C confirmed in a report from an *Accredited Testing Laboratory*.
- (b) If a fire protection system incorporates joints, the test specimens must incorporate representative joints.
- (c) Interface temperatures must be measured over the following features by a minimum of two thermocouples:
 - (i) At joint positions in the protection systems.
 - (ii) At least 200 mm from any joint.
 - (iii) At service penetrations.
 - (iv) At any other locations where, in the opinion of the *Accredited Testing Laboratory*, the interface temperature may be higher than the above positions.
- (d) The temperatures must be measured in accordance with Appendix C1 and Section 2 of AS 1530.4 as appropriate.

3.2 Smaller specimen permitted

An *Accredited Testing Laboratory* may carry out the test specified in [Clause 3.1](#) at pilot scale provided—

- (a) a specimen (which must be not less than 1000 mm x 1000 mm) adequately represents the proposed construction in the building; and
- (b) the fire resistance of the specimen has already been determined in a full scale test performed in accordance with AS 1530.4 to demonstrate adequate retention of the fire protection system in conjunction with the timber elements being protected; and
- (c) the results of the test do not apply to construction larger than limits defined by the *Accredited Testing Laboratory* conducting the pilot examination.

3.3 Acceptance criteria

The time the timber interface temperature exceeds 300°C must be taken as the minimum time any of the thermocouples specified in [Clause 3.1](#) exceeded 300°C.

Specification C2.5

Smoke-proof walls in health-care and residential care buildings

*Deemed-to-Satisfy Provisions***1. Scope**

This Specification sets out requirements for the construction of smoke-proof walls in Class 9a *health-care buildings* and Class 9c buildings. Smoke proof walls *required* to have an FRL are to be in accordance with [Clause A5.4](#).

2. Class 9a health-care buildings

Smoke-proof walls *required* by [C2.5](#) in Class 9a *health-care buildings* must comply with the following:

- (a) Be *non-combustible* and extend to the underside of—
 - (i) the floor above; or
 - (ii) a *non-combustible* roof covering; or
 - (iii) a ceiling having a *resistance to the incipient spread of fire* to the space above itself of not less than 60 minutes.
- (b) Not incorporate any glazed areas unless the glass is safety glass as defined in AS 1288.
- (c) Only have doorways which are fitted with smoke doors complying with [Specification C3.4](#).
- (d) Have all openings around penetrations and the junctions of the smoke-proof wall and the remainder of the building stopped with *non-combustible* material to prevent the free passage of smoke.
- (e) Incorporate smoke dampers where air-handling ducts penetrate the wall unless the duct forms part of a smoke hazard management system *required* to continue air movement through the duct during a fire.

3. Class 9c buildings

Smoke-proof walls *required* by [C2.5](#) in Class 9c buildings must comply with the following:

- (a) The wall may be lined on one side only.
- (b) Linings on the wall must be *non-combustible* and extend to the underside of—
 - (i) the floor above; or
 - (ii) a *non-combustible* roof covering; or
 - (iii) a flush plasterboard ceiling lined with 13 mm standard grade plasterboard or a *fire-protective covering*, with all penetrations sealed against the free passage of smoke.
- (c) If plasterboard is used in the lining on a wall, it must be a minimum of 13 mm standard grade plasterboard.
- (d) Not incorporate any glazed areas unless the glass is safety glass as defined in AS 1288.
- (e) Only have doorways which are fitted with smoke doors complying with [Specification C3.4](#).
- (f) Have all openings around penetrations and the junctions of the smoke-proof wall and the remainder of the building stopped with *non-combustible* material to prevent the free passage of smoke.
- (g) Incorporate smoke dampers where air-handling ducts penetrate the wall unless the duct forms part of a smoke hazard management system *required* to continue air movement through the duct during a fire.

4. Doorways in smoke-proof walls

A door *required* by [C2.5](#) or this Specification to be smoke-proof or have an FRL, other than one that serves a *fire compartment* provided with a zone pressurisation system in accordance with AS 1668.1, must provide a smoke reservoir by not extending within 400 mm of the underside of—

- (a) a roof covering; or
- (b) the floor above; or
- (c) an imperforate false ceiling that will prevent the free passage of smoke.

Specification C3.4

Fire doors, smoke doors, fire windows and shutters

Deemed-to-Satisfy Provisions

1. Scope

This Specification sets out requirements for the construction of fire doors, smoke doors, fire *windows* and fire shutters.

2. Fire Doors

A *required* fire door must—

- (a) comply with AS 1905.1; and
- (b) not fail by radiation through any glazed part during the period specified for *integrity* in the *required* FRL.

3. Smoke Doors

3.1 General requirements

Smoke doors must be constructed so that smoke will not pass from one side of the doorway to the other and, if they are glazed, there is minimal danger of a person being injured by accidentally walking into them.

3.2 Construction Deemed-to-Satisfy

A smoke door of one or two leaves satisfies [Clause 3.1](#) if it is constructed as follows:

- (a) The leaves are side-hung to swing—
 - (i) in the direction of egress; or
 - (ii) in both directions.
- (b) The leaves are solid-core and at least 35 mm thick, or are capable of resisting smoke at 200°C for 30 minutes.
- (c) The leaves are fitted with smoke seals.
- (d) (i) The leaves are normally in the closed position; or
 - (ii) (A) The leaves are closed *automatically* with the *automatic* closing operation initiated by smoke detectors, installed in accordance with the relevant provisions of AS 1670.1, located on each side of the doorway not more than 1.5 m horizontal distance from the doorway; and
 - (B) in the event of power failure to the door, the leaves fail-safe in the closed position.
- (e) The leaves return to the fully closed position after each manual opening.
- (f) Any glazing incorporated in the door complies with AS 1288.
- (g) If a glazed panel is capable of being mistaken for an unobstructed *exit*, the presence of the glass must be identified by an opaque mid-height band, mid-rail, crash-bar or other opaque construction.

4. Fire Shutters

A *required* fire shutter must—

- (a) be a shutter that—
 - (i) is identical with a tested prototype that has achieved the *required* FRL; and
 - (ii) is installed in the same manner and in an opening that is not larger than the tested prototype; and
 - (iii) did not have a rise in average temperature on the side remote from the furnace of more than 140 K during the first 30 minutes of the test; or
- (b) be a steel shutter complying with AS 1905.2 if a metallic fire shutter is not prohibited by [C3.5](#).

*Deemed-to-Satisfy Provisions***5. Fire Windows**

A *required* fire *window* must be—

- (a) identical in construction with a prototype that has achieved the *required* FRL; and
- (b) installed in the same manner and in an opening that is not larger than the tested prototype.

Specification C3.15

Penetration of walls, floors and ceilings by services

Deemed-to-Satisfy Provisions

1. Scope

This Specification prescribes materials and methods of installation for services that penetrate walls, floors and ceilings *required* to have an FRL.

2. Application

- (a) This Specification applies to installations permitted under the *Deemed-to-Satisfy Provisions* of the BCA as alternatives to systems that have been demonstrated by test to fulfil the requirements of C3.15(a).
- (b) This Specification does not apply to installations in ceilings *required* to have a *resistance to the incipient spread of fire* nor to the installation of piping that contains or is intended to contain a flammable liquid or gas.

3. Metal pipe systems

- (a) A pipe system comprised entirely of metal (excluding pipe seals or the like) that is not normally filled with liquid must not be located within 100 mm, for a distance of 2 m from the penetration, of any *combustible* building element or a position where *combustible* material may be located, and must be constructed of—
 - (i) copper alloy or stainless steel with a wall thickness of at least 1 mm; or
 - (ii) cast iron or steel (other than stainless steel) with a wall thickness of at least 2 mm.
- (b) An opening for a pipe system comprised entirely of metal (excluding pipe seals or the like) must—
 - (i) be neatly formed, cut or drilled; and
 - (ii) be no closer than 200 mm to any other service penetration; and
 - (iii) accommodate only one pipe.
- (c) A pipe system comprised entirely of metal (excluding pipe seals or the like) must be wrapped but must not be lagged or enclosed in thermal insulation over the length of its penetration of a wall, floor or ceiling unless the lagging or thermal insulation fulfils the requirements of [Clause 7](#).
- (d) The gap between a metal pipe and the wall, floor or ceiling it penetrates must be fire-stopped in accordance with [Clause 7](#).

4. Pipes penetrating sanitary compartments

If a pipe of metal or UPVC penetrates the floor of a *sanitary compartment* in accordance with C3.15(c)(ii)—

- (a) the opening must be neatly formed and no larger than is necessary to accommodate the pipe or fitting; and
- (b) the gap between pipe and floor must be fire-stopped in accordance with [Clause 7](#).

5. Wires and cables

If a wire or cable or cluster of wires or cables penetrates a floor, wall or ceiling—

- (a) the opening must be neatly formed, cut or drilled and no closer than 50 mm to any other service; and
- (b) the opening must be no larger in cross-sectional area than—
 - (i) 2000 mm² if only a single cable is accommodated and the gap between cable and wall, floor or ceiling is no wider than 15 mm; or
 - (ii) 500 mm² in any other case; and
- (c) the gap between the service and the wall, floor or ceiling must be fire-stopped in accordance with [Clause 7](#).

6. Electrical switches and outlets

If an electrical switch, outlet, socket or the like is accommodated in an opening or recess in a wall, floor or ceiling—

Fire resistance

Deemed-to-Satisfy Provisions

- (a) the opening or recess must not—
 - (i) be located opposite any point within 300 mm horizontally or 600 mm vertically of any opening or recess on the opposite side of the wall; or
 - (ii) extend beyond half the thickness of the wall; and
- (b) the gap between the service and the wall, floor or ceiling must be fire-stopped in accordance with [Clause 7](#).

7. Fire-stopping

- (a) **Material:** The material used for the fire-stopping of service penetrations must be concrete, high-temperature mineral fibre, high-temperature ceramic fibre or other material that does not flow at a temperature below 1120°C when tested in accordance with ISO 540, and must have—
 - (i) demonstrated in a system tested in accordance with [C3.15\(a\)](#) that it does not impair the *fire-resisting* performance of the building element in which it is installed; or
 - (ii) demonstrated in a test in accordance with [\(e\)](#) that it does not impair the *fire-resisting* performance of the test slab.
- (b) **Installation:** Fire-stopping material must be packed into the gap between the service and wall, floor or ceiling in a manner, and compressed to the same degree, as adopted for testing under [Clause 7\(a\)\(i\)](#) or [\(ii\)](#).
- (c) **Hollow construction:** If a pipe penetrates a hollow wall (such as a stud wall, a cavity wall or a wall of hollow blockwork) or a hollow floor/ceiling system, the cavity must be so framed and packed with fire-stopping material that is—
 - (i) installed in accordance with [Clause 7\(b\)](#) to a thickness of 25 mm all round the service for the full length of the penetration; and
 - (ii) restrained, independently of the service, from moving or parting from the surfaces of the service and of the wall, floor or ceiling.
- (d) **Recesses:** If an electrical switch, socket, outlet or the like is accommodated in a recess in a hollow wall or hollow floor/ceiling system—
 - (i) the cavity immediately behind the service must be framed and packed with fire-stopping material in accordance with [Clause 7\(c\)](#); or
 - (ii) the back and sides of the service must be protected with refractory lining board identical with and to the same thickness as that in which the service is installed.
- (e) **Test:** The test to demonstrate compliance of a fire-stopping material with this Specification must be conducted as follows:
 - (i) The test specimen must comprise a concrete slab not less than 1 m square and not more than 100 mm thick, and appropriately reinforced if necessary for *structural adequacy* during manufacture, transport and testing.
 - (ii) The slab must have a hole 50 mm in diameter through the centre and the hole must be packed with the fire-stopping material.
 - (iii) The slab must be conditioned in accordance with AS 1530.4.
 - (iv) Two thermocouples complying with AS 1530.4 must be attached to the upper surface of the packing each about 5 mm from its centre.
 - (v) The slab must be tested on flat generally in accordance with Section 10 of AS 1530.4 and must achieve an FRL of 60/60/60 or as otherwise *required*.

Access and egress

Section D	Access and egress
Part D1	Provision for escape
Part D2	Construction of exits
Part D3	Access for people with a disability

Section D Access and egress

Section D Access and egress

Performance Requirements

- DP1 Access for people with a disability
- DP2 Safe movement to and within a building
- DP3 Fall prevention barriers
- DP4 Exits
- DP5 Fire-isolated exits
- DP6 Paths of travel to exits
- DP7 Evacuation lifts
- DP8 Carparking for people with a disability
- DP9 Communication systems for people with hearing impairment

Verification Methods

- DV1 Wire barriers
- DV2 Access to and within a building
- DV3 Ramp gradient, crossfall, surface profile and slip resistance for ramps used by wheelchairs
- DV4 Fire Safety Verification Method

Part D1 Provision for escape

- D1.0 Deemed-to-Satisfy Provisions
- D1.1 Application of Part
- D1.2 Number of exits required
- D1.3 When fire-isolated stairways and ramps are required
- D1.4 Exit travel distances
- D1.5 Distance between alternative exits
- D1.6 Dimensions of exits and paths of travel to exits
- D1.7 Travel via fire-isolated exits
- D1.8 External stairways or ramps in lieu of fire-isolated exits
- D1.9 Travel by non-fire-isolated stairways or ramps
- D1.10 Discharge from exits
- D1.11 Horizontal exits
- D1.12 Non-required stairways, ramps or escalators
- D1.13 Number of persons accommodated
- D1.14 Measurement of distances
- D1.15 Method of measurement
- D1.16 Plant rooms, lift machine rooms and electricity network substations: concession
- D1.17 Access to lift pits
- D1.18 Egress from early childhood centres

Part D2 Construction of exits

- D2.0 Deemed-to-Satisfy Provisions
- D2.1 Application of Part
- D2.2 Fire-isolated stairways and ramps
- D2.3 Non-fire-isolated stairways and ramps
- D2.4 Separation of rising and descending stair flights
- D2.5 Open access ramps and balconies
- D2.6 Smoke lobbies
- D2.7 Installations in exits and paths of travel
- D2.8 Enclosure of space under stairs and ramps
- D2.9 Width of required stairways and ramps
- D2.10 Pedestrian ramps
- D2.11 Fire-isolated passageways
- D2.12 Roof as open space

- D2.13 Goings and risers
- D2.14 Landings
- D2.15 Thresholds
- D2.16 Barriers to prevent falls
- D2.17 Handrails
- D2.18 Fixed platforms, walkways, stairways and ladders
- D2.19 Doorways and doors
- D2.20 Swinging doors
- D2.21 Operation of latch
- D2.22 Re-entry from fire-isolated exits
- D2.23 Signs on doors
- D2.24 Protection of openable windows
- D2.25 Timber stairways: Concession

Part D3 Access for people with a disability

- D3.0 Deemed-to-Satisfy Provisions
- D3.1 General building access requirements
- D3.2 Access to buildings
- D3.3 Parts of buildings to be accessible
- D3.4 Exemptions
- D3.5 Accessible carparking
- D3.6 Signage
- D3.7 Hearing augmentation
- D3.8 Tactile indicators
- D3.9 Wheelchair seating spaces in Class 9b assembly buildings
- D3.10 Swimming pools
- D3.11 Ramps
- D3.12 Glazing on an accessway

Specification D1.12 Non-required stairways, ramps and escalators

1. Scope
2. Requirements

Specification D3.6 Braille and tactile signs

1. Scope
2. Location of braille and tactile signs
3. Braille and tactile sign specification
4. Luminance contrast
5. Lighting
6. Braille

Specification D3.10 Accessible water entry/exit for swimming pools

1. Scope
2. Fixed or moveable ramp
3. Zero depth entry
4. Platform swimming pool lift
5. Sling-style swimming pool lift
6. Aquatic wheelchair

Section D Access and egress

Performance Requirements

ACT Appendix

DP1 Access for people with a disability

Access must be provided, to the degree necessary, to enable—

- (a) people to—
 - (i) approach the building from the road boundary and from any *accessible* carparking spaces associated with the building; and
 - (ii) approach the building from any *accessible* associated building; and
 - (iii) access work and public spaces, accommodation and facilities for personal hygiene; and
- (b) identification of *accessways* at appropriate locations which are easy to find.

Limitation:

DP1 does not apply to a Class 4 part of a building.

DP2 Safe movement to and within a building

So that people can move safely to and within a building, it must have—

- (a) walking surfaces with safe gradients; and
- (b) any doors installed to avoid the risk of occupants—
 - (i) having their egress impeded; or
 - (ii) being trapped in the building; and
- (c) any stairways and ramps with—
 - (i) slip-resistant walking surfaces on—
 - (A) ramps; and
 - (B) stairway treads or near the edge of the nosing; and
 - (ii) suitable handrails where necessary to assist and provide stability to people using the stairway or ramp; and
 - (iii) suitable landings to avoid undue fatigue; and
 - (iv) landings where a door opens from or onto the stairway or ramp so that the door does not create an obstruction; and
 - (v) in the case of a stairway, suitable safe passage in relation to the nature, volume and frequency of likely usage.

DP3 Fall prevention barriers

Where people could fall—

- (a) 1 m or more—
 - (i) from a floor or roof or through an opening (other than through an openable window) in the *external wall* of a building; or
 - (ii) due to a sudden change of level within or associated with a building; or
- (b) 2 m or more from a floor through an openable window—
 - (i) in a bedroom in a Class 2 or 3 building or a Class 4 part of a building; or
 - (ii) in a Class 9b *early childhood centre*; or
- (c) 4 m or more from a floor through an openable window not covered by (b),

Access and egress

a barrier must be provided which must be—

- (d) continuous and extend for the full extent of the hazard; and
- (e) of a height to protect people from accidentally falling from the floor or roof or through the opening or openable window; and
- (f) constructed to prevent people from falling through the barrier; and
- (g) capable of restricting the passage of children; and
- (h) of strength and rigidity to withstand—
 - (i) the foreseeable impact of people; and
 - (ii) where appropriate, the static pressure of people pressing against it.

Limitations:

DP3 does not apply where such a barrier would be incompatible with the intended use of an area such as a stage, loading dock or the like.

DP3(g) does not apply to—

- (a) *fire-isolated stairways*, *fire-isolated ramps*, and other areas used primarily for emergency purposes, excluding external stairways and external ramps; and
- (b) Class 7 (other than *carparks*) and Class 8 buildings and parts of buildings containing those classes.

DP4 Exits

Exits must be provided from a building to allow occupants to evacuate safely, with their number, location and dimensions being appropriate to—

- (a) the travel distance; and
- (b) the number, mobility and other characteristics of occupants; and
- (c) the function or use of the building; and
- (d) the height of the building; and
- (e) whether the *exit* is from above or below ground level.

DP5 Fire-isolated exits

To protect evacuating occupants from a fire in the building *exits* must be fire-isolated, to the degree necessary, appropriate to—

- (a) the number of *storeys* connected by the *exits*; and
- (b) the *fire safety system* installed in the building; and
- (c) the function or use of the building; and
- (d) the number of *storeys* passed through by the *exits*; and
- (e) *fire brigade* intervention.

DP6 Paths of travel to exits

So that occupants can safely evacuate the building, paths of travel to *exits* must have dimensions appropriate to—

- (a) the number, mobility and other characteristics of occupants; and
- (b) the function or use of the building.

Limitation:

DP6 does not apply to the internal parts of a *sole-occupancy unit* in a Class 2 or 3 building or Class 4 part of a building.

DP7 Evacuation lifts

Where a lift is intended to be used in addition to the *required exits* to assist occupants to evacuate a building safely, the type, number, location and fire-isolation must be appropriate to—

Access and egress

- (a) the travel distance to the lift; and
- (b) the number, mobility and other characteristics of occupants; and
- (c) the function or use of the building; and
- (d) the number of *storeys* connected by the lift; and
- (e) the *fire safety system* installed in the building; and
- (f) the waiting time, travel time and capacity of the lift; and
- (g) the reliability and availability of the lift; and
- (h) the emergency procedures for the building.

DP8 Carparking for people with a disability

Carparking spaces for use by people with a disability must be—

- (a) provided, to the degree necessary, to give equitable access for carparking; and
- (b) designated and easy to find.

Limitation:

DP8 does not apply to a building where—

- (a) a parking service is provided; and
- (b) direct access to any carparking spaces by the general public or occupants is not available.

DP9 Communication systems for people with hearing impairment

An inbuilt communication system for entry, information, entertainment, or for the provision of a service, must be suitable for occupants who are deaf or hearing impaired.

Limitation:

DP9 does not apply to—

- (a) a Class 4 part of a building; or
- (b) an inbuilt communication system used only for emergency warning purposes.

Tas DP10

Verification Methods

DV1 Wire barriers

Compliance with DP3(f) and (g) for wire barriers is verified when the wire barrier passes the test described below:

(a) Application

The test must be carried out on either—

- (i) a prototype of a wire barrier that is identical to that proposed to be installed on-site; or
- (ii) a wire barrier installed on-site.

(b) Test equipment

The test equipment must consist of the following:

- (i) A horizontally suspended 125 mm diameter, 405 mm long cylinder of 1 mm thick steel having a highly polished 105 mm long cone at one end with a 20 mm diameter flat leading edge to which an eye bolt is fixed.
- (ii) A sufficiently flexible horizontal cable with mechanisms capable of applying and measuring a tension of 150 N (or a 15.3 kg weight suspended over a low friction pulley) is to be attached to the eye bolt (see [Figure DV1](#)).
- (iii) A mechanism capable of measuring the tension force applied to each wire.

Access and egress

Figure DV1 Apparatus for testing wire barriers

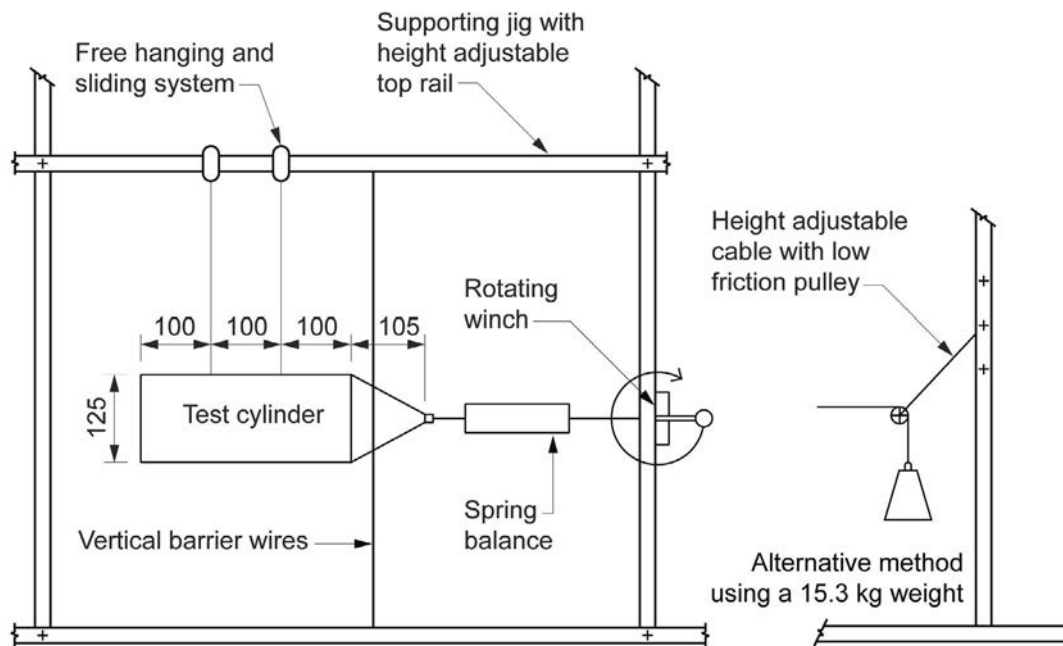

(c) Test procedure

The test procedure must be as follows:

- (i) Tension the wires, within their safe load, to the same tension in all wires and measure the tensions with a strain indicator.
- (ii) For—
 - (A) horizontal or near horizontal wires, position the cone against a pair of wires at the mid-span between supports, then apply the 150 N tension force to the cone; and
 - (B) vertical wires, position the cone against a pair of wires at the mid-span between supporting rails, then apply the 150 N tension force to the cone; and
 - (C) near-vertical wires, position the cone against a pair of wires at the widest opening between the wires, then apply the 150 N tension force to the cone.
- (iii) Attempt to pull the cone through the gap between the wires under the 150 N load, and—
 - (A) increase the tension in the wires and repeat (ii) until such time as the cone will not pull through; or
 - (B) if it does not pull through, reduce the tension in the wires and repeat step (ii); and
- (iv) When the cone is just prevented from pulling through the gap, the wires are at the correct tension in which case the cone is withdrawn and the tension recorded.
- (v) Reduce the tension in the wires and repeat steps (ii) to (iv) twice more, recording the tension in each case after the cone has been removed and then calculate the average of the three tensions as the *required* tension for each wire.
- (vi) For prototype tests of horizontal or near horizontal wires, record the deflection of each wire at the average tension calculated in accordance with (v) when a 2 kg mass is hung at mid-span between supports.

(d) Test report

The test report must include the following information:

- (i) The name and address of the person supervising the test.
- (ii) The test report number.
- (iii) The date of the test.
- (iv) The wire manufacturer's name and address, and specifications of the wires used in the test including the safe

Access and egress

load limit of the wires.

- (v) The construction details of the test specimen, including a description and drawings and details of the components including supports, post or railing spacings and wire spacings.
- (vi) For a prototype test, the *required* tension calculated in accordance with (c)(v).
- (vii) For prototype tests of horizontal or near horizontal wires, the deflection measured in accordance with (c)(vi).

DV2 Access to and within a building

Compliance with DP1, DP2, DP6, EP3.4 and/or FP2.1, for access, is verified when it is determined that the proposed building provides an equivalent level of access as a reference building when using the following process:

- (a) A performance-based design brief is completed to define the following:
 - (i) The occupant profile and *characteristics* based on the type and use of the building.
 - (ii) The appropriate method for determining the level of access.
 - (iii) The appropriate modelling method and tool.
 - (iv) The measurable acceptance criteria.
- (b) Using the appropriate method, the level of access *required* is determined by first modelling a reference building using the relevant *Deemed-to-Satisfy Provisions* of Sections D, E and F and the occupant profile and *characteristics* to determine the—
 - (i) needs of the occupants that the reference building addresses; and
 - (ii) facilities *required* to be accessed by each occupant profile; and
 - (iii) baseline measurable acceptance criteria.
- (c) The proposed building and access solution must be modelled using a modelling method and approach consistent with that used for the reference building, and the same critical features including the following:
 - (i) Occupant profile and *characteristics*.
 - (ii) Building location and orientation.
 - (iii) Locations of all entrances and *exits*.
 - (iv) Locations of facilities important to the solution, including sanitary facilities, lifts, stairwells, etc.
 - (v) The number and range of facilities.
- (d) The proposed solution's level of access is assessed by modelling occupant performance using *characteristics*, whereby the proposed building provides for equivalent access appropriate to the needs of each occupant profile.

DV3 Ramp gradient, crossfall, surface profile and slip resistance for ramps used by wheelchairs

- (a) Compliance with *Performance Requirement DP2*, relating to gradient, crossfall, surface profile and slip resistance of a ramp for the use of wheelchairs is verified when—
 - (i) the ramp has a gradient that is not steeper than 1:8; and
 - (ii) the pushing force required to accelerate a wheelchair and user during ascent is in accordance with (b); and
 - (iii) the required braking force for a wheelchair and user during descent is in accordance with (c); and
 - (iv) the projected ascent time is in accordance with (d); and
 - (v) the ramp crossfall, surface profile and slip resistance is in accordance with (e).
- (b) The pushing force during ascent must be in accordance with the formula:

$$F_p > mg \sin \alpha + C_{\pi 1} N_1 + C_{\pi 2} N_2$$

where—

F_p = the maximum force during ascent, equal to 40 N for ramps required to be usable by the general public; and
 m = the design mass of the wheelchair and wheelchair user, equal to 127 kg for ramps required to be usable by the general public; and

g = the gravitational constant, equal to 9.8 m/s²; and

α = the angle of incline of the ramp; and

$C_{\pi 1}$, $C_{\pi 2}$ = the coefficient of rolling resistance between the wheelchair wheel and ramp surface, for the rear wheels and front wheels respectively; and

N_1 , N_2 = the normal force between the wheelchair wheels and ramp surface, for the rear wheels and front wheels respectively.

- (c) The braking force during descent must be less than 9 N when calculated in accordance with the formula:

$$F_b = mg \sin \alpha - C_{\pi 1} N_1 - C_{\pi 2} N_2$$

where—

F_b = the braking force during descent; and

m = the design mass of the wheelchair and wheelchair user, equal to 127 kg for ramps required to be usable by the general public; and

g = the gravitational constant, equal to 9.8 m/s²; and

α = the angle of incline of the ramp; and

$C_{\pi 1}$, $C_{\pi 2}$ = the coefficient of rolling resistance between the wheelchair wheel and ramp surface, for the rear wheels and front wheels respectively; and

N_1 , N_2 = the normal force between the wheelchair wheels and ramp surface, for the rear wheels and front wheels respectively.

- (d) The time taken to ascend the ramp must be less than 17 s when calculated in accordance with the formula:

$$T = \frac{Lm}{t(F_p - mg \sin \alpha - C_{\pi 1} N_1 - C_{\pi 2} N_2)}$$

where—

T = the time taken to ascend the ramp in seconds; and

L = the length of the ramp in metres; and

m = the design mass of the wheelchair and wheelchair user, equal to 127 kg for ramps required to be usable by the general public; and

t = the time taken for the wheelchair to achieve maximum velocity, equal to 0.8 s; and

F_p = the maximum pushing force during ascent, equal to 40 N for ramps required to be usable by the general public; and

g = the gravitational constant, equal to 9.8 m/s²; and

α = the angle of incline of the ramp; and

$C_{\pi 1}$, $C_{\pi 2}$ = the coefficient of rolling resistance between the wheelchair wheel and ramp surface, for the rear wheels and front wheels respectively; and

N_1 , N_2 = the normal force between the wheelchair wheels and ramp surface, for the rear wheels and front wheels respectively.

- (e) The crossfall must be no steeper than, the surface profile must be no rougher than, and the slip resistance must be no less than, the values nominated in [Table DV3](#) for the gradient of the ramp.

Table DV3 Ramp crossfall, surface profile and slip resistance

Gradient	Crossfall	Surface profile (mm)	Slip resistance
1:14	1:40	2	P4/R11
1:12	1:50	2	P5/R12
1:10	1:100	1	P5/R12
1:8	1:100	0.5	P5/R12

DV4 Fire Safety Verification Method

Compliance with [DP4](#), [DP5](#), [DP6](#) and [DP7](#) is verified when a building is designed in accordance with [Schedule 7](#).

Part D1 Provision for escape

Deemed-to-Satisfy Provisions

D1.0 Deemed-to-Satisfy Provisions

- (a) Where a *Deemed-to-Satisfy Solution* is proposed, *Performance Requirements DP1 to DP6, DP8 and DP9* are satisfied by complying with—
- (i) *D1.1 to D1.17, D2.1 to D2.25 and D3.1 to D3.12*; and
 - (ii) in a building containing an *atrium, Part G3*; and
 - (iii) in a building in an *alpine area, Part G4*; and
 - (iv) for a building containing an *occupiable outdoor area, Part G6*; and
 - (v) for additional requirements for Class 9b buildings, *Part H1*; and
 - (vi) for public transport buildings, *Part H2*; and
 - (vii) for *farm sheds, Part H3*.
- (b) Where a *Performance Solution* is proposed, the relevant *Performance Requirements* must be determined in accordance with *A2.2(3)* and *A2.4(3)* as applicable.
- (c) *Performance Requirement DP7* must be complied with if lifts are to be used to assist occupants to evacuate a building.

Note:

There are no *Deemed-to-Satisfy Provisions* for this *Performance Requirement* in respect of using lifts.

D1.1 Application of Part

The *Deemed-to-Satisfy Provisions* of this Part do not apply to the internal parts of a *sole-occupancy unit* in a Class 2 or 3 building or a Class 4 part of a building.

D1.2 Number of exits required

- (a) **All buildings** — Every building must have at least one *exit* from each *storey*.
- (b) **Class 2 to 8 buildings** — In addition to any *horizontal exit*, not less than 2 *exits* must be provided from the following:
- (i) Each *storey* if the building has an *effective height* of more than 25 m.
 - (ii) A Class 2 or 3 building subject to *C1.5*.

SA D1.2(b)(iii) and *(iv)*

- (c) **Basements** — In addition to any *horizontal exit*, not less than 2 *exits* must be provided from any *storey* if egress from that *storey* involves a vertical rise within the building of more than 1.5 m, unless—
- (i) the *floor area* of the *storey* is not more than 50 m²; and
 - (ii) the distance of travel from any point on the floor to a single *exit* is not more than 20 m.
- (d) **Class 9 buildings** — In addition to any *horizontal exit*, not less than 2 *exits* must be provided from the following:
- (i) Each *storey* if the building has a *rise in storeys* of more than 6 or an *effective height* of more than 25 m.
 - (ii) Any *storey* which includes a *patient care area* in a Class 9a *health-care building*.
 - (iii) Any *storey* that contains sleeping areas in a Class 9c building.
 - (iv) Each *storey* in a Class 9b building used as an *early childhood centre*.
 - (v) Each *storey* in a primary or secondary *school* with a *rise in storeys* of 2 or more.
 - (vi) Any *storey* or *mezzanine* that accommodates more than 50 persons, calculated under *D1.13*.

NSW D1.2(d)(vii)

Access and egress

Deemed-to-Satisfy Provisions

- (e) **Exits from Class 9c buildings and patient care areas in Class 9a health-care buildings** — In a Class 9a *health-care building* and a Class 9c building, at least one *exit* must be provided from every part of a *storey* which has been divided into *fire compartments* in accordance with C2.2 or C2.5.
- (f) **Exits in open spectator stands** — In an *open spectator stand* containing more than one tier of seating, every tier must have not less than 2 stairways or ramps, each forming part of the path of travel to not less than 2 *exits*.
- (g) **Access to exits** — Without passing through another *sole-occupancy unit* every occupant of a *storey* or part of a *storey* must have access to—
 - (i) an *exit*; or
 - (ii) at least 2 *exits* if 2 or more *exits* are *required*.

D1.3 When fire-isolated stairways and ramps are required

- (a) **Class 2 and 3 buildings** — Every stairway or ramp serving as a *required exit* must be fire-isolated unless it connects, passes through or passes by not more than—
 - (i) 3 consecutive *storeys* in a Class 2 building; or
 - (ii) 2 consecutive *storeys* in a Class 3 building, and one extra *storey* of any classification may be included if—
 - (iii) it is only for the accommodation of motor vehicles or for other ancillary purposes; or
 - (iv) the building has a sprinkler system (other than a FPAA101D system) complying with Specification E1.5 installed throughout; or
 - (v) the *required exit* does not provide access to or egress for, and is separated from, the extra *storey* by construction having—
 - (A) an FRL of –/60/60, if non-*loadbearing*; and
 - (B) an FRL of 90/90/90, if *loadbearing*; and
 - (C) no opening that could permit the passage of fire or smoke.
- (b) **Class 5, 6, 7, 8 or 9 buildings** — Every stairway or ramp serving as a *required exit* must be fire-isolated unless—
 - (i) in a Class 9a *health-care building* — it connects, or passes through or passes by not more than 2 consecutive *storeys* in areas other than *patient care areas*; or
 - (ii) it is part of an *open spectator stand*; or
 - (iii) in any other case except in a Class 9c building, it connects, passes through or passes by not more than 2 consecutive *storeys* and one extra *storey* of any classification may be included if—
 - (A) the building has a sprinkler system (other than a FPAA101D system) complying with Specification E1.5 installed throughout; or
 - (B) the *required exit* does not provide access to or egress for, and is separated from, the extra *storey* by construction having—
 - (aa) an FRL of –/60/60, if non-*loadbearing*; and
 - (bb) an FRL of 90/90/90 for Type A construction or 60/60/60 for Type B or C construction, if *loadbearing*; and
 - (cc) no opening that could permit the passage of fire or smoke.

SA D1.3(b)(iv)

D1.4 Exit travel distances

- (a) **Class 2 and 3 buildings**—
 - (i) The entrance doorway of any *sole-occupancy unit* must be not more than—
 - (A) 6 m from an *exit* or from a point from which travel in different directions to 2 *exits* is available; or
 - (B) 20 m from a single *exit* serving the *storey* at the level of egress to a road or *open space*; and

Access and egress

Deemed-to-Satisfy Provisions

- (ii) no point on the floor of a room which is not in a *sole-occupancy unit* must be more than 20 m from an *exit* or from a point at which travel in different directions to 2 *exits* is available.
- (b) **Class 4 parts of a building** — The entrance doorway to any Class 4 part of a building must be not more than 6 m from an *exit* or a point from which travel in different directions to 2 *exits* is available.
- (c) **Class 5, 6, 7, 8 or 9 buildings** — Subject to (d), (e) and (f)—
 - (i) no point on a floor must be more than 20 m from an *exit*, or a point from which travel in different directions to 2 *exits* is available, in which case the maximum distance to one of those *exits* must not exceed 40 m; and
 - (ii) in a Class 5 or 6 building, the distance to a single *exit* serving a *storey* at the level of access to a road or *open space* may be increased to 30 m.

Vic D1.4(d)

- (d) **Class 9a buildings** — In a *patient care area* in a Class 9a building—
 - (i) no point on the floor must be more than 12 m from a point from which travel in different directions to 2 of the *required exits* is available; and
 - (ii) the maximum distance to one of those *exits* must not be more than 30 m from the starting point.
- (e) **Open spectator stands** — The distance of travel to an *exit* in a Class 9b building used as an *open spectator stand* must be not more than 60 m.
- (f) **Assembly buildings** — In a Class 9b building other than a *school* or *early childhood centre*, the distance to one of the *exits* may be 60 m if—
 - (i) the path of travel from the room concerned to that *exit* is through another area which is a corridor, hallway, lobby, ramp or other circulation space; and
 - (ii) the room is smoke-separated from the circulation space by construction having an FRL of not less than 60/60/60 with every doorway in that construction protected by a tight fitting, *self-closing*, solid-core door not less than 35 mm thick; and
 - (iii) the maximum distance of travel does not exceed 40 m within the room and 20 m from the doorway to the room through the circulation space to the *exit*.

SA D1.4(g) and (h)

D1.5 Distance between alternative exits

Exits that are *required* as alternative means of egress must be—

- (a) distributed as uniformly as practicable within or around the *storey* served and in positions where unobstructed access to at least 2 *exits* is readily available from all points on the floor including lift lobby areas; and
- (b) not less than 9 m apart; and
- (c) not more than—
 - (i) in a Class 2 or 3 building — 45 m apart; or
 - (ii) in a Class 9a *health-care building*, if such *required exit* serves a *patient care area* — 45 m apart; or
 - (iii) in all other cases — 60 m apart; and
- (d) located so that alternative paths of travel do not converge such that they become less than 6 m apart.

SA D1.5(e)

D1.6 Dimensions of exits and paths of travel to exits

In a *required exit* or path of travel to an *exit*—

- (a) the unobstructed height throughout must be not less than 2 m, except the unobstructed height of any doorway may be reduced to not less than 1980 mm; and
- (b) the unobstructed width of each *exit* or path of travel to an *exit*, except for doorways, must be not less than—
 - (i) 1 m; or
 - (ii) 1.8 m in a passageway, corridor or ramp normally used for the transportation of patients in beds within a

Access and egress

Deemed-to-Satisfy Provisions

treatment area or *ward area*; and

- (iii) in a *public corridor* in a Class 9c *aged care building*, notwithstanding (c) and (d)—
 - (A) 1.5 m; and
 - (B) 1.8 m for the full width of the doorway, providing access into a *sole-occupancy unit* or communal bathroom; and
- (c) if the *storey, mezzanine* or *open spectator stand* accommodates more than 100 persons but not more than 200 persons, the aggregate unobstructed width, except for doorways, must be not less than—
 - (i) 1 m plus 250 mm for each 25 persons (or part) in excess of 100; or
 - (ii) 1.8 m in a passageway, corridor or ramp normally used for the transportation of patients in beds within a *treatment area* or *ward area*; and
- (d) if the *storey, mezzanine* or *open spectator stand* accommodates more than 200 persons, the aggregate unobstructed width, except for doorways, must be increased to—
 - (i) 2 m plus 500 mm for every 60 persons (or part) in excess of 200 persons if egress involves a change in floor level by a stairway or ramp with a gradient steeper than 1 in 12; or
 - (ii) in any other case, 2 m plus 500 mm for every 75 persons (or part) in excess of 200; and
- (e) in an *open spectator stand* which accommodates more than 2000 persons, the aggregate unobstructed width, except for doorways, must be increased to 17 m plus a width (in metres) equal to the number in excess of 2000 divided by 600; and
- (f) the unobstructed width of a doorway must be not less than—
 - (i) in *patient care areas* through which patients would normally be transported in beds, if the doorway provides access to, or from, a corridor of width—
 - (A) less than 2.2 m — 1200 mm; or
 - (B) 2.2 m or greater — 1070 mm,
 and where the doorway is fitted with two leaves and one leaf is secured in the closed position in accordance with D2.21(b)(v), the other leaf must permit an unobstructed opening not less than 800 mm wide; or
 - (ii) in *patient care areas* in a *horizontal exit* — 1250 mm; or
 - (iii) the unobstructed width of each *exit* provided to comply with (b), (c), (d) or (e), minus 250 mm; or *Vic D1.6(f)(iv)*
 - (iv) in a Class 9c building—
 - (A) 1070 mm where it opens from a *public corridor* to a *sole-occupancy unit*; or
 - (B) 870 mm in other *resident use areas*; or
 - (C) 800 mm in non-*resident use areas*, and where the doorway is fitted with two leaves and one leaf is secured in the closed position in accordance with D2.21(b)(v), the other leaf must permit an unobstructed opening not less than 870 mm wide in *resident use areas* and 800 mm wide in non-*resident use areas*; or
 - (v) in any other case except where it opens to a *sanitary compartment* or bathroom — 750 mm wide; and *NSW D1.6(f)(vi)*
- (g) the unobstructed width of a *required exit* must not diminish in the direction of travel to a road or *open space*, except where the width is increased in accordance with (b)(ii) or (f)(i); and
- (h) the *required* width of a stairway or ramp must—
 - (i) be measured clear of all obstructions such as handrails, projecting parts of barriers and the like; and
 - (ii) extend without interruption, except for ceiling cornices, to a height not less than 2 m vertically above a line along the nosings of the treads or the floor surface of the ramp or landing; and
- (i) to determine the aggregate unobstructed width, the number of persons accommodated must be calculated according to D1.13.

NSW D1.6(j)

Access and egress

Deemed-to-Satisfy Provisions

D1.7 Travel via fire-isolated exits

- (a) A doorway from a room must not open directly into a stairway, passageway or ramp that is *required* to be fire-isolated unless it is from—
- (i) a *public corridor*, public lobby or the like; or
 - (ii) a *sole-occupancy unit* occupying all of a *storey*; or
 - (iii) a *sanitary compartment*, airlock or the like.
- (b) Each *fire-isolated stairway* or *fire-isolated ramp* must provide independent egress from each *storey* served and discharge directly, or by way of its own *fire-isolated passageway*—
- (i) to a road or *open space*; or
 - (ii) to a point—
 - (A) in a *storey* or space, within the confines of the building, that is used only for pedestrian movement, car parking or the like and is open for at least $\frac{2}{3}$ of its perimeter; and
 - (B) from which an unimpeded path of travel, not further than 20 m, is available to a road or *open space*; or
 - (iii) into a covered area that—
 - (A) adjoins a road or *open space*; and
 - (B) is open for at least $\frac{1}{3}$ of its perimeter; and
 - (C) has an unobstructed clear height throughout, including the perimeter openings, of not less than 3 m; and
 - (D) provides an unimpeded path of travel from the point of discharge to the road or *open space* of not more than 6 m.
- (c) Where a path of travel from the point of discharge of a fire-isolated *exit* necessitates passing within 6 m of any part of an *external wall* of the same building, measured horizontally at right angles to the path of travel, that part of the wall must have—
- (i) an FRL of not less than 60/60/60; and
 - (ii) any openings protected internally in accordance with C3.4, for a distance of 3 m above or below, as appropriate, the level of the path of travel, or for the height of the wall, whichever is the lesser.
- (d) If more than 2 access doorways, not from a *sanitary compartment* or the like, open to a *required* fire-isolated *exit* in the same *storey*—
- (i) a smoke lobby in accordance with D2.6 must be provided; or
 - (ii) the *exit* must be pressurised in accordance with AS 1668.1.
- (e) A ramp must be provided at any change in level less than 600 mm in a *fire-isolated passageway* in a Class 9 building.

D1.8 External stairways or ramps in lieu of fire-isolated exits

- (a) An external stairway or ramp may serve as a *required exit* in lieu of a fire-isolated *exit* serving a *storey* below an *effective height* of 25 m, if the stairway or ramp is—
- (i) *non-combustible* throughout; and
 - (ii) protected in accordance with (c) if it is within 6 m of, and exposed to any part of the *external wall* of the building it serves.
- (b) For the purposes of this clause—
- (i) exposure under (a)(ii), is measured in accordance with Clause 2.1 of Specification C1.1, as if the *exit* was a building element and the *external wall* of the building was a *fire-source feature* to the *exit*, except that the FRL *required* in Clause 2.1(a)(i) must not be less than 60/60/60; and
 - (ii) the plane formed at the construction edge or perimeter of an unenclosed building or part such as an *open-deck carpark*, *open spectator stand* or the like, is deemed to be an *external wall*; and

Access and egress

Deemed-to-Satisfy Provisions

- (iii) openings in an *external wall* and openings under (c) and (d), are determined in accordance with C3.1.
- (c) The protection referred to in (a)(ii), must adequately protect occupants using the *exit* from exposure to a fire within the building, in accordance with one of the following methods:
 - (i) The part of the *external wall* of the building to which the *exit* is exposed must have—
 - (A) an FRL of not less than 60/60/60; and
 - (B) no openings less than 3 m from the *exit* (except a doorway serving the *exit* protected by a –/60/30 fire door in accordance with C3.8(a)); and
 - (C) any opening 3 m or more but less than 6 m from the *exit*, protected in accordance with C3.4 and if wall wetting sprinklers are used, they are located internally.
 - (ii) The *exit* must be protected from—
 - (A) any part of the *external wall* of the building having an FRL of less than 60/60/60; and
 - (B) any openings in the *external wall*, by the construction of a wall, roof, floor or other shielding element as appropriate in accordance with (d).
- (d) The wall, roof, floor or other shielding element *required* by (c)(ii) must—
 - (i) have an FRL of not less than 60/60/60; and
 - (ii) have no openings less than 3 m from the *external wall* of the building (except a doorway serving the *exit* protected by a –/60/30 fire door in accordance with C3.8(a)); and
 - (iii) have any opening 3 m or more but less than 6 m from any part of the *external wall* of the building protected in accordance with C3.4 and if wall wetting sprinklers are used, they are located on the side exposed to the *external wall*.

D1.9 Travel by non-fire-isolated stairways or ramps

- (a) A non-*fire-isolated stairway* or non-*fire-isolated ramp* serving as a *required exit* must provide a continuous means of travel by its own *flights* and landings from every *storey* served to the level at which egress to a road or *open space* is provided.
- (b) In a Class 2, 3 or 4 building, the distance between the doorway of a room or *sole-occupancy unit* and the point of egress to a road or *open space* by way of a stairway or ramp that is not fire-isolated and is *required* to serve that room or *sole-occupancy unit* must not exceed—
 - (i) 30 m in a building of Type C construction; or
 - (ii) 60 m in all other cases.
- (c) In a Class 5, 6, 7, 8 or 9 building, the distance from any point on a floor to a point of egress to a road or *open space* by way of a *required* non-*fire-isolated stairway* or non-*fire-isolated ramp* must not exceed 80 m.
- (d) In a Class 2, 3 or 9a building, a *required* non-*fire-isolated stairway* or non-*fire-isolated ramp* must discharge at a point not more than—
 - (i) 15 m from a doorway providing egress to a road or *open space* or from a *fire-isolated passageway* leading to a road or *open space*; or
 - (ii) 30 m from one of 2 such doorways or passageways if travel to each of them from the non-*fire-isolated stairway* or non-*fire-isolated ramp* is in opposite or approximately opposite directions.
- (e) In a Class 5 to 8 or 9b building, a *required* non-*fire-isolated stairway* or non-*fire-isolated ramp* must discharge at a point not more than—
 - (i) 20 m from a doorway providing egress to a road or *open space* or from a *fire-isolated passageway* leading to a road or *open space*; or
 - (ii) 40 m from one of 2 such doorways or passageways if travel to each of them from the non-*fire-isolated stairway* or non-*fire-isolated ramp* is in opposite or approximately opposite directions.
- (f) In a Class 2 or 3 building, if 2 or more *exits* are *required* and are provided by means of internal non-*fire-isolated stairways* or non-*fire-isolated ramps* each *exit* must—
 - (i) provide separate egress to a road or *open space*; and

Access and egress

Deemed-to-Satisfy Provisions

- (ii) be suitably smoke-separated from each other at the level of discharge.

SA D1.9(g)

D1.10 Discharge from exits

- (a) An *exit* must not be blocked at the point of discharge and where necessary, suitable barriers must be provided to prevent vehicles from blocking the *exit*, or access to it.
- (b) If a *required exit* leads to an *open space*, the path of travel to the road must have an unobstructed width throughout of not less than—
 - (i) the minimum width of the *required exit*; or
 - (ii) 1 m,
 whichever is the greater.
- (c) If an *exit* discharges to *open space* that is at a different level than the public road to which it is connected, the path of travel to the road must be by—
 - (i) a ramp or other incline having a gradient not steeper than 1:8 at any part, or not steeper than 1:14 if *required* by the *Deemed-to-Satisfy Provisions* of Part D3; or
 - (ii) except if the *exit* is from a Class 9a building, a stairway complying with the *Deemed-to-Satisfy Provisions* of the BCA.
- (d) The discharge point of alternative *exits* must be located as far apart as practical.
- (e) In a Class 9b building which is an *open spectator stand* that accommodates more than 500 persons, a *required* stairway or *required* ramp must not discharge to the ground in front of the stand.

NSW D1.10(f)

- (f) In a Class 9b building containing an auditorium which accommodates more than 500 persons, not more than $\frac{2}{3}$ of the *required* width of *exits* must be located in the main entrance foyer.
- (g) The number of persons accommodated must be calculated according to D1.13.

D1.11 Horizontal exits

- (a) *horizontal exits* must not be counted as *required exits*—
 - (i) between *sole-occupancy units*; or
 - (ii) in a Class 9b building used as an *early childhood centre*, primary or secondary *school*.
- (b) In a Class 9a *health-care building* or Class 9c building, *horizontal exits* may be counted as *required exits* if the path of travel from a *fire compartment* leads by one or more *horizontal exits* directly into another *fire compartment* which has at least one *required exit* which is not a *horizontal exit*.
- (c) In cases other than in (b), *horizontal exits* must not comprise more than half of the *required exits* from any part of a *storey* divided by a *fire wall*.
- (d) *Horizontal exits* must have a clear area on the side of the *fire wall* to which occupants are evacuating, to accommodate the total number of persons (calculated under D1.13) served by the *horizontal exit* of not less than—
 - (i) 2.5 m² per patient/resident in a Class 9a *health-care building* or Class 9c *aged care building*; and
 - (ii) 0.5 m² per person in any other case.
- (e) Where a *fire compartment* is provided with only two *exits*, and one of those *exits* is a *horizontal exit*, the clear area *required* by (d) is to be of a size that accommodates all the occupants from the *fire compartment* being evacuated.
- (f) The clear area *required* by (d) must be connected to the *horizontal exit* by an unobstructed path that has at least the dimensions *required* for the *horizontal exit* and may include the area of the unobstructed path.

D1.12 Non-required stairways, ramps or escalators

An escalator, moving walkway or non-*required* non *fire-isolated stairway* or pedestrian ramp—

- (a) must not be used between *storeys* in—

Access and egress

Deemed-to-Satisfy Provisions

- (i) a *patient care area* in a Class 9a *health-care building*; or
- (ii) a *resident use area* in a Class 9c building; and
- (b) may connect any number of *storeys* if it is—
 - (i) in an *open spectator stand* or indoor sports stadium; or
 - (ii) in a *carpark* or an *atrium*; or
 - (iii) outside a building; or
 - (iv) in a Class 5 or 6 building that is sprinklered throughout, where the escalator, walkway, stairway or ramp complies with [Specification D1.12](#); and
- (c) except where permitted in (b) must not connect more than—
 - (i) 3 *storeys* if each of those *storeys* is provided with a sprinkler system (other than a FPAA101D system) complying with [Specification E1.5](#) throughout; or
 - (ii) 2 *storeys*,
provided that in each case, those *storeys* must be consecutive, and one of those *storeys* is situated at a level at which there is direct egress to a road or *open space*; and
- (d) except where permitted in (b) or (c), must not connect, directly or indirectly, more than 2 *storeys* at any level in a Class 5, 6, 7, 8 or 9 building and those *storeys* must be consecutive.

D1.13 Number of persons accommodated

For the purposes of the *Deemed-to-Satisfy Provisions*, the number of persons accommodated in a *storey*, room or *mezzanine* must be determined with consideration to the purpose for which it is used and the layout of the *floor area* by—

- (a) calculating the sum of the numbers obtained by dividing the *floor area* of each part of the *storey* by the number of square metres per person listed in [Table D1.13](#) according to the use of that part, excluding spaces set aside for—
 - (i) lifts, stairways, ramps and escalators, corridors, hallways, lobbies and the like; and
 - (ii) service ducts and the like, *sanitary compartments* or other ancillary uses; or
- (b) reference to the seating capacity in an *assembly building* or room; or
- (c) any other suitable means of assessing its capacity.

NSW Table D1.13

Table D1.13 Area per person according to use

Type of use	Area per person
Art gallery, exhibition area, museum	4 m ²
Bar—standing	0.5 m ²
Bar—other	1 m ²
Board room	2 m ²
Boarding house	15 m ²
Cafe, church, dining room	1 m ²
<i>Carpark</i>	30 m ²
Computer room	25 m ²
Court room—judicial area	10 m ²
Court room—public seating	1 m ²
Dance floor	0.5 m ²
Dormitory	5 m ²
<i>Early childhood centre</i>	4 m ²
Factory—	5 m ²
(a) machine shop, fitting shop or like place for cutting, grading, finishing or fitting of metals or glass, except	

Access and egress

Deemed-to-Satisfy Provisions

Type of use	Area per person
in the fabrication of structural steelwork or manufacture of vehicles or bulky products	
Factory— (b) areas used for fabrication and processing other than those in (a)	50 m ²
Factory— (c) a space in which the layout and natural use of fixed plant or equipment determines the number of persons who will occupy the space during working hours	Area per person determined by the use of the plant or equipment
Gymnasium	3 m ²
Hostel, hotel, motel, guest house	15 m ²
Indoor sports stadium—arena	10 m ²
Kiosk	1 m ²
Kitchen, laboratory, laundry	10 m ²
Library—reading space	2 m ²
Library—storage space	30 m ²
Office, including one for typewriting or document copying	10 m ²
<i>Patient care areas</i>	10 m ²
Plant room—ventilation, electrical or other service units	30 m ²
Plant room—boilers or power plant	50 m ²
Reading room	2 m ²
Restaurant	1 m ²
<i>School</i> —general classroom	2 m ²
<i>School</i> —multi-purpose hall	1 m ²
<i>School</i> —staff room	10 m ²
<i>School</i> —trade and practical area—primary	4 m ²
<i>School</i> —trade and practical area—secondary	As for workshop
Shop—space for sale of goods— at a level entered direct from the open air or any lower level	3 m ²
Shop—space for sale of goods— all other levels	5 m ²
Showroom—display area, covered mall or arcade	5 m ²
Skating rink, based on rink area	1.5 m ²
Spectator stand, audience viewing area— standing viewing area	0.3 m ²
Spectator stand, audience viewing area— removable seating	1 m ²
Spectator stand, audience viewing area— fixed seating	Per number of seats
Spectator stand, audience viewing area— bench seating	450 mm/person
Storage space	30 m ²
<i>Swimming pool</i> , based on pool area	1.5 m ²
Switch room, transformer room	30 m ²
Telephone exchange—private	30 m ²
Theatre and public hall	1 m ²

Access and egress

Deemed-to-Satisfy Provisions

Type of use	Area per person
Theatre dressing room	4 m ²
Transport terminal	2 m ²
Workshop—for maintenance staff	30 m ²
Workshop—for manufacturing processes	As for factory

Note to Table D1.13: Bar standing is the area used by standing patrons and extends not less than 1.5 m wide from the outside edge of the bar top for the length of the serving area of the bar.

D1.14 Measurement of distances

The nearest part of an *exit* means in the case of—

- (a) a *fire-isolated stairway*, *fire-isolated passageway*, or *fire-isolated ramp*, the nearest part of the doorway providing access to them; and
- (b) a non-*fire-isolated stairway*, the nearest part of the nearest riser; and
- (c) a non-*fire-isolated ramp*, the nearest part of the junction of the floor of the ramp and the floor of the *storey*; and
- (d) a doorway opening to a road or *open space*, the nearest part of the doorway; and
- (e) a *horizontal exit*, the nearest part of the doorway.

D1.15 Method of measurement

The following rules apply:

- (a) In the case of a room that is not a *sole-occupancy unit* in a Class 2 or 3 building or Class 4 part of a building, the distance includes the straight-line measurement from any point on the floor of the room to the nearest part of a doorway leading from it, together with the distance from that part of the doorway to the single *required exit* or point from which travel in different directions to 2 *required exits* is available.
- (b) Subject to (d), the distance from the doorway of a *sole-occupancy unit* in a Class 2 or 3 building or a Class 4 part of a building is measured in a straight line to the nearest part of the *required* single *exit* or point from which travel in different directions to 2 *required exits* is available.
- (c) Subject to (d), the distance between *exits* is measured in a straight line between the nearest parts of those *exits*.
- (d) Only the shortest distance is taken along a corridor, hallway, external balcony or other path of travel that curves or changes direction.
- (e) If more than one corridor, hallway, or other internal path of travel connects *required exits*, for the purposes of D1.5(c) the measurement is along the path of travel through the point at which travel in different directions to those *exits* is available, as determined in accordance with D1.4.
- (f) If a wall (including a demountable *internal wall*) that does not bound—
 - (i) a room; or
 - (ii) a corridor, hallway or the like, causes a change of direction in proceeding to a *required exit*, the distance is measured along the path of travel past that wall.
- (g) If permanent fixed seating is provided, the distance is measured along the path of travel between the rows of seats.
- (h) In the case of a non-*fire-isolated stairway* or non-*fire-isolated ramp*, the distance is measured along a line connecting the nosings of the treads, or along the slope of the ramp, together with the distance connecting those lines across any intermediate landings.

D1.16 Plant rooms, lift machine rooms and electricity network substations: concession

- (a) A ladder may be used in lieu of a stairway to provide egress from—
 - (i) a plant room with a *floor area* of not more than 100 m²; or
 - (ii) all but one point of egress from a plant room, a lift machine room or a Class 8 *electricity network substation* with a *floor area* of not more than 200 m².
- (b) A ladder permitted under (a)—

Access and egress

Deemed-to-Satisfy Provisions

- (i) may form part of an *exit* provided that in the case of a *fire-isolated stairway* it is contained within the *shaft*; or
- (ii) may discharge within a *storey* in which case it must be considered as forming part of the path of travel; and
- (iii) for a plant room or a Class 8 *electricity network substation*, must comply with AS 1657; and
- (iv) for a lift machine room, where access is provided from within a machine room to a secondary floor, a fixed rung type ladder complying with AS 1657 may be used, provided that—
 - (A) the height between the floors is not more than 2800 mm; and
 - (B) the ladder is inclined at an angle to the horizontal not less than 65 degrees nor more than 75 degrees; and
 - (C) the distance between the front face of the ladder and any adjacent obstruction is not less than—
 - (aa) 960 mm, where the ladder is inclined 65 degrees to the horizontal; or
 - (bb) 760 mm, where the ladder is inclined 75 degrees to the horizontal; or
 - (cc) a distance that is determined by interpolating the values in (aa) and (bb), where the ladder is inclined at any angle between 65 degrees and 75 degrees to the horizontal; and
 - (D) a clear space not less than 600 mm exists between the foot of the ladder and any equipment.

SA D1.16(c)

D1.17 Access to lift pits

Access to lift pits must—

- (a) where the pit depth is not more than 3 m, be through the lowest landing doors; or
- (b) where the pit depth is more than 3 m, be provided through an access doorway complying with the following:
 - (i) In lieu of D1.6, the doorway must be level with the pit floor and not be less than 600 mm wide by 1980 mm high clear opening, which may be reduced to 1500 mm where it is necessary to comply with (ii).
 - (ii) No part of the lift car or platform must encroach on the pit doorway entrance when the car is on a fully compressed buffer.
 - (iii) Access to the doorway must be by a stairway complying with AS 1657.
 - (iv) In lieu of D2.21, doors fitted to the doorway must be—
 - (A) of the horizontal sliding or outwards opening hinged type; and
 - (B) self-closing and self-locking from the outside; and
 - (C) marked on the landing side with the letters not less than 35 mm high:
“DANGER LIFTWELL – ENTRY OF UNAUTHORIZED PERSONS PROHIBITED – KEEP CLEAR AT ALL TIMES”

ACT Appendix

D1.18 Egress from early childhood centres

- (a) Every part of a Class 9b *early childhood centre* must be wholly within a *storey* that provides direct egress to a road or *open space*.
- (b) The requirements of (a) do not apply in a building with a *rise in storeys* of not more than 2, where the Class 9b *early childhood centre* is the only use in that building.

Explanatory information:

D1.18(a) recognises the difficulties associated with evacuation of *early childhood centres*. Should an *early childhood centre* be proposed within a *storey* that does not meet the requirements of D1.18(a), a *Performance Solution* is to be used to demonstrate compliance with the relevant *Performance Requirements*.

Part D2 Construction of exits

Deemed-to-Satisfy Provisions

D2.0 Deemed-to-Satisfy Provisions

- (a) Where a *Deemed-to-Satisfy Solution* is proposed, *Performance Requirements DP1 to DP6, DP8 and DP9* are satisfied by complying with—
- (i) *D1.1 to D1.16, D2.1 to D2.25 and D3.1 to D3.12*; and
 - (ii) in a building containing an *atrium, Part G3*; and
 - (iii) in a building in an *alpine area, Part G4*; and
 - (iv) for a building containing an *occupiable outdoor area, Part G6*; and
 - (v) for additional requirements for Class 9b buildings, *Part H1*; and
 - (vi) for public transport buildings, *Part H2*; and
 - (vii) for *farm buildings* and *farm sheds, Part H3*.
- (b) Where a *Performance Solution* is proposed, the relevant *Performance Requirements* must be determined in accordance with *A2.2(3)* and *A2.4(3)* as applicable.
- (c) *Performance Requirement DP7* must be complied with if lifts are to be used to assist occupants to evacuate a building.

D2.1 Application of Part

Except for—

- (a) *D2.13, D2.14(a), D2.16, D2.17(d), D2.17(e), D2.21 and D2.24*, the *Deemed-to-Satisfy Provisions* of this Part do not apply to the internal parts of a *sole-occupancy unit* in a Class 3 building; and
- (b) *D2.13, D2.14(a), D2.16, D2.17(d), D2.17(e), D2.18 and D2.24*, the *Deemed-to-Satisfy Provisions* of this Part do not apply to the internal parts of a *sole-occupancy unit* in a Class 2 building or Class 4 part of a building.

[NSW D2.1\(c\)](#)

D2.2 Fire-isolated stairways and ramps

A stairway or ramp (including any landings) that is *required* to be within a *fire-resisting shaft* must be constructed—

- (a) of *non-combustible* materials; and
- (b) so that if there is local failure it will not cause structural damage to, or impair the fire-resistance of, the *shaft*.

D2.3 Non-fire-isolated stairways and ramps

In a building having a *rise in storeys* of more than 2, *required* stairs and ramps (including landings and any supporting building elements) which are not *required* to be within a *fire-resisting shaft*, must be constructed according to *D2.2*, or only of—

- (a) reinforced or prestressed concrete; or
- (b) steel in no part less than 6 mm thick; or
- (c) timber that—
 - (i) has a finished thickness of not less than 44 mm; and
 - (ii) has an average density of not less than 800 kg/m³ at a moisture content of 12%; and
 - (iii) has not been joined by means of glue unless it has been laminated and glued with resorcinol formaldehyde or resorcinol phenol formaldehyde glue.

Access and egress

Deemed-to-Satisfy Provisions

D2.4 Separation of rising and descending stair flights

If a stairway serving as an *exit* is *required* to be fire-isolated—

- (a) there must be no direct connection between—
 - (i) a *flight* rising from a *storey* below the lowest level of access to a road or *open space*; and
 - (ii) a *flight* descending from a *storey* above that level; and
- (b) any construction that separates or is common to the rising and descending *flights* must be—
 - (i) *non-combustible*; and
 - (ii) smoke proof in accordance with [Clause 2 of Specification C2.5](#).

D2.5 Open access ramps and balconies

Where an open access ramp or balcony is provided to meet the smoke hazard management requirements of [Table E2.2a](#), it must—

- (a) have ventilation openings to the outside air which—
 - (i) have a total unobstructed area not less than the *floor area* of the ramp or balcony; and
 - (ii) are evenly distributed along the open sides of the ramp or balcony; and
- (b) not be enclosed on its open sides above a height of 1 m except by an open grille or the like having a free air space of not less than 75% of its area.

D2.6 Smoke lobbies

A smoke lobby *required* by [D1.7](#) must—

- (a) have a *floor area* not less than 6 m²; and
- (b) be separated from the occupied areas in the *storey* by walls which are impervious to smoke, and—
 - (i) have an FRL of not less than 60/60/– (which may be fire-protective grade plasterboard, gypsum block with set plaster, face brickwork, glass blocks or glazing); and
 - (ii) extend from slab to slab, or to the underside of a ceiling with a *resistance to the incipient spread of fire* of 60 minutes which covers the lobby; and
 - (iii) any construction joints between the top of the walls and the floor slab, roof or ceiling must be smoke sealed with intumescent putty or other suitable material; and
- (c) at any opening from the occupied areas, have smoke doors complying with [Clause 3 of Specification C3.4](#) except that the smoke sensing device need only be located on the approach side of the opening; and
- (d) be pressurised as part of the *exit* if the *exit* is *required* to be pressurised under [E2.2](#).

D2.7 Installations in exits and paths of travel

- (a) Access to service *shafts* and services other than to fire-fighting or detection equipment as permitted in the *Deemed-to-Satisfy Provisions* of [Section E](#), must not be provided from a *fire-isolated stairway*, *fire-isolated passageway* or *fire-isolated ramp*.
- (b) An opening to any chute or duct intended to convey hot products of combustion from a boiler, incinerator, fireplace or the like, must not be located in any part of a *required exit* or any corridor, hallway, lobby or the like leading to a *required exit*.
- (c) Gas or other fuel services must not be installed in a *required exit*.
- (d) Services or equipment comprising—
 - (i) electricity meters, distribution boards or ducts; or
 - (ii) central telecommunications distribution boards or equipment; or
 - (iii) electrical motors or other motors serving equipment in the building,

Access and egress

Deemed-to-Satisfy Provisions

may be installed in—

- (iv) a *required exit*, except for fire-isolated *exits* specified in (a); or
- (v) in any corridor, hallway, lobby or the like leading to a *required exit*, if the services or equipment are enclosed by *non-combustible* construction or a *fire-protective covering* with doorways or openings suitably sealed against smoke spreading from the enclosure.
- (e) Electrical wiring may be installed in a fire-isolated *exit* if the wiring is associated with—
 - (i) a lighting, detection, or pressurisation system serving the *exit*; or
 - (ii) a security, surveillance or management system serving the *exit*; or
 - (iii) an intercommunication system or an audible or visual alarm system in accordance with D2.22; or
 - (iv) the monitoring of hydrant or sprinkler isolating valves.

D2.8 Enclosure of space under stairs and ramps

- (a) **Fire-isolated stairways and ramps** — If the space below a *required fire-isolated stairway* or *fire-isolated ramp* is within the fire-isolated *shaft*, it must not be enclosed to form a cupboard or similar enclosed space.
- (b) **Non fire-isolated stairways and ramps** — The space below a *required* non *fire-isolated stairway* (including an external stairway) or non *fire-isolated ramp* must not be enclosed to form a cupboard or other enclosed space unless—
 - (i) the enclosing walls and ceilings have an FRL of not less than 60/60/60; and
 - (ii) any access doorway to the enclosed space is fitted with a *self-closing* –/60/30 fire door.

D2.9 Width of required stairways and ramps

A *required* stairway or ramp that exceeds 2 m in width is counted as having a width of only 2 m unless it is divided by a handrail or barrier continuous between landings and each division has a width of not more than 2 m.

D2.10 Pedestrian ramps

- (a) A *fire-isolated ramp* may be substituted for a *fire-isolated stairway* if the construction enclosing the *ramp* and the width and ceiling height comply with the requirements for a *fire-isolated stairway*.
- (b) A ramp serving as a *required exit* must—
 - (i) where the ramp is also serving as an *accessible* ramp under Part D3, be in accordance with AS 1428.1; or
 - (ii) in any other case, have a gradient not steeper than 1:8.
- (c) The floor surface of a ramp must have a slip-resistance classification not less than that listed in Table D2.14 when tested in accordance with AS 4586.

D2.11 Fire-isolated passageways

- (a) The enclosing construction of a *fire-isolated passageway* must have an FRL when tested for a fire outside the passageway in another part of the building of—
 - (i) if the passageway discharges from a *fire-isolated stairway* or *ramp* — not less than that *required* for the stairway or ramp *shaft*; or
 - (ii) in any other case — not less than 60/60/60.
- (b) Notwithstanding (a)(ii), the top construction of a *fire-isolated passageway* need not have an FRL if the walls of the *fire-isolated passageway* extend to the underside of—
 - (i) a *non-combustible* roof covering; or
 - (ii) a ceiling having a *resistance to the incipient spread of fire* of not less than 60 minutes separating the roof space or ceiling space in all areas surrounding the passageway within the *fire compartment*.

Access and egress

Deemed-to-Satisfy Provisions

D2.12 Roof as open space

If an *exit* discharges to a roof of a building, the roof must—

- (a) have an FRL of not less than 120/120/120; and
- (b) not have any roof lights or other openings within 3 m of the path of travel of persons using the *exit* to reach a road or *open space*.

D2.13 Goings and risers

- (a) A stairway must have—
 - (i) not more than 18 and not less than 2 risers in each *flight*; and
 - (ii) going (G), riser (R) and quantity ($2R + G$) in accordance with [Table D2.13](#), except as permitted by (b) and (c); and
 - (iii) constant goings and risers throughout each *flight*, except as permitted by (b) and (c), and the dimensions of goings (G) and risers (R) in accordance with (a)(ii) are considered constant if the variation between—
 - (A) adjacent risers, or between adjacent goings, is no greater than 5 mm; and
 - (B) the largest and smallest riser within a *flight*, or the largest and smallest going within a *flight*, does not exceed 10 mm; and
 - (iv) risers which do not have any openings that would allow a 125 mm sphere to pass through between the treads; and
 - (v) treads which have—
 - (A) a surface with a slip-resistance classification not less than that listed in [Table D2.14](#) when tested in accordance with AS 4586; or
 - (B) a nosing strip with a slip-resistance classification not less than that listed in [Table D2.14](#) when tested in accordance with AS 4586; and
 - (vi) treads of solid construction (not mesh or other perforated material) if the stairway is more than 10 m high or connects more than 3 *storeys*; and
 - (vii) in a Class 9b building, not more than 36 risers in consecutive *flights* without a change in direction of at least 30°; and
 - (viii) in the case of a *required* stairway, no winders in lieu of a landing.

NSW D2.13(a)(ix),(x),(xi)

- (b) In the case of a non-*required* stairway—
 - (i) the stairway must have—
 - (A) not more than 3 winders in lieu of a quarter landing; and
 - (B) not more than 6 winders in lieu of a half landing; and
 - (ii) the going of all straight treads must be constant throughout the same *flight* and the dimensions of goings (G) is considered constant if the variation between—
 - (A) adjacent goings, is no greater than 5 mm; and
 - (B) the largest and smallest going within a *flight*, does not exceed 10 mm; and
 - (iii) the going of all winders in lieu of a quarter or half landing may vary from the going of the straight treads within the same *flight* provided that the going of all such winders is constant.
- (c) Where a stairway discharges to a sloping public walkway or public road—
 - (i) the riser (R) may be reduced to account for the slope of the walkway or road; and
 - (ii) the quantity ($2R+G$) may vary at that location.

Access and egress

Deemed-to-Satisfy Provisions

Table D2.13 Riser and going dimensions

Stairway location	Riser (R)	Going (G) ^{Note 3}	Quantity (2R+G)
Public	Max: 190 mm Min: 115 mm	Max: 355 mm Min: 250 mm	Max: 700 mm Min: 550 mm
Private ^{Note 1}	Max: 190 mm Min: 115 mm	Max: 355 mm Min: 240 mm	Max: 700 mm Min: 550 mm

Notes to Table D2.13:

1. Private stairways are—
 - a. stairways in a *sole-occupancy unit* in a Class 2 building or Class 4 part of a building; and
 - b. in any building, stairways which are not part of a *required exit* and to which the public do not normally have access.
2. *Going* and *riser* dimensions must be measured in accordance with [Figure D2.13](#).
3. The *going* in tapered treads (except *winders* in lieu of a quarter or half landing) in a curved or spiral stairway is measured—
 - a. 270 mm in from the outer side of the unobstructed width of the stairway if the stairway is less than 1 m wide (applicable to a non-*required* stairway only); and
 - b. 270 mm from each side of the unobstructed width of the stairway if the stairway is 1 m wide or more.

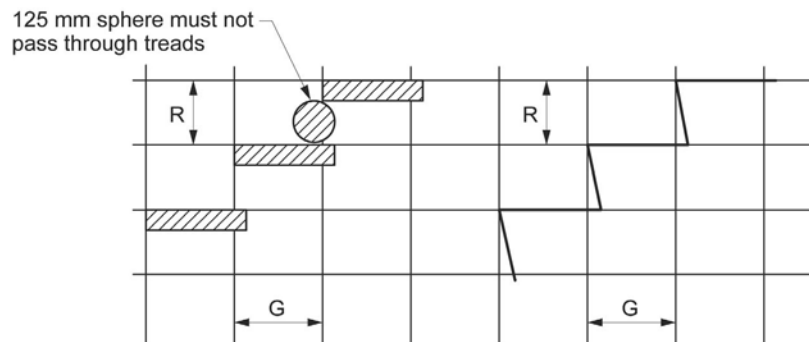
Figure D2.13 Riser and going dimensions

D2.14 Landings

In a stairway—

- (a) landings having a maximum gradient of 1:50 may be used in any building to limit the number of risers in each *flight* and each landing must—
 - (i) be not less than 750 mm long, and where this involves a change in direction, the length is measured 500 mm from the inside edge of the landing; and
 - (ii) have—
 - (A) a surface with a slip-resistance classification not less than that listed in [Table D2.14](#) when tested in accordance with AS 4586; or
 - (B) a strip at the edge of the landing with a slip-resistance classification not less than that listed in [Table D2.14](#) when tested in accordance with AS 4586, where the edge leads to a *flight* below; and
- (b) in a Class 9a building—
 - (i) the area of any landing must be sufficient to move a stretcher, 2 m long and 600 mm wide, at a gradient not more than the gradient of the stairs, with at least one end of the stretcher on the landing while changing direction between *flights*; or
 - (ii) the stair must have a change of direction of 180°, and the landing a clear width of not less than 1.6 m and a

Access and egress

Deemed-to-Satisfy Provisions

clear length of not less than 2.7 m.

Table D2.14 Slip-resistance classification

Application	Dry surface conditions	Wet surface conditions
Ramp steeper than 1:14	P4 or R11	P5 or R12
Ramp steeper than 1:20 but not steeper than 1:14	P3 or R10	P4 or R11
Tread or landing surface	P3 or R10	P4 or R11
Nosing or landing edge strip	P3	P4

D2.15 Thresholds

The threshold of a doorway must not incorporate a step or ramp at any point closer to the doorway than the width of the door leaf unless—

- (a) in *patient care areas* in a Class 9a *health-care building*, the door sill is not more than 25 mm above the finished floor level to which the doorway opens; or
- (b) in a Class 9c building, a ramp is provided with a maximum gradient of 1:8 for a maximum height of 25 mm over the threshold; or
- (c) in a building *required* to be *accessible* by [Part D3](#), the doorway—
 - (i) opens to a road or *open space*; and
 - (ii) is provided with a threshold ramp or step ramp in accordance with AS 1428.1; or

NSW D2.15(d),(e)

- (d) in other cases—
 - (i) the doorway opens to a road or *open space*, external stair landing or external balcony; and
 - (ii) the door sill is not more than 190 mm above the finished surface of the ground, balcony, or the like, to which the doorway opens.

SA D2.15(e)

D2.16 Barriers to prevent falls

- (a) A continuous barrier must be provided along the side of—
 - (i) a roof to which general access is provided; and
 - (ii) a stairway or ramp; and
 - (iii) a floor, corridor, hallway, balcony, deck, verandah, *mezzanine*, access bridge or the like; and
 - (iv) any delineated path of access to a building, if the trafficable surface is 1 m or more above the surface beneath.
- (b) The requirements of (a) do not apply to—
 - (i) the perimeter of a *stage*, rigging loft, loading dock or the like; or
 - (ii) areas referred to in [D2.18](#); or
 - (iii) a retaining wall unless the retaining wall forms part of, or is directly associated with a delineated path of access to a building from the road, or a delineated path of access between buildings; or
 - (iv) a barrier provided to an openable window covered by [D2.24](#).
- (c) A barrier *required* by (a) must be constructed in accordance with [Table D2.16a](#).

NSW Table D2.16a 1.

Table D2.16a Barrier construction

1. Barrier heights

Access and egress

Deemed-to-Satisfy Provisions

Location	Minimum height
(a) Stairways or ramps with a gradient of 1:20 or steeper.	865 mm
(b) Landings to a stair or ramp where the barrier is provided along the inside edge of the landing and does not exceed 500 mm in length.	
(c) In front of fixed seating on a <i>mezzanine</i> or balcony within an auditorium in a Class 9b building, where the horizontal projection extends not less than 1 m outwards from the top of the barrier.	700 mm
(d) In all other locations.	1 m

Notes:

1. Heights are measured vertically from the surface beneath, except that for stairways the height must be measured above the nosing line of the stair treads.
2. A transition zone may be incorporated where the barrier height changes from 865 mm on a stair *flight* or ramp to 1 m at a landing or floor.

2. Barrier openings

Location	Maximum opening
(a) <i>Fire-isolated stairways, fire-isolated ramps</i> and other areas used primarily for emergency purposes, excluding— (i) external stairways; and (ii) external ramps.	A 300 mm sphere must not be able to pass through any opening; or where rails are used—
(b) Class 7 (other than <i>carparks</i>) and Class 8 buildings.	(i) a 150 mm sphere must not be able to pass through the opening between the nosing line of the stair treads and the rail or between the rail and the floor of the landing, balcony or the like; and (ii) the opening between rails must not be more than 460 mm.
(c) In all other locations.	A 125 mm sphere must not be able to pass through any opening.

Note: The maximum 125 mm barrier opening for a stairway, such as a non *fire-isolated stairway*, is measured above the nosing line of the stair treads.

3. Barrier climbability

Location	Requirement
(a) <i>Fire-isolated stairways, fire-isolated ramps</i> and other areas used primarily for emergency purposes, excluding— (i) external stairways; and (ii) external ramps.	No requirement.
(b) Class 7 (other than <i>carparks</i>) and Class 8 buildings.	
(c) For floors more than 4 m above the surface beneath in all other locations.	Any horizontal or near horizontal elements between 150 mm and 760 mm above the floor must not facilitate climbing.

- (d) Where a *required* barrier is constructed of wire, it is deemed to meet the requirements of [Table D2.16a 2\(c\)](#) if it is constructed in accordance with the following:
- (i) For horizontal wire systems—
 - (A) when measured with a strain indicator, it must be in accordance with the tension values in [Table D2.16b](#); or
 - (B) must not exceed the maximum deflections in [Table D2.16d](#).
 - (ii) For non-continuous vertical wire systems, when measured with a strain indicator, must be in accordance with the tension values in [Table D2.16b](#) (see [Note 4](#)).

Access and egress

Deemed-to-Satisfy Provisions

- (iii) For continuous vertical or continuous near vertical sloped wire systems—
- (A) must have wires of no more than 2.5 mm diameter with a lay of 7×7 or 7×19 construction; and
 - (B) changes in direction at support rails must pass around a pulley block without causing permanent deformation to the wire; and
 - (C) must have supporting rails, constructed with a spacing of not more than 900 mm, of a material that does not allow deflection that would decrease the tension of the wire under load; and
 - (D) when the wire tension is measured with a strain indicator, it must be in accordance with the tension values in [Table D2.16c](#) and measured in the furthest span from the tensioning device.

Table D2.16b Wire barrier construction – Required tension for stainless steel horizontal wires

			Clear distance between posts (mm)								
			600	800	900	1000	1200	1500	1800	2000	2500
Wire dia. (mm)	Lay	Wire spacing (mm)	Minimum <i>required</i> tension (N)								
2.5	7x7	60	55	190	263	415	478	823	1080	1139	X
		80	382	630	730	824	1025	1288	X	X	X
		100	869	1218	1368	X	X	X	X	X	X
2.5	1x19	60	35	218	310	402	585	810	1125	1325	X
		80	420	630	735	840	1050	1400	1750	X	X
		100	1140	1565	X	X	X	X	X	X	X
3.0	7x7	60	15	178	270	314	506	660	965	1168	1491
		80	250	413	500	741	818	1083	1370	1565	X
		100	865	1278	1390	1639	X	X	X	X	X
3.0	1x19	60	25	183	261	340	520	790	1025	1180	X
		80	325	555	670	785	1015	1330	1725	1980	X
		100	1090	1500	1705	1910	X	X	X	X	X
4.0	7x7	60	5	73	97	122	235	440	664	813	1178
		80	196	422	480	524	760	1100	1358	1530	2130
		100	835	1182	1360	1528	1837	2381	2811	3098	X
4.0	1x19	60	5	5	10	15	20	147	593	890	1280
		80	30	192	300	415	593	1105	1303	1435	1844
		100	853	1308	1487	1610	2048	2608	3094	3418	3849
4.0	7x19	60	155	290	358	425	599	860	1080	1285	1540
		80	394	654	785	915	1143	1485	1860	2105	2615
		100	1038	1412	1598	1785	2165	2735	X	X	X

Notes to Table D2.16b:

- Lay = number of strands by the number of individual wires in each strand. For example a lay of 7x19 consists of 7 strands with 19 individual wires in each strand.
- Where a change of direction is made in a run of wire, the tensioning device is to be placed at the end of the longest span.
- If a 3.2 mm wire is used the tension figures for 3.0 mm wire are applied.
- This table may also be used for a set of non-continuous (single) vertical wires forming a barrier using the appropriate clear distance between posts as the vertical clear distance between the rails.
- X = Not allowed because the required tension would exceed the safe load of the wire.
- Tension measured with a strain indicator.

Access and egress

Deemed-to-Satisfy Provisions

Table D2.16c Continuous wire barrier construction – Required for vertical or near vertical stainless steel wires

Wire dia. (mm)	Lay	Widest spacing between wires (mm)	Maximum clear spacing between rails (mm)	
			900	<i>Required</i> tension (N)
2.5	7x19	80		145
		100		310
		110		610
2.5	7x7	80		130
		100		280
		110		500

Notes to Table D2.16c:

- Lay = number of strands by the number of individual wires in each strand. For example a lay of 7x19 consists of 7 strands with 19 individual wires in each strand.
- Vertical wires require two pulley blocks to each 180° change of direction in the wire.
- Near vertical wires may only require one pulley block for each change of direction.
- Tension measured with a strain indicator.
- The table only includes 7x7 and 7x19 wires due to other wires not having sufficient flexibility to make the necessary turns.

Table D2.16d Wire barrier construction – Maximum permissible deflection for stainless steel wires

		Clear distance between posts (mm)					
		600	900	1200	1500	1800	2000
Wire dia. (mm)	Wire spacing (mm)	Maximum permissible deflection of each wire in mm when a 2 kg mass is suspended at mid span					
2.5	60	17	11	9	8	8	8
	80	7	5	5	5	X	X
3.0	60	19	13	8	7	7	7
	80	8	6	6	5	5	5
4.0	60	18	12	8	8	7	7
	80	8	6	4	4	4	4

Notes to Table D2.16d:

- Where a change of direction is made in a run of wire the 2 kg mass must be placed at the middle of the longest span.
- If a 3.2 mm wire is used the deflection figures for 3.0 mm wire are applied.
- This table may also be used for a set of non-continuous (single) vertical wires forming a barrier using the appropriate clear distance between posts as the vertical clear distance between the rails. The deflection (offset) is measured by hooking a standard spring scale to the mid span of each wire and pulling it horizontally until a force of 19.6 N is applied.
- X = Not allowed because the required tension would exceed the safe load of the wire.
- This table has been limited to 60 mm and 80 mm spaces for 2.5 mm, 3 mm and 4 mm diameter wires because the required wire tensions at greater spacings would require the tension to be beyond the wire safe load limit, or the allowed deflection would be impractical to measure.

D2.17 Handrails

- (a) Except for handrails referred to in [D2.18](#), handrails must be—
- located along at least one side of the ramp or *flight*; and
 - located along each side if the total width of the stairway or ramp is 2 m or more; and

Access and egress

Deemed-to-Satisfy Provisions

- (iii) in a Class 9b building used as a primary *school*—
 - (A) have one handrail fixed at a height of not less than 865 mm; and
 - (B) have a second handrail fixed at a height between 665 mm and 750 mm, measured above the nosings of stair treads and the floor surface of the ramp, landing or the like; and
 - (iv) in any other case, fixed at a height of not less than 865 mm measured above the nosings of stair treads and the floor surface of the ramp, landing, or the like; and
 - (v) continuous between stair *flight* landings and have no obstruction on or above them that will tend to break a hand-hold; and
 - (vi) in a *required exit* serving an area *required* to be *accessible*, designed and constructed to comply with clause 12 of AS 1428.1, except that clause 12(d) does not apply to a handrail *required* by (a)(iii)(B).
- (b) Handrails—
- (i) in a Class 9a *health-care building* must be provided along at least one side of every passageway or corridor used by patients, and must be—
 - (A) fixed not less than 50 mm clear of the wall; and
 - (B) where practicable, continuous for their full length.
 - (ii) in a Class 9c *aged care building* must be provided along both sides of every passageway or corridor used by residents, and must be—
 - (A) fixed not less than 50 mm clear of the wall; and
 - (B) where practicable, continuous for their full length.
- (c) Handrails *required* to assist people with a disability must be provided in accordance with D3.3.
- (d) Handrails to a stairway or ramp within a *sole-occupancy unit* in a Class 2 or 3 building or Class 4 part of a building must—
- (i) be located along at least one side of the *flight* or ramp; and
 - (ii) be located along the full length of the *flight* or ramp, except in the case where a handrail is associated with a barrier, the handrail may terminate where the barrier terminates; and
 - (iii) have the top surface of the handrail not less than 865 mm vertically above the nosings of the stair treads or the floor surface of the ramp; and
 - (iv) have no obstruction on or above them that will tend to break a handhold, except for newel posts, ball type stanchions, or the like.
- (e) The requirements of (d) do not apply to—
- (i) handrails referred to in D2.18; or
 - (ii) a stairway or ramp providing a change in elevation of less than 1 m; or
 - (iii) a landing; or
 - (iv) a winder where a newel post is installed to provide a handhold.

D2.18 Fixed platforms, walkways, stairways and ladders

A fixed platform, walkway, stairway, ladder and any going and riser, landing, handrail or barrier attached thereto may comply with AS 1657 in lieu of D2.13, D2.14, D2.16 and D2.17 if it only serves:

- (a) machinery rooms, boiler houses, lift-machine rooms, plant-rooms, and the like; or
- (b) non-*habitable rooms*, such as attics, storerooms and the like that are not used on a frequent or daily basis in the internal parts of a *sole-occupancy unit* in a Class 2 building or Class 4 part of a building.

SA D2.18(c)

D2.19 Doorways and doors

- (a) A doorway in a *resident use area* of a Class 9c building must not be fitted with—

Access and egress

Deemed-to-Satisfy Provisions

- (i) a sliding fire door; or
 - (ii) a sliding smoke door; or
 - (iii) a revolving door; or
 - (iv) a roller shutter door; or
 - (v) a tilt-up door.
- (b) A doorway serving as a *required exit* or forming part of a *required exit*, or a doorway in a *patient care area* of a Class 9a *health-care building*—
- (i) must not be fitted with a revolving door; and
 - (ii) must not be fitted with a roller shutter or tilt-up door unless—
 - (A) it serves a Class 6, 7 or 8 building or part with a *floor area* not more than 200 m²; and
 - (B) the doorway is the only *required exit* from the building or part; and
 - (C) it is held in the open position while the building or part is lawfully occupied; and
 - (iii) must not be fitted with a sliding door unless—
 - (A) it leads directly to a road or *open space*; and
 - (B) the door is able to be opened manually under a force of not more than 110 N; and
 - (iv) if fitted with a door which is power-operated—
 - (A) it must be able to be opened manually under a force of not more than 110 N if there is a malfunction or failure of the power source; and
 - (B) if it leads directly to a road or *open space* it must open automatically if there is a power failure to the door or on the activation of a fire or smoke alarm anywhere in the *fire compartment* served by the door.

NSW D2.19(b)(v)

- (c) A power-operated door in a path of travel to a *required exit*, except for a door in a *patient care area* of a Class 9a *health-care building* as provided in (b), must be able to be opened manually under a force of not more than 110 N if there is a malfunction or failure of the power source.

D2.20 Swinging doors

A swinging door in a *required exit* or forming part of a *required exit*—

- (a) must not encroach—
 - (i) at any part of its swing by more than 500 mm on the *required* width (including any landings) of a *required*—
 - (A) stairway; or
 - (B) ramp; or
 - (C) passageway,
 if it is likely to impede the path of travel of the people already using the *exit*; and
 - (ii) when fully open, by more than 100 mm on the *required* width of the *required exit*, and the measurement of encroachment in each case is to include door handles or other furniture or attachments to the door; and
- (b) must swing in the direction of egress unless—
 - (i) it serves a building or part with a *floor area* not more than 200 m², it is the only *required exit* from the building or part and it is fitted with a device for holding it in the open position; or
 - (ii) it serves a *sanitary compartment* or airlock (in which case it may swing in either direction); and *SA D2.20(b)(ii), (iii)*
- (c) must not otherwise impede the path or direction of egress.

Access and egress

Deemed-to-Satisfy Provisions

D2.21 Operation of latch

Vic D2.21(a)

- (a) A door in a *required exit*, forming part of a *required exit* or in the path of travel to a *required exit* must be readily openable without a key from the side that faces a person seeking egress, by—
- (i) a single hand downward action on a single device which is located between 900 mm and 1.1 m from the floor and if serving an area *required* to be *accessible* by Part D3—
 - (A) be such that the hand of a person who cannot grip will not slip from the handle during the operation of the latch; and
 - (B) have a clearance between the handle and the back plate or door face at the centre grip section of the handle of not less than 35 mm and not more than 45 mm; or
 - (ii) a single hand pushing action on a single device which is located between 900 mm and 1.2 m from the floor; and
 - (iii) where the latch operation device referred to in (ii) is not located on the door leaf itself—
 - (A) manual controls to power-operated doors must be at least 25 mm wide, proud of the surrounding surface and located—
 - (aa) not less than 500 mm from an internal corner; and
 - (bb) for a hinged door, between 1 m and 2 m from the door leaf in any position; and
 - (cc) for a sliding door, within 2 m of the doorway and clear of a surface mounted door in the open position.
 - (B) braille and tactile signage complying with Clause 3 and 6 of Specification D3.6 must identify the latch operation device.
- (b) The requirements of (a) do not apply to a door that—
- (i) serves a vault, strong-room, *sanitary compartment*, or the like; or
 - (ii) serves only, or is within—
 - (A) a *sole-occupancy unit* in a Class 2 building or a Class 4 part of a building; or
 - (B) a *sole-occupancy unit* in a Class 3 building (other than an entry door to a *sole-occupancy unit* of a boarding house, guest house, hostel, lodging house or backpacker accommodation); or
 - (C) a *sole-occupancy unit* with a *floor area* not more than 200 m² in a Class 5, 6, 7 or 8 building; or
 - (D) a space which is otherwise inaccessible to persons at all times when the door is locked; or
 - (iii) serves—
 - (A) Australian Government Security Zones 4 or 5; or
 - (B) the secure parts of a bank, *detention centre*, mental health facility, *early childhood centre* or the like; and it can be immediately unlocked—
 - (C) by operating a fail-safe control switch, not contained within a protective enclosure, to actuate a device to unlock the door; or
 - (D) by hand by a person or persons, specifically nominated by the owner, properly instructed as to the duties and responsibilities involved and available at all times when the building is lawfully occupied so that persons in the building or part may immediately escape if there is a fire; or
 - (iv) is fitted with a fail-safe device which *automatically* unlocks the door upon the activation of any sprinkler system (other than a FPAA101D system) complying with Specification E1.5 or smoke, or any other detector system deemed suitable in accordance with AS 1670.1 installed throughout the building, and is readily openable when unlocked; or
 - (v) is in a Class 9a or 9c building and—
 - (A) is one leaf of a two-leaf door complying with D1.6(f)(i) or D1.6(f)(iv) provided that it is not held closed by a locking mechanism and is readily openable; and

Access and egress

Deemed-to-Satisfy Provisions

(B) the door is not *required* to be a fire door or smoke door.

NSW D2.21(c), (d)

- (c) The requirements of (a) do not apply in a Class 9b building (other than a *school*, an *early childhood centre* or a building used for religious purposes) to a door in a *required exit*, forming part of a *required exit* or in the path of travel to a *required exit* serving a *storey* or room accommodating more than 100 persons, determined in accordance with D1.13, in which case it must be readily openable—
- (i) without a key from the side that faces a person seeking egress; and
 - (ii) by a single hand pushing action on a single device such as a panic bar located between 900 mm and 1.2 m from the floor; and
 - (iii) where a two-leaf door is fitted, the provisions of (i) and (ii) need only apply to one door leaf if the appropriate requirements of D1.6 are satisfied by the opening of that one leaf.

D2.22 Re-entry from fire-isolated exits

- (a) Doors of a fire-isolated *exit* must not be locked from the inside as follows:
- (i) In a Class 9a *health-care building*.
 - (ii) In a Class 9c building.
 - (iii) In a fire-isolated *exit* serving any storey above an *effective height* of 25 m, throughout the *exit*.
- (b) The requirements of (a) do not apply to a door fitted with a fail-safe device that *automatically* unlocks the door upon the activation of a fire alarm and—
- (i) on at least every fourth *storey*, the doors are not able to be locked and a sign is fixed on such doors stating that re-entry is available; or
 - (ii) an intercommunication system, or an audible or visual alarm system, operated from within the enclosure is provided near the doors and a sign is fixed adjacent to such doors explaining its purpose and method of operation.

D2.23 Signs on doors

- (a) A sign, to alert persons that the operation of certain doors must not be impaired, must be installed where it can readily be seen on, or adjacent to—
- (i) a *required*—
 - (A) fire door providing direct access to a fire-isolated *exit*, except a door providing direct egress from a *sole-occupancy unit* in a Class 2 or 3 building or Class 4 part of a building; and
 - (B) smoke door,
 - on the side of the door that faces a person seeking egress and, if the door is fitted with a device for holding it in the open position, on either the wall adjacent to the doorway or both sides of the door; and
 - (ii) a—
 - (A) fire door forming part of a *horizontal exit*; and
 - (B) smoke door that swings in both directions; and
 - (C) door leading from a fire isolated *exit* to a road or *open space*, on each side of the door.
- (b) A sign referred to in (a) must be in capital letters not less than 20 mm high in a colour contrasting with the background and state—
- (i) for an *automatic* door held open by an *automatic* hold-open device—
 - “FIRE SAFETY DOOR—DO NOT OBSTRUCT”; or
 - (ii) for a *self-closing* door—
 - “FIRE SAFETY DOOR
DO NOT OBSTRUCT
DO NOT KEEP OPEN”; or

Access and egress

Deemed-to-Satisfy Provisions

- (iii) for a door discharging from a fire-isolated *exit*—
“FIRE SAFETY DOOR—DO NOT OBSTRUCT”.

D2.24 Protection of openable windows

- (a) A window opening must be provided with protection, if the floor below the window is 2 m or more above the surface beneath in—
 - (i) a bedroom in a Class 2 or 3 building or Class 4 part of a building; or
 - (ii) a Class 9b *early childhood centre*.
- (b) Where the lowest level of the window opening is less than 1.7 m above the floor, a window opening covered by (a) must comply with the following:
 - (i) The openable portion of the window must be protected with—
 - (A) a device capable of restricting the window opening; or
 - (B) a screen with secure fittings.
 - (ii) A device or screen *required* by (i) must—
 - (A) not permit a 125 mm sphere to pass through the window opening or screen; and
 - (B) resist an outward horizontal action of 250 N against the—
 - (aa) window restrained by a device; or
 - (bb) screen protecting the opening; and
 - (C) have a child resistant release mechanism if the screen or device is able to be removed, unlocked or overridden.
- (c) A barrier with a height not less than 865 mm above the floor is *required* to an openable window—
 - (i) in addition to window protection, when a child resistant release mechanism is *required* by (b)(ii)(C); and
 - (ii) where the floor below the window is 4 m or more above the surface beneath if the window is not covered by (a).
- (d) A barrier covered by (c) except for (e) must not—
 - (i) permit a 125 mm sphere to pass through it; and
 - (ii) have any horizontal or near horizontal elements between 150 mm and 760 mm above the floor that facilitate climbing.
- (e) A barrier *required* by (c) to an openable window in—
 - (i) *fire-isolated stairways*, *fire-isolated ramps* and other areas used primarily for emergency purposes, excluding external stairways and external ramps; and
 - (ii) Class 7 (other than *carparks*) and Class 8 buildings and parts of buildings containing those classes, must not permit a 300 mm sphere to pass through it.

D2.25 Timber stairways: Concession

- (a) Notwithstanding D2.2(a), timber treads, risers, landings and associated supporting framework which—
 - (i) has a finished thickness of not less than 44 mm; and
 - (ii) has an average density of not less than 800 kg/m³ at a moisture content of 12%, may be used within a *required fire-isolated stairway* or *fire-isolated passageway* constructed from *fire-protected timber* in accordance with C1.13 subject to—
 - (iii) the building being protected throughout by a sprinkler system (other than a FPAA101D system) complying with *Specification E1.5* which extends to within the fire-isolated enclosure; and
 - (iv) fire protection being provided to the underside of stair *flights* and landings located immediately above a landing level which—
 - (A) is at or near the level of egress; or

Access and egress

Deemed-to-Satisfy Provisions

- (B) provides direct access to a carpark.
- (b) Fire protection required by (a) must be not less than one layer of 13 mm fire-protective grade plasterboard fixed in accordance with the system requirements for a *fire-protective covering*.

NSW D2.101

Part D3 Access for people with a disability

Deemed-to-Satisfy Provisions

D3.0 Deemed-to-Satisfy Provisions

Tas D3.0

- (a) Where a *Deemed-to-Satisfy Solution* is proposed, *Performance Requirements DP1 to DP6, DP8 and DP9* are satisfied by complying with—
 - (i) *D1.1 to D1.16, D2.1 to D2.25 and D3.1 to D3.12*; and
 - (ii) in a building containing an *atrium, Part G3*; and
 - (iii) in a building in an *alpine area, Part G4*; and
 - (iv) for additional requirements for Class 9b buildings, *Part H1*; and
 - (v) for public transport buildings, *Part H2*.
- (b) Where a *Performance Solution* is proposed, the relevant *Performance Requirements* must be determined in accordance with *A2.2(3)* and *A2.4(3)* as applicable.
- (c) *Performance Requirement DP7* must be complied with if lifts are to be used to assist occupants to evacuate a building.

D3.1 General building access requirements

SA D3.1

Buildings and parts of buildings must be *accessible* as *required* by *Table D3.1*, unless exempted by *D3.4*.

Table D3.1 Requirements for access for people with a disability

Class of building	Access requirements
<p>Class 1b</p> <p>(a) Dwellings located on one allotment ^{Note 1} and used for short-term holiday accommodation, consisting of—</p> <ul style="list-style-type: none"> (i) 4 to 10 dwellings (ii) 11 to 40 dwellings (iii) 41 to 60 dwellings (iv) 61 to 80 dwellings (v) 81 to 100 dwellings (vi) more than 100 dwellings <p>(b) A boarding house, bed and breakfast, guest house, hostel or the like, other than those described in (a)</p>	<p>To and within—</p> <ul style="list-style-type: none"> 1 dwelling 2 dwellings 3 dwellings 4 dwellings 5 dwellings 5 dwellings plus 1 additional dwelling for each additional 30 dwellings or part thereof in excess of 100 dwellings. <p>To and within—</p> <ul style="list-style-type: none"> 1 bedroom and associated sanitary facilities; and not less than 1 of each type of room or space for use in common by the residents or guests, including a cooking facility, sauna, gymnasium, <i>swimming pool</i>, laundry, games room, eating area, or the like; and rooms or spaces for use in common by all residents on a floor to which access by way of a ramp complying with AS 1428.1 or a passenger lift is provided.
<p>Note 1: A community or strata-type subdivision or development is considered to be on a single allotment.</p>	
<p>Class 2</p> <p>Common areas</p>	<p>From a pedestrian entrance <i>required</i> to be <i>accessible</i> to at least 1 floor containing <i>sole-occupancy units</i> and to the entrance doorway of each <i>sole-occupancy unit</i> located on that level.</p>

Access and egress

Deemed-to-Satisfy Provisions

Class of building	Access requirements
	<p>To and within not less than 1 of each type of room or space for use in common by the residents, including a cooking facility, sauna, gymnasium, <i>swimming pool</i>, common laundry, games room, individual shop, eating area, or the like.</p> <p>Where a ramp complying with AS 1428.1 or a passenger lift is installed—</p> <p>(a) to the entrance doorway of each <i>sole-occupancy unit</i>; and</p> <p>(b) to and within rooms or spaces for use in common by the residents, located on the levels served by the lift or ramp.</p>
<p>Class 3 Common areas</p> <p><i>Sole-occupancy units</i></p> <p>If the building or group of buildings contain—</p> <p>1 to 10 <i>sole-occupancy units</i></p> <p>11 to 40 <i>sole-occupancy units</i></p> <p>41 to 60 <i>sole-occupancy units</i></p> <p>61 to 80 <i>sole-occupancy units</i></p> <p>81 to 100 <i>sole-occupancy units</i></p> <p>101 to 200 <i>sole-occupancy units</i></p> <p>201 to 500 <i>sole-occupancy units</i></p> <p>more than 500 <i>sole-occupancy units</i></p>	<p>From a pedestrian entrance <i>required</i> to be <i>accessible</i> to at least 1 floor containing <i>sole-occupancy units</i> and to the entrance doorway of each <i>sole-occupancy unit</i> located on that level.</p> <p>To and within not less than 1 of each type of room or space for use in common by the residents, including a cooking facility, sauna, gymnasium, <i>swimming pool</i>, common laundry, games room, TV room, individual shop, dining room, public viewing area, ticket purchasing service, lunch room, lounge room, or the like.</p> <p>Where a ramp complying with AS 1428.1 or a passenger lift is installed—</p> <p>(a) to the entrance doorway of each <i>sole-occupancy unit</i>; and</p> <p>(b) to and within rooms or spaces for use in common by the residents, located on the levels served by the lift or ramp.</p> <p>To and within—</p> <p>1 <i>accessible sole-occupancy unit</i>.</p> <p>2 <i>accessible sole-occupancy units</i>.</p> <p>3 <i>accessible sole-occupancy units</i>.</p> <p>4 <i>accessible sole-occupancy units</i>.</p> <p>5 <i>accessible sole-occupancy units</i>.</p> <p>5 <i>accessible sole-occupancy units</i> plus 1 additional <i>accessible sole-occupancy unit</i> for every 25 units or part thereof in excess of 100.</p> <p>9 <i>accessible sole-occupancy units</i> plus 1 additional <i>accessible sole-occupancy unit</i> for every 30 units or part thereof in excess of 200.</p> <p>19 <i>accessible sole-occupancy units</i> plus 1 additional <i>accessible sole-occupancy unit</i> for every 50 units or part thereof in excess of 500.</p> <p>Not more than 2 <i>required accessible sole-occupancy units</i> may be located adjacent to each other.</p> <p>Where more than 2 <i>accessible sole-occupancy units</i> are <i>required</i>, they must be representative of the range of rooms available.</p>
Class 5	To and within all areas normally used by the occupants.
Class 6	To and within all areas normally used by the occupants.
Class 7a	To and within any level containing <i>accessible</i> carparking

Access and egress

Deemed-to-Satisfy Provisions

Class of building	Access requirements
	(b) a change room facility; and (c) a public shelter or the like.
Class 10b <i>Swimming pool</i>	To and into <i>swimming pools</i> with a total perimeter greater than 40 m, associated with a Class 1b, 2, 3, 5, 6, 7, 8 or 9 building that is <i>required</i> to be <i>accessible</i> , but not <i>swimming pools</i> for the exclusive use of occupants of a Class 1b building or a <i>sole-occupancy unit</i> in a Class 2 or Class 3 building.

SA Table D3.1a

D3.2 Access to buildings

- (a) An *accessway* must be provided to a building *required* to be *accessible*—
- (i) from the main points of a pedestrian entry at the allotment boundary; and
 - (ii) from another *accessible* building connected by a pedestrian link; and
 - (iii) from any *required accessible* carparking space on the allotment.
- (b) In a building *required* to be *accessible*, an *accessway* must be provided through the principal pedestrian entrance, and—
- (i) through not less than 50% of all pedestrian entrances including the principal pedestrian entrance; and
 - (ii) in a building with a total *floor area* more than 500 m², a pedestrian entrance which is not *accessible* must not be located more than 50 m from an *accessible* pedestrian entrance, except for pedestrian entrances serving only areas exempted by D3.4.
- (c) Where a pedestrian entrance *required* to be *accessible* has multiple doorways—
- (i) if the pedestrian entrance consists of not more than 3 doorways — not less than 1 of those doorways must be *accessible*; and
 - (ii) if a pedestrian entrance consists of more than 3 doorways — not less than 50% of those doorways must be *accessible*.
- (d) For the purposes of (c)—
- (i) an *accessible* pedestrian entrance with multiple doorways is considered to be one pedestrian entrance where—
 - (A) all doorways serve the same part or parts of the building; and
 - (B) the distance between each doorway is not more than the width of the widest doorway at that pedestrian entrance (see Figure D3.2); and
 - (ii) a doorway is considered to be the clear, unobstructed opening created by the opening of one or more door leaves (see Figure D3.2).
- (e) Where a doorway on an *accessway* has multiple leaves, (except an automatic opening door) one of those leaves must have a clear opening width of not less than 850 mm in accordance with AS 1428.1.

Access and egress

Deemed-to-Satisfy Provisions

Figure D3.2 Doorways and pedestrian entrances for access purposes

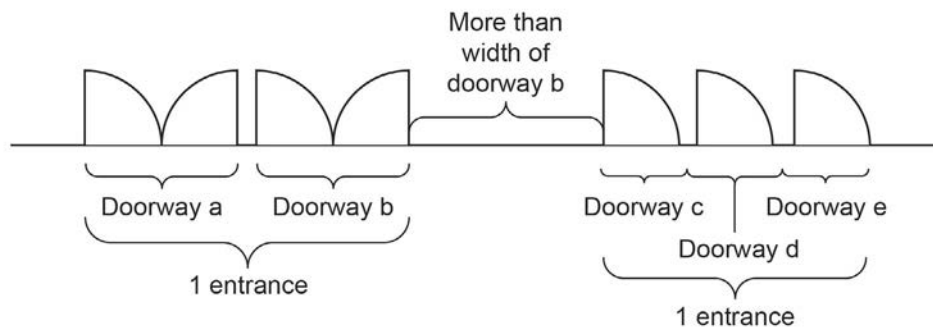

D3.3 Parts of buildings to be accessible

In a building *required* to be *accessible*—

- (a) every ramp and stairway, except for ramps and stairways in areas exempted by D3.4, must comply with—
 - (i) for a ramp, except a *fire-isolated ramp*, clause 10 of AS 1428.1; and
 - (ii) for a stairway, except a *fire-isolated stairway*, clause 11 of AS 1428.1; and
 - (iii) for a *fire-isolated stairway*, clause 11.1(f) and (g) of AS 1428.1; and
- (b) every passenger lift must comply with E3.6; and
- (c) *accessways* must have—
 - (i) passing spaces complying with AS 1428.1 at maximum 20 m intervals on those parts of an *accessway* where a direct line of sight is not available; and
 - (ii) turning spaces complying with AS 1428.1—
 - (A) within 2 m of the end of *accessways* where it is not possible to continue travelling along the *accessway*; and
 - (B) at maximum 20 m intervals along the *accessway*; and
- (d) an intersection of *accessways* satisfies the spatial requirements for a passing and turning space; and
- (e) a passing space may serve as a turning space; and
- (f) a ramp complying with AS 1428.1 or a passenger lift need not be provided to serve a *storey* or level other than the entrance *storey* in a Class 5, 6, 7b or 8 building—
 - (i) containing not more than 3 *storeys*; and
 - (ii) with a *floor area* for each *storey*, excluding the entrance *storey*, of not more than 200 m²; and
- (g) clause 7.4.1(a) of AS 1428.1 does not apply and is replaced with ‘the pile height or pile thickness shall not exceed 11 mm and the carpet backing thickness shall not exceed 4 mm’; and
- (h) the carpet pile height or pile thickness dimension, carpet backing thickness dimension and their combined dimension shown in Figure 8 of AS 1428.1 do not apply and are replaced with 11 mm, 4 mm and 15 mm respectively.

D3.4 Exemptions

The following areas are not *required* to be *accessible*:

- (a) An area where access would be inappropriate because of the particular purpose for which the area is used.
- (b) An area that would pose a health or safety risk for people with a disability.
- (c) Any path of travel providing access only to an area exempted by (a) or (b).

ACT Appendix

Access and egress

Deemed-to-Satisfy Provisions

SA D3.4(d)

Tas D3.4(d)

D3.5 Accessible carparking

Accessible carparking spaces—

- (a) subject to (b), must be provided in accordance with Table D3.5 in—
 - (i) a Class 7a building *required* to be *accessible*; and
 - (ii) a carparking area on the same allotment as a building *required* to be *accessible*; and
- (b) need not be provided in a Class 7a building or a carparking area where a parking service is provided and direct access to any of the carparking spaces is not available to the public; and
- (c) subject to (d), must comply with AS/NZS 2890.6; and
- (d) need not be identified with signage where there is a total of not more than 5 carparking spaces, so as to restrict the use of the carparking space only for people with a disability.

Table D3.5 Carparking spaces for people with a disability

Class of building to which the <i>carpark</i> or carparking area is associated	Number of <i>accessible</i> carparking spaces <i>re-quired</i>
Class 1b and 3 (a) Boarding house, guest house, hostel, lodging house, backpackers accommodation, or the residential part of a hotel or motel. (b) Residential part of a <i>school</i> , accommodation for the aged, disabled or children, residential part of a <i>health-care building</i> which accommodates members of staff or the residential part of a <i>detention centre</i> .	To be calculated by multiplying the total number of carparking spaces by the percentage of— (i) <i>accessible sole-occupancy units</i> to the total number of <i>sole-occupancy units</i> ; or (ii) <i>accessible</i> bedrooms to the total number of bedrooms; and the calculated number is to be taken to the next whole figure. 1 space for every 100 carparking spaces or part thereof.
Class 5, 7, 8 or 9c	1 space for every 100 carparking spaces or part thereof.
Class 6 (a) Up to 1000 carparking spaces; and (b) for each additional 100 carparking spaces or part thereof in excess of 1000 carparking spaces.	1 space for every 50 carparking spaces or part thereof. 1 space.
Class 9a (a) Hospital (non-outpatient area) (b) Hospital (outpatient area)— (i) up to 1000 carparking spaces; and (ii) for each additional 100 carparking spaces or part thereof in excess of 1000 carparking spaces. (c) Nursing home (d) Clinic or day surgery not forming part of a hospital.	1 space for every 100 carparking spaces or part thereof. 1 space for every 50 carparking spaces or part thereof. 1 space. 1 space for every 100 carparking spaces or part thereof. 1 space for every 50 carparking spaces or part thereof.
Class 9b (a) <i>School</i> (b) Other <i>assembly building</i> —	1 space for every 100 carparking spaces or part thereof.

Access and egress

Deemed-to-Satisfy Provisions

Class of building to which the <i>carpark</i> or carparking area is associated	Number of <i>accessible</i> carparking spaces <i>required</i>
(i) up to 1000 carparking spaces; and	1 space for every 50 carparking spaces or part thereof.
(ii) for each additional 100 carparking spaces or part thereof in excess of 1000 carparking spaces.	1 space.

D3.6 Signage

In a building *required* to be *accessible*—

- (a) braille and tactile signage complying with [Specification D3.6](#) must—
 - (i) incorporate the international symbol of access or deafness, as appropriate, in accordance with AS 1428.1 and identify each—
 - (A) sanitary facility, except a sanitary facility associated with a bedroom in a Class 1b building or a *sole-occupancy unit* in a Class 3 or Class 9c building; and
 - (B) space with a hearing augmentation system; and
 - (ii) identify each door *required* by [E4.5](#) to be provided with an *exit* sign and state—
 - (A) “**Exit**”; and
 - (B) “**Level**”; and either
 - (aa) the floor level number; or
 - (bb) a floor level descriptor; or
 - (cc) a combination of [\(aa\)](#) and [\(bb\)](#); and
- (b) signage including the international symbol for deafness in accordance with AS 1428.1 must be provided within a room containing a hearing augmentation system identifying—
 - (i) the type of hearing augmentation; and
 - (ii) the area covered within the room; and
 - (iii) if receivers are being used and where the receivers can be obtained; and
- (c) signage in accordance with AS 1428.1 must be provided for *accessible* unisex sanitary facilities to identify if the facility is suitable for left or right handed use; and
- (d) signage to identify an ambulant *accessible* sanitary facility in accordance with AS 1428.1 must be located on the door of the facility; and
- (e) where a pedestrian entrance is not *accessible*, directional signage incorporating the international symbol of access, in accordance with AS 1428.1 must be provided to direct a person to the location of the nearest *accessible* pedestrian entrance; and
- (f) where a bank of sanitary facilities is not provided with an *accessible* unisex sanitary facility, directional signage incorporating the international symbol of access in accordance with AS 1428.1 must be placed at the location of the sanitary facilities that are not *accessible*, to direct a person to the location of the nearest *accessible* unisex sanitary facility; and
- (g) in a building subject to [F2.9](#), directional signage complying with [Specification D3.6](#) must be provided at the location of each—
 - (i) bank of sanitary facilities; and
 - (ii) *accessible* unisex sanitary facility, other than one that incorporates an *accessible* adult change facility, to direct a person to the location of the nearest *accessible* adult change facility within that building.

D3.7 Hearing augmentation

- (a) A hearing augmentation system must be provided where an inbuilt amplification system, other than one used only for emergency warning, is installed—
 - (i) in a room in a Class 9b building; or

Access and egress

Deemed-to-Satisfy Provisions

- (ii) in an auditorium, conference room, meeting room or room for judicatory purposes; or
 - (iii) at any ticket office, teller's booth, reception area or the like, where the public is screened from the service provider.
- (b) If a hearing augmentation system *required* by (a) is—
- (i) an induction loop, it must be provided to not less than 80% of the *floor area* of the room or space served by the inbuilt amplification system; or
 - (ii) a system requiring the use of receivers or the like, it must be available to not less than 95% of the *floor area* of the room or space served by the inbuilt amplification system, and the number of receivers provided must not be less than—
 - (A) if the room or space accommodates up to 500 persons, 1 receiver for every 25 persons or part thereof, or 2 receivers, whichever is the greater; and
 - (B) if the room or space accommodates more than 500 persons but not more than 1000 persons, 20 receivers plus 1 receiver for every 33 persons or part thereof in excess of 500 persons; and
 - (C) if the room or space accommodates more than 1000 persons but not more than 2000 persons, 35 receivers plus 1 receiver for every 50 persons or part thereof in excess of 1000 persons; and
 - (D) if the room or space accommodates more than 2000 persons, 55 receivers plus 1 receiver for every 100 persons or part thereof in excess of 2000 persons.
- (c) The number of persons accommodated in the room or space served by an inbuilt amplification system must be calculated according to [D1.13](#).
- (d) Any screen or scoreboard associated with a Class 9b building and capable of displaying public announcements must be capable of supplementing any public address system, other than a public address system used for emergency warning purposes only.

D3.8 Tactile indicators

- (a) For a building *required* to be *accessible*, tactile ground surface indicators must be provided to warn people who are blind or have a vision impairment that they are approaching—
- (i) a stairway, other than a *fire-isolated stairway*; and
 - (ii) an escalator; and
 - (iii) a passenger conveyor or moving walk; and
 - (iv) a ramp other than a *fire-isolated ramp*, step ramp, kerb ramp or *swimming pool* ramp; and
 - (v) in the absence of a suitable barrier—
 - (A) an overhead obstruction less than 2 m above floor level, other than a doorway; and
 - (B) an *accessway* meeting a vehicular way adjacent to any pedestrian entrance to a building, excluding a pedestrian entrance serving an area referred to in [D3.4](#), if there is no kerb or kerb ramp at that point, except for areas exempted by [D3.4](#).
- (b) Tactile ground surface indicators *required* by (a) must comply with sections 1 and 2 of AS/NZS 1428.4.1.
- (c) A hostel for the aged, nursing home for the aged, a *residential aged care building*, Class 3 accommodation for the aged, Class 9a *health-care building* or a Class 9c *aged care building* need not comply with (a)(i) and (iv) if handrails incorporating a raised dome button in accordance with AS/NZS 1428.4.1 are provided to warn people who are blind or have a vision impairment that they are approaching a stairway or ramp.

D3.9 Wheelchair seating spaces in Class 9b assembly buildings

Where fixed seating is provided in a Class 9b *assembly building*, wheelchair seating spaces complying with AS 1428.1 must be provided in accordance with the following:

- (a) The number and grouping of wheelchair seating spaces must be in accordance with [Table D3.9](#).
- (b) In a cinema—
 - (i) with not more than 300 seats — wheelchair seating spaces must not be located in the front row of seats; and

Access and egress

Deemed-to-Satisfy Provisions

- (ii) with more than 300 seats — not less than 75% of *required* wheelchair seating spaces must be located in rows other than the front row of seats.

Table D3.9 Wheelchair seating spaces in Class 9b assembly buildings

Number of fixed seats in a room or space	Number of wheelchair seating spaces	Grouping and location
Up to 150	3 spaces	1 single space; and 1 group of 2 spaces.
151 to 800	3 spaces; plus 1 additional space for each additional 50 seats or part thereof in excess of 150 seats	Not less than 1 single space; and not less than 1 group of 2 spaces; and not more than 5 spaces in any other group.
801 to 10 000	16 spaces; plus 1 additional space for each additional 100 seats or part thereof in excess of 800 seats	Not less than 2 single spaces; and not less than 2 groups of 2 spaces; and not more than 5 spaces in any other group; and the location of spaces is to be representative of the range of seating provided.
More than 10 000	108 spaces; plus 1 additional space for each additional 200 seats or part thereof in excess of 10 000 seats	Not less than 5 single spaces; and not less than 5 groups of 2 spaces; and not more than 10 spaces in any other group; and the location of spaces is to be representative of the range of seating provided.

D3.10 Swimming pools

- (a) Not less than 1 means of *accessible* water entry/exit in accordance with [Specification D3.10](#) must be provided for each *swimming pool required* by [Table D3.1](#) to be *accessible*.
- (b) An *accessible* entry/exit must be by means of—
- (i) a fixed or movable ramp and an aquatic wheelchair; or
 - (ii) a zero depth entry and an aquatic wheelchair; or
 - (iii) a platform *swimming pool* lift and an aquatic wheelchair; or
 - (iv) a sling-style *swimming pool* lift.
- (c) Where a *swimming pool* has a perimeter of more than 70 m, at least one *accessible* water entry/exit must be provided by a means specified in (b)(i), (ii) or (iii).
- (d) Latching devices on gates and doors forming part of a *swimming pool* safety barrier need not comply with AS 1428.1.

D3.11 Ramps

On an *accessway*—

- (a) a series of connected ramps must not have a combined vertical rise of more than 3.6 m; and
- (b) a landing for a step ramp must not overlap a landing for another step ramp or ramp.

D3.12 Glazing on an accessway

On an *accessway*, where there is no chair rail, handrail or transom, all frameless or fully glazed doors, sidelights and any glazing capable of being mistaken for a doorway or opening, must be clearly marked in accordance with AS 1428.1.

[Tas D3.13](#)

Specification D1.12

Non-required stairways, ramps and escalators

Deemed-to-Satisfy Provisions

1. Scope

This Specification contains the requirements to allow non-*required* stairways, ramps or escalators to connect any number of *storeys* in a Class 5 or 6 building. The requirements do not apply in an *atrium* or outside a building.

2. Requirements

An escalator, moving walkway or non-*required* non-*fire-isolated stairway* or pedestrian ramp must comply with the following:

- (a) The escalator, walkway, stairway or ramp must be bounded by a *shaft* of—
 - (i) construction with an FRL of not less than 120/120/120 if *loadbearing* or –/120/120 if non-*loadbearing* and if of *lightweight construction* must comply with [Specification C1.8](#); or
 - (ii) glazed construction with an FRL of not less than –/60/30 protected by a wall wetting system in accordance with [Clause 2 of Specification G3.8](#).
- (b) The void of each non-*required* stairway, ramp or escalator must not connect more than 2 *storeys*.
- (c) Rising and descending escalators, walkways, stairways and ramps within one *shaft* must be separated by construction with an FRL of not less than –/60/30.
- (d) Openings into the *shaft* must be protected by fire doors with an FRL not less than –/60/30.
- (e) When the fire door is in the closed position, the floor or any covering over the floor beneath the fire door must not be *combustible*.
- (f) Fire doors must be fitted with smoke seals and the assembly must be tested in accordance with AS 1530.4.
- (g) Fire doors must be—
 - (i) closed and locked for security reasons; or
 - (ii) held open and be *automatic* closing.
- (h) Smoke detectors must be installed on both sides of the opening, not more than 1.5 m horizontal distance from the opening.
- (i) In the closed position, fire doors must be openable on a single hand downward action or horizontal pushing action on a single device within the *shaft* and by key only from outside the *shaft*.
- (j) A warning sign must be displayed where it can readily be seen outside the *shaft* near all fire doors opening to the *shaft*. The sign must comply with the details and dimensions of [Figure 2](#).

Figure 2 Warning sign for non-required stairway, ramp or escalator

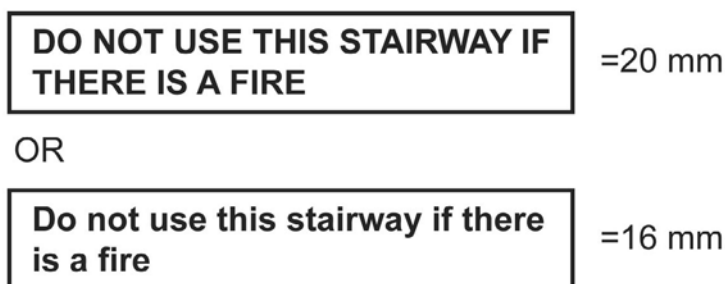

- (k) All doors opening into the *shaft* must be within 20 m of a *required exit*.

Access and egress

Deemed-to-Satisfy Provisions

- (l) Signs showing the direction of the nearest *required exit* must be installed where they can be readily seen.
- (m) Materials attached to any wall, ceiling or floor within the *shaft* must comply with [Specification C1.10](#).
- (n) Emergency lighting must be installed in the *shaft* in accordance with [E4.4](#).
- (o) No step or ramp may be closer to the threshold of the doorway than the width of the door leaf.

Specification D3.6

Braille and tactile signs

Deemed-to-Satisfy Provisions

1. Scope

This Specification sets out the requirements for the design and installation of braille and tactile signage as *required* by [D2.21](#), [D3.6](#) and [Specification F2.9](#).

2. Location of braille and tactile signs

Signs including symbols, numbering and lettering must be designed and installed as follows:

- (a) Braille and tactile components of a sign must be located not less than 1200 mm and not higher than 1600 mm above the floor or ground surface.
- (b) Signs with single lines of characters must have the line of tactile characters not less than 1250 mm and not higher than 1350 mm above the floor or ground surface.
- (c) Signs identifying rooms containing features or facilities listed in [D3.6](#) must be located—
 - (i) on the wall on the latch side of the door with the leading edge of the sign located between 50 mm and 300 mm from the architrave; and
 - (ii) where (i) is not possible, the sign may be placed on the door itself.
- (d) Signs identifying a door *required* by [E4.5](#) to be provided with an *exit* sign must be located—
 - (i) on the side that faces a person seeking egress; and
 - (ii) on the wall on the latch side of the door with the leading edge of the sign located between 50 mm and 300 mm from the architrave; and
 - (iii) where (ii) is not possible, the sign may be placed on the door itself.

3. Braille and tactile sign specification

- (a) Tactile characters must be raised or embossed to a height of not less than 1 mm and not more than 1.5 mm.
- (b) Title case must be used for all tactile characters, and—
 - (i) upper case tactile characters must have a height of not less than 15 mm and not more than 55 mm, except that the upper case tactile characters on a sign identifying a door *required* by [E4.5](#) to be provided with an *exit* sign must have a height of not less than 20 mm and not more than 55 mm; and
 - (ii) lower case tactile characters must have a minimum height of 50% of the related upper case characters.
- (c) Tactile characters, symbols, and the like, must have rounded edges.
- (d) The entire sign, including any frame, must have all edges rounded.
- (e) The background, negative space or fill of signs must be of matt or low sheen finish.
- (f) The characters, symbols, logos and other features on signs must be matt or low sheen finish.
- (g) The minimum letter spacing of tactile characters on signs must be 2 mm.
- (h) The minimum word spacing of tactile characters on signs must be 10 mm.
- (i) The thickness of letter strokes must be not less than 2 mm and not more than 7 mm.
- (j) Tactile text must be left justified, except that single words may be centre justified.
- (k) Tactile text must be Arial typeface.

4. Luminance contrast

The following applies to *luminance contrast*:

- (a) The background, negative space, fill of a sign or border with a minimum width of 5 mm must have a *luminance*

Access and egress

Deemed-to-Satisfy Provisions

contrast with the surface on which it is mounted of not less than 30%.

- (b) Tactile characters, icons and symbols must have a minimum *luminance contrast* of 30% to the surface on which the characters are mounted.
- (c) *Luminance contrasts* must be met under the lighting conditions in which the sign is to be located.

5. Lighting

Braille and tactile signs must be illuminated to ensure *luminance contrast* requirements are met at all times during which the sign is required to be read.

6. Braille

The following applies to braille:

- (a) Braille must be grade 1 braille (uncontracted) in accordance with the criteria set out by the Australian Braille Authority.
- (b) Braille must be raised and domed.
- (c) Braille must be located 8 mm below the bottom line of text (not including descenders).
- (d) Braille must be left justified.
- (e) Where an arrow is used in the tactile sign, a solid arrow must be provided for braille readers.
- (f) On signs with multiple lines of text and characters, a semicircular braille locator at the left margin must be horizontally aligned with the first line of braille text.

Specification D3.10

Accessible water entry/exit for swimming pools

Deemed-to-Satisfy Provisions

1. Scope

This Specification sets out the requirements for types of *accessible* water entry/exit for *swimming pools*.

2. Fixed or moveable ramp

A fixed or moveable ramp must—

- (a) have a slip-resistant surface; and
- (b) have a maximum gradient of 1:14; and
- (c) have handrails complying with the requirements for ramps in AS 1428.1, installed on both sides of the ramp; and
- (d) have kerbs in accordance with the requirements for ramps in AS 1428.1; and
- (e) extend to a depth of not less than 900 mm and not more than 1100 mm below the stationary water level; and
- (f) have landings in accordance with the requirements for ramps in AS 1428.1, with a landing located at the bottom and top of each ramp and a landing must be located at a level between 900 mm and 1100 mm below the stationary water level.

3. Zero depth entry

A zero depth entry must have—

- (a) a slip-resistant surface; and
- (b) a maximum gradient of 1:14; and
- (c) a single handrail complying with the requirements for handrails in AS 1428.1, from the top of the entry point continuous to the bottom level area; and
- (d) a level area—
 - (i) 1500 mm long for the width of the zero depth entry at the entry point; and
 - (ii) located at the bottom of the zero depth entry at a level between 900 mm and 1100 mm below the stationary water level.

4. Platform swimming pool lift

A platform *swimming pool* lift must be—

- (a) capable of being operated from the *swimming pool* surround, within the *swimming pool*, and on the platform; and
- (b) located where the water depth is not more than 1300 mm; and
- (c) designed to withstand a weight capacity of not less than 160 kg and be capable of sustaining a static load of not less than 1.5 times the rated load.

5. Sling-style swimming pool lift

A sling lift must comply with the following:

- (a) A sling lift must be located where the water depth is not more than 1300 mm.
- (b) When the sling is in the raised position and in the transfer position, the centreline of the sling must be located over the *swimming pool* surround and not less than 450 mm from the *swimming pool* edge.
- (c) The surface of the *swimming pool* surround between the centreline of the sling and the *swimming pool* edge must have a gradient of not more than 1:50 and must be slip-resistant.

Access and egress

Deemed-to-Satisfy Provisions

- (d) A clear space—
- (i) not less than 900 mm x 1300 mm; and
 - (ii) with a gradient of not more than 1:50; and
 - (iii) having a slip-resistant surface; and
 - (iv) located so that the centreline of the space is directly below the lifting point for the sling, must be provided on the *swimming pool* surround parallel with the *swimming pool* edge on the side remote from the water (see [Figures 5a](#) and [b](#)).
- (e) A sling lift must be capable of being operated from the *swimming pool* surround, within the *swimming pool* and from the sling.
- (f) A sling must be designed so that it will submerge to a water depth of not less than 500 mm below the stationary water level.
- (g) A sling lift must be designed to withstand a weight of not less than 136 kg and be capable of sustaining a static load not less than 1.5 times the rated load.

Figure 5 Clear swimming pool surround space for sling lift in the transfer position

Figure 5a Plan view

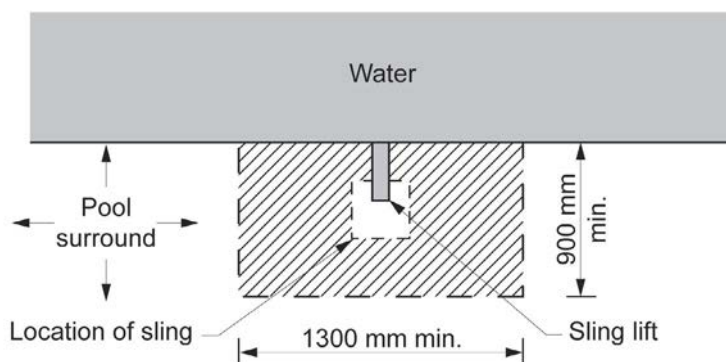
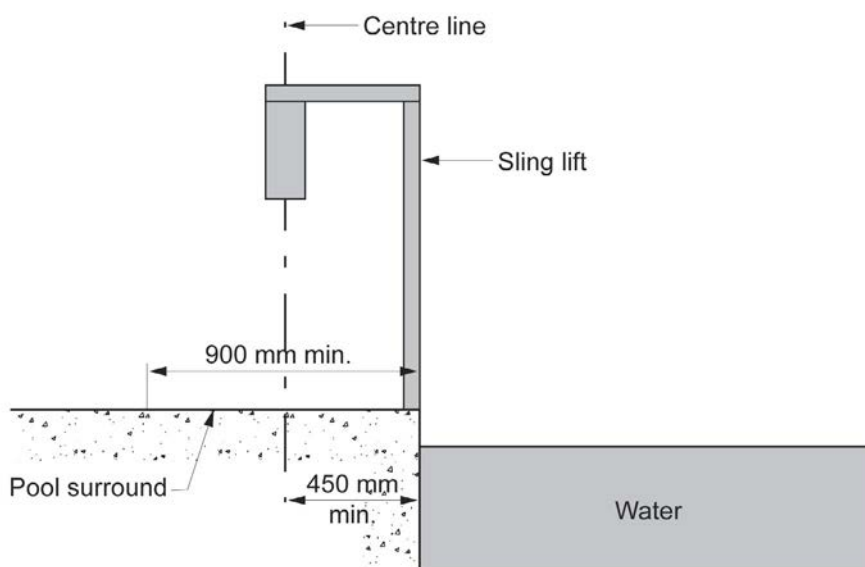

Figure 5b Sectional elevation



*Deemed-to-Satisfy Provisions***6. Aquatic wheelchair**

An aquatic wheelchair must comply with the following:

- (a) The height of the top surface of the seat must be not less than 430 mm.
- (b) The seat width must not be not less than 480 mm.
- (c) A footrest must be provided.
- (d) Armrests must be located on both sides of the seat and must be capable of being moved away from the side of the chair to allow a person to transfer on and off the seat.

Services and equipment

- Part E1** **Fire fighting equipment**
- Part E2** **Smoke hazard management**
- Part E3** **Lift installations**
- Part E4** **Visibility in an emergency, exit signs and warning systems**

Section E Services and equipment

Part E1 Fire fighting equipment

Performance Requirements

- EP1.1 Fire hose reels
- EP1.2 Fire extinguishers
- EP1.3 Fire hydrants
- EP1.4 Automatic fire suppression systems
- EP1.5 Fire-fighting services in buildings under construction
- EP1.6 Fire control centres

Verification Methods

- EV1.1 Fire Safety Verification Method
- E1.0 Deemed-to-Satisfy Provisions
- E1.1 * * * * *
- E1.2 * * * * *
- E1.3 Fire hydrants
- E1.4 Fire hose reels
- E1.5 Sprinklers
- E1.6 Portable fire extinguishers
- E1.7 * * * * *
- E1.8 Fire control centres
- E1.9 Fire precautions during construction
- E1.10 Provision for special hazards

Specification E1.5 Fire sprinkler systems

1. Scope
2. Application of automatic fire sprinkler standards
3. Separation of sprinklered and non-sprinklered areas
4. Protection of openings
5. Fast response sprinklers
6. Sprinkler valve enclosures
7. Water supply
8. Building occupant warning system
9. Connection to other systems
10. Anti-tamper devices
11. Sprinkler systems in carparks
12. Residential care buildings
13. Sprinkler systems in lift installations

Specification E1.5a Class 2 and 3 buildings not more than 25 m in effective height

1. Scope and application
2. System requirements

Specification E1.8 Fire control centres

1. Scope
2. Purpose and content
3. Location of fire control centre
4. Equipment not permitted within a fire control centre
5. Ambient sound level for a fire control centre
6. Construction of a fire control room
7. Protection of openings in a fire control room
8. Doors to a fire control room
9. Size and contents of a fire control room

10. Ventilation and power supply for a fire control room
11. Sign for a fire control room
12. Lighting for a fire control room

Part E2 Smoke hazard management

Performance Requirements

EP2.1 Automatic warning for sleeping occupants

EP2.2 Safe evacuation routes

Verification Methods

EV2.1 Fire Safety Verification Method

E2.0 Deemed-to-Satisfy Provisions

E2.1 Application of Part

E2.2 General requirements

E2.3 Provision for special hazards

Specification E2.2a Smoke detection and alarm systems

1. Scope
2. Type of system
3. Smoke alarm system
4. Smoke detection system
5. Combined smoke alarm and smoke detection system
6. Smoke detection for smoke control systems
7. Building occupant warning system
8. System monitoring

Specification E2.2b Smoke exhaust systems

1. Scope
2. Smoke exhaust capacity
3. Smoke exhaust fans
4. Smoke reservoirs
5. Smoke exhaust fan and vent location
6. Make-up air
7. Smoke exhaust system control
8. Smoke detection

Specification E2.2c Smoke-and-heat vents

1. Adoption of AS 2665
2. Controls

Specification E2.2d Residential fire safety systems

1. Application
2. Residential local fire alarm systems — Residential care buildings
3. Connection of residential sprinkler systems to a fire station or other approved monitoring service

Part E3 Lift installations

Performance Requirements

EP3.1 Stretcher facilities

EP3.2 Emergency lifts

EP3.3 Emergency alerts

EP3.4 Lift access for people with a disability

Verification Methods

EV3.1 Fire Safety Verification Method

EV3.2 Emergency alerts on the use of lifts

E3.0 Deemed-to-Satisfy Provisions

E3.1 Lift installations

- E3.2 Stretcher facility in lifts
- E3.3 Warning against use of lifts in fire
- E3.4 Emergency lifts
- E3.5 Landings
- E3.6 Passenger lifts
- E3.7 Fire service controls
- E3.8 Residential care buildings
- E3.9 Fire service recall control switch
- E3.10 Lift car fire service drive control switch

Specification E3.1 Lift installations

1. Scope
2. Lift cars exposed to solar radiation
3. Lift car emergency lighting
4. Cooling of lift shaft
5. Lift foyer access
6. Emergency access doors in a single enclosed lift shaft

Part E4 Visibility in an emergency, exit signs and warning systems

Performance Requirements

- EP4.1 Visibility in an emergency
- EP4.2 Identification of exits
- EP4.3 Emergency warning and intercom systems

Verification Methods

- EV4.1 Emergency lighting
- EV4.2 Fire Safety Verification Method
- E4.0 Deemed-to-Satisfy Provisions
- E4.1 * * * * *
- E4.2 Emergency lighting requirements
- E4.3 Measurement of distance
- E4.4 Design and operation of emergency lighting
- E4.5 Exit signs
- E4.6 Direction signs
- E4.7 Class 2 and 3 buildings and Class 4 parts: Exemptions
- E4.8 Design and operation of exit signs
- E4.9 Emergency warning and intercom systems

Specification E4.8 Photoluminescent exit signs

1. Scope
2. Application
3. Illumination
4. Pictorial elements
5. Viewing distance
6. Smoke control systems

Part E1 Fire fighting equipment

Performance Requirements

EP1.1 Fire hose reels

A fire hose reel system must be installed to the degree necessary to allow occupants to safely undertake initial attack on a fire appropriate to—

- (a) the size of the *fire compartment*; and
- (b) the function or use of the building; and
- (c) any other *fire safety systems* installed in the building; and
- (d) the *fire hazard*.

EP1.2 Fire extinguishers

Fire extinguishers must be installed to the degree necessary to allow occupants to undertake initial attack on a fire appropriate to—

- (a) the function or use of the building; and
- (b) any other *fire safety systems* installed in the building; and
- (c) the *fire hazard*.

EP1.3 Fire hydrants

A fire hydrant system must be provided to the degree necessary to facilitate the needs of the *fire brigade* appropriate to—

- (a) fire-fighting operations; and
- (b) the *floor area* of the building; and
- (c) the *fire hazard*.

Application:

EP1.3 only applies to a building where a *fire brigade* is available to attend.

EP1.4 Automatic fire suppression systems

NSW EP1.4

An *automatic* fire suppression system must be installed to the degree necessary to control the development and spread of fire appropriate to—

- (a) the size of the *fire compartment*; and
- (b) the function or use of the building; and
- (c) the *fire hazard*; and
- (d) the height of the building.

EP1.5 Fire-fighting services in buildings under construction

Suitable means of fire-fighting must be installed to the degree necessary in a building under construction to allow initial fire attack by construction workers and for the *fire brigade* to undertake attack on the fire appropriate to—

- (a) the *fire hazard*; and
- (b) the height the building has reached during its construction.

EP1.6 Fire control centres

Suitable facilities must be provided to the degree necessary in a building to co-ordinate *fire brigade* intervention during an

emergency appropriate to—

- (a) the function or use of the building; and
- (b) the *floor area* of the building; and
- (c) the height of the building.

Tas EP1.7

Verification Methods

EV1.1 Fire Safety Verification Method

Compliance with [EP1.1](#), [EP1.2](#), [EP1.3](#), [EP1.4](#) and [EP1.6](#) is verified when a building is designed in accordance with [Schedule 7](#).

Part E1 Fire fighting equipment

Deemed-to-Satisfy Provisions

E1.0 Deemed-to-Satisfy Provisions

Tas E1.0

- (a) Where a *Deemed-to-Satisfy Solution* is proposed, *Performance Requirements EP1.1* to *EP1.6* are satisfied by complying with—
- (i) *E1.1* to *E1.10*; and
 - (ii) in a building containing an *atrium*, *Part G3*; and
 - (iii) in a building in an *alpine area*, *Part G4*; and
 - (iv) for a building containing an *occupiable outdoor area*, *Part G6*; and
 - (v) for additional requirements for Class 9b buildings, *Part H1*; and
 - (vi) for *farm buildings* and *farm sheds*, *Part H3*.
- (b) Where a *Performance Solution* is proposed, the relevant *Performance Requirements* must be determined in accordance with *A2.2(3)* and *A2.4(3)* as applicable.

E1.1 * * * * *

This clause has deliberately been left blank.

E1.2 * * * * *

This clause has deliberately been left blank.

E1.3 Fire hydrants

- (a) A fire hydrant system must be provided to serve a building—
- (i) having a total *floor area* greater than 500 m²; and
 - (ii) where a *fire brigade station* is—
 - (A) no more than 50 km from the building as measured along roads; and
 - (B) equipped with equipment capable of utilising a fire hydrant.
- (b) The fire hydrant system—
- (i) must be installed in accordance with AS 2419.1, except—
 - (A) a Class 8 *electricity network substation* need not comply with clause 4.2 of AS 2419.1 if—
 - (aa) it cannot be connected to a town main supply; and
 - (bb) one hour water storage is provided for fire-fighting; and
 - (B) where a sprinkler system is installed throughout a building in accordance with AS 2118.1, AS 2118.4, AS 2118.6, FPAA101H or FPAA101D the fire hydrant booster protection requirements of clauses 7.3(c)(ii) and 7.3(d)(iii) of AS 2419.1 do not apply; and
 - (C) a fire hydrant booster assembly may be located between 3.5 m and 10 m of the building, and need not comply with clause 7.3(d)(iii) of AS 2419.1 where the assembly is protected by an adjacent fire-rated freestanding wall that—
 - (aa) achieves an FRL of not less than 90/90/90; and
 - (bb) extends not less than 1 m each side of the outermost fire hydrant booster risers within the assembly and is not less than 3 m wide; and

Services and equipment

Deemed-to-Satisfy Provisions

- (cc) extends to a height of not less than 2 m above finished ground level; and
- (ii) where internal fire hydrants are provided, they must serve only the *storey* on which they are located except that a *sole-occupancy unit*—
 - (A) in a Class 2 or 3 building or Class 4 part of a building may be served by a single fire hydrant located at the level of egress from that *sole-occupancy unit*; or
 - (B) of not more than 2 *storeys* in a Class 5, 6, 7, 8 or 9 building may be served by a single fire hydrant located at the level of egress from that *sole-occupancy unit* provided the fire hydrant can provide coverage to the whole of the *sole-occupancy unit*.

SA E1.3(c), (d), (e) and (f)

E1.4 Fire hose reels

- (a) E1.4 does not apply to—
 - (i) a Class 2, 3 or 5 building or Class 4 part of a building; or
 - (ii) a Class 8 *electricity network substation*; or
 - (iii) a Class 9c building; or
 - (iv) classrooms and associated corridors in a primary or secondary *school*.

SA E1.4(a)(v) and (vi)
- (b) A fire hose reel system must be provided—
 - (i) to serve the whole building where one or more internal fire hydrants are installed; or
 - (ii) where internal fire hydrants are not installed, to serve any *fire compartment* with a *floor area* greater than 500 m².
- (c) The fire hose reel system must—
 - (i) have fire hose reels installed in accordance with AS 2441; and
 - (ii) provide fire hose reels to serve only the *storey* at which they are located, except a *sole-occupancy unit* of not more than 2 *storeys* in a Class 6, 7, 8 or 9 building may be served by a single fire hose reel located at the level of egress from that *sole-occupancy unit* provided the fire hose reel can provide coverage to the whole of the *sole-occupancy unit*.
- (d) Fire hose reels must be located internally, externally or in combination, to achieve the system coverage specified in AS 2441.
- (e) In achieving system coverage, one or a combination of the following criteria for individual internally located fire hose reels must be met in determining the layout of any fire hose reel system:
 - (i) Fire hose reels must be located adjacent to an internal fire hydrant (other than one within a fire-isolated *exit*), except that a fire hose reel need not be located adjacent to every fire hydrant, provided system coverage can be achieved.
 - (ii) Fire hose reels must be located within 4 m of an *exit*, except that a fire hose reel need not be located adjacent to every *exit*, provided system coverage can be achieved.
 - (iii) Where system coverage is not achieved by compliance with (i) and (ii), additional fire hose reels may be located in paths of travel to an *exit* to achieve the *required* coverage.
- (f) Fire hose reels must be located so that the fire hose will not need to pass through doorways fitted with fire or smoke doors, except—
 - (i) doorways in walls referred to in C2.5(a)(v) in a Class 9a building and C2.5(b)(iv) in a Class 9c building, separating ancillary use areas of high potential *fire hazard*; and
 - (ii) doorways in walls referred to in C2.12 or C2.13 separating equipment or electrical supply systems; and
 - (iii) doorway openings to *shafts* referred to in C3.13.
- (g) Where the normal water supply cannot achieve the flow and pressures required by AS 2441, or is unreliable—
 - (i) a pump; or

Services and equipment

Deemed-to-Satisfy Provisions

- (ii) water storage facility; or
 - (iii) both a pump and water storage facility,
- must be installed to provide the minimum flow and pressures required by clause 6.1 of AS 2441.

E1.5 Sprinklers

A sprinkler system must—

- (a) be installed in a building or part of a building when *required* by Table E1.5; and
- (b) comply with [Specification E1.5](#) and [Specification E1.5a](#) as applicable.

[NSW Table E1.5](#)

[NT Table E1.5](#)

[Vic Table E1.5](#)

Table E1.5 Requirements for sprinklers

Occupancy	Where sprinklers are required
All classes— (a) including an <i>open-deck carpark</i> within a multi-classified building; but (b) excluding— (i) an <i>open-deck carpark</i> being a separate building; and (ii) a Class 8 <i>electricity network substation</i> , with a <i>floor area</i> not more than 200 m ² , located within a multi-classified building.	Throughout the whole building if any part of the building has an <i>effective height</i> of more than 25 m.
Class 2 or 3 building (excluding a building used as a <i>residential care building</i>) and any other class of building (excluding a building used as a <i>residential care building</i>) containing a Class 2 or 3 part.	Throughout the whole building, including any part of another class, if any part of the building has a <i>rise in storeys</i> of 4 or more and an <i>effective height</i> of not more than 25 m.
Class 3 building used as a <i>residential care building</i>	Throughout the building and in any <i>fire compartment</i> containing a Class 3 part used for residential care.
Class 6	In <i>fire compartments</i> where either of the following apply: (a) A <i>floor area</i> of more than 3 500 m ² . (b) A volume more than 21 000 m ³ .
Class 7a, other than <i>open-deck carparks</i>	In <i>fire compartments</i> where more than 40 vehicles are accommodated.
Class 9a <i>health-care building</i> used as a <i>residential care building</i>	Throughout the building and in any <i>fire compartment</i> containing a Class 9a part used for residential care.
Class 9c building	Throughout the building and any <i>fire compartment</i> containing a Class 9c part.
Class 9b	see Part H1
Atrium construction	see Part G3
Large isolated buildings	see Clause C2.3
Occupancies of excessive hazard ^{Note 4}	In <i>fire compartments</i> where either of the following apply: (a) A <i>floor area</i> of more than 2 000 m ² . (b) A volume of more than 12 000 m ³ .

Notes to Table E1.5:

1. See [Specification C1.1](#) for use of sprinklers in Class 2 buildings and *carparks* generally.
2. See [Part E2](#) for use of sprinklers to satisfy Smoke Hazard Management provisions.
3. See [C1.13](#) and [Specification C1.1](#) for use of sprinklers in buildings containing *fire-protected timber*.

Services and equipment

Deemed-to-Satisfy Provisions

4. For the purposes of this Table, occupancies of excessive *fire hazard* comprise buildings which contain—
- a. hazardous processes or storage including the following:
 - i. Aircraft hangars.
 - ii. Cane furnishing manufacture, processing and storage.
 - iii. Fire-lighter and fireworks manufacture and warehousing.
 - iv. Foam plastic and foam plastic goods manufacture, processing and warehousing e.g. furniture factory.
 - v. Hydrocarbon based sheet product, manufacture, processing and warehousing e.g. vinyl floor coverings.
 - vi. Woodwool and other flammable loose fibrous material manufacture.
 - b. combustible goods with an aggregate volume exceeding 1000 m³ and stored to a height greater than 4 m including the following:
 - i. Aerosol packs with flammable contents.
 - ii. Carpets and clothing.
 - iii. Electrical appliances.
 - iv. Combustible compressed fibreboards (low and high density) and plywoods.
 - v. Combustible cartons, irrespective of content
 - vi. Esparto and other fibrous combustible material.
 - vii. Furniture including timber, cane and composite, where foamed rubber or plastics are incorporated.
 - viii. Paper storage (all forms of new or waste) e.g. bales, sheet, horizontal or vertical rolls, waxed coated or processed.
 - ix. Textiles raw and finished, e.g., rolled cloth, clothing and manchester
 - x. Timber storage including sheets, planks, boards, joists and cut sizes.
 - xi. Vinyl, plastic, foamed plastic, rubber and other combustible sheets, offcuts and random pieces and rolled material storage, e.g. carpet, tar paper, linoleum, wood veneer and foam mattresses.
 - xii. All materials having wrappings or preformed containers of foamed plastics.

E1.6 Portable fire extinguishers

- (a) Portable fire extinguishers must be—
 - (i) provided as listed in [Table E1.6](#); and
 - (ii) for a Class 2, 3 or 5 building or Class 4 part of a building, provided—
 - (A) to serve the whole Class 2, 3 or 5 building or Class 4 part of a building where one or more internal fire hydrants are installed; or
 - (B) where internal fire hydrants are not installed, to serve any *fire compartment* with a *floor area* greater than 500 m², and for the purposes of this clause, a *sole-occupancy unit* in a Class 2 or 3 building or Class 4 part of a building is considered to be a *fire compartment*; and
 - (iii) subject to (b), selected, located and distributed in accordance with Sections 1, 2, 3 and 4 of AS 2444.
- (b) Portable fire extinguishers provided in a Class 2 or 3 building or Class 4 part of a building must be—
 - (i) an ABE type fire extinguisher; and
 - (ii) a minimum size of 2.5 kg; and
 - (iii) distributed outside a *sole-occupancy unit*—
 - (A) to serve only the *storey* at which they are located; and
 - (B) so that the travel distance from the entrance doorway of any *sole-occupancy unit* to the nearest fire extinguisher is not more than 10 m.

[SA E1.6\(c\)](#) and [\(d\)](#)

Services and equipment

Deemed-to-Satisfy Provisions

Table E1.6 Requirements for extinguishers

Occupancy class	Risk class (as defined in AS 2444)
General provisions —Class 2 to 9 buildings (except within <i>sole-occupancy units</i> of a Class 9c building).	(a) To cover Class AE or E fire risks associated with emergency services switchboards. ^{Note 1} (b) To cover Class F fire risks involving cooking oils and fats in kitchens. (c) To cover Class B fire risks in locations where flammable liquids in excess of 50 litres are stored or used (not including that held in fuel tanks of vehicles). (d) To cover Class A fire risks in normally occupied <i>fire compartments</i> less than 500 m ² not provided with fire hose reels (excluding <i>open-deck carparks</i>). (e) To cover Class A fire risks in classrooms and associated corridors in primary and secondary schools not provided with fire hose reels. (f) To cover Class A fire risks associated with a Class 2, 3 or 5 building or Class 4 part of a building.
Specific provisions (in addition to general provisions)— (a) Class 9a <i>health-care building</i> , including a Class 9a building used as a <i>residential care building</i> . (b) Class 3 parts of detention and correctional occupancies. (c) Class 3 accommodation for children, aged persons and people with disabilities, including a Class 3 building used as a <i>residential care building</i> . (d) Class 9c building.	To cover Class A and E fire risks. ^{Note 2}

Notes to Table E1.6:

- For the purposes of this Table, an emergency services switchboard is one which sustains emergency equipment operating in the emergency mode.
- A Class E fire extinguisher need only be located at each nurses' station, supervisors' station or the like.
- Additional extinguishers may be required to cover fire risks in relation to special hazards provided for in E1.10.
- The fire risks in a Class 2 or 3 building or Class 4 part of a building must include risks within any *sole-occupancy units*, however portable fire extinguishers are not required to be located within a *sole-occupancy unit* unless the *sole-occupancy unit* has a *floor area* greater than 500 m².

E1.7 * * * * *

This clause has deliberately been left blank.

E1.8 Fire control centres

A fire control centre facility in accordance with [Specification E1.8](#) must be provided for—

- a building with an *effective height* of more than 25 m; and
- a Class 6, 7, 8 or 9 building with a total *floor area* of more than 18000 m².

E1.9 Fire precautions during construction

In a building under construction—

- not less than one fire extinguisher to suit Class A, B and C fires and electrical fires must be provided at all times on each *storey* adjacent to each *required exit* or temporary stairway or *exit*; and

Services and equipment

Deemed-to-Satisfy Provisions

- (b) after the building has reached an *effective height* of 12 m—
 - (i) the *required* fire hydrants and fire hose reels must be operational in at least every *storey* that is covered by the roof or the floor structure above, except the 2 uppermost *storeys*; and
 - (ii) any *required* booster connections must be installed.

E1.10 Provision for special hazards

Suitable additional provision must be made if special problems of fighting fire could arise because of—

- (a) the nature or quantity of materials stored, displayed or used in a building or on the allotment; or
- (b) the location of the building in relation to a water supply for fire-fighting purposes.

Tas E1.101

Explanatory information: Cross-volume considerations

Part B4 of NCC Volume Three sets out the requirements for access for maintenance to fire-fighting water services.

Specification E1.5

Fire sprinkler systems

Deemed-to-Satisfy Provisions

1. Scope

This Specification sets out requirements for the design and installation of fire sprinkler systems.

2. Application of automatic fire sprinkler standards

Vic Spec E1.5 2.

Subject to this Specification, an *automatic* fire sprinkler system must comply with—

- (a) for all building classifications: AS 2118.1; or
- (b) for a Class 2 or 3 building with an *effective height* of not more than 25 m and a *rise in storeys* of 4 or more: [Specification E1.5a](#) and the relevant provisions of this Specification as applicable; or
- (c) for Class 5, 6, 7, 8, 9a (other than a *residential care building*) or 9b parts of a building with an *effective height* not more than 25 m, which also contains Class 2 or 3 parts: a sprinkler system in accordance with [Specification E1.5a](#) as for a Class 2 or 3 building and the relevant provisions of this Specification except—
 - (i) a FPAA101D sprinkler system cannot be used where the Class 5, 6, 7, 8, 9a (other than a *residential care building*) or 9b parts—
 - (A) contain more than 2 *storeys*; or
 - (B) are more than 25% of the total floor area of the building; or
 - (C) are located above the fourth *storey*; and
 - (ii) a FPAA101D or FPAA101H sprinkler system cannot be used where the Class 7a part (other than an *open-deck carpark*) accommodates more than 40 vehicles; or
- (d) for a combined sprinkler and fire hydrant system: AS 2118.6; or
- (e) for a Class 9a *health-care building* used as a *residential care building*: AS 2118.4 as applicable; or
- (f) for a Class 2, 3 or 9c building: AS 2118.4 as applicable.

3. Separation of sprinklered and non-sprinklered areas

Where a part of a building is not protected with sprinklers, the sprinklered and non-sprinklered parts must be fire-separated with a wall or floor which must—

- (a) comply with any specific requirement of the *Deemed-to-Satisfy Provisions* of the BCA; or
- (b) where there is no specific requirement, comply with the relevant part of AS 2118, FPAA101D or FPAA101H.

4. Protection of openings

Any openings, including those for service penetrations, in construction separating sprinklered and non-sprinklered parts of a building, including the construction separating the areas nominated for omitted protection in AS 2118.1, must be protected in accordance with the *Deemed-to-Satisfy Provisions* of [Part C3](#).

5. Fast response sprinklers

Fast response sprinklers may be installed only if they are suitable for the type of application proposed and it is demonstrated that the sprinkler system is designed to accommodate their use.

6. Sprinkler valve enclosures

- (a) Sprinkler alarm valves must be located in a secure room or enclosure which has direct egress to a road or open space.
- (b) All sprinkler valve rooms and enclosures must be secured with a system suitable for use by the *fire brigade*.

Services and equipment

Deemed-to-Satisfy Provisions

7. Water supply

- (a) A *required* sprinkler system must be provided with at least one water supply.
- (b) A *required* sprinkler system in a building greater than 25 m in *effective height* must be provided with dual water supply except that a secondary water supply storage capacity of 25,000 litres may be used if—
 - (i) the storage tank is located at the topmost *storey* of the building; and
 - (ii) the building occupancy is classified as no more hazardous than Ordinary Hazard 2 (OH2) under AS 2118.1; and
 - (iii) an operational *fire brigade* service is available to attend a building fire.

8. Building occupant warning system

A *required* sprinkler system, except a FPAA101D sprinkler system, must be connected to and activate a building occupant warning system complying with [Clause 7 of Specification E2.2a](#).

9. Connection to other systems

Where a smoke hazard management system is installed and is actuated by smoke detectors, the sprinkler system must, wherever practicable, be arranged to also activate the smoke hazard management system.

10. Anti-tamper devices

- (a) Where a sprinkler system is installed—
 - (i) over any *stage* area in a theatre, public hall or the like, visual and audible status indication of sprinkler valves must be provided at the location normally used by the *stage* manager; or
 - (ii) in a space housing lift electrical and control equipment (including machine rooms, secondary floors and sheave rooms), any valves provided to control sprinklers in these spaces must be located adjacent to the space.
- (b) Any valves provided to control sprinklers required by (a) must be fitted with anti-tamper monitoring devices connected to a monitoring panel.

11. Sprinkler systems in carparks

A sprinkler system protecting a *carpark* complying with [Table 3.9 of Specification C1.1](#) in a multi-classified building must—

- (a) be independent of the sprinkler system protecting any part of the building not used as a *carpark*; or
- (b) if forming part of a sprinkler system protecting a part of the building not used as a *carpark*, be designed such that the section protecting the non-*carpark* part can be isolated without interrupting the water supply or otherwise affecting the effective operation of the section protecting the *carpark*.

12. Residential care buildings

In addition to the provisions of AS 2118.4, a sprinkler system in—

- (a) a Class 3 building used as a *residential care building*; or
- (b) a Class 9a *health-care building* used as a *residential care building*; or
- (c) a Class 9c building,
must—
- (d) be provided with a monitored main stop valve in accordance with AS 2118.1; and
- (e) be permanently connected with a direct data link or other approved monitoring system to a fire station or fire station dispatch centre.

*Deemed-to-Satisfy Provisions***13. Sprinkler systems in lift installations**

- (a) Where sprinklers are installed in a space housing lift electrical and control equipment, including machine rooms, secondary floors and sheave rooms, sprinklers in these spaces must—
 - (i) have heads protected from accidental damage by way of a guard that will not impair the performance of the head; and
 - (ii) be capable of being isolated and drained, either separately or collectively, without isolating any other sprinklers within the building.
- (b) Valves provided to control sprinklers referred to in (a) must be installed in accordance with [Clause 10\(b\)](#).

Specification E1.5a

Class 2 and 3 buildings not more than 25 m in effective height

Deemed-to-Satisfy Provisions

1. Scope and application

This Specification sets out requirements for the design and installation of fire sprinkler systems, and concessions for Class 2 and 3 buildings not more than 25 m in *effective height* with a *rise in storeys* of 4 or more. The *Deemed-to-Satisfy Provisions* of this Specification take precedence where there is a difference to the *Deemed-to-Satisfy Provisions* of Sections C, D and E.

2. System requirements

Vic Spec E1.5a 2(a)

- (a) A *required automatic* fire sprinkler system installed in a Class 2 or 3 building with an *effective height* of not more than 25 m and a *rise in storeys* of 4 or more must comply with—
 - (i) AS 2118.1; or
 - (ii) AS 2118.4, as applicable; or
 - (iii) FPAA101D, except for *residential care buildings*; or
 - (iv) FPAA101H, except for *residential care buildings*.
- (b) A Class 2 or 3 building not more than 25 m in *effective height* with a *rise in storeys* of 4 or more provided with an *automatic* fire sprinkler system under Clause 2(a)(i) or 2(a)(ii) may be constructed in accordance with Clause 3(a), as applicable, provided—
 - (i) the *automatic* fire sprinkler system is permanently connected to a fire alarm monitoring system connected to a fire station or fire station dispatch centre in accordance with Specification E2.2d if—
 - (A) the system has more than 100 sprinkler heads; or
 - (B) in the case of a *residential care building*, the building will accommodate more than 32 residents; and
 - (ii) the *automatic* fire sprinkler system is fitted with sprinklers complying with clauses 4.4, 4.5 and 5.5.2 of AS 2118.4 in bedrooms; and
 - (iii) an *automatic* smoke detection and alarm system is installed in accordance with Specification E2.2a except that it need not be connected to a fire alarm monitoring system connected to a fire station or fire station dispatch centre, and in the case of a *residential care building* it must be installed in accordance with—
 - (A) Specification E2.2a Clause 4; or
 - (B) both—
 - (aa) Specification E2.2a Clause 3, provided Specification E2.2a Clause 3(a)(ii) is applied as if the building was not protected with a sprinkler system; and
 - (bb) Specification E2.2d; and
 - (iv) in a *residential care building*, the *automatic* smoke detection and alarm system and the *automatic* fire sprinkler system are connected to a local fire indicator panel provided in accordance with Specification E2.2d; and
 - (v) fire orders are provided in a Class 3 building in accordance with G4.9 as for a building in an *alpine area*.

3. Permitted concessions

- (a) The following concessions are permitted for Class 2 and 3 buildings provided with a *required automatic* fire sprinkler system in accordance with Clause 2(a)(i) or 2(a)(ii):
 - (i) The FRL for *self-closing* fire doors, as *required* by C3.8 and C3.11, may be reduced to not less than -/30/30.
 - (ii) The FRL for—
 - (A) all non-*loadbearing internal walls* and *shafts* constructed of *fire-protected timber*, as *required* by

Services and equipment

Deemed-to-Satisfy Provisions

Specification C1.1 to have FRLs greater than -/60/60, may be reduced to -/60/60 and service penetrations through non-*loadbearing internal walls* and *shafts* constructed of *fire-protected timber*, as *required* by C3.15, may be reduced to not less than -/60/15; and

- (B) all other non-*loadbearing internal walls*, as *required* by Specification C1.1, may be reduced to -/45/45 and the FRL for service penetrations through internal non-*loadbearing* walls and *shafts*, as *required* by C3.15, may be reduced to -/45/15.
- (iii) The FRL for *fire-isolated stairways* enclosed with non-*loadbearing* construction, as *required* by D1.3, may be reduced to -/45/45.
- (iv) Except in a *residential care building*, the maximum distance of travel, as *required* by D1.4(a)(i)(A), may be increased from 6 m to 12 m.
- (v) The maximum distance of travel from a single *exit* serving the *storey* at the level of egress to a road or *open space*, as *required* by D1.4(a)(i)(B), may be increased from 20 m to 30 m.
- (vi) The maximum distance between alternative *exits*, as *required* by D1.5(c)(i), may be increased from 45 m to 60 m.
- (vii) Internal fire hydrants in accordance with E1.3 are not *required* where—
 - (A) the building is served by external fire hydrants that provide compliant coverage installed in accordance with E1.3, except that in a *residential care building* the nozzle at the end of the length of hose need only reach the entry door of any *sole-occupancy unit* to be considered as covering the area within the *sole-occupancy unit*; or
 - (B) a dry fire hydrant system that otherwise complies with AS 2419.1 is installed in the building and—
 - (aa) each fire hydrant head is located in accordance with E1.3 and fitted with a blank end cap or plug; and
 - (bb) the pipework is installed in accordance with E1.3 (as for a *required* fire main) except that it need not be connected to a water supply; and
 - (cc) a hydrant booster inlet connection is provided in accordance with E1.3; and
 - (dd) an external street or feed hydrant capable of providing the *required* system flow is located within 60 m of the hydrant booster connection.
- (viii) An emergency warning and intercom system need not be provided in a *residential care building* in accordance with E4.9 if a warning system with an override public address facility is installed in accordance with Specification E2.2d.
- (b) The following concessions are permitted for Class 2 and 3 buildings provided with a *required automatic* fire sprinkler system in accordance with Clause 2(a)(iii):
 - (i) Window openings need not be protected in accordance with C3.11(g) provided the room served by the window is sprinkler protected.
 - (ii) The FRL for—
 - (A) service penetrations through non-*loadbearing internal walls* and *shafts*, as *required* by C3.15, may be reduced to -/60/15; and
 - (B) non-*loadbearing fire-resisting* lift and stair *shafts*, as *required* by Specification C1.1, may be reduced to -/60/60.
 - (iii) The maximum distance of travel, as *required* by D1.4(a)(i)(A), may be increased from 6 m to 12 m.
 - (iv) The maximum distance of travel from a single *exit* serving the *storey* at the level of egress to a road or *open space*, as *required* by D1.4(a)(i)(B), may be increased from 20 m to 30 m.
 - (v) The maximum distance between alternative *exits*, as *required* by D1.5(c)(i), may be increased from 45 m to 60 m.
 - (vi) Internal fire hydrants in accordance with E1.3 are not *required* where—
 - (A) the building is served by external fire hydrants that provide compliant coverage installed in accordance with E1.3; or
 - (B) a dry fire hydrant system that otherwise complies with AS 2419.1 is installed in the building except—

Services and equipment

Deemed-to-Satisfy Provisions

- (aa) the system pipework is not connected to the water supply; and
 - (bb) an on-site fire pumpset is not *required*; and
 - (cc) the minimum fire hydrant outlet flow of 6 L/s may be achieved when boosted by a *fire brigade* pumping appliance; and
 - (dd) the minimum pipe sizes specified in AS 2419.1 do not apply, and—
 - (ee) each fire hydrant head is located in accordance with E1.3 and fitted with a blank end cap or plug; and
 - (ff) a hydrant booster inlet connection is provided in accordance with E1.3; and
 - (gg) an external street or feed hydrant capable of providing the *required* system flow is located within 60 m of the hydrant booster connection.
- (c) The following concessions are permitted for Class 2 and 3 buildings provided with a *required automatic* fire sprinkler system in accordance with Clause 2(a)(iv):
- (i) Window openings need not be protected in accordance with C3.11(g) provided the room served by the window is sprinkler protected.
 - (ii) The FRL for—
 - (A) service penetrations through non-*loadbearing internal walls* and *shafts*, as *required* by C3.15, may be reduced to -/60/15; and
 - (B) non-*loadbearing fire-resisting* lift and stair *shafts*, as *required* by Specification C1.1, may be reduced to -/60/60.
 - (iii) The maximum distance of travel, as *required* by D1.4(a)(i)(A), may be increased from 6 m to 12 m.
 - (iv) The maximum distance of travel from a single *exit* serving the *storey* at the level of egress to a road or *open space*, as *required* by D1.4(a)(i)(B), may be increased from 20 m to 30 m.
 - (v) The maximum distance between alternative *exits*, as *required* by D1.5(c)(i), may be increased from 45 m to 60 m.

Specification E1.8

Fire control centres

Deemed-to-Satisfy Provisions

1. Scope

This Specification describes the construction and content of *required* fire control centres and rooms. A fire control room is a fire control centre in a dedicated room with additional specific requirements. [Clauses 2 to 5](#) apply to fire control centres (including fire control rooms). [Clauses 6 to 12](#) apply additional requirements to fire control rooms.

2. Purpose and content

A fire control centre must—

- (a) provide an area from which fire-fighting operations or other emergency procedures can be directed or controlled; and
- (b) contain controls, panels, telephones, furniture, equipment and the like associated with the *required* fire services in the building; and
- (c) not be used for any purpose other than the control of—
 - (i) fire-fighting activities; and
 - (ii) other measures concerning the occupant safety or security.

3. Location of fire control centre

A fire control centre must be so located in a building that egress from any part of its floor, to a road or *open space*, does not involve changes in level which in aggregate exceed 300 mm.

4. Equipment not permitted within a fire control centre

An internal combustion engine, pumps, sprinkler control valves, pipes and pipe fittings must not be located in a fire control centre, but may be located in rooms accessed through the fire control centre.

5. Ambient sound level for a fire control centre

- (a) The ambient sound level within the fire control centre measured when all fire safety equipment is operating in the manner in which it operates in an emergency must not exceed 65 dB(A).
- (b) The measurement must be taken for a sufficient time to characterize the effects of all sound sources. Where there is not a great variation in noise level, a measurement time of 60 seconds may be used.

6. Construction of a fire control room

A fire control centre in a building more than 50 m in *effective height* must be in a separate room where—

- (a) the enclosing construction is of concrete, masonry or the like, sufficiently impact resistant to withstand the impact of any likely falling debris, and with an FRL of not less than 120/120/120; and
- (b) any material used as a finish, surface, lining or the like within the room complies with the requirements of [Specification C1.10](#); and
- (c) services, pipes, ducts and the like that are not directly *required* for the proper functioning of the fire control room do not pass through it; and
- (d) openings in the walls, floors or ceiling which separate the room from the interior of the building are confined to doorways, ventilation and other openings for services necessary for the proper functioning of the facility.

7. Protection of openings in a fire control room

Openings permitted by [Clause 6](#) must be protected as follows:

- (a) Openings for *windows*, doorways, ventilation, service pipes, conduits and the like, in an *external wall* of the

Services and equipment

Deemed-to-Satisfy Provisions

building that faces a road or *open space*, must be protected in accordance with the *Deemed-to-Satisfy Provisions* of *Part C3*.

- (b) Openings in the floors, ceilings and *internal walls* enclosing a fire control room must, except for doorways, be protected in accordance with the *Deemed-to-Satisfy Provisions* of *Part C3*.
- (c) A door opening in the *internal walls* enclosing a fire-control room, must be fitted with a *self-closing* –/120/30 smoke sealed fire door.
- (d) Openings associated with natural or mechanical ventilation must—
 - (i) not be made in any ceiling or floor immediately above or below the fire control room; and
 - (ii) be protected by a –/120/– fire damper if the opening is for a duct through a wall *required* to have an FRL, other than an *external wall*.

8. Doors to a fire control room

- (a) *Required* doors to a fire control room must open into the room, be lockable and located so that persons using escape routes from the building will not obstruct or hinder access to the room.
- (b) The fire control room must be accessible via two paths of travel—
 - (i) one from the front entrance of the building; and
 - (ii) one direct from a public place or *fire-isolated passageway* which leads to a public place and has a door with an FRL of not less than –/120/30.

9. Size and contents of a fire control room

- (a) A fire control room must contain—
 - (i) a Fire Indicator Panel and necessary control switches and visual status indication for all *required* fire pumps, smoke control fans and other *required* fire safety equipment installed in the building; and
 - (ii) a telephone directly connected to an external telephone exchange; and
 - (iii) a blackboard or whiteboard not less than 1200 mm wide x 1000 mm high; and
 - (iv) a pin-up board not less than 1200 mm wide x 1000 mm high; and
 - (v) a raked plan layout table of a size suitable for laying out the plans provided under (vi); and
 - (vi) colour-coded, durable, tactical fire plans.
- (b) In addition, a fire control room may contain—
 - (i) master emergency control panels, lift annunciator panels, remote switching controls for gas or electrical supplies and emergency generator backup; and
 - (ii) building security, surveillance and management systems if they are completely segregated from all other systems.
- (c) A fire control room must—
 - (i) have a *floor area* of not less than 10 m² and the length of any internal side must be not less than 2.5 m; and
 - (ii) if only the minimum prescribed equipment is installed — have a net *floor area* of not less than 8 m² with a clear space of not less than 1.5 m² in front of the Fire Indicator Panel; and
 - (iii) if additional equipment is installed — have an additional area of not less than 2 m² net *floor area* for each additional facility and a clear space of not less than 1.5 m² in front of each additional control or indicator panel,

and the area *required* for any path of travel through the room to other areas must be provided in addition to the requirements (ii) and (iii).

10. Ventilation and power supply for a fire control room

A fire control room must be ventilated by—

Services and equipment

Deemed-to-Satisfy Provisions

- (a) natural ventilation from a [window](#) or doorway in an [external wall](#) of the building which opens directly into the fire control room from a road or [open space](#); or
- (b) a pressurisation system that only serves the fire control room, and—
 - (i) is installed in accordance with AS 1668.1 as though the room is a [fire-isolated stairway](#); and
 - (ii) is activated [automatically](#) by operation of the fire alarm, or sprinkler system complying with [Specification E1.5](#), installed in the building and manually by an over-riding control in the room; and
 - (iii) provides a flow of fresh air through the room of not less than 30 air changes per hour when the system is operating and any door to the room is open; and
 - (iv) has fans, motors and ductwork that form part of the system but not contained within the fire control room protected by enclosing construction with an FRL of not less than 120/120/120; and
 - (v) has any electrical supply to the fire control room or equipment necessary for its operation connected to the supply side of the main disconnection switch for the building,and no openable devices other than necessary doorways, pressure controlled relief louvres and [windows](#) that are openable by a key, must be constructed in the fire control room.

11. Sign for a fire control room

The external face of the door to the fire control room must have a sign with the words—

FIRE CONTROL ROOM

in letters of not less than 50 mm high and of a colour which contrasts with that of the background.

12. Lighting for a fire control room

Emergency lighting in accordance with the [Deemed-to-Satisfy Provisions](#) of [Part E4](#) must be provided in a fire control room, except that an illumination level of not less than 400 lux must be maintained at the surface of the plan table.

Part E2 Smoke hazard management

Performance Requirements

EP2.1 Automatic warning for sleeping occupants

In a building providing sleeping accommodation, occupants must be provided with *automatic* warning on the detection of smoke so they may evacuate in the event of a fire to a *safe place*.

Application:

EP2.1 only applies to a Class 2, 3, 9a or 9c building or Class 4 part of a building.

EP2.2 Safe evacuation routes

- (a) In the event of a fire in a building the conditions in any *evacuation route* must be maintained for the period of time occupants take to evacuate the part of the building so that—
- (i) the temperature will not endanger human life; and
 - (ii) the level of visibility will enable the *evacuation route* to be determined; and
 - (iii) the level of toxicity will not endanger human life.
- (b) The period of time occupants take to evacuate referred to in (a) must be appropriate to—
- (i) the number, mobility and other characteristics of the occupants; and
 - (ii) the function or use of the building; and
 - (iii) the travel distance and other characteristics of the building; and
 - (iv) the *fire load*; and
 - (v) the potential *fire intensity*; and
 - (vi) the *fire hazard*; and
 - (vii) any active *fire safety systems* installed in the building; and
 - (viii) *fire brigade* intervention.

Limitation:

EP2.2 does not apply to an *open-deck carpark* or *open spectator stand*.

Verification Methods

EV2.1 Fire Safety Verification Method

Compliance with EP2.1 and EP2.2 is verified when a building is designed in accordance with Schedule 7.

Part E2 Smoke hazard management

Deemed-to-Satisfy Provisions

E2.0 Deemed-to-Satisfy Provisions

- (a) Where a *Deemed-to-Satisfy Solution* is proposed, *Performance Requirements EP2.1* to *EP2.2* are satisfied by complying with—
- (i) *E2.1* to *E2.3*; and
 - (ii) in a building containing an *atrium*, *Part G3*; and
 - (iii) in a building in an *alpine area*, *Part G4*; and
 - (iv) for additional requirements for Class 9b buildings, *Part H1*.
- (b) Where a *Performance Solution* is proposed, the relevant *Performance Requirements* must be determined in accordance with *A2.2(3)* and *A2.4(3)* as applicable.

E2.1 Application of Part

- (a) The *Deemed-to-Satisfy Provisions* of this Part do not apply to—
- (i) any *open-deck carpark*; or
 - (ii) any *open spectator stand*; or
 - (iii) a Class 8 *electricity network substation* with a *floor area* not more than 200 m², located within a multi-classified building.
- (b) The smoke exhaust and *smoke-and-heat vent* provisions of this Part do not apply to any area not used by occupants for an extended period of time such as a storeroom with a *floor area* less than 30 m², *sanitary compartment*, plant room or the like.

E2.2 General requirements

- (a) A building must comply with (b), (c), (d) and—
- (i) *Table E2.2a* as applicable to Class 2 to 9 buildings such that each separate part complies with the relevant provisions for the classification; and
 - (ii) *Table E2.2b* as applicable to Class 6 and 9b buildings such that each separate part complies with the relevant provisions for the classification.
- (b) An air-handling system which does not form part of a smoke hazard management system in accordance with *Table E2.2a* or *Table E2.2b* and which recycles air from one *fire compartment* to another *fire compartment* or operates in a manner that may unduly contribute to the spread of smoke from one *fire compartment* to another *fire compartment* must—
- (i) be designed and installed to operate as a smoke control system in accordance with AS 1668.1; or
 - (ii)
 - (A) incorporate smoke dampers where the air-handling ducts penetrate any elements separating the *fire compartments* served; and
 - (B) be arranged such that the air-handling system is shut down and the smoke dampers are activated to close *automatically* by smoke detectors complying with clause 7.5 of AS 1670.1; and
for the purposes of this provision, each *sole-occupancy unit* in a Class 2 or 3 building is treated as a separate *fire compartment*.
- (c) Miscellaneous air-handling systems covered by Sections 5 and 6 of AS 1668.1 serving more than one *fire compartment* (other than a *carpark* ventilation system) and not forming part of a smoke hazard management system must comply with that Section of the Standard.
- (d) A smoke detection system must be installed in accordance with *Clause 6 of Specification E2.2a* to operate AS 1668.1 systems that are provided for zone pressurisation and *automatic* air pressurisation for fire-isolated *exits*.

Services and equipment

Deemed-to-Satisfy Provisions

E2.3 Provision for special hazards

Additional smoke hazard management measures may be necessary due to the—

- (a) special characteristics of the building; or
- (b) special function or use of the building; or
- (c) special type or quantity of materials stored, displayed or used in a building; or
- (d) special mix of classifications within a building or *fire compartment*,

which are not addressed in [Tables E2.2a](#) and [E2.2b](#).

[NSW Table E2.2a](#)

Table E2.2a General provisions

Fire-isolated exits
<p>A <i>required</i>—</p> <ul style="list-style-type: none"> (a) <i>fire-isolated stairway</i>, including any associated <i>fire-isolated passageway</i> or <i>fire-isolated ramp</i> serving— <ul style="list-style-type: none"> (i) any <i>storey</i> above an <i>effective height</i> of 25 m; or (ii) more than 2 below ground <i>storeys</i>, not counted in the <i>rise in storeys</i> in accordance with C1.2; or (iii) an <i>atrium</i> to which Part G3 applies; or (iv) a Class 9a building with a <i>rise in storeys</i> of more than 2; or (v) a Class 9c building with a <i>rise in storeys</i> of more than 2; or (vi) a Class 3 building used as a <i>residential care building</i> with a <i>rise in storeys</i> of more than 2; and (b) <i>fire-isolated passageway</i> or <i>fire-isolated ramp</i> with a length of travel more than 60 m to a road or <i>open space</i>, must be provided with— (c) an <i>automatic</i> air pressurisation system for fire-isolated <i>exits</i> in accordance with AS 1668.1; or (d) open access ramps or balconies in accordance with D2.5. <p>Notes:</p> <ol style="list-style-type: none"> 1. An <i>automatic</i> air pressurisation system for fire-isolated <i>exits</i> applies to the entire <i>exit</i>. 2. Refer D1.7(d) for pressurisation of a fire-isolated <i>exit</i> having more than 2 access doorways from within the same <i>storey</i>.
Buildings more than 25 m in effective height
Class 2 and 3 buildings and Class 4 part of a building
<p>A Class 2 and 3 building or part of a building and Class 4 part of a building must be provided with an <i>automatic</i> smoke detection and alarm system complying with Specification E2.2a.</p> <p>Note: Refer C2.14 for division of <i>public corridors</i> greater than 40 m in length.</p>
Class 5, 6, 7b,8 or 9b buildings
<p>A Class 5, 6, 7b, 8 or 9b building or part of a building must be provided with a zone pressurisation system between vertically separated <i>fire compartments</i> in accordance with AS 1668.1.</p> <p>Notes:</p> <ol style="list-style-type: none"> 1. Refer Table E2.2b for Specific Provisions applicable to a Class 6 (in a <i>fire compartment</i> having a <i>floor area</i> of more than 2000 m²) and 9b building or part of a building. 2. This requirement does not apply to a building that has a <i>fire compartment</i> containing a Class 5, 6, 7b, 8 or 9b part (or a combination of these classes in the same <i>fire compartment</i>) where there is only one <i>fire compartment</i> containing these classifications in an otherwise Class 2, 3, 9a or 9c building. 3. The requirement for pressurisation ‘between vertically separated <i>fire compartments</i>’ refers to <i>fire compartments</i> above and below each other, and does not apply to <i>fire compartments</i> within the same <i>storey</i>.
Class 9a buildings
<p>A Class 9a building must be provided with—</p> <ul style="list-style-type: none"> (a) an <i>automatic</i> smoke detection and alarm system complying with Specification E2.2a; and

Services and equipment

Deemed-to-Satisfy Provisions

- (b) a zone pressurisation system between vertically separated *fire compartments* in accordance with AS 1668.1.

Notes:

1. A building more than 25 m in *effective height* requires a sprinkler system under E1.5.
2. The requirement for pressurisation 'between vertically separated *fire compartments*' refers to *fire compartments* above and below each other, and does not apply to *fire compartments* within the same *storey*.

Buildings not more than 25 m in effective height

Class 2 and 3 buildings and Class 4 part of a building

A Class 2 and 3 building or part of a building and Class 4 part of a building—

- (a) must be provided with an *automatic* smoke detection and alarm system complying with [Specification E2.2a](#); and
- (b) where a *required fire-isolated stairway* serving the Class 2 or 3 parts also serves one or more *storeys* of Class 5, 6, 7 (other than an *open-deck carpark*), 8 or 9b parts—
 - (i) the *fire-isolated stairway*, including any associated *fire-isolated passageway* or *fire-isolated ramp*, must be provided with an *automatic* air pressurisation system for fire-isolated *exits* in accordance with AS 1668.1; or
 - (ii) the Class 5, 6, 7 (other than an *open-deck carpark*), 8 and 9b parts must be provided with—
 - (A) an *automatic* smoke detection and alarm system complying with [Specification E2.2a](#); or
 - (B) a sprinkler system (other than a FPAA101D or FPAA101H system) complying with [Specification E1.5](#); and
- (c) where a *required fire-isolated stairway* serving the Class 4 part also serves one or more *storeys* of Class 5, 6, 7 (other than an *open-deck carpark*), 8 or 9b parts—
 - (i) a system complying with (b)(i) or (b)(ii) must be installed; or
 - (ii) a smoke alarm or detector system complying with [Specification E2.2a](#) must be provided except that alarms or detectors need only be installed adjacent to each doorway into each *fire-isolated stairway* (set back horizontally from the doorway by a distance of not more than 1.5 m) to initiate a building occupant warning system for the Class 4 part.

Notes:

1. Refer [C2.14](#) for division of *public corridors* greater than 40 m in length.
2. Refer [Table E2.2b](#) for Specific Provisions applicable to a Class 6 (in a *fire compartment* having a *floor area* of more than 2000 m²) and 9b building or part of a building.

Class 5, 6, 7b, 8 and 9b buildings

In a—

- (a) Class 5 or 9b *school* building or part of a building having a *rise in storeys* of more than 3; or
- (b) Class 6, 7b, 8 or 9b building (other than a *school*) or part of a building having a *rise in storeys* of more than 2; or
- (c) building having a *rise in storeys* of more than 2 and containing—
 - (i) a Class 5 or 9b *school* part; and
 - (ii) a Class 6, 7b, 8 or 9b (other than a *school*) part,

the building must be provided with—

- (d) in each *required fire-isolated stairway*, including any associated *fire-isolated passageway* or *fire-isolated ramp*, an *automatic* air pressurisation system for fire-isolated *exits* in accordance with AS 1668.1; or
- (e) a zone pressurisation system between vertically separated *fire compartments* in accordance with AS 1668.1, if the building has more than one *fire compartment*; or
- (f) an *automatic* smoke detection and alarm system complying with [Specification E2.2a](#); or
- (g) a sprinkler system (other than a FPAA101D or FPAA101H system) complying with [Specification E1.5](#).

Note: The requirement for pressurisation 'between vertically separated *fire compartments*' refers to *fire compartments* above and below each other, and does not apply to *fire compartments* within the same *storey*.

Large isolated buildings subject to C2.3

- (a) In a Class 7 or 8 building, which does not exceed 18 000 m² in *floor area* nor exceed 108 000 m³ in volume, the building must be provided with—
 - (i) a sprinkler system complying with [Specification E1.5](#), and provided with perimeter vehicular access

Services and equipment

Deemed-to-Satisfy Provisions

complying with [C2.4\(b\)](#); or

- (ii) an *automatic* fire detection and alarm system complying with AS 1670.1 and monitored in accordance with [Clause 8 of Specification E2.2a](#); or
 - (iii) an *automatic* smoke exhaust system in accordance with [Specification E2.2b](#); or
 - (iv) *automatic smoke-and-heat vents* in accordance with [Specification E2.2c](#); or
 - (v) natural smoke venting, with ventilation openings distributed as evenly as practicable and comprising permanent openings at roof level with a free area not less than 1.5% of *floor area* and low level openings which may be permanent or readily openable with a free area not less than 1.5% of *floor area*.
- (b) In a Class 5, 6, 7, 8 or 9 building, which exceeds 18 000 m² in *floor area* or 108 000 m³ in volume, the building must be provided with—
- (i) if the ceiling height of the *fire compartment* is not more than 12 m—
 - (A) an *automatic* smoke exhaust system in accordance with [Specification E2.2b](#); or
 - (B) *automatic smoke-and-heat vents* in accordance with [Specification E2.2c](#); or
 - (ii) if the ceiling height of the *fire compartment* is more than 12 m, an *automatic* smoke exhaust system in accordance with [Specification E2.2b](#).

Notes:

1. Refer [Table E2.2b](#) for Specific Provisions applicable to a Class 6 (in a *fire compartment* having a *floor area* of more than 2000 m²) and 9b building or part of a building.
2. Refer provisions under Class 2 and 3 buildings and Class 4 part of a building in this Table where a Class 5, 6, 7b, 8 and 9b building contains a Class 2, 3 or 4 part.
3. Reference to “the building” being provided with specified measures, means to the nominated classes within the building. For parts of the building of other classes, see other parts of this Table.

Class 9a and 9c buildings

A Class 9a *health-care building* or a Class 9c building, or a building containing a part thereof, must be provided throughout with—

- (a) an *automatic* smoke detection and alarm system complying with [Specification E2.2a](#); and
- (b) *automatic* shutdown of any air-handling system which does not form part of a zone pressurisation system (other than individual room units with a capacity not more than 1000 L/s, systems serving critical treatment areas and miscellaneous exhaust air systems installed in accordance with Sections 5 and 6 of AS 1668.1) on the activation of—
 - (i) smoke detectors installed in accordance with (a); and
 - (ii) any other installed fire detection and alarm system including a sprinkler system complying with [Specification E1.5](#); and
- (c) in a building having a *rise in storeys* of more than 2 and not more than 25 m *effective height* (not being a Class 9c building)—
 - (i) a zone pressurisation system between vertically separated *fire compartments* in accordance with AS 1668.1; or
 - (ii) a sprinkler system complying with [Specification E1.5](#) throughout with residential sprinkler heads in *patient care areas*.

Notes:

1. Refer to [Clause 2 of Specification C2.5](#) for the provisions for smoke dampers.
2. The requirement for pressurisation ‘between vertically separated *fire compartments*’ refers to *fire compartments* above and below each other, and does not apply to *fire compartments* within the same *storey*.

Class 7a buildings

A Class 7a building, including a basement, provided with a mechanical ventilation system in accordance with AS 1668.2 must comply with clause 5.5 of AS 1668.1 except that—

- (a) fans with metal blades suitable for operation at normal temperature may be used; and
- (b) the electrical power and control cabling need not be fire rated.

Basements (other than Class 7a buildings)

A basement, not counted in the *rise in storeys* in accordance with [C1.2](#), must—

Services and equipment

Deemed-to-Satisfy Provisions

- (a) comply with measures in accordance with this Table applicable to the building generally; and
- (b) where the basement has a total *floor area* of more than 2000 m², be provided with—
 - (i) if not more than 2 below ground *storeys*—
 - (A) a zone pressurisation system between vertically separated *fire compartments* in accordance with AS 1668.1, if the basement has more than one *fire compartment*; or
 - (B) an *automatic* smoke detection and alarm system complying with [Specification E2.2a](#); or
 - (C) a sprinkler system (other than a FPAA101D or FPAA101H system) complying with [Specification E1.5](#); or
- (c) if more than 2 below ground *storeys*, a sprinkler system (other than a FPAA101D or FPAA101H system) complying with [Specification E1.5](#).

Notes:

1. Refer [Table E2.2b](#) for specific provisions applicable to a Class 6 (in a *fire compartment* having a *floor area* of more than 2000 m²) and 9b building or part of a building.
2. Basements with more than 3 below ground *storeys* or containing Class 6 or 9b occupancies with a large number of occupants may require special consideration in accordance with [E2.3](#).
3. The requirement for pressurisation 'between vertically separated *fire compartments*' refers to *fire compartments* above and below each other, and does not apply to *fire compartments* within the same *storey*.

Atriums

Refer [Part G3](#).

NSW Table E2.2b

Table E2.2b Specific provisions

Class 6 buildings — In fire compartments more than 2000 m ²
Class 6 buildings (not containing an enclosed common walkway or mall serving more than one Class 6 <i>sole-occupancy unit</i>)
<ul style="list-style-type: none"> (a) Where the <i>floor area</i> of a Class 6 part of a <i>fire compartment</i> is more than 2000 m², the <i>fire compartment</i>, must be provided with— <ul style="list-style-type: none"> (i) an <i>automatic</i> smoke exhaust system complying with Specification E2.2b; or (ii) <i>automatic smoke-and-heat vents</i> complying with Specification E2.2c, if the building is single <i>storey</i>; or (iii) if the <i>floor area</i> of the <i>fire compartment</i> is not more than 3500 m² and the building— <ul style="list-style-type: none"> (A) is single <i>storey</i>, an <i>automatic</i> smoke detection and alarm system complying with Specification E2.2a; or (B) has a <i>rise in storeys</i> of not more than 2, a sprinkler system (other than a FPAA101D or FPAA101H system) complying with Specification E1.5. (b) The provisions of (a) do not apply to— <ul style="list-style-type: none"> (i) a Class 6 <i>sole-occupancy unit</i> that— <ul style="list-style-type: none"> (A) has a <i>floor area</i> of not more than 2000 m²; and (B) is single <i>storey</i> with a main public entrance opening to a road or <i>open space</i>; and (C) is separated from other parts of the <i>fire compartment</i> by construction, including openings, penetrations and junctions with other building elements, that prevents the free passage of smoke; and (ii) parts of any other classification that are smoke separated from a Class 6 part by construction complying with (i)(C).
Class 6 buildings (containing an enclosed common walkway or mall serving more than one Class 6 <i>sole-occupancy unit</i>)
<ul style="list-style-type: none"> (a) Where the <i>floor area</i> of a Class 6 part of a <i>fire compartment</i> is more than 2000 m², the <i>fire compartment</i>, including the enclosed common walkway or mall, must be provided with— <ul style="list-style-type: none"> (i) an <i>automatic</i> smoke exhaust system complying with Specification E2.2b; or (ii) <i>automatic smoke-and-heat vents</i> complying with Specification E2.2c, if the building is single <i>storey</i>; or (iii) if the <i>floor area</i> of the <i>fire compartment</i> is not more than 3500 m² and the building has a <i>rise in storeys</i> of not more than 2, a sprinkler system (other than a FPAA101D or FPAA101H system) complying with Specification

Services and equipment

Deemed-to-Satisfy Provisions

E1.5.

- (b) The provisions of (a) do not apply to—
- (i) a Class 6 *sole-occupancy unit* that—
 - (A) opens onto the enclosed common walkway or mall if the Class 6 *sole-occupancy unit* has a *floor area* of not more than 1000 m²; or
 - (B) does not open onto the enclosed common walkway or mall if the Class 6 *sole-occupancy unit*—
 - (aa) has a *floor area* of not more than 2000 m²; and
 - (ab) is single *storey* with a main entrance opening to a road or *open space*; and
 - (ac) is separated from other parts of the *fire compartment* by construction, including openings, penetrations and junctions with other building elements, that prevents the free passage of smoke; and
 - (ii) parts of any other classification that are smoke separated from a Class 6 part by construction complying with (i)(B)(ac).

Note: A *fire compartment* having a *floor area* of more than 3500 m² in a Class 6 building requires a sprinkler system under E1.5.

Class 9b — Assembly buildings

Nightclubs and discotheques and the like

A building or part of a building used as a nightclub, discotheque or the like must be provided with—

- (a) *automatic* shutdown of any air-handling system (other than miscellaneous exhaust air systems installed in accordance with Sections 5 and 6 of AS 1668.1) which does not form part of the smoke hazard management system, on the activation of—
 - (i) smoke detectors installed complying with [Clause 6 of Specification E2.2a](#); and
 - (ii) any other installed fire detection and alarm system, including a sprinkler system complying with [Specification E1.5](#); and
- (b)
 - (i) an *automatic* smoke exhaust system complying with [Specification E2.2b](#); or
 - (ii) *automatic smoke-and-heat vents* complying with [Specification E2.2c](#), if the building is single *storey*; or
 - (iii) a sprinkler system (other than a FPAA101D or FPAA101H system) complying with [Specification E1.5](#) with fast response sprinkler heads.

Exhibition halls

A building or part of a building used as an exhibition hall must be provided with—

- (a) *automatic* shutdown of any air-handling system (other than miscellaneous exhaust air systems installed in accordance with Sections 5 and 6 of AS 1668.1) which does not form part of the smoke hazard management system, on the activation of—
 - (i) smoke detectors installed complying with [Specification E2.2a](#); and
 - (ii) any other installed fire detection and alarm system, including a sprinkler system complying with [Specification E1.5](#); and
- (b) where the *floor area* is more than 2000 m² and not more than 3500 m²—
 - (i) an *automatic* smoke exhaust system complying with [Specification E2.2b](#); or
 - (ii) *automatic smoke-and-heat vents* complying with [Specification E2.2c](#), if the building is single *storey*; or
 - (iii) a sprinkler system (other than a FPAA101D or FPAA101H system) complying with [Specification E1.5](#); and
- (c) where the *floor area* is more than 3500 m², a sprinkler system (other than a FPAA101D or FPAA101H system) complying with [Specification E1.5](#) and—
 - (i) an *automatic* smoke exhaust system complying with [Specification E2.2b](#); or
 - (ii) *automatic smoke-and-heat vents* complying with [Specification E2.2c](#), if the building is single *storey*.

Theatres and public halls

A building or part of a building used as a theatre or public hall which—

- (a) is a *school* assembly, church or community hall, and has a *stage* and any *backstage* area with a total *floor area* of more than 300 m²; or

Services and equipment

Deemed-to-Satisfy Provisions

- (b) is not a *school* assembly, church or community hall, and has a *stage* and any *backstage* area with a total *floor area* of more than 200 m²; or
- (c) has a *stage* with an associated rigging loft—
 - must be provided with—
 - (i) an *automatic* smoke exhaust system complying with [Specification E2.2b](#); or
 - (ii) *automatic smoke-and-heat vents* complying with [Specification E2.2c](#), if the building is single *storey*.

Theatres and public halls (not listed above) including lecture theatres and cinema/auditorium complexes

A building or part of a building used as a theatre or public hall (not listed above) including a lecture theatre and cinema/auditorium complex—

- (a) must be provided with *automatic* shutdown of any air-handling system (other than miscellaneous exhaust air systems installed in accordance with Sections 5 and 6 of AS 1668.1) which does not form part of the smoke hazard management system, on the activation of—
 - (i) smoke detectors installed complying with [Specification E2.2a](#); and
 - (ii) any other installed fire detection and alarm system, including a sprinkler system complying with [Specification E1.5](#); and
- (b) other than in the case of a *school* lecture theatre, where the *floor area* of the *fire compartment* is more than 2000 m²—
 - (i) an *automatic* smoke exhaust system complying with [Specification E2.2b](#); or
 - (ii) *automatic smoke-and-heat vents* complying with [Specification E2.2c](#), if the building is single *storey*; or
 - (iii) if the *floor area* of the *fire compartment* is not more than 5000 m² and the building has a *rise in storeys* of not more than 2—
 - (A) an *automatic* smoke detection and alarm system complying with [Specification E2.2a](#); or
 - (B) a sprinkler system (other than a FPAA101D or FPAA101H system) complying with [Specification E1.5](#).

Other assembly buildings (not listed above) and excluding schools

- (a) Each *fire compartment*, other than one in a building described in (b), having a *floor area* of more than 2000 m² must be provided with—
 - (i) an *automatic* smoke exhaust system complying with [Specification E2.2b](#); or
 - (ii) *automatic smoke-and-heat vents* complying with [Specification E2.2c](#), if the building is single *storey*; or
 - (iii) if the *floor area* of the *fire compartment* is not more than 5000 m² and the building has a *rise in storeys* of not more than 2—
 - (A) an *automatic* smoke detection and alarm system complying with [Specification E2.2a](#); or
 - (B) a sprinkler system (other than a FPAA101D or FPAA101H system) complying with [Specification E1.5](#).
- (b) The following buildings are exempt from the provisions of (a):
 - (i) Sporting complexes (including sports halls, gymnasiums, *swimming pools*, ice and roller rinks, and the like) other than an indoor sports stadium with a total spectator seating for more than 1000.
 - (ii) Churches and other places used solely for religious worship.

Specification E2.2a

Smoke detection and alarm systems

Deemed-to-Satisfy Provisions

1. Scope

This Specification describes the installation and operation of *automatic* smoke detection and alarm systems.

2. Type of system

A *required automatic* smoke detection and alarm system must be provided in accordance with the following:

- (a) **Class 2 buildings and Class 4 parts of a building—**
 - (i) a smoke alarm system complying with [Clause 3](#); or
 - (ii) a smoke detection system complying with [Clause 4](#); or
 - (iii) a combination of a smoke alarm system and a smoke detection system complying with [Clause 5](#).
- (b) **Class 3 buildings—**
 - (i) **with a Class 3 part located more than 2 storeys above ground level —** a smoke detection system complying with [Clause 4](#); or
 - (ii) **which accommodate more than 20 residents and are the residential part of a school, accommodation for the aged, children or people with a disability —** a smoke detection system complying with [Clause 4](#); or
 - (iii) **all other Class 3 buildings—**
 - (A) a smoke alarm system complying with [Clause 3](#); or
 - (B) a smoke detection system complying with [Clause 4](#); or
 - (C) a combination of a smoke alarm system and a smoke detection system complying with [Clause 5](#).
- (c) **Class 5, 6, 7, 8, 9b and 9c buildings —** a smoke detection system complying with [Clause 4](#).
- (d) **Class 9a health-care buildings—**
 - (i) **where more than 6 bed patients are accommodated —** a smoke detection system complying with [Clause 4](#); or
 - (ii) **where 6 or less bed patients are accommodated—**
 - (A) a smoke alarm system complying with [Clause 3](#); or
 - (B) a smoke detection system complying with [Clause 4](#).

3. Smoke alarm system

- (a) **All Class 2 - 9 buildings—**
 - (i) A smoke alarm system must—
 - (A) consist of smoke alarms complying with AS 3786; and
 - (B) be powered from the consumer mains source.
 - (ii) In kitchens and other areas where the use of the area is likely to result in smoke alarms causing spurious signals—
 - (A) any other alarm deemed suitable in accordance with AS 1670.1 may be installed provided that smoke alarms are installed elsewhere in the *sole-occupancy unit* in accordance with [Clause 3\(b\)\(i\)](#) and [Clause 3\(b\)\(ii\)](#); or
 - (B) an alarm acknowledgement facility may be installed, except where the kitchen or other area is in a building protected with a sprinkler system complying with [Specification E1.5](#) (other than a FPAA101D system), the alarms need not be installed in the kitchen or

Services and equipment

Deemed-to-Satisfy Provisions

other areas likely to result in spurious signals.

- (b) **Class 2 or 3 buildings or Class 4 parts of a building** — In a Class 2 or 3 building or Class 4 part of a building provided with a smoke alarm system, the following applies:
- (i) Alarms must be installed within each *sole-occupancy unit*, and located on or near the ceiling in any *storey*—
 - (A) containing bedrooms—
 - (aa) between each part of the *sole-occupancy unit* containing bedrooms and the remainder of the *sole-occupancy unit*; and
 - (bb) where bedrooms are served by a hallway, in that hallway; and
 - (B) not containing any bedrooms, in egress paths.
 - (ii) Where there is more than one alarm installed within a *sole-occupancy unit*, alarms must be interconnected within that *sole-occupancy unit*.
 - (iii) Subject to (iv), alarms must be—
 - (A) installed in *public corridors* and other internal public spaces, located in accordance with the requirements for smoke detectors in AS 1670.1; and
 - (B) connected to activate a building occupant warning system in accordance with [Clause 7](#).
 - (iv) In a Class 2 or 3 building or Class 4 part of a building protected with a sprinkler system complying with [Specification E1.5](#) (other than a FPAA101D system), alarms are not *required* in *public corridors* and other internal public spaces.
- (c) **Class 9a buildings** — Smoke alarms must—
- (i) be installed in every room, *public corridor* and other internal public space; and
 - (ii) be located in accordance with the requirements for smoke detectors in AS 1670.1; and
 - (iii) be interconnected to provide a common alarm; and
 - (iv) have manual call points installed in *evacuation routes* so that no point on a floor is more than 30 m from a manual call point.

4. Smoke detection system

- (a) **All Class 2 - 9 buildings**—
- (i) A smoke detection system must—
 - (A) subject to (b) and (c), comply with AS 1670.1; and
 - (B) activate a building occupant warning system in accordance with [Clause 7](#).
 - (ii) In kitchens and other areas where the use of the area is likely to result in smoke detectors causing spurious signals—
 - (A) any other detector deemed suitable in accordance with AS 1670.1 may be installed provided that smoke detectors are installed elsewhere in the *sole-occupancy unit* in accordance with the requirements for alarms in [Clause 3\(b\)\(i\)](#) and [Clause 3\(b\)\(ii\)](#); or
 - (B) an alarm acknowledgement facility may be installed,

except where the kitchen or other area is in a building protected with a sprinkler system complying with [Specification E1.5](#) (other than a FPAA101D or FPAA101H system), the detectors need not be installed in the kitchen or other areas likely to result in spurious signals.
- (b) **Class 2 or 3 buildings or Class 4 parts of a building** — In a Class 2 or 3 building or Class 4 part of a building provided with a smoke detection system, the following applies:
- (i) Smoke detectors must be installed—
 - (A) within each *sole-occupancy unit*, in accordance with the requirements for alarms in [Clause 3\(b\)\(i\)](#) and [Clause 3\(b\)\(ii\)](#); and
 - (B) subject to (ii), in *public corridors* and other internal public spaces.

Services and equipment

Deemed-to-Satisfy Provisions

- (ii) In a Class 2 or 3 building or Class 4 part of a building protected with a sprinkler system complying with [Specification E1.5](#) (other than a FPAA101D or FPAA101H system), smoke detectors are not *required* in *public corridors* and other internal public spaces.
- (c) **Class 9a health-care buildings** — The following applies in a Class 9a *health-care building*:
 - (i)
 - (A) Photoelectric type smoke detectors must be installed in *patient care areas* and in paths of travel to *exits* from *patient care areas*; and
 - (B) in areas other than *patient care areas* and paths of travel to *exits* from *patient care areas*, where the use of the area is likely to result in smoke detectors causing spurious signals, any other detector deemed suitable in accordance with AS 1670.1 may be installed in lieu of smoke detectors, except where an area is protected with a sprinkler system complying with [Specification E1.5](#), smoke detectors need not be installed where the use of the area is likely to result in spurious signals.
 - (ii) Manual call points must be installed in *evacuation routes* so that no point on a floor is more than 30 m from a manual call point.

Vic Spec E2.2a 4(d)

- (d) **Class 9c buildings** — In a Class 9c building—
 - (i) remote automatic indication of each zone must be given in each smoke compartment by means of—
 - (A) mimic panels with an illuminated display; or
 - (B) annunciator panels with alpha numeric display; and
 - (ii) if the building accommodates more than 20 residents, manual call points must be installed in paths of travel so that no point on a floor is more than 30 m from a manual call point.

5. Combined smoke alarm and smoke detection system

- (a) A Class 2 or 3 building or Class 4 part of a building provided with a combination of a smoke alarm system and smoke detection system in accordance with [Clause 2](#) must—
 - (i) be provided with a smoke alarm system complying with [Clause 3](#) within *sole-occupancy units*; and
 - (ii) subject to (b), be provided with a smoke detection system complying with [Clause 4](#) in areas not within *sole-occupancy units*.
- (b) In a Class 2 or 3 building or Class 4 part of a building protected with a sprinkler system complying with [Specification E1.5](#) (other than a FPAA101D or FPAA101H system), smoke detectors are not *required* in *public corridors* and other internal public spaces.

6. Smoke detection for smoke control systems

- (a) Smoke detectors *required* to activate air pressurisation systems for fire-isolated *exits* and zone pressurisation systems must—
 - (i) be installed in accordance with AS 1670.1; and
 - (ii) have additional smoke detectors installed adjacent to each bank of lift landing doors set back horizontally from the door openings by a distance of not more than 3 m.
- (b) Smoke detectors *required* to activate—
 - (i) *automatic* shutdown of air-handling systems in accordance with [Table E2.2b](#); or
 - (ii) a smoke exhaust system in accordance with [Specification E2.2b](#), must—
 - (iii) be spaced—
 - (A) not more than 20 m apart and not more than 10 m from any wall, bulkhead or smoke curtain; and
 - (B) in enclosed malls and walkways in a Class 6 building not more than 15 m apart and not more than 7.5 m from any wall, bulkhead or curtain; and

Services and equipment

Deemed-to-Satisfy Provisions

- (iv) have a sensitivity—
 - (A) in accordance with AS 1670.1 in areas other than a multi-storey walkway and mall in a Class 6 building; and
 - (B) not exceeding 0.5% smoke obscuration per metre with compensation for external airborne contamination as necessary, in a multi-storey walkway and mall in a Class 6 building.
- (c) Smoke detectors provided to activate a smoke control system must—
 - (i)
 - (A) form part of a building fire or smoke detection system complying with AS 1670.1; or
 - (B) be a separate dedicated system incorporating control and indicating equipment complying with AS 1670.1; and
 - (ii) activate a building occupant warning system complying with Clause 7, except that smoke detectors provided solely to initiate automatic shutdown of air-handling systems in accordance with (b)(i) need not activate a building occupant warning system.

7. Building occupant warning system

Subject to E4.9, a building occupant warning system provided as part of a smoke hazard management system must comply with clause 3.22 of AS 1670.1 to sound through all occupied areas except—

- (a) in a Class 2 and 3 building or Class 4 part of a building provided with a smoke alarm system in accordance with Clause 3(b)(iii)—
 - (i) the sound pressure level need not be measured within a sole-occupancy unit if a level of not less than 85 dB(A) is provided at the door providing access to the sole-occupancy unit; and
 - (ii) the inbuilt sounders of the smoke alarms may be used to wholly or partially meet the requirements; and
- (b) in a Class 2 and 3 building or Class 4 part of a building provided with a smoke detection system in accordance with Clause 4(b), the sound pressure level from a building occupant warning system need not be measured within a sole-occupancy unit if a level of not less than 100 dB(A) is provided at the door providing access to the sole-occupancy unit; and
- (c) in a Class 3 building used as a residential care building, the system—
 - (i) must be arranged to provide a warning for occupants; and
 - (ii) in areas used by residents, may have its alarm adjusted in volume and content to minimise trauma consistent with the type and condition of residents; and
- (d) in a Class 9a health-care building, in a patient care area, the system—
 - (i) must be arranged to provide a warning for occupants; and
 - (ii) in a ward area, may have its alarm adjusted in volume and content to minimise trauma consistent with the type and condition of the patients; and
- (e) in a Class 9c building, the system—
 - (i) must be arranged to provide a warning for occupants; and
 - (ii) must notify staff caring for the residents of the building; and
 - (iii) in areas used by residents, may have its alarm adjusted in volume and content to minimise trauma consistent with the type and condition of residents.

8. System monitoring

The following installations must be connected to a fire alarm monitoring system connected to a fire station or fire station dispatch centre in accordance with AS 1670.3:

- (a) A smoke detection system in a Class 3 building provided in accordance with Clause 2(b)(i) or Clause 2 (b)(ii).
Vic Spec E2.2a 8(b)
- (b) A smoke detection system in a Class 9a health-care building, if the building accommodates more than 20

Services and equipment

Deemed-to-Satisfy Provisions

patients.

Vic Spec E2.2a 8(c)

- (c) A smoke detection system in a Class 9c building.
- (d) Smoke detection in accordance with [Clause 6](#) provided to activate—
 - (i) a smoke exhaust system in accordance with [Specification E2.2b](#); or
 - (ii) *smoke-and-heat vents* in accordance with [Specification E2.2c](#).

NSW Spec E2.2a 8(e)

- (e) An *automatic* fire detection and alarm system *required* by [Table E2.2a](#) for large isolated buildings subject to [C2.3](#).

Specification E2.2b

Smoke exhaust systems

Deemed-to-Satisfy Provisions

1. Scope

This Specification describes the requirements for mechanical smoke exhaust systems.

2. Smoke exhaust capacity

- (a) Smoke exhaust fans must have a sufficient capacity to contain the smoke layer—
 - (i) within a smoke reservoir formed in accordance with [Clause 4](#) and not less than 2 m above the highest floor level; and
 - (ii) above the top of any openings interconnecting different smoke reservoirs.
- (b) Exhaust rates must be determined in accordance with [Figure 2](#), with the height measurement taken from the lowest floor level to the underside of the smoke layer and the *fire load* determined in accordance with [Table 1](#).

3. Smoke exhaust fans

Each smoke exhaust fan, complete with its drive, flexible connections, control gear and wiring must—

- (a) be constructed and installed so that it is capable of continuous operation (exhausting the *required* volumetric flow rate at the installed system resistance) at a temperature of 200° C for a period of not less than 1 hour; and
- (b) in a building not fitted with a sprinkler system, be capable of continuous operation at a temperature of 300° C for a period of not less than 30 minutes; and
- (c) be rated to handle the *required* volumetric flow rate at ambient temperature to be capable of exhausting cool smoke during the early stages of a fire and to allow routine testing; and
- (d) have any high temperature overload devices installed, *automatically* overridden during the smoke exhaust operation.

Figure 2 Smoke exhaust rate

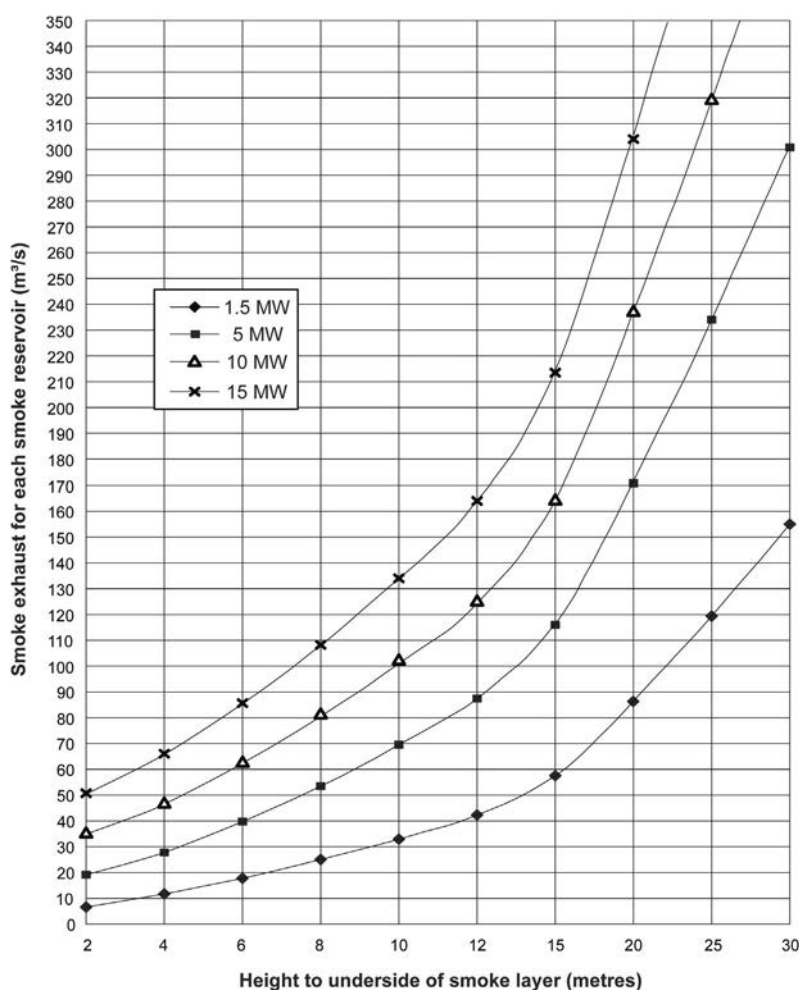

Table 1 Fire load (MW)

Classification	Fire load (MW) for unsprinklered buildings	Fire load (MW) for sprinklered buildings
Class 2, 3 or 5	5	1.5
Class 6	10	5
Class 7 or 8	15	5
Class 9 — Generally	5	1.5
Class 9b buildings covered by Part H1 (see Note), or exhibition halls.	10	5

Note to Table 1: If the smoke reservoir above the *stage* is smoke separated from the audience area, the *fire load* specified applies to the *stage* area only and the *fire load* for the audience area is as per Class 9 generally.

4. Smoke reservoirs

- A *fire compartment* must be divided at ceiling level into smoke reservoirs formed by smoke baffles/curtains of *non-combustible* and non-shatterable construction.
- The horizontal area of a smoke reservoir must not exceed 2000 m² and in enclosed walkways and malls of a Class 6 building must not exceed 60 m in length.
- Smoke reservoirs must be of sufficient depth to contain the smoke layer and must not be less than 500 mm below an imperforate ceiling or roof.

Services and equipment

Deemed-to-Satisfy Provisions

- (d)
 - (i) Within a multi-storey fire compartment, a non-combustible bulkhead or smoke baffle/curtain must be provided around the underside of each opening into a building void to minimise the spread of smoke to other storeys.
 - (ii) The depth of the bulkhead or smoke baffle must be not less than the depth of the smoke reservoir provided under (c) plus an additional 400 mm.

5. Smoke exhaust fan and vent location

Smoke exhaust fans and vents must be located—

- (a) such that each smoke reservoir is served by one or more fans with the maximum exhaust rate at any one point limited to avoid extracting air from below the smoke layer; and
- (b) to prevent the formation of stagnant regions resulting in excessive cooling and downward mixing of smoke; and
- (c) at natural collection points for the hot smoky gases within each smoke reservoir having due regard to the ceiling geometry and its effect on the migratory path of the smoke; and
- (d) away from the intersection of walkways or malls; and
- (e) to ensure that any voids containing escalators and/or stairs commonly used by the public are not used as a smoke exhaust path; and
- (f) to discharge directly to outdoor with a velocity of not less than 5 m/s, at a suitable point not less than 6 m from any air intake point or exit.

6. Make-up air

- (a) Low level make-up air must be provided either automatically or via permanent ventilation openings to replace the air exhausted so as to minimise—
 - (i) any disturbance of the smoke layer due to turbulence created by the incoming air; and
 - (ii) the risk of smoke migration to areas remote from the fire due to the effect of make-up air on the air balance of the total system.
- (b) The velocity of make-up air through doorways must not exceed 2.5 m/s.
- (c) Within a multi-storey fire compartment, make-up air must be provided across each vertical opening from a building void to the fire-affected storey at an average velocity of 1 m/s so as to minimise the spread of smoke from the fire-affected storey to other storeys.

7. Smoke exhaust system control

- (a) Each smoke exhaust fan must be activated sequentially by smoke detectors complying with Specification E2.2a and arranged in zones to match the smoke reservoir served by the fan(s).
- (b) Subject to (c) and (d), an air handling system (other than individual room units less than 1000 L/s and miscellaneous exhaust air systems installed in accordance with Sections 5 and 6 of AS 1668.1) which does not form part of the smoke hazard management system must be automatically shut down on the activation of the smoke exhaust system.
- (c) In a single storey fire compartment, air handling systems in all non fire-affected zones may operate on 100% outdoor air to provide make-up air to the fire-affected zone.
- (d) Within a multi-storey fire compartment, air handling systems in all non fire-affected zones and storeys must operate at 100% outdoor air to provide make-up air to the fire-affected storey via building voids connecting storeys.
- (e) Manual override control and indication together with operating instructions for use by emergency personnel must be provided adjacent to the fire indicator panel in accordance with the requirements of clauses 4.11 and 4.13 of AS 1668.1.
- (f) Manual control for the smoke exhaust system must also be provided at a location normally used by the stage manager in a theatre.

Services and equipment

Deemed-to-Satisfy Provisions

- (g) Power supply wiring to exhaust fans together with detection, control, and indication circuits (and where necessary to *automatic* make-up air supply arrangements) must comply with AS 1668.1.

8. Smoke detection

A smoke detection system must be installed in accordance with [Specification E2.2a](#) to activate the smoke exhaust system.

Specification E2.2c

Smoke-and-heat vents

Deemed-to-Satisfy Provisions

1. Adoption of AS 2665

Automatic smoke-and-heat vents must be installed as a system complying with AS 2665 except that—

- (a) * * * * *
- (b) * * * * *
- (c) permanently open vents may form part of the smoke/heat venting system provided they comply with the relevant criteria for *automatic smoke-and-heat vents* in AS 2665.

2. Controls

Where a *smoke-and-heat vent* system is installed to comply with [Table E2.2b](#), the following must apply:

- (a) In addition to thermally released link operation, *smoke-and-heat vents* must also be initiated by smoke detection complying with [Clauses 6 and 8 of Specification E2.2a](#) and arranged in zones to match the smoke reservoirs.

Specification E2.2d

Residential fire safety systems

Deemed-to-Satisfy Provisions

1. Application

This Specification describes the requirements for residential fire safety systems referenced in [Specification E1.5a](#).

[Clause 2](#) applies to Class 3 *residential care buildings*. It covers installation requirements for local fire indicator panels (or alarm panels) that provide information to staff when a fire alarm is activated.

[Clause 3](#) describes requirements for connecting residential sprinkler systems in Class 2 and 3 buildings or a *residential care building*, to a fire station or other approved monitoring service.

2. Residential local fire alarm systems — Residential care buildings

(a) **General requirements:**

- (i) This Clause applies to Class 3 *residential care buildings*.
- (ii) The installation must consist of a system of smoke alarms powered either—
 - (A) directly from the *low voltage* supply mains; or
 - (B) from an *extra-low voltage* power source originating at a local fire indicator panel with a battery back-up facility.
- (iii) A smoke detector complying with AS 1670.1 Clause 2.1.2(a)(ii), (xi) or (xv) may be substituted for a smoke alarm, provided an audible alarm device is associated with each detector.
- (iv) The sound pressure level provided by a warning device must be equivalent to that required in Clause 3.22 of AS 1670.1, except that the sound pressure level need not be measured inside a *sole-occupancy unit*, provided that a level of not less than 85 dB(A) is attained at the access door to the unit.
- (v) The alarm system must be wired for *low voltage* or *extra-low voltage* wiring.
- (vi) The system must be designed so—
 - (A) an audible alarm is given in the area in which the smoke alarm activates; and
 - (B) visible and audible indication of an alarm is provided at the local fire indicator panel; and
 - (C) an audible alarm is given in any area (including sleeping quarters and staff outbuildings) set aside for staff use.
- (vii) The maximum number of smoke alarms on any one *alarm zone* must—
 - (A) be determined by the maximum current output rating of the system source; and
 - (B) not exceed 10.
- (viii) Each *alarm zone* must be located around a single central access passageway, corridor or similar thoroughfare, to enable staff to readily identify the source of the alarm.
- (ix) Where the smoke alarm is functionally dependent on an external power source, an audible fault signal must sound at the local fire indicator panel if that power source fails. The local fire indicator panel must be permanently connected to a reliable 240 V separate *low voltage* final sub-circuit. Source power must be protected by a separate circuit breaker, or fuse, supplied from the live side of the main switch.
- (x) The smoke alarm system is not required to be connected to a fire alarm monitoring system (refer to [Clause 2\(b\)\(iii\) of Specification E1.5a](#)).

(b) **Local fire indicator panel:**

- (i) The local fire indicator panel must be located in a central area, such as a reception area, so that it is readily accessible by staff at all times.
- (ii) The local fire indicator panel must be *fixed wired*.
- (iii) The local fire indicator panel must incorporate the following:

Services and equipment

Deemed-to-Satisfy Provisions

- (A) A suitable mains power supply with battery back-up (capable of operating the system for 12 hours) for the local fire indicator panel and *extra-low voltage* smoke alarms supplied directly from the local fire indicator panel.
 - (B) Terminals for input signal conductors from the smoke alarm and residential sprinkler system. If the signal source is from a *low voltage* smoke alarm external isolation must be provided.
 - (C) Visible indication of the *alarm zone* in which the actuating device is located.
 - (D) *Automatic* audible and visible indication of the following faults:
 - (aa) A break in the wiring of any circuit between smoke alarms or *sprinkler alarm switch* and the local fire indicator panel.
 - (bb) Low battery condition.
 - (E) Automatic visible indication of mains power failure.
 - (F) Initiation of any ancillary control facilities such as smoke door release or air-conditioning shut-down.
 - (G) Local operation of individual smoke alarms, in the event of *alarm zone* isolation at the local fire indicator panel.
- (iv) If the local fire indicator panel is also used for other non-fire related purposes such as security, then these functions must be on separate and distinct circuits. When disabled or isolated, these functions must not interfere with the operation of fire alarm circuitry.
 - (v) The local fire indicator panel must comply with AS 1670.1.
 - (vi) The local fire indicator panel must have the capacity to incorporate heat detectors deemed suitable in accordance with AS 1670.1 on either the same or separate *alarm zones* as the smoke alarms.
- (c) **Smoke alarms:**
- (i) *Extra-low voltage* smoke alarms must be compatible with the local fire indicator panel.
 - (ii) *Low voltage* smoke alarms must be configured to send an output alarm signal to the local fire indicator panel.
 - (iii) Unless there is internal isolation of the signal output conductors, they must at all times be treated as *low voltage* conductors.
- (d) **Signal isolation interface units:**
- (i) Signal isolation interface units must isolate any *low voltage* connected to the smoke alarms from the local fire indicator panel.
 - (ii) Signal isolation interface units must be certified by an *Accredited Testing Laboratory* as compatible with the specific types of smoke alarms used in the system.
 - (iii) Signal isolation interface units must be accepted by the electricity supply authority.
 - (iv) Units must be marked in a clearly visible location, with letters greater than or equal to 35 mm containing the following information:

SMOKE ALARM SIGNAL ISOLATION UNIT WARNING — 240V

Isolate power supply before removing cover
--

- (e) **Wiring:**
- (i) Smoke alarms and associated equipment must be *fixed wired* for *low voltage* or *extra-low voltage* wiring systems, as applicable.
 - (ii) All *extra-low voltage* wiring must be red sheathed 0.6/1 kV stranded, with conductors having a cross sectional area of not less than 0.75 mm².
 - (iii) Clear and concise “as-installed” single line drawings to a suitable scale, showing rooms, external and internal walls, fixed partitions, doorways etc., are to be provided for each installation at the local fire indicator panel.
 - (iv) Drawings must also include the actual location of fire alarms, smoke alarms, sprinkler flow switches (where installed), alarm connection points and local fire indicator panel, to enable easy identification of alarm

Services and equipment

Deemed-to-Satisfy Provisions

system elements and their relationship to the building layout. Symbols to be used are:

Flow Switch



Heat Detector



Smoke Detector



End-of-Line Device



Fire Indicator Panel



Smoke Alarm



3. Connection of residential sprinkler systems to a fire station or other approved monitoring service

(a) Connection to monitoring service:

- (i) Connection of a residential sprinkler system to a fire station or other approved monitoring service must be via a *sprinkler alarm switch*, connected to alarm signaling equipment. The connection from the alarm signaling equipment must be in accordance with AS 1670.3.
- (ii) The alarm signaling equipment must be installed—
 - (A) in a secure, accessible position; and
 - (B) in a weatherproof housing, if located externally; and
 - (C) not more than 500 mm from the system flow switch.

- (b) **Indication at the fire indicator panel** — the fire signal from the alarm signaling equipment must be mimicked by an audible and visible signal at the fire indicator panel.

Part E3 Lift installations

Performance Requirements

EP3.1 Stretcher facilities

Stretcher facilities must be provided, to the degree necessary—

- (a) in at least one emergency lift *required* by EP3.2; or
- (b) where an emergency lift is not *required* and a passenger lift is provided, in at least one lift, to serve each floor in the building served by the passenger lift.

EP3.2 Emergency lifts

One or more passenger lifts fitted as emergency lifts to serve each floor served by the lifts in a building must be installed to facilitate the activities of the *fire brigade* and other emergency services personnel.

Application:

EP3.2 only applies to—

- (a) a building with an *effective height* of more than 25 m; and
- (b) a Class 9a building in which *patient care areas* are located at a level that does not have direct access to a road or *open space*.

EP3.3 Emergency alerts

Signs or other means must be provided to alert occupants about the use of a lift during an emergency.

EP3.4 Lift access for people with a disability

When a passenger lift is provided in a building *required* to be *accessible*, it must be suitable for use by people with a disability.

Verification Methods

EV3.1 Fire Safety Verification Method

Compliance with EP3.2 is verified when a building is designed in accordance with Schedule 7.

EV3.2 Emergency alerts on the use of lifts

- (a) Compliance with *Performance Requirement EP3.3* is verified when building occupants are provided with *automatic* warning that lifts must not be used during a fire emergency.
- (b) The *automatic* warning must—
 - (i) be initiated by a smoke hazard management system complying with Part E2; and
 - (ii) be provided via a sound system complying with the relevant provisions of AS 1670.4; and
 - (iii) have a flashing warning sign installed in accordance with AS 1670.4 clause 4.3.9 displaying the words “do not use lift”.

Part E3 Lift installations

Deemed-to-Satisfy Provisions

E3.0 Deemed-to-Satisfy Provisions

- (a) Where a *Deemed-to-Satisfy Solution* is proposed, *Performance Requirements EP3.1* to *EP3.4* are satisfied by complying with—
- (i) *E3.1* to *E3.10*; and
 - (ii) for a building containing an *occupiable outdoor area*, *Part G6*; and
 - (iii) for public transport buildings, *Part H2*.
- (b) Where a *Performance Solution* is proposed, the relevant *Performance Requirements* must be determined in accordance with *A2.2(3)* and *A2.4(3)* as applicable.

E3.1 Lift installations

An *electric passenger lift* installation and an *electrohydraulic passenger lift* installation must comply with *Specification E3.1*.

E3.2 Stretcher facility in lifts

- (a) A stretcher facility in accordance with (b) must be provided—
- (i) in at least one emergency lift *required* by *E3.4*; or
 - (ii) where an emergency lift is not *required*, if passenger lifts are installed to serve any storey above an *effective height* of 12 m, in at least one of those lifts to serve each floor served by the lifts.
- (b) A stretcher facility must accommodate a raised stretcher with a patient lying on it horizontally by providing a clear space not less than 600 mm wide x 2000 mm long x 1400 mm high above the floor level.

E3.3 Warning against use of lifts in fire

A warning sign must—

- (a) be displayed where it can be readily seen—
- (i) near every call button for a passenger lift or group of lifts throughout a building; except
 - (ii) a small lift such as a dumb-waiter or the like that is for the transport of goods only; and
- (b) comply with the details and dimensions of *Figure E3.3* and consist of—
- (i) incised, inlaid or embossed letters on a metal, wood, plastic or similar plate securely and permanently attached to the wall; or
 - (ii) letters incised or inlaid directly into the surface of the material forming the wall.

Services and equipment

Deemed-to-Satisfy Provisions

Figure E3.3 Warning sign for passenger lifts

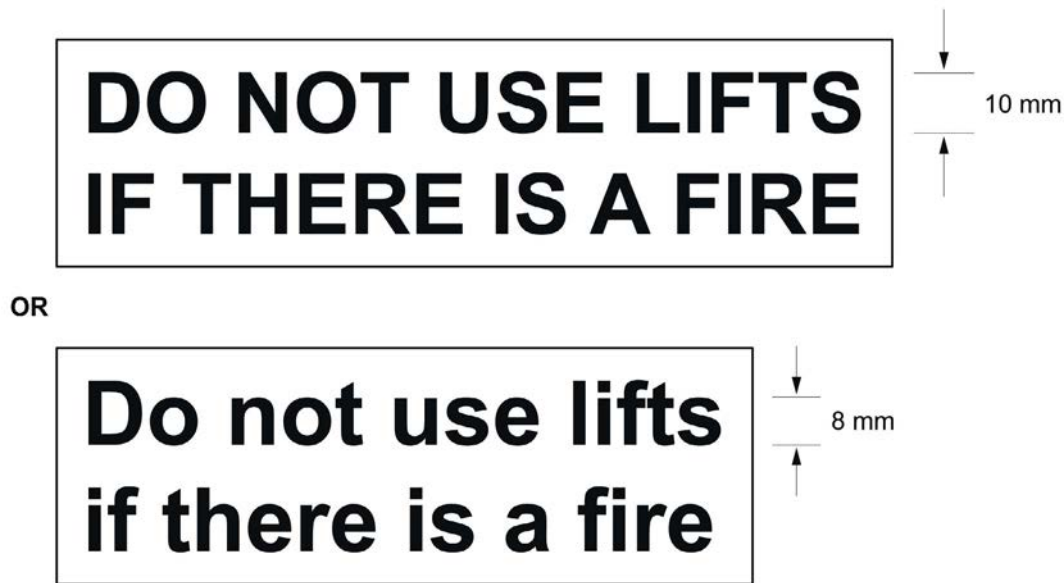

E3.4 Emergency lifts

- (a) At least one emergency lift complying with (d) must be installed in—
- a building which has an *effective height* of more than 25 m; and
 - a Class 9a building in which *patient care areas* are located at a level that does not have direct egress to a road or *open space*.
- (b) An emergency lift may be combined with a passenger lift and must serve those *storeys* served by the passenger lift so that all *storeys* of the building served by passenger lifts are served by at least one emergency lift.
- (c) Where two or more passenger lifts are installed and serve the same *storeys*, excluding a lift that is within an *atrium* and not contained wholly within a *shaft*—
- at least two emergency lifts must be provided to serve those *storeys*; and
 - if located within different *shafts*, at least one emergency lift must be provided in each *shaft*.
- (d) An emergency lift must—
- be contained within a *fire-resisting shaft* in accordance with C2.10; and
 - in a Class 9a building serving a *patient care area*—
 - have minimum dimensions, measured clear of all obstructions, including handrails, etc complying with Table E3.4; and
 - be connected to a standby power supply system where installed; and
 - if the building has an *effective height* of more than 75 m, have a rating of at least—
 - 600 kg if not provided with a stretcher facility; or
 - 900 kg if provided with a stretcher facility.

Table E3.4 Minimum emergency lift dimensions in Class 9a buildings

Lift component	Minimum dimension (mm)
Minimum depth of car	2280
Minimum width of car	1600
Minimum floor to ceiling height	2300
Minimum door height	2100

Services and equipment

Deemed-to-Satisfy Provisions

Lift component	Minimum dimension (mm)
Minimum door width	1300

E3.5 Landings

Access and egress to and from liftwell landings must comply with the *Deemed-to-Satisfy Provisions* of Section D.

E3.6 Passenger lifts

In an accessible building, every passenger lift must—

- be one of the types identified in Table E3.6a, subject to the limitations on use specified in the Table; and
- have *accessible* features in accordance with Table E3.6b; and
- not rely on a constant pressure device for its operation if the lift car is fully enclosed.

Table E3.6a Limitations on use of types of passenger lifts

Lift type	Limitations on use
<i>Electric passenger lift</i>	No limitation.
<i>Electrohydraulic passenger lift</i>	No limitation.
<i>Stairway platform lift</i>	Must not— (a) be used to serve a space in a building accommodating more than 100 persons calculated according to D1.13; or (b) be used in a high traffic public use area such as a theatre, cinema, auditorium, transport interchange, shopping centre or the like; or (c) be used where it is possible to install another type of passenger lift; or (d) connect more than 2 <i>storeys</i> ; or (e) where more than 1 stairway lift is installed, serve more than 2 consecutive <i>storeys</i> ; or (f) when in the folded position, encroach on the minimum width of a stairway <i>required</i> by D1.6.
<i>Inclined lift</i>	No limitation.
<i>Low-rise platform lift</i>	Must not travel more than 1000 mm.
<i>Low-rise, low-speed constant pressure lift</i>	Must not— (a) for an enclosed type, travel more than 4 m; or (b) for an unenclosed type, travel more than 2 m; or (c) be used in a high traffic public use areas in buildings such as a theatre, cinema, auditorium, transport interchange, shopping complex or the like.
<i>Small-sized, low-speed automatic lift</i>	Must not travel more than 12 m.

Table E3.6b Application of features to passenger lifts

Feature	Application
Handrail complying with the provisions for a mandatory handrail in AS 1735.12	All lifts except— (a) a <i>stairway platform lift</i> ; and (b) a <i>low-rise platform lift</i> .
Lift floor dimension of not less than 1400 mm wide x 1600 mm deep	All lifts which travel more than 12 m.
Lift floor dimensions of not less than 1100 mm wide x 1400 mm deep	All lifts which travel not more than 12 m except a <i>stairway platform lift</i> .
Lift floor dimensions of not less than 810 mm wide x 1200 mm deep	A <i>stairway platform lift</i> .
Minimum clear door opening complying with AS 1735.12	All lifts except a <i>stairway platform lift</i> .

Services and equipment

Deemed-to-Satisfy Provisions

Feature	Application
Passenger protection system complying with AS 1735.12	All lifts with a power operated door.
Lift landing doors at the upper landing	All lifts except a <i>stairway platform lift</i> .
Lift car and landing control buttons complying with AS 1735.12	All lifts except— (a) a <i>stairway platform lift</i> ; and (b) a <i>low-rise platform lift</i> .
Lighting in accordance with AS 1735.12	All enclosed lift cars.
(a) Automatic audible information within the lift car to identify the level each time the car stops; and (b) audible and visual indication at each lift landing to indicate the arrival of the lift car; and (c) audible information and audible indication <i>required</i> by (a) and (b) is to be provided in a range of between 20–80 dB(A) at a maximum frequency of 1 500 Hz	All lifts serving more than 2 levels.
Emergency hands-free communication, including a button that alerts a call centre of a problem and a light to signal that the call has been received	All lifts except a <i>stairway platform lift</i> .

E3.7 Fire service controls

Where lifts serve any *storey* above an *effective height* of 12 m, the following must be provided:

- (a) A fire service recall control switch complying with E3.9 for—
 - (i) a group of lifts; or
 - (ii) a single lift not in a group that serves the *storey*.
- (b) A lift car fire service drive control switch complying with E3.10 for every lift.

E3.8 Residential care buildings

Where residents in a Class 9c *residential care building* are on levels which do not have direct access to a road or *open space*, the building must be provided with either—

- (a) at least one lift to accommodate a stretcher in accordance with E3.2(b); or
 - (b) a ramp in accordance with AS 1428.1, and
- the lift or ramp must discharge at a level providing direct access to a road or *open space*.

E3.9 Fire service recall control switch

- (a) Each group of lifts must be provided with one fire service recall control switch *required* by E3.7 that activates the fire service recall operation at (e). The switch must—
 - (i) be located at the landing nominated by the *appropriate authority*; and
 - (ii) be labelled “FIRE SERVICE” in indelible white lettering on a red background; and
 - (iii) have two positions with an “OFF” and an “ON” position identified; and
 - (iv) be operable only by the use of a key that is removable in either the “OFF” position or the “ON” position.
- (b) Adhesive labels must not be used for compliance with (a)(ii) and (a)(iii).
- (c) The key in (a)(iv) must be able to turn all fire service recall control switches in the building and must have a different key combination to other keys used for lifts in the building.
- (d) The fire service recall operation must be activated by—
 - (i) switching the fire service recall control switch in (a) to “ON”; or
 - (ii) a signal from a fire management system approved by the *appropriate authority*.
- (e) The activation of the fire service recall operation at (d) must—

Services and equipment

Deemed-to-Satisfy Provisions

- (i) cancel all registered car and landing calls; and
 - (ii) inactivate all door reopening devices that may be affected by smoke; and
 - (iii) ensure lift cars travelling toward the nominated floor continue to the nominated floor without stopping; and
 - (iv) ensure lift cars travelling away from the nominated floor stop at or before the next available floor without opening the doors (either automatically or by the door open button), reverse direction and travel without stopping to the nominated floor; and
 - (v) for lifts stopped at a floor other than the nominated floor, close the doors and travel without stopping to the nominated floor; and
 - (vi) ensure that lifts stay at the nominated floor with doors open; and
 - (vii) permit all lifts to return to normal service if the fire service recall control switch at (a) is switched to the “OFF” position during or after the fire service recall operation.
- (f) The requirements of (e) do not apply to lifts on inspection service or when the lift car fire service control switch *required* by E3.10 is in the “ON” position.
- (g) Lifts having manual controls must signal an alert to the lift for the lift to return to the nominated floor containing the recall switch that activated the signal.

E3.10 Lift car fire service drive control switch

- (a) The lift car fire service drive control switch *required* by E3.7 must be activated from within the lift car. The switch must—
- (i) be located between 600 mm and 1500 mm above the lift car floor; and
 - (ii) be labelled “FIRE SERVICE” by indelible white lettering on a red background; and
 - (iii) have two positions with an “OFF” and an “ON” position identified; and
 - (iv) operate only by the use of a key that is removable in either the “OFF” position or the “ON” position.
- (b) Adhesive labels must not be used for compliance with (a)(ii) or (a)(iii).
- (c) When the lift car fire service drive control switch at (a) is turned to the “ON” position, the lift must—
- (i) not respond to the fire service recall control switch; and
 - (ii) cancel all registered lift car and landing calls; and
 - (iii) override all lift car call access control systems; and
 - (iv) inactivate all door reopening devices that may be affected by smoke; and
 - (v) allow the registration of lift car call by lift car call buttons, however the lift doors must not close in response to the registration of lift car calls; and
 - (vi) activate door closing by constant pressure being applied on the “door close” button unless the button is released before the doors are fully closed, in which case the doors must reopen and any registered lift car calls must be cancelled; and
 - (vii) when the doors are closed, move the lift in response to registered lift car calls while allowing additional lift car calls to also be registered; and
 - (viii) travel to the first possible floor in response to registered lift car calls and cancel all registered lift car calls after the lift stops; and
 - (ix) ensure doors do not open automatically, rather by constant pressure being applied on the “door open” button unless the button is released before the doors are fully open, in which case the doors must re-close; and the requirements of (c)(i) to (c)(ix) do not apply to a lift operating on inspection service.
- (d) A multi-deck lift installation must have systems in place that—
- (i) are able to communicate to the fire officer that the fire service drive control switch will not operate until all decks have been cleared of passengers; and
 - (ii) ensure there is an appropriate method of clearing all deck landings of passengers; and

Services and equipment

Deemed-to-Satisfy Provisions

- (iii) maintain all doors to deck landings not containing the fire service control switch closed and inoperative while the lift is on fire service drive control.

Specification E3.1

Lift installations

Deemed-to-Satisfy Provisions

1. Scope

This Specification contains requirements for *electric passenger lift* installations and *electrohydraulic passenger lift* installations.

2. Lift cars exposed to solar radiation

- (a) A lift car exposed to solar radiation directly, or indirectly by re-radiation, must have—
 - (i) mechanical ventilation at a rate of one air change per minute; or
 - (ii) mechanical cooling.
- (b) A 2 hour alternative power source for ventilation or mechanical cooling at (a) must be provided in the event of normal power loss.

3. Lift car emergency lighting

A lift car must have an emergency lighting system designed—

- (a) to come on automatically upon failure of the normal lighting supply; and
- (b) to provide at least 20 lux of lighting for 2 hours on the alarm initiation button.

4. Cooling of lift shaft

While a lift in a lift *shaft* is in service, the cooling of the lift *shaft* must—

- (a) ensure that the dry bulb air temperature in the lift *shaft* does not exceed 40°C; and
- (b) if the cooling is by a ventilation system, be provided with an air change rate determined using a temperature rise of no more than 5 K.

5. Lift foyer access

Where there is a security foyer in a building, access may be via locked security doors provided—

- (a) security doors revert to the unlocked state in the event of—
 - (i) power failure; or
 - (ii) fire alarm; and
- (b) locked foyer areas are monitored by closed circuit television and intercom system to a 24 hour staffed location.

6. Emergency access doors in a single enclosed lift shaft

- (a) Where a lift is installed in a single enclosed lift *shaft* having a distance between normal landing entrances greater than 12.2 m, emergency access doors must be provided and constructed as follows:
 - (i) The clear opening size of emergency doors must be not less than 600 mm wide x 980 mm high.
 - (ii) Hinged doors must not open towards the interior of the lift *shaft*.
 - (iii) Doors must be *self-closing* and self-locking.
 - (iv) Doors must be marked on the landing side with the letters not less than 35 mm high:
“DANGER LIFTWELL ACCESS”
“KEEP FURNITURE AND FIXTURES CLEAR”.
 - (v) Doors from the landing side must only be openable by a tool.
 - (vi) Each emergency door must be provided with a positive breaking electrical contact, wired into the control

Services and equipment

Deemed-to-Satisfy Provisions

circuit to prevent movement of the lift until the emergency door is both closed and locked.

(b) In single enclosed lift *shafts* where—

- (i) ropes are installed; and
- (ii) the vertical distance between the lift car sill and the landing door head is less than 600 mm; and
- (iii) the counterweight is resting on its fully compressed buffer,

emergency egress from the lift car must be provided in the form of an interlocked door with clear opening dimensions not less than 600 mm x 600 mm, accessible from the lift car entrance or the lift car roof (where the door is located in the wall of the lift *shaft*).

Part E4 Visibility in an emergency, exit signs and warning systems

Performance Requirements

EP4.1 Visibility in an emergency

To facilitate safe evacuation in an emergency, a building must be provided with a system that—

- (a) ensures a level of visibility sufficient to enable *exits*, paths of travel to *exits* and any obstacles along a path of travel to an *exit* to be identified; and
- (b) activates instantaneously upon the failure of an artificial lighting system, to the degree necessary, appropriate to—
 - (i) the function or use of the building; and
 - (ii) the *floor area* of the building; and
 - (iii) the distance of travel to an *exit*.

Limitation:

EP4.1 does not apply to the internal parts of a *sole-occupancy unit* in a Class 2, 3 or 9c building or Class 4 part of a building.

EP4.2 Identification of exits

To facilitate evacuation, suitable signs or other means of identification must, to the degree necessary—

- (a) be provided to identify the location of *exits*; and
- (b) guide occupants to *exits*; and
- (c) be clearly visible to occupants; and
- (d) operate in the event of a power failure of the main lighting system for sufficient time for occupants to safely evacuate.

Limitation:

EP4.2 does not apply to the internal parts of a *sole-occupancy unit* in a Class 2 or 3 building or Class 4 part of a building.

EP4.3 Emergency warning and intercom systems

To warn occupants of an emergency and assist evacuation of a building, an emergency warning and intercom system must be provided, to the degree necessary, appropriate to—

- (a) the *floor area* of the building; and
- (b) the function or use of the building; and
- (c) the height of the building.

Verification Methods

EV4.1 Emergency lighting

Compliance with EP4.1 is verified for the level of visibility for safe evacuation in an emergency and instantaneous activation, when an emergency lighting system satisfies the requirements below:

- (a) The calculated horizontal *illuminance* is not less than—
 - (i) 0.2 lux at floor level in the path of travel to an *exit*; and
 - (ii) 1 lux at each floor level or tread in every *required*—
 - (A) *fire-isolated stairway*; or
 - (B) *fire-isolated passageway*; or
 - (C) *fire-isolated ramp*; or

Services and equipment

- (D) non-*fire-isolated stairway*; or
 - (E) non-*fire-isolated ramp*.
- (b) The emergency lighting provides a level of *illuminance* not less than—
- (i) 10% of that *required* by (a) within 1 second of energization; and
 - (ii) 80% of that *required* by (a) within 15 seconds of energization.
- (c) The full level of illumination *required* by (a) must be achieved within 60 seconds of energization.
- (d) An emergency lighting system must operate at not less than the minimum *required* level of *illuminance* for not less than 90 minutes.

EV4.2 Fire Safety Verification Method

Compliance with [EP4.1](#), [EP4.2](#) and [EP4.3](#) is verified when a building is designed in accordance with [Schedule 7](#).

Part E4 Visibility in an emergency, exit signs and warning systems

Deemed-to-Satisfy Provisions

E4.0 Deemed-to-Satisfy Provisions

- (a) Where a *Deemed-to-Satisfy Solution* is proposed, *Performance Requirements* EP4.1 to EP4.3 are satisfied by complying with—
- (i) E4.1 to E4.9; and
 - (ii) in a building containing an *atrium*, Part G3; and
 - (iii) in a building in an *alpine area*, Part G4; and
 - (iv) for a building containing an *occupiable outdoor area*, Part G6; and
 - (v) for additional requirements for Class 9b buildings, Part H1; and
 - (vi) for *farm buildings* and *farm sheds*, Part H3.
- (b) Where a *Performance Solution* is proposed, the relevant *Performance Requirements* must be determined in accordance with A2.2(3) and A2.4(3) as applicable.

E4.1 * * * * *

This clause has deliberately been left blank.

E4.2 Emergency lighting requirements

An emergency lighting system must be installed—

- (a) in every *fire-isolated stairway*, *fire-isolated passageway* or *fire-isolated ramp*; and
- (b) in every *storey* of a Class 5, 6, 7, 8 or 9 building where the *storey* has a *floor area* more than 300 m²—
- (i) in every passageway, corridor, hallway, or the like, that is part of the path of travel to an *exit*; and
 - (ii) in any room having a *floor area* more than 100 m² that does not open to a corridor or space that has emergency lighting or to a road or *open space*; and
 - (iii) in any room having a *floor area* more than 300 m²; and
SA E4.2(b)(iii)
- (c) in every passageway, corridor, hallway, or the like, having a length of more than 6 m from the entrance doorway of any *sole-occupancy unit* in a Class 2 or 3 building or Class 4 part of a building to the nearest doorway opening directly to—
- (i) a *fire-isolated stairway*, *fire-isolated passageway* or *fire-isolated ramp*; or
 - (ii) an external stairway serving instead of a *fire-isolated stairway* under D1.8; or
 - (iii) an external balcony leading to a *fire-isolated stairway*, *fire-isolated passageway* or *fire-isolated ramp*; or
 - (iv) a road or *open space*; and
- (d) in every *required non-fire-isolated stairway*; and
- (e) in a *sole-occupancy unit* in a Class 5, 6 or 9 building if—
- (i) the *floor area* of the unit is more than 300 m²; and
 - (ii) an *exit* from the unit does not open to a road or *open space* or to an external stairway, passageway, balcony or ramp, leading directly to a road or *open space*; and
- (f) in every room or space to which there is public access in every *storey* in a Class 6 or 9b building if—
- (i) the *floor area* in that *storey* is more than 300 m²; or

Services and equipment

Deemed-to-Satisfy Provisions

- (ii) any point on the floor of that *storey* is more than 20 m from the nearest doorway leading directly to a stairway, ramp, passageway, road or *open space*; or
 - (iii) egress from that *storey* involves a vertical rise within the building of more than 1.5 m, or any vertical rise if the *storey* concerned does not admit sufficient light; or
 - (iv) the *storey* provides a path of travel from any other *storey required* by (i), (ii) or (iii) to have emergency lighting; and
- (g) in a Class 9a *health-care building*—
- (i) in every passageway, corridor, hallway, or the like, serving a *treatment area* or a *ward area*; and
 - (ii) in every room having a *floor area* of more than 120 m² in a *patient care area*; and
- (h) in every Class 9c building excluding within *sole-occupancy units*; and
- (i) in every *required* fire control centre.
- SA E4.2(j)*

E4.3 Measurement of distance

Distances, other than vertical rise, must be measured along the shortest path of travel whether by straight lines, curves or a combination of both.

E4.4 Design and operation of emergency lighting

Every *required* emergency lighting system must comply with AS/NZS 2293.1.

E4.5 Exit signs

An *exit* sign must be clearly visible to persons approaching the *exit*, and must be installed on, above or adjacent to each—

- (a) door providing direct egress from a *storey* to—
 - (i) an enclosed stairway, passageway or ramp serving as a *required exit*; and
 - (ii) an external stairway, passageway or ramp serving as a *required exit*; and
 - (iii) an external access balcony leading to a *required exit*; and
 - (b) door from an enclosed stairway, passageway or ramp at every level of discharge to a road or *open space*; and
 - (c) *horizontal exit*; and
 - (d) door serving as, or forming part of, a *required exit* in a *storey required* to be provided with emergency lighting in accordance with E4.2.
- SA E4.5(e)*

E4.6 Direction signs

NSW E4.6

If an *exit* is not readily apparent to persons occupying or visiting the building then *exit* signs must be installed in appropriate positions in corridors, hallways, lobbies, and the like, indicating the direction to a *required exit*.

E4.7 Class 2 and 3 buildings and Class 4 parts: Exemptions

E4.5 does not apply to—

- (a) a Class 2 building in which every door referred to is clearly and legibly labelled on the side remote from the *exit* or balcony—
 - (i) with the word “EXIT” in capital letters 25 mm high in a colour contrasting with that of the background; or
 - (ii) by some other suitable method; and
- (b) an entrance door of a *sole-occupancy unit* in a Class 2 or 3 building or Class 4 part of a building.

Services and equipment

Deemed-to-Satisfy Provisions

E4.8 Design and operation of exit signs

Every *required exit* sign must comply with—

- (a) AS/NZS 2293.1; or
 - (b) for a photoluminescent *exit* sign, [Specification E4.8](#); and
- be clearly visible at all times when the building is occupied by any person having the right of legal entry to the building.
[SA E4.8\(c\)](#)

E4.9 Emergency warning and intercom systems

An emergency warning and intercom system complying where applicable with AS 1670.4 must be installed—

- (a) in a building with an *effective height* of more than 25 m; and
- (b) in a Class 3 building having a *rise in storeys* of more than 2 and used as—
 - (i) the residential part of a primary or secondary *school*; or
 - (ii) accommodation for the aged, children or people with a disability; and
- (c) in a Class 3 building used as a *residential care building*, except that the system—
 - (i) must be arranged to provide a warning for occupants; and
 - (ii) in areas used by the residents, may have its alarm adjusted in volume and content to minimise trauma consistent with the type and condition of residents; and
- (d) in a Class 9a building having a *floor area* of more than 1000 m² or a *rise in storeys* of more than 2, and the system—
 - (i) must be arranged to provide a warning for occupants; and
 - (ii) in a *ward area*, may have its alarm adjusted in volume and content to minimise trauma consistent with the type and condition of patients; and
- (e) in a Class 9b building—
 - (i) used as a *school* and having a *rise in storeys* of more than 3; or
 - (ii) used as a theatre, public hall, or the like, having a *floor area* more than 1000 m² or a *rise in storeys* of more than 2.

Specification E4.8

Photoluminescent exit signs

Deemed-to-Satisfy Provisions

1. Scope

This Specification contains requirements for photoluminescent *exit* signs.

2. Application

A photoluminescent *exit* sign must comply with Section 5 and Appendix D of AS/NZS 2293.1, except where varied by this Specification.

3. Illumination

A photoluminescent *exit* sign must—

- (a) be maintained in a continuously charged state by a minimum illumination of 100 lux at the face of the sign by a dedicated light source with a colour temperature not less than 4000 K; and
- (b) in the event of a power failure, continue to provide a minimum luminance of 30 mcd/m² for not less than 90 minutes; and
- (c) have its performance verified by testing in accordance with ASTM E2073-10, except the activation illumination in clause 8.3 is replaced with 54 lux.

4. Pictorial elements

Pictorial elements on a photoluminescent *exit* sign must—

- (a) where the colour white is used, be replaced with a photoluminescent material; and
- (b) be not less than 1.3 times larger than that specified in Table 5.1 of AS/NZS 2293.1; and
- (c) have a border of photoluminescent material that extends not less than 15 mm beyond the pictorial elements.

5. Viewing distance

The maximum viewing distance in clause 5.6 of AS/NZS 2293.1 must not be more than 24 m.

6. Smoke control systems

Smoke control systems required by clause 5.3 of AS/NZS 2293.1 do not apply to a photoluminescent *exit* sign.

Health and amenity

- Part F1** **Damp and weatherproofing**
- Part F2** **Sanitary and other facilities**
- Part F3** **Room heights**
- Part F4** **Light and ventilation**
- Part F5** **Sound transmission and insulation**
- Part F6** **Condensation management**

Section F Health and amenity

Part F1 Damp and weatherproofing

Performance Requirements

- FP1.1 Managing rainwater impact on adjoining properties
- FP1.2 Preventing rainwater from entering buildings
- FP1.3 Rainwater drainage systems
- FP1.4 Weatherproofing
- FP1.5 Rising damp
- FP1.6 Wet area overflows
- FP1.7 Wet areas

Verification Methods

- FV1.1 Weatherproofing
- FV1.2 Overflow protection
- F1.0 Deemed-to-Satisfy Provisions
- F1.1 Stormwater drainage
- F1.2 * * * * *
- F1.3 * * * * *
- F1.4 External above ground membranes
- F1.5 Roof coverings
- F1.6 Sarking
- F1.7 Waterproofing of wet areas in buildings
- F1.8 * * * * *
- F1.9 Damp-proofing
- F1.10 Damp-proofing of floors on the ground
- F1.11 Provision of floor wastes
- F1.12 Subfloor ventilation
- F1.13 Glazed assemblies

Part F2 Sanitary and other facilities

Performance Requirements

- FP2.1 Personal hygiene facilities
- FP2.2 Laundry facilities
- FP2.3 Kitchen facilities
- FP2.4 Disposal of contaminated water from containers
- FP2.5 Construction of sanitary compartments to allow removal of unconscious people
- FP2.6 Microbial control for water systems

Verification Methods

- FV2.1 Sanitary facilities
- F2.0 Deemed-to-Satisfy Provisions
- F2.1 Facilities in residential buildings
- F2.2 Calculation of number of occupants and facilities
- F2.3 Facilities in Class 3 to 9 buildings
- F2.4 Accessible sanitary facilities
- F2.5 Construction of sanitary compartments
- F2.6 Interpretation: Urinals and washbasins
- F2.7 Microbial (legionella) control
- F2.8 Waste management
- F2.9 Accessible adult change facilities

Specification F2.9 Accessible adult change facilities

1. Scope
2. General requirements

3. Hoist
4. Toilet pan, seat, backrest and grabrails
5. Washbasin and tap
6. Fixtures and fittings
7. Change table
8. Changing rails
9. Door and door controls
10. Signage
11. Operating instructions

Part F3 Room heights

Performance Requirements

FP3.1 Room or space heights

Verification Methods

FV3.1 Room or space heights

F3.0 Deemed-to-Satisfy Provisions

F3.1 Height of rooms and other spaces

Part F4 Light and ventilation

Performance Requirements

FP4.1 Natural lighting

FP4.2 Artificial lighting

FP4.3 Outdoor air supply

FP4.4 Mechanical ventilation to control odours and contaminants

FP4.5 Disposal of contaminated air

Verification Methods

FV4.1 Verification of suitable indoor air quality

FV4.2 Verification of suitable indoor air quality for carparks

FV4.3 Verification of suitable provision of natural light

F4.0 Deemed-to-Satisfy Provisions

F4.1 Provision of natural light

F4.2 Methods and extent of natural light

F4.3 Natural light borrowed from adjoining room

F4.4 Artificial lighting

F4.5 Ventilation of rooms

F4.6 Natural ventilation

F4.7 Ventilation borrowed from adjoining room

F4.8 Restriction on location of sanitary compartments

F4.9 Airlocks

F4.10 * * * * *

F4.11 Carparks

F4.12 Kitchen local exhaust ventilation

Part F5 Sound transmission and insulation

Performance Requirements

FP5.1 Sound transmission through floors

FP5.2 Sound transmission through walls

FP5.3 Sound transmission through floor and wall penetrations and door assemblies

FP5.4 Sound transmission through floors in residential care buildings

FP5.5 Sound transmission through walls in residential care buildings

FP5.6 Sound transmission through floor and wall penetrations in residential care buildings

Verification Methods

FV5.1 Sound transmission through floors [FP5.1 and FP5.3]

FV5.2 Sound transmission through walls [FP5.2(a) and FP5.3]

FV5.3 Sound transmission through floors [FP5.4 and FP5.6]

- FV5.4 Sound transmission through walls [FP5.5(a) and FP5.6]
- F5.0 Deemed-to-Satisfy Provisions
- F5.1 Application of Part
- F5.2 Determination of airborne sound insulation ratings
- F5.3 Determination of impact sound insulation ratings
- F5.4 Sound insulation rating of floors
- F5.5 Sound insulation rating of walls
- F5.6 Sound insulation rating of internal services
- F5.7 Sound isolation of pumps

Specification F5.2 Sound insulation for building elements

1. Scope
2. Construction Deemed-to-Satisfy

Specification F5.5 Impact sound — Test of equivalence

1. Scope
2. Construction to be tested
3. Method

Part F6 Condensation management

Performance Requirements

FP6.1 Condensation and water vapour management

Verification Methods

- FV6 Condensation management
- F6.0 Deemed-to-Satisfy Provisions
- F6.1 Application of Part
- F6.2 Pliable building membrane
- F6.3 Flow rate and discharge of exhaust systems
- F6.4 Ventilation of roof spaces

Part F1 Damp and weatherproofing

Performance Requirements

FP1.1 Managing rainwater impact on adjoining properties

Surface water, resulting from a storm having an *average recurrence interval* of 20 years and which is collected or concentrated by a building or *sitework*, must be disposed of in a way that avoids the likelihood of damage or nuisance to any *other property*.

FP1.2 Preventing rainwater from entering buildings

Surface water, resulting from a storm having an *average recurrence interval* of 100 years must not enter the building.

Limitation:

FP1.2 does not apply to—

- (a) a Class 7 or 8 building where in the particular case there is no necessity for compliance; or
- (b) a garage, tool shed, *sanitary compartment*, or the like, forming part of a building used for other purposes; or
- (c) an *open spectator stand* or *open-deck carpark*.

FP1.3 Rainwater drainage systems

A drainage system for the disposal of *surface water* resulting from a storm having an *average recurrence interval* of—

- (a) 20 years must—
 - (i) convey *surface water* to an appropriate *outfall*; and
 - (ii) avoid *surface water* damaging the building; and
- (b) 100 years must avoid the entry of *surface water* into a building.

FP1.4 Weatherproofing

A roof and *external wall* (including openings around *windows* and doors) must prevent the penetration of water that could cause—

- (a) unhealthy or dangerous conditions, or loss of amenity for occupants; and
- (b) undue dampness or deterioration of building elements.

Limitation:

FP1.4 does not apply to—

- (a) a Class 7 or 8 building where in the particular case there is no necessity for compliance; or
- (b) a garage, tool shed, *sanitary compartment*, or the like, forming part of a building used for other purposes; or
- (c) an *open spectator stand* or *open-deck carpark*.

FP1.5 Rising damp

SA FP1.5

Moisture from the ground must be prevented from causing—

- (a) undue dampness or deterioration of building elements; and
- (b) unhealthy or dangerous conditions, or loss of amenity for occupants.

Limitation:

FP1.5 does not apply to—

- (a) a Class 7 or 8 building where in the particular case there is no necessity for compliance; or

Health and amenity

- (b) a garage, tool shed, *sanitary compartment*, or the like, forming part of a building used for other purposes; or
- (c) an *open spectator stand* or *open-deck carpark*:

FP1.6 Wet area overflows

SA FP1.6

Overflow from a bathroom, laundry facility or the like must be prevented from penetrating to—

- (a) another *sole-occupancy unit* used for sleeping accommodation; and
 - (b) a public space,
- in a *storey* below in the same building.

FP1.7 Wet areas

To protect the structure of the building and to maintain the amenity of the occupants, water must be prevented from penetrating—

- (a) behind fittings and linings; and
 - (b) into concealed spaces,
- of *sanitary compartments*, bathrooms, laundries and the like.

SA FP1.8

Verification Methods

FV1.1 Weatherproofing

- (a) Compliance with [FP1.4](#) for weatherproofing of an *external wall* that—
 - (i) has a risk score of 20 or less, when the sum of all risk factor scores are determined in accordance with [Table FV1.1](#); and
 - (ii) is not subjected to an ultimate limit state wind pressure of more than 2.5 kPa; and
 - (iii) includes only windows that comply with AS 2047, is verified when a prototype passes the procedure described below:
 - (iv) The test specimen is in accordance with the requirements of [\(b\)](#).
 - (v) The test procedure is in accordance with the requirements of [\(c\)](#).
 - (vi) The test specimen does not fail the criteria in [\(d\)](#).
 - (vii) The test is recorded in accordance with the requirements of [\(e\)](#).

Table FV1.1 Risk factors and scores

Risk factor	Category	Risk severity	Score
Wind region	Region A (AS/NZS 1170.2)	Low to medium	0
	Region B (AS/NZS 1170.2)		
	Region C (AS/NZS 1170.2)	High	1
	Region D (AS/NZS 1170.2)	Very high	2
Number of <i>storeys</i>	One <i>storey</i>	Low	0
	Two <i>storeys</i> in part	Medium	1
	Two <i>storeys</i>	High	2
	More than two <i>storeys</i>	Very high	4
Roof/wall junctions	Roof-to-wall junctions fully protected	Low	0
	Roof-to-wall junctions partially exposed	Medium	1
	Roof-to-wall junctions fully exposed	High	3
	Roof elements finishing within the boundaries formed by the <i>external walls</i>	Very high	5

Health and amenity

Risk factor	Category	Risk severity	Score
Eaves width	More than 600 mm for single <i>storey</i>	Low	0
	451-600 mm for single <i>storey</i> ; or more than 600 mm for two <i>storey</i>	Medium	1
	101-450 mm for single <i>storey</i> ; or 451-600 mm for two <i>storey</i> ; or more than 600 mm for above two <i>storey</i>	High	2
	0-100 mm for single <i>storey</i> ; or 0-450 mm for two <i>storey</i> ; or less than 600 mm for above two <i>storey</i>	Very high	5
Envelope complexity	Simple shape with single cladding type	Low	0
	Complex shape with not more than two cladding types	Medium	1
	Complex shape with more than two cladding types	High	3
	As for high risk but with fully exposed roof-to-wall junctions	Very high	6
Decks, porches and balconies	None; or timber slat deck or porch at ground level	Low	0
	Fully covered in plan view by roof; or timber slat deck attached at first or second floor level	Medium	2
	Balcony exposed in plan view at first floor level; or balcony cantilevered at first floor level	High	4
	Balcony exposed in plan view at second floor level or above; or balcony cantilevered at second floor level or above	Very high	6

Notes to Table FV1.1:

- Eaves width is measured horizontally from the external face of any wall cladding to the outer edge of any overhang, including fascia and external gutters.
- Barriers to prevent falling and parapets are considered as 0 mm eaves.

(b) Test specimen

The test specimen must incorporate—

- representative samples of openings and joints, including—
 - vertical and horizontal control joints; and
 - wall junctions; and
 - windows* or doors; and
 - electrical boxes; and
 - balcony drainage and parapet flashings; and
 - footer and header termination systems; and
- for a *cavity wall*—
 - a transparent material for a proportion of the internal wall lining (to provide an unobstructed view of the *external wall* cladding) with sufficient structural capability and similar air tightness to resist the applied wind pressures; and
 - a 15 mm diameter hole in the internal wall lining below a *window*.

(c) Test procedure

- The test procedure for a *direct fix cladding wall* or *unique wall* must be as follows:

Health and amenity

- (A) Apply 100% positive and negative serviceability wind pressures to the external face of the test specimen for a period of not less than 1 minute each.
- (B) Apply static pressure of either 300 Pa or 30% serviceability wind pressure, whichever is higher, in accordance with the water penetration test procedure at clause 8.5.2 of AS/NZS 4284.
- (C) Apply cyclic pressure in accordance with—
 - (aa) the three stages of [Table FV1.2](#); and
 - (bb) the water penetration test procedure at clause 8.6.2 of AS/NZS 4284.

Table FV1.2

Stage number	Serviceability wind pressure
1	15% to 30%
2	20% to 40%
3	30% to 60%

- (ii) The test procedure for a *cavity wall* must be as follows:
 - (A) Apply 100% positive and negative serviceability wind pressures to the external face of the test specimen for a period of not less than 1 minute each.
 - (B) Apply static pressure of either 300 Pa or 30% serviceability wind pressure, whichever is higher, in accordance with the water penetration test procedure at clause 8.5.2 of AS/NZS 4284.
 - (C) Apply cyclic pressure in accordance with—
 - (aa) stage 3 of [Table FV1.2](#); and
 - (bb) the water penetration test procedure at clause 8.6.2 of AS/NZS 4284.
 - (D) To simulate the failure of the primary weather-defence or sealing, the following procedure must be applied to the test specimen:
 - (aa) Insert 6 mm diameter holes through the external face of the *cavity wall* in all places specified below:
 - (AA) Wall/window or wall/door junctions at $\frac{3}{4}$ height.
 - (BB) Immediately above the head flashing.
 - (CC) Through external sealing of the horizontal and vertical joints.
 - (DD) Above any other penetration detail not covered by (AA) to (CC).
 - (bb) Repeat the static and cyclic pressure tests of (B) and (C).
 - (cc) Within 30 minutes of the completion of (bb), remove the internal lining of the *cavity wall* and check for compliance with (d).
 - (dd) With the internal lining removed, apply a final static pressure test at 50 Pa for a period of 15 minutes.

(d) Compliance

- (i) A *direct fix cladding wall* and *unique wall* are verified for compliance with [FP1.4](#) if there is no presence of water on the inside surface of the facade.
- (ii) A *cavity wall* is verified for compliance with [FP1.4](#) if there is no presence of water on the removed surface of the cavity, except that during the simulation of the failure of the primary weather-defence or sealing, water may—
 - (A) transfer to the removed surface of the cavity due to the introduced defects (6 mm holes); and
 - (B) contact, but not pool on, battens and other cavity surfaces.

(e) Test report

The test report must include the following information:

- (i) Name and address of the person supervising the test.
- (ii) Test report number.
- (iii) Date of the test.

Health and amenity

- (iv) Cladding manufacturer's name and address.
- (v) Construction details of the test specimen, including a description, and drawings and details of the components, showing modifications, if any.
- (vi) Test sequence with the pressures used in all tests.
- (vii) For each of the static and cyclic pressure tests, full details of all leakages, including position, extent and timing.

FV1.2 Overflow protection

FP1.6 is verified when the flow rate of the in-built overflow for all *vessels* in the room is greater than the flow rate of the source filling the *vessel*.

Application:

FV1.2 only applies to bathrooms, laundries and the like in a Class 2 or 3 building or a Class 4 part of a building.

Part F1 Damp and weatherproofing

Deemed-to-Satisfy Provisions

F1.0 Deemed-to-Satisfy Provisions

- (a) *Performance Requirement FP1.4*, for the prevention of the penetration of water through *external walls*, must be complied with.

There are no *Deemed-to-Satisfy Provisions* for this *Performance Requirement* in respect of *external walls*.

SA F1.0(b)

- (b) Where a *Deemed-to-Satisfy Solution* is proposed, *Performance Requirements FP1.1 to FP1.3* and *FP1.5 to FP1.7* are satisfied by complying with *F1.1 to F1.13*.
- (c) Where a *Performance Solution* is proposed, the relevant *Performance Requirements* must be determined in accordance with *A2.2(3)* and *A2.4(3)* as applicable.

F1.1 Stormwater drainage

Stormwater drainage must comply with AS/NZS 3500.3.

F1.2 * * * * *

This clause has deliberately been left blank.

F1.3 * * * * *

This clause has deliberately been left blank.

F1.4 External above ground membranes

Waterproofing membranes for external above ground use must comply with AS 4654.1 and AS 4654.2.

F1.5 Roof coverings

A roof must be covered with—

- (a) concrete roofing tiles complying with AS 2049 and fixed, except in cyclonic areas, in accordance with AS 2050, as appropriate; or
- (b) terracotta roofing tiles complying with AS 2049 and fixed, except in cyclonic areas, in accordance with AS 2050; or
- (c) cellulose cement corrugated sheeting complying with AS/NZS 2908.1 and installed in accordance with AS/NZS 1562.2; or
- (d) metal sheet roofing complying with AS 1562.1; or
- (e) plastic sheet roofing designed and installed in accordance with AS/NZS 4256.1, AS/NZS 4256.2, AS/NZS 4256.3, AS/NZS 4256.5 and AS/NZS 1562.3; or
- (f) Terracotta, fibre-cement and timber slates and shingles designed and installed in accordance with AS 4597, except in cyclonic areas.

F1.6 Sarking

Sarking-type material used for weatherproofing of roofs and walls must comply with AS/NZS 4200.1 and AS 4200.2.

F1.7 Waterproofing of wet areas in buildings

SA F1.7(a)

Health and amenity

Deemed-to-Satisfy Provisions

- (a) In a Class 2 and 3 building and a Class 4 part of a building, building elements in *wet areas* must—
- (i) be *water resistant* or *waterproof* in accordance with Table F1.7; and
 - (ii) comply with AS 3740.
- (b) In a Class 5, 6, 7, 8 or 9 building, building elements in the bathroom or shower room, a slop hopper or sink compartment, a laundry or *sanitary compartment* must—
- (i) be *water resistant* or *waterproof* in accordance with Table F1.7; and
 - (ii) comply with AS 3740,
as if they were in a Class 2 or 3 building or a Class 4 part of a building.
- (c) Where a slab or stall type urinal is installed—
- (i) the floor surface of the room containing the urinal must—
 - (A) be an impervious material; and
 - (B) where no step is installed—
 - (aa) be graded to the urinal channel for a distance of 1.5 m from the urinal channel; and
 - (bb) the remainder of the floor be graded to a floor waste; and
 - (C) where a step is installed—
 - (aa) the step must have an impervious surface and be graded to the urinal channel; and
 - (bb) the floor behind the step must be graded to a floor waste; and
 - (ii) the junction between the floor surface and the urinal channel must be impervious.
- (d) Where a wall hung urinal is installed—
- (i) the wall must be surfaced with impervious material extending from the floor to not less than 50 mm above the top of the urinal and not less than 225 mm on each side of the urinal.
 - (ii) the floor must be surfaced with impervious material and graded to a floor waste.
- (e) In a room with timber or steel-framed walls and containing a urinal—
- (i) the wall must be surfaced with an impervious material extending from the floor to not less than 100 mm above the floor surface; and
 - (ii) the junction of the floor surface and the wall surface must be impervious.

Table F1.7 Waterproofing and water-resistance requirements for building elements in wet areas

Vessels or area where the fixture is installed	Floors and horizontal surfaces	Walls	Wall junctions and joints	Wall / floor junctions	Penetrations
Shower area (enclosed and unenclosed)					
With hob	<i>Waterproof</i> floor in <i>shower area</i> (including any hob or step-down).	(a) <i>Waterproof</i> all walls in <i>shower area</i> to a height the greater of—	<i>Waterproof</i> wall junctions within <i>shower area</i> .	<i>Waterproof</i> wall / floor junctions within <i>shower area</i> .	<i>Waterproof</i> penetrations in <i>shower area</i> .
With step-down		(i) not less than 150 mm above floor substrate; or			
Without hob or step-down		(ii) not less than 25 mm above maximum retained			

Health and amenity

Deemed-to-Satisfy Provisions

Vessels or area where the fixture is installed	Floors and horizontal surfaces	Walls	Wall junctions and joints	Wall / floor junctions	Penetrations
		water level; and (b) <i>Water resistant</i> walls in <i>shower area</i> to not less than 1800 mm above finished floor level of the shower.			
With preformed shower base	N/A	<i>Water resistant</i> walls in <i>shower area</i> to not less than 1800 mm above finished floor level of the shower.	<i>Waterproof</i> wall junctions within <i>shower area</i> .	<i>Waterproof</i> wall / floor junctions within <i>shower area</i> .	<i>Waterproof</i> penetrations in <i>shower area</i> .
Area outside shower area					
For concrete and compressed fibre-cement sheet flooring	<i>Water resistant</i> floor of the room.				
For timber floors including particleboard, plywood and other timber based flooring materials	<i>Waterproof</i> floor of the room.	N/A	N/A	<i>Waterproof</i> wall / floor junctions.	N/A
Areas adjacent to baths and spas					
For concrete and compressed fibre-cement sheet flooring	<i>Water resistant</i> floor of the room.	(a) <i>Water resistant</i> to a height of not less than 150 mm above the <i>vessel</i> , for the extent of the <i>vessel</i> , where the <i>vessel</i> is within 75 mm of a wall.	<i>Water resistant</i> junctions within 150 mm above a <i>vessel</i> for the extent of the <i>vessel</i> .	<i>Water resistant</i> wall / floor junctions for the extent of the <i>vessel</i> .	<i>Waterproof</i> tap and spout penetrations where they occur in horizontal surfaces.
For timber floors including particleboard, plywood and other timber based flooring materials	<i>Waterproof</i> floor of the room.	(b) <i>Water resistant</i> all exposed surfaces below <i>vessel</i> lip.			
Inserted baths and spas	(a) <i>Waterproof</i> shelf area, incorporating waterstop under the bath lip.	(a) <i>Waterproof</i> to not less than 150 mm above lip of bath or spa; and	(a) <i>Waterproof</i> junctions within 150 mm above bath or spa; and	N/A	<i>Waterproof</i> tap and spout penetrations where they occur in horizontal surfaces.
	(b) No requirement under bath.	(b) No requirement under bath.	(b) No requirement under bath.		
Note: Where a shower is above a bath or spa, use requirements for shower.					
Other areas					
Walls adjoining other <i>vessel</i>	N/A	<i>Water resistant</i> to a height of not less than	<i>Waterproof</i> wall junctions where a	N/A	<i>Waterproof</i> tap and spout

Health and amenity

Deemed-to-Satisfy Provisions

Vessels or area where the fixture is installed	Floors and horizontal surfaces	Walls	Wall junctions and joints	Wall / floor junctions	Penetrations
(e.g. sink, basin or laundry tub)		150 mm above the <i>vessel</i> , for the extent of the <i>vessel</i> , where the <i>vessel</i> is within 75 mm of a wall.	<i>vessel</i> is fixed to a wall.		penetrations where they occur in surfaces <i>required</i> to be <i>waterproof</i> or <i>water resistant</i> .
Laundries and WCs	<i>Water resistant</i> floor of the room.	N/A	N/A	<i>Water resistant</i> wall / floor junctions.	<i>Waterproof</i> penetration where they occur in surfaces <i>required</i> to be <i>waterproof</i>
Bathrooms and laundries <i>required</i> to provide a floor waste by F1.11.	<i>Waterproof</i> floor of the room.	N/A	N/A	<i>Waterproof</i> wall / floor junctions.	<i>Waterproof</i> penetrations where they occur through the floor.

Note to Table F1.7:

N/A means not applicable.

F1.8 * * * * *

This clause has deliberately been left blank.

F1.9 Damp-proofing

- (a) Except for a building covered by (c), moisture from the ground must be prevented from reaching—
- (i) the lowest floor timbers and the walls above the lowest floor joists; and
 - (ii) the walls above the damp-proof course; and
 - (iii) the underside of a suspended floor constructed of a material other than timber, and the supporting beams or girders.

SA F1.9(b)

- (b) Where a damp-proof course is provided, it must consist of—
- (i) a material that complies with AS/NZS 2904; or
 - (ii) impervious sheet material in accordance with AS 3660.1.
- (c) The following buildings need not comply with (a):
- (i) A Class 7 or 8 building where in the particular case there is no necessity for compliance.
 - (ii) A garage, tool shed, *sanitary compartment*, or the like, forming part of a building used for other purposes.
 - (iii) An *open spectator stand* or *open-deck carpark*.

F1.10 Damp-proofing of floors on the ground

SA F1.10

If a floor of a room is laid on the ground or on fill, moisture from the ground must be prevented from reaching the upper surface of the floor and adjacent walls by the insertion of a vapour barrier in accordance with AS 2870, except damp-proofing need not be provided if—

Health and amenity

Deemed-to-Satisfy Provisions

- (a) weatherproofing is not *required*; or
- (b) the floor is the base of a stair, lift or similar *shaft* which is adequately drained by gravitation or mechanical means.

F1.11 Provision of floor wastes

SA F1.11

In a Class 2 or 3 building or Class 4 part of a building, a bathroom or laundry located at any level above a *sole-occupancy unit* or public space must have—

- (a) a floor waste; and
- (b) the floor graded to the floor waste to permit drainage of water.

F1.12 Subfloor ventilation

- (a) Subfloor spaces must—
 - (i) be provided with openings in *external walls* and internal subfloor walls in accordance with [Table F1.12](#) for the climatic zones given in [Figure F1.12](#); and
 - (ii) have clearance between the ground surface and the underside of the lowest horizontal member in the subfloor in accordance with [Table F1.12](#).

Table F1.12 Subfloor openings and ground clearance

Climatic zone (see Figure F1.12)	Minimum aggregate subfloor ventilation openings without a membrane (mm ² /m of wall)	Minimum aggregate subfloor ventilation openings having the ground sealed with an impervious membrane (mm ² /m of wall)	Minimum ground clearance height where termite inspection or management system is not <i>required</i> (mm)	Minimum ground clearance height where termite inspection is <i>required</i> (mm) <small>Note 1</small>
A	2000	1000	150	400
B	4000	2000	150	400
C	6000	3000	150	400

Notes to [Table F1.12](#):

1. 400 mm clearance *required* only where termite management systems are installed that need to be inspected (see [B1.4](#)).
2. On sloping sites, the 400 mm clearance *required* by (1) may be reduced to 150 mm within 2 m of *external walls*.
3. In situations where openings in *external walls* and internal subfloor walls are not able to be provided, additional measures must be provided to ensure that the overall level of ventilation of the subfloor space is maintained. This may include measures similar to those in [F1.12\(e\)](#) i.e. providing durability class timbers, or having the ground sealed in the subfloor space with an impervious membrane.

Health and amenity

Deemed-to-Satisfy Provisions

Figure F1.12 Climatic zones based on relative humidity

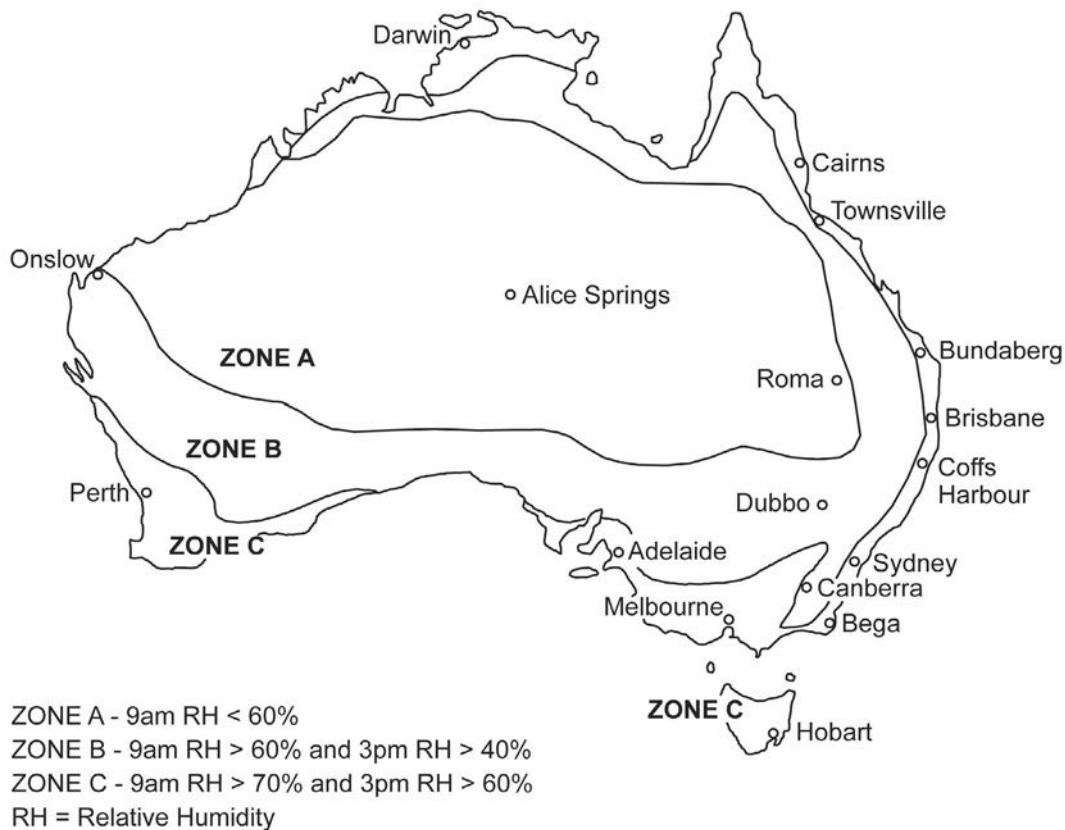

Note to Figure F1.12: The season with the highest relative humidity is used. Generally this will be July for southern Australia and January for northern Australia.

- (b) In addition to (a), a subfloor space must—
- (i) be cleared of all building debris and vegetation; and
 - (ii) have the ground beneath the suspended floor graded to prevent *surface water* ponding under the building; and
 - (iii) contain no dead air spaces; and
 - (iv) have openings evenly spaced as far as practicable; and
 - (v) have openings placed not more than 600 mm in from corners.
- (c) In double leaf masonry walls, openings specified in (a) must be provided in both leaves of the masonry, with openings being aligned to allow an unobstructed flow of air.
- (d) Openings in internal subfloor walls specified in (a) must have an unobstructed area equivalent to that *required* for the adjacent external openings.
- (e) Where the ground or subfloor space is excessively damp or subject to frequent flooding, in addition to the requirements of (a) to (d)—
- (i) the subfloor ventilation *required* in (a) must be increased by 50%; or
 - (ii) the ground within the subfloor space must be sealed with an impervious membrane; or
 - (iii) subfloor framing must be—
 - (A) where above ground, above-ground durability Class 1 or 2 timbers or H3 preservative treated timbers in accordance with AS 1684.2, AS 1684.3 or AS 1684.4; or
 - (B) where in ground, in-ground durability Class 1 or 2 timbers or H5 preservative treated timbers in accordance with AS 1684.2, AS 1684.3 or AS 1684.4; or

Deemed-to-Satisfy Provisions

(C) steel in accordance with NASH Standard 'Residential and Low-Rise Steel Framing' Part 2.

F1.13 Glazed assemblies

- (a) Subject to (b) and (c), the following glazed assemblies in an *external wall*, must comply with AS 2047 requirements for resistance to water penetration:
- (i) Windows.
 - (ii) Sliding and swinging glazed doors with a frame, including french and bi-fold doors with a frame.
 - (iii) Adjustable louvres.
 - (iv) Shopfronts.
 - (v) Window walls with one piece framing.
- (b) The following buildings need not comply with (a):
- (i) A Class 7 or 8 building where in the particular case there is no necessity for compliance.
 - (ii) A garage, tool shed, *sanitary compartment*, or the like, forming part of a building used for other purposes, except where the construction of the garage, tool shed, *sanitary compartment* or the like contributes to the weatherproofing of the other part of the building.
 - (iii) An *open spectator stand* or *open-deck carpark*.
- (c) The following glazed assemblies need not comply with (a):
- (i) All glazed assemblies not in an *external wall*.
 - (ii) Revolving doors.
 - (iii) Fixed louvres.
 - (iv) Skylights, roof lights and windows in other than the vertical plane.
 - (v) Sliding and swinging glazed doors without a frame.
 - (vi) Windows constructed on site and architectural one-off windows, which are not design tested in accordance with AS 2047.
 - (vii) Second-hand windows, re-used windows and recycled windows.
 - (viii) Heritage windows.

Part F2 Sanitary and other facilities

Performance Requirements

FP2.1 Personal hygiene facilities

Suitable sanitary facilities for personal hygiene must be provided in a convenient location within or associated with a building, to the degree necessary, appropriate to—

- (a) the function or use of the building; and
- (b) the number and gender of the occupants; and
- (c) the disability or other particular needs of the occupants.

FP2.2 Laundry facilities

Laundrying facilities or space for laundrying facilities and the means for the sanitary disposal of waste water must be provided in a convenient location within or associated with a building appropriate to the function or use of the building.

Vic FP2.2 Application

Application:

FP2.2 only applies to—

- (a) a Class 2 building or Class 4 part of a building; and
- (b) a Class 9a *health-care building*; and
- (c) a Class 9b *early childhood centre*; and
- (d) a Class 9c building.

FP2.3 Kitchen facilities

A facility must be provided which includes—

- (a) a means for food rinsing, utensil washing and the sanitary disposal of associated waste water; and
- (b) a means for cooking food; and
- (c) a space for food preparation.

Application:

FP2.3 only applies to—

- (a) a Class 2 building or Class 4 part of a building; and
- (b) a Class 9a *health-care building*; and
- (c) a Class 9b *early childhood centre*; and
- (d) a Class 9c building.

FP2.4 Disposal of contaminated water from containers

Suitable means must be provided in a building containing wards or bedrooms to facilitate the emptying of sewage or dirty water from containers.

Application:

FP2.4 only applies to a Class 9a or 9c building.

FP2.5 Construction of sanitary compartments to allow removal of unconscious people

A *sanitary compartment* must be constructed with sufficient space or other means to permit an unconscious occupant to be removed from the compartment.

FP2.6 Microbial control for water systems

NSW FP2.6

Hot water, warm water and cooling water systems installed in a building must control the accumulation of harmful levels of micro-organisms.

Limitation:

FP2.6 does not apply to a system serving only a single *sole-occupancy unit* in a Class 2 or 3 building or Class 4 part of a building.

Verification Methods

FV2.1 Sanitary facilities

- (a) Compliance with FP2.1, for the number of sanitary facilities, is verified when queuing modelling predicts that occupant waiting time for sanitary facilities is at least equivalent to the waiting time predicted using the respective *Deemed-to-Satisfy Provisions*.
- (b) For calculations performed under (a), the occupant waiting time is determined as the 90th percentile wait time at maximum population.
- (c) Queuing modelling in (a) must reflect the following:
 - (i) Function or use of the building.
 - (ii) Number and gender of occupants.
 - (iii) The disability or other particular needs of the occupants.
 - (iv) Occupant usage patterns.

Part F2 Sanitary and other facilities

Deemed-to-Satisfy Provisions

F2.0 Deemed-to-Satisfy Provisions

Vic F2.0

- (a) Where a *Deemed-to-Satisfy Solution* is proposed, *Performance Requirements FP2.1 to FP2.6* are satisfied by complying with—
- (i) *F2.1 to F2.9*; and
 - (ii) for public transport buildings, *Part H2*; and
 - (iii) for *farm sheds*, *Part H3*.
- (b) Where a *Performance Solution* is proposed, the relevant *Performance Requirements* must be determined in accordance with *A2.2(3)* and *A2.4(3)* as applicable.

F2.1 Facilities in residential buildings

- (a) For facilities in Class 2 buildings, the following applies:
- (i) Within each *sole-occupancy unit*, provide—
 - (A) a kitchen sink and facilities for the preparation and cooking of food; and
 - (B) a bath or shower; and
 - (C) a closet pan; and
 - (D) a washbasin.
 - (ii) For laundry facilities, provide either—
 - (A) in each *sole-occupancy unit*—
 - (aa) clothes washing facilities, comprising at least one washtub and a space for a washing machine; and
 - (bb) clothes drying facilities comprising clothes line or a hoist with not less than 7.5 m of line, or space for one heat operated drying cabinet or appliance in the same room as the clothes washing facilities; or
 - (B) a separate laundry for each 4 *sole-occupancy units*, or part thereof, that must comprise—
 - (aa) clothes washing facilities, comprising at least one washtub and a space for a washing machine; and
 - (bb) clothes drying facilities comprising clothes line or a hoist with not less than 7.5 m of line per *sole-occupancy unit*, or space for one heat operated drying cabinet or appliance.
 - (iii) For the purposes of (a)(i) and (a)(ii), a kitchen sink or washbasin must not be counted as a laundry washtub.
- (b) For facilities in Class 3 buildings other than *residential care buildings*, the following applies:
- (i) For residents in each building or group of buildings, provide—
 - (A) a bath or shower; and
 - (B) a closet pan; and
 - (C) a washbasin,
 for each 10 residents for whom private facilities are not provided.
 - (ii) Notwithstanding (b)(i), if one urinal is provided for each 25 males up to 50 and one additional urinal for each additional 50 males or part thereof, one closet pan for each 12 males may be provided.
 - (iii) Facilities for employees must be provided in accordance with *F2.3*.
 - (iv) Facilities *required* by (b)(i), (ii) or (iii) need not be situated in the same building.
- (c) For facilities in Class 3 *residential care buildings*, the following applies:
- (i) For residents in each building or group of buildings, provide—

Health and amenity

Deemed-to-Satisfy Provisions

- (A) a shower, closet pan and wash basin for each 8 residents or part thereof where private facilities are not provided; and
- (B) a suitable bath for each 30 residents or part thereof.
- (ii) For the purposes of (c)(i), urinals must not be taken into consideration in calculating the number of facilities.
- (d) For the *sole-occupancy unit* of a Class 4 part of a building, provide—
 - (i) a kitchen sink and facilities for the preparation and cooking of food; and
 - (ii) a bath or shower; and
 - (iii) a closet pan; and
 - (iv) a washbasin; and
 - (v) clothes washing facilities, comprising a washtub and space in the same room for a washing machine; and
 - (vi) a clothes line or hoist, or space for a heat-operated drying cabinet or similar appliance for the exclusive use of the occupants; and
 - (vii) for the purposes of (d)(v), a kitchen sink or washbasin must not be counted as a laundry washtub.
- (e) For facilities in Class 9c buildings, the following applies:
 - (i) For residents in each building or group of buildings, provide—
 - (A) a closet pan and wash basin for each 6 residents or part thereof where private facilities are not provided; and
 - (B) a shower for each 7 residents or part thereof for where private facilities are not provided; and
 - (C) a suitable bath, fixed or mobile.
 - (ii) In addition to the facilities *required* by (e)(i), provide—
 - (A) one kitchen or other adequate facility for the preparation and cooking or reheating of food including a kitchen sink and washbasin; and
 - (B) laundry facilities for the cleansing and drying of linen and clothing or adequate facilities for holding and dispatch or treatment of soiled linen and clothing and the like and the receipt and storage of clean linen; and
 - (C) one clinical hand washing basin for each 16 residents or part thereof.
 - (iii) For the purposes of (e)(i), urinals must not be taken into consideration in calculating the number of facilities.

F2.2 Calculation of number of occupants and facilities

- (a) The number of persons accommodated must be calculated according to D1.13 if it cannot be more accurately determined by other means.
- (b) Unless the premises are used predominantly by one sex, sanitary facilities must be provided on the basis of equal numbers of males and females.
- (c) In calculating the number of sanitary facilities to be provided under F2.1 and F2.3, a unisex facility *required* for people with a disability (other than a facility provided under F2.9) may be counted once for each sex.
- (d) For the purposes of this Part, a unisex facility comprises one closet pan, one washbasin and means for the disposal of sanitary products.

F2.3 Facilities in Class 3 to 9 buildings

- (a) Except where permitted by (b), (c), (f), F2.4(a), F2.4(b) and F2.9(b), separate sanitary facilities for males and females must be provided for Class 3, 5, 6, 7, 8 or 9 buildings in accordance with Table F2.3.
- (b) If not more than 10 people are employed, a unisex facility may be provided instead of separate facilities for each sex.
- (c) If the majority of employees are of one sex, not more than 2 employees of the other sex may share toilet facilities if the facilities are separated by means of walls, partitions and doors to afford privacy.

Health and amenity

Deemed-to-Satisfy Provisions

- (d) Employees and the public may share the same facilities in a Class 6 and 9b building (other than a *school* or *early childhood centre*) provided the number of facilities provided is not less than the total number of facilities *required* for employees plus those *required* for the public.
- (e) Adequate means of disposal of sanitary products must be provided in sanitary facilities for use by females.
- (f) Separate sanitary facilities for males and females need not be provided for patients in a *ward area* of a Class 9a building.
- (g) A Class 9a *health-care building* must be provided with—
 - (i) one kitchen or other adequate facility for the preparation and cooking or reheating of food including a kitchen sink and washbasin; and
 - (ii) laundry facilities for the cleansing and drying of linen and clothing or adequate facilities for holding and dispatch or treatment of soiled linen and clothing, sanitary products and the like and the receipt and storage of clean linen; and
 - (iii) one shower for each 8 patients or part thereof; and
 - (iv) one island-type plunge bath in each *storey* containing a *ward area*.

Vic F2.3(h) and *(ha)*

- (h) A Class 9b *early childhood centre* must be provided with—
 - (i) a kitchen or food preparation area with a kitchen sink, separate hand washing facilities, space for a refrigerator and space for cooking facilities, with—
 - (A) the facilities protected by a door or gate with child proof latches to prevent unsupervised access to the facilities by children younger than 5 years old; and
 - (B) the ability to facilitate supervision of children from the facilities if the *early childhood centre* accommodates children younger than 2 years old; and
 - (ii) one bath, shower or shower-bath; and
 - (iii) if the centre accommodates children younger than 3 years old—
 - (A) a laundry facility comprising a washtub and space in the same room for a washing machine; and
 - (B) a bench type baby bath, which is within 1 m of the nappy change bench; and
 - (C) a nappy changing bench which—
 - (aa) is within 1 m of separate adult hand washing facilities and bench type baby bath; and
 - (bb) must be not less than 0.9 m² in area and at a height of not less than 850 mm, but not more than 900 mm above the finished floor level; and
 - (cc) must have a space not less than 800 mm high, 500 mm wide and 800 mm deep for the storage of steps; and
 - (dd) is positioned to permit a staff member changing a nappy to have visibility of the play area at all times.
 - (i) Class 9b theatres and sporting venues must be provided with one shower for each 10 participants or part thereof.
 - (j) Not less than one washbasin must be provided where closet pans or urinals are provided.

Tas Table F2.3

Vic Table F2.3

Table F2.3 Sanitary facilities in Class 3, 5, 6, 7, 8 or 9 buildings

User Group	Closet Pans		Urinals		Washbasins	
	Design Occupancy	Number	Design Occupancy	Number	Design Occupancy	Number
Class 3, 5, 6 and 9 other than <i>schools</i>						
Male employees	1 — 20 > 20	1 Add 1 per 20	1 — 10 11 — 25 26 — 50 >50	0 1 2 Add 1 per 50	1 — 30 > 30	1 Add 1 per 30
Female employees	1 — 15 > 15	1 Add 1 per 15	N/A	N/A	1 — 30 > 30	1 Add 1 per 30
Class 7 and 8						
Male employees	1 — 20 > 20	1 Add 1 per 20	1 — 10 11 — 25 26 — 50 >50	0 1 2 Add 1 per 50	1 — 20 > 20	1 Add 1 per 20
Female employees	1 — 15 > 15	1 Add 1 per 15	N/A	N/A	1 — 20 > 20	1 Add 1 per 20
Note: Sanitary facilities need not be provided for a Class 8 <i>electricity network substation</i>						
Class 6 — department stores, shopping centres						
Male patrons	1 — 1200 > 1200	1 Add 1 per 1200	1 — 600 >600	1 Add 1 per 1200	1 — 600 >600	1 Add 1 per 1200
Female patrons	1 — 300 301 — 600 >600	1 2 Add 1 per 1200	N/A	N/A	1 — 600 601 — 1200 >1200	1 2 Add 1 per 1200
Note: Sanitary facilities need not be provided for patrons if the total number of persons accommodated in the building is not more than 600.						
Class 6 — restaurants, cafes, bars						
Male patrons	1 — 100 101 — 300 >300	1 2 Add 1 per 200	1 — 50 51 — 100 101 — 150 151 — 200 201 — 250 >250	1 2 3 4 5 Add 1 per 100	1 — 50 51 — 200 >200	1 2 Add 1 per 200
Female patrons	1 — 25 26 — 50 51 — 100 101 — 150	1 2 3 4	N/A	N/A	1 — 50 51 — 150 >150	1 2 Add 1 per 200

User Group	Closet Pans		Urinals		Washbasins	
	Design Occupancy	Number	Design Occupancy	Number	Design Occupancy	Number
	151 — 200	5				
	201 — 250	6				
	>250	Add 1 per 100				
Note: Sanitary facilities need not be provided for patrons if the total number of persons accommodated in the building is not more than 20.						
Class 9a — health-care buildings						
Male patients	1 — 16	2			1 — 8	1
	>16	Add 1 per 8			> 8	Add 1 per 8
Female patients	1 — 16	2	N/A	N/A	1 — 8	1
	>16	Add 1 per 8			> 8	Add 1 per 8
Class 9b — schools						
Male employees	1 — 20	1	1 — 10	0	1 — 30	1
	> 20	Add 1 per 20	11 — 20	1	> 30	Add 1 per 30
			21 — 45	2		
			>45	Add 1 per 30		
Female employees	1 — 5	1	N/A	N/A	1 — 30	1
	>5	Add 1 per 15			> 30	Add 1 per 30
Male students	1 — 25	1	1 — 50	1	1 — 10	1
	26 — 75	2	51 — 100	2	11 — 50	2
	76 — 150	3	>100	Add 1 per 100	51 — 100	3
	151 — 200	4			> 100	Add 1 per 75
	> 200	Add 1 per 100				
Female students	1 — 10	1	N/A	N/A	1 — 10	1
	11 — 25	2			11 — 50	2
	26 — 100	Add 1 per 25			51 — 100	3
	> 100	Add 1 per 50			> 100	Add 1 per 75
Class 9b — early childhood centres						
Children	1 — 30	2	N/A	N/A	1 — 30	2
	> 30	Add 1 per 15			> 30	Add 1 per 15
Note: Facilities for use by children must be—						
(a) junior pans; and						
(b) washbasins with a rim height not exceeding 600mm; and						
(c) accessible from both indoor and outdoor play areas.						
Class 9b — theatres and cinemas with multiple auditoria, art galleries or the like						
Male participants	1 — 20	1	1 — 10	1	1 — 10	1

User Group	Closet Pans		Urinals		Washbasins	
	Design Occupancy	Number	Design Occupancy	Number	Design Occupancy	Number
	> 20	Add 1 per 20	> 10	Add 1 per 10	> 10	Add 1 per 10
Female participants	1 — 10	1	N/A	N/A	1 — 10	1
	> 10	Add 1 per 10			> 10	Add 1 per 10
Male spectators or patrons	1 — 250	1	1 — 100	1	1 — 150	1
	251 — 500	2	>100	Add 1 per 100	>150	Add 1 per 150
	>500	Add 1 per 500				
Female spectators or patrons	1 — 10	1	N/A	N/A	1 — 80	1
	11 — 50	2			81 — 250	2
	>51	Add 1 per 60			251 — 430	3
				> 430	Add 1 per 200	
Class 9b —single auditorium theatres and cinemas						
Male patrons	1 — 50	0	1 — 50	0	1 — 50	0
	51 — 250	1	51 — 100	1	51 — 150	1
	251 — 500	2	>100	Add 1 per 100	>150	Add 1 per 150
	>500	Add 1 per 500				
Female patrons	1 — 50	0	N/A	N/A	1 — 50	0
	51 — 110	3			51 — 150	1
	111 — 170	4			>150	Add 1 per 150
	171 — 230	5				
	231 — 250	6				
	>250	Add 1 per 80				
Class 9b — sports venues or the like						
Male participants	1 — 20	1	1 — 10	1	1 — 10	1
	> 20	Add 1 per 20	> 10	Add 1 per 10	> 10	Add 1 per 10
Female participants	1 — 10	1	N/A	N/A	1 — 10	1
	> 10	Add 1 per 10			> 10	Add 1 per 10
Male spectators or patrons	1 — 250	1	1 — 100	1	1 — 150	1
	251 — 500	2	> 100	Add 1 per 100	> 150	Add 1 per 150
	> 500	Add 1 per 500				
Female spectators or patrons	1 — 15	1	N/A	N/A	1 — 60	1
	16 — 60	2			61 — 200	2
	61 — 120	3			201 — 350	3
	> 120	Add 1 per 70			> 350	Add 1 per 150
Class 9b — churches, chapels or the like						

User Group	Closet Pans		Urinals		Washbasins	
	Design Occupancy	Number	Design Occupancy	Number	Design Occupancy	Number
Male patrons	1 — 300 >300	1 Add 1 per 500	1 — 200 > 200	1 Add 1 per 200	1 — 250 > 250	1 Add 1 per 250
Female patrons	1 — 150 > 150	1 Add 1 per 150	N/A	N/A	1 — 250 > 250	1 Add 1 per 250`
Class 9b — public halls, function rooms or the like						
Male patrons	1 — 100 >100	1 Add 1 per 200	1 — 50 51 — 100 101 — 150 151 — 200 201 — 250 >250	1 2 3 4 5 Add 1 per 100	1 — 50 51 — 200 >200	1 2 Add 1 per 200
Female patrons	1 — 25 26 — 50 51 — 100 101 — 150 151 — 200 201 — 250 >250	1 2 3 4 5 6 Add 1 per 100	N/A	N/A	1 — 50 51 — 150 >150	1 2 Add 1 per 200

Note: Sanitary facilities need not be provided for patrons if the total number of persons accommodated in the building is not more than 20.

- Notes:**
1. Number — means the number of facilities *required*.
 2. > — means greater than
 3. Employees — a reference to employees includes owners and managers using the building.
 4. A reference to “add 1 per 100 or 150, 250, 500” etc. includes any part of that number.

F2.4 Accessible sanitary facilities

In a building *required* to be *accessible*—

SA F2.4(a)

- (a) *accessible* unisex *sanitary compartments* must be provided in *accessible* parts of the building in accordance with Table F2.4(a); and

SA F2.4(b)

- (b) *accessible* unisex showers must be provided in accordance with Table 2.4(b); and
- (c) at each bank of toilets where there is one or more toilets in addition to an *accessible* unisex *sanitary compartment* at that bank of toilets, a *sanitary compartment* suitable for a person with an ambulant disability in accordance with AS 1428. 1 must be provided for use by males and females; and
- (d) an *accessible* unisex *sanitary compartment* must contain a closet pan, washbasin, shelf or bench top and adequate means of disposal of sanitary products; and
- (e) the circulation spaces, fixtures and fittings of all *accessible* sanitary facilities provided in accordance with Table F2.4(a) and Table F2.4(b) must comply with the requirements of AS 1428. 1; and
- (f) an *accessible* unisex sanitary facility must be located so that it can be entered without crossing an area reserved for one sex only; and
- (g) where two or more of each type of *accessible* unisex sanitary facility are provided, the number of left and right handed mirror image facilities must be provided as evenly as possible; and
- (h) where male sanitary facilities are provided at a separate location to female sanitary facilities, *accessible* unisex sanitary facilities are only *required* at one of those locations; and
- (i) an *accessible* unisex *sanitary compartment* or an *accessible* unisex shower need not be provided on a *storey* or level that is not *required* by D3.3(f) to be provided with a passenger lift or ramp complying with AS 1428. 1.

Table F2.4(a) Accessible unisex sanitary compartments

Class of building	Minimum accessible unisex sanitary compartments to be provided
Class 1b	(a) Not less than 1; and (b) where private <i>accessible</i> unisex <i>sanitary compartments</i> are provided for every <i>accessible</i> bedroom, common <i>accessible</i> unisex <i>sanitary compartments</i> need not be provided.
Class 2	Where <i>sanitary compartments</i> are provided in common areas, not less than 1.
Class 3 and Class 9c	(a) In every <i>accessible sole-occupancy unit</i> provided with <i>sanitary compartments</i> within the <i>accessible sole-occupancy unit</i> , not less than 1; and (b) at each bank of <i>sanitary compartments</i> containing male and female <i>sanitary compartments</i> provided in common areas, not less than 1.
Class 5, 6, 7, 8 or 9 — except for within a <i>ward area</i> of a Class 9a <i>health-care building</i>	Where F2.3 requires closet pans— (a) 1 on every <i>storey</i> containing <i>sanitary compartments</i> ; and (b) where a <i>storey</i> has more than 1 bank of <i>sanitary compartments</i> containing male and female <i>sanitary compartments</i> , at not less than 50% of those banks.
Class 10a except— (a) a Class 10a appurtenant to another Class of building; and (b) a <i>sanitary compartment</i> dedicated to a single caravan/camping site	At each bank of <i>sanitary compartments</i> containing male and female <i>sanitary compartments</i> , not less than 1.

SA Table F2.4(a)(i)

Table F2.4(b) Accessible unisex showers

Class of building	Minimum accessible unisex showers to be provided
Class 1b	(a) Not less than 1; and (b) where private <i>accessible</i> unisex showers are provided for every <i>accessible</i> bedroom, common <i>accessible</i> unisex showers need not be provided.
Class 2	Where showers are provided in common areas, not less than 1.
Class 3 and Class 9c	(a) In every <i>accessible sole-occupancy unit</i> provided with showers within the <i>accessible sole-occupancy unit</i> , not less than 1; and (b) 1 for every 10 showers or part thereof provided in common areas.
Class 5, 6, 7, 8 or 9 — except for within a <i>ward area</i> of a Class 9a <i>health-care building</i>	Where F2.3 requires 1 or more showers, not less than 1 for every 10 showers or part thereof.
Class 10a except— (a) a Class 10a appurtenant to another Class of building; and (b) a <i>sanitary compartment</i> dedicated to a single caravan/camping site	Where showers are provided, 1 for every 10 showers or part thereof.

SA Table F2.4(b)(i)

F2.5 Construction of sanitary compartments

- (a) Other than in an *early childhood centre*, *sanitary compartments* must have doors and partitions that separate adjacent compartments and extend—
- (i) from floor level to the ceiling in the case of a unisex facility; or
 - (ii) to a height of not less than 1.5 m above the floor if primary *school* children are the principal users; or
 - (iii) 1.8 m above the floor in all other cases.
- (b) The door to a fully enclosed *sanitary compartment* must—
- (i) open outwards; or
 - (ii) slide; or
 - (iii) be readily removable from the outside of the *sanitary compartment*, unless there is a clear space of at least 1.2 m, measured in accordance with Figure F2.5, between the closet pan within the *sanitary compartment* and the doorway.
- Vic F2.5(c)*
- (c) In an *early childhood centre*, facilities for use by children must have each *sanitary compartment* screened by a partition which, except for the doorway, is opaque for a height of at least 900 mm but not more than 1200 mm above the floor level.

Figure F2.5 Construction of sanitary compartments

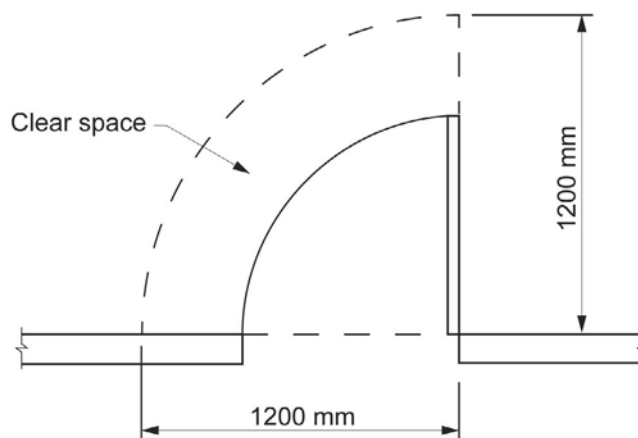

F2.6 Interpretation: Urinals and washbasins

- (a) A urinal may be—
- (i) an individual stall or wall-hung urinal; or
 - (ii) each 600 mm length of a continuous urinal trough; or
 - (iii) a closet pan used in place of a urinal.
- (b) A washbasin may be—
- (i) an individual basin; or
 - (ii) a part of a hand washing trough served by a single water tap.

F2.7 Microbial (legionella) control

NSW F2.7

Hot water, warm water and cooling water systems in a building other than a system serving only a single *sole-occupancy unit* in a Class 2 or 3 building or Class 4 part of a building must be installed in accordance with AS/NZS 3666.1.

F2.8 Waste management

- (a) In a Class 9a *health-care building*, at least one slop-hopper or other device, other than a water closet pan or urinal, must be provided—
- (i) on any *storey* containing *ward areas* or bedrooms to facilitate emptying of containers of sewage or dirty water; and
 - (ii) with a flushing apparatus, tap and grating.
- (b) In a Class 9c building, the following facilities must be provided for every 60 beds or part thereof on each storey containing *resident use areas*—
- (i) one slop-hopper or other device other than a water closet pan or urinal for the safe handling and disposal of liquid and solid wastes with a flushing apparatus, tap and grating; and
 - (ii) an appliance for the disinfection of pans or an adequate means to dispose of receptacles.

Tas F2.101, F2.102

Vic F2.101

Explanatory information: Cross-volume considerations

NCC Volume Three contains a number of plumbing and drainage provisions which are relevant to facilities. These include, but may not be limited to, the following:

Access for maintenance of plumbing and drainage	Parts B1, B2, B3, C1 and C2
Heated water temperature control for facilities used for personal hygiene	Part B2

F2.9 Accessible adult change facilities

- (a) *Accessible* adult change facilities *required* by (b)—
- (i) must be constructed in accordance with [Specification F2.9](#); and
 - (ii) cannot be combined with another *sanitary compartment*.
- (b) One unisex *accessible* adult change facility must be provided in an *accessible* part of a—
- (i) Class 6 building that is a shopping centre having a design occupancy of not less than 3,500 people, calculated on the basis of the *floor area* and containing a minimum of 2 *sole-occupancy units*; and
 - (ii) Class 9b sports venue or the like that—
 - (A) has a design occupancy of not less than 35,000 spectators; or
 - (B) contains a *swimming pool* that has a perimeter of not less than 70 m and that is *required* by [Table D3.1](#) to be *accessible*; and
 - (iii) museum, art gallery or the like having a design occupancy of not less than 1,500 patrons; and
 - (iv) theatre or the like having a design occupancy of not less than 1,500 patrons; and
 - (v) passenger use area of an airport terminal building within an airport that accepts domestic and/or international flights that are public transport services as defined in the Disability Standards for Accessible Public Transport 2002.
- (c) For the purposes of (b), design occupancy must be calculated in accordance with [D1.13](#), but excluding any area that—
- (i) can only be accessed by staff, employees, contractors, maintenance personnel and the like; or
 - (ii) is subject to an exemption under [D3.4](#).

Specification F2.9

Accessible adult change facilities

Deemed-to-Satisfy Provisions

1. Scope

This Specification contains the requirements for *accessible* adult change facilities.

2. General requirements

- (a) Each *accessible* adult change facility must—
 - (i) be constructed so that all *required* equipment and fixtures are contained within the same room; and
 - (ii) if it is a unisex facility, be located such that it can be entered without crossing an area reserved for one sex only.
- (b) In each *accessible* adult change facility, the following must be provided:
 - (i) A hoist complying with [Clause 3](#).
 - (ii) A toilet pan, seat, backrest and grabrails complying with [Clause 4](#).
 - (iii) A washbasin and tap complying with [Clause 5](#).
 - (iv) Fixtures and fittings as specified in [Clause 6](#).
 - (v) A change table complying with [Clause 7](#).
 - (vi) Changing rails complying with [Clause 8](#).
 - (vii) An automated sliding entrance door complying with [Clause 9](#).
 - (viii) Signage complying with [Clause 10](#).
 - (ix) Operating instructions for the hoist and change table in accordance with [Clause 11](#).
 - (x) Circulation spaces complying with [Figure 2](#).

Health and amenity

Deemed-to-Satisfy Provisions

Figure 2 Required circulation spaces

Diagram a. Turning space, each side of the pan and in front of the pan

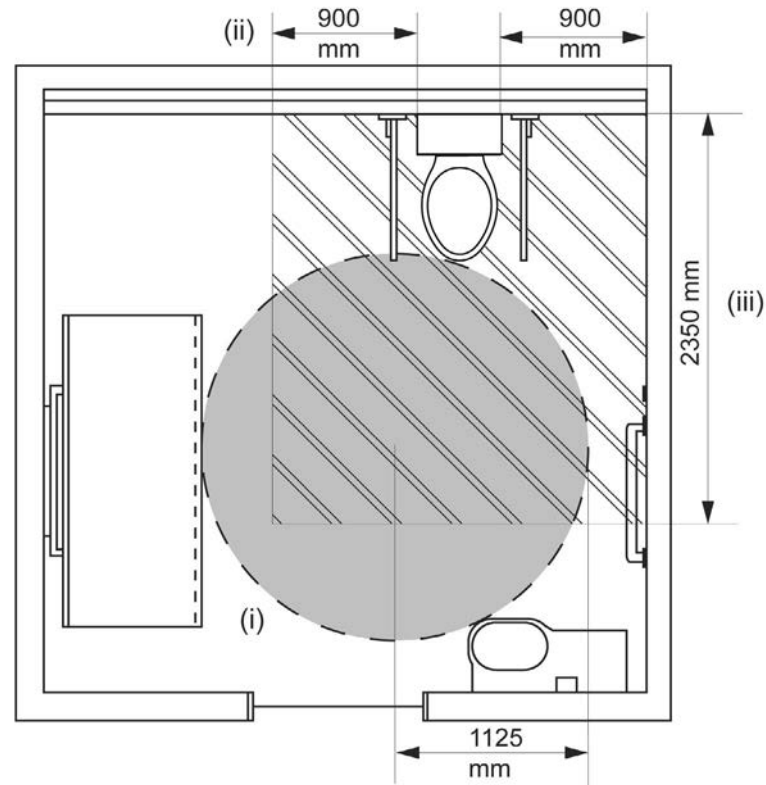

Health and amenity

Deemed-to-Satisfy Provisions

Diagram b. Turning space and circulation space for a washbasin

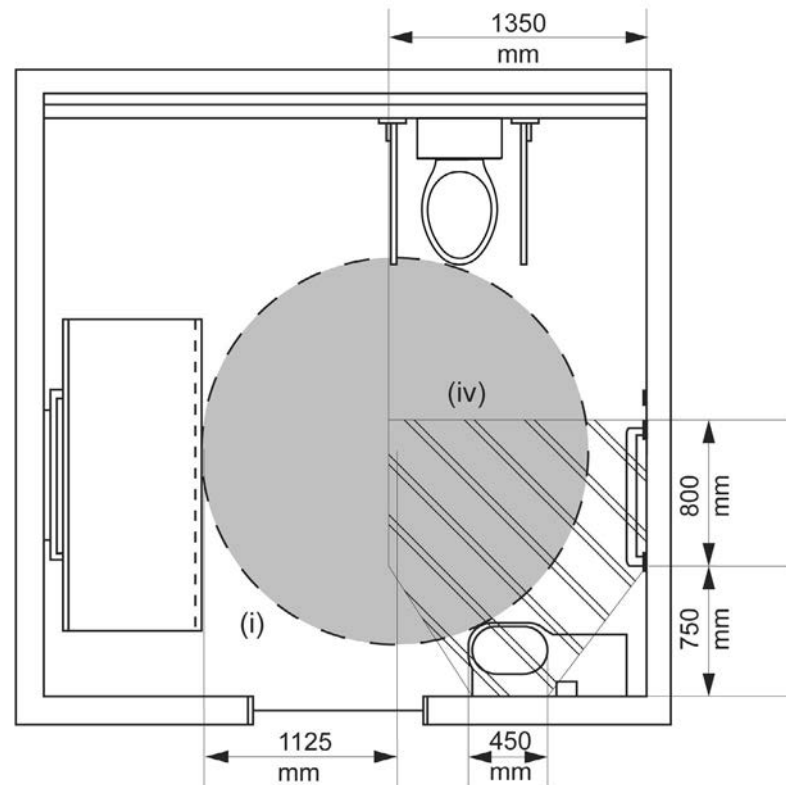
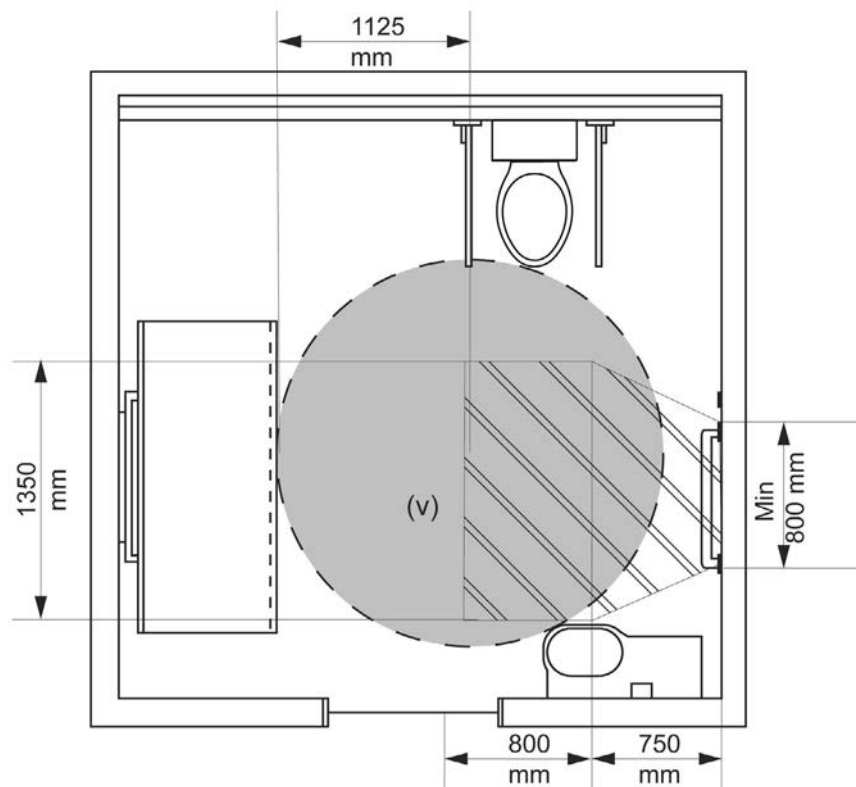

Diagram c. Turning space and circulation space for changing rails



Deemed-to-Satisfy Provisions

Notes to Figure 2:

- (a) The Roman numerals shown in Figure 2 indicate the following *required* circulation spaces:
 - (i) Turning space: a full circle of 1125 mm radius.
 - (ii) Each side of the pan: 900 mm (measured from each edge of the pan).
 - (iii) In front of the pan: 2350 mm (measured from the wall behind the pan, and therefore includes the pan itself).
 - (iv) For a washbasin: the width of the basin (450 mm) increasing to a width of 1350 mm measured at a distance of 750 mm out from the wall against which the washbasin is mounted then continuing at that width for a further 800 mm (to a total of 1550 mm out from the wall).
 - (v) For changing rails: the width of the rails increasing to a width of 1350 mm at a distance of 750 mm out from the wall to which the rails are fixed then continuing at that width for a further 800 mm (to a total of 1550 mm out from the wall).
- (b) All *required* circulation spaces must extend for a minimum height of 2000 mm above finished floor level.
- (c) *Required* circulation spaces may be overlapped.
- (c) The floor surface must have a slip resistance classification of not less than R10 or P3 when tested in accordance with AS 4586.

3. Hoist

The hoist must—

- (a) provide a constant charge in-line room coverage hoist system (also known as an "XY" system or gantry) including 2 parallel fixed rails and a moving traverse rail; and
- (b) provide coverage over the entire room; and
- (c) have a maximum safe working load of not less than 180 kg; and
- (d) be capable of sustaining a static load of not less than 1.5 times the rated load; and
- (e) have a minimum lifting height of 2100 mm.

4. Toilet pan, seat, backrest and grabrails

- (a) The toilet pan must be of the centrally located ("peninsula-type") design.
- (b) The toilet pan must be installed so that—
 - (i) the front edge of the pan is 800 mm (\pm 10 mm) from the rear wall; and
 - (ii) the top of the seat is between 460 mm and 480 mm above finished floor level; and
 - (iii) there is a minimum clearance of 900 mm, measured horizontally, between each side of the pan and any adjacent wall or privacy screen.
- (c) The toilet seat must—
 - (i) be of the full-round type (not open-fronted) with minimal contours to the top surface; and
 - (ii) be securely fixed in position when in use; and
 - (iii) have seat fixings that provide lateral stability to the seat when the seat is in use; and
 - (iv) be load-rated to 150 kg; and
 - (v) have a minimum *luminance contrast* of 30% against the pan, wall or floor; and
 - (vi) remain in the fully upright position when raised.
- (d) Hand-operated flushing controls must—
 - (i) be located on the centreline of the toilet, at a height of—
 - (A) not less than 600 mm; and
 - (B) not more than 1100 mm, above finished floor level; and

Health and amenity

Deemed-to-Satisfy Provisions

- (ii) not be located within the area *required* for any grabrails or backrest; and
- (iii) have the button mounted so that it is proud of the wall surface, and activates the flushing operation before the button becomes level with the surrounding surface.
- (e) An automatically activated flushing system need not comply with the requirements of (d).
- (f) The backrest must—
 - (i) be capable of withstanding a force, in any direction, of not less than 1100 N; and
 - (ii) have a minimum height, between the lower edge of the backrest and the top of the seat, of between 120 mm and 150 mm; and
 - (iii) have a vertical height, between the upper and lower edges of the backrest, of between 150 mm and 200 mm; and
 - (iv) have a width of between 350 mm and 400 mm; and
 - (v) be positioned such that the face of the backrest achieves an angle of between 95° and 100° back from the seat, when the seat is in use.
- (g) Grabrails must be installed adjacent to each side of the pan and must be—
 - (i) of the drop-down type; and
 - (ii) located such that—
 - (A) the top of each rail is between 800 mm and 810 mm above finished floor level; and
 - (B) the rails are between 750 mm and 770 mm apart, measured centre-to-centre, and equidistant to the centreline of the pan; and
 - (iii) at least 850 mm long; and
 - (iv) with a diameter of between 30 mm and 40 mm; and
 - (v) securely fixed to withstand a force, in any direction, of not less than 1100 N; and
 - (vi) provided with a toilet paper dispenser on one side; and
 - (vii) capable of being lifted up or swung away when not in use, so as to allow unimpeded access to the toilet pan.

5. Washbasin and tap

- (a) The washbasin must be installed so that the rim of the basin is between 800 mm and 830 mm above finished floor level.
- (b) Exposed *heated water* supply pipes must be insulated or located so as not to pose a hazard.
- (c) Water supply or sanitary *drainage* pipes must not encroach on the space under the basin.
- (d) The washbasin must have an integrated shelf not less than 300 mm long.
- (e) Water taps must have a single lever flick-mixer handle or a sensor plate or the like.
- (f) Where lever handles are provided, they must be installed with a clear space of not less than 50 mm between the tap and any adjacent surface.
- (g) *Heated water* must be provided and temperature controlled in accordance with [Part B2](#) of NCC Volume Three.

6. Fixtures and fittings

- (a) **Mirror:**
 - (i) A vertical mirror must be provided at the washbasin, with a reflective surface that—
 - (A) is not less than 600 mm wide; and
 - (B) has its bottom edge not more than 900 mm above finished floor level; and
 - (C) has its top edge not less than 1850 mm above finished floor level.

Health and amenity

Deemed-to-Satisfy Provisions

- (ii) If a second vertical mirror is provided in the facility, it must have a reflective surface that—
 - (A) is not less than 600 mm wide; and
 - (B) has its bottom edge not less than 600 mm above finished floor level; and
 - (C) has its top edge not less than 1850 mm above finished floor level.
- (b) **Towel dispensers, hand dryers and the like:**
Towel dispensers, hand dryers, soap dispensers and the like must be operable using one hand, and must be installed with their output or operative components—
 - (i) between 900 mm and 1100 mm above finished floor level; and
 - (ii) not less than 500 mm from any internal corner.
- (c) **Soap dispenser:**
A soap dispenser must be installed above the integrated shelf *required* by [Clause 5\(d\)](#).
- (d) **Clothing hook:**
A clothing hook must be installed so that it is located—
 - (i) at a height of between 1200 mm and 1350 mm above finished floor level; and
 - (ii) adjacent to the washbasin; and
 - (iii) not less than 500 mm from any internal corner.
- (e) **Sling hook:**
A sling hook with a minimum projection of 50 mm from the wall must be installed beside the change table at a height of 1500 mm above finished floor level.

Explanatory information:

The purpose of the sling hook is to store the sling when it is not in use.

- (f) **Disposal bins:**
 - (i) A sanitary disposal bin must be provided in the corner adjacent to the toilet pan.
 - (ii) An incontinence pad disposal bin must be provided in the corner adjacent to the change table.

7. Change table

- (a) The change table must be—
 - (i) permanently installed, with one of the long edges up against a wall and with a retractable safety rail on the opposite side; and
 - (ii) motorised for the purposes of height adjustment; and
 - (iii) height adjustable between 450 mm and 900 mm above finished floor level; and
 - (iv) not less than 700 mm wide; and
 - (v) not less than 1800 mm long.
- (b) The change table must have a maximum safe working load of not less than 180 kg, including when raising or lowering the table.
- (c) The change table must not encroach on any *required* circulation space.
- (d) A dispenser for sanitary wipes must be provided.
- (e) A shelf not less than 400 mm long and 150 mm wide must be provided.

8. Changing rails

Changing rails must be installed as two horizontal and parallel rails fixed to a wall, not less than 800 mm long, each with a diameter between 30 and 40 mm, and—

- (a) the lower rail must be installed between 800 mm and 810 mm above finished floor level; and

Deemed-to-Satisfy Provisions

- (b) the upper rail must be installed between 1000 mm and 1010 mm above finished floor level; and
- (c) the rails must be able to withstand a force of not less than 1100 N in any direction.

9. Door and door controls

The entrance door and associated door controls must be automated and must comply with the following:

- (a) The threshold must incorporate a smooth transition without a step or lip.
- (b) The minimum clear opening width must be—
 - (i) 1100 mm in locations where beach wheelchairs are likely to be used; or
 - (ii) 950 mm in all other locations.
- (c) The doorway must achieve a *luminance contrast* of at least 30% between—
 - (i) Door leaf and door jamb; or
 - (ii) Door leaf and adjacent wall; or
 - (iii) Architraves (where used) and adjacent wall; or
 - (iv) Door leaf and architrave (where used); or
 - (v) Door jamb and adjacent wall.
- (d) The operation of the door must be calibrated such that—
 - (i) it has a gentle opening and closing movement; and
 - (ii) there is sufficient dwell time for a user to safely travel through the doorway.
- (e) The door must be fitted with a fail-safe opening mechanism that opens the door if an obstruction is detected during its closing movement.
- (f) Door controls must be located internally and externally—
 - (i) between 900 mm and 1200 mm above finished floor level; and
 - (ii) not less than 500 mm from any internal corner.
- (g) Door control buttons must—
 - (i) have a minimum diameter of 25 mm; and
 - (ii) be proud of the surrounding surface; and
 - (iii) activate the door operation before the button becomes level with the surrounding surface; and
 - (iv) be of a contrasting colour to the surrounding plate.
- (h) The surrounding plates of both internal and external door controls must include the words “Push to Open”.
- (i) The following indicator lights must be provided:
 - (i) “Occupied” and “Vacant” on the external plate.
 - (ii) “Locked” and “Unlocked” on the internal plate.
- (j) Braille and tactile signage complying with [Specification D3.6](#) must identify the door controls.

10. Signage

- (a) External signage must incorporate—
 - (i) the symbol shown in [Figure 10](#); and
 - (ii) the words “Accessible Adult Change Facility”.
- (b) The symbol *required* by (a)(i) must have a blue (B21, ultramarine) background with the hoist and table elements shown in white.
- (c) Signage must be braille and tactile signage complying with [Specification D3.6](#).

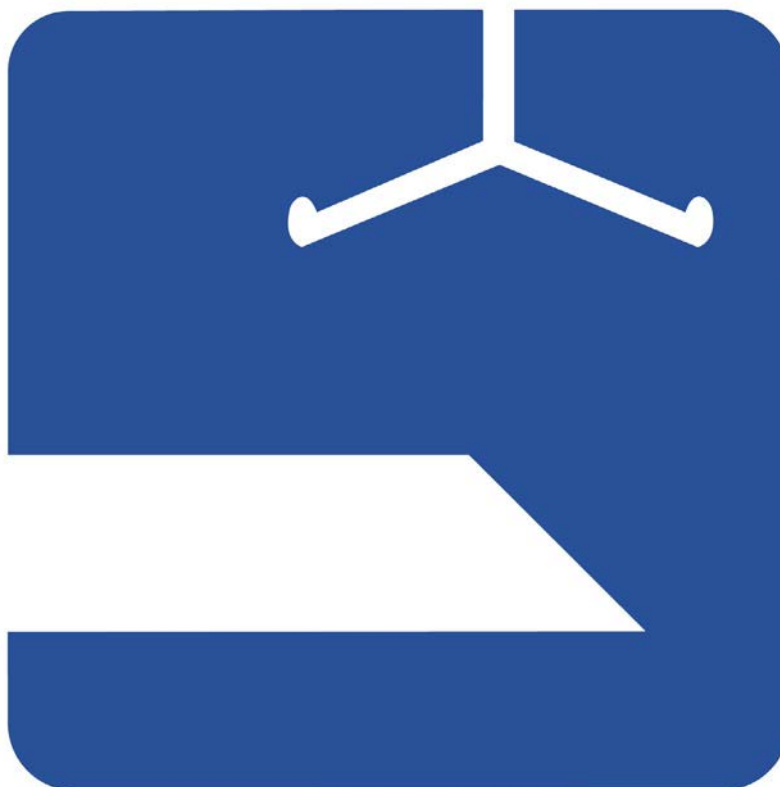
Figure 10 Symbol**11. Operating instructions**

Signage provided within the facility must include the following information for the hoist and change table:

- (a) Operating instructions.
- (b) Safe working load limits.

Part F3 Room heights

Performance Requirements

FP3.1 Room or space heights

Vic FP3.1

A *habitable room* or space must have sufficient height that does not unduly interfere with its intended function.

Verification Methods

FV3.1 Room or space heights

(a) Compliance with [FP3.1](#) is verified where the height of a *habitable room* or space provides an appropriate *activity support level* that does not unduly interfere with its intended function.

Vic FV3.1(a)

(b) For the purposes of (a), the *activity support level* must consider the dimensions of—

- (i) doors, *required exits*, ramps, barriers, stairs and *windows*; and
- (ii) fixed fittings and services; and
- (iii) fixed and moveable equipment or furniture; and
- (iv) occupant circulation spaces.

Part F3 Room heights

Deemed-to-Satisfy Provisions

F3.0 Deemed-to-Satisfy Provisions

Vic F3.0

- (a) Where a *Deemed-to-Satisfy Solution* is proposed, *Performance Requirement FP3.1* is satisfied by complying with—
 - (i) **F3.1**; and
 - (ii) for *farm sheds*, **Part H3**.
- (b) Where a *Performance Solution* is proposed, the relevant *Performance Requirements* must be determined in accordance with **A2.2(3)** and **A2.4(3)** as applicable.

F3.1 Height of rooms and other spaces

The height of rooms and other spaces must be not less than—

- (a) in a Class 2 or 3 building or Class 4 part of a building—
 - (i) a kitchen, laundry, or the like — 2.1 m; and
 - (ii) a corridor, passageway or the like — 2.1 m; and
 - (iii) a *habitable room* excluding a kitchen — 2.4 m; and
 - (iv) in a room or space with a sloping ceiling or projections below the ceiling line within—
 - (A) a *habitable room*—
 - (aa) in an attic — a height of not less than 2.2 m for not less than two-thirds of the *floor area* of the room or space; and
 - (bb) in other rooms — a height of not less than 2.4 m for not less than two-thirds of the *floor area* of the room or space; and
 - (B) a non-*habitable room* — a height of not less than 2.1 m for not less than two-thirds of the *floor area* of the room or space; and

when calculating the *floor area* of a room or space, any part that has a ceiling height of less than 1.5 m is not included; and
- (b) in a Class 5, 6, 7 or 8 building—
 - (i) except as allowed in (ii) and (f) — 2.4 m; and
 - (ii) a corridor, passageway, or the like — 2.1 m; and
- (c) in a Class 9a *health-care building*—
 - (i) a *patient care area* — 2.4 m; and
 - (ii) an operating theatre or delivery room — 3 m; and
 - (iii) a treatment room, clinic, waiting room, passageway, corridor, or the like — 2.4 m; and
- (d) in a Class 9b building—
 - (i) a *school* classroom or other *assembly building* or part that accommodates not more than 100 persons — 2.4 m; and
 - (ii) a theatre, public hall or other *assembly building* or part that accommodates more than 100 persons — 2.7 m; and
 - (iii) a corridor—
 - (A) that serves an *assembly building* or part that accommodates not more than 100 persons — 2.4 m; or
 - (B) that serves an *assembly building* or part that accommodates more than 100 persons — 2.7 m; and

Health and amenity

Deemed-to-Satisfy Provisions

- (iv) the number of persons accommodated must be calculated according to [D1.13](#); and
- (e) in a Class 9c building—
 - (i) a kitchen, laundry, or the like — 2.1 m; and
 - (ii) a corridor, passageway or the like — 2.4 m; and
 - (iii) a *habitable room* excluding a kitchen — 2.4 m; and
- (f) in any building—
 - (i) a bathroom, shower room, *sanitary compartment*, other than an *accessible* adult change facility, airlock, tea preparation room, pantry, store room, garage, car parking area, or the like — 2.1 m; and
 - (ii) a commercial kitchen — 2.4 m; and
 - (iii) above a stairway, ramp, landing or the like — 2 m measured vertically above the nosing line of stairway treads or the floor surface of the ramp, landing or the like; and
 - (iv) a *required accessible* adult change facility — 2.4 m.

Vic F3.101 — F3.103

Part F4 Light and ventilation

Performance Requirements

FP4.1 Natural lighting

Sufficient openings must be provided and distributed in a building, appropriate to the function or use of that part of the building so that natural light, when available, provides an *average daylight factor* of not less than 2%.

Application:

FP4.1 only applies to a Class 2, 3 or 9 building, or a Class 4 part of a building.

FP4.2 Artificial lighting

Artificial lighting must be installed to provide an *illuminance* of not less than 20 lux appropriate to the function or use of the building to enable safe movement by occupants.

FP4.3 Outdoor air supply

A space in a building used by occupants must be provided with means of ventilation with *outdoor air* which will maintain adequate air quality.

FP4.4 Mechanical ventilation to control odours and contaminants

A mechanical air-handling system installed in a building must control—

- (a) the circulation of objectionable odours; and
- (b) the accumulation of harmful contamination by micro-organisms, pathogens and toxins.

FP4.5 Disposal of contaminated air

Contaminated air must be disposed of in a manner which does not unduly create a nuisance or hazard to people in the building or *other property*.

Verification Methods

FV4.1 Verification of suitable indoor air quality

For a Class 2, 3, 5, 6, 9b or 9c building or Class 4 part of a building, compliance with FP4.3 and FP4.4(a) is verified when it is determined that the building under typical conditions in use is provided with sufficient ventilation with *outdoor air* such that contaminant levels do not exceed the limits specified in Table FV4.1.

Table FV4.1 Maximum contaminant limits for acceptable indoor air quality

Pollutant	Averaging time	Maximum air quality value
Carbon dioxide, CO ₂	8 hours	850 ppm ^{Note 1}
Carbon monoxide, CO	15 minutes	90 ppm
Carbon monoxide, CO	30 minutes	50 ppm
Carbon monoxide, CO	1 hour	25 ppm
Carbon monoxide, CO	8 hours	10 ppm
Formaldehyde, CH ₂ O	30 minutes	0.1 mg/m ³
Nitrogen dioxide, NO ₂	1 year	40 µg/m ³ (0.0197 ppm) ^{Note 2}
Nitrogen dioxide, NO ₂	1 hour	200 µg/m ³ (0.0987 ppm)
Ozone, O ₃	8 hour, daily maximum	100 µg/m ³ (0.0473 ppm)
Particulate matter, PM _{2.5}	1 year	10 µg/m ³
Particulate matter, PM _{2.5}	24 hour (99th percentile)	25 µg/m ³

Health and amenity

Pollutant	Averaging time	Maximum air quality value
Particulate matter, PM ₁₀	1 year	20 µg/m ³
Particulate matter, PM ₁₀	24 hour (99th percentile)	50 µg/m ³
Total volatile organic compounds	1 hour	500 µg/m ³

Notes to Table FV4.1:

- Based on body odour metric (i.e. 450 ppm above ambient CO₂ level of 400 ppm and demand control ventilation provisions in AS 1668.2).
- Based on pressure of 101.325 kPa and temperature of 25°C (i.e. the conversion is mg/m³ = ppm (molecular weight/24.4)).

FV4.2 Verification of suitable indoor air quality for carparks

For a Class 7a building, compliance with FP4.3 and FP4.4(a) is verified when it is determined that the building is provided with sufficient ventilation with *outdoor air* such that carbon monoxide exposure levels do not exceed the limits specified in Table FV4.2.

Table FV4.2 Maximum carbon monoxide exposure for carparks

Concentration (ppm)	Total exposure duration per day
100	Not to be exceeded
90	15 minutes
60	1 hour
30	8 hours

Note to Table FV4.2: Various government work, health and safety regulations specify workplace exposure limits for airborne contaminants in the workplace.

FV4.3 Verification of suitable provision of natural light

Compliance with FP4.1 is verified for the provision of natural light for—

- habitable rooms* of Class 2 buildings and Class 4 parts of buildings; and
- bedrooms and dormitories of Class 3 buildings; and
- rooms used for sleeping purposes in Class 9a and 9c buildings; and
- general purpose classrooms in primary and secondary *school* and playrooms or the like for the use of children in an *early childhood centre* in Class 9b buildings,

when the *average daylight factor* for each *window* is determined in accordance with the following formula:

$$\text{Average Daylight Factor} = \frac{W}{A} \frac{T\theta}{(1 - R^2)}$$

W = the net area of the light transmitting area of the *window* (m²); and

A = the total area of the internal wall, floor and ceiling surfaces (m²); and

T = the diffuse light transmittance of the *window*; and

θ = visible sky angle in degrees, measured in a vertical plane normal to and from the centre of the *window*, and

Health and amenity

R = the area-weighted average reflectance of area A.

Part F4 Light and ventilation

Deemed-to-Satisfy Provisions

F4.0 Deemed-to-Satisfy Provisions

- (a) Where a *Deemed-to-Satisfy Solution* is proposed, *Performance Requirements FP4.1* to *FP4.5* are satisfied by complying with—
- (i) *F4.1* to *F4.12*; and
 - (ii) for a building containing an *occupiable outdoor area*, *Part G6*; and
 - (iii) for *farm buildings* and *farm sheds*, *Part H3*.
- (b) Where a *Performance Solution* is proposed, the relevant *Performance Requirements* must be determined in accordance with *A2.2(3)* and *A2.4(3)* as applicable.

F4.1 Provision of natural light

Natural light must be provided in:

- (a) **Class 2 buildings and Class 4 parts of buildings** — to all *habitable rooms*.
- (b) **Class 3 buildings** — to all bedrooms and dormitories.
- (c) **Class 9a and 9c buildings** — to all rooms used for sleeping purposes.

Vic F4.1(d)

- (d) **Class 9b buildings** — to all general purpose classrooms in primary or secondary *schools* and all playrooms or the like for the use of children in an *early childhood centre*.

F4.2 Methods and extent of natural light

- (a) *Required* natural light must be provided by—
- (i) *windows*, excluding *roof lights*, that—
 - (A) have an aggregate light transmitting area measured exclusive of framing members, glazing bars or other obstructions of not less than 10% of the *floor area* of the room; and
 - (B) are open to the sky or face a court or other space open to the sky or an open verandah, carport or the like; or
 - (ii) *roof lights*, that—
 - (A) have an aggregate light transmitting area measured exclusive of framing members, glazing bars or other obstructions of not less than 3% of the *floor area* of the room; and
 - (B) are open to the sky; or
 - (iii) a proportional combination of *windows* and *roof lights required* by (i) and (ii).

Vic F4.2(b)

- (b) Except in a Class 9c *aged care building*, in a Class 2, 3 or 9 building or Class 4 part of a building a *required window* that faces a boundary of an adjoining allotment or a wall of the same building or another building on the allotment must not be less than a horizontal distance from that boundary or wall that is the greater of—
- (i) generally — 1 m; and
 - (ii) in a *patient care area* or other room used for sleeping purposes in a Class 9a building — 3 m; and
 - (iii) 50% of the square root of the exterior height of the wall in which the *window* is located, measured in metres from its sill.

Vic F4.2(c)

- (c) In a Class 9c *aged care building*, a *required window* must be transparent and located—
- (i) in an *external wall* with the *window* sill not more than 1 m above the floor level; and

Health and amenity

Deemed-to-Satisfy Provisions

- (ii) where the *window* faces an adjoining allotment, another building or another wall of the same building, it must not be less than a horizontal distance of 3 m from the adjoining allotment, other building or wall.

Vic F4.2(d)

- (d) In a Class 9b *early childhood centre*, the sills of 50% of *windows* in children's rooms must be located not more than 500 mm above the floor level.

F4.3 Natural light borrowed from adjoining room

- (a) Natural light to a room in a Class 2 building or Class 4 part of a building or in a *sole-occupancy unit* of a Class 3 building, may come through one or more glazed panels or openings from an adjoining room (including an enclosed verandah) if—
 - (i) both rooms are within the same *sole-occupancy unit* or the enclosed verandah is on common property; and
 - (ii) the glazed panels or openings have an aggregate light transmitting area of not less than 10% of the *floor area* of the room to which it provides light; and
 - (iii) the adjoining room has—
 - (A) *windows*, excluding *roof lights*, that—
 - (aa) have an aggregate light transmitting area of not less than 10% of the combined *floor areas* of both rooms; and
 - (bb) are open to the sky or face a court or other space open to the sky or an open verandah, carport or the like; or
 - (B) *roof lights*, that—
 - (aa) have an aggregate light transmitting area of not less than 3% of the combined *floor areas* of both rooms; and
 - (bb) are open to the sky; or
 - (C) a proportional combination of *windows* and *roof lights required* by (A) and (B).
- (b) The areas specified in (a)(ii) and (a)(iii) may be reduced as appropriate if direct natural light is provided from another source.

F4.4 Artificial lighting

- (a) Artificial lighting must be provided—
 - (i) in *required* stairways, passageways, and ramps; and
 - (ii) if natural light of a standard equivalent to that *required* by F4.2 is not available, and the periods of occupation or use of the room or space will create undue hazard to occupants seeking egress in an emergency, in—
 - (A) Class 4 parts of a building — to *sanitary compartments*, bathrooms, shower rooms, airlocks and laundries; and
 - (B) Class 2 buildings — to *sanitary compartments*, bathrooms, shower rooms, airlocks, laundries, common stairways and other spaces used in common by the occupants of the building; and
 - (C) Class 3, 5, 6, 7, 8 and 9 buildings — to all rooms that are frequently occupied, all spaces *required* to be *accessible*, all corridors, lobbies, internal stairways, other circulation spaces and paths of egress.
- (b) The artificial lighting system must comply with AS/NZS 1680.0.
- (c) The system may provide a lesser level of illumination to the following spaces during times when the level of lighting would be inappropriate for the use:
 - (i) A theatre, cinema or the like, when performances are in progress, with the exception of aisle lighting *required* by Part H1.
 - (ii) A museum, gallery or the like, where sensitive displays require low lighting levels.
 - (iii) A discotheque, nightclub or the like, where to create an ambience and character for the space, low lighting levels are used.

Health and amenity

Deemed-to-Satisfy Provisions

F4.5 Ventilation of rooms

A *habitable room*, office, shop, factory, workroom, *sanitary compartment*, bathroom, shower room, laundry and any other room occupied by a person for any purpose must have—

- (a) natural ventilation complying with F4.6; or
- (b) a mechanical ventilation or air-conditioning system complying with AS 1668.2 and AS/NZS 3666.1.
NSW F4.5(b)
SA F4.5(b) and (c)

F4.6 Natural ventilation

- (a) Natural ventilation provided in accordance with F4.5(a) must consist of openings, *windows*, doors or other devices which can be opened—
 - (i) with a ventilating area not less than 5% of the *floor area* of the room *required* to be ventilated; and
 - (ii) open to—
 - (A) a suitably sized court, or space open to the sky; or
 - (B) an open verandah, carport, or the like; or
 - (C) an adjoining room in accordance with F4.7.
- (b) The requirements of (a)(i) do not apply to a Class 8 *electricity network substation*.

F4.7 Ventilation borrowed from adjoining room

Natural ventilation to a room may come through a *window*, opening, door or other device from an adjoining room (including an enclosed verandah) if both rooms are within the same *sole-occupancy unit* or the enclosed verandah is common property, and—

- (a) in a Class 2 building, a *sole-occupancy unit* of a Class 3 building or Class 4 part of a building—
 - (i) the room to be ventilated is not a *sanitary compartment*; and
 - (ii) the *window*, opening, door or other device has a ventilating area of not less than 5% of the *floor area* of the room to be ventilated; and
 - (iii) the adjoining room has a *window*, opening, door or other device with a ventilating area of not less than 5% of the combined *floor areas* of both rooms; and
- (b) in a Class 5, 6, 7, 8 (except a Class 8 *electricity network substation*) or 9 building—
 - (i) the *window*, opening, door or other device has a ventilating area of not less than 10% of the *floor area* of the room to be ventilated, measured not more than 3.6 m above the floor; and
 - (ii) the adjoining room has a *window*, opening, door or other device with a ventilating area of not less than 10% of the combined *floor areas* of both rooms; and
- (c) the ventilating areas specified in (a) and (b) may be reduced as appropriate if direct natural ventilation is provided from another source.

F4.8 Restriction on location of sanitary compartments

Sanitary compartments must not open directly into—

- (a) a kitchen or pantry; or
- (b) a public dining room or restaurant; or
- (c) a dormitory in a Class 3 building; or
- (d) a room used for public assembly (which is not an *early childhood centre*, primary *school* or *open spectator stand*); or
- (e) a workplace normally occupied by more than one person.

Health and amenity

Deemed-to-Satisfy Provisions

F4.9 Airlocks

If a *sanitary compartment* is prohibited under F4.8 from opening directly to another room—

- (a) in a *sole-occupancy unit* in a Class 2 or 3 building or Class 4 part of a building—
 - (i) access must be by an airlock, hallway or other room; or
 - (ii) the *sanitary compartment* must be provided with mechanical exhaust ventilation; and
- (b) in a Class 5, 6, 7, 8 or 9 building (which is not an *early childhood centre*, primary *school* or *open spectator stand*)—
 - (i) access must be by an airlock, hallway or other room with a *floor area* of not less than 1.1 m² and fitted with *self-closing* doors at all access doorways; or
 - (ii) the *sanitary compartment* must be provided with mechanical exhaust ventilation and the doorway to the room adequately screened from view.

F4.10 * * * * *

This clause has deliberately been left blank.

F4.11 Carparks

Every *storey* of a *carpark*, except an *open-deck carpark*, must have—

- (a) a system of mechanical ventilation complying with AS 1668.2; or
- (b) a system of natural ventilation complying with Section 4 of AS 1668.4.

F4.12 Kitchen local exhaust ventilation

A commercial kitchen must be provided with a kitchen exhaust hood complying with AS 1668.1 and AS 1668.2 where—

- (a) any cooking apparatus has—
 - (i) a total maximum electrical power input exceeding 8 kW; or
 - (ii) a total gas power input exceeding 29 MJ/h; or
- (b) the total maximum power input to more than one apparatus exceeds—
 - (i) 0.5 kW electrical power; or
 - (ii) 1.8 MJ/hour gas,
per m² of *floor area* of the room or enclosure.

Part F5 Sound transmission and insulation

NT Part F5

Performance Requirements

FP5.1 Sound transmission through floors

Floors separating—

- (a) *sole-occupancy units*; or
- (b) a *sole-occupancy unit* from a plant room, lift *shaft*, stairway, *public corridor*, public lobby, or the like, or a part of a different classification, must provide insulation against the transmission of airborne and impact generated sound sufficient to prevent illness or loss of amenity to the occupants.

Application:

FP5.1 only applies to a Class 2 or 3 building.

FP5.2 Sound transmission through walls

Walls separating *sole-occupancy units* or a *sole-occupancy unit* from a plant room, lift *shaft*, stairway, *public corridor*, public lobby, or the like, or parts of a different classification, must provide insulation against the transmission of—

- (a) airborne sound; and
- (b) impact generated sound, if the wall is separating a bathroom, *sanitary compartment*, laundry or kitchen in one *sole-occupancy unit* from a *habitable room* (other than a kitchen) in an adjoining unit, sufficient to prevent illness or loss of amenity to the occupants.

Application:

FP5.2 only applies to a Class 2 or 3 building.

FP5.3 Sound transmission through floor and wall penetrations and door assemblies

The *required* sound insulation of a floor or a wall must not be compromised by—

- (a) the incorporation or penetration of a pipe or other service element; or
- (b) a door assembly.

Application:

FP5.3 only applies to a Class 2 or 3 building.

FP5.4 Sound transmission through floors in residential care buildings

Floors separating *sole-occupancy units* must provide insulation against the transmission of airborne and impact generated sound sufficient to prevent illness or loss of amenity to the occupants.

Application:

FP5.4 only applies to a Class 9c building.

FP5.5 Sound transmission through walls in residential care buildings

Walls separating *sole-occupancy units*, or a *sole-occupancy unit* from a kitchen, bathroom, *sanitary compartment* (not being an associated ensuite), laundry, plant room or utilities room, must provide insulation against the transmission of—

- (a) airborne sound; and
- (b) impact generated sound, if the wall separates a *sole-occupancy unit* from a kitchen or laundry, sufficient to prevent illness or loss of amenity to the occupants.

Application:

FP5.5 only applies to a Class 9c building.

FP5.6 Sound transmission through floor and wall penetrations in residential care buildings

The *required* sound insulation of a floor or a wall must not be compromised by the incorporation or penetration of a pipe or other service element.

Application:

FP5.6 only applies to a Class 9c building.

Verification Methods

FV5.1 Sound transmission through floors [FP5.1 and FP5.3]

Compliance with FP5.1 and FP5.3 to avoid the transmission of airborne and impact generated sound through floors is verified when it is measured in-situ that the separating floor has—

- airborne: a weighted standardised level difference with spectrum adaptation term ($D_{nT,w} + C_{tr}$) not less than 45 when determined under AS/NZS ISO 717.1; and
- impact: a weighted standardised impact sound pressure level ($L_{nT,w}$) not more than 62 when determined under AS ISO 717.2.

FV5.2 Sound transmission through walls [FP5.2(a) and FP5.3]

Compliance with FP5.2(a) and FP5.3 to avoid the transmission of airborne sound through walls is verified when it is measured in-situ that—

- a wall separating *sole-occupancy units* has a weighted standardised level difference with spectrum adaptation term ($D_{nT,w} + C_{tr}$) not less than 45 when determined under AS/NZS ISO 717.1; or
- a wall separating a *sole-occupancy unit* from a plant room, lift *shaft*, stairway, *public corridor*, public lobby, or the like, or parts of a different classification, has a weighted standardised level difference ($D_{nT,w}$) not less than 45 when determined under AS/NZS ISO 717.1; or
- any door assembly located in a wall that separates a *sole-occupancy unit* from a stairway, *public corridor*, public lobby, or the like, has a weighted standardised level difference ($D_{nT,w}$) not less than 25 when determined under AS/NZS ISO 717.1.

FV5.3 Sound transmission through floors [FP5.4 and FP5.6]

Compliance with FP5.4 and FP5.6 to avoid the transmission of airborne and impact generated sound through floors is verified when it is measured in-situ that the separating floor has—

- airborne: a weighted standardised level difference ($D_{nT,w}$) not less than 40 when determined under AS/NZS ISO 717.1; and
- impact: a weighted standardised impact sound pressure level ($L_{nT,w}$) not more than 62 when determined under AS ISO 717.2.

FV5.4 Sound transmission through walls [FP5.5(a) and FP5.6]

Compliance with FP5.5(a) and FP5.6 to avoid the transmission of airborne sound through walls is verified when it is measured in-situ that—

- a wall separating *sole-occupancy units* has a weighted standardised level difference ($D_{nT,w}$) not less than 40 when determined under AS/NZS ISO 717.1; or
- a wall separating a *sole-occupancy unit* from a kitchen, bathroom, sanitary compartment (not being an associated ensuite), laundry, plant room or utilities room has a weighted standardised level difference ($D_{nT,w}$) not less than 40 when determined under AS/NZS ISO 717.1.

Part F5 Sound transmission and insulation

Deemed-to-Satisfy Provisions

NT Part F5

F5.0 Deemed-to-Satisfy Provisions

- (a) Where a *Deemed-to-Satisfy Solution* is proposed, *Performance Requirements FP5.1* to *FP5.6* are satisfied by complying with *F5.1* to *F5.7*.
- (b) Where a *Performance Solution* is proposed, the relevant *Performance Requirements* must be determined in accordance with *A2.2(3)* and *A2.4(3)* as applicable.

F5.1 Application of Part

The *Deemed-to-Satisfy Provisions* of this Part apply to Class 2 and 3 buildings and Class 9c buildings.

F5.2 Determination of airborne sound insulation ratings

A form of construction *required* to have an airborne sound insulation rating must—

- (a) have the *required* value for weighted sound reduction index (R_w) or weighted sound reduction index with spectrum adaptation term ($R_w + C_{tr}$) determined in accordance with AS/NZS ISO 717.1 using results from laboratory measurements; or
- (b) comply with *Specification F5.2*.

F5.3 Determination of impact sound insulation ratings

(a) A floor in a building *required* to have an impact sound insulation rating must—

- (i) have the *required* value for weighted normalised impact sound pressure level ($L_{n,w}$) determined in accordance with AS ISO 717.2 using results from laboratory measurements; or
- (ii) comply with *Specification F5.2*.

(b) A wall in a building *required* to have an impact sound insulation rating must—

- (i) for a Class 2 or 3 building be of discontinuous construction; and
- (ii) for a Class 9c building, must—
 - (A) for other than masonry, be two or more separate leaves without rigid mechanical connection except at the periphery; or
 - (B) be identical with a prototype that is no less resistant to the transmission of impact sound when tested in accordance with *Specification F5.5* than a wall listed in *Table 2 of Specification F5.2*.

(c) For the purposes of this Part, discontinuous construction means a wall having a minimum 20 mm cavity between 2 separate leaves, and

- (i) for masonry, where wall ties are required to connect leaves, the ties are of the resilient type; and
- (ii) for other than masonry, there is no mechanical linkage between leaves except at the periphery.

F5.4 Sound insulation rating of floors

(a) A floor in a Class 2 or 3 building must have an $R_w + C_{tr}$ (airborne) not less than 50 and an $L_{n,w}$ (impact) not more than 62 if it separates—

- (i) *sole-occupancy units*; or
- (ii) a *sole-occupancy unit* from a plant room, lift *shaft*, stairway, *public corridor*, public lobby or the like, or parts of a different classification.

(b) A floor in a Class 9c building separating *sole-occupancy units* must have an R_w not less than 45.

Health and amenity

Deemed-to-Satisfy Provisions

F5.5 Sound insulation rating of walls

- (a) A wall in a Class 2 or 3 building must—
- (i) have an $R_w + C_{tr}$ (airborne) not less than 50, if it separates *sole-occupancy units*; and
 - (ii) have an R_w (airborne) not less than 50, if it separates a *sole-occupancy unit* from a plant room, lift *shaft*, stairway, *public corridor*, public lobby or the like, or parts of a different classification; and
 - (iii) comply with F5.3(b) if it separates—
 - (A) a bathroom, *sanitary compartment*, laundry or kitchen in one *sole-occupancy unit* from a *habitable room* (other than a kitchen) in an adjoining unit; or
 - (B) a *sole-occupancy unit* from a plant room or lift *shaft*.
- (b) A door may be incorporated in a wall in a Class 2 or 3 building that separates a *sole-occupancy unit* from a stairway, *public corridor*, public lobby or the like, provided the door assembly has an R_w not less than 30.
- (c) A wall in a Class 9c building must have an R_w not less than 45 if it separates—
- (i) *sole-occupancy units*; or
 - (ii) a *sole-occupancy unit* from a kitchen, bathroom, *sanitary compartment* (not being an associated ensuite), laundry, plant room or utilities room.
- (d) In addition to (c), a wall separating a *sole-occupancy unit* in a Class 9c building from a kitchen or laundry must comply with F5.3(b).
- (e) Where a wall *required* to have sound insulation has a floor above, the wall must continue to—
- (i) the underside of the floor above; or
 - (ii) a ceiling that provides the sound insulation *required* for the wall.
- (f) Where a wall *required* to have sound insulation has a roof above, the wall must continue to—
- (i) the underside of the roof above; or
 - (ii) a ceiling that provides the sound insulation *required* for the wall.

F5.6 Sound insulation rating of internal services

- (a) If a duct, soil, waste or water supply pipe, including a duct or pipe that is located in a wall or floor cavity, serves or passes through more than one *sole-occupancy unit*, the duct or pipe must be separated from the rooms of any *sole-occupancy unit* by construction with an $R_w + C_{tr}$ (airborne) not less than—
- (i) 40 if the adjacent room is a *habitable room* (other than a kitchen); or
 - (ii) 25 if the adjacent room is a kitchen or non-*habitable room*.
- (b) If a storm water pipe passes through a *sole-occupancy unit* it must be separated in accordance with (a)(i) and (ii).

F5.7 Sound isolation of pumps

A flexible coupling must be used at the point of connection between the service pipes in a building and any circulating or other pump.

Specification F5.2

Sound insulation for building elements

*Deemed-to-Satisfy Provisions***1. Scope**

- (a) This Specification lists the weighted sound reduction index R_w for some common forms of construction.
- (b) Wall systems listed in [Table 2](#) having a minimum 20 mm cavity between 2 separate leaves, with—
 - (i) for masonry, where wall ties are required to connect leaves, the ties are of the resilient type; and
 - (ii) for other than masonry, there is no mechanical linkage between leaves except at the periphery, are deemed to be discontinuous construction.

2. Construction Deemed-to-Satisfy

The forms of construction listed in [Table 2](#) for wall construction and [Table 3](#) for floor construction, are considered to have the R_w , $R_w + C_{tr}$ and $L_{n,w}$ stated in that Table. The forms of construction must be installed as follows:

- (a) **Masonry** — Units must be laid with all joints filled solid, including those between the masonry and any adjoining construction.
- (b) **Concrete slabs** — Joints between concrete slabs or panels and any adjoining construction must be filled solid.
- (c) **Sheeting materials**—
 - (i) if one layer is *required* on both sides of a wall, it must be fastened to the studs with joints staggered on opposite sides; and
 - (ii) if two layers are *required*, the second layer must be fastened over the first layer so that the joints do not coincide with those of the first layer; and
 - (iii) joints between sheets or between sheets and any adjoining construction must be taped and filled solid.
- (d) **Timber or steel-framed construction** — Perimeter framing members must be securely fixed to the adjoining structure and—
 - (i) bedded in resilient compound; or
 - (ii) the joints must be caulked so that there are no voids between the framing members and the adjoining structure.
- (e) **Services**—
 - (i) Services must not be chased into concrete or masonry elements.
 - (ii) A door or panel *required* to have a certain $R_w + C_{tr}$ that provides access to a duct, pipe or other service must—
 - (A) not open into any *habitable room* (other than a kitchen); and
 - (B) be firmly fixed so as to overlap the frame or rebate of the frame by not less than 10 mm, be fitted with a sealing gasket along all edges and be constructed of—
 - (aa) wood, particleboard or blockboard not less than 33 mm thick; or
 - (bb) compressed fibre-reinforced cement sheeting not less than 9 mm thick; or
 - (cc) other suitable material with a mass per unit area not less than 24.4 kg/m².
 - (iii) A water supply pipe must—
 - (A) only be installed in the cavity of discontinuous construction; and
 - (B) in the case of a pipe that serves only one *sole-occupancy unit*, not be fixed to the wall leaf on the side adjoining any other *sole-occupancy unit* and have a clearance not less than 10 mm to the other wall leaf.
 - (iv) Electrical outlets must be offset from each other—

Health and amenity

Deemed-to-Satisfy Provisions



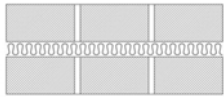
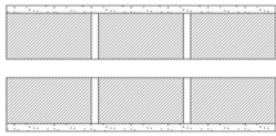
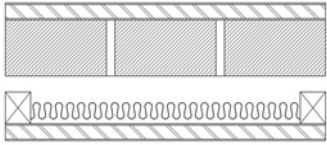
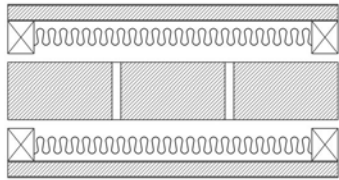
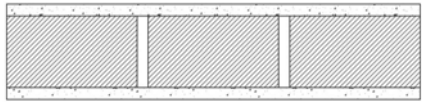
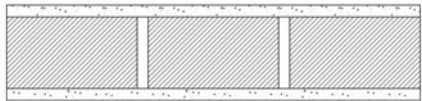
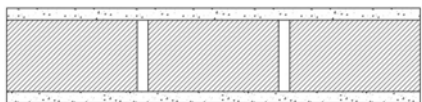

- (A) in masonry walling, not less than 100 mm; and
 (B) in timber or steel-framed walling, not less than 300 mm.

Table 2 Acceptable forms of construction for walls

Description	$R_w + C_{tr}$ (not less than)	R_w (not less than)	Construction
Wall construction type: Masonry			
Two leaves of 110 mm clay brick masonry with— (a) cavity not less than 50 mm between leaves; and (b) 50 mm thick glass wool insulation with a density of 11 kg/m ³ or 50 mm thick polyester insulation with a density of 20 kg/m ³ in the cavity.	50	50	
Two leaves of 110 mm clay brick masonry with— (a) cavity not less than 50 mm between leaves and; (b) 13 mm cement render on each outside face.	50	50	
Single leaf of 110 mm clay brick masonry with— (a) a row of 70 mm × 35 mm timber studs or 64 mm steel studs at 600 mm centres, spaced 20 mm from the masonry wall; and (b) 50 mm thick glass or mineral wool insulation with a density of 11 kg/m ³ positioned between studs; and (c) one layer of 13 mm plasterboard fixed to outside face of studs and outside face of masonry.	50	50	
Single leaf of 90 mm clay brick masonry with— (a) a row of 70 mm × 35 mm timber studs or 64 mm steel studs at 600 mm centres, spaced 20 mm from each face of the masonry wall; and (b) 50 mm thick glass or mineral wool insulation with a density of 11 kg/m ³ positioned between studs in each row; and (c) one layer of 13 mm plasterboard fixed to studs on each outside face.	50	50	
Single leaf of 150 mm brick masonry with 13 mm cement render on each face.	-	50	
Single leaf of 220 mm brick masonry with 13 mm cement render on each face.	50	50	
110 mm thick brick masonry with 13 mm cement render on each face.	-	45	
110 mm thick concrete brickwork.	-	45	



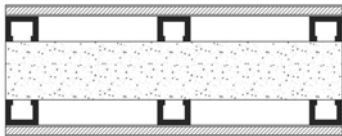
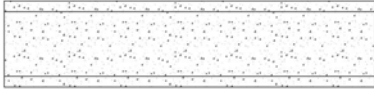
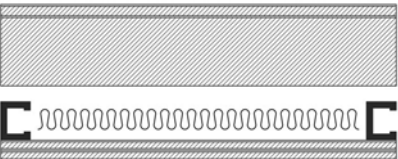
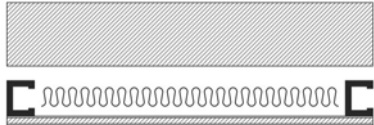
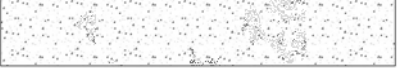
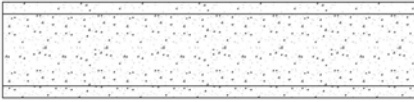



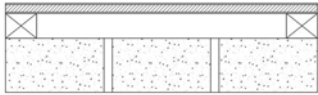

Health and amenity

Deemed-to-Satisfy Provisions

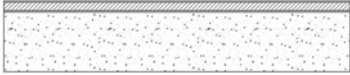
Description	$R_w + C_{tr}$ (not less than)	R_w (not less than)	Construction
			
Wall construction type: Concrete			
150 mm thick concrete panel.	50	50	
150 mm thick concrete panel with one layer of 10 mm plasterboard fixed to 28 mm metal furring channels on each face.	-	50	
200 mm thick concrete panel with one layer of 13 mm plasterboard or 13 mm cement render on each face.	50	50	
100 mm thick concrete panel with— (a) a row of 64 mm steel studs at 600 mm centres, spaced 25 mm from the concrete panel; and (b) 80 mm thick polyester insulation or 50 mm thick glass wool insulation with a density of 11 kg/m ³ , positioned between studs; and (c) two layers of 13 mm plasterboard fixed to outside face of studs and one layer of 13 mm plasterboard fixed to outside face of concrete panel.	50	50	
125 mm thick concrete panel with— (a) a row of 64 mm steel studs at 600 mm centres, spaced 20 mm from the concrete panel; and (b) 70 mm polyester insulation with a density of 9 kg/m ³ , positioned between studs; and (c) one layer of 13 mm plasterboard fixed to the outside face of the studs.	50	50	
125 mm thick concrete panel.	-	50	
100 mm concrete panel with 13 mm cement render or one layer of 13 mm plasterboard on each face.	-	50	
190 mm thick concrete blockwork.	-	45	
140 mm thick concrete blockwork, the face shell thickness of the blocks being not less than 44 mm and with— (a) 50 mm x 50 mm timber battens spaced at not more than 610 mm centres screw-fixed on one face of the	-	45	

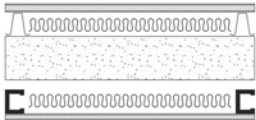

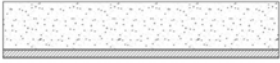
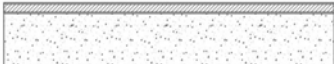

Health and amenity

Deemed-to-Satisfy Provisions

Description	$R_w + C_{tr}$ (not less than)	R_w (not less than)	Construction
(b) blocks into resilient plugs with rubber inserts between battens and the wall; and the face of the battens clad with 13 mm plasterboard.			
Concrete panel - 100 mm thick.	-	45	
Note: For the purposes of this table the term “concrete panel” is a reference to a solid in-situ concrete panel or solid precast concrete panel.			
Wall construction type: Autoclaved aerated concrete			
75 mm thick autoclaved aerated concrete wall panel with—			
(a) a row of 64 mm steel studs at 600 mm centres, spaced 20 mm from the autoclaved aerated concrete wall panel; and			
(b) 75 mm thick glass wool insulation with a density of 11 kg/m ³ positioned between studs; and	50	50	
(c) one layer of 10 mm moisture resistant plasterboard or 13 mm fire protective grade plasterboard fixed to outside face of studs and outside face of autoclaved aerated concrete wall panel.			
75 mm thick autoclaved aerated concrete wall panel with—			
(a) a row of 64 mm steel studs at 600 mm centres, spaced 35 mm from the autoclaved aerated concrete panel wall; and			
(b) 28 mm metal furring channels fixed to the outside face of the autoclaved aerated concrete wall panel, with 50 mm thick polyester insulation with a density of 9 kg/m ³ positioned between furring channels and one layer of 13 mm fire protective grade plasterboard fixed to furring channels; and	50	50	
(c) 105 mm thick glass wool insulation with a density of 7 kg/m ³ positioned between studs; and			
(d) one layer of 13 mm fire protective grade plasterboard fixed to the outside face of the studs.			
Two leaves of 75 mm autoclaved aerated concrete wall panel with—			
(a) a cavity not less than 30 mm between panels containing 50 mm glass wool insulation with a density of 11 kg/m ³ ; and	50	50	
(b) one layer of 10 mm plasterboard fixed to outside face of each panel.			
75 mm thick autoclaved aerated concrete wall panel with—			
(a) one layer of 10 mm moisture resistant plasterboard on one face; and	-	50	
(b) 28 mm metal furring channels and resilient mounts,			

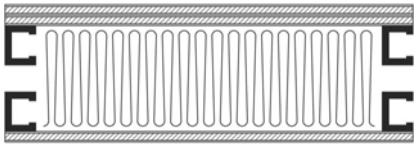
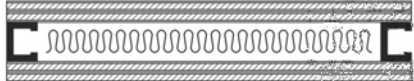
Health and amenity



Deemed-to-Satisfy Provisions

Description	$R_w + C_{tr}$ (not less than)	R_w (not less than)	Construction
75 mm polyester insulation with a density of 9 kg/m ³ and 13 mm fire-protective grade plasterboard fixed to the other face.			
Wall construction type: Timber and steel framing			
<p>Two rows of 90×35 mm timber studs or two rows of 64 mm steel studs at 600 mm centres with—</p> <p>(a) an air gap not less than 20 mm between the rows of studs; and</p> <p>(b) 50 mm thick glass wool insulation or 60 mm thick polyester insulation with a density of 11 kg/m³; positioned between one row of studs; and</p> <p>(c) two layers of 13 mm fire-protective grade plasterboard or one layer of 6 mm fibre cement sheet and one layer of 13 mm fire-protective grade plasterboard, fixed to outside face of studs.</p>	50	50	
<p>Two rows of 64 mm steel studs at 600 mm centres with—</p> <p>(a) an air gap not less than 80 mm between the rows of studs; and</p> <p>(b) 200 mm thick polyester insulation with a density of 14 kg/m³; positioned between studs; and</p> <p>(c) one layer of 13 mm fire-protective grade plasterboard and one layer 13 mm plasterboard on one outside face and one layer of 13 mm fire-protective grade plasterboard on the other outside face.</p>	50	50	
<p>One row of 92 mm steel studs at 600 mm centres with—</p> <p>(a) 50 mm thick glass wool insulation with a density of 11 kg/m³ or 60 mm thick polyester insulation with a density of 8 kg/m³, positioned between studs; and</p> <p>(b) two layers of 13 mm fire-protective grade plasterboard or one layer of 6 mm fibre-cement sheet and one layer of 13 mm fire-protective grade plasterboard, fixed to each face.</p>	-	50	
<p>One row of 64 mm steel studs with 2 layers of 16 mm fire-protective grade plasterboard fixed to each face.</p>	-	45	
<p>One row of 64 mm steel studs with—</p> <p>(a) one layer of 16 mm fire-protective grade plasterboard fixed to one face; and</p> <p>(b) 50 mm thick glass or mineral wool insulation with a density of 11 kg/m³ positioned between the studs; and</p> <p>(c) two layers of fire-protective grade plasterboard fixed to the other face, the inner layer being 16 mm thick and the outer layer being 13 mm.</p>	-	45	
<p>One row of 64 mm steel studs with two layers of 13 mm plasterboard on each face.</p>	-	45	

Health and amenity

Deemed-to-Satisfy Provisions

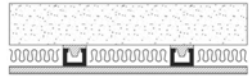
Table 3 Acceptable forms of construction for floors

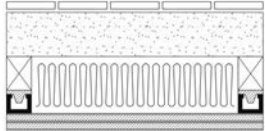
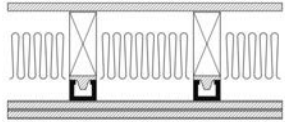
Description	$R_w + C_{tr}$ (not less than)	$L_{n,w}$ (not more than)	R_w (not less than)	Construction
Floor construction type: Concrete				
150 mm thick concrete slab with—				
(a) 28 mm metal furring channels and isolation mounts fixed to underside of slab, at 600 mm centres; and				
(b) 65 mm thick polyester insulation with a density of 8 kg/m ³ , positioned between furring channels; and	50	62	50	
(c) one layer of 13 mm plasterboard fixed to furring channels.				
200 mm thick concrete slab with carpet on underlay.	50	62	50	
100 mm thick concrete slab.	45	-	45	
Floor construction type: Autoclaved aerated concrete				
75 mm thick autoclaved aerated concrete floor panel with—				
(a) 8 mm ceramic tiles with flexible adhesive and waterproof membrane, located above the slab; and				
(b) timber joists at 600 mm centres; and				
(c) R1.5 glass wool insulation positioned between timber joists; and	50	62	50	
(d) 28 mm metal furring channels and resilient mounts fixed to underside of joists; and				
(e) two layers of 13 mm plasterboard fixed to furring channels.				
Floor construction type: Timber				
19 mm thick chipboard floor sheeting with—				
(a) 190×45 mm timber joists at 450 mm centres; and				
(b) R2.5 glass wool insulation positioned between timber joists; and				
(c) 28 mm metal furring channels and isolation mounts fixed to underside of joists, isolation mounts to be of natural rubber with a dynamic factor of not more than 1.1 and static deflection of not less than 3 mm at actual operating load; and	50	62	50	
(d) two layers of 16 mm fire-protective grade plasterboard fixed to furring channels.				
19 mm thick tongued and grooved boards with—				
(a) timber joists not less than 175 mm x 50 mm; and	45	-	45	
(b) 75 mm thick glass or mineral wool				

Health and amenity

Deemed-to-Satisfy Provisions

Description	$R_w + C_{tr}$ (not less than)	$L_{n,w}$ (not more than)	R_w (not less than)	Construction
<p>insulation with a density of 11 kg/m³ positioned between joists and laid on 10 mm thick plasterboard fixed to underside of joists; and</p> <p>(c) 25 mm thick glass or mineral wool insulation with a density of 11 kg/m³ laid over entire floor, including tops of joists before flooring is laid; and</p> <p>(d) secured to 75 mm × 50 mm battens; and</p> <p>(e) the assembled flooring laid over the joists, but not fixed to them, with the battens lying between the joists.</p>				

Specification F5.5

Impact sound — Test of equivalence

Deemed-to-Satisfy Provisions

1. Scope

This Specification describes a method of test to determine the comparative resistance of walls to the transmission of impact sound.

2. Construction to be tested

- (a) The test is conducted on a specimen of prototype wall construction and on a specimen of one or other of the constructions specified in [Table 2 of Specification F5.2](#).
- (b) The testing of a construction specified in [Table 2 of Specification F5.2](#) need not be repeated for subsequent comparisons provided complete records of the results, the test equipment and the technique of testing are kept so that identical equipment can be employed and an identical technique can be adopted in the testing of specimens of prototype wall construction.

3. Method

- (a) The wall constructions to be compared must be tested in accordance with AS 1191.
- (b) A horizontal steel platform 510 mm x 460 mm x 10 mm thick must be placed with one long edge in continuous and direct contact with the wall to be tested on the side of the wall on which the impact sound is to be generated.
- (c) A tapping machine complying with ISO 140/6 — 1998 (E) must be mounted centrally on the steel platform.
- (d) The sound transmission through the wall must be determined in accordance with AS 1191 except that the tapping machine as mounted on the steel platform must be used as the source of sound.
- (e) The impact sound pressure levels measured in the receiving room must be converted into normalised levels using a reference equivalent absorption area of 10 m².

Part F6 Condensation management

Performance Requirements

FP6.1 Condensation and water vapour management

In a *sole-occupancy unit* of a Class 2 building or a Class 4 part of a building, risks associated with water vapour and *condensation* must be managed to minimise their impact on the health of occupants.

Tas FP6.1

Verification Methods

FV6 Condensation management

Compliance with *Performance Requirement FP6.1* is verified when modelling that assesses the effects of—

- (a) indoor and outdoor temperature and humidity conditions; and
- (b) heating and cooling set points; and
- (c) rain absorption; and
- (d) wind pressure; and
- (e) solar radiation; and
- (f) material hygrothermal properties,
determines that moisture will not accumulate—
- (g) interior to the primary *water control layer* within a building envelope; or
- (h) on the interior surface of the *water control layer*.

Part F6 Condensation management

Deemed-to-Satisfy Provisions

F6.0 Deemed-to-Satisfy Provisions

- (a) Compliance with *Performance Requirement FP6.1* is satisfied by complying with *Deemed-to-Satisfy Provisions F6.1* to *F6.4*.
- (b) Where a *Performance Solution* is proposed, the relevant *Performance Requirements* must be determined in accordance with *A2.2(3)* and *A2.4(3)* as applicable.

ACT Appendix

Explanatory information:

The intent of these requirements is to assist in the mitigation of *condensation* within a building. The installation of a *condensation* management system may not prevent *condensation* from occurring.

F6.1 Application of Part

The *Deemed-to-Satisfy Provisions* of this Part only apply to a *sole-occupancy unit* of a Class 2 building and a Class 4 part of a building.

F6.2 Pliable building membrane

- (a) Where a *pliable building membrane* is installed in an *external wall*, it must—
 - (i) comply with AS/NZS 4200.1; and
 - (ii) be installed in accordance with AS 4200.2; and
 - (iii) be a vapour permeable membrane for *climate zones* 6, 7 and 8; and
 - (iv) be located on the exterior side of the primary insulation layer of wall assemblies that form the external envelope of a building.
- (b) Except for single skin masonry and single skin concrete, where a *pliable building membrane* is not installed in an *external wall*, the primary *water control layer* must be separated from *water sensitive materials* by a drained cavity.

F6.3 Flow rate and discharge of exhaust systems

- (a) An exhaust system installed in a kitchen, bathroom, *sanitary compartment* or laundry must have a minimum flow rate of—
 - (i) 25 L/s for a bathroom or *sanitary compartment*; and
 - (ii) 40 L/s for a kitchen or laundry.
- (b) Exhaust from a kitchen must be discharged directly or via a shaft or duct to *outdoor air*.
- (c) Exhaust from a bathroom, *sanitary compartment*, or laundry must be discharged—
 - (i) directly or via a shaft or duct to *outdoor air*; or
 - (ii) to a roof space that is ventilated in accordance with *F6.4*.

F6.4 Ventilation of roof spaces

- (a) Where an exhaust system covered by *F6.3* discharges directly or via a shaft or duct into a roof space, the roof space must be ventilated to *outdoor air* through evenly distributed openings.
- (b) Openings *required* by (a) must have a total unobstructed area of 1/300 of the respective ceiling area if the roof pitch is greater than 22°, or 1/150 of the respective ceiling area if the roof pitch is less than or equal to 22°.
- (c) 30% of the total unobstructed area *required* by (b) must be located not more than 900 mm below the ridge or highest point of the roof space, measured vertically, with the remaining *required* area provided by eave vents.

Ancillary provisions

- Part G1** **Minor structures and components**
- Part G2** **Boilers, pressure vessels, heating appliances, fireplaces, chimneys and flues**
- Part G3** **Atrium construction**
- Part G4** **Construction in alpine areas**
- Part G5** **Construction in bushfire prone areas**
- Part G6** **Occupiable outdoor areas**

Section G Ancillary provisions

Part G1 Minor structures and components

Performance Requirements

- GP1.1 Swimming pool drainage
- GP1.2 Swimming pool access and water recirculation systems
- GP1.3 Cool rooms
- GP1.4 Vaults
- GP1.5 Outdoor play spaces in early childhood centres
- G1.0 Deemed-to-Satisfy Provisions
- G1.1 Swimming pools
- G1.2 Refrigerated chambers, strong-rooms and vaults
- G1.3 Outdoor play spaces

Part G2 Boilers, pressure vessels, heating appliances, fireplaces, chimneys and flues

Performance Requirements

- GP2.1 Combustion heating appliances
- GP2.2 Boilers and pressure vessels

Verification Methods

- GV2 Combustion appliances
- G2.0 Deemed-to-Satisfy Provisions
- G2.1 * * * * *
- G2.2 Installation of appliances
- G2.3 Open fireplaces
- G2.4 Incinerator rooms

Specification G2.2 Installation of boilers and pressure vessels

- 2.1 Explosion relief
- 2.2 Floors and drainage
- 2.3 Protection from heat

Part G3 Atrium construction

- G3.1 Application of Part
- G3.2 Dimensions of atrium well
- G3.3 Separation of atrium by bounding walls
- G3.4 Construction of bounding walls
- G3.5 Construction at balconies
- G3.6 Separation at roof
- G3.7 Means of egress
- G3.8 Fire and smoke control systems

Specification G3.8 Fire and smoke control systems in buildings containing atriums

- 2.1 General requirement
- 2.2 Roof protection
- 2.3 Atrium floor protection
- 2.4 Sprinkler systems to glazed walls
- 2.5 Stop valves
- 3.1 General requirements
- 3.2 Operation of atrium mechanical air-handling systems
- 3.3 Activation of smoke control system
- 3.4 Smoke exhaust system
- 3.5 Upward air velocity
- 3.6 Exhaust fans

- 3.7 Smoke and heat vents
- 3.8 Make-up air supply
- 4.1 General requirements
- 4.2 Smoke detection system
- 4.3 Smoke detection in spaces separated from the atrium by bounding walls
- 4.4 Alarm systems

Part G4 Construction in alpine areas

Performance Requirements

- GP4.1 External doorways
- GP4.2 Structures forming pathways in snow conditions
- GP4.3 Control of falling ice and snow
- GP4.4 Fire safety systems in alpine areas
- G4.0 Deemed-to-Satisfy Provisions
- G4.1 Application of Part
- G4.2 * * * * *
- G4.3 External doors
- G4.4 Emergency lighting
- G4.5 External trafficable structures
- G4.6 Clear space around buildings
- G4.7 * * * * *
- G4.8 Fire-fighting services and equipment
- G4.9 Fire orders

Part G5 Construction in bushfire prone areas

Performance Requirements

- GP5.1 Bushfire resistance

Verification Methods

- GV5 Buildings in bushfire prone areas
- G5.0 Deemed-to-Satisfy Provisions
- G5.1 Application of Part
- G5.2 Protection

Part G6 Occupiable outdoor areas

- G6.1 Application of Part
- G6.2 Fire hazard properties
- G6.3 Fire separation
- G6.4 Provision for escape
- G6.5 Construction of exits
- G6.6 Fire fighting equipment
- G6.7 Lift installations
- G6.8 Visibility in an emergency, exit signs and warning systems
- G6.9 Light and ventilation
- G6.10 Fire orders

Part G1 Minor structures and components

Performance Requirements

GP1.1 Swimming pool drainage

NT GP1.1

A *swimming pool* must have adequate means of draining the pool in a manner which will not—

- (a) cause illness to people; or
- (b) affect *other property*.

GP1.2 Swimming pool access and water recirculation systems

ACT Appendix

NSW GP1.2(a)

NT GP1.2(a)

Qld GP1.2(a)

SA GP1.2

Tas GP1.2(a)

Vic GP1.2(a)

- (a) A barrier must be provided to a *swimming pool* and must—
 - (i) be continuous for the full extent of the hazard; and
 - (ii) be of a strength and rigidity to withstand the foreseeable impact of people; and
 - (iii) restrict the access of young children to the pool and the immediate pool surrounds; and
 - (iv) have any gates and doors fitted with latching devices not readily operated by young children, and constructed to automatically close and latch.
- (b) A *swimming pool* water recirculation system must incorporate safety measures to avoid entrapment of, or injury to, a person.

SA GP1.2(c)

Application

GP1.2(b) only applies to a *swimming pool* with a depth of water more than 300 mm.

GP1.3 Cool rooms

Any refrigerated or cooling chamber, or the like which is of sufficient size for a person to enter must—

- (a) have adequate means of communicating with or alerting other occupants in the building in the case of an emergency; and
- (b) have a door which is—
 - (i) of adequate dimensions to allow occupants to readily escape; and
 - (ii) openable from inside without a key at all times.

GP1.4 Vaults

Any strong-room, vault or the like which is of sufficient size for a person to enter must—

- (a) have adequate means of communicating with or alerting other occupants in the building in the case of an emergency; and
- (b) have internal lighting controllable only from within the room; and
- (c) have an external indicator that the room is occupied.

GP1.5 Outdoor play spaces in early childhood centres

Fencing or other barriers must be provided around any outdoor play space, in which the design and height of the fencing or other barriers, including the—

- (a) design of gates and fittings; and
 - (b) proximity of the barriers to any permanent structure on the property,
- must ensure that children cannot go through, over or under the fencing or other barriers.

Application

GP1.5 only applies to a Class 9b *early childhood centre*.

Tas GP1.6

Part G1 Minor structures and components

Deemed-to-Satisfy Provisions

G1.0 Deemed-to-Satisfy Provisions

- (a) *Performance Requirement GP1.1* must be complied with.

There is no *Deemed-to-Satisfy Provision* for this *Performance Requirement*.

Tas G1.0(b)

- (b) Where a *Deemed-to-Satisfy Solution* is proposed, *Performance Requirements GP1.2* to *GP1.5* are satisfied by complying with *G1.1* to *G1.3*.
- (c) Where a *Performance Solution* is proposed, the relevant *Performance Requirements* must be determined in accordance with *A2.2(3)* and *A2.4(3)* as applicable.

G1.1 Swimming pools

NSW G1.1(a) and (b)

NT G1.1(a)

Qld G1.1(a)

Vic G1.1(a)

- (a) * * * * *

- (b) A *swimming pool* with a depth of water more than 300 mm and which is associated with a Class 2 or 3 building or Class 4 part of a building, must have suitable barriers to restrict access by young children to the immediate pool surrounds in accordance with AS 1926.1 and AS 1926.2.
- (c) A water recirculation system in a *swimming pool* with a depth of water more than 300 mm must comply with AS 1926.3.

ACT Appendix

SA G1.1(d), (e)

Tas G1.1(d)–(h)

Explanatory information: Cross-volume considerations

Part C2 of NCC Volume Three sets out the requirements for pumped discharge from *swimming pools*.

G1.2 Refrigerated chambers, strong-rooms and vaults

- (a) A refrigerated or cooling chamber, strongroom or vault which is of sufficient size for a person to enter must have—
- (i) a door which is capable of being opened by hand from inside without a key; and
 - (ii) internal lighting controlled only by a switch which is located adjacent to the entrance doorway inside the chamber, strongroom or vault; and
 - (iii) an indicator lamp positioned outside the chamber, strongroom or vault which is illuminated when the interior lights *required* by (a)(ii) are switched on; and
 - (iv) an alarm that is—
 - (A) located outside but controllable only from within the chamber, strongroom or vault; and
 - (B) able to achieve a sound pressure level outside the chamber, strongroom or vault of 90 dB(A) when measured 3 m from the sounding device.
- (b) A door *required* by (a)(i) in a refrigerated or cooling chamber must have a doorway with a clear width of not less than 600 mm and a clear height not less than 1.5 m.

Ancillary provisions

Deemed-to-Satisfy Provisions

G1.3 Outdoor play spaces

- (a) Any outdoor play space in a Class 9b *early childhood centre* must be enclosed on all sides with a barrier which complies with AS 1926.1.
- (b) For the purposes of (a), AS 1926.1 is applied as if there is a *swimming pool* located outside the outdoor play space, so that the barrier restricts children from exiting the premises without the knowledge of staff in the centre.
- (c) The requirements of (a) do not apply to a wall, including doors and *windows*, which form part of the Class 9b *early childhood centre*.

NSW G1.101

Part G2

Boilers, pressure vessels, heating appliances, fireplaces, chimneys and flues

Performance Requirements

GP2.1 Combustion heating appliances

Where provided in a building, a combustion appliance and its associated components, including an open fire-place, chimney, flue, chute, hopper or the like, must be installed—

- (a) to withstand the temperatures likely to be generated by the appliance; and
- (b) so that it does not raise the temperature of any building element to a level that would adversely affect the element's physical or mechanical properties or function; and
- (c) so that hot products of combustion will not—
 - (i) escape through the walls of the associated components; and
 - (ii) discharge in a position that will cause fire to spread to nearby *combustible* materials or allow smoke to penetrate through nearby *windows*, ventilation inlets, or the like.

GP2.2 Boilers and pressure vessels

When located in a building, *boilers* and *pressure vessels* must be installed to avoid, during reasonably foreseeable conditions, the likelihood of—

- (a) leakage from the vessel which could cause damage to the building; and
- (b) rupture or other mechanical damage of the vessel which could cause damage to the building or injury to occupants.

Verification Methods

GV2 Combustion appliances

Compliance with GP2.1(a) and GP2.1(b) is verified when—

- (a) components used within an appliance and its installation are constructed from—
 - (i) heat-resistant materials for maximum operating temperatures not less than 600°C, where the material complies with (c); or
 - (ii) heat-tolerant materials for maximum operating temperatures more than 150°C and less than 600°C, where the material complies with (c); and
- (b) the building elements surrounding the appliance maintain their designed function and material properties inclusive of a full range of thermal movements when exposed to the heat effects of the appliance; and
- (c) a sample of the material is tested to the maximum operating temperature, specified in (a)(i) or (a)(ii) for a minimum of 96 hours and the tested sample complies with the following:
 - (i) When allowed to cool, the tested sample must be free from—
 - (A) visible cracks and fractures; and
 - (B) visible indication of de-lamination; and
 - (C) linear distortion in excess of the equivalent of 10 mm per metre, and
 - (D) deterioration of the appearance of any surface finish, when compared to an unheated sample.

Deemed-to-Satisfy Provisions

G2.0 Deemed-to-Satisfy Provisions

- (a) Where a *Deemed-to-Satisfy Solution* is proposed, *Performance Requirements GP2.1* and *GP2.2* are satisfied by complying with *G2.1* to *G2.4*.
- (b) Where a *Performance Solution* is proposed, the relevant *Performance Requirements* must be determined in accordance with *A2.2(3)* and *A2.4(3)* as applicable.

G2.1 * * * * *

This clause has deliberately been left blank.

G2.2 Installation of appliances

The installation of a stove, heater or similar appliance in a building must comply with:

- (a) * * * * *
- (b) Domestic solid-fuel burning appliances — Installation: AS/NZS 2918.
- (c) For *boilers* and *pressure vessels*: *Specification G2.2*.

ACT Appendix

G2.3 Open fireplaces

An open fireplace, or solid-fuel burning appliance in which the fuel-burning compartment is not enclosed must have—

- (a) a hearth constructed of stone, concrete, masonry or similar *non-combustible* material so that—
 - (i) it extends not less than 300 mm beyond the front of the fireplace opening and not less than 150 mm beyond each side of that opening; and
 - (ii) it extends beyond the limits of the fireplace or appliance not less than 300 mm if the fireplace or appliance is free-standing from any wall of the room; and
 - (iii) its upper surface does not slope away from the grate or appliance; and
 - (iv) *combustible* material situated below the hearth but not below that part *required* to extend beyond the fireplace opening or the limits of the fireplace is not less than 150 mm from the upper surface of the hearth; and
- (b) walls forming the sides and back of the fireplace up to not less than 300 mm above the underside of the arch or lintel which—
 - (i) are constructed in 2 separate leaves of solid masonry not less than 180 mm thick, excluding any cavity; and
 - (ii) do not consist of concrete block masonry in the construction of the inner leaf; and
- (c) walls of the chimney above the level referred to in (b)—
 - (i) constructed of masonry units with a net volume, excluding cored and similar holes, not less than 75% of their gross volume, measured on the overall rectangular shape of the units, and with an actual thickness of not less than 100 mm; and
 - (ii) lined internally to a thickness of not less than 12 mm with rendering consisting of 1 part cement, 3 parts lime, and 10 parts sand by volume, or other suitable material; and
- (d) suitable damp-proof courses or flashings to maintain weatherproofing.

G2.4 Incinerator rooms

- (a) If an incinerator is installed in a building, any hopper giving access to a charging chute must be—
 - (i) *non-combustible*; and

Ancillary provisions

Deemed-to-Satisfy Provisions

- (ii) gas-tight when closed; and
 - (iii) designed to return to the closed position after use; and
 - (iv) not attached to a chute that connects directly to a flue unless the hopper is located in the open air; and
 - (v) not located in a *required exit*.
- (b) A room containing an incinerator must be separated from other parts of the building by construction with an FRL of not less than 60/60/60.

Specification G2.2

Installation of boilers and pressure vessels

Deemed-to-Satisfy Provisions

1. Scope

This Specification sets out the requirements for the installation of *boilers* and *pressure vessels* in buildings.

2. Boilers and pressure vessels

2.1 Explosion relief

The distance between the vent of any explosion relief device and any adjacent wall, roof, ceiling or other solid construction shall be calculated in accordance with [Table 2.1](#).

Table 2.1 Minimum clearances for explosion relief

Clearance from	Minimum clearance (metres)
Adjacent wall or ceiling/roof	$0.4(V/3)^{1/3}$ or 0.4 m, whichever is the greater
Two walls at right angles; or one wall and a ceiling/roof	$0.6(V/3)^{1/3}$ or 0.6 m, whichever is the greater

Note to Table 2.1: V is the internal volume of the *boiler* or *pressure vessel* being vented up to the connection of the flue.

2.2 Floors and drainage

- (a) Floor surfaces beneath *boilers* and *pressure vessels* shall be *water resistant* and formed to drain away from supports and structural building elements.
- (b) Where a safe tray is provided to trap liquids, it must be manufactured from a material resistant to corrosion from the contents of the *boiler* or *pressure vessel*.

2.3 Protection from heat

Building elements surrounding a *boiler* must be protected from any surface heat by refractory material or effective air spaces so that—

- (a) steel elements do not exceed a temperature of more than 300°C; and
- (b) concrete elements do not exceed a temperature of more than 200°C; and
- (c) timber elements do not exceed a temperature of more than 150°C.

Part G3 Atrium construction

Deemed-to-Satisfy Provisions

Note:

Part G3 contains *Deemed-to-Satisfy Provisions* additional to those contained in Sections C, D and E for *atrium* Construction.

G3.1 Application of Part

This Part does not apply to an *atrium* which—

- (a) connects only 2 *storeys*; or
- (b) connects only 3 *storeys* if—
 - (i) each *storey* is provided with a sprinkler system (other than a FPAA101D or FPAA101H system) complying with [Specification E1.5](#) throughout; and
 - (ii) one of those *storeys* is situated at a level at which there is direct egress to a road or *open space*.

G3.2 Dimensions of atrium well

An *atrium well* must have a width throughout the well that is able to contain a cylinder having a horizontal diameter of not less than 6 m.

G3.3 Separation of atrium by bounding walls

An *atrium* must be separated from the remainder of the building at each *storey* by bounding walls set back not more than 3.5 m from the perimeter of the *atrium well* except in the case of the walls at no more than 3 consecutive *storeys* if—

- (a) one of those *storeys* is at a level at which direct egress to a road or *open space* is provided; and
- (b) the sum of the *floor areas* of those *storeys* that are contained within the *atrium* is not more than the maximum area that is permitted in [Table C2.2](#).

G3.4 Construction of bounding walls

Bounding walls must—

- (a) have an FRL of not less than 60/60/60, and—
 - (i) extend from the floor of the *storey* to the underside of the floor next above or to the underside of the roof; and
 - (ii) have any door openings protected with *self-closing* or *automatic* –/60/30 fire doors; or
- (b) be constructed of fixed toughened safety glass, or wired safety glass in *non-combustible* frames, with—
 - (i) any door openings fitted with a *self-closing* smoke door complying with [Specification C3.4](#); and
 - (ii) the walls and doors protected with wall-wetting systems in accordance with [Specification G3.8](#); and
 - (iii) a fire barrier with an FRL of not less than –/60/30 installed in any ceiling spaces above the wall.

G3.5 Construction at balconies

If a bounding wall separating an *atrium* from the remainder of the building is set back from the perimeter of the *atrium well*, a barrier that is imperforate and *non-combustible*, and not less than 1 m high must be provided.

G3.6 Separation at roof

In an *atrium*—

- (a) the roof must have the FRL prescribed in [Table 3 of Specification C1.1](#); or
- (b) the roof structure and membrane must be protected by a sprinkler system (other than a FPAA101D or FPAA101H system) complying with [Specification E1.5](#).

Ancillary provisions

Deemed-to-Satisfy Provisions

G3.7 Means of egress

All areas within an [atrium](#) must have access to at least 2 [exits](#).

G3.8 Fire and smoke control systems

Sprinkler systems, smoke control, fire detection and alarm systems, and emergency warning and intercom systems must be installed in compliance with [Specification G3.8](#).

Specification G3.8

Fire and smoke control systems in buildings containing atriums

Deemed-to-Satisfy Provisions

1. Scope

This Specification sets out the requirements for the design and operation of systems of fire and smoke control in buildings containing an *atrium*.

2. Automatic fire sprinkler system

2.1 General requirement

A sprinkler system (other than a FPAA101D or FPAA101H system) complying with [Specification E1.5](#) must be installed in every building containing an *atrium*, except where varied or superseded by this Specification.

2.2 Roof protection

A roof of an *atrium* which does not have the FRL prescribed in [Specification C1.1](#) or the *Deemed-to-Satisfy Provisions* of [Part C2](#) must be protected by *automatic* sprinklers arranged to wet both the covering membrane and supporting structure if the roof is—

- (a) less than 12 m above the floor of the *atrium* or the floor of the highest *storey* where the bounding construction is set back more than 3.5 m from the *atrium well* if a Class 2, 3, 5 or 9 part of a building is open to the *atrium*; or
- (b) less than 20 m above the floor of the *atrium* or the floor of the highest *storey* where the bounding construction is set back more than 3.5 m from the *atrium well* if a Class 6, 7 or 8 part of a building is open to the *atrium*,

and the temperature rating of sprinkler heads providing roof protection must be within the range 79°C–100°C.

2.3 Atrium floor protection

The floor of the *atrium* must be protected by sprinklers with—

- (a) the use of sidewall pattern sprinkler heads together with overhead sprinklers where dictated by the dimensions of the *atrium*; and
- (b) sprinkler heads of the fast response type.

2.4 Sprinkler systems to glazed walls

2.4.1 Location of protection

Where an *atrium* is separated from the remainder of the building by walls or doors incorporating glazing, a wall wetting system must be provided to protect the glazing as follows:

- (a) On the *atrium* side of the glazing — to all glazed walls which are set back more than 3.5 m from the *atrium well*.
- (b) On the *atrium* side of the glazing — to all glazed walls which are not set back, or are set back 3.5 m or less, from the *atrium well*, for all levels which are less than—
 - (i) 12 m above the floor of an *atrium* or the floor of the highest *storey* where the bounding wall is set back more than 3.5 m from the *atrium well* if a Class 2, 3, 5 or 9 part of the building is open to the *atrium*; or
 - (ii) 20 m above the floor of an *atrium* or the floor of the highest *storey* where the bounding wall is set back more than 3.5 m from the *atrium well* if a Class 6, 7 or 8 part of the building is open to the *atrium*.
- (c) On the side of the glazing away from the *atrium well*—to all glazing forming part of the bounding wall at each *storey*.

Ancillary provisions

Deemed-to-Satisfy Provisions

2.4.2 Sprinkler head location

Sprinklers must be located in positions allowing full wetting of the glazing surfaces without wetting adjacent sprinkler heads.

2.4.3 Head rating and response time

Sprinkler heads must be of the fast response type and have a maximum temperature rating of 74°C.

2.4.4 Water discharge rate

The rate of water discharge to protect glazing must be not less than—

- (a) on the *atrium* side of the glazing—
 - (i) 0.25 L/s.m² where glazing is not set back from the *atrium well*; or
 - (ii) 0.167 L/s.m² where glazing is set back from the *atrium well*; and
- (b) on the side away from the *atrium well*—0.167 L/s.m².

2.4.5 Water supply

In addition to that of the basic sprinkler protection for the building, the water supply to *required* wall wetting systems must be of adequate capacity to accommodate the following on the *atrium* side of the glazing:

- (a) Where the bounding walls are set back less than 3.5 m from the *atrium well*—wall wetting of a part not less than 6 m long for a height of not less than—
 - (i) 12 m above the floor of an *atrium* or the floor of the highest *storey* where the bounding wall is set back more than 3.5 m from the *atrium well* if a Class 2, 3, 5 or 9 part of the building is open to the *atrium*; or
 - (ii) 20 m above the floor of an *atrium* or the floor of the highest *storey* where the bounding wall is set back more than 3.5 m from the *atrium well* if a Class 6, 7 or 8 part of the building is open to the *atrium*; and
- (b) Where the walls are set back 3.5 m or more from the *atrium well* — wetting of a part not less than 12 m long on one *storey*.

2.5 Stop valves

- (a) Basic sprinkler and wall wetting systems protecting a building containing an *atrium* must be provided with easily accessible and identified stop valves.
- (b) Sprinkler and wall wetting systems must be provided with independent stop valves.
- (c) Sprinkler heads protecting the roof of the *atrium* must be provided with a stop valve.
- (d) Stop valve to wall wetting and roof sprinklers may be of the gate type.
- (e) All sprinkler and wall wetting stop valves must be monitored to detect unauthorised closure.

3. Smoke control system

3.1 General requirements

Except where varied or superseded by this Specification, mechanical air-handling systems in a building containing an *atrium* must comply with AS 1668.1.

3.2 Operation of atrium mechanical air-handling systems

Mechanical air-handling systems serving an *atrium* must be designed to operate so that during a fire—

- (a) a tenable atmosphere is maintained in all paths of travel along balconies to *required exits* during the period of evacuation; and
- (b) smoke exhaust fans serving the *atrium* are only activated when smoke enters the *atrium*; and
- (c) central plant systems do not use the *atrium* as a return air path; and

Ancillary provisions

Deemed-to-Satisfy Provisions

- (d) central plant systems which use return air paths remote from the *atrium*—
 - (i) cycle to the full outside air mode; and
 - (ii) stop supply air to the fire affected *storey* or *fire compartment*; and
 - (iii) continue to fully exhaust the fire affected *storey* or *fire compartment* and reduce the exhaust from other *storeys* or *fire compartments* by at least 75%; and
 - (iv) continue to supply air to *fire compartments* or *storeys* other than the fire affected *storey* or *fire compartment*, and
- (e) fans performing relief or exhaust duty from the *atrium* stop normal operation; and
- (f) floor by floor, or unitary, air-handling plant serving a single *fire compartment* or *storey*—
 - (i) ceases normal operation in the fire affected *storey* or *fire compartment*; and
 - (ii) commences full relief or exhaust from that fire affected *storey* or *fire compartment*; and
 - (iii) continue to supply air to *fire compartments* or *storeys* other than the fire affected *storey* or *fire compartment*.

3.3 Activation of smoke control system

- (a) The smoke control system must be activated by—
 - (i) operation of an *automatic* fire alarm; or
 - (ii) operation of the sprinkler system; or
 - (iii) a manual start switch.
- (b) All controls for the smoke control system must be located—
 - (i) in the fire control room; or
 - (ii) in the emergency control centre, (if any); or
 - (iii) adjacent to the sprinkler control valves; or
 - (iv) incorporated in the Fire Indicator Panel.

3.4 Smoke exhaust system

A smoke exhaust system serving an *atrium* must be designed on the basis of—

- (a) the sprinkler system limiting the size of a fire to—
 - (i) a heat output of 1.5 MW and perimeter of 7.5 m if a Class 2, 3, 5 or 9 part of the building is open to the *atrium*; or
 - (ii) a heat output of 5 MW and perimeter of 12 m if a Class 6, 7 or 8 part of the building is open to the *atrium*; and
- (b) a smoke plume reaching a level 3 m above the highest *storey* having a path of travel to a *required exit* along a balcony bounding the *atrium well*, and not less than—
 - (i) 12 m above the floor of an *atrium* or the floor of the highest *storey* where the bounding wall is set back more than 3.5 m from the *atrium well* if a Class 2, 3, 5 or 9 part of the building is open to the *atrium*; or
 - (ii) 20 m above the floor of an *atrium* or the floor of the highest *storey* where the bounding construction is set back more than 3.5 m from the *atrium well* if a Class 6, 7 or 8 part of the building is open to the *atrium*; and
- (c) the smoke exhaust system discharging smoke at a rate of not less than that shown in [Figure 3.4](#) for the appropriate height of smoke plume and fire size—
 - (i) from the top of the *atrium*; or
 - (ii) horizontally where calculations of wind velocity induced pressure profiles for the building verify that the exhaust system will operate effectively for all wind directions.

Ancillary provisions

Deemed-to-Satisfy Provisions

Figure 3.4 Smoke exhaust rate

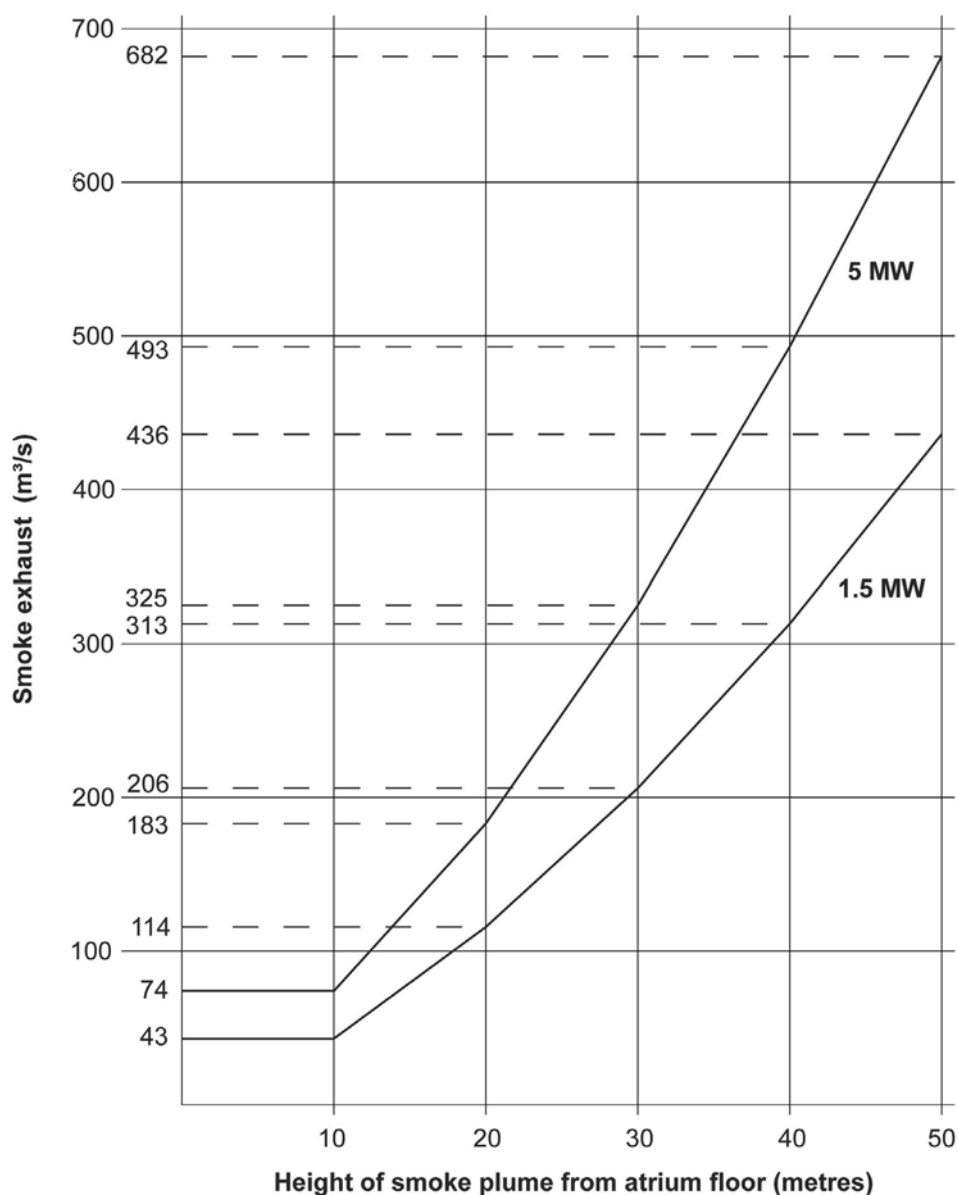

3.5 Upward air velocity

Notwithstanding 3.4(c), the average upward air velocity in the *atrium*, due to the *required* smoke exhaust quantity must—

- (a) be not less than 0.2 m/s at any level over an 18 m height above the floor of the *atrium*; and
- (b) not exceed the following maximum velocities in *atriums* of constant cross sectional plan area—
 - (i) for occupancy classification qualifying for 1.5 MW fire size — 3.5 m/s.
 - (ii) for occupancy classifications qualifying for 5 MW fire size — 5 m/s.

3.6 Exhaust fans

- (a) Smoke exhaust must be provided by fans capable of continuous and *required* operation for a period of not less than 1 hour when handling exhaust gases at 200°C.
- (b) Where a Class 2, 3 or 9 part of a building adjoins an *atrium*, the *atrium* must be provided with a minimum

Ancillary provisions

Deemed-to-Satisfy Provisions

of 3 fans each capable of 50% of the total *required* smoke exhaust capacity.

- (c) *Atriums* other than those referred to in (b) must be provided with a minimum of 2 fans each capable of 50% of the total *required* smoke exhaust capacity.

3.7 Smoke and heat vents

Notwithstanding [Clause 3.6](#), *automatic* vents complying with AS 2665 may be used, except where a Class 6 part of a building adjoins the *atrium*, in lieu of exhaust fans provided that—

- (a) the height from the *atrium* floor to the bottom of the highest vent is not more than 12 m; and
- (b) the vents are fitted with a remote manual operation switch located adjacent to the sprinkler control valves or incorporated in the Fire Indicator Panel.

3.8 Make-up air supply

- (a) Uniformly distributed make-up air must be provided to the *atrium* exhaust system from—
 - (i) outside the *atrium* at or near the lowest *storey* level; and
 - (ii) relief air from non-fire *storeys*.
- (b) A discharge volume sufficient to maintain a velocity of not less than 0.1 m/s towards the *atrium well* must be provided on all *storeys* where the bounding wall is set back from the *atrium well*.
- (c) The requirements of (a)(i) are satisfied if make-up air is provided to the *atrium* exhaust system in such a manner as to prevent, as far as possible, disturbance of the smoke layer due to turbulence created by the incoming air, through—
 - (i) openings directly from the outside air to the *atrium* and located as close as practicable to the lowest level of the *atrium*; or
 - (ii) ducts from the outside air to the *atrium* which deliver air as close as practicable to the lowest level of the *atrium* and, where passing through any other *fire compartment* having an FRL of at least 60/60/60; or
 - (iii) a combination of (i) and (ii).

4. Fire detection and alarm system

4.1 General requirements

Except where superseded by this Specification, *automatic* fire detection and alarm systems in a building containing an *atrium* must comply with AS 1670.1.

4.2 Smoke detection system

Smoke detection within an *atrium*—

- (a) must be provided within all outside air intakes and at individual floor return air intakes of all air-handling systems to initiate *automatic* fire mode operation, and where applicable, comply with the restart facilities in AS 1668.1; and
- (b) must operate at an obscuration level not greater than 0.5% per metre with compensation for external airborne contamination as necessary; and
- (c) must sample air within the *atrium* and in *storeys* where the bounding wall is set back more than 3.5 m from the *atrium well*; and
- (d) must be calibrated to compensate for smoke dilution where sampling occurs within return air path common to more than one room; and
- (e) may incorporate beam type detectors to sense smoke in an *atrium* in a Class 5, 6, 7 or 8 building with an *effective height* of not more than 25 m if—
 - (i) the beam detectors are located at intervals of not more than 3 *storeys*; and
 - (ii) arranged to scan at 90 degrees orientation to adjacent beam units.

Ancillary provisions

Deemed-to-Satisfy Provisions

4.3 Smoke detection in spaces separated from the atrium by bounding walls

Smoke detection systems must be located at all return and relief air openings associated with the building air-handling systems and be—

- (a) of the sampling type system as *required* in 4.2; or
- (b) of the point type photoelectric smoke detector.

4.4 Alarm systems

- (a) A break-glass fire alarm point must be provided at each door to a *fire-isolated stairway*, *fire-isolated ramp*, or *fire-isolated passageway*.
- (b) A staged alarm must be provided where an air sampling type smoke detection system is provided for the *atrium*, and must operate as follows:
 - (i) Alert building management when abnormal smoke levels of 0.03% obscuration per metre are detected.
 - (ii) Initiate a second alarm to management and start all smoke control systems including pressurisation of escape routes when smoke levels of 0.07% obscuration per metre are detected.
 - (iii) Automatically call the *fire brigade*, activate the emergency warning and intercom system, and deactivate all plant not necessary for fire safety within the building when smoke levels of 0.09% obscuration per metre are detected.
- (c) Beam and point type smoke detectors *required* must simultaneously operate all functions referred to above and activate at the level set out in AS 1670.1.

5. Emergency warning and intercom systems

All buildings containing an *atrium* must be provided with an emergency warning and intercom system which—

- (a) complies with AS 1670.4; and
- (b) incorporates visual warning devices that—
 - (i) operate upon the evacuation signal; and
 - (ii) display the words “EVACUATE” in red with letters conforming with the requirements of the *Deemed-to-Satisfy Provisions* of Part E4 for *exit* signs.

6. Standby power system

- (a) If a *required* path of travel to an *exit* is within an *atrium*, a suitable alternative power supply must be provided to operate *required* safety systems, including sprinkler systems and fire hydrant pumps, air handling systems, alarms, warning and communication systems and emergency lighting circuits.
- (b) The alternative power supply must—
 - (i) be connected *automatically* if the normal power supply fails; and
 - (ii) if located within the building, be separated from the remainder of the building by an enclosure with an FRL of at least 120/120/120; and
 - (iii) be connected to the safety systems by means of cabling complying with C2.13(c)(iii) and (iv).
- (c) The requirements of (a) are satisfied by—
 - (i) a single medium voltage supply taken from an electricity substation situated within, or adjacent to, the building concerned where the power supply to the substation consists of two or more high voltage cables each taking electricity from separate transformers; or
 - (ii) two or more medium voltage supplies each taking electricity from separate electricity substations situated—
 - (A) outside the building concerned; and
 - (B) at a suitable distance from each other; or
 - (iii) a single medium voltage supply taken from an electricity substation together with an electricity generating plant capable of—

Ancillary provisions

Deemed-to-Satisfy Provisions

- (A) generating a medium voltage supply; and
- (B) starting and taking the *required* electrical load within a period of not more than 30 seconds from the time of normal supply failure.

7. System for excluding smoke from fire-isolated exits

Required fire-isolated *exits* in a building containing an *atrium* must be protected from the entry of smoke in accordance with E2.2.

Part G4 Construction in alpine areas

Performance Requirements

GP4.1 External doorways

An external doorway from a building in an *alpine area* must be installed so that opening the door is not obstructed by snow or ice.

Application

GP4.1 applies to a building constructed in an *alpine area* and overrules other provisions of the BCA.

GP4.2 Structures forming pathways in snow conditions

A building in an *alpine area* containing external trafficable structures forming part of the means of egress must be constructed so that those structures remain, as far as practicable, useable under snow conditions.

Application

GP4.2 applies to a building constructed in an *alpine area* and overrules other provisions of the BCA.

GP4.3 Control of falling ice and snow

A building in an *alpine area* must be constructed so that snow or ice is not shed from the building onto the allotment, any adjoining allotment, road or public space in a location or manner that will—

- (a) obstruct a means of egress from any building to a road or *open space*; or
- (b) otherwise endanger people.

Application

GP4.3 applies to a building constructed in an *alpine area* and overrules other provisions of the BCA.

GP4.4 Fire safety systems in alpine areas

A building in an *alpine area* must have a *fire safety system* installed to—

- (a) facilitate fire-fighting operations; and
- (b) alert occupants in the event of an emergency.

Application

GP4.4 applies to a building constructed in an *alpine area* and overrules other provisions of the BCA.

Part G4 Construction in alpine areas

Deemed-to-Satisfy Provisions

G4.0 Deemed-to-Satisfy Provisions

- (a) Where a *Deemed-to-Satisfy Solution* is proposed, *Performance Requirements GP4.1* to *GP4.4* are satisfied by complying with—
 - (i) *G4.1* to *G4.9*; and
 - (ii) for a building containing an *occupiable outdoor area*, *Part G6*.
- (b) Where a *Performance Solution* is proposed, the relevant *Performance Requirements* must be determined in accordance with *A2.2(3)* and *A2.4(3)* as applicable.

G4.1 Application of Part

- (a) The *Deemed-to-Satisfy Provisions* of this Part apply to any building constructed in an *alpine area* in addition to other *Deemed-to-Satisfy Provisions* of the BCA.
- (b) Where any *Deemed-to-Satisfy Provisions* are in conflict, the provisions of this Part take precedence.

G4.2 * * * * *

This clause has deliberately been left blank.

G4.3 External doors

External doors which may be subject to the build-up of snow must—

- (a) open inwards or slide; and
- (b) if inward opening, be marked “OPEN INWARDS” on the inside face of the door in letters not less than 75 mm high in a colour contrasting with that of the background; and
- (c) be constructed so that the threshold is not less than 900 mm above the adjoining surface; and
- (d) if it serves a corridor or stairway, be positioned in an alcove or recess with—
 - (i) no horizontal dimensions of the alcove or recess less than twice the width of the door; and
 - (ii) the door positioned to open against a wall such that the distance from any part of its swing to the nearest point of entry of the stairway or corridor is not less than the width of the door.

G4.4 Emergency lighting

In a Class 2, 3, 5, 6, 7, 8 or 9 building or Class 4 part of a building, a system of emergency lighting must be installed in accordance with the *Deemed-to-Satisfy Provisions* of *Part E4*—

- (a) in every stairway (other than those within a *sole-occupancy unit* in a Class 2 or 3 building or Class 4 part of a building); and
- (b) in every *public corridor* or the like leading to an *exit*; and
- (c) externally above every doorway opening to a road or *open space*; and
- (d) in any *storey* of the building if illumination sufficient for safe egress will not be available under conditions of emergency.

G4.5 External trafficable structures

External stairways, ramps, access bridges or other trafficable structures serving the building must—

- (a) have a floor surface that consists of expanded mesh if it is used as a means of egress; and
- (b) have any *required* barrier designed so that its sides are not less than 75% open; and

Ancillary provisions

Deemed-to-Satisfy Provisions

- (c) for a stairway have, *goings* (G), *risers* (R) and slope relationship quantity (2R + G) in accordance with—
 - (i) Table D2.13; or
 - (ii) Table G4.5; and
- (d) for a ramp serving as an *exit* and not serving as an *accessible* ramp, have a gradient not steeper than 1:12; and
- (e) where a ramp is also serving as an *accessible* ramp under Part D3, be in accordance with AS 1428.1.

Table G4.5 Alternate stair riser and going dimensions (mm)

Riser (R)		Going (G)		Slope relationship (2R + G)	
Max	Min	Max	Min	Max	Min
150	115	375	355	675	605

G4.6 Clear space around buildings

A building must be so constructed that—

- (a) if any part of an *external wall* is more than 3.6 m above the natural ground level — the distance of that part from a boundary other than a road alignment is not less than 2.5 m plus an additional 100 mm for each 300 mm or part by which that part of the wall exceeds a height of 3.6 m; and
- (b) if an *exit* doorway discharges into a court between wings of a building and that area may be used for vehicle access to the building, the distance between wings must be not less than 4 m; and
- (c) where an *exit* doorway discharges opposite a feature that could entrap snow or an embankment that is more than 900 mm above the threshold of the doorway, a distance of not less than 4 m must be provided between the doorway and the feature.

G4.7 * * * * *

This clause has deliberately been left blank.

G4.8 Fire-fighting services and equipment

- (a) Every Class 2, 3, 5, 6, 7, 8 or 9 building must have—
 - (i) a manually operated fire alarm system with call-points complying with AS 1670.1; and
 - (ii) fire hydrants installed in accordance with E1.3(b); and
 - (iii) fire hose reels installed in accordance with E1.4(b) to (g), except that—
 - (A) in a Class 2 or 3 building—
 - (aa) for the purpose of E1.4(b), a *sole-occupancy unit* is considered to be a *fire compartment*; and
 - (bb) for the purpose of E1.4(c)(ii), a *sole-occupancy unit* may be served by a single fire hose reel located at the level of egress from that *sole-occupancy unit*; and
 - (cc) for the purpose of E1.4(f), a fire hose may pass through a doorway in bounding construction referred to in C3.11.
- (b) The requirements of (a)(iii) do not apply to a Class 8 *electricity network substation*.

G4.9 Fire orders

Every Class 2, 3 or 9 building must display a notice clearly marked “FIRE ORDERS” in suitable locations near the main entrance and on each *storey*, explaining—

- (a) the method of operation of the fire alarm system and the location of all call-points; and
- (b) the location and methods of operation of all fire-fighting equipment; and

Ancillary provisions

Deemed-to-Satisfy Provisions

- (c) the location of all *exits*; and
- (d) the procedure for evacuation of the building.

Part G5 Construction in bushfire prone areas

Performance Requirements

[NSW GP5.1](#)

[Qld GP5.1](#)

GP5.1 Bushfire resistance

A building that is constructed in a [designated bushfire prone area](#) must, to the degree necessary, be designed and constructed to reduce the risk of ignition from a bushfire, appropriate to the—

- (a) potential for ignition caused by burning embers, radiant heat or flame generated by a bushfire; and
- (b) intensity of the bushfire attack on the building.

Application

[GP5.1](#) only applies to—

- (a) a Class 2 or 3 building; or
- (b) a Class 10a building or deck associated with a Class 2 or 3 building, located in a [designated bushfire prone area](#).

Verification Methods

GV5 Buildings in bushfire prone areas

- (a) Compliance with [Performance Requirement GP5.1](#) is verified if the ignition probability for a building exposed to a design bushfire does not exceed 10%.
- (b) Bushfire design actions must be determined in consideration of the annual probability of a design bushfire derived from—
 - (i) assigning the building or structure with an importance level in accordance with [GV5\(c\)](#); and
 - (ii) determining the corresponding annual probability of exceedance in accordance with [Table GV5.1](#).
- (c) A building or structure's importance level must be identified as one of the following:
 - (i) Importance level 1 — where the building or structure presents a low degree of hazard to life and [other property](#) in the case of failure.
 - (ii) Importance level 2 — where the building or structure is not of importance level 1, 3 or 4 and is a Class 2 building accommodating 12 people or less.
 - (iii) Importance level 3 — where the building is designed to contain a large number of people and is a—
 - (A) Class 2 building accommodating more than 12 people; or
 - (B) Class 3 boarding house, guest house, hostel, lodging house or backpackers accommodation; or
 - (C) Class 3 residential part of a hotel or motel; or
 - (D) Class 3 residential part of a [school](#).
 - (iv) Importance level 4 — where the building or structure is—
 - (A) essential to emergency management or post-disaster recovery; or
 - (B) associated with hazardous facilities; or
 - (C) subject to a necessary 'defend in place' strategy and is a—
 - (aa) Class 3 accommodation building for the aged, children or people with disabilities; or
 - (bb) Class 3 residential part of a [health-care building](#) which accommodates members of staff; or
 - (cc) Class 3 residential part of a [detention centre](#); or

Ancillary provisions

(dd) building that operates in the event of a bushfire emergency, such as a public bushfire shelter.

Table GV5.1 Annual Probability of Exceedance (APE) for design bushfire actions

Importance level	Complex analysis APE for bushfire exposure	Simple analysis APE for weather conditions (design bushfire)
1	No requirement	No requirement
2	1:500	1:50
3	1:1000	1:100
4	1:2000	1:200

Note to Table GV5.1: Complex analysis must consider the probability of ignition, fire spread to the urban interface and penetration of the urban interface coincident with fire weather conditions.

- (d) The ignition probability for a building must be assessed by application of the following:
- (i) An event tree analysis of relevant bushfire scenarios.
 - (ii) Design bushfire conditions that include combinations of the following actions appropriate to the distance between the building and the bushfire hazard:
 - (A) Direct attack from airborne burning embers.
 - (B) Burning debris and accumulated embers adjacent to a building element.
 - (C) Radiant heat from a bushfire front.
 - (D) Direct flame attack from a bushfire front.
- (e) Applied fire actions must allow for reasonable variations in—
- (i) fire weather; and
 - (ii) vegetation, including fuel load, burning behaviour of vegetation (including the potential for crown fires); and
 - (iii) the distance of the building from vegetation; and
 - (iv) topography, including slopes and features that may shield; and
 - (v) ignition of adjacent buildings, building elements, plants, mulch and other materials; and
 - (vi) effective size of fire front; and
 - (vii) duration of exposure; and
 - (viii) flame height; and
 - (ix) flame tilt; and
 - (x) flame adhesion to sloping land; and
 - (xi) the height of the building and its elements.
- (f) The assessment process must include consideration of—
- (i) the probability of non-complying construction of critical aspects of an approved design; and
 - (ii) the probability of critical aspects of an approved design being fully functional during the life of the building; and
 - (iii) inclusion of safety factors; and
 - (iv) sensitivity analysis of critical aspects of a proposed design.

Part G5 Construction in bushfire prone areas

Deemed-to-Satisfy Provisions

G5.0 Deemed-to-Satisfy Provisions

- (a) Where a *Deemed-to-Satisfy Solution* is proposed, *Performance Requirements GP5.1* is satisfied by complying with *G5.1* and *G5.2*.
- (b) Where a *Performance Solution* is proposed, the relevant *Performance Requirements* must be determined in accordance with *A2.2(3)* and *A2.4(3)* as applicable.

G5.1 Application of Part

NSW G5.1

Qld G5.1

The *Deemed-to-Satisfy Provisions* of this Part apply to—

- (a) a Class 2 or 3 building; or
- (b) a Class 10a building or deck associated with a Class 2 or 3 building, located in a *designated bushfire prone area*.

G5.2 Protection

NSW G5.2

In a *designated bushfire prone area*—

- (a) a Class 2 or 3 building; or
- (b) a Class 10a building or deck associated with a Class 2 or 3 building, must comply with AS 3959.

Part G6 Occupiable outdoor areas

Deemed-to-Satisfy Provisions

Note:

Part G6 contains *Deemed-to-Satisfy Provisions* additional to those contained in Sections C, D, E, F and G for *occupiable outdoor areas*.

G6.1 Application of Part

- (a) The *Deemed-to-Satisfy Provisions* of this Part apply to buildings containing an *occupiable outdoor area* in addition to the other *Deemed-to-Satisfy Provisions* of the BCA.
- (b) The *Deemed-to-Satisfy Provisions* of this Part take precedence where there is a difference to the *Deemed-to-Satisfy Provisions* of Sections C, D, E, F and G.
- (c) Except for G6.2, the *Deemed-to-Satisfy Provisions* of this Part do not apply to—
 - (i) an *occupiable outdoor area* of a *sole-occupancy unit* in a Class 2 or 3 building, Class 9c building or Class 4 part of a building; or
 - (ii) an *occupiable outdoor area* with an area less than 10m².

G6.2 Fire hazard properties

- (a) Subject to (b), a lining, material or assembly in an *occupiable outdoor area* must comply with C1.10 as for an internal element.
- (b) The following *fire hazard properties* of a lining, material or assembly in an *occupiable outdoor area* are not *required* to comply with C1.10:
 - (i) *Average specific extinction area*.
 - (ii) *Smoke-Developed Index*.
 - (iii) *Smoke development rate*.
 - (iv) *Smoke growth rate index* (SMOGR_{A,RC}).

G6.3 Fire separation

For the purposes of the *Deemed-to-Satisfy Provisions* of C2.7, C2.8 and C2.9, a reference to a *storey* includes an *occupiable outdoor area*, however a *fire wall* cannot be used to separate an *occupiable outdoor area* into different *fire compartments*.

G6.4 Provision for escape

For the purposes of the *Deemed-to-Satisfy Provisions* of Part D1, a reference to a *storey* or room includes an *occupiable outdoor area*.

G6.5 Construction of exits

For the purposes of the *Deemed-to-Satisfy Provisions* of Part D2, a reference to a *storey* or room includes an *occupiable outdoor area*.

G6.6 Fire fighting equipment

Except for Clause 7(b)(i) of Specification E1.5, for the purposes of the *Deemed-to-Satisfy Provisions* of Part E1, a reference to a *storey* includes an *occupiable outdoor area*.

Note:

An *occupiable outdoor area* is not a *storey* for the purposes of Schedule 3 of the NCC and therefore is not included in the determination of *rise in storeys*.

Ancillary provisions

Deemed-to-Satisfy Provisions

G6.7 Lift installations

For the purposes of the *Deemed-to-Satisfy Provisions* of Part E3, a reference to a *storey* includes an *occupiable outdoor area*.

G6.8 Visibility in an emergency, exit signs and warning systems

For the purposes of the *Deemed-to-Satisfy Provisions* of Part E4, a reference to a *storey* includes an *occupiable outdoor area*.

G6.9 Light and ventilation

For the purposes of the *Deemed-to-Satisfy Provisions* of F4.4, F4.8 and F4.9, a reference to a room includes an *occupiable outdoor area*.

G6.10 Fire orders

For the purposes of the *Deemed-to-Satisfy Provisions* of G4.9, a reference to a *storey* includes an *occupiable outdoor area*.

Special use buildings

- Part H1** **Class 9b buildings**
- Part H2** **Public transport buildings**
- Part H3** **Farm buildings and farm sheds**

Section H Special use buildings

Part H1 Class 9b buildings

- H1.1 Application of Part
- H1.2 Separation
- H1.3 Proscenium wall construction
- H1.4 Seating area
- H1.5 Exits from stages
- H1.6 Access to platforms and lofts
- H1.7 Aisle lights

Part H2 Public transport buildings

- H2.1 Application of Part
- H2.2 Accessways
- H2.3 Ramps
- H2.4 Handrails and grabrails
- H2.5 Doorways and doors
- H2.6 Lifts
- H2.7 Stairways
- H2.8 Unisex accessible toilet
- H2.9 Location of accessible toilets
- H2.10 Symbols and signs
- H2.11 Tactile ground surface indicators
- H2.12 Lighting
- H2.13 Hearing augmentation
- H2.14 Emergency warning systems
- H2.15 Controls

Part H3 Farm buildings and farm sheds

- H3.1 Application of Part
- H3.2 Fire resistance and separation
- H3.3 Provision for escape
- H3.4 Construction of exits
- H3.5 Fixed platforms, walkways, stairways and ladders
- H3.6 Thresholds
- H3.7 Swinging doors
- H3.8 Fire fighting equipment
- H3.9 Fire hydrants and water supplies
- H3.10 Fire hose reels
- H3.11 Portable fire extinguishers
- H3.12 Emergency lighting requirements
- H3.13 Exit signs
- H3.14 Direction signs
- H3.15 Design and operation of exit signs
- H3.16 Sanitary facilities
- H3.17 Height of rooms and other spaces
- H3.18 Artificial lighting

Specification H1.3 Construction of proscenium walls

1. Scope
2. Separation of stage areas, etc
3. Proscenium wall construction
4. Combustible materials not to cross proscenium wall

5. Protection of openings in proscenium wall
6. Proscenium curtains

Part H1 Class 9b buildings

Deemed-to-Satisfy Provisions

Note.

Part H1 contains *Deemed-to-Satisfy Provisions* additional to those contained in Sections C, D and E for Class 9b buildings.

H1.1 Application of Part

NSW H1.1

- (a) The *Deemed-to-Satisfy Provisions* of this Part apply to every enclosed Class 9b building or part of a building which—
- (i) is a *school* assembly, church or community hall with a *stage* and any *backstage* area with a total *floor area* of more than 300 m²; or
 - (ii) otherwise, has a *stage* and any *backstage* area with a total *floor area* of more than 200 m²; or
 - (iii) has a *stage* with an associated rigging loft.
- (b) Notwithstanding (a)—
- (i) H1.4 applies to every open or enclosed Class 9b building; and
 - (ii) H1.7 applies to every enclosed Class 9b building.

H1.2 Separation

A theatre, public hall or the like must—

- (a) have a sprinkler system (other than a FPAA101D or FPAA101H system) complying with [Specification E1.5](#); or
- (b) have the *stage*, *backstage* area and accessible under *stage* area separated from the audience by a proscenium wall in accordance with H1.3.

H1.3 Proscenium wall construction

A proscenium wall must comply with [Specification H1.3](#).

H1.4 Seating area

In a seating area—

- (a) the gradient of the floor surface must not be steeper than 1 in 8, or the floor must be stepped so that—
 - (i) a line joining the nosings of consecutive steps does not exceed an angle of 30° to the horizontal; and
 - (ii) the height of each step in the stepped floor is not more than 600 mm; and
 - (iii) the height of any opening in such a step is not more than 125 mm; and
- (b) if an aisle divides the stepped floor and the difference in level between any 2 consecutive steps—
 - (i) exceeds 230 mm but not 400 mm — an intermediate step must be provided in the aisle; and
 - (ii) exceeds 400 mm — 2 equally spaced intermediate steps must be provided in the aisle; and
 - (iii) the going of intermediate steps must be not less than 270 mm and such as to provide as nearly as practicable equal treads throughout the length of the aisle; and
- (c) the clearance between rows of fixed seats used for viewing performing arts, sport or recreational activities must be not less than—
 - (i) 300 mm if the distance to an aisle is not more than 3.5 m; or
 - (ii) 500 mm if the distance to an aisle is more than 3.5 m.

Special use buildings

Deemed-to-Satisfy Provisions

H1.5 Exits from stages

- (a) The path of travel to an *exit* from a *stage* or performing area must not pass through the proscenium wall if the *stage* area is separated from the audience area with a proscenium wall.
- (b) *Required exits* from *backstage* and under-*stage* areas must be independent of those provided for the audience area.

H1.6 Access to platforms and lofts

A stairway that provides access to a service platform, rigging loft, or the like, must comply with AS 1657.

H1.7 Aisle lights

In every enclosed Class 9b building, where in any part of the auditorium, the general lighting is dimmed or extinguished during public occupation and the floor is stepped or is inclined at a slope steeper than 1 in 12, aisle lights must be provided to illuminate the full length of the aisle and tread of each step.

Part H2 Public transport buildings

Deemed-to-Satisfy Provisions

Note:

Part H2 contains *Deemed-to-Satisfy Provisions* for Class 9b and Class 10 public transport buildings additional to those contained in Parts D3, E3 and F2 that apply to public transport buildings.

H2.1 Application of Part

- (a) The *Deemed-to-Satisfy Provisions* of this Part apply to the passenger use areas of a Class 9b or Class 10 building used for public transport.
- (b) The *Deemed-to-Satisfy Provisions* of this Part take precedence where there is a difference to the *Deemed-to-Satisfy Provisions* of Parts D3, E3 and F2.
- (c) For an airport that does not accept regular public transport services, as defined in the Disability Standards for Accessible Public Transport 2002, only H2.8, H2.9, H2.10, H2.11, H2.12 and H2.13 of this Part apply.
- (d) **Exemption 1** to A6.0(1) does not apply to this Part.

H2.2 Accessways

- (a) An *accessway* must comply with AS 1428.2.
- (b) If an *accessway* branches into 2 or more parallel tracks—
 - (i) the ends of each track must be on the main pedestrian traffic routes; and
 - (ii) the parallel tracks must have equal convenience and be located as close as practicable to the main pedestrian branch.
- (c) The minimum unobstructed width of an *accessway* must be 1.2 m, except that—
 - (i) the minimum unobstructed width of a moving walkway forming part of an *accessway* may be not less than 850 mm; and
 - (ii) the minimum unobstructed width of a doorway in an *accessway* may be not less than 850 mm.
- (d) Poles, columns, stanchions, bollards and fixtures must not project into an *accessway*.
- (e) Obstacles that abut an *accessway* must have a *luminance contrast* with a background of not less than 30%.
- (f) Manoeuvring areas that allow a 180 degree wheelchair turn must comply with clause 6.2 of AS 1428.2.
- (g) A passing area must be provided at least every 6 m along any two-way *accessway* that is less than 1800 mm wide.
- (h) Ground and floor surfaces must comply with clause 9 of AS 1428.2 and AS 1428.1. Supplement 1 provides criteria for the selection of floor surfaces.
- (i) The requirements of D3.3(c)(ii) do not apply to Class 9b or Class 10 public transport buildings.

H2.3 Ramps

- (a) A ramp forming part of an *accessway* must comply with clause 8 of AS 1428.2.
- (b) The requirements of D3.11(a) do not apply to Class 9b or Class 10 public transport buildings.

H2.4 Handrails and grabrails

- (a) A handrail must comply with clause 10.1 of AS 1428.2.
- (b) Handrails must be placed along an *accessway* wherever passengers are likely to require additional support or passive guidance.
- (c) A grabrail must comply with clause 10.2 of AS 1428.2.
- (d) A grabrail or handrail must be provided at fixed locations where passengers are required to pay fares.

Special use buildings

Deemed-to-Satisfy Provisions

H2.5 Doorways and doors

Doorways and doors must comply with clause 11 (except clause 11.5.2) of AS 1428.2.

H2.6 Lifts

Lift facilities must comply with AS 1735.12.

H2.7 Stairways

Stairs must comply with—

- (a) clause 9.1 of AS 1428.1, including the notes; and
- (b) clause 9.2 of AS 1428.1; and
- (c) clause 13.2, 13.3 and Figures 8 and 9 of AS 1428.2.

H2.8 Unisex accessible toilet

If toilets are provided, there must be at least one unisex *accessible* toilet without an airlock that complies with AS 1428.1 clause 10, sanitary facilities.

H2.9 Location of accessible toilets

Accessible toilets must be in the same location as other toilets.

H2.10 Symbols and signs

- (a) The international symbols for accessibility and deafness in accordance with clauses 14.2 and 14.3 of AS 1428.1 must be used to identify an *accessway* and which facilities and boarding points are *accessible*.
- (b) Signs must be placed in accordance with clause 17.4 of AS 1428.2.
- (c) The size of accessibility symbols must comply with Table 1 of AS 1428.2.
- (d) The symbol for accessibility must incorporate directional arrows and words or, if possible, pictograms, to show passengers the way to *accessible* facilities such as toilets.
- (e) Signs must comply with clause 17.1 and Figure 30 of AS 1428.2.
- (f) If a sign incorporates raised lettering or symbols, they must be at least 0.8 mm above the surface of the sign.
- (g) If an operator or provider supplements a notice with braille characters, they must be placed to the left of the raised characters.

H2.11 Tactile ground surface indicators

Tactile ground surface indicators must be installed in accordance with AS 1428.4 on an *accessway* and must indicate changes of direction in accordance with clause 18.1 of AS 1428.2.

H2.12 Lighting

Any lighting provided must comply with minimum levels of maintenance illumination for various situations shown in the notes to clause 19.1 of AS 1428.2.

H2.13 Hearing augmentation

If a public address system is installed, it must comply with clause 21.1 of AS 1428.2.

H2.14 Emergency warning systems

- (a) If an emergency warning system is installed, it must comply with clause 18.2.1, 18.2.2 and 18.2.3 of AS 1428.2.
- (b) In the event of an emergency, provision must be made for people with vision impairment to locate the *exit* path.

Special use buildings

Deemed-to-Satisfy Provisions

H2.15 Controls

Controls must comply with clause 11 of AS 1428.1.

Part H3 Farm buildings and farm sheds

Deemed-to-Satisfy Provisions

SA Part H3

Note.

Part H3 contains *Deemed-to-Satisfy Provisions* additional to those contained in Sections C, D, E and F for *farm buildings* and *farm sheds*.

H3.1 Application of Part

- (a) The *Deemed-to-Satisfy Provisions* of this Part apply to *farm buildings* and *farm sheds*.
- (b) The *Deemed-to-Satisfy Provisions* of this Part take precedence where there is a difference to the *Deemed-to-Satisfy Provisions* of Sections C, D, E and F.
- (c) H3.1 to H3.5, H3.8 and H3.11 to H3.18 apply to a *farm shed*.
- (d) H3.1, H3.3, H3.5 to H3.7, H3.9 to H3.12, H3.14, H3.15 and H3.18 apply to a *farm building*.

H3.2 Fire resistance and separation

A *farm shed* need not comply with the provisions of Parts C1, C2 and C3, except for C1.11, if it is separated from any other building or allotment boundary by a distance of not less than 6 m.

H3.3 Provision for escape

- (a) Except for D1.2, D1.4 to D1.6, D1.9, D1.10(a), D1.13(c), D1.14 and D1.15, the *Deemed-to-Satisfy Provisions* of D1 do not apply to a *farm shed*.
- (b) An *open space* adjacent to a *farm building* or a *farm shed* need not be directly connected with a public road.

H3.4 Construction of exits

Except for D2.13, D2.14, D2.16, D2.17 and D2.24, the *Deemed-to-Satisfy Provisions* of Part D2 do not apply to a *farm shed*.

H3.5 Fixed platforms, walkways, stairways and ladders

A fixed platform, stairway, ladder and any going and riser, landing, handrail or barrier may comply with AS 1657 in lieu of D2.13, D2.14, D2.16 and D2.17 where it serves a *farm building* or a *farm shed*.

H3.6 Thresholds

The threshold of a doorway that serves an area not *required* to be *accessible* by D3.1 in a *farm building* need not comply with D2.15 where the door sill is not more than 700 mm above the finished surface of the ground, floor or the like, to which the doorway opens.

H3.7 Swinging doors

A swinging door in a *required exit* or forming part of a *required exit* need not swing in the direction of egress if it serves a *farm building*.

H3.8 Fire fighting equipment

The *Deemed-to-Satisfy Provisions* of E1 do not apply to a *farm shed*.

H3.9 Fire hydrants and water supplies

- (a) A *farm building*—
 - (i) with a total *floor area* greater than 500 m²; and

Special use buildings

Deemed-to-Satisfy Provisions

- (ii) located where a *fire brigade station* is—
 - (A) not more than 50 km from the building as measured along roads; and
 - (B) equipped with equipment capable of utilising a fire hydrant,
 must be—
 - (iii) provided with a fire hydrant system installed in accordance with AS 2419.1, except reference to '4 hours' water supply in clause 4.2 is replaced with '2 hours'; or
 - (iv) located on the same allotment as an access point to a water supply which—
 - (A) has a minimum total capacity of 144000 litres; and
 - (B) is situated so as to enable emergency services vehicles access to within 4 m; and
 - (C) is located within 60 m of the building and not more than 90 m from any part of the building.
- (b) For the purposes of (a)(iv), water supply for a *farm building* must consist of one or any number of the following:
- (i) A water storage tank.
 - (ii) A dam.
 - (iii) A reservoir.
 - (iv) A river.
 - (v) A lake.
 - (vi) A bore.
 - (vii) A sea.
- (c) If the whole or part of the water supply referred to in (a)(iv) is contained in a water storage tank, it must be—
- (i) located not less than 10 m from the building; and
 - (ii) fitted with at least one small bore suction connection and one large bore suction connection where—
 - (A) each suction connection is located in a position so as to enable emergency service vehicles access to within 4 m; and
 - (B) the suction connections are located not less than 10 m from the building; and
 - (C) 'small bore suction connection' and 'large bore suction connection' have the meanings contained in AS 2419.1.

H3.10 Fire hose reels

A fire hose reel system need not be provided to serve a *farm building* where portable fire extinguishers are installed in accordance with H3.11.

H3.11 Portable fire extinguishers

- (a) A *farm building* not provided with a fire hose reel system in accordance with E1.4 must be provided with—
- (i) one portable fire extinguisher rated at not less than 5ABE in each room containing flammable materials or electrical equipment; and
 - (ii) one portable fire extinguisher rated at not less than 4A60BE adjacent to every *required exit* door; and
 - (iii) location signs complying with clauses 3.3 to 3.9 of AS 2444 above each *required* portable fire extinguisher.
- (b) A *farm shed* must be provided with not less than one portable fire extinguisher for every 500 m² of *floor area* or part thereof, distributed as evenly as practicable throughout the building.
- (c) A portable fire extinguisher *required* by (b) must be—
- (i) of ABE type; and
 - (ii) not less than 4.5 kg in size; and
 - (iii) installed in accordance with Section 3 of AS 2444.

Special use buildings

Deemed-to-Satisfy Provisions

H3.12 Emergency lighting requirements

- (a) An emergency lighting system need not be installed in a *farm building*—
 - (i) with no artificial lighting as permitted by H3.18; or
 - (ii) with artificial lighting where, if that lighting fails due to an emergency, automatic power supply to the building is provided by a fuel-driven generator.
- (b) An emergency lighting system need not be installed in a *farm shed*.

H3.13 Exit signs

An *exit* serving a *farm shed* need not be provided with an *exit* sign where the *exit* is a permanent opening not less than 2 m wide.

H3.14 Direction signs

In a *farm building* or a *farm shed*, if an *exit* is not readily apparent to persons occupying or visiting the building, *exit* signs complying with H3.15 must be installed in appropriate positions in corridors, hallways, lobbies, and the like, indicating the direction to a *required exit*.

H3.15 Design and operation of exit signs

- (a) In a *farm building*, each *required exit* sign provided under E4.5 and H3.14 need not comply with E4.8 if—
 - (i) the use of illuminated *exit* signs may adversely impact the behaviour or welfare of animals being kept in the building; and
 - (ii) non-illuminated *exit* signs are installed in accordance with the requirements of Appendix D of AS/NZS 2293.1 as for an externally illuminated *exit* sign, and clauses 5.6 and 5.8 of AS/NZS 2293.1.
- (b) In a *farm shed*, each *required exit* sign provided under E4.5 and H3.14 need not comply with E4.8 if—
 - (i) non-illuminated *exit* signs are installed in accordance with the requirements of Appendix D of AS/NZS 2293.1 as for an externally illuminated *exit* sign, and clauses 5.6 and 5.8 of AS/NZS 2293.1; and
 - (ii) the maximum viewing distance in clause 5.6 of AS/NZS 2293.1 is not more than 24 m.

H3.16 Sanitary facilities

F2.3 does not apply to a *farm shed*.

H3.17 Height of rooms and other spaces

F3.1 does not apply to a *farm shed* which has ceiling heights not less than—

- (a) in a room, corridor, passageway or the like — 2.1 m; and
- (b) in a room or space with a sloping ceiling or projections — a height of not less than 2.1 m for at least two-thirds of the *floor area* of the room or space, and when calculating the *floor area* of the room or space, any part that has a ceiling height of less than 1.5 m is not included; and
- (c) in a stairway, ramp, landing or the like — 2.0 m measured vertically above the nosing line of stairway treads or the floor surface of the ramp, landing or the like.

H3.18 Artificial lighting

- (a) An artificial lighting system need not be provided in a *farm building* where—
 - (i) occupants are provided with visibility sufficient for safe movement through suitable alternative means; and
 - (ii) the use of artificial lighting could adversely affect the function of the building including, but not limited to—
 - (A) the behaviour or welfare of animals being kept in the building; or
 - (B) the cultivating or propagating of plants or fungi.
- (b) An artificial lighting system need not be provided in a *farm shed*.

Specification H1.3

Construction of proscenium walls

Deemed-to-Satisfy Provisions

1. Scope

This Specification contains the requirements for the construction of proscenium walls for theatres, public halls, or the like.

2. Separation of stage areas, etc

- (a) Dressing rooms, scene docks, property rooms, workshops, associated store rooms and other ancillary areas must be—
 - (i) located on the *stage* side of the proscenium wall; and
 - (ii) separated from corridors and the like by construction having an FRL of not less than 60/60/60, and if of *lightweight construction*, complying with [Specification C1.8](#).
- (b) The *stage* and *backstage* must be separated from other parts of the building other than the audience seating area by construction having an FRL of not less than 60/60/60, and if of *lightweight construction*, complying with [Specification C1.8](#).
- (c) Any doorway in the construction referred to in paragraphs (a) and (b) must be protected by a *self-closing* –/60/30 fire door.

3. Proscenium wall construction

A proscenium wall must—

- (a) extend to the underside of the roof covering or the underside of the structural floor next above; and
- (b) have an FRL of not less than 60/60/60, and if of *lightweight construction*, comply with [Specification C1.8](#).

4. Combustible materials not to cross proscenium wall

Timber purlins or other *combustible* material must not pass through or cross any proscenium wall.

5. Protection of openings in proscenium wall

Every opening in a proscenium wall must be protected—

- (a) at the principal opening, by a curtain in accordance with [Clause 6](#) which is—
 - (i) capable of closing the proscenium opening within 35 seconds either by gravity slide or motor assisted mechanisms; and
 - (ii) operated by a system of *automatic* heat activated devices, manually operated devices or push button emergency devices; and
 - (iii) able to be operated from either the *stage* side or the audience side of the curtain; and
- (b) at any doorway in the wall, by a *self-closing* –/60/30 fire door.

6. Proscenium curtains

A curtain *required* by [Clause 5](#) must be—

- (a) a fire safety curtain—
 - (i) made of *non-combustible* material; and
 - (ii) capable of withstanding a pressure differential of 0.5 kPa over its entire surface area; and
 - (iii) so fitted that when fully lowered it inhibits the penetration of smoke around the perimeter of the opening, from the *stage*; or
- (b) a curtain—

Special use buildings

Deemed-to-Satisfy Provisions

- (i) having *fire hazard properties* complying with [Specification C1.10](#); and
- (ii) protected by a deluge system of open sprinklers installed along the full width of the curtain.

* * * * *

Part I1 * * * * *

Part I2 * * * * *

Section I * * * * *

Part I1 * * * * *

Part I2 * * * * *

Part I1

* * * * *

The content of [Part I1](#), which existed in BCA 2013, has been removed. The Part number [Part I1](#) has been retained so as not to change the numbering of the current BCA from that of BCA 2013.

Part I2

* * * * *

The content of [Part I2](#), which existed in BCA 2013, has been removed. The Part number [Part I2](#) has been retained so as not to change the numbering of the current BCA from that of BCA 2013.

Energy efficiency

Section J	Energy efficiency
Part J0	Energy efficiency
Part J1	Building fabric
Part J2	* * * * *
Part J3	Building sealing
Part J4	* * * * *
Part J5	Air-conditioning and ventilation systems
Part J6	Artificial lighting and power
Part J7	Heated water supply and swimming pool and spa pool plant
Part J8	Facilities for energy monitoring

Section J Energy efficiency

Section J Energy efficiency

Performance Requirements

JP1 Energy use

Verification Methods

JV1 NABERS Energy for Offices

JV2 Green Star

JV3 Verification using a reference building

JV4 Building envelope sealing

Specification JVa Additional requirements

1. Scope
2. Additional requirements — general
3. Additional requirements — NABERS Energy for Offices
4. Additional requirements — Green Star

Specification JVb Modelling parameters

1. Scope
2. Reference building
3. Proposed building and reference building
4. Services — proposed and reference building

Specification JVc Modelling profiles

1. Scope
2. Modelling profiles

Part J0 Energy efficiency

J0.0 Deemed-to-Satisfy Provisions

J0.1 Application of Section J

J0.2 Heating and cooling loads of sole-occupancy units of a Class 2 building or a Class 4 part

J0.3 Ceiling fans

J0.4 Roof thermal breaks

J0.5 Wall thermal breaks

Part J1 Building fabric

J1.0 Deemed-to-Satisfy Provisions

J1.1 Application of Part

J1.2 Thermal construction — general

J1.3 Roof and ceiling construction

J1.4 Roof lights

J1.5 Walls and glazing

J1.6 Floors

Part J2 * * * * *

Part J3 Building sealing

J3.0 Deemed-to-Satisfy Provisions

J3.1 Application of Part

J3.2 Chimneys and flues

J3.3 Roof lights

J3.4 Windows and doors

J3.5 Exhaust fans

- J3.6 Construction of ceilings, walls and floors
- J3.7 Evaporative coolers

Part J4 * * * * *

Part J5 Air-conditioning and ventilation systems

- J5.0 Deemed-to-Satisfy Provisions
- J5.1 Application of Part
- J5.2 Air-conditioning system control
- J5.3 Mechanical ventilation system control
- J5.4 Fan systems
- J5.5 Ductwork insulation
- J5.6 Ductwork sealing
- J5.7 Pump systems
- J5.8 Pipework insulation
- J5.9 Space heating
- J5.10 Refrigerant chillers
- J5.11 Unitary air-conditioning equipment
- J5.12 Heat rejection equipment

Part J6 Artificial lighting and power

- J6.0 Deemed-to-Satisfy Provisions
- J6.1 Application of Part
- J6.2 Artificial lighting
- J6.3 Interior artificial lighting and power control
- J6.4 Interior decorative and display lighting
- J6.5 Exterior artificial lighting
- J6.6 Boiling water and chilled water storage units
- J6.7 Lifts
- J6.8 Escalators and moving walkways

Part J7 Heated water supply and swimming pool and spa pool plant

- J7.0 Deemed-to-Satisfy Provisions
- J7.1 * * * * *
- J7.2 Heated water supply
- J7.3 Swimming pool heating and pumping
- J7.4 Spa pool heating and pumping

Part J8 Facilities for energy monitoring

- J8.0 Deemed-to-Satisfy Provisions
- J8.1 Application of Part
- J8.2 * * * * *
- J8.3 Facilities for energy monitoring

Specification J1.2 Material properties

1. Scope
2. Construction Deemed-to-Satisfy

Specification J1.5a Calculation of U-Value and solar admittance

1. Scope
2. General
3. U-Value — Method 1 (Single Aspect)
4. U-Value — Method 2 (Multiple Aspects)
5. Solar admittance — Method 1 (Single Aspect)
6. Solar admittance — Method 2 (Multiple Aspects)
7. Shading

Specification J1.5b Spandrel panel thermal performance

1. Scope
2. Spandrel panel R-Value: Calculation method 1
3. Spandrel panel R-Value: Calculation method 2

Specification J1.6 Sub-floor thermal performance

1. Scope
2. Sub-floor thermal performance

Specification J6 Lighting and power control devices

1. Scope
2. Lighting timers
3. Time switch
4. Motion detectors
5. Daylight sensor and dynamic lighting control device

Section J Energy efficiency

[NSW Section J](#)

[NT Section J](#)

[Qld Section J](#)

Note:

From 1 May 2019 to 30 April 2020 Section J of NCC 2016 Volume One Amendment 1 may apply instead of [Section J](#) of NCC 2019. From 1 May 2020 [Section J](#) of NCC 2019 applies.

Performance Requirements

JP1 Energy use

A building, including its [services](#), must have features that facilitate the efficient use of energy appropriate to—

- (a) the function and use of the building; and
- (b) the level of human comfort required for the building use; and
- (c) solar radiation being—
 - (i) utilised for heating; and
 - (ii) controlled to minimise energy for cooling; and
- (d) the energy source of the [services](#); and
- (e) the sealing of the building [envelope](#) against air leakage; and
- (f) for a [conditioned space](#), achieving an hourly [regulated energy](#) consumption, averaged over the annual [hours of operation](#), of not more than—
 - (i) for a Class 6 building, 80 kJ/m².hr; and
 - (ii) for a Class 5, 7b, 8 or 9a building other than a [ward area](#), or a Class 9b [school](#), 43 kJ/m².hr; and
 - (iii) for all other building classifications, other than a [sole-occupancy unit](#) of a Class 2 building or a Class 4 part of a building, 15 kJ/m².hr.

Verification Methods

JV1 NABERS Energy for Offices

[ACT Appendix](#)

- (a) For a Class 5 building, compliance with [JP1](#) is verified when—
 - (i) a minimum 5.5-star [NABERS Energy for Offices](#) base building Commitment Agreement is obtained; and
 - (ii) the energy model required for (i) demonstrates—
 - (A) the base building's greenhouse gas emissions are not more than 67% of the 5.5-star level when excluding—
 - (aa) tenant supplementary heating and cooling systems; and
 - (bb) external lighting; and
 - (cc) [carpark services](#); and
 - (B) a [thermal comfort level](#) of between a [Predicted Mean Vote](#) of -1 to +1 is achieved across not less than 95% of the [floor area](#) of all occupied zones for not less than 98% of the annual [hours of operation](#) of the building; and
 - (iii) the building complies with the additional requirements in [Specification JVa](#).
- (b) The calculation method for (a) must comply with ANSI/ASHRAE Standard 140.

JV2 Green Star

ACT Appendix

- (a) For a Class 3, 5, 6, 7, 8 or 9 building, or common area of a Class 2 building, compliance with JP1 is verified when—
- (i) the building complies with the simulation requirements, and is registered, for a *Green Star* – Design & As-Built rating; and
 - (ii) the *annual greenhouse gas emissions* of the proposed building are less than 90% of the *annual greenhouse gas emissions* of the *reference building*; and
 - (iii) in the proposed building, a *thermal comfort level* of between a *Predicted Mean Vote* of -1 to +1 is achieved across not less than 95% of the *floor area* of all occupied zones for not less than 98% of the annual *hours of operation* of the building; and
 - (iv) the building complies with the additional requirements in *Specification JVa*.
- (b) The calculation method used for (a) must comply with—
- (i) ANSI/ASHRAE Standard 140; and
 - (ii) *Specification JVb*.

JV3 Verification using a reference building

- (a) For a Class 3, 5, 6, 7, 8 or 9 building or common area of a Class 2 building, compliance with JP1 is verified when—
- (i) it is determined that the *annual greenhouse gas emissions* of the proposed building are not more than the *annual greenhouse gas emissions* of a *reference building* when—
 - (A) the proposed building is modelled with the proposed *services*; and
 - (B) the proposed building is modelled with the same *services* as the *reference building*; and
 - (ii) in the proposed building, a *thermal comfort level* of between a *Predicted Mean Vote* of -1 to +1 is achieved across not less than 95% of the *floor area* of all occupied zones for not less than 98% of the annual *hours of operation* of the building; and
 - (iii) the building complies with the additional requirements in *Specification JVa*.
- (b) The *annual greenhouse gas emissions* of the proposed building may be offset by—
- (i) *renewable energy* generated and used on *site*; and
 - (ii) another process such as reclaimed energy, used on *site*.
- (c) The calculation method used for (a) and (b) must comply with—
- (i) ANSI/ASHRAE Standard 140; and
 - (ii) *Specification JVb*.

JV4 Building envelope sealing

Compliance with JP1(e) is verified when the *envelope* is sealed at an air permeability rate, tested in accordance with Method 1 of AS/NZS ISO 9972, of not more than—

- (a) for a Class 2 building or a Class 4 part of a building, 10 m³/hr.m² at 50 Pa reference pressure; or
- (b) for a Class 5, 6, 8 or 9a or 9b building, other than a *ward area*, in *climate zones* 1, 7 and 8, 5 m³/hr.m² at 50 Pa reference pressure; or
- (c) for a Class 3 or 9c building, or a Class 9a *ward area* in *climate zones* 1, 3, 4, 6, 7 and 8, 5 m³/hr.m² at 50 Pa reference pressure.

Note:

JV4 is only one way of achieving compliance with JP1(e). Other ways of complying include the following:

- (a) The relevant provisions of *Part J3*.
- (b) A *Performance Solution* that uses one of the other NCC *Assessment Methods* which verifies that compliance with JP1(e) will be achieved.

Specification JVa

Additional requirements

*ACT Appendix***1. Scope**

This Specification contains requirements that must be complied with in addition to the modelling requirements of [JV1](#), [JV2](#) and [JV3](#).

2. Additional requirements — general

In addition to the modelling requirements for [JV1](#), [JV2](#) and [JV3](#), a building must comply with—

- (a) for general thermal construction, [J1.2](#); and
- (b) for floor edge insulation, [J1.6\(b\)](#) and [J1.6\(c\)](#); and
- (c) for building sealing, [JV4](#) or [J3](#); and
- (d) for deactivation, control and insulation of *air-conditioning* and mechanical ventilation systems—
 - (i) [J5.2\(a\)\(i\)](#); and
 - (ii) [J5.2\(a\)\(ii\)\(A\)](#); and
 - (iii) [J5.2\(a\)\(iv\)](#); and
 - (iv) [J5.2\(a\)\(vi\)](#); and
 - (v) [J5.2\(b\)](#); and
 - (vi) [J5.2\(c\)](#); and
 - (vii) [J5.3\(b\)](#); and
 - (viii) [J5.3\(d\)](#); and
 - (ix) [J5.5](#); and
 - (x) [J5.6](#); and
 - (xi) [J5.8](#); and
- (e) for testing package *air-conditioning* equipment not less than 65 kW_r, AS/NZS 3823.1.2 at test condition T1; and
- (f) for testing a refrigeration chiller, AHRI 551/591; and
- (g) for interior artificial lighting and power control, [J6.3](#); and
- (h) for interior decorative and display lighting, [J6.4](#); and
- (i) for artificial lighting around the exterior of a building, [J6.5](#); and
- (j) for boiling water and chilled water storage units, [J6.6](#); and
- (k) for deactivation of *swimming pool* heating and pumping, [J7.3\(b\)\(ii\)](#) and [J7.3\(c\)](#); and
- (l) for deactivation of spa pool heating and pumping, [J7.4\(b\)\(ii\)](#) and [J7.4\(c\)](#); and
- (m) for facilities for energy monitoring, [Part J8](#); and
- (n) for deactivation of fixed outdoor space heating appliances, clause [J5.9\(c\)](#).

3. Additional requirements — NABERS Energy for Offices

Where not included in the building energy simulation to satisfy [JV1\(a\)](#), compliance must be achieved with—

- (a) for a tenant supplementary heating and cooling system, [J5.7](#); and
- (b) for *carpark* ventilation and lighting—
 - (i) [J5.3](#); and
 - (ii) [J5.4](#); and

- (iii) [J6.2](#); and
- (iv) [J6.3](#); and
- (c) for heating, cooling and ventilation equipment not covered by the [NABERS Energy for Offices](#) base building rating, [Part J5](#); and
- (d) for artificial lighting not covered by the [NABERS Energy for Offices](#) base building rating, [Part J6](#).

4. Additional requirements — Green Star

Where not included in the building energy simulation to satisfy [JV2\(a\)](#), compliance must be achieved with—

- (a) for heating, cooling and ventilation equipment outside the scope of the [Green Star](#) model, [Part J5](#); and
- (b) for artificial lighting outside the scope of the [Green Star](#) model, [Part J6](#).

Specification JVb

Modelling parameters

ACT Appendix

1. Scope

This Specification contains the *required* modelling parameters for *JV2* and *JV3*.

2. Reference building

The *annual greenhouse gas emissions* must be calculated for the *reference building* in accordance with the following:

- (a) The *reference building* must—
 - (i) comply with *Deemed-to-Satisfy Provisions* in *Parts J1 to J7*; and
 - (ii) have the minimum amount of mechanical ventilation *required* by *Part F4*.
- (b) The *external walls* must have a solar absorptance of 0.6.
- (c) The *air-conditioning* must—
 - (i) for 98% of the annual *hours of operation*, achieve temperatures between—
 - (A) 18°CDB to 25°CDB for *conditioned spaces* with transitory occupancy; and
 - (B) subject to (ii), 21°CDB to 24°CDB in all other *conditioned spaces*; and
 - (ii) if the proposed building has no mechanically provided cooling or has mixed mode cooling, have the same method of control and control set points for non-mechanical cooling as the proposed building.
- (d) The infiltration rate in each zone must be—
 - (i) 0.7 air changes per hour throughout all zones when there is no mechanically supplied *outdoor air*; and
 - (ii) 0.35 air changes per hour at all other times.
- (e) The artificial lighting must achieve the *required* maximum *illumination power density* in *Part J6* without applying the control device adjustment factors.
- (f) *Minimum Energy Performance Standards* must be applied to *services* not covered by *Parts J5 to J7*.

3. Proposed building and reference building

The *annual greenhouse gas emissions* must be calculated for the proposed building and the *reference building* using the same:

- (a) **General—**
 - (i) *annual greenhouse gas emissions* calculation method; and
 - (ii) greenhouse gas emissions factors based on either—
 - (A) the factors in *Table 3a*; or
 - (B) the current full fuel cycle emissions factors published by the Australian Government, except, where the greenhouse gas intensity of electricity is less than half the greenhouse gas intensity of natural gas—
 - (aa) electricity is to be weighted as 1; and
 - (bb) natural gas is to be weighted as 2; and

Table 3a Greenhouse gas emissions factors (kgCO₂-e/GJ)

Energy Source	ACT	NSW	NT	Qld	SA	Tas	Vic	WA
Electricity	-	256	201	256	170	61	323	207
Natural gas	-	51.53	51.53	51.53	51.53	51.53	51.53	51.53

Note to Table 3a: National emissions factors are not applicable to calculations for buildings in the ACT as they

Energy efficiency

do not take into account investments in renewable electricity generation in the national electricity market made by the ACT. Values for the ACT can be found in the [ACT Appendix](#).

- (iii) location, being either—
 - (A) the location where the building is to be constructed if appropriate climatic data is available; or
 - (B) the nearest location with similar climatic conditions, for which climatic data is available; and
 - (iv) adjacent structures and features; and
 - (v) orientation; and
 - (vi) building form, including—
 - (A) the roof geometry; and
 - (B) the floor plan; and
 - (C) the number of [storeys](#); and
 - (D) the ground to lowest floor arrangements; and
 - (E) the size and location of [glazing](#); and
 - (F) external doors; and
 - (vii) testing standards including for insulation, [glazing](#), water heater and unitary [air-conditioning](#) equipment; and
- (b) **Fabric and glazing—**
- (i) quality of insulation installation; and
 - (ii) thermal resistance of air films including any adjustment factors, moisture content of materials and the like; and
 - (iii) dimensions of external, internal and separating walls; and
 - (iv) internal shading devices, their colour and their criteria for operation; and
- (c) **Services—**
- (i) range and type of [services](#) and energy sources, other than [renewable energy](#) generated on [site](#); and
 - (ii) assumptions and means of calculating the temperature difference across [air-conditioning](#) zone boundaries; and
 - (iii) floor coverings and furniture and fittings density; and
 - (iv) internal artificial lighting illumination levels; and
 - (v) internal heat gains including people, lighting, appliances, meals and other electric power loads; and
 - (vi) [air-conditioning](#) system configuration and zones; and
 - (vii) profiles for occupancy, [air-conditioning](#), lighting and internal heat gains from people, hot meals, appliances, equipment and heated water supply systems based on—
 - (A) [Specification JVc](#); or
 - (B) [NABERS Energy for Offices](#) simulation requirements; or
 - (C) [Green Star](#) simulation requirements; or
 - (D) the actual building if—
 - (aa) the operating hours per year are not less than 2 500; or
 - (bb) the daily operating profiles are not listed in [Specification JVc](#); and
 - (viii) supply heated water temperature and rate of use; and
 - (ix) infiltration values, unless the following have been specified—
 - (A) additional sealing provisions to those [required](#) by [Part J3](#); and
 - (B) an intended building leakage of less than 10 m³/hr.m² at 50Pa; and
 - (C) pressure testing to verify achievement of the intended building leakage,

in which case the intended building leakage at 50Pa may be converted into a whole building infiltration value for the proposed building infiltration using Tables 4.16 to 4.24 of CIBSE Guide A; and

- (x) sequencing for water heaters, refrigeration chillers and heat rejection equipment such as cooling towers; and
- (xi) representation of clothing and metabolic rate of the occupants; and
- (xii) control of *air-conditioning* except—
 - (A) the *reference building* must have variable temperature control for chilled and heated water that modulates the chilled water and heated water temperatures as required to maximise the efficiency of the chiller or boiler operation during periods of low load; and
 - (B) if the controls for the proposed building are not adequately specified or cannot be simulated, the sample control specifications in Appendix B of AIRAH-DA28 must be used; and
- (xiii) environmental conditions such as ground reflectivity, sky and ground form factors, temperature of external bounding surfaces, air velocities across external surfaces and the like; and
- (xiv) number, sizes, floors and traffic served by lifts and escalators.

4. Services — proposed and reference building

For the modelling of *services* for the purposes of calculating *annual greenhouse gas emissions*—

- (a) system demand and response for all items of plant must be calculated on a not less frequent than hourly basis; and
- (b) energy usage of all items of plant must be calculated with allowances for—
 - (i) part load performance; and
 - (ii) staging to meet system demand; and
- (c) energy usage of cooling plant must be calculated with allowances for—
 - (i) the impact of chilled water temperature on chiller efficiency; and
 - (ii) the impact of condenser water temperature on water-cooled plant efficiency; and
 - (iii) the impact of ambient temperature on air-cooled plant efficiency; and
 - (iv) the energy use of primary pumps serving individual chillers; and
 - (v) the energy use of auxiliary equipment, including controls and oil heating for chillers; and
 - (vi) thermal losses in the chilled water system; and
 - (vii) the impact of chilled water temperature on thermal losses in the chilled water system; and
- (d) energy usage of water heating systems for space heating must be calculated with allowances for—
 - (i) the impact of water temperature on water heater efficiency; and
 - (ii) the energy use of primary or feedwater pumps serving individual water heaters; and
 - (iii) thermal losses in water heating systems; and
 - (iv) the thermal mass of water heating systems, accounting for thermal losses during periods when the system is not operating; and
- (e) energy usage of fan and pump systems must be calculated with allowances for—
 - (i) the method of capacity regulation; and
 - (ii) the use of either fixed or variable pressure control; and
- (f) energy usage of pump systems must be calculated with allowances for the system fixed static pressure head; and
- (g) energy usage of auxiliary equipment associated with co-generation and tri-generation systems, including pumps, cooling towers and jacket heaters, must be calculated; and
- (h) where the energy usage of the heated water supply for food preparation and sanitary purposes or the energy usage of lifts and escalators is the same in the proposed building and the *reference building*, they may be omitted from the calculation of both the proposed building and the *reference building*; and

Energy efficiency

- (i) energy use of a lift in a building with more than one classification may be apportioned according to the number of *storeys* of the part for which the *annual greenhouse gas emissions* and *thermal comfort level* are being calculated.

Specification JVC

Modelling profiles

1. Scope

This Specification contains modelling profiles as referenced in subclause 3(c)(vii) of Specification JVb.

2. Modelling profiles

- (a) The *air-conditioning*, must be modelled on the basis of—
 - (i) the daily occupancy and operation profiles in Tables 2a to 2k; and
 - (ii) the internal heat gains in a building—
 - (A) from occupants and hot meals, in accordance with one of the options in Table 2n; and
 - (B) from appliances and equipment, in accordance with Table 2l; and
 - (C) from artificial lighting, determined in accordance with (b).
- (b) The artificial lighting, must be modelled on the basis of the proposed level of artificial lighting in the building with the daily profile in Tables 2a to 2k.
- (c) The heated water supply, must be modelled on the basis of the consumption rates of Table 2m.

Table 2a Occupancy and operation profiles of a Class 2 common area

Time period (local standard time)	Occupancy (Daily)	Artificial lighting (Daily)	Appliances and equipment (Daily)	<i>Air-conditioning</i> (Daily)
12:00am to 1:00am	0%	30%	0%	On
1:00am to 2:00am	0%	30%	0%	On
2:00am to 3:00am	0%	30%	0%	On
3:00am to 4:00am	0%	30%	0%	On
4:00am to 5:00am	0%	30%	0%	On
5:00am to 6:00am	0%	30%	0%	On
6:00am to 7:00am	0%	50%	0%	On
7:00am to 8:00am	0%	50%	0%	On
8:00am to 9:00am	0%	50%	0%	On
9:00am to 10:00am	0%	50%	0%	On
10:00am to 11:00am	0%	50%	0%	On
11:00am to 12:00pm	0%	50%	0%	On
12:00pm to 1:00pm	0%	50%	0%	On
1:00pm to 2:00pm	0%	50%	0%	On
2:00pm to 3:00pm	0%	50%	0%	On
3:00pm to 4:00pm	0%	50%	0%	On
4:00pm to 5:00pm	0%	50%	0%	On
5:00pm to 6:00pm	0%	50%	0%	On
6:00pm to 7:00pm	0%	50%	0%	On
7:00pm to 8:00pm	0%	50%	0%	On
8:00pm to 9:00pm	0%	50%	0%	On
9:00pm to 10:00pm	0%	50%	0%	On
10:00pm to 11:00pm	0%	50%	0%	On
11:00pm to 12:00am	0%	30%	0%	On

Note to Table 2a: The artificial lighting profile is expressed as a percentage of the maximum *illumination power density* permitted under Part J6.

Energy efficiency

Table 2b Occupancy and operation profiles of a Class 3 hotel

Time period (local standard time)	Occupancy (Daily)	Artificial lighting (Daily)	Appliances and equipment (Daily)	<i>Air-conditioning</i> (Daily)
12:00am to 1:00am	90%	5%	20%	On
1:00am to 2:00am	90%	5%	20%	On
2:00am to 3:00am	90%	5%	15%	On
3:00am to 4:00am	90%	5%	15%	On
4:00am to 5:00am	90%	5%	15%	On
5:00am to 6:00am	80%	25%	15%	On
6:00am to 7:00am	70%	80%	40%	On
7:00am to 8:00am	60%	80%	80%	On
8:00am to 9:00am	60%	50%	50%	On
9:00am to 10:00am	30%	20%	30%	On
10:00am to 11:00am	10%	20%	20%	Off
11:00am to 12:00pm	10%	20%	20%	Off
12:00pm to 1:00pm	10%	20%	20%	Off
1:00pm to 2:00pm	10%	20%	20%	Off
2:00pm to 3:00pm	10%	20%	20%	Off
3:00pm to 4:00pm	10%	20%	20%	Off
4:00pm to 5:00pm	20%	20%	20%	On
5:00pm to 6:00pm	30%	50%	40%	On
6:00pm to 7:00pm	40%	50%	40%	On
7:00pm to 8:00pm	50%	50%	50%	On
8:00pm to 9:00pm	60%	50%	60%	On
9:00pm to 10:00pm	70%	50%	60%	On
10:00pm to 11:00pm	70%	50%	40%	On
11:00pm to 12:00am	90%	50%	20%	On

Note to Table 2b: The occupancy profile is expressed as a percentage of the maximum number of people that can be accommodated in the Class 3 building. The artificial lighting profile is expressed as a percentage of the maximum *illumination power density* permitted under Part J6. The *air-conditioning* profile is expressed as the plant status.

Table 2c Weekday occupancy and operation profiles of a Class 5 building, a Class 7 warehouse, a Class 8 Laboratory or a Class 9a clinic, day surgery or procedure unit

Time period (local standard time)	Occupancy (Monday to Friday)	Artificial lighting (Monday to Friday)	Appliances and equipment (Monday to Friday)	<i>Air-conditioning</i> (Monday to Friday)
12:00am to 1:00am	0%	15%	25%	Off
1:00am to 2:00am	0%	15%	25%	Off
2:00am to 3:00am	0%	15%	25%	Off
3:00am to 4:00am	0%	15%	25%	Off
4:00am to 5:00am	0%	15%	25%	Off
5:00am to 6:00am	0%	15%	25%	Off
6:00am to 7:00am	0%	15%	25%	Off
7:00am to 8:00am	10%	40%	65%	On
8:00am to 9:00am	20%	90%	80%	On
9:00am to 10:00am	70%	100%	100%	On
10:00am to 11:00am	70%	100%	100%	On
11:00am to 12:00pm	70%	100%	100%	On
12:00pm to 1:00pm	70%	100%	100%	On

Energy efficiency

Time period (local standard time)	Occupancy (Monday to Friday)	Artificial lighting (Monday to Friday)	Appliances and equipment (Monday to Friday)	<i>Air-conditioning</i> (Monday to Friday)
1:00pm to 2:00pm	70%	100%	100%	On
2:00pm to 3:00pm	70%	100%	100%	On
3:00pm to 4:00pm	70%	100%	100%	On
4:00pm to 5:00pm	70%	100%	100%	On
5:00pm to 6:00pm	35%	80%	80%	On
6:00pm to 7:00pm	10%	60%	65%	Off
7:00pm to 8:00pm	5%	60%	55%	Off
8:00pm to 9:00pm	5%	50%	25%	Off
9:00pm to 10:00pm	0%	15%	25%	Off
10:00pm to 11:00pm	0%	15%	25%	Off
11:00pm to 12:00am	0%	15%	25%	Off

Note to Table 2c: The occupancy profile is expressed as a percentage of the maximum number of people that can be accommodated in the building. The artificial lighting profile is expressed as a percentage of the maximum *illumination power density* permitted under Part J6. The appliances and equipment profile is expressed as a percentage of the maximum internal heat gain in Table 2i. The *air-conditioning* profile is expressed as the plant status.

Table 2d Weekend occupancy and operation profiles of a Class 5 building, a Class 7 warehouse, a Class 8 Laboratory or a Class 9a clinic, day surgery or procedure unit

Time period (local standard time)	Occupancy (Saturday, Sunday and holidays)	Artificial lighting (Saturday, Sunday and holidays)	Appliances and equipment (Saturday, Sunday and holidays)	<i>Air-conditioning</i> (Saturday, Sunday and holidays)
12:00am to 1:00am	0%	15%	25%	Off
1:00am to 2:00am	0%	15%	25%	Off
2:00am to 3:00am	0%	15%	25%	Off
3:00am to 4:00am	0%	15%	25%	Off
4:00am to 5:00am	0%	15%	25%	Off
5:00am to 6:00am	0%	15%	25%	Off
6:00am to 7:00am	0%	15%	25%	Off
7:00am to 8:00am	0%	15%	25%	Off
8:00am to 9:00am	5%	25%	25%	Off
9:00am to 10:00am	5%	25%	25%	Off
10:00am to 11:00am	5%	25%	25%	Off
11:00am to 12:00pm	5%	25%	25%	Off
12:00pm to 1:00pm	5%	25%	25%	Off
1:00pm to 2:00pm	5%	25%	25%	Off
2:00pm to 3:00pm	5%	25%	25%	Off
3:00pm to 4:00pm	5%	25%	25%	Off
4:00pm to 5:00pm	5%	25%	25%	Off
5:00pm to 6:00pm	0%	15%	25%	Off
6:00pm to 7:00pm	0%	15%	25%	Off
7:00pm to 8:00pm	0%	15%	25%	Off
8:00pm to 9:00pm	0%	15%	25%	Off
9:00pm to 10:00pm	0%	15%	25%	Off
10:00pm to 11:00pm	0%	15%	25%	Off
11:00pm to 12:00am	0%	15%	25%	Off

Note to Table 2d: The occupancy profile is expressed as a percentage of the maximum number of people that can be

Energy efficiency

accommodated in the building. The artificial lighting profile is expressed as a percentage of the maximum *illumination power density* permitted under [Part J6](#). The appliances and equipment profile is expressed as a percentage of the maximum internal heat gain in [Table 2l](#). The *air-conditioning* profile is expressed as the plant status.

Table 2e Occupancy and operation profiles of a Class 6 shop or shopping centre

Time period (local standard time)	Occupancy (Daily)	Artificial lighting (Daily)	Appliances and equipment (Daily)	<i>Air-conditioning</i> (Daily)
12:00am to 1:00am	0%	25%	25%	Off
1:00am to 2:00am	0%	25%	25%	Off
2:00am to 3:00am	0%	25%	25%	Off
3:00am to 4:00am	0%	25%	25%	Off
4:00am to 5:00am	0%	25%	25%	Off
5:00am to 6:00am	0%	25%	25%	Off
6:00am to 7:00am	0%	25%	25%	Off
7:00am to 8:00am	10%	100%	70%	On
8:00am to 9:00am	20%	100%	70%	On
9:00am to 10:00am	20%	100%	70%	On
10:00am to 11:00am	15%	100%	70%	On
11:00am to 12:00pm	25%	100%	70%	On
12:00pm to 1:00pm	25%	100%	70%	On
1:00pm to 2:00pm	15%	100%	70%	On
2:00pm to 3:00pm	15%	100%	70%	On
3:00pm to 4:00pm	15%	100%	70%	On
4:00pm to 5:00pm	15%	100%	70%	On
5:00pm to 6:00pm	5%	100%	70%	On
6:00pm to 7:00pm	5%	100%	70%	Off
7:00pm to 8:00pm	0%	10%	10%	Off
8:00pm to 9:00pm	0%	10%	10%	Off
9:00pm to 10:00pm	0%	10%	10%	Off
10:00pm to 11:00pm	0%	10%	10%	Off
11:00pm to 12:00am	0%	10%	10%	Off

Note to Table 2e: The occupancy profile is expressed as a percentage of the maximum number of people that can be accommodated in the building. The artificial lighting profile is expressed as a percentage of the maximum *illumination power density* permitted under [Part J6](#). The appliances and equipment profile is expressed as a percentage of the maximum internal heat gain in [Table 2l](#). The *air-conditioning* profile is expressed as the plant status.

Table 2f Occupancy and operation profiles of a Class 6 restaurant or café

Time period (local standard time)	Occupancy (Monday to Saturday)	Artificial lighting (Monday to Saturday)	Appliances and equipment (Monday to Saturday)	<i>Air-conditioning</i> (Monday to Saturday)
12:00am to 1:00am	0%	5%	15%	Off
1:00am to 2:00am	0%	5%	15%	Off
2:00am to 3:00am	0%	5%	15%	Off
3:00am to 4:00am	0%	5%	15%	Off
4:00am to 5:00am	0%	5%	15%	Off
5:00am to 6:00am	0%	5%	15%	Off
6:00am to 7:00am	5%	40%	40%	Off
7:00am to 8:00am	5%	40%	40%	On
8:00am to 9:00am	5%	60%	60%	On

Energy efficiency

Time period (local standard time)	Occupancy (Monday to Saturday)	Artificial lighting (Monday to Saturday)	Appliances and equipment (Monday to Saturday)	<i>Air-conditioning</i> (Monday to Saturday)
9:00am to 10:00am	5%	60%	60%	On
10:00am to 11:00am	20%	90%	90%	On
11:00am to 12:00pm	50%	90%	90%	On
12:00pm to 1:00pm	80%	90%	90%	On
1:00pm to 2:00pm	70%	90%	90%	On
2:00pm to 3:00pm	40%	90%	90%	On
3:00pm to 4:00pm	20%	90%	90%	On
4:00pm to 5:00pm	25%	90%	90%	On
5:00pm to 6:00pm	50%	90%	90%	On
6:00pm to 7:00pm	80%	90%	90%	On
7:00pm to 8:00pm	80%	90%	90%	On
8:00pm to 9:00pm	80%	90%	90%	On
9:00pm to 10:00pm	50%	90%	90%	On
10:00pm to 11:00pm	35%	50%	50%	On
11:00pm to 12:00am	20%	30%	30%	On

Notes to Table 2f:

- The occupancy profile is expressed as a percentage of the maximum number of people that can be accommodated in the building. The artificial lighting profile is expressed as a percentage of the maximum *illumination power density* permitted under Part J6. The appliances and equipment profile is expressed as a percentage of the maximum internal heat gain in Table 2i. The *air-conditioning* profile is expressed as the plant status.
- Sunday profile is 5% continuous artificial lighting and 5% continuous appliances and equipment. There is no occupancy and the *air-conditioning* is "off".

Table 2g Occupancy and operation profiles of a Class 9a ward area

Time period (local standard time)	Occupancy (Daily)	Artificial lighting (Daily)	<i>Air-conditioning</i> (Daily)
12:00am to 1:00am	70%	5%	On
1:00am to 2:00am	70%	5%	On
2:00am to 3:00am	70%	5%	On
3:00am to 4:00am	70%	5%	On
4:00am to 5:00am	70%	5%	On
5:00am to 6:00am	70%	25%	On
6:00am to 7:00am	70%	80%	On
7:00am to 8:00am	70%	80%	On
8:00am to 9:00am	70%	50%	On
9:00am to 10:00am	70%	20%	On
10:00am to 11:00am	70%	20%	On
11:00am to 12:00pm	70%	20%	On
12:00pm to 1:00pm	70%	20%	On
1:00pm to 2:00pm	70%	20%	On
2:00pm to 3:00pm	70%	20%	On
3:00pm to 4:00pm	70%	20%	On
4:00pm to 5:00pm	70%	20%	On
5:00pm to 6:00pm	70%	50%	On
6:00pm to 7:00pm	70%	50%	On
7:00pm to 8:00pm	70%	50%	On

Energy efficiency

Time period (local standard time)	Occupancy (Daily)	Artificial lighting (Daily)	<i>Air-conditioning</i> (Daily)
8:00pm to 9:00pm	70%	50%	On
9:00pm to 10:00pm	70%	50%	On
10:00pm to 11:00pm	70%	50%	On
11:00pm to 12:00am	70%	5%	On

Note to Table 2g: The occupancy profile is expressed as a percentage of the maximum number of people that can be accommodated in the building. The artificial lighting profile is expressed as a percentage of the maximum *illumination power density* permitted under Part J6. The *air-conditioning* profile is expressed as the plant status.

Table 2h Occupancy and operation profiles of a Class 9b theatre or cinema

Time period (Local standard time)	Occu- pancy (Monday to Friday)	Occupancy (Saturday and Sunday)	Artificial lighting (Monday to Friday)	Artificial light- ing (Saturday and Sunday)	<i>Air-condi- tioning</i> (Monday to Friday)	<i>Air-condition- ing</i> (Saturday and Sunday)
12:00am to 1:00am	0%	0%	5%	5%	Off	Off
1:00am to 2:00am	0%	0%	5%	5%	Off	Off
2:00am to 3:00am	0%	0%	5%	5%	Off	Off
3:00am to 4:00am	0%	0%	5%	5%	Off	Off
4:00am to 5:00am	0%	0%	5%	5%	Off	Off
5:00am to 6:00am	0%	0%	5%	5%	Off	Off
6:00am to 7:00am	0%	0%	5%	5%	Off	Off
7:00am to 8:00am	0%	0%	5%	5%	Off	On
8:00am to 9:00am	0%	20%	100%	100%	Off	On
9:00am to 10:00am	0%	70%	10%	10%	Off	On
10:00am to 11:00am	0%	70%	10%	10%	Off	On
11:00am to 12:00pm	0%	70%	10%	10%	On	On
12:00pm to 1:00pm	20%	20%	100%	100%	On	On
1:00pm to 2:00pm	70%	70%	5%	5%	On	On
2:00pm to 3:00pm	70%	70%	5%	5%	On	On
3:00pm to 4:00pm	70%	70%	5%	5%	On	On
4:00pm to 5:00pm	70%	70%	5%	5%	On	On
5:00pm to 6:00pm	20%	20%	100%	100%	On	On
6:00pm to 7:00pm	20%	20%	100%	100%	On	On
7:00pm to 8:00pm	70%	70%	100%	100%	On	On
8:00pm to 9:00pm	70%	70%	5%	5%	On	On
9:00pm to 10:00pm	70%	70%	5%	5%	On	On
10:00pm to 11:00pm	70%	70%	5%	5%	On	On
11:00pm to 12:00am	10%	10%	100%	100%	On	On

Note to Table 2h: The occupancy profile is expressed as a percentage of the maximum number of people that can be accommodated in the building. The artificial lighting profile is expressed as a percentage of the maximum *illumination power density* permitted under Part J6. The *air-conditioning* profile is expressed as the plant status.

Table 2i Occupancy and operation profiles of a Class 9b conference facility

Hour	Occupancy (Daily)	Artificial lighting and equipment (Daily)	<i>Air-conditioning</i> (Daily)
12:00am to 1:00am	0%	15%	Off
1:00am to 2:00am	0%	15%	Off

Energy efficiency

Hour	Occupancy (Daily)	Artificial lighting and equipment (Daily)	<i>Air-conditioning</i> (Daily)
2:00am to 3:00am	0%	15%	Off
3:00am to 4:00am	0%	15%	Off
4:00am to 5:00am	0%	15%	Off
5:00am to 6:00am	0%	15%	Off
6:00am to 7:00am	5%	25%	On
7:00am to 8:00am	10%	45%	On
8:00am to 9:00am	20%	45%	On
9:00am to 10:00am	20%	45%	On
10:00am to 11:00am	25%	60%	On
11:00am to 12:00pm	30%	60%	On
12:00pm to 1:00pm	30%	60%	On
1:00pm to 2:00pm	35%	60%	On
2:00pm to 3:00pm	30%	45%	On
3:00pm to 4:00pm	30%	60%	On
4:00pm to 5:00pm	35%	60%	On
5:00pm to 6:00pm	25%	60%	On
6:00pm to 7:00pm	20%	60%	On
7:00pm to 8:00pm	15%	25%	On
8:00pm to 9:00pm	10%	25%	On
9:00pm to 10:00pm	10%	25%	On
10:00pm to 11:00pm	10%	25%	On
11:00pm to 12:00am	5%	25%	Off

Note to Table 2i: The occupancy profile is expressed as a percentage of the maximum number of people that can be accommodated in the building. The artificial lighting profile is expressed as a percentage of the maximum *illumination power density* permitted under Part J6. The appliances and equipment profile is expressed as a percentage of the maximum internal heat gain in Table 2i. The *air-conditioning* profile is expressed as the plant status.

Table 2j Occupancy and operation profiles of a Class 9b school

Time period (local standard time)	Occupancy (Monday to Friday)	Artificial lighting (Monday to Friday)	Appliances and equipment (Monday to Friday)	<i>Air-conditioning</i> (Monday to Friday)
12:00am to 1:00am	0%	5%	5%	Off
1:00am to 2:00am	0%	5%	5%	Off
2:00am to 3:00am	0%	5%	5%	Off
3:00am to 4:00am	0%	5%	5%	Off
4:00am to 5:00am	0%	5%	5%	Off
5:00am to 6:00am	0%	5%	5%	Off
6:00am to 7:00am	0%	5%	5%	Off
7:00am to 8:00am	5%	30%	30%	On
8:00am to 9:00am	75%	85%	85%	On
9:00am to 10:00am	90%	95%	95%	On
10:00am to 11:00am	90%	95%	95%	On
11:00am to 12:00pm	90%	95%	95%	On
12:00pm to 1:00pm	50%	80%	70%	On
1:00pm to 2:00pm	50%	80%	70%	On
2:00pm to 3:00pm	90%	95%	95%	On
3:00pm to 4:00pm	70%	90%	80%	On

Energy efficiency

Time period (local standard time)	Occupancy (Monday to Friday)	Artificial lighting (Monday to Friday)	Appliances and equipment (Monday to Friday)	<i>Air-conditioning</i> (Monday to Friday)
4:00pm to 5:00pm	50%	70%	60%	On
5:00pm to 6:00pm	20%	20%	20%	Off
6:00pm to 7:00pm	20%	20%	20%	Off
7:00pm to 8:00pm	20%	20%	20%	Off
8:00pm to 9:00pm	10%	10%	10%	Off
9:00pm to 10:00pm	5%	5%	5%	Off
10:00pm to 11:00pm	5%	5%	5%	Off
11:00pm to 12:00am	5%	5%	5%	Off

Notes to Table 2j:

- The occupancy profile is expressed as a percentage of the maximum number of people that can be accommodated in the building. The artificial lighting profile is expressed as a percentage of the maximum *illumination power density* permitted under Part J6. The appliances and equipment profile is expressed as a percentage of the maximum internal heat gain in Table 2i. The *air-conditioning* profile is expressed as the plant status.
- Saturday and Sunday profiles are 5% continuous artificial lighting and 5% continuous appliances and equipment. There is no occupancy and the *air-conditioning* is "off".

Table 2k Occupancy and operation profiles of a Class 9c aged care facility

Time period (local standard time)	Occupancy (Monday to Friday)	Occupancy (Saturday, Sunday and holidays)	Artificial lighting (Monday to Friday)	<i>Air-conditioning</i> (Monday to Friday)	<i>Air-conditioning</i> (Saturday, Sunday and holidays)
12:00am to 1:00am	85%	85%	5%	On	On
1:00am to 2:00am	85%	85%	5%	On	On
2:00am to 3:00am	85%	85%	5%	On	On
3:00am to 4:00am	85%	85%	5%	On	On
4:00am to 5:00am	85%	85%	5%	On	On
5:00am to 6:00am	85%	85%	25%	On	On
6:00am to 7:00am	85%	85%	80%	On	On
7:00am to 8:00am	80%	85%	80%	On	On
8:00am to 9:00am	50%	50%	50%	On	On
9:00am to 10:00am	10%	50%	20%	Off	On
10:00am to 11:00am	10%	20%	20%	Off	Off
11:00am to 12:00pm	10%	20%	20%	Off	Off
12:00pm to 1:00pm	10%	20%	20%	Off	Off
1:00pm to 2:00pm	10%	20%	20%	Off	Off
2:00pm to 3:00pm	10%	20%	20%	Off	Off
3:00pm to 4:00pm	10%	30%	20%	Off	Off
4:00pm to 5:00pm	50%	50%	20%	On	On
5:00pm to 6:00pm	50%	50%	50%	On	On
6:00pm to 7:00pm	70%	50%	50%	On	On
7:00pm to 8:00pm	70%	70%	50%	On	On
8:00pm to 9:00pm	80%	80%	50%	On	On
9:00pm to 10:00pm	85%	80%	50%	On	On
10:00pm to 11:00pm	85%	85%	50%	On	On
11:00pm to 12:00am	85%	85%	5%	On	On

Energy efficiency

Note to Table 2k: The occupancy profile is expressed as a percentage of the maximum number of people that can be accommodated in the Class 9c building. The artificial lighting profile is expressed as a percentage of the maximum *illumination power density* permitted under Part J6. The *air-conditioning* profile is expressed as the plant status.

Table 2l Internal heat gains for appliances and equipment

Application	Internal sensible heat gain rate
Class 9a building <i>ward area</i>	5 W/m ² averaged for 24 hours per day, 7 days per week, continuous operation
Class 8 laboratory and a Class 9a clinic, day surgery and a procedure unit	15 W/m ²
Class 6 shop and shopping centre, Class 6 cafe and restaurant and Class 9b <i>school</i>	5 W/m ²
Other applications	No load
Class 3 (<i>sole-occupancy unit</i>)	160 W per room
Class 3 dormitories	No load
Class 5 building	11 W/m ²
Class 9c building	160 W per room
Class 9b (conference facilities only)	150 W per room plus 10 W per person

Table 2m Heated water supply consumption rates

Application	Daily consumption rate at 60°C
Residential part of a hotel or motel	100 L/ <i>sole-occupancy unit</i>
Dormitory, boarding house, guest house, hostel, lodging house and backpackers accommodation	50 L/person
Residential part of a <i>school</i> , accommodation for the aged, children or people with a disability and a <i>detention centre</i> or a <i>health-care building</i> which accommodates members of staff	
Class 9c building	
Office, laboratory, shop and <i>assembly building</i>	4 L/person
Dining room, restaurant and cafe	9 L/meal
<i>Health-care building ward area</i>	70 L/patient
<i>School</i>	7 L/person
Other applications	4 L/person

Table 2n Internal heat gains for occupants and hot meals

Application	Internal heat gains per person
Dining room, restaurant or cafe	(a) 80 W <i>sensible heat gain</i> and 80 W <i>latent heat gain</i>
	(b) The average adjusted metabolic rate for sedentary work from Table 45 of AIRAH-DA09
	(c) The heat emission rate for sedentary work from Table 6.3 of CIBSE Guide A
Other applications	(a) 75 W <i>sensible heat gain</i> and 55 W <i>latent heat gain</i>
	(b) An average adjusted metabolic rate from Table 45 of AIRAH-DA09
	(c) A heat emission rate from Table 6.3 of CIBSE Guide A

Notes to Table 2n:

- The number of people must be calculated in accordance with D1.13.
- For a dining room, restaurant or cafe, the internal heat gains per person account for heat gains from both occupants and hot meals. For other applications, the internal heat gains per person only account for heat gains from occupants.

Part J0 Energy efficiency

Deemed-to-Satisfy Provisions

J0.0 Deemed-to-Satisfy Provisions

- (a) Where a *Deemed-to-Satisfy Solution* is proposed, *Performance Requirement JP1* is satisfied by complying with—
- (i) J0.1 to J0.5; and
 - (ii) J1.1 to J1.6; and
 - (iii) J3.1 to J3.7; and
 - (iv) J5.1 to J5.12; and
 - (v) J6.1 to J6.8; and
 - (vi) J7.1 to J7.4; and
 - (vii) J8.1 to J8.3.
- (b) Where a *Performance Solution* is proposed, the relevant *Performance Requirements* must be determined in accordance with A2.2(3) and A2.4(3) as applicable.

J0.1 Application of Section J

Performance Requirement JP1 is satisfied by complying with—

- (a) for reducing the heating or cooling loads—
- (i) of *sole-occupancy units* of a Class 2 building or a Class 4 part of a building, J0.2 to J0.5; and
 - (ii) of a Class 2 to 9 building, other than the *sole-occupancy units* of a Class 2 building or a Class 4 part of a building, Parts J1 and J3; and
- (b) for *air-conditioning* and ventilation, Part J5; and
- (c) for artificial lighting and power, Part J6; and
- (d) for heated water supply and *swimming pool* and spa pool plant, Part J7; and
- (e) for facilities for monitoring, Part J8.

J0.2 Heating and cooling loads of sole-occupancy units of a Class 2 building or a Class 4 part

The *sole-occupancy units* of a Class 2 building or a Class 4 part of a building must—

- (a) for reducing the heating or cooling loads—
- (i) collectively achieve an average energy rating of not less than 6 stars, including the separate heating and cooling load limits; and
 - (ii) individually achieve an energy rating of not less than 5 stars, including the separate heating and cooling load limits,
using *house energy rating software* and the load limits specified in the ABCB Standard for NatHERS Heating and Cooling Load Limits.
- (b) for general thermal construction, comply with J1.2; and
- (c) for thermal breaks, comply with J0.4 and J0.5; and
- (d) for floor edge insulation, comply with J1.6(b) and J1.6(c); and
- (e) for building sealing, comply with Part J3.

J0.3 Ceiling fans

Ceiling fans *required* as part of compliance with J0.2(a), must—

Energy efficiency

Deemed-to-Satisfy Provisions

- (a) be permanently installed; and
- (b) have a speed controller; and
- (c) serve the whole room, with the *floor area* that a single fan serves not exceeding—
 - (i) 15 m² if it has a blade rotation diameter of not less than 900 mm; and
 - (ii) 25 m² if it has a blade rotation diameter of not less than 1 200 mm.

J0.4 Roof thermal breaks

For compliance with J0.2(c), a roof that—

- (a) has metal sheet roofing fixed to metal purlins, metal rafters or metal battens; and
- (b) does not have a ceiling lining or has a ceiling lining fixed directly to those metal purlins, metal rafters or metal battens, must have a thermal break, consisting of a material with an *R-Value* of not less than R0.2, installed at all points of contact between the metal sheet roofing and its supporting metal purlins, metal rafters or metal battens.

J0.5 Wall thermal breaks

For compliance with J0.2(c), a wall that—

- (a) does not have a wall lining or has a wall lining that is fixed directly to the same metal frame; and
- (b) has lightweight external cladding such as weatherboards, fibre-cement or metal sheeting fixed to a metal frame, must have a thermal break, consisting of a material with an *R-Value* of not less than R0.2, installed at all points of contact between the external cladding and the metal frame.

Part J1 Building fabric

Deemed-to-Satisfy Provisions

J1.0 Deemed-to-Satisfy Provisions

- (a) Where a *Deemed-to-Satisfy Solution* is proposed, *Performance Requirement JP1* is satisfied by complying with—
- (i) J0.1 to J0.5; and
 - (ii) J1.1 to J1.6; and
 - (iii) J3.1 to J3.7; and
 - (iv) J5.1 to J5.12; and
 - (v) J6.1 to J6.8; and
 - (vi) J7.1 to J7.4; and
 - (vii) J8.1 to J8.3.
- (b) Where a *Performance Solution* is proposed, the relevant *Performance Requirements* must be determined in accordance with A2.2(3) and A2.4(3) as applicable.

J1.1 Application of Part

The *Deemed-to-Satisfy Provisions* of this Part apply to building elements forming the *envelope* of a Class 2 to 9 building other than J1.2(e), J1.3, J1.4, J1.5 and J1.6(a) which do not apply to a Class 2 *sole-occupancy unit* or a Class 4 part of a building.

J1.2 Thermal construction — general

- (a) Where *required*, insulation must comply with AS/NZS 4859.1 and be installed so that it—
- (i) abuts or overlaps adjoining insulation other than at supporting members such as studs, noggings, joists, furring channels and the like where the insulation must be against the member; and
 - (ii) forms a continuous barrier with ceilings, walls, bulkheads, floors or the like that inherently contribute to the thermal barrier; and
 - (iii) does not affect the safe or effective operation of a *service* or fitting.
- (b) Where *required*, *reflective insulation* must be installed with—
- (i) the necessary airspace to achieve the *required R-Value* between a reflective side of the *reflective insulation* and a building lining or cladding; and
 - (ii) the *reflective insulation* closely fitted against any penetration, door or *window* opening; and
 - (iii) the *reflective insulation* adequately supported by framing members; and
 - (iv) each adjoining sheet of roll membrane being—
 - (A) overlapped not less than 50 mm; or
 - (B) taped together.
- (c) Where *required*, bulk insulation must be installed so that—
- (i) it maintains its position and thickness, other than where it is compressed between cladding and supporting members, water pipes, electrical cabling or the like; and
 - (ii) in a ceiling, where there is no bulk insulation or *reflective insulation* in the wall beneath, it overlaps the wall by not less than 50 mm.
- (d) Roof, ceiling, wall and floor materials, and associated surfaces are deemed to have the thermal properties listed in *Specification J1.2*.
- (e) The *required Total R-Value* and *Total System U-Value*, including allowance for thermal bridging, must be—

Energy efficiency

Deemed-to-Satisfy Provisions

- (i) calculated in accordance with AS/NZS 4859.2 for a roof or floor; or
- (ii) determined in accordance with [Specification J1.5a](#) for *wall-glazing construction*; or
- (iii) determined in accordance with [Specification J1.6](#) or Section 3.5 of CIBSE Guide A for soil or sub-floor spaces.

J1.3 Roof and ceiling construction

- (a) A roof or ceiling must achieve a *Total R-Value* greater than or equal to—
 - (i) in *climate zones* 1, 2, 3, 4 and 5, R3.7 for a downward direction of heat flow; and
 - (ii) in *climate zone* 6, R3.2 for a downward direction of heat flow; and
 - (iii) in *climate zone* 7, R3.7 for an upward direction of heat flow; and
 - (iv) in *climate zone* 8, R4.8 for an upward direction of heat flow.
- (b) In *climate zones* 1, 2, 3, 4, 5, 6 and 7, the solar absorptance of the upper surface of a roof must be not more than 0.45.
[SA J1.3\(c\)](#)

J1.4 Roof lights

Roof lights must have—

- (a) a total area of not more than 5% of the *floor area* of the room or space served; and
- (b) transparent and translucent elements, including any imperforate ceiling diffuser, with a combined performance of—
 - (i) for *Total system SHGC*, in accordance with [Table J1.4](#); and
 - (ii) for *Total system U-Value*, not more than U3.9.

Table J1.4 Roof lights - Total system SHGC

<i>Roof light</i> shaft index ^{Note 1}	Total area of <i>roof lights</i> up to 3.5% of the <i>floor area</i> of the room or space	Total area of <i>roof lights</i> more than 3.5% and up to 5% of the <i>floor area</i> of the room or space
< 1.0	≤ 0.45	≤ 0.29
≥ 1.0 to < 2.5	≤ 0.51	≤ 0.33
≥ 2.5	≤ 0.76	≤ 0.49

Notes to [Table J1.4](#):

1. The *roof light* shaft index is determined by measuring the distance from the centre of the shaft at the roof to the centre of the shaft at the ceiling level and dividing it by the average internal dimension of the shaft opening at the ceiling level (or the diameter for a circular shaft) in the same units of measurement.
2. The area of a *roof light* is the area of the roof opening that allows light to enter the building. The total area of *roof lights* is the combined area for all *roof lights* serving the room or space.

J1.5 Walls and glazing

- (a) The *Total System U-Value* of *wall-glazing construction* must not be greater than—
 - (i) for a Class 2 common area, a Class 5, 6, 7, 8 or 9b building or a Class 9a building other than a *ward area*, U2.0; and
 - (ii) for a Class 3 or 9c building or a Class 9a *ward area*—
 - (A) in *climate zones* 1, 3, 4, 6 or 7, U1.1; or
 - (B) in *climate zones* 2 or 5, U2.0; or
 - (C) in *climate zone* 8, U0.9.
- (b) The *Total System U-Value* of *display glazing* must not be greater than U5.8.
- (c) The *Total System U-Value* of *wall-glazing construction* must be calculated in accordance with [Specification J1.5a](#).

Energy efficiency

Deemed-to-Satisfy Provisions

- (d) Wall components of a *wall-glazing construction* must achieve a minimum *Total R-Value* of—
- (i) where the wall is less than 80% of the area of the *wall-glazing construction*, R1.0; or
 - (ii) where the wall is 80% or more of the area of the *wall-glazing construction*, the value specified in [Table J1.5a](#).

Table J1.5a Minimum wall Total R-Value - Wall area 80% or more of wall-glazing construction area

<i>Climate zone</i>	Class 2 common area, Class 5, 6, 7, 8 or 9b building or a Class 9a building other than a <i>ward area</i>	Class 3 or 9c building or Class 9a <i>ward area</i>
1	2.4	3.3
2	1.4	1.4
3	1.4	3.3
4	1.4	2.8
5	1.4	1.4
6	1.4	2.8
7	1.4	2.8
8	1.4	3.8

- (e) The *solar admittance* of externally facing *wall-glazing construction* must not be greater than—
- (i) for a Class 2 common area, a Class 5, 6, 7, 8 or 9b building or a Class 9a building other than a *ward area*, the values specified in [Table J1.5b](#); and
 - (ii) for a Class 3 or 9c building or a Class 9a *ward area*, the values specified in [Table J1.5c](#).
- (f) The *solar admittance* of a *wall-glazing construction* must be calculated in accordance with [Specification J1.5a](#).
- (g) The *Total system SHGC* of *display glazing* must not be greater than 0.81 divided by the applicable shading factor specified in [Clause 7](#) of [Specification J1.5a](#).

Table J1.5b Maximum wall-glazing construction solar admittance - Class 2 common area, Class 5, 6, 7, 8 or 9b building or Class 9a building other than a ward area

<i>Climate zone</i>	Eastern aspect <i>solar admittance</i>	Northern aspect <i>solar admittance</i>	Southern aspect <i>solar admittance</i>	Western aspect <i>solar admittance</i>
1	0.12	0.12	0.12	0.12
2	0.13	0.13	0.13	0.13
3	0.16	0.16	0.16	0.16
4	0.13	0.13	0.13	0.13
5	0.13	0.13	0.13	0.13
6	0.13	0.13	0.13	0.13
7	0.13	0.13	0.13	0.13
8	0.2	0.2	0.42	0.36

Table J1.5c Maximum wall-glazing construction solar admittance - Class 3 or 9c building or Class 9a ward area

<i>Climate zone</i>	Eastern aspect <i>solar admittance</i>	Northern aspect <i>solar admittance</i>	Southern aspect <i>solar admittance</i>	Western aspect <i>solar admittance</i>
1	0.07	0.07	0.10	0.07
2	0.10	0.10	0.10	0.10
3	0.07	0.07	0.07	0.07
4	0.07	0.07	0.07	0.07
5	0.10	0.10	0.10	0.10
6	0.07	0.07	0.07	0.07
7	0.07	0.07	0.08	0.07
8	0.08	0.08	0.08	0.08

Energy efficiency

Deemed-to-Satisfy Provisions

J1.6 Floors

- (a) A floor must achieve the *Total R-Value* specified in [Table J1.6](#).
- (b) A floor must be insulated around the vertical edge of its perimeter with insulation having an *R-Value* greater than or equal to 1.0 when the floor—
- (i) is a concrete slab-on-ground in *climate zone* 8; or
 - (ii) has an in-slab or in-screed heating or cooling system, except where used solely in a bathroom, amenity area or the like.
- (c) Insulation *required* by (b) for a concrete slab-on-ground must—
- (i) be water resistant; and
 - (ii) be continuous from the adjacent finished ground level—
 - (A) to a depth not less than 300 mm; or
 - (B) for the full depth of the vertical edge of the concrete slab-on-ground.

Table J1.6 Floors - Minimum Total R-Value

Location	<i>Climate zone</i> 1 — upwards heat flow	<i>Climate zones</i> 2 and 3 — upwards and downwards heat flow	<i>Climate zones</i> 4, 5, 6 and 7 — downwards heat flow	<i>Climate zone</i> 8 — downwards heat flow
A floor without an in-slab heating or cooling system	2.0	2.0	2.0	3.5
A floor with an in-slab heating or cooling system	3.25	3.25	3.25	4.75

Note to Table J1.6: For the purpose of calculating the *Total R-Value* of a floor, the sub-floor and soil *R-Value* must be calculated in accordance with [Specification J1.6](#) or Section 3.5 of CIBSE Guide A.

Part J2

* * * * *

The content of [Part J2](#) for *glazing*, which existed in NCC 2016, has been removed. *Glazing* provisions are now included in [Part J1](#).

The Part number [Part J2](#) has been retained so as not to change the numbering of the current NCC from that of NCC 2016.

Part J3 Building sealing

Deemed-to-Satisfy Provisions

J3.0 Deemed-to-Satisfy Provisions

- (a) Where a *Deemed-to-Satisfy Solution* is proposed, *Performance Requirement JP1* is satisfied by complying with—
- (i) J0.1 to J0.5; and
 - (ii) J1.1 to J1.6; and
 - (iii) J3.1 to J3.7; and
 - (iv) J5.1 to J5.12; and
 - (v) J6.1 to J6.8; and
 - (vi) J7.1 to J7.4; and
 - (vii) J8.1 to J8.3.
- (b) Where a *Performance Solution* is proposed, the relevant *Performance Requirements* must be determined in accordance with A2.2(3) and A2.4(3) as applicable.

J3.1 Application of Part

The *Deemed-to-Satisfy Provisions* of this Part apply to elements forming the *envelope* of a Class 2 to 9 building, other than—

- (a) a building in *climate zones* 1, 2, 3 and 5 where the only means of *air-conditioning* is by using an evaporative cooler; or
- (b) a permanent building opening, in a space where a gas appliance is located, that is necessary for the safe operation of a gas appliance; or
- (c) a building or space where the mechanical ventilation *required* by Part F4 provides sufficient pressurisation to prevent infiltration.

NSW J3.1(d)

J3.2 Chimneys and flues

The chimney or flue of an open solid-fuel burning appliance must be provided with a damper or flap that can be closed to seal the chimney or flue.

J3.3 Roof lights

- (a) A *roof light* must be sealed, or capable of being sealed, when serving—
- (i) a *conditioned space*; or
 - (ii) a *habitable room* in *climate zones* 4, 5, 6, 7 or 8.
- (b) A *roof light required* by (a) to be sealed, or capable of being sealed, must be constructed with—
- (i) an imperforate ceiling diffuser or the like installed at the ceiling or internal lining level; or
 - (ii) a weatherproof seal; or
 - (iii) a shutter system readily operated either manually, mechanically or electronically by the occupant.

J3.4 Windows and doors

- (a) A door, openable *window* or the like must be sealed—
- (i) when forming part of the *envelope*; or
 - (ii) in *climate zones* 4, 5, 6, 7 or 8.

Energy efficiency

Deemed-to-Satisfy Provisions

- (b) The requirements of (a) do not apply to—
 - (i) a *window* complying with AS 2047; or
 - (ii) a fire door or smoke door; or
 - (iii) a roller shutter door, roller shutter grille or other security door or device installed only for out-of-hours security.
- (c) A seal to restrict air infiltration—
 - (i) for the bottom edge of a door, must be a draft protection device; and
 - (ii) for the other edges of a door or the edges of an openable *window* or other such opening, may be a foam or rubber compression strip, fibrous seal or the like.
- (d) An entrance to a building, if leading to a *conditioned space* must have an airlock, *self-closing* door, *rapid roller door*, revolving door or the like, other than—
 - (i) where the *conditioned space* has a *floor area* of not more than 50 m²; or
 - (ii) where a café, restaurant, open front shop or the like has—
 - (A) a 3 m deep un-conditioned zone between the main entrance, including an open front, and the *conditioned space*; and
 - (B) at all other entrances to the café, restaurant, open front shop or the like, *self-closing* doors.
- (e) A loading dock entrance, if leading to a *conditioned space*, must be fitted with a *rapid roller door* or the like.

J3.5 Exhaust fans

- (a) An exhaust fan must be fitted with a sealing device such as a self-closing damper or the like when serving—
 - (i) a *conditioned space*; or
 - (ii) a *habitable room* in *climate zones* 4, 5, 6, 7 or 8.

J3.6 Construction of ceilings, walls and floors

- (a) Ceilings, walls, floors and any opening such as a *window* frame, door frame, *roof light* frame or the like must be constructed to minimise air leakage in accordance with (b) when forming part of—
 - (i) the *envelope*; or
 - (ii) in *climate zones* 4, 5, 6, 7 or 8.
- (b) Construction *required* by (a) must be—
 - (i) enclosed by internal lining systems that are close fitting at ceiling, wall and floor junctions; or
 - (ii) sealed at junctions and penetrations with—
 - (A) close fitting architrave, skirting or cornice; or
 - (B) expanding foam, rubber compressible strip, caulking or the like.
- (c) The requirements of (a) do not apply to openings, grilles or the like *required* for smoke hazard management.

J3.7 Evaporative coolers

An evaporative cooler must be fitted with a self-closing damper or the like—

- (a) when serving a heated space; or
- (b) in *climate zones* 4, 5, 6, 7 or 8.

Part J4

* * * * *

This Part has deliberately been left blank.

Part J5 Air-conditioning and ventilation systems

J5.0 Deemed-to-Satisfy Provisions

- (a) Where a *Deemed-to-Satisfy Solution* is proposed, *Performance Requirement JP1* is satisfied by complying with—
- (i) J0.1 to J0.5; and
 - (ii) J1.1 to J1.6; and
 - (iii) J3.1 to J3.7; and
 - (iv) J5.1 to J5.12; and
 - (v) J6.1 to J6.8; and
 - (vi) J7.1 to J7.4; and
 - (vii) J8.1 to J8.3.
- (b) Where a *Performance Solution* is proposed, the relevant *Performance Requirements* must be determined in accordance with A2.2(3) and A2.4(3) as applicable.

J5.1 Application of Part

The *Deemed-to-Satisfy Provisions* of this Part do not apply to a Class 8 *electricity network substation*.

J5.2 Air-conditioning system control

- (a) An *air-conditioning* system—
- (i) must be capable of being deactivated when the building or part of a building served by that system is not occupied; and
 - (ii) when serving more than one *air-conditioning* zone or area with different heating or cooling needs, must—
 - (A) thermostatically control the temperature of each zone or area; and
 - (B) not control the temperature by mixing actively heated air and actively cooled air; and
 - (C) limit reheating to not more than—
 - (aa) for a fixed supply air rate, a 7.5 K rise in temperature; and
 - (bb) for a variable supply air rate, a 7.5 K rise in temperature at the nominal supply air rate but increased or decreased at the same rate that the supply air rate is respectively decreased or increased; and
 - (iii) which provides the *required* mechanical ventilation, other than in *climate zone* 1 or where dehumidification control is needed, must have an *outdoor air economy cycle* if the total air flow rate of any airside component of an *air-conditioning* system is greater than or equal to the figures in Table J5.2; and
 - (iv) which contains more than one water heater, chiller or coil, must be capable of stopping the flow of water to those not operating; and
 - (v) with an airflow of more than 1000 L/s, must have a variable speed fan when its supply air quantity is capable of being varied; and
 - (vi) when serving a *sole-occupancy unit* in a Class 3 building, must not operate when any external door of the *sole-occupancy unit* that opens to a balcony or the like, is open for more than one minute; and
 - (vii) must have the ability to use direct signals from the control components responsible for the delivery of comfort conditions in the building to regulate the operation of central plant; and
 - (viii) must have a control dead band of not less than 2°C, except where a smaller range is *required* for specialised applications; and
 - (ix) must be provided with balancing dampers and balancing valves that ensure the maximum design air or fluid flow is achieved but not exceeded by more than 15% above design at each—
 - (A) component; or
 - (B) group of components operating under a common control in a system containing multiple components,

Energy efficiency

as *required* to meet the needs of the system at its maximum operating condition; and

- (x) must ensure that each independently operating space of more than 1 000 m² and every separate floor of the building has provision to terminate airflow independently of the remainder of the system sufficient to allow for different operating times; and
- (xi) must have automatic variable temperature operation of heated water and chilled water circuits; and
- (xii) when deactivated, must close any motorised outdoor air or return air damper that is not otherwise being actively controlled.

Table J5.2 Requirement for an outdoor air economy cycle

<i>Climate zone</i>	Total air flow rate <i>requiring</i> an economy cycle (L/s)
2	9000
3	7500
4	3500
5	3000
6	2000
7	2500
8	4000

- (b) When two or more *air-conditioning* systems serve the same space they must use control sequences that prevent the systems from operating in opposing heating and cooling modes.
- (c) **Time switches—**
 - (i) A time switch must be provided to control—
 - (A) an *air-conditioning* system of more than 2 kW_r; and
 - (B) a heater of more than 1 kW_{heating} used for *air-conditioning*.
 - (ii) The time switch must be capable of switching electric power on and off at variable pre-programmed times and on variable pre-programmed days.
 - (iii) The requirements of (i) and (ii) do not apply to—
 - (A) an *air-conditioning* system that serves—
 - (aa) only one *sole-occupancy unit* in a Class 2, 3 or 9c building; or
 - (bb) a Class 4 part of a building; or
 - (B) a *conditioned space* where *air-conditioning* is needed for 24 hour continuous use.

J5.3 Mechanical ventilation system control

- (a) **General —** A mechanical ventilation system, including one that is part of an *air-conditioning* system, except where the mechanical system serves only one *sole-occupancy unit* in a Class 2 building or serves only a Class 4 part of a building, must—
 - (i) be capable of being deactivated when the building or part of the building served by that system is not occupied; and
 - (ii) when serving a *conditioned space*, except in periods when evaporative cooling is being used—
 - (A) where specified in [Table J5.3](#), have—
 - (aa) an energy reclaiming system that preconditions outdoor air at a minimum sensible heat transfer effectiveness of 60%; or
 - (bb) demand control ventilation in accordance with AS 1668.2 if appropriate to the application; and
 - (B) not exceed the minimum outdoor air quantity *required* by [Part F4](#) by more than 20%, except where—
 - (aa) additional unconditioned outdoor air is supplied for free cooling; or
 - (bb) additional mechanical ventilation is needed to balance the *required* exhaust or process exhaust; or
 - (cc) an energy reclaiming system preconditions all the outdoor air; and

Energy efficiency

- (iii) for an airflow of more than 1000 L/s, have a variable speed fan unless the downstream airflow is *required* by Part F4 to be constant.

Table J5.3 Required outdoor air treatment

Climate zone	Outdoor air flow (L/s)	Required measure
1	>500	Modulating control
2	-	No <i>required</i> measure
3	>1000	Modulating control
4 and 6	>500	Modulating control or energy reclaiming system
5	>1000	Modulating control or energy reclaiming system
7 and 8	>250	Modulating control or energy reclaiming system

- (b) **Exhaust systems** — An exhaust system with an air flow rate of more than 1000 L/s must be capable of stopping the motor when the system is not needed, except for an exhaust system in a *sole-occupancy unit* in a Class 2, 3 or 9c building.
- (c) **Carpark exhaust systems** — *Carpark* exhaust systems must have a control system in accordance with—
- (i) 4.11.2 of AS 1668.2; or
 - (ii) 4.11.3 of AS 1668.2.
- (d) **Time switches**—
- (i) A time switch must be provided to a mechanical ventilation system with an air flow rate of more than 1000 L/s.
 - (ii) The time switch must be capable of switching electric power on and off at variable pre-programmed times and on variable pre-programmed days.
 - (iii) The requirements of (i) and (ii) do not apply to—
 - (A) a mechanical ventilation system that serves—
 - (aa) only one *sole-occupancy unit* in a Class 2, 3 or 9c building; or
 - (bb) a Class 4 part of a building; or
 - (B) a building where mechanical ventilation is needed for 24 hour occupancy.

J5.4 Fan systems

- (a) Fans, ductwork and duct components that form part of an *air-conditioning* system or mechanical ventilation system must—
- (i) separately comply with (b), (c), (d) and (e); or
 - (ii) achieve a fan motor input power per unit of flowrate lower than the fan motor input power per unit of flowrate achieved when applying (b), (c), (d) and (e) together.
- (b) **Fans**—
- (i) Fans in systems that have a static pressure of not more than 200 Pa must have an efficiency at the full load operating point not less than the efficiency calculated with the following formula:

$$\eta_{min} = 0.13 \times \ln(p) - 0.3$$
 where—
 - η_{min} = the minimum *required* system static efficiency for installation type A or C or the minimum *required* system total efficiency for installation type B or D; and
 - p = the static pressure of the system (Pa); and
 - ln = natural logarithm.
 - (ii) Fans in systems that have a static pressure above 200 Pa must have an efficiency at the full load operating point not less than the efficiency calculated with the following formula:

$$\eta_{min} = 0.85 \times (a \times \ln(P) - b + N) / 100$$
 where—

Energy efficiency

η_{min} = the minimum *required* system static efficiency for installation type A or C or the minimum *required* system total efficiency for installation type B or D; and

P = the motor input power of the fan (kW); and

N = the minimum performance grade obtained from [Table J5.4a](#); and

a = regression coefficient a, obtained from [Table J5.4b](#); and

b = regression coefficient b, obtained from [Table J5.4c](#); and

ln = natural logarithm.

- (iii) The requirements of (i) and (ii) do not apply to fans that need to be explosion proof.

Table J5.4a Minimum fan performance grade

Fan type	Installation type A or C	Installation type B or D
Axial — as a component of an air handling unit or fan coil unit	46.0	51.5
Axial — other	42.0	61.0
Mixed flow — as a component of an air handling unit or fan coil unit	46.0	51.5
Mixed flow – other	52.5	65.0
Centrifugal forward-curved	46.0	51.5
Centrifugal radial bladed	46.0	51.5
Centrifugal backward-curved	64.0	64.0

Notes to [Table J5.4a](#):

1. **Installation type A** means an arrangement where the fan is installed with free inlet and outlet conditions.
2. **Installation type B** means an arrangement where the fan is installed with a free inlet and a duct at its outlet.
3. **Installation type C** means an arrangement where the fan is installed with a duct fitted to its inlet and with free outlet conditions.
4. **Installation type D** means an arrangement where the fan is installed with a duct fitted to its inlet and outlet.

Table J5.4b Fan regression coefficient a

Fan type	Fan motor input power < 10 kW	Fan motor input power ≥ 10 kW
Axial	2.74	0.78
Mixed flow	4.56	1.1
Centrifugal forward-curved	2.74	0.78
Centrifugal radial bladed	2.74	0.78
Centrifugal backward-curved	4.56	1.1

Table J5.4c Fan regression coefficient b

Fan type	Fan motor input power < 10 kW	Fan motor input power ≥ 10 kW
Axial	6.33	1.88
Mixed flow	10.5	2.6
Centrifugal forward-curved	6.33	1.88
Centrifugal radial bladed	6.33	1.88
Centrifugal backward-curved	10.5	2.6

(c) Ductwork—

- (i) The pressure drop in the index run across all straight sections of rigid ductwork and all sections of flexible ductwork must not exceed 1 Pa/m when averaged over the entire length of straight rigid duct and flexible duct. The pressure drop of flexible ductwork sections may be calculated as if the flexible ductwork is laid straight.
- (ii) Flexible ductwork must not account for more than 6 m in length in any duct run.
- (iii) The upstream connection to ductwork bends, elbows and tees in the index run must have an equivalent diameter to the connected duct.

Energy efficiency

- (iv) Turning vanes must be included in all rigid ductwork elbows of 90° or more acute than 90° in the index run except where—
 - (A) the inclusion of turning vanes presents a fouling risk; or
 - (B) a long radius bend in accordance with AS 4254.2 is used.
- (d) **Ductwork components in the index run—**
 - (i) The pressure drop across a coil must not exceed the value specified in [Table J5.4d](#).

Table J5.4d Maximum coil pressure drop

Number of rows	Maximum pressure drop (Pa)
1	30
2	50
4	90
6	130
8	175
10	220

- (ii) A high efficiency particulate arrestance (HEPA) air filter must not exceed the higher of—
 - (A) a pressure drop of 200 Pa when clean; or
 - (B) the filter design pressure drop when clean at an air velocity of 1.5 m/s.
- (iii) Any other air filter must not exceed—
 - (A) the pressure drop specified in [Table J5.4e](#) when clean; or
 - (B) the filter design pressure drop when clean at an air velocity of 2.5 m/s.

Table J5.4e Maximum clean filter pressure drop

Filter minimum efficiency reporting value	Maximum pressure drop (Pa)
9	55
11	65
13	95
14	110

- (iv) The pressure drop across intake louvres must not exceed the higher of—
 - (A) for single stage louvres, 30 Pa; and
 - (B) for two stage louvres, 60 Pa; and
 - (C) for acoustic louvres, 50 Pa; and
 - (D) for other non-weatherproof louvres, 30 Pa.
- (v) The pressure drop across a variable air volume box, with the damper in the fully open position, must not exceed—
 - (A) for units with electric reheat, 100 Pa; and
 - (B) for other units, 25 Pa not including coil pressure losses.
- (vi) Rooftop cowls must not exceed a pressure drop of 30 Pa.
- (vii) Attenuators must not exceed a pressure drop of 40 Pa.
- (viii) Fire dampers must not exceed a pressure drop of 15 Pa when open.
- (ix) Balancing and control dampers in the index run must not exceed a pressure drop of 25 Pa when in the fully open position.
- (x) Supply air diffusers and grilles must not exceed a pressure drop of 40 Pa.
- (xi) Exhaust grilles must not exceed a pressure drop of 30 Pa.
- (xii) Transfer ducts must not exceed a pressure drop of 12 Pa.

Energy efficiency

- (xiii) Door grilles must not exceed a pressure drop of 12 Pa.
- (xiv) Active chilled beams must not exceed a pressure drop of 150 Pa.
- (e) The requirements of (a), (b), (c) and (d) do not apply to—
 - (i) fans in unducted *air-conditioning* systems with a supply air capacity of less than 1000 L/s; and
 - (ii) smoke spill fans, except where also used for *air-conditioning* or ventilation; and
 - (iii) the power for process-related components; and
 - (iv) kitchen exhaust systems.

J5.5 Ductwork insulation

- (a) Ductwork and fittings in an *air-conditioning* system must be provided with insulation—
 - (i) complying with AS/NZS 4859.1; and
 - (ii) having an insulation *R-Value* greater than or equal to—
 - (A) for flexible ductwork, 1.0; or
 - (B) for cushion boxes, that of the connecting ductwork; or
 - (C) that specified in [Table J5.5](#).
- (b) Insulation must—
 - (i) be protected against the effects of weather and sunlight; and
 - (ii) be installed so that it—
 - (A) abuts adjoining insulation to form a continuous barrier; and
 - (B) maintains its position and thickness, other than at flanges and supports; and
 - (iii) when conveying cooled air—
 - (A) be protected by a vapour barrier on the outside of the insulation; and
 - (B) where the vapour barrier is a membrane, be installed so that adjoining sheets of the membrane—
 - (aa) overlap by at least 50 mm; and
 - (bb) are bonded or taped together.
- (c) The requirements of (a) do not apply to—
 - (i) ductwork and fittings located within the only or last room served by the system; or
 - (ii) fittings that form part of the interface with the *conditioned space*; or
 - (iii) return air ductwork in, or passing through, a *conditioned space*; or
 - (iv) ductwork for *outdoor air* and exhaust air associated with an *air-conditioning* system; or
 - (v) the floor of an in-situ air-handling unit; or
 - (vi) packaged air conditioners, split systems, and variable refrigerant flow *air-conditioning* equipment complying with *MEPS*; or
 - (vii) flexible fan connections.
- (d) For the purposes of (a), (b) and (c), fittings—
 - (i) include non-active components of a ductwork system such as cushion boxes; and
 - (ii) exclude active components such as air-handling unit components.

Table J5.5 Ductwork and fittings - Minimum insulation R-Value

Location of ductwork and fittings	<i>Climate zone 1, 2, 3, 4, 5, 6 or 7</i>	<i>Climate zone 8</i>
Within a conditioned space	1.2	2.0
Where exposed to direct sunlight	3.0	3.0
All other locations	2.0	3.0

J5.6 Ductwork sealing

Ductwork in an *air-conditioning* system with a capacity of 3000 L/s or greater, not located within the only or last room served by the system, must be sealed against air loss in accordance with the duct sealing requirements of AS 4254.1 and AS 4254.2 for the static pressure in the system.

J5.7 Pump systems

- (a) **General** — Pumps and pipework that form part of an *air-conditioning* system must either—
- (i) separately comply with (b), (c) and (d); or
 - (ii) achieve a pump motor power per unit of flowrate lower than the pump motor power per unit of flowrate achieved when applying (b), (c) and (d) together.
- (b) **Circulator pumps** — A glandless impeller pump, with a rated hydraulic power output of less than 2.5 kW and that is used in closed loop systems must have an energy efficiency index (EEI) not more than 0.27 calculated in accordance with European Union Commission Regulation No. 622/2012.
- (c) **Other pumps** — Pumps that are in accordance with Articles 1 and 2 of European Union Commission Regulation No. 547/2012 must have a minimum efficiency index (MEI) of 0.4 or more when calculated in accordance with European Union Commission Regulation No. 547/2012.
- (d) **Pipework** — Straight segments of pipework along the index run, forming part of an *air-conditioning* system—
- (i) in pipework systems that do not have branches and have the same flow rate throughout the entire pipe network, must achieve an average pressure drop of not more than—
 - (A) for constant speed systems, the values nominated in [Table J5.7a](#); or
 - (B) for variable speed systems, the values nominated in [Table J5.7b](#); or
 - (ii) in any other pipework system, must achieve an average pressure drop of not more than—
 - (A) for constant speed systems, the values nominated in [Table J5.7c](#); or
 - (B) for variable speed systems, the values nominated in [Table J5.7d](#).
- (e) the requirements of (d) do not apply—
- (i) to valves and fittings; or
 - (ii) where the smallest pipe size compliant with (d) results in a velocity of 0.7 m/s or less at design flow.

Table J5.7a Maximum pipework pressure drop - Non-distributive constant speed systems

Nominal pipe diameter (mm)	Maximum pressure drop in systems operating 5000 hours/annum or less (Pa/m)	Maximum pressure drop in systems operating more than 5000 hours/annum (Pa/m)
Not more than 20	400	400
25	400	400
32	400	400
40	400	400
50	400	350
65	400	350
80	400	350
100	400	200
125	400	200
150 or more	400	200

Table J5.7b Maximum pipework pressure drop - Non-distributive variable speed systems

Nominal pipe diameter (mm)	Maximum pressure drop in systems operating 5000 hours/annum or less (Pa/m)	Maximum pressure drop in systems operating more than 5000 hours/annum (Pa/m)
Not more than 20	400	400

Energy efficiency

Nominal pipe diameter (mm)	Maximum pressure drop in systems operating 5000 hours/annum or less (Pa/m)	Maximum pressure drop in systems operating more than 5000 hours/annum (Pa/m)
25	400	400
32	400	400
40	400	400
50	400	400
65	400	400
80	400	400
100	400	300
125	400	300
150 or more	400	300

Table J5.7c Maximum pipework pressure drop - Distributive constant speed systems

Nominal pipe diameter (mm)	Maximum pressure drop in systems operating 2000 hours/annum or less (Pa/m)	Maximum pressure drop in systems operating between 2000 hours/annum and 5000 hours/annum (Pa/m)	Maximum pressure drop in systems operating more than 5000 hours/annum (Pa/m)
Not more than 20	400	300	150
25	400	220	100
32	400	220	100
40	400	220	100
50	400	220	100
65	400	400	170
80	400	400	170
100	400	400	170
125	400	400	170
150 or more	400	400	170

Table J5.7d Maximum pipework pressure drop - Distributive variable speed systems

Nominal pipe diameter (mm)	Maximum pressure drop in systems operating 5000 hours/annum or less (Pa/m)	Maximum pressure drop in systems operating more than 5000 hours/annum (Pa/m)
Not more than 20	400	250
25	400	180
32	400	180
40	400	180
50	400	180
65	400	300
80	400	300
100	400	300
125	400	300
150 or more	400	300

J5.8 Pipework insulation

- (a) *Piping*, vessels, heat exchangers and tanks containing heating or cooling fluid, where the fluid is held at a heated or cooled temperature, that are part of an *air-conditioning* system, other than in appliances covered by *MEPS*, must be provided with insulation—
- (i) complying with AS/NZS 4859.1; and
 - (ii) for *piping* of heating and cooling fluids, having an insulation *R-Value* in accordance with [Table J5.8a](#); and

Energy efficiency

- (iii) for vessels, heat exchangers or tanks, having an insulation *R-Value* in accordance with [Table J5.8b](#); and
 - (iv) for refill or pressure relief *pipings*, having an insulation *R-Value* equal to the *required* insulation *R-Value* of the connected pipe, vessel or tank within 500 mm of the connection.
- (b) Insulation must—
- (i) be protected against the effects of weather and sunlight; and
 - (ii) be able to withstand the temperatures within the *pipings*, vessel, heat exchanger or tank.
- (c) Insulation provided to *pipings*, vessels, heat exchangers or tanks containing cooling fluid must be protected by a vapour barrier on the outside of the insulation.
- (d) The requirements of (a) and (b) do not apply to *pipings*, vessels or heat exchangers—
- (i) located within the only or last room served by the system and downstream of the control device for the regulation of heating or cooling service to that room; or
 - (ii) encased within a concrete slab or panel which is part of a heating or cooling system; or
 - (iii) supplied as an integral part of a chiller, boiler or unitary air-conditioner complying with the requirements of [J5.9](#), [J5.10](#) and [J5.11](#); or
 - (iv) inside an air-handling unit, fan-coil unit, or the like.
- (e) For the purposes of (a), (b), (c) and (d)—
- (i) heating fluids include refrigerant, heated water, steam and condensate; and
 - (ii) cooling fluids include refrigerant, chilled water, brines and glycol mixtures, but do not include condenser cooling water.

Table J5.8a Piping — Minimum insulation R-Value

Fluid temperature range	Minimum insulation <i>R-Value</i> — nominal pipe diameter ≤ 40 mm	Minimum insulation <i>R-Value</i> — nominal pipe diameter > 40 mm and ≤ 80 mm	Minimum insulation <i>R-Value</i> — nominal pipe diameter between > 80 mm and ≤ 150 mm	Minimum insulation <i>R-Value</i> — nominal pipe diameter > 150 mm
Low temperature chilled — ≤ 2°C	1.3	1.7	2.0	2.7
Chilled — > 2°C but ≤ 20°C	1.0	1.5	2.0	2.0
Heated — > 30°C but ≤ 85°C	1.7	1.7	1.7	1.7
High Temperature heated — > 85°C	2.7	2.7	2.7	2.7

Note to Table J5.8a: The minimum *required R-Value* may be halved for *pipings* penetrating a structural member.

Table J5.8b Vessels, heat exchangers and tanks — Minimum insulation R-Value

Fluid temperature range	Minimum insulation <i>R-Value</i>
Low temperature chilled — ≤ 2°C	2.7
Chilled — > 2°C but ≤ 20°C	1.8
Heated — > 30°C but ≤ 85°C	3.0
High temperature heated — > 85°C	3.0

J5.9 Space heating

ACT Appendix

- (a) A heater used for *air-conditioning* or as part of an *air-conditioning* system must be—
- (i) a solar heater; or

Energy efficiency

- (ii) a gas heater; or
 - (iii) a heat pump heater; or
 - (iv) a heater using reclaimed heat from another process such as reject heat from a refrigeration plant; or
 - (v) an electric heater if—
 - (A) the heating capacity is not more than—
 - (aa) 10 W/m² of the *floor area* of the *conditioned space* in *climate zone 1*; or
 - (bb) 40 W/m² of the *floor area* of the *conditioned space* in *climate zone 2*; or
 - (cc) the value specified in [Table J5.9](#) where reticulated gas is not available at the allotment boundary; or
 - (B) the annual energy consumption for heating is not more than 15 kWh/m² of the *floor area* of the *conditioned space* in *climate zones 1, 2, 3, 4 and 5*; or
 - (C) the in-duct heater complies with [J5.2\(a\)\(ii\)\(C\)](#); or
 - (vi) any combination of (i) to (v).
- (b) An electric heater may be used for heating a bathroom in a Class 2, 3, 9a or 9c building if the heating capacity is not more than 1.2 kW and the heater has a timer.
- (c) A fixed heating or cooling appliance that moderates the temperature of an outdoor space must be configured to automatically shut down when—
- (i) there are no occupants in the space served; or
 - (ii) a period of one hour has elapsed since the last activation of the heater; or
 - (iii) the space served has reached the design temperature.
- (d) A gas water heater, that is used as part of an *air-conditioning* system, must—
- (i) if rated to consume 500 MJ/hour of gas or less, achieve a minimum gross thermal efficiency of 86%; or
 - (ii) if rated to consume more than 500 MJ/hour of gas, achieve a minimum gross thermal efficiency of 90%.

Table J5.9 Maximum electric heating capacity

<i>Floor area of the conditioned space</i>	<i>W/m² of floor area in climate zone 3</i>	<i>W/m² of floor area in climate zone 4</i>	<i>W/m² of floor area in climate zone 5</i>	<i>W/m² of floor area in climate zone 6</i>	<i>W/m² of floor area in climate zone 7</i>
≤ 500 m ²	50	60	55	65	70
> 500 m ²	40	50	45	55	60

J5.10 Refrigerant chillers

An *air-conditioning* system refrigerant chiller must comply with *MEPS* and the full load operation energy efficiency ratio and integrated part load energy efficiency ratio in [Table J5.10a](#) or [Table J5.10b](#) when determined in accordance with AHRI 551/591.

Table J5.10a Minimum energy efficiency ratio for refrigerant chillers — Option 1

Chiller type	Full load operation ($W_r / W_{\text{input power}}$)	Integrated part load ($W_r / W_{\text{input power}}$)
Air-cooled chiller with a capacity ≤ 528 kW _r	2.985	4.048
Air-cooled chiller with a capacity > 528 kW _r	2.985	4.137
Water-cooled positive displacement chiller with a capacity ≤ 264 kW _r	4.694	5.867
Water-cooled positive displacement chiller with a capacity > 264 kW _r but ≤ 528 kW _r	4.889	6.286
Water-cooled positive displacement	5.334	6.519

Energy efficiency

Chiller type	Full load operation ($W_r / W_{\text{input power}}$)	Integrated part load ($W_r / W_{\text{input power}}$)
chiller with a capacity > 528 kW _r but ≤ 1055 kW _r		
Water-cooled positive displacement chiller with a capacity > 1055 kW _r but ≤ 2110 kW _r	5.800	6.770
Water-cooled positive displacement chiller with a capacity > 2110 kW _r	6.286	7.041
Water-cooled centrifugal chiller with a capacity ≤ 528 kW _r	5.771	6.401
Water-cooled centrifugal chiller with a capacity > 528 kW _r but ≤ 1055 kW _r	5.771	6.519
Water-cooled centrifugal chiller with a capacity > 1055 kW _r but ≤ 1407 kW _r	6.286	6.770
Water-cooled centrifugal chiller with a capacity > 1407 kW _r	6.286	7.041

Table J5.10b Minimum energy efficiency ratio for refrigerant chillers — Option 2

Chiller type	Full load operation ($W_r / W_{\text{input power}}$)	Integrated part load ($W_r / W_{\text{input power}}$)
Air-cooled chiller with a capacity ≤ 528 kW _r	2.866	4.669
Air-cooled chiller with a capacity > 528 kW _r	2.866	4.758
Water-cooled positive displacement chiller with a capacity ≤ 264 kW _r	4.513	7.041
Water-cooled positive displacement chiller with a capacity > 264 kW _r but ≤ 528 kW _r	4.694	7.184
Water-cooled positive displacement chiller with a capacity > 528 kW _r but ≤ 1055 kW _r	5.177	8.001
Water-cooled positive displacement chiller with a capacity > 1055 kW _r but ≤ 2110 kW _r	5.633	8.586
Water-cooled positive displacement chiller with a capacity > 2110 kW _r	6.018	9.264
Water-cooled centrifugal chiller with a capacity ≤ 528 kW _r	5.065	8.001
Water-cooled centrifugal chiller with a capacity > 528 kW _r but ≤ 1055 kW _r	5.544	8.001
Water-cooled centrifugal chiller with a capacity > 1055 kW _r but ≤ 1407 kW _r	5.917	9.027
Water-cooled centrifugal chiller with a capacity > 1407 kW _r	6.018	9.264

J5.11 Unitary air-conditioning equipment

Unitary *air-conditioning* equipment including packaged air-conditioners, split systems, and variable refrigerant flow systems must comply with *MEPS* and for a capacity greater than or equal to 65 kW_r—

- where water cooled, have a minimum energy efficiency ratio of $4.0 W_r / W_{\text{input power}}$ for cooling when tested in accordance with AS/NZS 3823.1.2 at test condition T1, where input power includes both compressor and fan input power; or
- where air cooled, have a minimum energy efficiency ratio of $2.9 W_r / W_{\text{input power}}$ for cooling when tested in accordance

Energy efficiency

with AS/NZS 3823.1.2 at test condition T1, where input power includes both compressor and fan input power.

J5.12 Heat rejection equipment

- (a) The motor rated power of a fan in a cooling tower, closed circuit cooler or evaporative condenser must not exceed the allowances in [Table J5.12](#).
- (b) The fan in an air-cooled condenser must have a motor rated power of not more than 42 W for each kW of heat rejected from the refrigerant, when determined in accordance with AHRI 460 except for—
- (i) a refrigerant chiller in an *air-conditioning* system that complies with the energy efficiency ratios in [J5.10](#); or
 - (ii) packaged air-conditioners, split systems, and variable refrigerant flow *air-conditioning* equipment that complies with the energy efficiency ratios in [J5.11](#).

Table J5.12 Maximum fan motor power — Cooling towers, closed circuit coolers and evaporative condensers

Type	Cooling tower maximum fan motor input power (W/kW _{rej})	Closed circuit cooler maximum fan motor input power (W/kW _{rej})	Evaporative condenser maximum fan motor input power (W/kW _{rej})
Induced draft	10.4	16.9	11.0
Forced draft	19.5	Note	11.0

Note to Table J5.12: A closed circuit, forced draft cooling tower must not be used.

Part J6 Artificial lighting and power

Deemed-to-Satisfy Provisions

J6.0 Deemed-to-Satisfy Provisions

- (a) Where a *Deemed-to-Satisfy Solution* is proposed, *Performance Requirement JP1* is satisfied by complying with—
- (i) J0.1 to J0.5; and
 - (ii) J1.1 to J1.6; and
 - (iii) J3.1 to J3.7; and
 - (iv) J5.1 to J5.12; and
 - (v) J6.1 to J6.8; and
 - (vi) J7.1 to J7.4; and
 - (vii) J8.1 to J8.3.
- (b) Where a *Performance Solution* is proposed, the relevant *Performance Requirements* must be determined in accordance with A2.2(3) and A2.4(3) as applicable.

J6.1 Application of Part

J6.2, J6.3 and J6.5(a)(ii) do not apply to a Class 8 *electricity network substation*.

J6.2 Artificial lighting

- (a) In a *sole-occupancy unit* of a Class 2 building or a Class 4 part of a building—
- (i) the *lamp power density* or *illumination power density* of artificial lighting must not exceed the allowance of—
 - (A) 5 W/m² within a *sole-occupancy unit*; and
 - (B) 4 W/m² on a verandah, balcony or the like attached to a *sole-occupancy unit*; and
 - (ii) the *illumination power density* allowance in (i) may be increased by dividing it by the *illumination power density* adjustment factor for a control device in Table J6.2b as applicable; and
 - (iii) when designing the *lamp power density* or *illumination power density*, the power of the proposed installation must be used rather than nominal allowances for exposed batten holders or luminaires; and
 - (iv) halogen lamps must be separately switched from fluorescent lamps.
- (b) In a building other than a *sole-occupancy unit* of a Class 2 building or a Class 4 part of a building—
- (i) for artificial lighting, the aggregate design illumination power load must not exceed the sum of the allowances obtained by multiplying the area of each space by the maximum *illumination power density* in Table J6.2a; and
 - (ii) the aggregate design illumination power load in (i) is the sum of the design illumination power loads in each of the spaces served; and
 - (iii) where there are multiple lighting systems serving the same space, the design illumination power load for (ii) is—
 - (A) the total illumination power load of all systems; or
 - (B) where a control system permits only one system to operate at a time—
 - (aa) based on the highest illumination power load; or
 - (bb) determined by the formula—

$$[H \times T/2 + P \times (100 - T/2)] / 100$$

where—

H = the highest illumination power load; and

T = the time for which the maximum illumination power load will occur, expressed

Energy efficiency

Deemed-to-Satisfy Provisions

as a percentage; and
 $P =$ the predominant illumination power load.

- (c) The requirements of (a) and (b) do not apply to the following:
- (i) Emergency lighting provided in accordance with [Part E4](#).
 - (ii) Signage, display lighting within cabinets and display cases that are fixed in place.
 - (iii) Lighting for accommodation within the residential part of a [detention centre](#).
 - (iv) A heater where the heater also emits light, such as in bathrooms.
 - (v) Lighting of a specialist process nature such as in a surgical operating theatre, fume cupboard or clean workstation.
 - (vi) Lighting of performances such as theatrical or sporting.
 - (vii) Lighting for the permanent display and preservation of works of art or objects in a museum or gallery other than for retail sale, purchase or auction.
 - (viii) Lighting installed solely to provide photosynthetically active radiation for indoor plant growth on green walls and the like.
- (d) For the purposes of [Table J6.2b](#), the following control devices must comply with [Specification J6](#):
- (i) Lighting timers.
 - (ii) Motion detectors.
 - (iii) Daylight sensors and dynamic lighting control devices.

Table J6.2a Maximum illumination power density

Space	Maximum <i>illumination power density</i> (W/m ²)
Auditorium, church and public hall	8
Board room and conference room	5
Carpark - general	2
Carpark - entry zone (first 15 m of travel) during the daytime	11.5
Carpark - entry zone (next 4 m of travel) during the day	2.5
Carpark - entry zone (first 20 m of travel) during nighttime	2.5
Common rooms, spaces and corridors in a Class 2 building	4.5
Control room, switch room and the like - intermittent monitoring	3
Control room, switch room and the like - constant monitoring	4.5
Corridors	5
Courtroom	4.5
Dormitory of a Class 3 building used for sleeping only	3
Dormitory of a Class 3 building used for sleeping and study	4
Entry lobby from outside the building	9
Health-care - infants' and children's wards and emergency department	4
Health-care - examination room	4.5
Health-care - examination room in intensive care and high dependency ward	6
Health-care - all other patient care areas including wards and corridors	2.5
Kitchen and food preparation area	4
Laboratory - artificially lit to an ambient level of 400 lx or more	6
Library - stack and shelving area	2.5
Library - reading room and general areas	4.5
Lounge area for communal use in a Class 3 or 9c building	4.5
Museum and gallery - circulation, cleaning and service lighting	2.5
Office - artificially lit to an ambient level of 200 lx or more	4.5

Energy efficiency

Deemed-to-Satisfy Provisions

Space	Maximum <i>illumination power density</i> (W/m ²)
Office - artificially lit to an ambient level of less than 200 lx	2.5
Plant room where an average of 160 lx vertical illuminance is required on a vertical panel such as in switch rooms	4
Plant rooms with a horizontal illuminance target of 80 lx	2
Restaurant, café, bar, hotel lounge and a space for the serving and consumption of food or drinks	14
Retail space including a museum and gallery whose purpose is the sale of objects	14
<i>School</i> - general purpose learning areas and tutorial rooms	4.5
<i>Sole-occupancy unit</i> of a Class 3 or 9c building	5
Storage	1.5
Service area, cleaner's room and the like	1.5
Toilet, locker room, staff room, rest room and the like	3
Wholesale storage area with a vertical illuminance target of 160 lx	4
Stairways, including <i>fire-isolated stairways</i>	2
Lift cars	3

Notes to Table J6.2a:

- In areas not listed above, the maximum *illumination power density* is—
 - for an illuminance not more than 80 lx, 2 W/m²; and
 - for an illuminance more than 80 lx and not more than 160 lx, 2.5 W/m²; and
 - for an illuminance more than 160 lx and not more than 240 lx, 3 W/m²; and
 - for an illuminance more than 240 lx and not more than 320 lx, 4.5 W/m²; and
 - for an illuminance more than 320 lx and not more than 400 lx, 6 W/m²; and
 - for an illuminance more than 400 lx and not more than 600 lx, 10 W/m²; and
 - for an illuminance more than 600 lx and not more than 800 lx, 11.5 W/m².
- For enclosed spaces with a Room Aspect Ratio of less than 1.5, the maximum *illumination power density* may be increased by dividing it by an adjustment factor for room aspect which is—
 $0.5 + (\text{Room Aspect Ratio}/3)$
The Room Aspect Ratio of the enclosed space is determined by the formula—
 $A/(H \times C)$,
where—
 - A is the area of the enclosed space; and
 - H is the height of the space measured from the floor to the highest part of the ceiling; and
 - C is the perimeter of the enclosed space at floor level.
- In addition to 2, the maximum *illumination power density* may be increased by dividing it by the *illumination power density* adjustment factor in Table J6.2b and Table J6.2c and where the control device is not installed to comply with J6.3.
- Circulation spaces are included in the allowances listed in the Table.

Table J6.2b Illumination power density adjustment factor for a control device

Item ^{Note 1}	Description	<i>Illumination power density</i> adjustment factor
Motion detector	In a toilet or change room, other than a public toilet, in a Class 6 building	0.4
Motion detector	Where a group of light fittings serving less than 100 m ² is controlled by one or more detectors	0.6
Motion detector	Where a group of light fittings serving 100 m ² or more is controlled by	0.7

Energy efficiency

Deemed-to-Satisfy Provisions

Item ^{Note 1}	Description	<i>Illumination power density</i> adjustment factor
	one or more detectors	
Programmable dimming system ^{Note 2}	Where not less than 75% of the area of a space is controlled by programmable dimmers	0.85
Fixed dimming ^{Notes 2 and 3}	All fittings with fixed dimming	Whichever is greater of (a) 0.5; or (b) $0.2+0.8L$ where L = the illuminance turndown for the fixed dimming.
Lumen depreciation dimming ^{Note 2}	All fittings with lumen depreciation dimming	0.85
Two stage sensor - equipped lights with minimum power of 30 % of peak power or less	Fire stairs and other spaces not used for regular transit	0.4
Two stage sensor - equipped lights with minimum power of 30% of peak power or less	Transitory spaces in regular use or in a <i>carpark</i>	0.7
Daylight sensor and dynamic lighting control device - dimmed or stepped switching of lights adjacent <i>windows</i> ^{Notes 2 and 4}	In a Class 5, 6, 7, 8 or 9b building or a Class 9a building, other than a <i>ward area</i> , where the lights are adjacent <i>windows</i> , other than <i>roof lights</i> , for a distance from the <i>window</i> equal to the depth of the floor to <i>window</i> head height	0.5 ^{Note 2}
Daylight sensor and dynamic lighting control device - dimmed or stepped switching of lights adjacent <i>windows</i> ^{Notes 2 and 4}	Serving a Class 3 or 9c building, or a Class 9a <i>ward area</i> , where the lights are adjacent <i>windows</i> , other than <i>roof lights</i> , for a distance from the <i>window</i> equal to the depth of the floor to <i>window</i> head height	0.75 ^{Note 2}
Daylight sensor and dynamic lighting control device - dimmed or stepped switching of lights adjacent <i>windows</i> ^{Notes 2 and 4}	In a Class 5, 6, 7, 8 or 9b building or a Class 9a building, other than a <i>ward area</i> , where the lights are adjacent <i>roof lights</i> .	0.6 ^{Note 2}
Daylight sensor and dynamic lighting control device - dimmed or stepped switching of lights adjacent <i>windows</i> ^{Note 2 and 4}	In a Class 3 or 9c building, or a Class 9a <i>ward area</i> , where the lights are adjacent <i>roof lights</i>	0.8 ^{Note 2}

Notes to Table J6.2b:

1. A maximum of two *illumination power density* adjustment factors for a control device can be applied to an area. Where more than one *illumination power density* adjustment factor (other than for room aspect) apply to an area, they are to be combined using the following formula:

Energy efficiency

Deemed-to-Satisfy Provisions

$$A \times (B + [(1 - B) / 2]),$$

where—

- a. A is the lowest applicable *illumination power density* adjustment factor; and
 - b. B is the second lowest applicable *illumination power density* adjustment factor.
2. The adjustment factor does not apply to tungsten, halogen or other incandescent sources.
 3. Includes luminaires with a pre-programmed function which provides dimming from ON to OFF (one-stage dimming).
 4. The *illumination power density* adjustment factor is only applied to lights controlled by daylight sensors between 8:00am and 7:00pm.

Table J6.2c Illumination power density adjustment factor for light colour

Light source	Description	<i>Illumination power density</i> adjustment factor
CRI ≥ 90	Where lighting with good colour rendering is used	0.9
CCT ≤ 3500 K ^{Note}	Where lighting with a warm appearance is used	0.8
CCT ≥ 4500 K	Where lighting with a cool appearance is used	1.1

Note to Table J6.2c: Includes luminaires that can adjust their CCT to 3500 K or below.

J6.3 Interior artificial lighting and power control

- (a) All artificial lighting of a room or space must be individually operated by—
 - (i) a switch; or
 - (ii) other control device; or
 - (iii) a combination of (i) and (ii).
- (b) An occupant activated device, such as a room security device, a motion detector in accordance with [Specification J6](#), or the like, must be provided in the *sole-occupancy unit* of a Class 3 building, other than where providing accommodation for people with a disability or the aged, to cut power to the artificial lighting, air-conditioner, local exhaust fans and bathroom heater when the *sole-occupancy unit* is unoccupied.
- (c) An artificial lighting switch or other control device in (a) must—
 - (i) if an artificial lighting switch, be located in a visible and easily accessed position—
 - (A) in the room or space being switched; or
 - (B) in an adjacent room or space from where 90% of the lighting being switched is visible; and
 - (ii) for other than a single functional space such as an auditorium, theatre, *swimming pool*, sporting stadium or warehouse—
 - (A) not operate lighting for an area of more than 250 m² if in a Class 5 building or a Class 8 laboratory; or
 - (B) not operate lighting for an area of more than—
 - (aa) 250 m² for a space of not more than 2000 m²; or
 - (bb) 1000 m² for a space of more than 2000 m²,
 if in a Class 3, 6, 7, 8 (other than a laboratory) or 9 building.
- (d) 95% of the light fittings in a building or *storey* of a building, other than a Class 2 or 3 building or a Class 4 part of a building, of more than 250 m² must be controlled by—
 - (i) a time switch in accordance with [Specification J6](#); or
 - (ii) an occupant sensing device such as—
 - (A) a security key card reader that registers a person entering and leaving the building; or
 - (B) a motion detector in accordance with [Specification J6](#).

Energy efficiency

Deemed-to-Satisfy Provisions

- (e) In a Class 5, 6 or 8 building of more than 250 m², artificial lighting in a natural lighting zone adjacent to *windows* must be separately controlled from artificial lighting not in a natural lighting zone in the same *storey* except where—
 - (i) the room containing the natural lighting zone is less than 20 m²; or
 - (ii) the room's natural lighting zone contains less than 4 luminaires; or
 - (iii) 70% or more of the luminaires in the room are in the natural lighting zone.
- (f) Artificial lighting in a *fire-isolated stairway*, *fire-isolated passageway* or *fire-isolated ramp*, must be controlled by a motion detector in accordance with [Specification J6](#).
- (g) Artificial lighting in a foyer, corridor and other circulation spaces—
 - (i) of more than 250 W within a single zone; and
 - (ii) adjacent to *windows*,
 must be controlled by a daylight sensor and dynamic lighting control device in accordance with [Specification J6](#).
- (h) Artificial lighting for daytime travel in the first 19 m of travel in a *carpark* entry zone must be controlled by a daylight sensor in accordance with [Specification J6](#).
- (i) The requirements of (a), (b), (c), (d), (e), (f), (g) and (h) do not apply to the following:
 - (i) Emergency lighting in accordance with [Part E4](#).
 - (ii) Where artificial lighting is needed for 24 hour occupancy such as for a manufacturing process, parts of a hospital, an airport control tower or within a *detention centre*.
- (j) The requirements of (d) do not apply to the following:
 - (i) Artificial lighting in a space where the sudden loss of artificial lighting would cause an unsafe situation such as—
 - (A) in a *patient care area* in a Class 9a building or in a Class 9c building; or
 - (B) a plant room or lift motor room; or
 - (C) a workshop where power tools are used.
 - (ii) A heater where the heater also emits light, such as in bathrooms.

J6.4 Interior decorative and display lighting

- (a) Interior decorative and display lighting, such as for a foyer mural or art display, must be controlled—
 - (i) separately from other artificial lighting; and
 - (ii) by a manual switch for each area other than when the operating times of the displays are the same in a number of areas such as in a museum, art gallery or the like, in which case they may be combined; and
 - (iii) by a time switch in accordance with [Specification J6](#) where the display lighting exceeds 1 kW.
- (b) Window display lighting must be controlled separately from other display lighting.

J6.5 Exterior artificial lighting

- (a) Exterior artificial lighting attached to or directed at the facade of a building, must—
 - (i) be controlled by—
 - (A) a daylight sensor; or
 - (B) a time switch that is capable of switching on and off electric power to the system at variable pre-programmed times and on variable pre-programmed days; and
 - (ii) when the total lighting load exceeds 100 W—
 - (A) use LED luminaires for 90% of the total lighting load; or
 - (B) be controlled by a motion detector in accordance with [Specification J6](#); or
 - (C) when used for decorative purposes, such as façade lighting or signage lighting, have a separate time

Energy efficiency

Deemed-to-Satisfy Provisions

switch in accordance with [Specification J6](#).

- (b) The requirements of (a)(ii) do not apply to the following:
- (i) Emergency lighting in accordance with [Part E4](#).
 - (ii) Lighting around a *detention centre*.

J6.6 Boiling water and chilled water storage units

Power supply to a boiling water or chilled water storage unit must be controlled by a time switch in accordance with [Specification J6](#).

J6.7 Lifts

Lifts must—

- (a) be configured to ensure artificial lighting and ventilation in the car are turned off when it is unused for 15 minutes; and
- (b) achieve the idle and standby energy performance level in [Table 6.7a](#); and
- (c) achieve—
 - (i) the energy efficiency class in [Table 6.7b](#); or
 - (ii) if a dedicated goods lift, energy efficiency class D in accordance with ISO 25745-2.

Table 6.7a Lift idle and standby energy performance level

Rated load	Idle and standby ^{Note} energy performance level in accordance with ISO 25745-2
Less than or equal to 800 kg	2
801 kg to less than or equal to 2000 kg	3
2001 kg to less than or equal to 4000 kg	4
Greater than 4000 kg	5

Note to Table 6.7a: Applies to the standby power used after 30 minutes.

Table 6.7b Lift energy efficiency class

Usage category in accordance with ISO 25745-2	Energy efficiency class in accordance with ISO 25745-2
1 - 4	C
> 5	D

J6.8 Escalators and moving walkways

Escalators and moving walkways must have the ability to slow to between 0.2 m/s and 0.05 m/s when unused for more than 15 minutes.

Part J7 Heated water supply and swimming pool and spa pool plant

Deemed-to-Satisfy Provisions

J7.0 Deemed-to-Satisfy Provisions

- (a) Where a *Deemed-to-Satisfy Solution* is proposed, *Performance Requirement JP1* is satisfied by complying with—
- (i) J0.1 to J0.5; and
 - (ii) J1.1 to J1.6; and
 - (iii) J3.1 to J3.7; and
 - (iv) J5.1 to J5.12; and
 - (v) J6.1 to J6.8; and
 - (vi) J7.1 to J7.4; and
 - (vii) J8.1 to J8.3.
- (b) Where a *Performance Solution* is proposed, the relevant *Performance Requirement* must be determined in accordance with A2.2(3) and A2.4(3) as applicable.

J7.1 * * * * *

This clause has deliberately been left blank.

J7.2 Heated water supply

A heated water supply system for food preparation and sanitary purposes must be designed and installed in accordance with Part B2 of NCC Volume Three — Plumbing Code of Australia.

J7.3 Swimming pool heating and pumping

ACT Appendix

- (a) Heating for a *swimming pool* must be by—
- (i) a solar heater; or
 - (ii) a heater using reclaimed heat from another process such as reject heat from a refrigeration plant; or
 - (iii) a geothermal heater; or
 - (iv) a gas heater that—
 - (A) if rated to consume 500 MJ/hour or less, achieves a minimum gross thermal efficiency of 86%; or
 - (B) if rated to consume more than 500 MJ/hour, achieves a minimum gross thermal efficiency of 90%; or
 - (v) a heat pump; or
 - (vi) a combination of (i) to (v).
- (b) Where some or all of the heating *required* by (a) is by a gas heater or a heat pump, the *swimming pool* must have—
- (i) a cover with a minimum *R-Value* of 0.05; and
 - (ii) a time switch to control the operation of the heater.
- (c) A time switch must be provided to control the operation of a circulation pump for a *swimming pool*.
- (d) Where *required*, a time switch must be capable of switching electric power on and off at variable pre-programmed times and on variable pre-programmed days.
- (e) Pipework carrying heated or chilled water for a *swimming pool* must comply with the insulation requirements of J5.8.
- (f) For the purpose of J7.3, a *swimming pool* does not include a spa pool.

J7.4 Spa pool heating and pumping

ACT Appendix

- (a) Heating for a spa pool that shares a water recirculation system with a *swimming pool* must be by—
- (i) a solar heater; or
 - (ii) a heater using reclaimed heat from another process such as reject heat from a refrigeration plant; or
 - (iii) a geothermal heater; or
 - (iv) a gas heater that—
 - (A) if rated to consume 500 MJ/hour or less, achieves a minimum gross thermal efficiency of 86%; or
 - (B) if rated to consume more than 500 MJ/hour, achieves a minimum gross thermal efficiency of 90%; or
 - (v) a heat pump; or
 - (vi) a combination of (i) to (v).
- (b) Where some or all of the heating *required* by (a) is by a gas heater or a heat pump, the spa pool must have—
- (i) a cover with a minimum *R-Value* of 0.05; and
 - (ii) a push button and a time switch to control the operation of the heater.
- (c) A time switch must be provided to control the operation of a circulation pump for a spa pool having a capacity of 680 L or more.
- (d) Where *required*, a time switch must be capable of switching electric power on and off at variable pre-programmed times and on variable pre-programmed days.
- (e) Pipework carrying heated or chilled water for a spa pool must comply with the insulation requirements of J5.8.

Part J8 Facilities for energy monitoring

Deemed-to-Satisfy Provisions

J8.0 Deemed-to-Satisfy Provisions

- (a) Where a *Deemed-to-Satisfy Solution* is proposed, *Performance Requirement JP1* is satisfied by complying with—
- (i) J0.1 to J0.5; and
 - (ii) J1.1 to J1.6; and
 - (iii) J3.1 to J3.7; and
 - (iv) J5.1 to J5.12; and
 - (v) J6.1 to J6.8; and
 - (vi) J7.1 to J7.4; and
 - (vii) J8.1 to J8.3.
- (b) Where a *Performance Solution* is proposed, the relevant *Performance Requirements* must be determined in accordance with A2.2(3) and A2.4(3) as applicable.

J8.1 Application of Part

The *Deemed-to-Satisfy Provisions* of this Part do not apply—

- (a) within a *sole-occupancy unit* of a Class 2 building or a Class 4 part of a building; or
- (b) to a Class 8 *electricity network substation*.

J8.2 * * * * *

This clause has deliberately been left blank.

J8.3 Facilities for energy monitoring

- (a) A building or *sole-occupancy unit* with a *floor area* of more than 500 m² must have an energy meter configured to record the time-of-use consumption of gas and electricity.
- (b) A building with a *floor area* of more than 2 500 m² must have energy meters configured to enable individual time-of-use energy consumption data recording, in accordance with (c), of the energy consumption of—
 - (i) *air-conditioning* plant including, where appropriate, heating plant, cooling plant and air handling fans; and
 - (ii) artificial lighting; and
 - (iii) appliance power; and
 - (iv) central hot water supply; and
 - (v) internal transport devices including lifts, escalators and moving walkways where there is more than one serving the building; and
 - (vi) other ancillary plant.
- (c) Energy meters *required* by (b) must be interlinked by a communication system that collates the time-of-use energy consumption data to a single interface monitoring system where it can be stored, analysed and reviewed.
- (d) The provisions of (b) do not apply to a Class 2 building with a *floor area* of more than 2 500 m² where the total area of the common areas is less than 500 m².

Specification J1.2

Material properties

Deemed-to-Satisfy Provisions

1. Scope

This Specification lists the thermal properties of some common construction materials.

2. Construction Deemed-to-Satisfy

(a) [Table 2a](#) lists the thermal conductivity considered to be achieved by some common construction materials.

Table 2a Thermal conductivity of typical wall, roof/ceiling and floor materials

Material description	Material density (kg/m ³)	Thermal conductivity (W/m.K)
1. Framing		
(a) Steel	7850	47.5
(b) Timber – kiln dried hardwood (across the grain)	677	0.16
(c) Timber – Radiata pine (across the grain)	506	0.10
2. Roof Cladding		
(a) Aluminium sheeting	2680	210
(b) Concrete or terra cotta tiles	1922	0.81
(c) Steel sheeting	7850	47.5
3. Wall Cladding		
(a) Aluminium sheeting	2680	210
(b) Autoclaved aerated concrete	350	0.10
	900	0.27
(c) Cement render (1 cement : 4 sand)	1570	0.53
(d) Clay bricks		
(i) Clay brick – 2.75 kg	1430	0.55
(ii) Clay brick – 3.25 kg	1690	0.65
(iii) Clay brick – 3.75 kg	1950	0.78
(e) Concrete blocks		
(i) 190 mm dense or 90 mm dense solid	1100/2200	1.1
(ii) 140 mm dense or 190 mm lightweight	1250/910	0.85
(iii) 90 mm dense hollow or 90 mm lightweight solid	1650/1800	0.75
(iv) 140 mm lightweight	1050	0.67
(v) 90 mm lightweight	1360	0.55
(f) Fibre-cement	1360	0.25
(g) Gypsum plasterboard	880	0.17
(h) Pine weatherboards	506	0.10
(i) Plywood	530	0.14
(j) Solid concrete	2400	1.44
(k) Steel sheeting	7850	47.5
(l) Prestressed hollow core concrete panel	1680	0.80
4. Flooring Materials		

Energy efficiency

Deemed-to-Satisfy Provisions

Material description	Material density (kg/m ³)	Thermal conductivity (W/m.K)
(a) Carpet underlay	-	0.04
(b) Carpet	-	0.05
(c) Prestressed hollow core concrete planks	1680	0.80
(d) Particleboard	640	0.12
(e) Plywood	530	0.14
(f) Timber – kiln dried hardwood (across the grain)	677	0.16
(g) Timber – Radiata pine (across the grain)	506	0.10
(h) Solid concrete	2400	1.44
(i) Vinyl floor tiles	2050	0.79
5. Other Materials		
(a) Clay soil (10% moisture content)	1300	0.6
(b) PMMA (polymethylmethacrylate)	1180	1.00
(c) Polycarbonates	1200	0.2
(d) Sand (6% moisture content)	1800	1.64
(e) Soda lime glass	2500	1.0

Notes to Table 2a:

- For materials which incorporate cores or hollows in regular patterns (such as cored brickwork, hollow blockwork and cored floor or wall panels), the tabulated material densities and thermal conductivities are based on the gross density (mass divided by external dimensions).
- The *R-Value* of a material is determined by dividing the thickness of the material in metres by the thermal conductivity in W/m.K.
 - Table 2b lists the *R-Values* considered to be achieved by air films and airspaces.

Table 2b Typical R-Values for airspaces and air films

Position of airspace	Direction of heat flow	R-Value
1. Airspaces non-reflective unventilated		
In a roof with a pitch of not more than 5°	Up	0.15
	Down	0.22
In a roof with a ceiling that is parallel with a roof with a pitch more than 5° and not more than 15°	Up	0.15
	Down	0.21
In a roof with a ceiling that is parallel with a roof with a pitch more than 22° and not more than 45°	Up	0.15
	Down	0.18
In any roof space with a horizontal ceiling, with a pitch more than 5°	Up	0.18
	Down	0.28
In a wall	Horizontal	0.17
2. Airspaces non-reflective ventilated		
In any roof with a pitch not more than 5° and 100 mm deep airspace	Up	Nil
	Down	0.19
In any roof space with a horizontal ceiling, with a pitch more than 5°	Up	Nil
	Down	0.46

Energy efficiency

Deemed-to-Satisfy Provisions

Position of airspace	Direction of heat flow	<i>R-Value</i>
In a wall	Horizontal	0.14
3. Air films – Still air		
On a surface with a pitch of not more than 5°	Up	0.11
	Down	0.16
On a surface with a pitch of more than 5° and not more than 30°	Up	0.11
	Down	0.15
On a surface with a pitch of more than 30° and not more than 45°	Up	0.11
	Down	0.13
On a wall	Horizontal	0.12
4. Air films – Moving air		
Not more than 3 m/s wind	Any direction	0.04
More than 3 m/s wind speed and not more than 7 m/s wind speed	Any direction	0.03

Note to Table 2b: *R-Values* are for a temperature of 10°C and temperature difference of 15 K.

- (c) The thermal properties considered to be achieved by reflective surfaces are—
- (i) within a wall—
 - (A) with an inner reflective surface of 0.05 emittance and a 20 mm airspace to the wall lining, an added *R-Value* of 0.48; and
 - (B) with an inner reflective surface of 0.05 emittance and a 70 mm airspace to the wall lining, an added *R-Value* of 0.43; and
 - (C) with an inner reflective surface of 0.05 emittance and a 70 mm airspace to the wall lining and an outer anti-glare reflective surface of 0.20 emittance and a 25 mm airspace to the wall cladding, an added *R-Value* of 0.95; and
 - (D) with an outer anti-glare reflective surface of 0.20 emittance and a 35 mm airspace to the wall cladding, an added *R-Value* of 0.50; and
 - (ii) within a roof where the *reflective insulation* is laid directly under the roof, those in Table 2c.

Table 2c Typical thermal properties for reflective surfaces with airspaces in roofs

Emittance of added <i>reflective insulation</i>	Direction of heat flow	<i>R-Value</i> added by a reflective surface					
		Pitched roof (>10°) with horizontal ceiling		Flat, skillion or pitched roof (≤10°) with horizontal ceiling	Pitched roof with cathedral ceiling		
		Ventilated roof space	Non-ventilated roof space		15° to not more than 25° pitch	more than 25° to not more than 35° pitch	more than 35° to 45° pitch
0.2 outer 0.05 inner	Downwards	1.21	1.12	1.28	0.96	0.86	0.66
0.2 outer 0.05 inner	Upwards	0.59	0.75	0.68	0.72	0.74	0.77
0.9 outer	Downwards	1.01	0.92	1.06	0.74	0.64	0.44

Energy efficiency

Deemed-to-Satisfy Provisions

Emittance of added <i>reflective insulation</i>	Direction of heat flow	<i>R-Value</i> added by a reflective surface					
		Pitched roof (>10°) with horizontal ceiling		Flat, skillion or pitched roof (≤10°) with horizontal ceiling	Pitched roof with cathedral ceiling		
		Ventilated roof space	Non-ventilated roof space		15° to not more than 25° pitch	more than 25° to not more than 35° pitch	more than 35° to 45° pitch
0.05 inner							
0.9 outer 0.05 inner	Upward	0.40	0.55	0.49	0.51	0.52	0.53

- (d) A ventilated roof space is a roof space with—
- (i) gable vents, ridge vents, eave vents, roof vents or the like that—
 - (A) are evenly distributed to allow an unobstructed flow of air; and
 - (B) are located to ensure, where practicable, there are no dead airspaces; and
 - (C) have an aggregate fixed open area of not less than 1.0% of the ceiling area; or
 - (ii) not less than 2 wind-driven roof ventilators having an aggregate opening area of not less than 0.14 m² in conjunction with gable vents, ridge vents, eave vents, roof vents or the like having an aggregate fixed open area of not less than 0.2% of the ceiling area; or
 - (iii) a tiled roof without *sarking-type material* at roof level.

Specification J1.5a

Calculation of U-Value and solar admittance

1. Scope

This specification describes the methods of calculating the *U-Value* and *solar admittance* of a *wall-glazing construction*.

2. General

For determining the aspect of a *wall-glazing construction*—

- (a) the northern aspect is at or within 45° of true north; and
- (b) the southern aspect is at or within 45° of true south; and
- (c) the eastern aspect is within 45° of true east; and
- (d) the western aspect is within 45° of true west.

3. U-Value — Method 1 (Single Aspect)

- (a) For the purposes of this method, a *wall-glazing construction* only includes the walls and *glazing* facing a single aspect.
- (b) The *Total system U-Value* of the wall component of a *wall-glazing construction* must be calculated as the inverse of the *Total R-Value*, including allowance for thermal bridging, in accordance with—
 - (i) AS/NZS 4859.2; or
 - (ii) *Specification J1.5b* for *spandrel panels*.
- (c) The *Total system U-Value* of a *wall-glazing construction* must be calculated as the area-weighted average of the *Total system U-Value* of each of the components of the *wall-glazing construction*.
- (d) The *Total system U-Value* must not exceed the applicable value in *J1.5(a)*.

4. U-Value — Method 2 (Multiple Aspects)

- (a) For the purposes of this method, a *wall-glazing construction* includes the walls and *glazing* facing multiple aspects.
- (b) The *Total system U-Value* of the wall component of a *wall-glazing construction* must be calculated as the inverse of the *Total R-Value*, including allowance for thermal bridging, in accordance with—
 - (i) AS/NZS 4859.2; or
 - (ii) *Specification J1.5b* for *spandrel panels*.
- (c) The *Total system U-Value* of a *wall-glazing construction* must be calculated as an area-weighted average of the *Total system U-Value* of each of the components of the *wall-glazing construction*.
- (d) The *Total system U-Value* must not exceed the applicable value in *J1.5(a)*.

5. Solar admittance — Method 1 (Single Aspect)

- (a) The *solar admittance* of a *wall-glazing construction* must be calculated in accordance with the following formula:

$$SA = \frac{A_{W1} \times S_{W1} \times SHGC_{W1}}{A_{Wall}} + \frac{A_{W2} \times S_{W2} \times SHGC_{W2}}{A_{Wall}} + \dots$$

where—

SA = the *wall-glazing construction solar admittance*; and

$A_{W1}, A_{W2}, \text{ etc}$ = the area of each *glazing* element; and

$S_{W1}, S_{W2}, \text{ etc}$ = the shading multiplier for each *glazing* element in accordance with Clause 7; and

$SHGC_{W1}, W2, \text{ etc}$ = the *Total system SHGC* of each *glazing* element; and

A_{Wall} = the total *wall-glazing construction* area.

- (b) The *solar admittance* of the *wall-glazing construction* must not exceed the applicable value in J1.5(e).

6. Solar admittance — Method 2 (Multiple Aspects)

The *solar admittance* of *wall-glazing construction* must achieve a representative *air-conditioning* energy value less than that achieved by the reference *solar admittance*, when using the following formula:

$$E_R = A_N \alpha_N SA_N + A_E \alpha_E SA_E + A_S \alpha_S SA_S + A_W \alpha_W SA_W$$

where—

E_R = the representative *air-conditioning* energy value; and

A_N, E, S, W = the area of the *wall-glazing construction* facing each aspect; and

α_N, E, S, W = the *solar admittance* weighting coefficient of each aspect equal to—

- where the *glazing* area on an aspect is less than 20% of the *wall-glazing construction* area, 0; and
- the values in Table 6a and Table 6b; and

SA_N, E, S, W = the *wall-glazing construction solar admittance* of each aspect—

- equal to the applicable value in J1.5(b) in the reference case; and
- calculated in accordance with Clause 5(a) in the proposed case.

Energy efficiency

Table 6a Solar admittance weighting coefficient — Class 2 common area, Class 5, 6, 7, 8 or 9b building or Class 9a building other than a ward area

	<i>Climate zone 1</i>	<i>Climate zone 2</i>	<i>Climate zone 3</i>	<i>Climate zone 4</i>	<i>Climate zone 5</i>	<i>Climate zone 6</i>	<i>Climate zone 7</i>	<i>Climate zone 8</i>
Northern aspect	1.47	1.95	1.95	2.05	2.28	2.12	2.40	1.88
Southern aspect	1.00	1.00	1.00	1.00	1.00	1.00	1.00	1.00
Eastern aspect	1.39	1.58	1.63	1.72	1.72	1.62	1.84	1.92
Western aspect	1.41	1.68	1.65	1.69	1.75	1.67	1.92	1.25

Table 6b Solar admittance weighting coefficient — Class 3 or 9c building or Class 9a ward area

	<i>Climate zone 1</i>	<i>Climate zone 2</i>	<i>Climate zone 3</i>	<i>Climate zone 4</i>	<i>Climate zone 5</i>	<i>Climate zone 6</i>	<i>Climate zone 7</i>	<i>Climate zone 8</i>
Northern aspect	1.42	1.77	1.72	1.55	1.88	1.52	1.60	1.24
Southern aspect	1.00	1.00	1.00	1.00	1.00	1.00	1.00	1.00
Eastern aspect	1.30	1.49	1.48	1.37	1.48	1.28	1.35	1.26
Western aspect	1.37	1.54	1.50	1.36	1.52	1.33	1.40	1.05

7. Shading

For the purpose of calculating *solar admittance*, the shading multiplier is—

- (a) for shading provided by an external permanent projection that extends horizontally on both sides of the *glazing* for the same projection distance P, as shown in [Figure 7](#)—
 - (i) the value in [Table 7a](#) for shading on the northern, eastern or western aspects; or
 - (ii) the value in [Table 7b](#) for shading on the southern aspect; or
- (b) 0.35 for shading that is provided by an external shading device such as a shutter, blind, vertical or horizontal building screen with blades, battens or slats, which—
 - (i) is capable of restricting at least 80% of summer solar radiation; and
 - (ii) if adjustable, will operate automatically in response to the level of solar radiation.

Table 7a Shading multipliers — Northern, eastern and western aspects

G/H	P/H = 0	P/H = 0.1	P/H = 0.2	P/H = 0.3	P/H = 0.4	P/H = 0.5	P/H = 0.6	P/H = 0.7	P/H = 0.8	P/H = 0.9	P/H = 1
0	1.00	0.90	0.80	0.72	0.64	0.57	0.51	0.46	0.41	0.38	0.35
0.1	1.00	0.95	0.89	0.81	0.74	0.66	0.59	0.52	0.47	0.42	0.40
0.2	1.00	0.98	0.94	0.89	0.82	0.75	0.68	0.62	0.56	0.51	0.47
0.3	1.00	1.00	0.97	0.94	0.89	0.84	0.78	0.72	0.66	0.61	0.57
0.4	1.00	1.00	0.99	0.97	0.94	0.90	0.86	0.82	0.77	0.73	0.68
0.5	1.00	1.00	1.00	0.99	0.97	0.95	0.92	0.90	0.86	0.83	0.79

Table 7b Shading multipliers — Southern aspect

G/H	P/H = 0	P/H = 0.1	P/H = 0.2	P/H = 0.3	P/H = 0.4	P/H = 0.5	P/H = 0.6	P/H = 0.7	P/H = 0.8	P/H = 0.9	P/H = 1
0	1.00	0.93	0.87	0.82	0.77	0.73	0.69	0.65	0.62	0.60	0.58
0.1	1.00	0.97	0.93	0.88	0.84	0.79	0.75	0.71	0.67	0.64	0.62

Energy efficiency

G/H	P/H = 0	P/H = 0.1	P/H = 0.2	P/H = 0.3	P/H = 0.4	P/H = 0.5	P/H = 0.6	P/H = 0.7	P/H = 0.8	P/H = 0.9	P/H = 1
0.2	1.00	0.98	0.96	0.93	0.89	0.85	0.81	0.77	0.73	0.70	0.68
0.3	1.00	0.99	0.98	0.96	0.93	0.90	0.87	0.83	0.80	0.77	0.74
0.4	1.00	1.00	0.99	0.98	0.96	0.94	0.91	0.89	0.86	0.84	0.81
0.5	1.00	1.00	0.99	0.99	0.98	0.96	0.95	0.93	0.91	0.90	0.88

Figure 7 Permanent external shading - Measurement of P, G and H

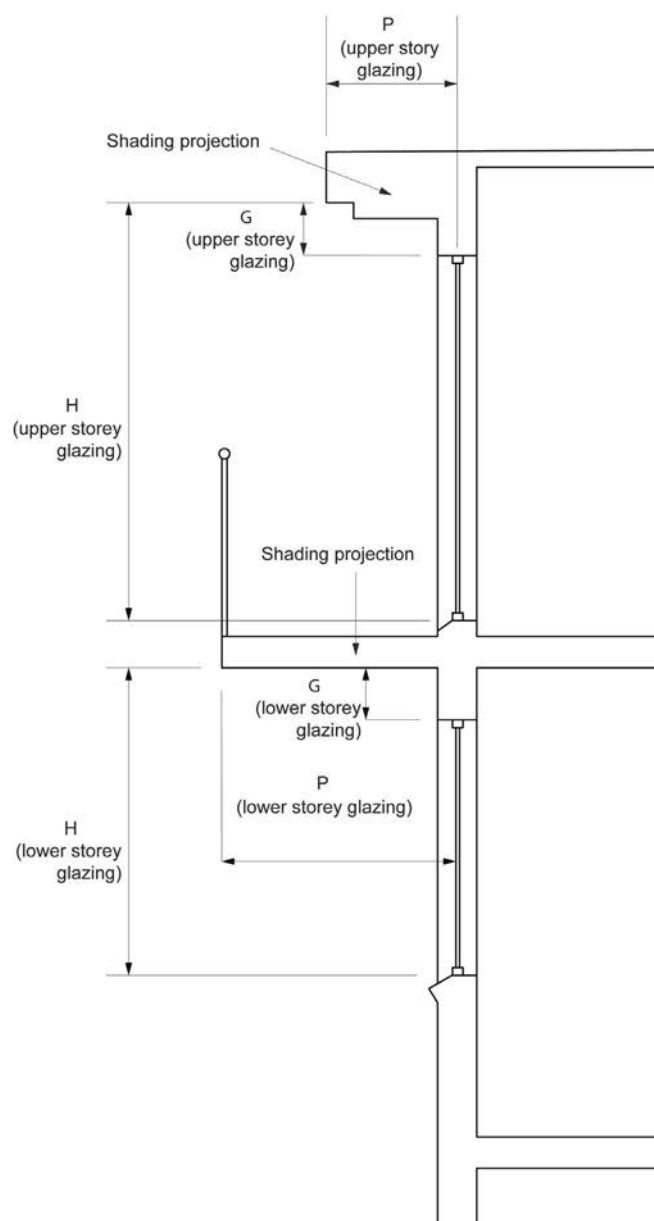

Specification J1.5b

Spandrel panel thermal performance

1. Scope

This Specification describes methods of determining the thermal performance of *spandrel panels*.

2. Spandrel panel R-Value: Calculation method 1

Spandrel panels are deemed to have the thermal properties nominated in Table 2, where—

- (a) Configuration 1 consists of—
 - (i) a thermally unbroken (bridged) frame; and
 - (ii) a centre of *spandrel panel* consisting of—
 - (A) a single-glazed opaque or clear face; and
 - (B) a 100 mm air gap; and
 - (C) a 3 mm aluminium, 0.8 mm galvanised steel or zinc back pan; and
- (b) Configuration 2 consists of—
 - (i) a thermally unbroken (bridged) frame; and
 - (ii) a centre of *spandrel panel* consisting of—
 - (A) a double-glazed opaque face; and
 - (B) a 50 mm air gap; and
 - (C) a 3 mm aluminium, 0.8 mm galvanised steel or zinc back pan; and
- (c) Configuration 3 consists of—
 - (i) a thermally broken (unbridged) frame; and
 - (ii) a centre of *spandrel panel* consisting of—
 - (A) a double-glazed clear face; and
 - (B) a 50 mm air gap; and
 - (C) a 3 mm aluminium, 0.8 mm galvanised steel or zinc back pan; and
- (d) Configuration 4 consists of—
 - (i) a thermally broken (unbridged) frame; and
 - (ii) a centre of *spandrel panel* consisting of—
 - (A) a double-glazed low-e clear face; and
 - (B) a 50 mm air gap; and
 - (C) a 3 mm aluminium, 0.8 mm galvanised steel or zinc back pan.

Table 2 Achieved Total R-Value of spandrel panels

Type	No insulation	R0.5 insulation	R1.0 insulation	R1.5 insulation	R2.0 insulation
Configuration 1	0.3	0.39	0.42	0.44	0.45
Configuration 2	0.35	0.41	0.43	0.44	0.45
Configuration 3	0.84	0.96	1.03	1.07	1.09
Configuration 4	0.91	1.00	1.05	1.09	1.11

3. Spandrel panel R-Value: Calculation method 2

The *Total system U-Value* of a *spandrel panel* is determined in accordance with the following formula:

$$U_{sp} = \frac{U_{cs} A_{cs} + \sum U_{es} A_{es} + \sum U_{fs} A_{fs}}{A_{cs} + \sum A_{es} + \sum A_{fs}}$$

where—

A_{cs} = the area of the centre region of the *spandrel panel*; and

A_{es} = the area of the edge region of the *spandrel panel*, where the edge has a defined width of 127 mm; and

A_{fs} = the area of the frame region of the *spandrel panel*; and

U_{cs} = the U-value of the centre region of the *spandrel panel*; and

U_{es} = the U-value of the edge region of the *spandrel panel*, where the edge has a defined width of 127 mm; and

U_{fs} = the U-value of the frame region of the *spandrel panel*; and

U_{sp} = the *Total system U-Value* of the *spandrel panel*.

Specification J1.6

Sub-floor thermal performance

1. Scope

This Specification describes the thermal performance of sub-floor spaces and soil in direct contact with a floor for the purposes of calculating the *Total R-Value* of a floor.

2. Sub-floor thermal performance

- (a) Table 2a details the R-Values considered to be achieved by enclosed sub-floor spaces that are—
 - (i) mechanically ventilated by not more than 1.5 air changes per hour; or
 - (ii) provided with not more than 150% of the aggregate sub-floor ventilation area *required* by Part F1 and are not mechanically ventilated.

Table 2a R-Value of sub-floor spaces

Ratio of <i>floor area</i> to floor perimeter (m)	Sub-floor space <i>R-Value</i>
1.0	0.10
1.5	0.15
2.0	0.20
2.5	0.25
3.0	0.30
3.5	0.35
4.0	0.40
4.5	0.45
5.0	0.50
5.5	0.55
6.0	0.60
6.5	0.65
7.0	0.70

Note to Table 2a: Where the ratio of *floor area* to floor perimeter is between the values stated, interpolation may be used to determine the sub-floor space R-Values.

- (b) Table 2b details the R-Values considered to be achieved by the soil for floors that are in direct contact with the ground.

Table 2b R-Value of soil in contact with a floor

Ratio of <i>floor area</i> to floor perimeter (m)	Wall thickness of 50 mm	Wall thickness of 100 mm	Wall thickness of 150 mm	Wall thickness of 200 mm	Wall thickness of 250 mm	Wall thickness of 300 mm
1.0	0.4	0.5	0.5	0.6	0.7	0.8
1.5	0.6	0.7	0.7	0.8	0.9	1.0
2.0	0.7	0.8	0.9	1.0	1.1	1.3
2.5	0.9	1.0	1.1	1.2	1.3	1.5
3.0	1.0	1.2	1.3	1.4	1.5	1.7
3.5	1.2	1.3	1.5	1.6	1.7	1.9
4.0	1.3	1.5	1.6	1.7	1.9	2.2
4.5	1.5	1.7	1.8	1.9	2.1	2.4
5.0	1.6	1.8	2.0	2.1	2.3	2.6
5.5	1.8	2.0	2.1	2.2	2.4	2.8
6.0	1.9	2.1	2.3	2.4	2.6	2.9
6.5	2.0	2.3	2.4	2.6	2.8	3.1

Energy efficiency

Ratio of <i>floor area</i> to floor perimeter (m)	Wall thickness of 50 mm	Wall thickness of 100 mm	Wall thickness of 150 mm	Wall thickness of 200 mm	Wall thickness of 250 mm	Wall thickness of 300 mm
7.0	2.2	2.4	2.6	2.7	3.0	3.3

Note to Table 2b: Where a wall thickness or ratio of *floor area* to floor perimeter is between the values stated, interpolation may be used to determine the soil R-Value.

Specification J6

Lighting and power control devices

*Deemed-to-Satisfy Provisions***1. Scope**

This Specification contains the requirements for lighting and power control devices including timers, time switches, motion detectors and daylight control devices.

2. Lighting timers

A lighting timer must—

- (a) be located within 2 m of every entry door to the space; and
- (b) have an indicator light that is illuminated when the artificial lighting is off; and
- (c) not control more than—
 - (i) an area of 100 m² with a single push button timer; and
 - (ii) 95% of the lights in spaces of area more than 25 m²; and
- (d) be capable of maintaining the artificial lighting—
 - (i) for not less than 5 minutes; and
 - (ii) for not more than 12 hours if the timer is reset.

3. Time switch

- (a) A time switch must be—
 - (i) capable of switching on and off electric power at variable pre-programmed times and on variable pre-programmed days; and
 - (ii) configured so that the lights are switched off at any time the space is designated to be unoccupied.
- (b) A time switch for internal lighting must be capable of being overridden by—
 - (i) a means of turning the lights on, either by—
 - (A) a manual switch, remote control or an occupant sensing device that on sensing a person's presence, overrides the time switch for a period of up to 2 hours, after which if there is no further presence detected, the time switch must resume control; or
 - (B) an occupant sensing device that overrides the time switch upon a person's entry and returns control to the time switch upon the person's exiting, such as a security card reader or remote control; and
 - (ii) a manual "off" switch.
- (c) A time switch for external lighting must be—
 - (i) configured to limit the period the system is switched on to between 30 minutes before sunset and 30 minutes after sunrise is determined or detected including any pre-programmed period between these times; and
 - (ii) capable of being overridden by a manual switch, remote control or a security access system for a period of up to 8 hours, after which the time switch must resume control.
- (d) A time switch for boiling water or chilled water storage units must be capable of being overridden by a manual switch or a security access system that senses a person's presence, overrides for a period of up to 2 hours, after which if there is no further presence detected, the time switch must resume control.

4. Motion detectors

- (a) In a Class 2, 3 or 9c *residential care building* other than within a *sole-occupancy unit*, a motion detector must—
 - (i) be capable of sensing movement such as by infra-red, ultrasonic or microwave detection or by a

Energy efficiency

Deemed-to-Satisfy Provisions

- combination of these means; and
- (ii) be capable of detecting a person before they are 1 m into the space; and
 - (iii) other than within a *sole-occupancy unit* of a Class 3 building, not control more than—
 - (A) an area of 100 m²; and
 - (B) 95% of the lights in spaces of area more than 25 m²; and
 - (iv) be configured so that the lights are turned off when the space is unoccupied for more than 15 minutes; and
 - (v) be capable of being overridden by a manual switch only enabling the lights to be turned off.
- (b) In a Class 5, 6, 7, 8, 9a or 9b building, a motion detector must—
- (i) be capable of sensing movement such as by infra-red, ultrasonic or microwave detection or by a combination of these means; and
 - (ii) be capable of detecting—
 - (A) a person before they have entered 1 m into the space; and
 - (B) movement of 500 mm within the useable part of the space; and
 - (iii) not control more than—
 - (A) in other than a *carpark*, an area of 500 m² with a single sensor or group of parallel sensors; and
 - (B) 75% of the lights in spaces using high intensity discharge; and
 - (iv) be configured so that the lights are turned off when the space is unoccupied for more than 15 minutes; and
 - (v) be capable of being overridden by a manual switch that only enables the lights to be turned off.
- (c) When outside a building, a motion detector must—
- (i) be capable of sensing movement such as by pressure, infra-red, ultrasonic or microwave detection or by a combination of these means; and
 - (ii) be capable of detecting a person within a distance from the light equal to—
 - (A) twice the mounting height; or
 - (B) 80% of the ground area covered by the light's beam; and
 - (iii) not control more than five lights; and
 - (iv) be operated in series with a photoelectric cell or astronomical time switch so that the light will not operate in daylight hours; and
 - (v) be configured so that the lights are turned off when the area is unoccupied for more than 15 minutes; and
 - (vi) have a manual override switch which is reset after a maximum period of 4 hours.
- (d) When in a *fire-isolated stairway*, *fire-isolated passageway* or *fire-isolated ramp*, a motion detector must—
- (i) be capable of sensing movement such as by infra-red, ultrasonic or microwave detection or by a combination of these means; and
 - (ii) be capable of detecting—
 - (A) movement of 500 mm within the useable part of the space; and
 - (B) a person before they have entered 1 m into the space; and
 - (iii) be configured so that the lights dim to a 30% peak power or less when the space is unoccupied for more than 15 minutes.

5. Daylight sensor and dynamic lighting control device

- (a) A daylight sensor and dynamic control device for artificial lighting must—
 - (i) for switching on and off—

Energy efficiency

Deemed-to-Satisfy Provisions

- (A) be capable of having the switching level set point adjusted between 50 and 1000 lux; and
- (B) have—
 - (aa) a delay of more than 2 minutes; and
 - (bb) a differential of more than 100 lux for a sensor controlling high pressure discharge lighting, and 50 lux for a sensor controlling other than high pressure discharge lighting; and
- (ii) for dimmed or stepped switching, be capable of reducing the power consumed by the controlled lighting in proportion to the incident daylight on the working plane either—
 - (A) continuously down to a power consumption that is less than 50% of full power; or
 - (B) in no less than 4 steps down to a power consumption that is less than 50% of full power.
- (b) Where a daylight sensor and dynamic control device has a manual override switch, the manual override switch must not be able to switch the lights permanently on or bypass the lighting controls.

State & Territory Appendices

Schedule 1 State & Territory Appendices

Schedule 1 State & Territory Appendices

Schedule 1 State & Territory Appendices

Schedule 1 State & Territory Appendices

Commonwealth of Australia

Australian Capital Territory

New South Wales

Northern Territory

Queensland

South Australia

Tasmania

Victoria

Western Australia

Commonwealth of Australia

Footnote: Other legislation and policies affecting buildings

Commonwealth of Australia

Footnote: Other legislation and policies affecting buildings

1. Aged Care Buildings
2. Australian Capital Territory
3. Indian Ocean Territories
4. Communications and Information Technology
5. Defence Buildings
6. Disability Discrimination
7. Environment
8. Federal Airports
9. Jervis Bay Territory
10. Occupational Health and Safety
11. Australian Antarctic Territory
12. Territory of Heard Island and McDonald Islands
13. National or World Heritage Places
14. National Parks
15. Commonwealth funding for building work
16. Commonwealth buildings

Footnote: Other legislation and policies affecting buildings

In addition to any applicable provisions of this Code, there are a number of other legislative technical requirements and policies affecting the design, construction and/or performance of buildings that practitioners may need to be aware of, including, but not necessarily limited to, the following list. Additional legislative instruments such as regulations, codes and standards may exist under the legislation listed.

1. Aged Care Buildings

Administering Agency

Department of Health

Relevant Legislation

Aged Care Act 1997

2. Australian Capital Territory

Administering Agency

Department of Finance, section 27 insofar as it relates to the declaration of land in the Australian Capital Territory to be National Land where the land is required for Commonwealth purposes other than for the special purposes of Canberra as the National Capital

Department of Infrastructure, Regional Development and Cities, except to the extent administered by the Minister for Finance.

Relevant Legislation

Australian Capital Territory (Planning and Land Management) Act 1988

National Capital Plan (established under the Australian Capital Territory (Planning and Land Management) Act 1988)

Administering Agency

Department of Infrastructure, Regional Development and Cities

Relevant Legislation

Parliament Act 1974

National Land Ordinance 1989

3. Indian Ocean Territories

Administering Agency

Department of Infrastructure, Regional Development and Cities

Relevant Legislation

Christmas Island Act 1958

Cocos (Keeling) Islands Act 1955

4. Communications and Information Technology

Administering Agency

Department of Communications and the Arts

Relevant Legislation

Australian Postal Corporation Act 1989

National Transmission Network Sale Act 1998

Telecommunications Act 1997

Telstra Corporation Act 1991

Telecommunications (Consumer Protection and Service Standards) Act 1999

Relevant Policy

Telecommunications Infrastructure in New Development (TIND) Policy

5. Defence Buildings

Administering Agency

Department of Defence

Relevant Legislation

Defence Act 1903

Relevant Regulations

Defence Regulation 2016, Part 11A

Relevant Codes, Standards and Publications

Manual of Fire Protection Engineering

Requirements for the Provision of Disabled Access and other Facilities for People with a Disability in Defence

Heating, Ventilation and Air Conditioning Policy

Microbial Control in Air Handling and Water Systems of Defence Buildings

Building Energy Performance Manual

Manual of Infrastructure Engineering - Electrical

Manual of Infrastructure Engineering - Bulk Fuel Installation Design

Defence Communications Cabling Standard

Defence Training Area Management Manual

Defence Safety Manual

Defence Security Manual

Defence Explosive Ordinance Publications

The Defence Estate Quality Management System (<http://www.defence.gov.au/estatemangement/governance/policy/principlesdevelopment/default.asp>) contains further requirements including the principles of development, zone planning, site selection, engineering requirements and environmental impact assessment and approval requirements.

6. Disability Discrimination

Administering Agency

Attorney-General's Department

Relevant Legislation

Disability (Access to Premises - Buildings) Standards 2010

Disability Discrimination Act 1992

Disability Standards for Accessible Public Transport 2002

7. Environment

Administering Agency

Department of the Environment and Energy

Relevant Legislation

Environment Protection and Biodiversity Conservation Act 1999

Environment Protection and Biodiversity Conservation Regulations 2000

Relevant Policy

Energy Efficiency in Government Operations (2007)

8. Federal Airports

Administering Agency

Department of Infrastructure, Regional Development and Cities

Relevant Legislation

Airports Act 1996

Airports Regulations 1997
 Airports (Building Control) Regulations 1996
 Airports (Control of On-Airport Activities) Regulations 1997
 Airports (Environmental Protection) Regulations 1997
 Airports (Protection of Airspace) Regulations 1996

9. Jervis Bay Territory

Administering Agency

Department of Infrastructure, Regional Development and Cities

Relevant Legislation

Jervis Bay Territory Acceptance Act 1915

10. Occupational Health and Safety

Administering Agency

Department of Jobs and Small Business

Relevant Legislation

Work Health and Safety Act 2011

Work Health and Safety Regulations 2011

11. Australian Antarctic Territory

Administering Agency

Department of the Environment and Energy (Australian Antarctic Division)

Relevant Legislation

Antarctic Treaty (Environment Protection) Act 1980

Antarctic Treaty (Environment Protection) (Environmental Impact Assessment) Regulations 1993

Antarctic Treaty (Environment Protection) (Waste Management) Regulations 1994

Environment Protection and Biodiversity Conservation Act 1999

Environment Protection and Biodiversity Conservation Regulations 2000

12. Territory of Heard Island and McDonald Islands

Administering Agency

Department of the Environment and Energy (Australian Antarctic Division)

Relevant Legislation

Environment Protection and Management Ordinance 1987 (HIMI)

Environment Protection and Biodiversity Conservation Act 1999

Heard Island and McDonald Islands Marine Reserve management plan in operation under the Environment Protection and Biodiversity Conservation Act 1999

Environment Protection and Biodiversity Conservation Regulations 2000

13. National or World Heritage Places

Administering Agency

Department of the Environment and Energy

Relevant Legislation

Environment Protection and Management Ordinance 1987 (HIMI)

Antarctic Treaty (Environment Protection) (Environmental Impact Assessment) Regulations 1993

Environment Protection and Biodiversity Conservation Act 1999

Heard Island and McDonald Islands Marine Reserve management plan in operation under the Environment Protection and Biodiversity Conservation Act 1999

Environment Protection and Biodiversity Conservation Regulations 2000

14. National Parks

Administering Agency

Director of National Parks, Environment and Energy Portfolio

Relevant Legislation

Commonwealth Reserve management plans in operation under the Environment Protection and Biodiversity Conservation Act 1999

Environment Protection and Biodiversity Conservation Act 1999

Environment Protection and Biodiversity Conservation Regulations 2000

15. Commonwealth funding for building work

Administering Agency

Department of Jobs and Small Business

Relevant Legislation

Building and Construction Industry (Improving Productivity) Act 2016

Building and Construction Industry (Improving Productivity) Regulations 2017

Building and Construction Industry (Consequential and Transitional Provisions) Act 2016

Fair Work (Building Industry - Accreditation Scheme) Amendment Regulation 2014

Building Code 2013 (issued under Section 27 of the Fair Work (Building Industry) Act 2012)

16. Commonwealth buildings

Administering Agency

Department of Jobs and Small Business

Relevant Legislation

Building and Construction Industry (Improving Productivity) Act 2016

Building and Construction Industry (Improving Productivity) Regulations 2017

Building and Construction Industry (Consequential and Transitional Provisions) Act 2016

Fair Work (Building Industry - Accreditation Scheme) Amendment Regulation 2014

Building Code 2013 (issued under Section 27 of the Fair Work (Building Industry) Act 2012)

Australian Capital Territory

ACT Appendix

Footnote: Other legislation affecting buildings

Australian Capital Territory

ACT Appendix

Footnote: Other legislation affecting buildings

ACT Appendix

The Australian Capital Territory Appendix to the Building Code of Australia (BCA) Volume One forms part of the ACT Building Code published in accordance with the Building Act 2004. This Appendix contains variations and additions to the BCA that apply to building work undertaken in the ACT and information about the application of the BCA in the ACT. The ACT Appendix is notified on the ACT Legislation Register and can be found at <https://www.legislation.act.gov.au/a/2004-11/> under the Regulations and Instruments tab. While the BCA text includes indicators of potential ACT-specific clauses, including variations and additions, not all current ACT-specific clauses may be indicated. Users of the BCA must check that they are using the version of the ACT Appendix currently in force and are applying all relevant variations and additions. Historical version of the ACT Appendix are also available on the register

Footnote: Other legislation affecting buildings

In addition to any applicable provisions of the Building Act 2004 and this Code, there are other legislative technical requirements affecting the design, construction and/or performance of buildings that practitioners may need to be aware of. A list of relevant legislation and links to where it can be found on the ACT Legislation Register can be found in the ACT Appendix at <https://www.legislation.act.gov.au/a/2004-11/>.

New South Wales

Introduction

Section A **Governing requirements**

Section D **Access and egress**

Section F **Health and amenity**

Section G **Ancillary provisions**

Section H **Special use buildings**

NSW Part H101 **Entertainment venues other than temporary structures
and drive-in theatres**

NSW Part H102 **Temporary structures**

NSW Part H103 **Drive-in theatres**

NSW Section J **Energy efficiency**

Schedule 3 **Definitions**

Schedule 4 **Referenced documents**

Footnote: **Other legislation affecting buildings**

New South Wales

Introduction

Section A Governing requirements

NSW A6.6 Class 6 buildings

Section C Fire resistance

NSW C1.10 Fire hazard properties

NSW C2.5 Class 9a and 9c buildings

NSW C3.11 Bounding construction: Class 2, 3, 4 and 9b buildings

NSW 7. Other materials

NSW Specification C1.10 Fire hazard properties

NSW 7. Other materials

Section D Access and egress

NSW D1.2 Number of exits required

NSW D1.6 Dimensions of exits

NSW D1.10 Discharge from exits

NSW D2.1 Application of Part

NSW D2.13 Treads and risers

NSW D2.15 Thresholds

NSW D2.16 Barriers

NSW D2.19 Doorways and doors

NSW D2.21 Operation of latch

NSW D2.101 Doors in path of travel in an entertainment venue

Section E Services and equipment

NSW EP1.4 Automatic fire suppression systems

NSW Table E1.5 Requirements for sprinklers

NSW Table E2.2a General provisions

8. System Monitoring

NSW E4.6 Direction signs

NSW Specification E2.2a Smoke detectors and alarm systems

8. System Monitoring

Section F Health and amenity

Performance Requirements

NSW FP2.6 Microbial control for water systems

Deemed-to-Satisfy Provisions

NSW F2.7 Microbial (legionella) control

NSW F4.5 Ventilation of rooms

Section G Ancillary provisions

Performance requirements

NSW GP1.2 Swimming pool access and water recirculation systems

Deemed-to-Satisfy provisions

NSW G1.1 Swimming pools

NSW G1.101 Provision for cleaning windows

Performance Requirements

NSW GP5.1 Bushfire resistance

Deemed-to-Satisfy Provisions

NSW G5.1 Application of part

NSW G5.2 Protection

Section H Special use buildings

NSW H1.1 Application of Part

NSW Part H101 Entertainment venues other than temporary structures and drive-in theatres

NSW H101.1 Application of Part

NSW H101.2 Fire separation

NSW H101.3 Foyer space

NSW H101.4 Sprinkler systems for common foyers

NSW H101.5 Conventional stages

NSW H101.5.1 Extent of stage area

NSW H101.5.2 Small stages

NSW H101.5.3 Large stages

NSW H101.5.4 Fire separation of stages

NSW H101.6 Non-conventional stages

NSW H101.6.1 Small stages

NSW H101.6.2 Large stages

NSW H101.7 Flying scenery

NSW H101.8 Load notice

NSW H101.9 * * * * *

NSW H101.10 Safety curtains

NSW H101.10.1 Safety curtains—Additional requirements

NSW H101.11 Seating in rows

NSW H101.11.1 Number of seats

NSW H101.11.2 Chairs used for seating

NSW H101.11.3 Chairs in auditoriums—Level floors

NSW H101.11.4 Chairs in auditoriums—Sloping floors

NSW H101.11.5 Radiating aisles in seating areas

NSW H101.11.6 Aisles and cross-overs

NSW H101.11.7 Platforms and steps

NSW H101.11.8 Stepped platforms

NSW H101.12 Continental seating

NSW H101.12.1 Seating to be fastened

NSW H101.12.2 Maximum seats per row

NSW H101.12.3 Depths of seating rows

NSW H101.12.4 Clearance between rows

NSW H101.12.5 Chairs used for seating

NSW H101.12.6 Egress Doorways

NSW H101.12.7 Clear Areas

NSW H101.12.8 Minimum clear space

NSW H101.12.9 Doors

NSW H101.13 Provision of guardrails

NSW H101.13.1 Location

NSW H101.13.2 Fixed back seats

NSW H101.13.3 Steps between platforms

NSW H101.14 Guardrails

NSW H101.14.1 Continental seating

NSW H101.14.2 Balconies and boxes

NSW H101.14.3 Cross-overs

NSW H101.15 Dressing rooms

NSW H101.16 Storerooms

NSW H101.17 Projection suites

- NSW H101.17.1 Rooms to be provided
- NSW H101.17.2 Fire separation
- NSW H101.17.3 Concession for protection of some openings
- NSW H101.18 Basement storeys
- NSW H101.18.1 Basement storeys — More than two
- NSW H101.19 Electric mains installation
- NSW H101.19.1 Main switchboard
- NSW H101.19.2 Circuit protection
- NSW H101.19.3 Separate sub-mains
- NSW H101.20 Lighting
- NSW H101.20.1 Lighting switches
- NSW H101.20.2 Lighting levels
- NSW H101.20.3 Provision of aisle lighting
- NSW H101.20.4 Aisle lighting power supply
- NSW H101.20.5 Aisle lighting alternative power supply
- NSW H101.21 * * * * *
- NSW H101.22 Automatic smoke-and-heat vents for stages
- NSW H101.23 Solid fuel burning stoves and open fire places.
- NSW H101.24 Fuel gas cylinders
- NSW H101.24.1 General
- NSW H101.24.2 Fuel gas cylinder enclosures

NSW Part H102 Temporary structures

- NSW H102.1 Application of Part
- NSW H102.2 Exits—Exclusions
- NSW H102.3 Location of exits
- NSW H102.4 Exits to be provided
- NSW H102.5 Vertical clearances for exits
- NSW H102.6 Curtains across exits
- NSW H102.7 Curtains and blinds
- NSW H102.8 Fabrics
- NSW H102.9 Guardrails
- NSW H102.10 Seating
- NSW H102.11 Sanitary accommodation
- NSW H102.12 Projection suites
- NSW H102.13 Fireplaces and heating
- NSW H102.14 Electrical services
- NSW H102.15 Artificial lighting
- NSW H102.15.1 Emergency lighting levels
- NSW H102.15.2 Emergency lighting power supply
- NSW H102.16 Exit signs
- NSW H102.17 Fire-fighting services

NSW Part H103 Drive-in theatres

- NSW H103.1 Application of Part
- NSW H103.2 Speaker standards
- NSW H103.2.1 Lines of speaker standards
- NSW H103.3 Electrical services
- NSW H103.4 Vehicular entrances
- NSW H103.5 Lighting

NSW Section J Energy efficiency

Performance Requirements

- NSW J(A)P1
- NSW J(A)P2

NSW J(A)P3
NSW J(A)V1 Building sealing
NSW J(A)1.0 Deemed-to-Satisfy Provisions
NSW J(A)1.1 Application of Part
NSW J(A)1.2 Compliance with BCA provisions
NSW J(A)2.0 Deemed-to-Satisfy Provisions
NSW J(A)2.1 Application of Part
NSW J(A)2.2 Compliance with BCA provisions
NSW J(A)3.0 Deemed-to-Satisfy Provisions
NSW J(A)3.1 Application of Part
NSW J(A)3.2 Compliance with BCA provisions
NSW J(A)4.0 Deemed-to-Satisfy Provisions
NSW J(A)4.1 Application of Part
NSW J(A)4.2 Compliance with BCA provisions
NSW J(A)5.0 Deemed-to-Satisfy Provisions
NSW J(A)5.1 Application of Part
NSW J(A)5.2 * * * * *
NSW J(A)5.3 Compliance with BCA provisions
NSW J(B)1 Compliance with BCA provisions
NSW J3.1 Application of Part

Schedule 3 Definitions

NSW Schedule 3 Definitions

Schedule 4 Referenced documents

NSW Schedule 4 Referenced documents

Footnote: Other legislation affecting buildings

1. Abattoirs, Knackeries and Meat Premises
2. Boarding Houses
3. Children's Services
4. Crematoria, Vaults, Mortuary Churches etc.
5. Crown Land — Construction Approval
6. Dairies
7. Dangerous Goods (including Gas Installations)
8. Dining Rooms and Bars
9. Electrical Installations
10. Fire Prevention in Existing Buildings
11. Food Premises
12. Foundries
13. Historic Buildings
14. Hospitals, Nursing Homes and Health Care Buildings
15. Hot or Warm Water Systems and Air Handling Systems
16. Lift Installations
17. Moveable Dwellings (in Caravan Parks)
18. Work Health and Safety
19. Pharmacies
20. Planning Controls
21. Premises for Activities Involving Skin Penetration
22. Sanitary Plumbing, Water Supply and Sewerage
23. Septic Tank Installations
24. Sleeping Accommodation
25. Smoking Restrictions
26. Subdivision of Buildings
27. Swimming Pool Fences

28. Temporary Structures

Introduction

The NSW Building Code technical package consists of—

- (a) the Building Code of Australia (BCA) Volume One and Volume Two; and
- (b) the New South Wales BCA Appendix which contains variations to the requirements of the BCA and additional provisions applicable in New South Wales.

The technical package is accompanied by administrative provisions contained within the Environmental Planning and Assessment (EP & A) Act 1979 and the Environmental Planning and Assessment (EP & A) Regulation 2000.

Section A Governing requirements

NSW A6.6 Class 6 buildings

In A6.6 replace the definition of **Class 6** as follows:

Class 6: a shop or other building for the sale of goods by retail or the supply of services direct to the public, including—

- (a) an eating room, cafe, restaurant, milk or soft-drink bar; or
- (b) a dining room, bar, shop or kiosk part of a hotel or motel; or
- (c) a hairdresser's or barber's shop, public laundry, or undertaker's establishment; or
- (d) market or sale room, showroom, or *service station*.

Section C Fire resistance

Part C1 Fire resistance and stability

Delete C1.10(a)(v), C1.10(b) and C1.10(c)(xiii) and insert NSW C1.10(a)(v), NSW C1.10(b) and NSW C1.10(c)(xiii) as follows:

NSW C1.10 Fire hazard properties

- (a) The *fire hazard properties* of the following internal linings, materials and assemblies within a Class 2 to 9 building must comply with [Specification C1.10](#):
 - (v) In Class 9b buildings used as—
 - (A) an *entertainment venue*, a material used to cover closed back upholstered seats; and
 - (B) a public hall or the like, a proscenium curtain *required* by [Specification H1.3](#).
 - (b) Paint or fire-retardant coatings must not be used in order to make a material comply with a *required fire hazard property*, except in respect of a material referred to in [NSW Specification C1.10](#), [NSW Table 4](#) and to which Notes 4 and 5 are applicable.
 - (c) The requirements of (a) do not apply to a material or assembly if it is—
 - (xiii) an attached non-building fixture and fitting such as—
 - (A) a curtain, blind, or similar decor, other than—
 - (aa) a proscenium curtain *required* by [Specification H1.3](#); or
 - (bb) in a Class 9b building used as an *entertainment venue*, a material that is regulated under [NSW Table 4](#); and
 - (B) a whiteboard, *window* treatment or the like; or

Part C2 Compartmentation and separation

Delete C2.5(b) and insert NSW C2.5(b) as follows:

NSW C2.5 Class 9a and 9c buildings

- (b) A Class 9c building must comply with the following:
 - (i) A building must be divided into areas not more than 500 m² by smoke proof walls complying with [Specification C2.5](#).
 - (ii) A *fire compartment* must be separated from the remainder of the building by *fire walls* and notwithstanding [C2.7](#) and [Specification C1.1](#), floors with an FRL of not less than 60/60/60.
 - (iii) Except for walls provided in accordance with (b)(i) and (ii), non-loadbearing *internal walls*, and if a building is of Type C construction — all *internal walls*, between and bounding *sole-occupancy units* and bounding a *public corridor* in a *resident use area* must:
 - (A) be lined on each side with standard grade plasterboard not less than 13 mm thick or a material with at least an equivalent level of fire protection; and
 - (B) if provided with cavity insulation, contain only *non-combustible* insulation; and
 - (C) extend to the underside of—
 - (aa) the floor next above; or
 - (bb) a ceiling lined with standard grade plasterboard not less than 13 mm thick or an equivalent non-combustible material; or
 - (cc) a *non-combustible* roof covering; and
 - (D) not incorporate any penetrations above door head height unless the penetrations are adequately stopped to prevent the free passage of smoke; and
 - (E) be smoke sealed with intumescent putty or other suitable material at any construction joint, space or the

like between the top of the wall and the floor, ceiling or roof.

- (iv) *Loadbearing internal walls* must comply with the requirements of [Specification C1.1](#) and (iii)(B), (C), (D) and (E) above.
- (v) Ancillary use areas containing equipment or materials that are a high potential *fire hazard*, must be separated from the *sole-occupancy units* by smoke proof walls complying with [Specification C2.5](#).
- (vi) The ancillary use areas referred to in (v) include, but are not limited to, the following:
 - (A) A kitchen and related food preparation areas having a combined *floor area* of more than 30 m².
 - (B) A laundry, where items of equipment are of the type that are potential fire sources (e.g. gas fire dryers).
 - (C) Storage rooms greater than 10 m² used predominantly for the storage of administrative records.
- (vii) Openings in *fire walls* must be protected as follows:
 - (A) Doorways — *self-closing* or *automatic* closing –/60/30 fire doors.
 - (B) Windows — *automatic* or permanently fixed closed –/60/– fire windows or –/60/– *automatic* fire shutters.
 - (C) Other openings — construction having an FRL not less than –/60/–.

Part C3 Protection of openings

Delete C3.11(d) and insert NSW C3.11(d) as follows:

NSW C3.11 Bounding construction: Class 2, 3, 4 and 9b buildings

- (d) Protection for a doorway *required* under (a), (b) or (c) must be at least—
 - (i) in a building of Type A construction — a *self-closing* –/60/30 fire door; and
 - (ii) in a building of Type B or C construction — a *self-closing*, tight fitting, solid core door not less than 35 mm thick, except—
 - (iii) in a Class 3 building used as a *residential care building* protected with a sprinkler system complying with [Specification E1.5](#), a tight fitting solid core door not less than 35 mm thick that is—
 - (A) *self-closing*; or
 - (B) fitted with a free-arm action closing device which closes the door or causes the door to remain closed (without preventing manual re-opening), upon the detection of smoke by a detector located within the room.

Insert NSW C3.11(h) as follows:

- (h) In a Class 9b building used as an *entertainment venue*, openings in construction *required* to separate one space from another must be protected in accordance with [C3.4](#).

NSW Specification C1.10

Fire hazard properties

Delete Clause 7 and Table 4 and insert NSW Clause 7 and NSW Table 4

NSW 7. Other materials

Materials and assemblies in a Class 2 to 9 building not included in **Clauses 3, 4, 5 or 6** must not exceed the indices set out in [NSW Table 4](#).

NSW Table 4 Other materials

Material or assembly location	Flammability Index	Spread-of-Flame Index	Smoke-Developed Index
Fire control rooms subject to Specification E1.8 and fire-isolated exits , other than a sarking-type material used in a ceiling or used as an attachment or part of an attachment to a building element. <small>Note 1</small>	N/A	0	2
Class 9b buildings used as an entertainment venue , a material used to cover closed back upholstered seats in any part available to the public where— <small>Note 4</small> (a) smoking is permitted; or (b) flame is exposed in connection with the preparation of meals.	N/A	6	5
Class 9b buildings used as an entertainment venue , a material used as a curtain, blind or similar decor in any part available to the public. <small>Notes 4 and 5</small>	6	N/A	N/A
Class 9b buildings used as an entertainment venue , a material used to form a cinematograph screen. <small>Notes 4, 5 and 6</small>	12	0	7
Class 9b buildings used as a public hall or the like, a proscenium curtain required by Specification H1.3 .	N/A	0	3
Escalators, moving walkways or non- required non- fire-isolated stairways or pedestrian ramps subject to Specification D1.12 .	N/A	0	5
Sarking-type materials in a fire control room subject to Specification E1.8 or a fire-isolated exit used in the form of an exposed wall or ceiling.	0	N/A	N/A

New South Wales

Material or assembly location	Flammability Index	Spread-of-Flame Index	Smoke-Developed Index
<i>Sarking-type materials</i> other than in a fire control room subject to Specification E1.8 or a fire-isolated <i>exit</i> used in the form of an exposed wall or ceiling. <small>Note 2</small>	5	N/A	N/A
Other materials or locations and insulation materials other than <i>sarking-type materials</i> . <small>Notes 2 and 3</small>	N/A	9	8 if the <i>Spread-of-Flame Index</i> is more than 5

Notes to NSW Table 4:

1. In a fire control room or *fire-isolated stairway*, a material used as an attachment or part of an attachment to a building element must, if *combustible*, be attached directly to a *non-combustible* substrate and not exceed 1 mm finished thickness.
2. A material, other than one located within a fire-isolated *exit* or fire control room, may be covered on all faces by concrete or masonry not less than 50 mm thick, as an alternative to meeting the specified indices.
3. In the case of a composite member or assembly, the member or assembly must be constructed so that when assembled as proposed in a building—
 - a. any material which does not comply with this Table is protected on all sides and edges from exposure to the air; and
 - b. the member or assembly, when tested in accordance with [Schedule 6](#), has a *Spread-of-Flame Index* and a *Smoke-Developed Index* not exceeding those prescribed in this Table; and
 - c. the member or assembly retains the protection in position so that it prevents ignition of the material and continues to screen it from access to free air for a period of not less than 10 minutes.
4. Any fire-retardant coating used in an *entertainment venue* to make a material subject to (a), (b) or (c) comply with a *required Flammability Index*, *Spread-of-Flame Index* or *Smoke-Developed Index* must be certified by—
 - a. its manufacturer or distributor—
 - i. as approved for use with the fabric to achieve the *required* indices; and
 - ii. to retain its retardancy effect after a minimum of 5 commercial dry cleaning or laundering operations carried out in accordance with AS 2001.5.4, Procedure 7A, using non-phosphate ECE reference detergent A (without optical brightener); and
 - b. the applicator as having been carried out in accordance with the manufacturer's specification.
5. Materials subject to (b) or (c) must have a label affixed to a representative sample of each different material indicating, in legible characters—
 - a. name of manufacturer; and
 - b. trade name and description of material's composition; and
 - c. retardant treatment (if any), name of applicator and date of application; and
 - d. AS 1530 Part 2 and/or AS/NZS 1530 Part 3 test number and its *Flammability Index*, *Spread-of-Flame Index* and *Smoke-Developed Index*; and
 - e. approved methods of cleaning.
6. A cinematograph screen must have a supporting frame of metal construction.

Section D Access and egress

Part D1 Provision for escape

Add D1.2(d)(vii) as follows:

NSW D1.2 Number of exits required

- (d)
- (vii) any *storey* or *mezzanine* within an *auditorium* in an *entertainment venue*.

Insert NSW D1.6(f)(vi), and (j) as follows:

NSW D1.6 Dimensions of exits

- (f)
- (vi) in a Class 9b building used as an *entertainment venue*—
- (A) in parts of the building used by the public, the width of the *required exit* or path of travel, and the unobstructed width of each doorway must not be less than 1 m and not more than 3 m; and
- (B) in other parts of the building, doorways must comply with D1.6(f).
- (j) in a Class 9b building used as an *entertainment venue*—
- (i) the aggregate width must be not less than 2 m plus 500 mm for every 50 persons or part in excess of 200; and
- (ii) D1.6(b), (c) and (d) do not apply; and
- (iii) where one or more paths of travel merge, the width of the combined path of travel must be not less than the sum of the *required* widths of those paths of travel; and
- (iv) the *required* widths of the paths of travel connecting the *exits* from the building to a public road or *open space* must comply with (iii).

Delete D1.10(f) and insert NSW D1.10(f) as follows:

NSW D1.10 Discharge from exits

- (f) In a Class 9b building used as an *entertainment venue*, at least half of the *required* number of *exits* from each *storey* or *mezzanine*, and at least half of the aggregate width of such *exits* must discharge otherwise than through the main entrance, or the area immediately adjacent to the main entrance of the building.

Vary Table D1.13 by deleting the row for “Theatre and public hall” and inserting the following rows:

NSW Table D1.13 Area per person according to use

Type of use	Area per person
<i>Entertainment venue</i> —other than <i>auditorium</i>	1.2 m ²
<i>Auditorium</i> —standing area	0.5 m ²
<i>Auditorium</i> —removable seating	1.0 m ²
<i>Auditorium</i> —fixed seating	count seats
<i>Auditorium</i> —bench seating	450 mm/person

Part D2 Construction of exits

Add NSW D2.1(c) as follows:

NSW D2.1 Application of Part

In addition—

- (c) in a Class 9b building used as an *entertainment venue*—
- (i) *Clauses NSW D2.13(a)(ix), (a)(x), and (a)(xi), NSW D2.15(d), NSW Table D2.16a 1(d), and NSW D2.19(b)(v)*

New South Wales

apply to only those parts of the building used by the public; and

- (ii) the general requirements of [Part D2](#) apply to all other parts of the building.

Insert NSW D2.13(a)(ix), (a)(x) and (a)(xi) as follows:

NSW D2.13 Treads and risers

- (a)
- (ix) conspicuous edges to the treads of steps in a Class 9b building used as an *entertainment venue*; and
- (x) in a Class 9b building used as an *entertainment venue*, not more than one helical stairway serving as a *required exit* and that stairway must—
- (A) have a width of not less than 1500 mm; and
- (B) be of constant radius; and
- (C) be constructed so that each tread, when measured 500 mm in from its narrow end, has a width of at least 280 mm; and
- (xi) in a Class 9b building used as an *entertainment venue*, in a curved stairway serving as a *required exit*— an internal radius of not less than twice the width of the stair.

Renumber D2.15(d) to (e) and insert NSW D2.15(d) as follows:

NSW D2.15 Thresholds

- (d) in a Class 9b building used as an *entertainment venue*, the door sill of a doorway opening to a road, *open space*, external stair landing or external balcony is not more than 50 mm above the finished floor level to which the doorway opens; or
- (e) in other cases—
- (i) the doorway opens to a road or *open space*, external stair landing or external balcony; and
- (ii) the door sill is not more than 190 mm above the finished surface of the ground, balcony, or the like, to which the doorway opens.

Delete Table D2.16a 1 and substitute NSW Table D2.16a 1 as follows:

NSW D2.16 Barriers

NSW Table D2.16a 1. Barrier construction

1. Barrier heights		
Location		Minimum height
(a)	Stairways or ramps with a gradient of 1:20 or steeper.	865 mm
(b)	Landings to a stair or ramp where the barrier is provided along the inside edge of the landing and does not exceed 500 mm in length.	
(c)	In front of fixed seating on a <i>mezzanine</i> or balcony within an auditorium in a Class 9b building.	1 m; or 700 mm and a horizontal projection that extends not less than 1 m outwards from the top of the barrier; or in a Class 9b building used as an <i>entertainment venue</i> , the height prescribed for guardrails in NSW H101.14.2 and NSW H102.9 .
(d)	In a Class 9b building used as an <i>entertainment venue</i> — (i) stairways or ramps; and (ii) the floor of any access path,	1 m when provided inside the building; and 1200 mm when provided externally to the building.

New South Wales

	balcony, landing or the like.	
(e)	In all other locations.	1 m.

Notes to NSW Table D2.16a 1.:

1. Heights are measured vertically from the surface beneath, except that for stairways the height must be measured above the nosing line of the stair treads.
2. A transition zone may be incorporated where the barrier height changes from 865 mm on a stair flight or ramp to 1 m at a landing or floor.

Insert NSW D2.19(b)(v) as follows:

NSW D2.19 Doorways and doors

(b)

- (v) in a Class 9b building used as an *entertainment venue*—
- (A) must not be fitted with a collapsible gate, accordion door, turnstile or rigid barrier; and
 - (B) if fitted with a door, must be—
 - (aa) a swing door which opens in the direction of egress; and
 - (bb) doors hung in two folds where the unobstructed width of the doorway is more than 1 m; and
 - (C) a doorway or opening within sight of the audience but not intended for egress must have a notice displayed clearly indicating its purpose and such a notice must not be internally illuminated; and
 - (D) notwithstanding (b)(iii), a sliding door may be fitted where—
 - (aa) it leads directly to a road or *open space* and forms a main entrance; and
 - (bb) it is capable of swinging in the direction of egress when pressure is applied to the inside face of the door; and
 - (cc) the door is provided with signage that clearly indicates to persons seeking egress, the potential for swinging the door open in an emergency.

Delete D2.21(c) and insert NSW D2.21(c) and (d) as follows:

NSW D2.21 Operation of latch

- (c) The requirements of (a) do not apply in a Class 9b building (other than a *school*, an *early childhood centre* or a building used for religious purposes) to a door in a *required exit*, forming part of a *required exit* or in the path of travel to a *required exit* serving a *storey* or room accommodating more than 100 persons, determined in accordance with D1.13, in which case it must be readily openable—
- (i) without a key from the side that faces a person seeking egress; and
 - (ii) by a single hand pushing action on a single device such as a panic bar located between 900 mm and 1.2 m from the floor; and
 - (iii) where a two-leaf door is fitted, the provisions of (i) and (ii) need only apply to one door leaf if the appropriate requirements of D1.6 are satisfied by the opening of that one leaf; and
 - (iv) where the door is a door in a path of travel providing re-entry to the building from a balcony, terrace or the like, it may be fitted with key-operated fastenings only, the tongues of which must be locked in the retracted position whenever the building is occupied by the public, so the door can yield to pressure.
- (d) The requirements of (a) and (c) do not apply to a door serving a Class 9b building used as an *entertainment venue* where the following provisions apply to a door or gate used by the public—
- (i) on a door, the single device operating the latch or bolts must be a panic bar if those doors are to be secured; or
 - (ii) an *exit* door or gate used by the public as the main entrance may be fitted with key-operated fastenings only, the tongues of which must be locked in the retracted position whenever the building is occupied by the public so the door or gate can yield to pressure from within; or
 - (iii) a door from a balcony, terrace or the like, being a door in a path of travel providing re-entry to the building, may comply with the locking provision of (ii) above.

Add NSW D2.101 as follows:

NSW D2.101 Doors in path of travel in an entertainment venue

In a Class 9b building used as an *entertainment venue*, a doorway in a path of travel must comply with [NSW D2.19\(b\)\(v\)](#).

Section E Services and equipment

Part E1 Fire fighting equipment

NSW EP1.4 Automatic fire suppression systems

Note:

NSW has requirements for fire sprinkler systems in certain residential aged care facilities. See the Department of Planning and Environment website www.planning.nsw.gov.au.

NSW Table E1.5 Requirements for sprinklers

Note:

NSW has requirements for fire sprinkler systems in certain residential aged care facilities. See the Department of Planning and Environment website www.planning.nsw.gov.au.

Part E2 Smoke hazard management

NSW Table E2.2a General provisions

NCC Volume One Table E2.2a is applicable in NSW except for sub-clause (a) of the “Large isolated buildings” provisions.

Delete Table E2.2b Class 9b Assembly buildings and substitute NSW Table E2.2b Class 9b buildings as follows:

NSW Table E2.2b Specific provisions

Class 6 buildings - In fire compartments more than 2000 m²
The provisions of NCC Volume One Table E2.2b for Class 6 buildings are applicable in NSW.
Class 9b buildings
Class 9b - Assembly buildings
The following provisions apply to all Class 9b <i>assembly buildings</i> :
(a) Automatic shutdown:
A building or part of a building used as an <i>assembly building</i> must be provided with <i>automatic</i> shutdown of any air-handling system (other than non-ducted individual room units with a capacity not more than 1000 L/s and miscellaneous exhaust air systems installed in accordance with Sections 5 and 6 of AS 1668.1) which does not form part of the smoke hazard management system, on the activation of—
(i) smoke detectors installed complying with Clause 6 of Specification E2.2a ; and
(ii) any other installed fire detection and alarm system, including a sprinkler system (other than a FPAA101D or FPAA101H system) complying with Specification E1.5 .
(b) Basements:
A basement not counted in the <i>rise in storeys</i> in accordance with C1.2 , less than 2000 m ² used as an <i>assembly building</i> or part of an <i>assembly building</i> containing an <i>auditorium</i> or other public area, must be equipped with—
(i) an <i>automatic</i> smoke detection system in accordance with Specification E2.2a ; or
(ii) an <i>automatic</i> zone pressurisation system in accordance with AS 1668.1 if the basement has more than one <i>fire compartment</i> ; or if the basement forms part of a multi <i>fire compartmented</i> building served by the zone pressurisation system; or
(iii) a sprinkler system (other than a FPAA101D or FPAA101H system) complying with Specification E1.5 .
(c) Stages and backstages:
(i) For the purposes of this Table, where a <i>stage</i> is separated from the <i>auditorium</i> by a proscenium wall incorporating a proscenium opening, a backstage room or area that is not separated from the <i>stage</i> by construction having an FRL of not less than 60/60/60, is taken to form part of the <i>stage</i> .
(ii) A building or part of a building used as an <i>assembly building</i> which has a <i>stage</i> —
(A) with a <i>floor area</i> of more than 50 m ² and not more than 150 m ² must, over the <i>stage</i> , be provided with—

New South Wales

- (aa) an *automatic* smoke exhaust system complying with [Specification E2.2b](#) (including [Figure 2](#)); or
- (ab) roof mounted *automatic smoke-and-heat vents* complying with [NSW H101.22](#), in a single *storey* building or the top *storey* of a multi *storey* building; or
- (B) with a *floor area* of more than 150 m² must, over the *stage*, be provided with an *automatic* smoke exhaust system complying with [Specification E2.2b](#) (including [Figure 2](#)); or
- (C) equipped with means of *flying scenery* must, over the *stage*, be provided with an *automatic* smoke exhaust system complying with [Specification E2.2b](#) (including [Figure 2](#)).

Night clubs, discotheques and the like

A building or part of a building being a night club, discotheque or the like, must be provided with—

- (a) in an auditorium—
 - (i) an *automatic* smoke exhaust system complying with [Specification E2.2b](#); or
 - (ii) roof mounted *automatic smoke-and-heat vents* complying with [Specification E2.2c](#), in a single *storey* building or the top *storey* of a multi *storey* building; or
 - (iii) a sprinkler system (other than a FPAA101D or FPAA101H system) complying with [Specification E1.5](#) with fast response sprinkler heads; and
- (b) in all other areas—
 - (i) where a building or part of a building has a *floor area* not more than 2000 m²—
 - (A) one of the smoke hazard management measures listed under (a) above; or
 - (B) an *automatic* smoke detection and alarm system complying with [Specification E2.2a](#); or
 - (ii) where a building or part of a building has a *floor area* of more than 2000 m², smoke hazard management measures as provided for under ‘Other Assembly Buildings’ in [NSW Table E2.2b](#).

Note: Paragraph (a) applies only to an auditorium designed principally to accommodate an audience to an entertainment.

Exhibition halls, museums and art galleries

A building or part of a building used as an exhibition hall, museum, art gallery or the like, must be provided with—

- (a) where the *floor area* is more than 2000 m² and not more than 3500 m²—
 - (i) an *automatic* smoke exhaust system complying with [Specification E2.2b](#); or
 - (ii) roof mounted *automatic smoke-and-heat vents* complying with [Specification E2.2c](#) in a single *storey* building or the top *storey* of a multi *storey* building; or
 - (iii) a sprinkler system (other than a FPAA101D or FPAA101H system) complying with [Specification E1.5](#); and
- (b) where the *floor area* is more than 3500 m², a sprinkler system (other than a FPAA101D or FPAA101H system) complying with [Specification E1.5](#) and—
 - (i) an *automatic* smoke exhaust system complying with [Specification E2.2b](#); or
 - (ii) roof mounted *automatic smoke-and-heat vents* complying with [Specification E2.2c](#), in a single *storey* building or the top *storey* of a multi *storey* building.

Other assembly buildings

- (a) Unless otherwise described in (b), in a building or part of a building used as an *assembly building* (not being a night club, discotheque or the like; or an exhibition hall, museum or art gallery) where the *floor area* of a *fire compartment* is more than 2000 m², the *fire compartment* must be provided with—
 - (i) an *automatic* smoke exhaust system complying with [Specification E2.2b](#); or
 - (ii) roof mounted *automatic smoke-and-heat vents* complying with [Specification E2.2c](#), in a single *storey* building or the top *storey* of a multi *storey* building; or
 - (iii) if the *floor area* of the *fire compartment* is not more than 5000 m² and the building has a *rise in storeys* of not more than 2—
 - (A) an *automatic* smoke detection and alarm system complying with [Specification E2.2a](#); or
 - (B) a sprinkler system (other than a FPAA101D or FPAA101H system) complying with [Specification E1.5](#).
- (b) The following buildings are exempt from the provisions of (a):
 - (i) Sporting complexes, (including sports halls, gymnasiums, *swimming pools*, ice and roller rinks, and the like) other than indoor sports stadiums with total spectator seating for more than 1000 persons.
 - (ii) Churches and other places used solely for religious worship.
 - (iii) *School* classrooms.

New South Wales

Note to NSW Table E2.2b: Smoke hazard management provisions for an *assembly building* used for multiple purposes must comply with all the relevant provisions of [NSW Table E2.2b](#) according to usage.

NSW Specification E2.2a

Smoke detectors and alarm systems

Delete Clause 8(e) as follows:

8. System Monitoring

- (e) (deleted)

Part E4 Emergency lighting, exit signs and warning systems

Delete E4.6 and insert NSW E4.6 as follows:

NSW E4.6 Direction signs

If an *exit* is not readily apparent to persons occupying or visiting the building, then *exit* signs must be installed—

- (a) in appropriate positions in corridors, hallways, lobbies, foyers, auditoria, and the like, indicating the direction to a *required exit*; and
- (b) in a Class 9b building used as an *entertainment venue* — in any external egress path to a road where the *exit* does not open directly onto a road.

Section F Health and amenity

Part F2 Sanitary and other facilities

Delete FP2.6 (and Limitation) and replace with NSW FP2.6:

Performance Requirements

NSW FP2.6 Microbial control for water systems

(deleted).

Note.

This Performance Requirement is deleted from the BCA in NSW, as the installation of hot water, warm water and cooling water systems (and their operation and maintenance) is regulated in the Public Health Regulation, 2012, under the Public Health Act, 2010.

Delete F2.7:

Deemed-to-Satisfy Provisions

NSW F2.7 Microbial (legionella) control

(deleted).

Note.

This clause is deleted from the BCA in NSW, as the installation of hot water, warm water and cooling water systems (and their operation and maintenance) is regulated in the Public Health Regulation, 2012, under the Public Health Act, 2010.

Part F4 Light and ventilation

Delete F4.5(b) and insert NSW F4.5(b) as follows:

NSW F4.5 Ventilation of rooms

(b) a mechanical ventilation or air-conditioning system complying with AS 1668.2.

Note.

The reference to AS/NZS 3666.1 is deleted from the BCA in NSW, as the need to comply with this standard is regulated in the Public Health Regulation, 2012, under the Public Health Act, 2010.

Section G Ancillary provisions

Part G1 Minor structures and components

Delete GP1.2(a) and insert NSW GP1.2(a) as follows:

Performance requirements

NSW GP1.2 Swimming pool access and water recirculation systems

- (a) A barrier must be provided to a *swimming pool* and must—
- (i) be continuous for the full extent of the hazard; and
 - (ii) be of a strength and rigidity to withstand the foreseeable impact of people; and
 - (iii) restrict the access of young children to the pool and the immediate pool surrounds; and
 - (iv) have any gates and doors fitted with latching devices not readily operated by young children, and constructed to automatically close and latch.

Application:

NSW GP1.2(a) only applies to a *swimming pool* with a depth of water of more than 300 mm, in conjunction with the Swimming Pools Act 1992 and the Swimming Pools Regulation 2018.

Delete G1.1(a) and (b) and insert NSW G1.1(a) and (b) as follows:

Deemed-to-Satisfy provisions

NSW G1.1 Swimming pools

- (a) G1.1(b) applies to the technical construction requirements for barriers to restrict access to *swimming pools*, subject to out-of-ground pool walls and the walls of above ground pools, including inflatable pools, not being considered to be effective barriers.
- (b) A *swimming pool* with a depth of water more than 300 mm and which is associated with a Class 2 or 3 building or Class 4 part of a building, must have suitable barriers to restrict access by young children to the immediate pool surrounds in accordance with:
- (i) AS 1926 Parts 1 and 2; or
 - (ii) if the *swimming pool* is a *spa pool*:
 - (A) The requirements of (b)(i); or
 - (B) Clause 9 of the Swimming Pools Regulation 2018.

Note:

The Swimming Pools Act 1992 and the Swimming Pools Regulation 2018, applicable to *swimming pools* with a depth of water of more than 300 mm, regulate the circumstances in which a barrier is required and prevail in the case of any inconsistency.

Add NSW G1.101 as follows:

NSW G1.101 Provision for cleaning windows

- (a) A building must provide for a safe manner of cleaning any *windows* located 3 or more *storeys* above ground level.
- (b) A building satisfies (a) where—
- (i) the *windows* can be cleaned wholly from within the building; or
 - (ii) provision is made for the cleaning of the *windows* by a method complying with the Work Health and Safety Act 2011 and regulations made under that Act.

Part G5 Construction in bushfire prone areas

Delete GP5.1 and insert NSW GP5.1 as follows:

Performance Requirements

NSW GP5.1 Bushfire resistance

A building that is constructed in a *designated bushfire prone area* must, to the degree necessary, be designed and constructed to reduce the risk of ignition from a bushfire appropriate to the—

- (a) potential for ignition caused by burning embers, radiant heat or flame generated by a bushfire; and
- (b) intensity of the bushfire attack on the building.

Application:

NSW GP5.1 only applies in a *designated bushfire prone area*, to—

- (a) a Class 2 or 3 building;
- (b) a Class 4 part of a building;
- (c) a Class 9 building that is a *special fire protection purpose*; or
- (d) a Class 10a building or deck associated with a building or part referred to in (a), (b) or (c).

Delete G5.1 and insert NSW G5.1 as follows:

Deemed-to-Satisfy Provisions

NSW G5.1 Application of part

The *Deemed-to-Satisfy Provisions* of this part apply to—

- (a) a Class 2 or 3 building; or
- (b) a Class 4 part of a building; or
- (c) a Class 9 building that is a *special fire protection purpose*; or
- (d) a Class 10a building or deck associated with a building or a part referred to in (a), (b) or (c), located in a *designated bushfire prone area*.

Delete G5.2 and insert NSW G5.2 as follows:

NSW G5.2 Protection

In a *designated bushfire prone area*, a Class 2 building, a Class 3 building, a Class 4 part of a building or a Class 9 building that is a *special fire protection purpose* or a Class 10a building or deck associated with such a building or part, must comply with the following—

- (a) AS 3959 except—
 - (i) as amended by *Planning for Bush Fire Protection*; and
 - (ii) for Section 9 Construction for Bushfire Attack Level FZ (BAL-FZ). Buildings subject to BAL-FZ must comply with specific conditions of development consent for construction at this level; or
- (b) the requirements of (a) above as modified by the development consent following consultation with the NSW Rural Fire Service under section 4.14 of the Environmental Planning and Assessment Act 1979 if required; or
- (c) the requirements of (a) above as modified by development consent with a bushfire safety authority issued under section 100B of the Rural Fires Act 1997 for the purposes of integrated development.

Section H Special use buildings

Part H1 Class 9b buildings

Delete H1.1 and insert NSW H1.1 as follows:

NSW H1.1 Application of Part

- (a) For a Class 9b building or part of a building that is not an *entertainment venue*—
- (i) The *Deemed-to-Satisfy Provisions* of Part H1 apply to every enclosed Class 9b building or part of a building which—
 - (A) is a *school* assembly, church or community hall with a *stage* and any *backstage* area with a total *floor area* of more than 300m²; or
 - (B) otherwise, has a *stage* and any *backstage* area with a total *floor area* of more than 200m²; or
 - (C) has a *stage* with an associated rigging loft.
 - (ii) Notwithstanding (a)(i)—
 - (A) *H1.4* applies to every open or enclosed Class 9b building; and
 - (B) *H1.7* applies to every enclosed Class 9b building.
- (b) For a Class 9b building that is an *entertainment venue*, *NSW Part H101*, as follows, applies in replacement of Part H1:

NSW Part H101

Entertainment venues other than temporary structures and drive-in theatres

Note.

NSW Part H101 contains *Deemed-to-Satisfy Provisions* additional to those contained in Sections C, D, E, F and G for buildings containing or used as *entertainment venues* other than temporary structures and drive-in theatres.

NSW H101.1 Application of Part

This Part applies to every *entertainment venue* as described in the Environmental Planning and Assessment Regulation 2000.

NSW H101.2 Fire separation

If an *entertainment venue* forms part only of a building, then—

- (a) the whole of the *entertainment venue*; or
- (b) the part containing the *stage*, *backstage* area and *auditorium*,

must be separated from the other parts of the building by construction having an FRL of not less than 60/60/60.

NSW H101.3 Foyer space

Where an *entertainment venue* is used principally for the purpose of—

- (a) exhibiting *films*; or
- (b) conducting live *stage* productions,

foyer space (excluding stairways and concession areas) must be provided on the basis of at least 0.25 m² for each person that the *auditorium* accommodates.

NSW H101.4 Sprinkler systems for common foyers

In an *entertainment venue*, where multiple *auditoriums* have a foyer in common, the following applies—

- (a) If the foyer serves not more than 2 *auditoriums*; that foyer must be separated from any adjoining foyer by construction having an FRL of not less than 60/60/60.
- (b) If the foyer serves more than 2 *auditoriums*, a sprinkler system (other than a FPAA101D or FPAA101H system) complying with *Specification E1.5* must be installed—
 - (i) throughout the *storey* containing the foyer; and
 - (ii) throughout each *storey* in the building below that *storey*.

NSW H101.5 Conventional stages

This clause applies to a conventional *stage*, that is, a *stage* which is separated from the *auditorium* by a proscenium wall incorporating a proscenium opening.

NSW H101.5.1 Extent of stage area

If a room or area is not separated from the remainder of a conventional *stage* by construction having an FRL of not less than 60/60/60, the room or area is, for the purposes of this Part, to be taken to form part of the *stage*.

NSW H101.5.2 Small stages

A *stage* which is more than 50 m² but not more than 150 m² in area must have 2 or more means of egress from the *stage* and *backstage* area provided otherwise than through the proscenium wall.

NSW H101.5.3 Large stages

A *stage* which is more than 150 m² in area—

- (a) must have installed directly above the *stage* a suitable sprinkler system (other than a FPAA101D or FPAA101H

- system) complying with [Specification E1.5](#); and
- (b) must have the proscenium opening protected by a safety curtain that complies with [NSW H101.10](#); and
 - (c) must have a line of open drenchers or open sprinklers provided above the proscenium opening on the [stage](#) side and in such a position as to be able to discharge over the inside face of the safety curtain; and
 - (d) must have 2 or more means of egress from the [stage](#) and [backstage](#) area provided otherwise than through the proscenium wall.

NSW H101.5.4 Fire separation of stages

A [stage](#) which is more than 50 m² in area, and all areas below such a [stage](#), must (with the exception of the proscenium opening) be separated from the [backstage](#) and the remainder of the building by construction having an FRL of not less than 60/60/60.

NSW H101.6 Non-conventional stages

This clause applies to a [stage](#) that is not a conventional [stage](#) within the meaning of [NSW H101.5](#).

NSW H101.6.1 Small stages

A [stage](#) which is more than 50 m² but not more than 150 m² in area must have at least 2 means of egress from the [backstage](#) area.

NSW H101.6.2 Large stages

A [stage](#) which is more than 150 m² in area must have at least 2 means of egress from the [backstage](#) area.

NSW H101.7 Flying scenery

Where there is a [grid](#) or other means of [flying scenery](#) over—

- (a) a conventional [stage](#) or non-conventional [stage](#)—
 - (i) the [stage](#) must be provided with a sprinkler system (other than a FPAA101D or FPAA101H system) complying with [Specification E1.5](#); and
 - (ii) a fly gallery, bridge [grid](#), rigging loft, tie gallery or electric light perch must—
 - (A) comply with AS 1657; and
 - (B) be of [non-combustible](#) construction;
 - (iii) a fly gallery must be provided with at least 2 means of egress, one on each side of the [stage](#);
 - (iv) a [grid](#) or rigging loft must be provided with at least 2 means of egress;
 - (v) if exposed steel is used in the construction of a roof, fly or tie gallery, the roof, fly or tie gallery must be so designed that, in the event of its structural failure due to fire, the wall structure of the building will not be affected.
 - (vi) structural steel supporting the [stage](#) tower must be enclosed by masonry or concrete and have an FRL of not less than 120/120/120; and
- (b) in the case of a conventional [stage](#), the following additional requirements apply:
 - (i) The proscenium wall must—
 - (A) have an FRL of not less than 120/120/120; and
 - (B) have the proscenium opening protected by a rigid safety curtain in accordance with [NSW H101.10.1](#);
 - (ii) the walls forming the [stage](#) area, and the area beneath the [stage](#), must be constructed of masonry or concrete and have an FRL of not less than 120/120/120.

NSW H101.8 Load notice

A notice indicating the actual distributed and concentrated load for which the [stage](#) floor has been designed must be conspicuously and permanently displayed in a position adjacent to the [stage](#) floor.

This notice must be in legible letters and figures—

- (a) at least 50 mm high; and
- (b) on a contrasting background.

NSW H101.9 * * * * *

This clause has been deliberately left blank.

NSW H101.10 Safety curtains

A safety curtain *required* by [NSW H101.5.3](#) must—

- (a) be made of *non-combustible* material; and
- (b) be so fitted that, when it is closed, it forms an efficient smoke seal between the *stage* and the *auditorium*; and
- (c) be capable of withstanding a pressure differential of 0.5 kPa over its entire surface area; and
- (d) be run on steel guides located on each side of the proscenium opening; and
- (e) remain engaged in its guides if the guides, together with their fittings and attachments and that part of the curtain engaged in the guides, are subjected to a pressure differential of 1 kPa; and
- (f) be of sufficiently robust construction to withstand damage by scenery, *stage* properties and falling debris; and
- (g) be capable of closing the proscenium opening within 30 seconds, either by gravity slide or by motor assisted mechanisms; and
- (h) have manual controls, located on each side of the *stage*, for the closing of the curtains; and
- (i) have a notice displayed adjacent to the operating controls, in clear and legible letters and symbols of adequate size, indicating its use and operation; and
- (j) when operated, actuate a distinctive warning alarm audible to persons on the *stage* and must not be reliant for its operation solely on the primary electricity supply; and
- (k) have the words “Safety Curtain” exhibited on the curtain in clear and legible letters of adequate size to enable them to be read from all parts of the *auditorium*.

NSW H101.10.1 Safety curtains—Additional requirements

A rigid safety curtain *required* by [NSW H101.7](#) must comply with the requirements of [NSW H101.10](#) and it must—

- (a) be vertically hung from steel cables;
- (b) be framed with structural steel that complies with AS 4100;
- (c) be sheeted and finished on both faces with sheet steel or other *non-combustible* material of such gauge, and so fastened to its frame, as to ensure that its frame is capable of withstanding distortion arising from heat; and
- (d) when closed, overlap the proscenium opening by not less than 300 mm at each side and by not less than 600 mm at the top.

NSW H101.11 Seating in rows

This clause does not apply to *continental seating* or seating at tables.

NSW H101.11.1 Number of seats

Subject to [NSW H101.11.5](#), where seating is arranged in *rows*, the maximum number of seats in each *row* must not exceed—

- (a) 8 where there is an *aisle* at one end only of the *row*; or
- (b) 16 where there are *aisles* on both ends of the *row*.

NSW H101.11.2 Chairs used for seating

Chairs used for seating must—

- (a) where they have arms, be at least 500 mm from centre to centre; and
- (b) where they do not have arms, be at least 450 mm from centre to centre; and

- (c) have a *minimum lateral clearance* of at least 300 mm between—
 - (i) the front of each chair and the back of the chair in front; or
 - (ii) if a guardrail is provided in front of the chairs, between the front of each chair and the guardrail; and
- (d) have a distance of at least 950 mm between the back of each chair and the back of the chair in front.

NSW H101.11.3 Chairs in auditoriums—Level floors

Chairs in an *auditorium* that has a level floor must be—

- (a) securely fastened to the floor; or
- (b) secured together in groups of not less than 4 and not more than 16.

NSW H101.11.4 Chairs in auditoriums—Sloping floors

Chairs in an *auditorium* having a sloping floor, or having stepped or inclined platforms, must be securely fastened to the floor or platform.

NSW H101.11.5 Radiating aisles in seating areas

Where seating is securely fastened to the floor and arranged in *rows* of concentric circles, semi-circles or segments of circles, with radiating *aisles*—

- (a) the number of seats in each row between 2 *aisles* must not exceed 24; and
- (b) each seat must—
 - (i) have a *minimum lateral clearance* of at least 325 mm between the front of the seat and the back of the seat in front; and
 - (ii) have a distance of at least 975 mm between the back of the seat and the back of the seat in front; and
- (c) the *rows* may be curved or straight.

NSW H101.11.6 Aisles and cross-overs

Where *aisles* and *cross-overs* are provided—

- (a) each *aisle* must have a width of at least 1000 mm and each *cross-over* must have a width of at least 1500 mm; and
- (b) the floor of each *aisle* must not have a grade of more than 1 in 8 at any part; and
- (c) if there is a step from a *row* to an *aisle* or from a landing to an *aisle*, the step must not project into the *aisle*.

NSW H101.11.7 Platforms and steps

Where an *aisle* contains platforms or steps—

- (a) the platforms and steps must extend for the full width of the *aisle*; and
- (b) if there are no intervening steps between levels of platforms, the height of the platform riser must not be more than 200 mm; and
- (c) if there are one or more intervening steps between levels of platforms—
 - (i) each riser must be at least 100 mm but not more than 200 mm high; and
 - (ii) each going must be at least 250 mm deep; and
 - (iii) risers and goings must be uniform; and
- (d) goings which are more than 450 mm deep at platform level must not have a grade of more than 1 in 50; and
- (e) at the entrance from the *aisle* to each *row* there must be a clear level floor space, extending the full width of the *aisle*, of at least 300 mm, measured from the back of the *row* in front; and
- (f) any going projecting in front of a seat adjacent to an *aisle* must be protected by a guardrail.

NSW H101.11.8 Stepped platforms

Where stepped platforms without chairs or stepped platforms with bench seats, are used for seating—

- (a) each platform must be at least 700 mm deep; and
- (b) each seating space must be at least 450 mm wide, measured along the front of the platform or bench seat; and
- (c) each seating space must be numbered consecutively; and
- (d) at the entrance from the *aisle* to each *row* there must be a clear level floor space, extending the full width of the *aisle*, of at least 300 mm, measured from the back of the *row* in front; and
- (e) any going projecting in front of a seat adjacent to an *aisle* must be protected by a guardrail; and
- (f) in the case of stepped platforms with bench seats, there must be at least 300 mm between the back of each seat and the front of the platform behind, or the front of the bench seat behind, whichever is the closer.

NSW H101.12 Continental seating

This Clause applies to *continental seating*.

NSW H101.12.1 Seating to be fastened

Seating must be securely fastened to the floor.

NSW H101.12.2 Maximum seats per row

The number of seats in a *row* must not exceed 120.

NSW H101.12.3 Depths of seating rows

The depth of each *row* of seating (that is, the distance between the back of the *row* in front or, if there is a guardrail in front, between the back of the *row* and the guardrail) must, in respect of a *row* containing a number of seats specified in Column 1 of [Table H101.12](#) be not less than the distance specified in Column 2 of that Table in respect of that number of seats.

NSW H101.12.4 Clearance between rows

The *minimum lateral clearance* between each *row* of seating must, in respect of a *row* containing a number of seats specified in Column 1 of [Table H101.12](#) be not less than the clearance specified in Column 3 of that Table in respect of that number of seats.

NSW H101.12.5 Chairs used for seating

Chairs used for seating must comply with [NSW H101.11.2\(a\)](#) and [\(b\)](#).

NSW H101.12.6 Egress Doorways

Egress doorways through the walls of the *auditorium*—

- (a) must have an aggregate width of at least twice the sum of the clearances specified in Column 3 of [Table H101.12](#) for each *row* of the *auditorium* to be served by those doorways; and
- (b) must be provided at each end of every fifth *row*, excluding the first 2 *rows* and the last 2 *rows* in the *auditorium* if those *rows* each contain no more than 16 seats; and
- (c) must lead—
 - (i) directly to a road or *open space*; or
 - (ii) into a foyer or other area giving access to a road or *open space*; and
- (d) must be provided with *exit* signs if the egress doorways are not sufficiently conspicuous.

NSW H101.12.7 Clear Areas

A clear area—

- (a) must be provided from each end of each *row* to an egress doorway in the wall of the *auditorium*; and
- (b) must have a width of at least—
 - (i) the sum of the clearances specified in Column 3 of [Table H101.12](#) for each such *row*; or

- (ii) 500 mm, whichever is the greater; and
- (c) if it contains platforms or steps, must comply with [NSW H101.11.7\(a\)](#), [\(b\)](#), [\(c\)](#), [\(d\)](#) and [\(f\)](#).

NSW H101.12.8 Minimum clear space

At the entrance from a [row](#) to a clear area, there must be a clear level floor space having a width of at least the clearance specified for the [row](#) in Column 3 of [Table H101.12](#).

NSW H101.12.9 Doors

A door fitted to the egress doorway in the wall of an [auditorium](#) must comply with [NSW D2.15](#) and [NSW D2.19](#).

Table H101.12 Spacing of auditorium seating

Column 1	Column 2	Column 3
Number of seats in Rows	Depth of Rows (mm)	Clearance between Rows (mm)
Not exceeding 16	950	300
17 - 30	975	325
31 - 45	1000	350
46 - 60	1025	375
61 - 75	1050	400
76 - 90	1075	425
91 - 105	1100	450
106 - 120	1125	475

NSW H101.13 Provision of guardrails

NSW H101.13.1 Location

Guardrails must be provided—

- (a) along the fascia of each balcony or box;
- (b) if there is a stepped floor, along the front edge of each [cross-over](#); and
- (c) where [NSW H101.13.2](#) and [NSW H101.13.3](#) apply.

NSW H101.13.2 Fixed back seats

If seats with fixed backs are provided, guardrails that extend for the full width of the seating, must be provided at least 500 mm above the platform unless—

- (a) fixed seat backs of the next lower level project at least 500 mm above the level of the stepped platform; and
- (b) there is only one riser between the platform and the next lower [cross-over](#).

NSW H101.13.3 Steps between platforms

If—

- (a) there is more than one intervening step in an [aisle](#) between levels of platforms, a guardrail must be provided (at a vertical height of at least 660 mm measured above the nosing of each tread and of the upper platform) to the sides of the [aisle](#) adjacent to those steps; and
- (b) there is more than one intervening step in an [aisle](#) between levels of platforms, and that [aisle](#) is along a wall, a continuous guardrail must be affixed to that wall at a height of at least 865 mm above the nosing of each tread; and
- (c) the end of a platform or the back of the highest platform does not abut a wall that extends at least 660 mm above the floor level of the platform, a guard rail not less than 660 mm high must be provided—
 - (i) at the ends of the platform, extending from the front of the first riser to the back of the highest platform; and
 - (ii) at the back of the highest platform, extending the full width of the platform; and
- (d) there is an inclined floor, the raised section of which is not bounded by walls at least 660 mm high, a guard rail must

be provided that extends around the perimeter of the raised section at a height of at least 660 mm above the inclined floor level; and

- (e) seating at tables is provided on a stepped platform, a guardrail at least 500 mm high must be provided along the front edge of the platform.

NSW H101.14 Guardrails

This clause applies to seating areas.

NSW H101.14.1 Continental seating

Where a guardrail is provided in front of a *row* of chairs—

- (a) the distance between the back of each chair in that *row*, and the guardrail must be not less than the distance specified in Column 2 of [Table H101.12](#) for the number of chairs in that *row*;
- (b) the *minimum lateral clearance* between the front of each chair in that *row* and the guardrail must be not less than the clearance specified in Column 3 of [Table H101.12](#) for the number of chairs in that *row*.

NSW H101.14.2 Balconies and boxes

A guardrail provided along the fascia of a balcony or box—

- (a) if it is located at the foot of a stepped *aisle*, must have its top surface at least 900 mm above the floor of the balcony or box; and
- (b) if it is not located at the foot of a stepped *aisle*, must have its top surface at least 750 mm above the floor; and
- (c) if it has a ledge more than 70 mm wide, must have the top surface of the ledge sloping downwards towards the floor of the balcony or box at an angle of at least 30 degrees from the horizontal; and
- (d) must have an unperforated kerb or toe guard extending for at least 300 mm above the floor.

NSW H101.14.3 Cross-overs

A guardrail provided along the front edge of a cross-over on a stepped floor—

- (a) must be at least 750 mm high; and
- (b) must extend for the full distance between *aisles*, or between a wall and an *aisle*, or for such other distance as considered necessary.

NSW H101.15 Dressing rooms

A dressing room or 2 or more adjoining dressing rooms, having a total *floor area* of more than 50 m², must—

- (a) be separated from other parts of the building by construction having an FRL of not less than 60/60/60;
- (b) have at least 2 means of egress as remote from each other as possible, one of which must discharge—
 - (i) directly to a road or *open space*; or
 - (ii) through a fire-isolated *exit* to a road or *open space*.

NSW H101.16 Storerooms

A storeroom must be separated from other parts of the building by construction having an FRL of not less than 60/60/60.

NSW H101.17 Projection suites

- (a) This clause applies to *projection suites*.
- (b) A *projection suite* must be provided in an *entertainment venue* intended to be used for the showing of *films*.

NSW H101.17.1 Rooms to be provided

A *projection suite* in accordance with the staffing requirements of Schedule 3A of the Environmental Planning and Assessment Regulation 2000 must contain either—

- (a) a projection room and sanitary accommodation comprising at least 1 closet pan and 1 washbasin, where the

projection suite is continually staffed; or

- (b) a projection room fitted with the following equipment—
- (i) an *automatic* fire suppression system in accordance with SSL Appraisal Specification FAS 102 or a sprinkler system complying with AS 2118; and
 - (ii) a smoke detection system which will—
 - (A) comply with AS 1670.1; and
 - (B) be connected to a fire station or other approved monitoring service where arrangements are in place to initiate *fire brigade* response; and
 - (C) close down all shutters fitted to projection or observation ports; and
 - (D) activate sufficient general lighting to provide a minimum of 40 lux measured at floor level in any *auditorium* affected; and
 - (E) operate a public address system to automatically announce a suitable message from the management of the premises; and
 - (F) activate an audible alarm to immediately indicate to management the presence of smoke in the projection room.

NSW H101.17.2 Fire separation

A *projection suite* must be separated from all other internal parts of the building in which it is located by construction having an FRL of not less than 60/60/60.

NSW H101.17.3 Concession for protection of some openings

If a projection or observation port is not more than 0.1 m² in area—

- (a) a metal shutter not less than 1.5 mm thick may be fitted thereto instead of the protection *required* under [NSW C3.11](#); and
- (b) any metal shutter or protection system provided must be equipped with a device to permit the closing of the shutter or protection system from easily accessible operating positions adjacent to each egress doorway from the projection room.

NSW H101.18 Basement storeys

Where an *entertainment venue* includes not more than 2 basement *storeys*—

- (a) all *required exits* from the basement must be enclosed in *non-combustible* construction, with the exception of the main entry or *exit*; and
- (b) any *auditorium* and other public areas in the basement must be equipped with an air-handling system that complies with AS 1668.2.

NSW H101.18.1 Basement storeys — More than two

If the *entertainment venue* includes more than 2 basement *storeys*—

- (a) the construction must be of at least Type B; and
- (b) all *required exits* from the basement must be enclosed in a *fire-resisting shaft* having an FRL as *required* by the relevant Type of construction; and
- (c) the building must be equipped with a sprinkler system (other than a FPAA101D or FPAA101H system) complying with [Specification E1.5](#).

NSW H101.19 Electric mains installation

NSW H101.19.1 Main switchboard

The switchboard containing the main isolation switch must—

- (a) be located in a position that is readily accessible to authorised persons, and to the *fire brigade* in the case of an emergency; and

- (b) be enclosed by construction having an FRL not less than 60/60/60.

NSW H101.19.2 Circuit protection

Protection of a final sub-circuit originating at a switchboard or distribution board must be by means of circuit breakers.

NSW H101.19.3 Separate sub-mains

Where an *entertainment venue* has its mains supply in common with that of another building or where it is a part of a building—

- (a) the *entertainment venue* must be served by a separate and independent sub-main from the main switchboard; and
- (b) each such sub-main, the consumer's main and the supply authority's conductors within the building must be protected against fire by means of—
- (i) mineral-insulated metal-sheathed cables or other cables that provide at least 2 hours' fire protection; or
 - (ii) heavy-duty PVC conduit or metallic pipe, concrete encased in walls or slabs with a minimum of 50 mm cover; or
 - (iii) heavy-duty PVC conduit or metallic pipe, buried at least 500 mm below ground level, for underground cabling.

NSW H101.20 Lighting

NSW H101.20.1 Lighting switches

- (a) Any switch controlling the lighting system must not be accessible.
- (b) Where, during normal use, general lighting may be dimmed or switched off, an override switch to switch on all the general lighting instantaneously must be installed in the *auditorium* in a position accessible to management.

NSW H101.20.2 Lighting levels

Where the lamps utilised in the general lighting are of a type that will not relight immediately after the restoration of the primary electricity supply to those lamps—

- (a) a time delay or other suitable means must be provided to maintain the emergency lighting for a period not less than that necessary to allow the general lighting lamps to restrike; or
- (b) lamps of a type that will provide immediate lighting must be installed and—
- (i) arranged in such a manner as to ensure visual conditions not inferior to those *required* to be provided by the emergency lighting; and
 - (ii) capable of being switched in common with the general lighting and of being controlled also by the override switch *required* by NSW H101.20.1(b).

NSW H101.20.3 Provision of aisle lighting

Where general lighting is to be either dimmed or extinguished when the public is in attendance and where the floor is stepped or at an inclination greater than 1 in 12, *aisle* lights must be provided to illuminate the length of each *aisle* and the tread of each step therein.

NSW H101.20.4 Aisle lighting power supply

Where an *aisle* light is installed in a seat frame, it must be supplied at a voltage of not more than 32 volts AC or 115 volts DC.

NSW H101.20.5 Aisle lighting alternative power supply

Aisle lighting must be provided with an alternative electricity supply that—

- (a) is capable of being *automatically* energised in the event of failure of the primary lighting electricity supply; and
- (b) complies with the provisions applying to emergency lighting.

NSW H101.21 * * * * *

This clause has deliberately been left blank.

NSW H101.22 Automatic smoke-and-heat vents for stages

An automatic *smoke-and-heat vent* system *required* by NSW Table E2.2b “*Stages* and *backstage*” must—

- (a) be capable of *automatic* operation by the inclusion of a heat sensing device designed to activate the system at a temperature of not more than 71°C; and
- (b) be capable of being released manually from positions at each side of the *stage* and of being fully activated from either position; and
- (c) have a notice, prominently displayed at each position referred to in (b), clearly indicating the method of activation; and
- (d) have an openable area of not less than 1/10 of the total area of the *stage*.

NSW H101.23 Solid fuel burning stoves and open fire places.

Solid fuel burning stoves and open fire places must not be installed in premises designed for the purpose of—

- (a) exhibiting *films*; or
- (b) conducting live theatre productions.

NSW H101.24 Fuel gas cylinders**NSW H101.24.1 General**

Fuel gas cylinders must—

- (a) be housed in an enclosure that is located outside the building; and
- (b) comply with the ventilation requirements of AS/NZS 1596.

NSW H101.24.2 Fuel gas cylinder enclosures

An enclosure referred to in NSW H101.24.1—

- (a) must be located not less than 3 m from any *window*, door, vent or other opening; and
- (b) if located 3 m or more from a building must—
 - (i) have a concrete base; and
 - (ii) be constructed from heavy-gauge chain-wire mesh or other suitable material; and
 - (iii) be at least 1.8 m high; and
 - (iv) be so designed as to securely contain the fuel gas cylinders in a single line; and
 - (v) must be so designed as to allow cross ventilation; and
- (c) if located less than 3 m from a building must—
 - (i) have a concrete base; and
 - (ii) have 3 sides constructed from concrete or masonry; and
 - (iii) have a concrete roof; and
 - (iv) be so designed as to securely contain the fuel gas cylinders in a single line; and
 - (v) have a hinged, heavy-gauge chain-wire door capable of being secured against unauthorised entry; and
 - (vi) have its roof at least 600 mm above the uppermost fitting on any fuel gas cylinder housed therein.

NSW Part H102

Temporary structures

NSW H102.1 Application of Part

This Part applies to *temporary structures* used as *entertainment venues*.

NSW H102.2 Exits—Exclusions

In this clause, a reference to an entrance or *exit* does not include a reference to an entrance or *exit* provided for persons or animals performing in a *temporary structure*.

NSW H102.3 Location of exits

Exits must be so provided and arranged as to afford a ready means of egress from all parts of a *temporary structure*.

NSW H102.4 Exits to be provided

Without limiting the generality of [NSW H102.3](#)—

- the number of *exits* to be provided for a *temporary structure* designed to accommodate a number of persons specified in Column 1 of [Table H102.4](#) must be not less than the number of *exits* specified in Column 2 of that Table in respect of that number of persons; and
- the aggregate width of the *exits* to a *temporary structure* designed to accommodate a number of persons specified in Column 1 of [Table H102.4](#) must not be less than the width specified in Column 3 of that Table in respect of that number of persons.

NSW H102.5 Vertical clearances for exits

Every part of an entrance or *exit* must provide a minimum unobstructed height of 2000 mm and, where the entrance or *exit* is beneath a stepped seating platform, infilled risers or other approved overhead protection must be provided above the entrance or *exit*.

NSW H102.6 Curtains across exits

A flap or curtain used to cover an *exit* must be so designed that, when it is secured, it will not obstruct or impede egress.

NSW H102.7 Curtains and blinds

Curtains and blinds for use in a *temporary structure* must comply with [Table 4 of NSW Specification C1.10](#).

Table H102.4 Number of exits and widths

Column 1 Accommodation provided	Column 2 Number of <i>exits</i> required	Column 3 Aggregate width of <i>exits</i> (mm)
1-25 persons	*1-2	1000
26-50 persons	2	1,500
51-75 persons	2	2000
76-100 persons	2	2,500
100-200 persons	2	3,000
201-400 persons	3	4,500
401-600 persons	4	6,000
601-800 persons	5	7,500
801-1000 persons	5	9,000
over 1,000 persons	5 <i>exits</i> plus one additional <i>exit</i> for each additional 450 persons or part thereof.	9,000 mm plus 500 mm for each additional 50 persons or part thereof.

*Notes to [Table H102.4](#):

1. Where only one *exit* is provided that *exit* must be at least 1,000 mm wide.
2. Where 2 *exits* are provided each must be at least 500 mm wide.

NSW H102.8 Fabrics

Fabric that is used in the construction of a *temporary structure* must have—

- (a) a *Flammability Index* of not more than 6 where used—
 - (i) within a height of 4 m of the base of the *temporary structure*; or
 - (ii) in an air-supported *temporary structure* without other supporting framework; and
- (b) a *Flammability Index* of not more than 25 in every other case.

NSW H102.9 Guardrails

A rigid guardrail must—

- (a) be provided at each end of a stepped or inclined platform, at least 750 mm high above the floor of the platform, and must extend—
 - (i) in the case of a stepped platform, from the front of the first riser; and
 - (ii) in the case of an inclined platform, from the front of the first *row* of seating, to the back of the highest platform and along the rear of that platform for its full width; and
- (b) not obstruct any *aisle*, *cross-over* or *exit*.

NSW H102.10 Seating

Seating must be provided in accordance with [NSW H101.11.1](#), [NSW H101.11.2](#), [NSW H101.11.3\(b\)](#), [NSW H101.11.5\(a\)](#), [\(c\)](#), [NSW H101.11.6\(a\)](#) and [NSW H101.11.8\(a\)](#), [\(b\)](#), [\(c\)](#) and [\(d\)](#).

NSW H102.11 Sanitary accommodation

Suitable sanitary accommodation must be provided at a location convenient to the *temporary structure*.

NSW H102.12 Projection suites

Any *projection suite* must comply with [NSW H101.17.2](#) and [NSW H101.17.3](#).

NSW H102.13 Fireplaces and heating

No fireplace or other form of heating equipment may be installed in a *temporary structure*, without the consent of the approval authority.

NSW H102.14 Electrical services

Electrical services connected to the local supply authority's mains, to a generating plant or to a battery supply must comply with—

- (a) the requirements of the local supply authority; and
- (b) AS 3002; and
- (c) where applicable, AS/NZS 3000; and
- (d) [NSW H101.19.1\(a\)](#) and [NSW H101.19.3\(a\)](#).

NSW H102.15 Artificial lighting

Artificial lighting must be provided, and must comply with [NSW H101.20.1](#) and [NSW H101.20.2](#).

NSW H102.15.1 Emergency lighting levels

Emergency lighting must be provided to the areas provided with artificial lighting under [NSW H102.15](#) and must include a sufficient number of lamps to give a minimum illumination of 0.2 lux at floor level.

NSW H102.15.2 Emergency lighting power supply

Where emergency lighting is provided, the capacity of the battery and charging system must be sufficient to provide the illumination *required* by [NSW H102.15.1](#) for—

- (a) half an hour, in respect of a *temporary structure* designed to accommodate not more than 1,000 persons; and
- (b) 1 hour, in respect of a *temporary structure* designed to accommodate more than 1,000 persons.

NSW H102.16 Exit signs

Exit signs must be provided above all *exits* and in such other locations as may be *required* by [NSW E4.6](#) and must comply with [E4.5](#) and [E4.8](#).

NSW H102.17 Fire-fighting services

- (a) Fire-fighting services and appliances must be so provided as to afford adequate protection and must be so located as the approving authority, on the advice of the Commissioner of Fire and Rescue NSW, may require.
- (b) Where *required* by the approving authority, the fire-fighting services and appliances must comply with [Part E1](#).

NSW Part H103

Drive-in theatres

NSW H103.1 Application of Part

This Part applies to drive-in theatres.

NSW H103.2 Speaker standards

Speaker standards must—

- (a) be placed at a minimum of 5.5 m centres in a line along each parking ramp; and
- (b) be capable of being illuminated throughout any performance so as to be easily distinguishable at all times.

NSW H103.2.1 Lines of speaker standards

Lines of speaker standards along parking ramps must be placed at a distance of not less than 12.2 m apart.

NSW H103.3 Electrical services

The following electrical services must be installed underground—

- (a) the supply authority's conductors within the site and the consumer's mains, unless otherwise approved; and
- (b) electrical wiring external to any building on the site; and
- (c) all wiring to the speaker standards.

NSW H103.4 Vehicular entrances

Each public vehicular entrance to or exit from the drive-in theatre must be capable of being fully illuminated by flood lights that are so placed and so focussed as not to interfere with the vision of the driver of any motor vehicle.

NSW H103.5 Lighting

- (a) Driveways — Entrance and exit driveways, and the perimeter of the holding area, must be capable of being continuously illuminated by lamps capable of producing a minimum illumination of 0.5 lux at ground level.
- (b) Ramp areas — The whole of the ramp area of a drive-in theatre must be capable of being floodlit by means of area flood lights to an illumination of at least 10 lux.

NSW Section J Energy efficiency

Replace Section J with NSW Section J as follows:

Note 1:

From 1 May 2019 to 30 April 2020 Section J of NCC 2016 Volume One Amendment 1 may apply instead of [Section J](#) of NCC 2019. From 1 May 2020 [Section J](#) of NCC 2019 applies.

Note 2:

NSW Section J consists of two Subsections J(A) and J(B).

NSW Subsection J(A) Energy Efficiency - Class 2 buildings and Class 4 parts

This Subsection contains energy efficiency requirements for Class 2 buildings and Class 4 parts of buildings.

The need for separating these requirements from the requirements for Class 3 buildings arises because, in NSW, Class 2 buildings and Class 4 parts of buildings are subject to BASIX (the Building Sustainability Index), however Class 3 buildings are not.

BASIX is the web-based planning tool designed to assess the potential performance of certain residential buildings against a range of sustainability indices including thermal comfort and energy. Commitments made under BASIX become a condition of the relevant development consent or complying development certificate.

BASIX applies in NSW to all new Class 1 and 2 buildings, and Class 4 parts of buildings; and to alterations and additions to buildings of those classes where the work is subject to BASIX and also where an applicant elects to comply with BASIX.

The provisions of NSW Subsection J(A) are therefore designed to complement requirements that arise under BASIX and which are implemented via the development consent. Where BASIX is not applied to alterations and additions to Class 1 and 2 buildings, and Class 4 parts of buildings, these provisions will also complement council development controls that require energy efficiency measures to be incorporated as part of the alterations and additions.

NSW Subsection J(B) Energy Efficiency - Class 3 and Class 5 to 9 buildings

This subsection contains energy efficiency requirements for Class 3 and Class 5 to 9 buildings.

As Class 3 and Class 5 to 9 buildings are not subject to BASIX, NSW Subsection J(B) applies the provisions of the national Section J relevant to Class 3 and Class 5 to 9 buildings, with minor variations.

Note 3.

All definitions in Schedule 3 that are applicable to the national Section J are also applicable to NSW Section J.

NSW Subsection J(A)

Energy efficiency — Class 2 building and Class 4 parts

Performance Requirements

NSW J(A)P1

- (a) Thermal insulation in a building must be installed in a manner and have characteristics, which facilitate the efficient use of energy for artificial heating and cooling.
- (b) A building must have, to the degree necessary, thermal breaks installed between the framing and external cladding, to facilitate efficient thermal performance of the building envelope.

Application:

- (a) NSW J(A)P1(a) only applies to thermal insulation in a Class 2 building or Class 4 part of a building where a development consent specifies that the insulation is to be provided as part of the development.
- (b) In (a), the term development consent has the meaning given by the Environmental Planning and Assessment Act 1979.
- (c) NSW J(A)P1(b) only applies to a metal framed roof and a metal framed wall.

NSW J(A)P2

A building must have, to the degree necessary, a level of building sealing against air leakage to facilitate the efficient use of energy for artificial heating and cooling appropriate to—

- (a) the function and use of the building; and
- (b) the internal environment; and
- (c) the geographic location of the building.

Application:

NSW J(A)P2 only applies to a Class 2 building or Class 4 part of a building, except—

- (a) a building in *climate zones* 2 and 5 where the only means of *air-conditioning* is by using an evaporative cooler; and
- (b) a permanent building opening in a space where a gas appliance is located, that is necessary for the safe operation of a gas appliance; and
- (c) parts that cannot be fully enclosed

NSW J(A)P3

A building's *services* must have features that, to the degree necessary, facilitate the efficient use of energy appropriate to—

- (a) the function and use of the *service*; and
- (b) the internal environment; and
- (c) the geographic location of the building; and
- (d) the energy source of the *service*.

Application:

NSW J(A)P3 only applies to a Class 2 building or Class 4 part of a building.

NSW J(A)V1 Building sealing

Compliance with NSW J(A)P2 is verified when a building *envelope* is sealed in accordance with JV4 of the national provisions.

NSW Part J(A)1

Building fabric

NSW J(A)1.0 Deemed-to-Satisfy Provisions

- (a) Where a *Deemed-to-Satisfy Solution* is proposed, *Performance Requirement NSW J(A)P1* is satisfied by complying with *NSW J(A)1.1* and *NSW J(A)1.2*.
- (b) Where a *Performance Solution* is proposed, the relevant *Performance Requirements* must be determined in accordance with *A2.2(3)* and *A2.4(3)* as applicable.

NSW J(A)1.1 Application of Part

- (a) The *Deemed-to-Satisfy Provisions* only apply to thermal insulation in a Class 2 building or Class 4 part of a building where a development consent or complying development certificate specifies that the insulation is to be provided as part of the development.
- (b) In (a), development consent and complying development certificate, have the meaning given to these terms by the Environmental Planning and Assessment Act 1979.
- (c) The *Deemed-to-Satisfy Provisions* of this Part for thermal breaks apply to all Class 2 buildings and Class 4 parts.

NSW J(A)1.2 Compliance with BCA provisions

The *sole-occupancy units* of a Class 2 building and a Class 4 part of a building must comply with the national BCA provisions of *J0.2(b)* to *(d)* - except that the reference to "Where *required*" in *J1.2* is deemed to refer to "Where a development consent or a complying development certificate specifies that insulation is to be provided as part of the development."

Note: Compliance is not *required* with the national BCA provisions of *J0.2(a)* as those matters are regulated under BASIX and the national BCA provisions of *J0.2(e)* are covered by *NSW J(A)2.2*.

NSW Part J(A)2

Building sealing

NSW J(A)2.0 Deemed-to-Satisfy Provisions

- (a) Where a *Deemed-to-Satisfy Solution* is proposed, *Performance Requirement NSW J(A)P2* is satisfied by complying with *NSW J(A)2.1* and *NSW J(A)2.2*.
- (b) Where a *Performance Solution* is proposed, the relevant *Performance Requirements* must be determined in accordance with *A2.2(3)* and *A2.4(3)* as applicable.

NSW J(A)2.1 Application of Part

The *Deemed-to-Satisfy Provisions* of this Part apply to elements forming the *envelope* of a Class 2 building and a Class 4 part of a building, other than—

- (a) a building in *climate zones* 2 and 5 where the only means of *air-conditioning* is by using an evaporative cooler; or
- (b) a permanent building opening, in a space where a gas appliance is located, that is necessary for the safe operation of a gas appliance; or
- (c) parts of buildings that cannot be fully enclosed.

NSW J(A)2.2 Compliance with BCA provisions

Class 2 buildings and Class 4 parts of buildings must comply with the following national BCA provisions, as applicable—

- (a) *J3.2* Chimneys and flues; and
- (b) *J3.3* Roof lights; and
- (c) *J3.4(a)* to *(d)* Windows and doors; and
- (d) *J3.5* Exhaust fans; and
- (e) *J3.6* Construction of ceilings, walls and floors; and
- (f) *J3.7* Evaporative coolers.

NSW Part J(A)3

Air-conditioning and ventilation systems

NSW J(A)3.0 Deemed-to-Satisfy Provisions

- (a) Where a *Deemed-to-Satisfy Solution* is proposed, *Performance Requirement NSW J(A)P3* is satisfied by complying with [NSW J\(A\)3.1](#) and [NSW J\(A\)3.2](#).
- (b) Where a *Performance Solution* is proposed, the relevant *Performance Requirements* must be determined in accordance with [A2.2\(3\)](#) and [A2.4\(3\)](#) as applicable.

NSW J(A)3.1 Application of Part

The *Deemed-to-Satisfy Provisions* of this Part apply to a Class 2 building and a Class 4 part of a building.

NSW J(A)3.2 Compliance with BCA provisions

Class 2 buildings and Class 4 parts of buildings must comply with the following national BCA provisions, as applicable—

- (a) for air-conditioning system control: [J5.2](#); and
- (b) for mechanical ventilation system control: [J5.3](#); and
- (c) for fan systems: [J5.4](#); and
- (d) for ductwork insulation: [J5.5](#); and
- (e) for ductwork sealing: [J5.6](#); and
- (f) for pump systems: [J5.7](#); and
- (g) for pipework insulation: [J5.8](#); and
- (h) for refrigerant chillers: [J5.10](#); and
- (i) for unitary air-conditioning equipment: [J5.11](#); and
- (j) for heat rejection equipment: [J5.12](#).

Note: Compliance is not *required* with the national BCA provisions of [J5.9](#) as those matters are regulated under BASIX.

NSW Part J(A)4

Heated water supply

NSW J(A)4.0 Deemed-to-Satisfy Provisions

- (a) Where a *Deemed-to-Satisfy Solution* is proposed, *Performance Requirement NSW J(A)P3* is satisfied by complying with [NSW J\(A\)4.1](#) and [NSW J\(A\)4.2](#).
- (b) Where a *Performance Solution* is proposed, the relevant *Performance Requirements* must be determined in accordance with [A2.2\(3\)](#) and [A2.4\(3\)](#) as applicable.

NSW J(A)4.1 Application of Part

The *Deemed-to-Satisfy Provisions* of this Part apply to a Class 2 building and a Class 4 part of a building.

NSW J(A)4.2 Compliance with BCA provisions

Class 2 buildings and Class 4 parts of buildings must comply with the national BCA provisions of [J7.2](#) Heated water supply.

Note: Compliance is not *required* with the national BCA provisions of [J7.3](#) and [J7.4](#) as those matters are regulated under BASIX.

NSW Part J(A)5

Facilities for energy monitoring

NSW J(A)5.0 Deemed-to-Satisfy Provisions

- (a) Where a *Deemed-to-Satisfy Solution* is proposed, *Performance Requirement NSW J(A)P3* is satisfied by complying with [NSW J\(A\)5.1](#) and [NSW J\(A\)5.3](#).
- (b) Where a *Performance Solution* is proposed, the relevant *Performance Requirements* must be determined in accordance with [A2.2\(3\)](#) and [A2.4\(3\)](#) as applicable.

NSW J(A)5.1 Application of Part

The *Deemed-to-Satisfy Provisions* of this Part apply to a Class 2 building except within a *sole-occupancy unit*.

NSW J(A)5.2 * * * * *

NSW J(A)5.3 Compliance with BCA provisions

Class 2 buildings must comply with the national BCA provisions of [J8.3](#).

NSW Subsection J(B)

Energy efficiency — Class 3 and Class 5 to 9 buildings

For buildings of Class 3 and Class 5 to 9, the energy efficiency provisions of the national BCA as varied by the NSW Appendix, are applicable, as follows—

NSW J(B)1 Compliance with BCA provisions

Class 3 and Class 5 to 9 buildings must comply with all of the provisions of the national [Section J](#) that are applicable to the relevant classifications, except as varied by [NSW J3.1](#) Application of Part.

Add NSW J3.1(d) as follows:

NSW J3.1 Application of Part

(d) parts of buildings that cannot be fully enclosed.

Schedule 3 Definitions

NSW Schedule 3 Definitions

Insert definition for *aisle* as follows:

Aisle means a walkway at the end of *rows* of seating, not being *continental seating*, leading to a cross-over or to an egress doorway.

Vary definition of *appropriate authority* as follows:

Appropriate authority means the relevant authority with the responsibility to determine the particular matter.

Insert definition of *assembly building* as follows:

Assembly building means a building where people may assemble for—

- (a) civic, theatrical, social, political or religious purposes including a library, theatre, public hall or place of worship; or
- (b) educational purposes in a *school*, *early childhood centre*, preschool, or the like; or
- (c) entertainment, recreational or sporting purposes including—
 - (i) a cinema; or
 - (ii) a sports stadium, sporting or other club; or
- (d) transit purposes including a bus station, railway station, airport or ferry terminal.

Insert definition for *auditorium* as follows:

Auditorium means a part of an *entertainment venue* used or intended to be used for the purposes of accommodating an audience to an entertainment.

Insert definition of *continental seating* as follows:

Continental seating means *rows* of seating in which the *rows* extend the full width of an *auditorium* without intervening *aisles*.

Insert definition of *cross-over* as follows:

Cross-over in relation to an *entertainment venue* or *temporary structure*, means a walkway between *aisles* or between an *aisle* and an egress doorway.

Vary definition for *designated bushfire prone area* as follows:

Designated bushfire prone area means land that:

- (a) has been designated under legislation; or
 - (b) has been identified under an environmental planning instrument, development control plan or in the course of processing and determining a development application,
- as land that can support a bushfire or is likely to be subject to bushfire attack.

Insert definition for *entertainment venue* as follows:

Entertainment venue is as defined in the Environmental Planning and Assessment Regulation 2000.

Insert definition of *film* as follows:

Film means a cinematograph *film* of a size of 35 mm or greater.

Insert definition of *flying scenery* as follows:

Flying scenery means scenery of a kind that is lifted above the *stage* floor by means of lines run from a *grid*.

Insert definition of *grid* as follows:

Grid means a framework from which lines are run for the purpose of lifting *flying scenery* above the *stage* floor.

Insert definition of *minimum lateral clearance* as follows:

Minimum lateral clearance means a permanently unobstructed space having a height above floor level of not less than 2000 mm and a width of not less than the specified measurement.

Insert definition of *Planning for Bush Fire Protection* as follows:

Planning for Bush Fire Protection is as prescribed by the Environmental Planning and Assessment Regulation 2000.

Insert definition of *projection suite* as follows:

Projection suite means such part of an *entertainment venue* as is designed to accommodate apparatus used for projecting

films.

Insert definition of *row* as follows:

Row means a *row* of seating—

- (a) between a wall or other barrier and an *aisle*; or
- (b) between 2 *aisles*.

Insert definition for *spa pool* as follows:

Spa pool is as defined in the Swimming Pools Act 1992

Insert definition of *special fire protection purpose* as follows:

Special fire protection purpose (as per Section 100B(6) of the Rural Fires Act 1997) means any of the following purposes:

- (a) a school,
- (b) a child care centre,
- (c) a hospital (including a hospital for the mentally ill or mentally disordered),
- (d) a hotel, motel or other tourist accommodation,
- (e) a building wholly or principally used as a home or other establishment for mentally incapacitated persons,
- (f) seniors housing within the meaning of State Environmental Planning Policy (Housing for Seniors or People with a Disability) 2004,
- (g) a group home within the meaning of State Environmental Planning Policy No 9 - Group Homes (now SEPP (Affordable Rental Housing) 2009),
- (h) a retirement village,
- (i) any other purpose prescribed by the regulations (Rural Fires Regulation 2013).

Note: For application of this definition in the BCA, the term “school” does not include a college, university or similar tertiary educational establishment.

Insert definition of *temporary structure* as follows:

Temporary structure means—

- (a) a booth, tent or other temporary enclosure, whether or not part of the booth, tent or enclosure is permanent; or
- (b) a mobile structure

Schedule 4 Referenced documents

NSW Schedule 4 Referenced documents

Insert in Table 1 of [Schedule 4](#) additional references as follows:

NSW Table 1 Schedule of referenced documents

No.	Date	Title	Volume One
AS/NZS 1596	2014	The Storage and Handling of LP Gas	NSW H101.24.1
AS 2001 Part 5.4	2005	Methods of test for textiles: Dimensional washing and drying procedures for textile testing See Note 1	NSW Specification C1.10
AS/NZS 3000	2018	Electrical installations (known as the Australian/New Zealand Wiring Rules)	NSW H102.14
AS/NZS 3002	2008	Electrical installations — Shows and carnivals	NSW H102.14
SSL	N/A	Appraisal Specification FAS102	NSW H101.17.1
NSW Legislation	1979	Environmental Planning and Assessment Act	NSW G5.2 , NSW J(A)P1 , NSW J(A)1.1
NSW Legislation	2000	Environmental Planning and Assessment Regulation	NSW Schedule 3 , NSW H101.1 , NSW H101.17.1
NSW Legislation	1997	Rural Fires Act	NSW Schedule 3 , NSW G5.2
NSW Legislation	1992	Swimming Pools Act	NSW GP1.2 , NSW G1.1 , NSW Schedule 3
NSW Legislation	2018	Swimming Pools Regulation	NSW GP1.2 , NSW G1.1
NSW Legislation	2011	Work Health and Safety Act	NSW G1.101

Notes associated with [NSW Table 1](#):

- (1) For AS 2001 Part 5.4, test reports based on AS2001.5.4-1987 remain valid until 30 April 2022, subject to Procedure 7A and ECE reference detergent as specified in AS2001.5.4-1987 being used.

Footnote: Other legislation affecting buildings

In addition to any applicable provisions of the Environmental Planning and Assessment Act 1979, the Environmental Planning and Assessment Regulation 2000 and this Code, there is a variety of other regulatory provisions, including legislation, regulation and departmental policies that impose requirements affecting the design, construction and/or performance of buildings in NSW.

The following is a non-definitive list of such provisions. It does not include Commonwealth provisions that may apply in NSW, nor planning and environmental standards that may impose building requirements in individual circumstances. It is meant as an indicative guide only and is not to be relied upon in any way as a substitute for further research, investigation and legal advice needed to determine building standards in individual circumstances.

1. Abattoirs, Knackeries and Meat Premises**Administering Agency**

NSW Food Authority

Relevant Legislation

Food Regulation 2015

2. Boarding Houses**Administering Agency**

Department of Family and Community Services – Ageing, Disability and Home Care

Relevant Legislation

Boarding Houses Regulation 2013

3. Children's Services**Administering Agency**

NSW Department of Education

Relevant Legislation

Children (Education and Care Services National Law Application) Act 2010

Children (Education and Care Services) Supplementary Provisions Regulation 2012

4. Crematoria, Vaults, Mortuary Churches etc.**Administering Agency**

NSW Ministry of Health

Relevant Legislation

Public Health Regulation 2012

5. Crown Land — Construction Approval**Administering Agency**

Department of Industry

Relevant Legislation

Crown Land Management Act 2016

Crown Land Management Regulation 2018

Administering Agency

NSW Rural Fire Service

Relevant Legislation

Rural Fires Act 1997

6. Dairies

Administering Agency

NSW Food Authority

Relevant Legislation

Food Regulation 2015

7. Dangerous Goods (including Gas Installations)

Administering Agency

Department of Planning and Environment, Energy, Water and Portfolio Strategy

Relevant Legislation

Explosives Regulation 2013

Gas Supply Act 1996

Gas Supply (Safety and Network Management) Regulation 2013

Administering Agency

SafeWork NSW

Relevant Legislation

Explosives Regulation 2013

Work Health and Safety Regulation 2017

Administering Agency

NSW Fair Trading

Relevant Legislation

Gas and Electricity (Consumer Safety) Act 2017

Gas and Electricity (Consumer Safety) Regulation 2018

8. Dining Rooms and Bars

Administering Agency

NSW Food Authority

Relevant Legislation

Food Regulation 2015

9. Electrical Installations

Administering Agency

NSW Fair Trading

Relevant Legislation

Gas and Electricity (Consumer Safety) Regulation 2018

Gas and Electricity (Consumer Safety) Act 2017

Administering Agency

SafeWork NSW

Relevant Legislation

Work Health and Safety Regulation 2017

10. Fire Prevention in Existing Buildings

Administering Agency

Department of Planning and Environment

Relevant Legislation

Environmental Planning and Assessment Act 1979

Environmental Planning and Assessment Regulation 2000

11. Food Premises

Administering Agency

NSW Food Authority

Relevant Legislation

Food Regulation 2015

12. Foundries

Administering Agency

Department of Planning and Environment, Energy, Water and Portfolio Strategy

Relevant Legislation

Gas Supply Act 1996

Administering Agency

SafeWork NSW

Relevant Legislation

Work Health and Safety Regulation 2017

13. Historic Buildings

Administering Agency

Office of Environment and Heritage

Relevant Legislation

Heritage Regulation 2012

14. Hospitals, Nursing Homes and Health Care Buildings

Administering Agency

NSW Ministry of Health

Relevant Legislation

Private Health Facilities Regulation 2017

Poisons and Therapeutic Goods Regulation 2008

15. Hot or Warm Water Systems and Air Handling Systems

Administering Agency

NSW Ministry of Health

Relevant Legislation

Public Health Regulation 2012

16. Lift Installations

Administering Agency

SafeWork NSW

Relevant Legislation

Work Health and Safety Regulation 2017

17. Moveable Dwellings (in Caravan Parks)

Administering Agency

Office of Local Government

Relevant Legislation

Local Government Act 1993

Administering Agency

Department of Planning and Environment

Relevant Legislation

Local Government (Manufactured Home Estates, Caravan Parks, Camping Grounds and Moveable Dwellings) Regulation 2005

18. Work Health and Safety

Administering Agency

SafeWork NSW

Relevant Legislation

Work Health and Safety Regulation 2017

19. Pharmacies

Administering Agency

Pharmacy Council of New South Wales

Relevant Legislation

Health Practitioner Regulation National Law (NSW)

Health Practitioner Regulation (New South Wales) Regulation 2016

20. Planning Controls

Administering Agency

Department of Planning and Environment

Relevant Legislation

Environmental Planning and Assessment Act 1979

Environmental Planning and Assessment Regulation 2000

21. Premises for Activities Involving Skin Penetration

Administering Agency

NSW Ministry of Health

Relevant Legislation

Public Health Regulation 2012

22. Sanitary Plumbing, Water Supply and Sewerage

Administering Agency

Office of Local Government

Relevant Legislation

Local Government Act 1993

Local Government (General) Regulation 2005

Administering Agency

NSW Fair Trading

Relevant Legislation

Plumbing and Drainage Act 2011

Plumbing and Drainage Regulation 2017

Approval to Connect to Network Utility Operator's System

Refer to the Network Utility Operator for the current Act & Regulation

Hunter Water Act 1991

Sydney Water Act 1994

Water Industry Competition Act (WICA) 2006

23. Septic Tank Installations

Administering Agency

Office of Local Government

Relevant Legislation

Local Government Act 1993

Local Government (General) Regulation 2005

24. Sleeping Accommodation

Administering Agency

NSW Ministry of Health

Relevant Legislation

Public Health Regulation 2012

25. Smoking Restrictions

Administering Agency

NSW Ministry of Health

Relevant Legislation

Smoke-free Environment Regulation 2016

Smoke-free Environment Act 2000

Public Health (Tobacco) Act 2008

26. Subdivision of Buildings

Administering Agency

Department of Finance, Services and Innovation

Relevant Legislation

Conveyancing Act 1919

Conveyancing (General) Regulation 2013

Strata Scheme Development Act 2015

Strata Scheme Development Regulation 2016

Community Land Development Act 1989

Community Land Development Regulation 2007

27. Swimming Pool Fences

Administering Agency

NSW Fair Trading

Relevant Legislation

Swimming Pools Act 1992

Swimming Pools Regulation 2018

28. Temporary Structures

Administering Agency

Department of Planning and Environment

Relevant Legislation

Environmental Planning and Assessment Act 1979

Environmental Planning and Assessment Regulation 2000

Northern Territory

Introduction

Section E **Services and equipment**

Section G **Ancillary provisions**

Section H **Special use buildings**

NT Part H101 * * * * *

NT Part H102 **Premises to be used for activities involving skin penetration**

NT Part H103 **Mortuaries**

Section J **Energy efficiency**

Schedule 4 **Referenced documents**

Footnote: **Other legislation affecting buildings**

Northern Territory

Introduction

Section B Structure

- NT B1.4 Determination of structural resistance of materials and forms of construction
- NT3 Strengthened area
- NT4 Masonry veneer construction

NT Addition to Specification B1.2

- NT3 Strengthened area
- NT4 Masonry veneer construction

Section E Services and equipment

- NT E1.5 Sprinklers

Section F Health and amenity

Performance Requirements

- NT FP5.1 Sound transmission through floors
- NT FP5.2 Sound transmission through walls
- NT FP5.3 Sound transmission through floor and wall penetrations
- NT FP5.4 Sound transmission through walls in residential care buildings

Deemed-to-Satisfy Provisions

- NT F5.0 Deemed-to-Satisfy Provisions
- NT F5.1 Application of Part
- NT F5.2 Weighted sound reduction index: Interpretation
- NT F5.3 Sound insulation of floors between units
- NT F5.4 Sound insulation of walls between units
- NT F5.5 Walls between a bathroom, sanitary compartment, laundry or kitchen and a habitable room in adjoining unit
- NT F5.6 Soil and waste pipes to be separated
- NT F5.7 Isolation of pumps
- NT F5.8 Walls between a bedroom and kitchen or laundry in a Class 9c building
 1. Scope
 2. Construction deemed-to-satisfy
 1. Scope
 2. Construction to be tested
 3. Method

NT Specification F5.2 Sound insulation for building elements

1. Scope
2. Construction deemed-to-satisfy

NT Specification F5.5 Impact sound — Test of equivalence

1. Scope
2. Construction to be tested
3. Method

Section G Ancillary provisions

Performance Requirements

NT GP1.1 * * * * *

NT GP1.2 Swimming pool access and water recirculation systems

Deemed-to-Satisfy Provisions

NT G1.1 Swimming pools

Section H Special use buildings

NT Part H101 * * * * *

NT Part H102 Premises to be used for activities involving skin penetration

NT H102.1 Application of Part

NT H102.2 * * * * *

NT H102.3 Washbasins

NT Part H103 Mortuaries

NT H103.1 Application of Part

NT H103.2 Layout of mortuary

NT H103.3 Construction of body preparation room

NT H103.4 Water supply and sewerage

Section J Energy efficiency

NT Section J Energy Efficiency

Schedule 4 Referenced documents

NT Schedule 4 Referenced documents

Footnote: Other legislation affecting buildings

1. Accommodation/Food Premises/Skin Penetration Activities/Mortuaries
2. Child Care
3. Crown Land
4. Dangerous Goods and Gas Installations
5. Electrical Installations
6. Fences — dividing
7. Fire Prevention
8. Historic Buildings
9. Liquor — licensing
10. Occupational Health and Safety
11. Planning Controls
12. Plumbing Installations
13. Stormwater Drainage (Municipal Roads)
14. Stormwater Drainage (Territory Roads)
15. Swimming Pools
16. Water Supply and Sewage Services

Introduction

This Appendix contains variations and additions to the Building Code of Australia (BCA) provisions which are considered necessary for the effective application of the Code in the Northern Territory.

Section B Structure**Part B1 Structural provisions**

Delete B1.4(i) and insert NT B1.4(i) as follows:

NT B1.4 Determination of structural resistance of materials and forms of construction

- (i) Termite Risk Management: Where a *primary building element* is subject to attack by subterranean termites—
- (i) AS 3660.1 with additional protection measures to be used in areas where *Mastotermes Darwiniensis* are prevalent; and
 - (ii) for the purpose of this provision, a *primary building element* consisting entirely of, or a combination of, any of the following materials is considered not to be subject to termite attack:
 - (A) Steel, aluminium or other metals.
 - (B) Concrete.
 - (C) Masonry.
 - (D) Fibre-reinforced cement.
 - (E) Timber in areas where *Mastotermes Darwiniensis* are not prevalent—naturally termite resistant in accordance with Appendix C of AS 3660.1.
 - (F) Timber — preservative treated in accordance with Appendix D of AS 3660.1; and
 - (iii) where a termite risk management system in accordance with AS 3660.1 is used, a durable notice must be permanently fixed to the building in a prominent location, such as a meter box or the like, indicating—
 - (A) the method of termite risk management; and
 - (B) the date of installation of the system; and
 - (C) where a chemical barrier is used, its life expectancy as listed on the *appropriate authority's* pesticide register label; and
 - (D) the installer's or manufacturer's recommendations for the scope and frequency of future inspections for termite activity.

NT Addition to Specification B1.2

Add clause NT3 and clause NT4 as follows–

NT3 Strengthened area

Where a residential building of Class 2, 3, 9a or 9c, in Region C as defined by AS/NZS 1170.2, is designed to be used by the Aged or Infirm it shall incorporate a “strengthened area” for use as shelter during cyclonic conditions and must comply with the following criteria:

(“strengthened area” is defined as the strengthening of an area to increase its potential to facilitate debris protection)

- (a) The *floor area* of the “strengthened area” is to be calculated at the rate of 1.2 m² per person normally accommodated within the building.
- (b) The design wind pressure for the overall “strengthened area” is for an Importance Level 3 building.
- (c) The minimum standard of debris protection to walls, floors and ceilings (or roof) bounding the “strengthened area” shall be that which resists (without complete penetration) the impact loading specified in AS/NZS 1170.2, using a regional wind speed associated with an Importance Level 3 building.
- (d) All doors, windows, vents and the like in walls bounding the “strengthened area” are to be protected against windborne debris with permanently installed screens in accordance with (c).
- (e) Consideration must be given to the selection of materials and fittings to ensure doors, windows and vents can withstand the required design wind pressures.
- (f) All doors serving as required entries/exits to a “strengthened area” are to be inward opening with locking devices suitably noted for use in a cyclone emergency.

NT4 Masonry veneer construction

Masonry veneer construction must be designed so that the structural framing, to which the masonry veneer is tied, will ensure the stability of the masonry veneer.

Section E Services and equipment**Part E1 Fire-fighting equipment****NT E1.5 Sprinklers**

In addition to Table E1.5 insert NT Table E1.5 for Class 9a buildings as follows:

NT Table E1.5 Requirements for sprinklers

Occupancy	When sprinklers are required
Class 9a	if more than one <i>storey</i>

Section F Health and amenity

Part F5 Sound transmission and insulation

Performance Requirements

NT FP5.1 Sound transmission through floors

Floors separating *sole-occupancy units* must provide insulation against the transmission of airborne and impact generated sound sufficient to prevent illness or loss of amenity to the occupants.

Application:

NT FP5.1 only applies to a Class 2 or 3 building or a Class 9c building.

NT FP5.2 Sound transmission through walls

Walls separating—

- (a) *sole-occupancy units*; or
 - (b) a *sole-occupancy unit* from a plant room, lift *shaft*, stairway, *public corridor*, public lobby or the like,
- must provide insulation against the transmission of airborne and impact generated sound sufficient to prevent illness or loss of amenity to the occupants.

Application:

NT FP5.2 only applies to a Class 2 or 3 building.

NT FP5.3 Sound transmission through floor and wall penetrations

The *required* sound insulation of floors or walls must not be compromised by the incorporation or penetration of a pipe or other service element.

Application:

NT FP5.3 only applies to a Class 2 or 3 building or a Class 9c building.

NT FP5.4 Sound transmission through walls in residential care buildings

Walls separating—

- (a) *sole-occupancy units*; or
 - (b) a *sole-occupancy unit* from a kitchen, bathroom, *sanitary compartment* (not being an associated ensuite), laundry, plant room or utilities room,
- must provide insulation against the transmission of airborne sound sufficient to prevent illness or loss of amenity to the occupants; and
- (c) a *sole-occupancy unit* from a kitchen or laundry,
- must provide insulation against the transmission of impact generated sound sufficient to prevent illness or loss of amenity to the occupants.

Application:

NT FP5.4 only applies to a Class 9c building.

Deemed-to-Satisfy Provisions

NT F5.0 Deemed-to-Satisfy Provisions

- (a) Where a *Deemed-to-Satisfy Solution* is proposed, *Performance Requirements* NT FP5.1 to NT FP5.4 are satisfied by complying with NT F5.1 to NT F5.8.

Northern Territory

Deemed-to-Satisfy Provisions

- (b) Where a *Performance Solution* is proposed, the relevant *Performance Requirements* must be determined in accordance with *A2.2(3)* and *A2.4(3)* as applicable.

NT F5.1 Application of Part

The *Deemed-to-Satisfy Provision* of this Part apply to Class 2 and 3 buildings and Class 9c *aged care buildings*.

NT F5.2 Weighted sound reduction index: Interpretation

A form of construction *required* to have a certain weighted sound reduction index (R_w) must—

- (a) have the *required* value determined under AS/NZS ISO 717.1; or
 (b) comply with *NT Specification F5.2*.

NT F5.3 Sound insulation of floors between units

A floor separating *sole-occupancy units* must have an R_w not less than 45.

NT F5.4 Sound insulation of walls between units

A wall must have an R_w not less than 45 if it separates—

- (a) *sole-occupancy units*; or
 (b) a *sole-occupancy unit* not within a Class 9c building from a plant room, lift *shaft*, stairway, *public corridor*, hallway or the like.
 (c) a *sole-occupancy unit* in a Class 9c building from a kitchen, bathroom, *sanitary compartment* (not being an associated ensuite), laundry, plant room or utilities room.

NT F5.5 Walls between a bathroom, sanitary compartment, laundry or kitchen and a habitable room in adjoining unit

- (a) Except for a Class 9c building, a wall separating a bathroom, *sanitary compartment*, laundry or kitchen in one *sole-occupancy unit* from a *habitable room* (other than a kitchen) in an adjoining unit must—
- (i) have an R_w of not less than 50; and
 (ii) provide a satisfactory level of insulation against impact sound; and
 (iii) not incorporate a duct which reduces the R_w of the wall to less than 50.
- (b) A wall satisfies (a)(i) and (a)(ii) if it is—
- (i) in accordance with *NT Table F5.5*; or
 (ii) for other than masonry, in 2 or more separate leaves without rigid mechanical connection except at their periphery; or
 (iii) identical with a prototype that is no less resistant to the transmission of impact sound when tested in accordance with *NT Specification F5.5* than a wall listed in *NT Table F5.5*.

NT Table F5.5 Construction of walls to reduce impact sound

Construction of walls to reduce impact sound
Cavity brickwork— Two leaves of 90 mm brick masonry with— (i) all joints filled solid with mortar; and (ii) an air space not less than 40 mm between the leaves; and (iii) the leaves connected only by ties in accordance with AS 3700.
Single leaf brickwork— 110 mm thick brick masonry with— (i) each face rendered 13 mm thick; and

Northern Territory

Deemed-to-Satisfy Provisions

Construction of walls to reduce impact sound

- (ii) 50 mm x 12 mm thick timber battens at not more than 610 mm centres fixed to each face but not recessed into the render; and
- (iii) one layer of 12 mm thick softboard nailed to the battens; and
- (iv) 6 mm thick medium density hardboard adhesive-fixed to the softboard.

Concrete blockwork—

190 mm thick concrete block masonry with—

- (i) each face of the blocks fitted with 50 mm x 50 mm timber battens, spaced at not more than 610 mm centres, screw-fixed into resilient plugs with rubber inserts; and
- (ii) the space between the battens completely filled with mineral or glass wool blanket or batts not less than 50 mm thick; and
- (iii) the outer face of the battens finished with plasterboard not less than 10 mm thick or other material with a mass per unit area not less than 7.3 kg/m².

NT F5.6 Soil and waste pipes to be separated

If a soil or waste pipe, including a pipe that is embedded in or passes through a floor, serves or passes through more than one *sole-occupancy unit*—

- (a) the pipe must be separated from the rooms of any *sole-occupancy unit* by construction with an R_w not less than—
 - (i) 45 if the adjacent room is a *habitable room* (other than a kitchen); or
 - (ii) 30 if the adjacent room is a kitchen or any other room; and
- (b) a door or panel providing access to the pipe must not open into any *habitable room* (other than a kitchen); and
- (c) an access door or panel in any other part must be firmly fixed so as to overlap the frame or rebate of the frame by not less than 10 mm, be fitted with a sealing gasket along all edges and constructed of—
 - (i) wood, particleboard or blockboard not less than 38 mm thick; or
 - (ii) compressed fibre reinforced cement sheeting not less than 9 mm thick; or
 - (iii) other suitable material with a mass per unit area not less than 24.4 kg/m².

NT F5.7 Isolation of pumps

A flexible coupling must be used at the point of connection between the service pipes in a building and any circulating or other pump.

NT F5.8 Walls between a bedroom and kitchen or laundry in a Class 9c building

In addition to [NT F5.4](#), a wall separating a *sole-occupancy unit* in a Class 9c building from a kitchen or laundry must—

- (a) for other than masonry, be two or more separate leaves without rigid mechanical connection except at their periphery; or
- (b) be identical with a prototype that is no less resistant to the transmission of impact sound when tested in accordance with [NT Specification F5.5](#) than a wall listed in [Table 2 of NT Specification F5.2](#).

NT Specification F5.2 Sound insulation for building elements

Deemed-to-Satisfy Provisions

1. Scope

This Specification lists the weighted sound reduction index (R_w) for some common forms of construction.

2. Construction deemed-to-satisfy

The forms of construction listed in [Table 2](#) are considered to have the R_w stated in that Table if installed as follows:

- (a) **Masonry**—Units must be laid with all joints filled solid, including those between the masonry and any adjoining construction.
- (b) **Concrete slabs**—Joints between concrete slabs and any adjoining construction must be filled solid.
- (c) **Plasterboard**—
 - (i) if one layer is *required* under this Specification, it must be screw-fixed to the studs with joints staggered on opposite faces; and
 - (ii) if 2 layers are *required*, the first layer must be fixed according to (i) and the second layer must be fixed to the first layer with nails, screws or adhesive so that the joints do not coincide with those of the first layer; and
 - (iii) joints between sheets or between sheets and any adjoining construction must be taped and filled solid; and
 - (iv) fire-protective grade plasterboard must be the special grade manufactured for use in *fire-resisting construction*.
- (d) **Steel studs and perimeter members**—
 - (i) the section of steel must be not less than 0.6 mm thick; and
 - (ii) studs must be not less than 63 mm in depth unless another depth is listed in [Table 2](#); and
 - (iii) studs must be fixed to steel top and bottom plates of sufficient depth to permit secure fixing of the plasterboard; and
 - (iv) all steel members at the perimeter of the wall must be securely fixed to the adjoining structure and bedded in resilient compound or the joints must be caulked so that there are no voids between the steel members and the wall.

Table 2 R_w Applicable to construction

Construction	R_w (not less than)
WALLS	
Clay brickwork—	
(a) 230 mm thick in one or more leaves and with a mass per unit area of not less than 290 kg/m ²	45
(b) 110 mm thick rendered 13 mm thick on both sides with a mass per unit area of the unrendered wall being not less than 190 kg/m ²	45
(c) 110 mm thick, of semi-dry-pressed bricks and rendered 13 mm on one side, the mass per unit area of the unrendered wall being not less than 215 kg/m ²	45
(d) 110 mm thick, of extruded brick and rendered 13 mm on one side, the mass per unit area of the unrendered wall being not less than 180 kg/m ²	45
Concrete brickwork — 110 mm thick with a mass per unit area of not less than 195 kg/m ²	45
Concrete blockwork—	

Northern Territory

Deemed-to-Satisfy Provisions

Construction	R _w (not less than)
(a) 190 mm thick with a mass per unit area of not less than 215 kg/m ²	45
(b) (i) 140 mm thick, the wall thickness of the blocks being not less than 44 mm and with— 50 mm x 50 mm timber battens spaced at not more than 610 mm centres screw-fixed on one face of the blocks into resilient plugs with rubber inserts between battens and the wall;	
(ii) the face of the battens clad with 13 mm thick standard plasterboard; and	45
(iii) a mass per unit area of the whole system of not less than 220 kg/m ²	
Concrete—	
(a) In-situ concrete — 125 mm thick and with a density of not less than 2200 kg/m ³	45
(b) In-situ concrete — 100 mm thick and with a density of not less than 2500 kg/m ³	45
(c) Precast concrete — 100 mm thick and without joints	45
Steel stud walling—	
(a) with 2 layers of 16 mm thick fire-protective grade plasterboard fixed to each face	45
(b) with—	45
(i) 1 layer of 13 mm thick fire-protective grade plasterboard fixed to one face, and before fixing, 50 mm thick mineral or glass wool blanket or batts stapled to the back of each sheet so that the sheet is completely covered; and	45
(ii) 2 layers of 13 mm thick fire-protective grade plasterboard fixed to the other face	
(c) with—	45
(i) 1 layer of 16 mm fire-protective grade plasterboard fixed to one face; and	
(ii) 50 mm thick mineral or glass wool blanket or batts wedged firmly between the studs; and	45
(iii) 2 layers of fire-protective grade plasterboard fixed to the other face, the inner layer being 16 mm thick and the outer layer being 13 mm	
(d) with 2 layers of 13 mm plasterboard on both sides of 75 mm studs	45
FLOORS—	
Concrete—	
(a) In-situ concrete slab — 125 mm thick and with a density of not less than 2200 kg/m ³	45
(b) In-situ concrete slab — 100 mm thick and with a density of not less than 2500 kg/m ³	45
(c) Pre-cast concrete slab — 100 mm thick and without joints	45
Timber — comprising—	
(a) timber joists not less than 175 mm x 50 mm; and	45
(b) 75 mm thick mineral or glass wool blanket or batts cut to fit tightly between joists and laid on 10 mm thick plasterboard fixed to underside of joists; and	
(c) 25 mm thick mineral or glass wool blanket or batts laid over entire floor, including tops of joists before flooring is laid; and	
(d) tongued-and-grooved boards not less than 19 mm thick, secured to 75 mm x 50 mm battens; and	
(e) the assembled flooring laid over the joists, but not fixed to them, with the battens lying between the joists	
DUCTS OR OTHER CONSTRUCTION SEPARATING SOIL AND WASTE PIPES FROM UNITS	
Masonry — not less than 90 mm thick	30
Plasterboard — 2 layers of plasterboard—	
(a) each 10 mm thick, fixed to timber studs not less than 75 mm x 50 mm and spaced at not more than 400 mm centres.	30
(b) each 13 mm thick, one on each side of steel studs not less than 50 mm deep and spaced at not more than 400 mm centres	30

NT Specification F5.5**Impact sound — Test of equivalence***Deemed-to-Satisfy Provisions***1. Scope**

This Specification describes a method of test to determine the comparative resistance of walls to the transmission of impact sound.

2. Construction to be tested

- (a) The test is conducted on a specimen of prototype wall construction and on a specimen of one or other of the constructions specified in [NT Table F5.5](#).
- (b) The testing of a construction specified in [NT Table F5.5](#) need not be repeated for subsequent comparisons provided complete records of the results, the test equipment and the technique of testing are kept so that identical equipment can be employed and an identical technique can be adopted in the testing of specimens of prototype wall construction.

3. Method

- (a) The wall constructions to be compared must be tested in accordance with AS 1191.
- (b) A horizontal steel platform 510 mm x 460 mm x 10 mm thick must be placed with one long edge in continuous and direct contact with the wall to be tested on the side of the wall on which the impact sound is to be generated.
- (c) A tapping machine complying with *ISO 140/6—1998 (E)* must be mounted centrally on the steel platform.
- (d) The sound transmission through the wall must be determined in accordance with AS 1191 except that the tapping machine as mounted on the steel platform must be used as the source of sound.
- (e) The impact sound pressure levels measured in the receiving room must be converted into normalised levels using a reference equivalent absorption area of 10 m².

Section G Ancillary provisions

Part G1 Minor structures and components

Delete GP1.1 and GP1.2 insert NT GP1.1 and NT GP1.2 as follows:

Performance Requirements

NT GP1.1 * * * * *

NT GP1.2 Swimming pool access and water recirculation systems

- (a) * * * * *
- (b) A *swimming pool* water recirculation system must incorporate safety measures to avoid entrapment of, or injury to, a person.

Delete G1.1(a) and (b) and insert NT G1.1(a) and (b) as follows:

Deemed-to-Satisfy Provisions

NT G1.1 Swimming pools

- (a) * * * * *
- (b) * * * * *

Note:

Barriers and fences for *swimming pools* are regulated by the Northern Territory of Australia Swimming Pool Safety Act 2004.

Section H

Special use buildings

NT Part H101

* * * * *

This clause has deliberately been left blank.

NT Part H102

Premises to be used for activities involving skin penetration

NT H102.1 Application of Part

This part applies to premises for tattooing, ear-piercing, acupuncture and like activities.

NT H102.2 * * * * *

This clause has deliberately been left blank.

NT H102.3 Washbasins

The area in which skin penetration is done must be provided with—

- (a) one wash basin for each 10, or part of 10 employees; and
- (b) an adequate supply of hot and cold water controlled by foot-operated or elbow-operated taps.

NT Part H103**Mortuaries****NT H103.1 Application of Part**

This Part applies to any premises used for storage or preparation for burial, cremation or disposal by other means, of bodies of deceased persons.

NT H103.2 Layout of mortuary

- (a) A mortuary may be integral with the remainder of a building but must be separated physically from all public areas of that building.
- (b) Each mortuary at which bodies are prepared for burial, cremation or other disposal must be provided with a body preparation room that is capable of being isolated from the remainder of the premises.
- (c) A vehicle reception area or garage must be provided adjacent to and with direct access to the storage room or body preparation room to ensure that the transfer of uncoffined bodies is screened from public view.
- (d) Access to toilet and shower facilities from any other part of the mortuary premises must be only by way of an air lock.

NT H103.3 Construction of body preparation room

- (a) The floor must be—
 - (i) of impervious material with a smooth, unbroken surface; and
 - (ii) uniformly graded to a floor drain.
- (b) All walls and partitions must be of concrete or masonry with a smooth, unbroken finish for ease of cleaning.
- (c) All joints between the floor, walls, partitions, ceiling, ventilation grilles, fittings, pipework, [windows](#) and light fittings must be sealed with impervious material for ease of cleaning.
- (d) All joints between the floor and walls or partitions must be covered for ease of cleaning.
- (e) The body preparation room must be provided with at least one washbasin, fitted with elbow or foot-operated taps, and an adequate supply of hot and cold water.
- (f) The body preparation room must be provided with refrigerated storage facilities—
 - (i) with sufficient capacity for the storage of at least two adult bodies; and
 - (ii) capable of maintaining an internal temperature between 1°C and 5°C.

NT H103.4 Water supply and sewerage

Each mortuary with a body preparation room must be connected to—

- (a) a permanent water supply with a physical discontinuity between the water supply and all equipment, appliances, fittings and areas in the mortuary; and
- (b) a water carriage sewerage system.

Section J Energy efficiency

Section J Energy efficiency

Delete Section J and insert the following:

NT Section J Energy Efficiency

For a Class 2 building and a Class 4 part of a building, [Section J](#) is replaced with Section J of BCA 2009.

[Section J](#) does not apply to Class 3 and 5 - 9 buildings.

Schedule 4 Referenced documents**NT Schedule 4 Referenced documents**

Insert in Table 1 of [Schedule 4](#) as follows:

NT Table 1 Schedule of referenced documents

No	Date	Title	Volume One
AS/NZS 1170 Part 2	2011	Structural design actions: Wind actions Amdt 1, 2, 3, 4 and 5	NT Spec B1.2
AS 3660 Part 1	2014	Termite management: New building work	NT B1.4
BCA 2009	May 2009	Building Code of Australia	NT Section J

Footnote: Other legislation affecting buildings

In addition to any applicable provisions of the Building Act, Building Regulations and this Code, there are a number of other legislative technical requirements affecting the design, construction and/or performance of buildings that practitioners may need to be aware of, including, but not necessarily limited to, the following list. Additional legislative instruments such as regulations, codes and standards may exist under the legislation listed.

1. Accommodation/Food Premises/Skin Penetration Activities/Mortuaries**Administering Agency**

Department of Health

Relevant Legislation

Public and Environmental Health Act

Public and Environmental Health Regulations

Food Act

2. Child Care**Administering Agency**

Department of Education

Relevant Legislation

Education and Care Services National Law

Education and Care Services National Regulations

3. Crown Land**Administering Agency**

Department of Infrastructure, Planning and Logistics

Relevant Legislation

Crown Lands Act

4. Dangerous Goods and Gas Installations**Administering Agency**

Department of Attorney-General and Justice (NT Worksafe)

Relevant Legislation

Dangerous Goods Act

5. Electrical Installations**Administering Agency**

Department of Attorney-General and Justice (NT Worksafe)

Relevant Legislation

Electrical Workers and Contractors Act

Electricity Reform Act

Electricity Reform (Safety and Technical) Regulations

6. Fences — dividing**Administering Agency**

Department of Attorney-General and Justice (NT Worksafe)

Relevant Legislation

Fences Act

7. Fire Prevention

Administering Agency

Northern Territory Fire and Rescue Service

Relevant Legislation

Fire and Emergency Act

8. Historic Buildings

Administering Agency

Department of Tourism and Culture

Relevant Legislation

Heritage Act

9. Liquor — licensing

Administering Agency

Department of Attorney-General and Justice

Relevant Legislation

Liquor Act

10. Occupational Health and Safety

Administering Agency

Department of Attorney-General and Justice (NT Worksafe)

Relevant Legislation

Work Health and Safety (National Uniform Legislation) Act

11. Planning Controls

Administering Agency

Department of Infrastructure, Planning and Logistics

Relevant Legislation

Planning Act

12. Plumbing Installations

Administering Agency

Department of Infrastructure, Planning and Logistics

Department of Attorney-General and Justice

Relevant Legislation

Building Act

Building Regulations

Plumbers and Drainers Licencing Act

13. Stormwater Drainage (Municipal Roads)

Administering Agency

Council or Municipality in which building is located

Relevant Legislation

Local Government Act

14. Stormwater Drainage (Territory Roads)

Administering Agency

Department of Infrastructure, Planning and Logistics

Relevant Legislation

Control of Roads Act

15. Swimming Pools

Administering Agency

Department of Infrastructure, Planning and Logistics

Relevant Legislation

Swimming Pool Safety Act

16. Water Supply and Sewage Services

Administering Agency

Power and Water Corporation

Relevant Legislation

Water Supply and Sewerage Services Act

Water Supply and Sewerage Services Regulations

Queensland

Introduction

Section B **Structure**

Section G **Ancillary provisions**

Qld Part G5 **Construction in bushfire prone areas**

Section J **Energy efficiency**

Schedule 4 **Referenced documents**

Footnote: **Other legislation affecting buildings**

Queensland

Introduction

Section B Structure

Performance Requirements

Qld BP1.4 * * * * *

Qld B1.4 Determination of structural resistance of materials and forms of construction

Qld B1.6 Construction of buildings in flood hazard areas

Section G Ancillary provisions

Performance Requirements

Qld GP1.2 Swimming pool access and water recirculation systems

Qld G1.1 Swimming pools

Qld Part G5 Construction in bushfire prone areas

Performance Requirements

Qld GP5.1

Deemed-to-Satisfy Provisions

Qld G5.1

Section J Energy efficiency

Schedule 4 Referenced documents

Qld Schedule 4 Referenced documents

Footnote: Other legislation affecting buildings

Introduction

This Appendix contains variations and additions to the Building Code of Australia (BCA) provisions which are considered necessary for the effective application of the Code in Queensland and shall be treated as amendments to the Code.

Section B Structure

Part B1 Structural provisions

Delete BP1.4 and insert Qld BP1.4 as follows:

Performance Requirements

Qld BP1.4 * * * * *

Note:

Building work in designated flood hazard areas is regulated by the Building Act 1975 and the Queensland Development Code 3.5 - Construction of buildings in flood hazard areas.

After B1.4(f)(iv) insert Qld B1.4(f)(v) as follows:

Qld B1.4 Determination of structural resistance of materials and forms of construction

(f) Timber Construction:

- (v) Timber used for structural purposes: a species scheduled for the appropriate use in Schedules A, B or C of Book 2 of the 'Queensland Government, Department of Agriculture, Fisheries and Forestry - Construction timbers in Queensland, Book 1 and Book 2 - Properties and specifications for satisfactory performance of construction timbers in Queensland - Class 1 and 10 buildings (Houses, carports, garages, greenhouses and sheds)'.

Delete B1.6 and insert Qld B1.6 as follows:

Qld B1.6 Construction of buildings in flood hazard areas

* * * * *

Note:

Building work in designated flood hazard areas is regulated by the Building Act 1975. and the Queensland Development Code 3.5 - Construction of buildings in flood hazard areas.

Section G Ancillary provisions

Part G1 Minor structures and components

Delete GP1.2(a) and insert Qld GP1.2(a) as follows:

Performance Requirements

Qld GP1.2 Swimming pool access and water recirculation systems

(a) * * * * *

Delete G1.1(a) and (b) and insert Qld G1.1(a) and (b) as follows:

Qld G1.1 Swimming pools

(a) * * * * *

(b) * * * * *

Note:

Barriers and fences for *swimming pools* are regulated by the Building Act 1975 and the Building Regulation 2006.

Qld Part G5 Construction in bushfire prone areas

Delete GP5.1 and insert Qld GP5.1 as follows:

Performance Requirements**Qld GP5.1**

A building that is constructed in a *designated bushfire prone area* must be designed and constructed to reduce the risk of ignition from a bushfire while the fire front passes.

Application

Qld GP5.1 only applies to—

- (a) a Class 2 or 3 building; or
- (b) a Class 10a building or deck associated with a Class 2 or 3 building, located in a *designated bushfire prone area*, but does not apply when the classified vegetation is Group F rainforest (excluding wet sclerophyll forest types), mangrove communities and grasslands under 300 mm high.

Delete G5.1 and insert Qld G5.1 as follows:

Deemed-to-Satisfy Provisions**Qld G5.1**

The *Deemed-to-Satisfy Provisions* of this Part apply to—

- (a) a Class 2 or 3 building; or
- (b) a Class 10a building or deck associated with a Class 2 or 3 building, located in a *designated bushfire prone area*, but does not apply when the classified vegetation is Group F rainforest (excluding wet sclerophyll forest types), mangrove communities and grasslands under 300 mm high.

Section J **Energy efficiency**

Insert the following:

Note:

In Queensland, for a Class 2 building, [Section J](#) is replaced with Section J of BCA 2009.

For other classifications, from 1 May 2019 to 30 April 2020 Section J of NCC 2016 may apply in lieu of Section J of NCC2019. From 1 May 2020 Section J of NCC2019 applies.

Schedule 4 Referenced documents

Qld Schedule 4 Referenced documents

Insert in Table 1 of [Schedule 4](#) additional standards as follows:

Qld Table 1 Schedule of referenced documents

No.	Date	Title	Volume One
BCA 2009	May 2009	Building Code of Australia	Qld Section J
N/A	December 2017	Queensland Government, Department of Agriculture, Fisheries and Forestry- Construction timbers in Queensland: Book 1 and Book 2: Properties and specifications for satisfactory performance of construction timbers in Queensland - Class 1 and 10 buildings (Houses, carports, garages, greenhouses and sheds).	Qld B1.4
		Queensland Development Code MP 4.1- Sustainable buildings	Section J

Footnote: Other legislation affecting buildings

All legislative technical requirements affecting the design, construction and/or performance of buildings are consolidated into the Building Act 1975 and other legislative instruments under that Act, such as regulations, codes (including this Code) and standards. Building work for the energy efficiency of Class 2 buildings is also regulated by the Queensland Development Code MP 4.1-Sustainable buildings.

South Australia

Introduction

Section A	Governing Requirements
Section B	Structure
Section C	Fire resistance
Section D	Access and egress
Section E	Services and equipment
Section F	Health and amenity
Section G	Ancillary provisions
SA Part G7	Access for maintenance
SA Part G8	Miscellaneous provisions
Section H	Special use buildings
SA Part H3	Farm buildings
Section J	Energy efficiency
Schedule 3	Definitions
Schedule 4	Referenced documents
Footnote:	Other legislation affecting buildings

South Australia

Introduction

Section A Governing Requirements

SA A6.6 Classifications

Section B Structure

Performance Requirements

SA BP1.4

SA B1.6 Construction of buildings in flood hazard areas

Section C Fire resistance

SA C1.1 Type of construction required

SA C1.15 Class 7b bulk grain storage facilities

SA C2.15 Class 2 external walls exposed to brush fences

SA C2.16 Bulk grain storage facilities

SA C3.18 Protection of openings - grain storage facilities

Section D Access and egress

SA D1.2 Number of exits required

SA D1.3 When fire-isolated stairways and ramps are required

SA D1.4 Exit travel distances

SA D1.5 Distance between alternative exits

SA D1.9 Travel by non-fire-isolated stairways and ramps

SA D1.16 Plant rooms, lift machine rooms, electricity network substations and cell type silos: Concession

SA D2.15 Thresholds

SA D2.18 Fixed platforms, walkways, stairways and ladders

SA D2.20 Swinging doors

SA D3.1 General building access requirements

SA D3.4 Exemptions

Section E Services and equipment

SA E1.3 Fire hydrants

SA E1.4(a)(v) Fire hose reels

SA E1.6 Portable fire extinguishers

SA E2.4 Smoke venting in bulk grain storage facilities

SA E4.2 Emergency lighting requirements

SA E4.5 Exit signs

SA E4.8 Design and operation of exit signs

Section F Health and amenity

Performance Requirements

SA FP1.5 Rising damp

SA FP1.6 Wet area overflows

SA FP1.8 Prevention of surface water accumulation

SA F1.0 Deemed-to-Satisfy Provisions

SA F1.7 Waterproofing of wet areas in buildings

SA F1.9 Damp-proofing

SA F1.10 Damp-proofing of floors on the ground

SA F1.11 Provision of floor wastes

SA F2.4 Accessible sanitary facilities

SA F4.5 Ventilation of rooms

Section G Ancillary provisions

Performance Requirements

SA GP1.2 Swimming pool access and water recirculation systems

SA GP1.2(c)

SA G1.1 Swimming pools

SA Part G7 Access for maintenance

Objective

SA GO7

Functional Statements

SA GF7.1

SA GF7.2

Performance Requirements

SA GP7.1

SA GP7.2

SA G7.0 Deemed-to-Satisfy Provisions

SA G7.1 Application of Part

SA G7.2 Access for window cleaning

SA G7.3 Access for inspection and maintenance between buildings

SA Part G8 Miscellaneous provisions

Performance Requirements

SA GP8.1

SA G8.0 Deemed-to-Satisfy Provisions

SA G8.1 Application of Part

SA G8.2 Attachments to buildings

Section H Special use buildings

SA Part H3 Farm buildings

SA H3.1 Application of Part

SA H3.2 Concessions and additions for farm buildings

Section J Energy efficiency

SA J1.3 Roof and ceiling construction

Schedule 3 Definitions

SA Schedule 3 Definitions

Schedule 4 Referenced documents

SA Schedule 4 Referenced documents

Footnote: Other legislation affecting buildings

1. Abattoirs
2. Accommodation
3. Asbestos Removal
4. Children's Services
5. Crown Land
6. Dangerous Goods
7. Electrical Installations
8. Encroachments
9. Fences
10. Fire Prevention in Existing Buildings
11. Food Premises
12. Gas Installations
13. Historic Buildings

14. Hospitals, Nursing Homes and Health Care Buildings
15. Housing
16. Licensed Premises
17. Lift Installations
18. Occupational Health and Safety
19. Pharmacies
20. Radiation Safety
21. Sanitary Plumbing, Water Supply and Sewerage
22. School (non-government)
23. Septic Tank and Grey Water Installations
24. Smoking Restrictions
25. Subdivision of Property
26. Waste Management and Environment Protection

Introduction

This Appendix contains variations and additions to the BCA provisions which are considered necessary for the effective application of the Code in South Australia.

These variations and additions are to be treated as amendments to the BCA and apply to the construction or alteration of all buildings requiring approval under the Development Act 1993 and Regulations 2008.

Section A Governing Requirements

Part A6 Building classification

SA A6.6 Classifications

In A6.6 replace the definition of Class 6 as follows:

Class 6: a shop or other building for the sale of goods by retail or the supply of services direct to the public, including—

- (a) an eating room, café, restaurant, milk or soft-drink bar; or
- (b) a dining room, bar, shop or kiosk part of a hotel or motel; or
- (c) a hairdresser's or barber's shop, public laundry, or undertaker's establishment; or
- (d) market or sale room, showroom, or *service station*; or
- (e) a *small arts venue*.

Section B Structure

Part B1 Structural provisions

Delete BP1.4 and replace with SA BP1.4:

Performance Requirements

SA BP1.4

(deleted).

Delete B1.6 and replace with SA B1.6:

SA B1.6 Construction of buildings in flood hazard areas

(deleted).

Section C Fire resistance

Part C1 Fire resistance and stability

After C1.1(a)(iii) add SA C1.1(a)(iv) and (v) and after C1.1(b) add SA C1.1(c) and (d) as follows:

SA C1.1 Type of construction required

- (a) The minimum Type of *fire-resisting construction* of a building must be determined in accordance with [Table C1.1](#) and [Specification C1.1](#), except as allowed for—
 - (iv) Class 2 buildings located within 3 m of a *brush fence* and Class 10b *brush fences* located within 3 m of a Class 2 building in [SA 1.1\(c\)](#) and [\(d\)](#).
 - (v) a Class 7b *bulk grain storage facility* in [SA C1.15](#).
- (c) In addition to the minimum *fire-resisting construction* requirements of [Table C1.1](#) and [Specification C1.1](#) a Class 2 buildings must not be constructed within 3 m of a Class 10b *brush fence* unless any part of the building within 3 m of the *brush fence* complies with the *fire-resisting* requirements of [SA C2.15](#).
- (d) A Class 10b *brush fence* must not be constructed within 3 m of a Class 2 building unless any part of the building within 3 m of the *brush fence* complies with the *fire-resisting* requirements of [SA C2.15](#).

After C1.14 add SA C1.15 as follows:

SA C1.15 Class 7b bulk grain storage facilities

The *external walls* of a *bulk grain storage facility* need not be of *fire-resisting construction* if—

- (a) The *external walls* are 3 m or more from an allotment boundary and more than 6 m from any other building on the same allotment, other than a Class 10 building; and__
- (b) a fire separation space of not less than 2 m is provided between *cell type silos*; and
- (c) the external walls are—
 - (i) of *non-combustible* construction; or
 - (ii) of Type C construction.

Part C2 Compartmentation and separation

After C2.14 add SA C2.15 as follows:

SA C2.15 Class 2 external walls exposed to brush fences

Where the distance between the *external wall* of a Class 2 building and a *brush fence* is less than 3 m, the Class 2 building must comply with the following:

- (a) An *external wall* or part of an *external wall* exposed to the *brush fence* must be *fire-resisting* and extend to the underside of a *non-combustible* roof covering or a *non-combustible* eaves lining or to a point at which exposure to the *brush fence* no longer exists and must—
 - (i) have a FRL of at least 60/60/60 when tested from the outside; or
 - (ii) be of masonry veneer construction in which the external masonry veneer is not less than 90 mm thick; or
 - (iii) be of masonry construction not less than 90 mm thick; and
 - (iv) have any exposed openings protected in accordance with [C3.4](#).
- (b) Where an *external wall* is *required* by [\(a\)](#) to be *fire-resisting*, only that part of the wall, including openings within the specified distance, need to be constructed in that manner.
- (c) The requirements of [\(a\)](#) do not apply to subfloor vents, roof vents, weepholes, control joints, construction joints and penetrations for pipes, conduits and the like.
- (d) The following are permitted to encroach within 3 m of a *brush fence*—
 - (i) *non-combustible* fascias, gutters, downpipes; and

- (ii) eaves with *non-combustible* roof cladding and *non-combustible* lining; and
 - (iii) flues, chimneys, pipes, domestic fuel tanks, cooling or heating appliances or other services; and
 - (iv) light fittings, electricity or gas meters, aerials or antennas; and
 - (v) pergolas, sun blinds or water tanks; and
 - (vi) unroofed terraces, landings, steps and ramps, not more than 1 m in height.
- (e) The distance from any point on an *external wall* of a building to a *brush fence* is measured in any direction from the *external wall*.

After SA C2.15 insert SA C2.16 as follows:

SA C2.16 Bulk grain storage facilities

Underground passageways in *bulk grain storage facilities* must be separated from other parts of the building by smoke-proof walls and smoke-proof doors complying with *Specification C2.5*.

Part C3 Protection of openings

After C3.17 insert SA C3.18 as follows:

SA C3.18 Protection of openings - grain storage facilities

Where external stairs, ramps or ladders are used as an *exit* in a *grain storage facility*, any window or door opening within 6 m of the stairway or ladder—

- (a) must be protected in accordance with *C3.4*; or
- (b) the stairway, ramp or ladder must be enclosed for its full height above the lowest level of the window or door opening with *non-combustible* construction having an FRL of not less than 60/60/60.

Section D Access and egress

Part D1 Provision for escape

Vary D1.2(b) by adding SA D1.2(b)(iii) and (iv) as follows:

SA D1.2 Number of exits required

- (b) **Class 2 to 8 buildings** — In addition to any *horizontal exit*, not less than 2 *exits* must be provided from the following:
- (iii) a *storage shed* in a *bulk grain storage facility* if the distance of travel to an exit is more than 150 m; and
 - (iv) the gallery level of a in a *cell type silo* in a *bulk grain storage facility*.

D1.3(b) is varied by adding SA D1.3(b)(iv) as follows:

SA D1.3 When fire-isolated stairways and ramps are required

- (b) **Class 5, 6, 7 or 9 buildings** — Every stairway or ramp serving as a *required exit* must be fire-isolated unless—
- (iv) it is a *required exit* from a *bulk grain storage facility* and there are no window or door openings within 3 m of the stairway, ramp or ladder.

D1.4 is varied by adding SA D1.4(g) and (h) as follows:

SA D1.4 Exit travel distances

- (g) **Farm buildings** — Notwithstanding (c), in a *farm building*—
- (i) no point on the floor must be more than 20 m from an *exit*, or a point from which travel in different directions to 2 *exits* is available, in which case the maximum distance to one of those *exits* must not exceed 60 m; and
 - (ii) in a machinery room, plant-room or the like, the distance to a single *exit* serving a storey at the level of access to a road or open space may be increased to 30 m.
- (h) **Bulk grain storage facilities** — Notwithstanding (c), in a *bulk grain storage facility*—
- (i) where *required exits* are spaced not more than 100 m apart, the travel distance to an *exit* in a *cell type silo* or a *storage shed* is not limited.

D1.5 is varied by adding SA D1.5(e) as follows:

SA D1.5 Distance between alternative exits

- (e) Notwithstanding (c), *exits* that are *required* as alternative means of egress in a *farm building* must not be more than 80 m apart.

D1.9 is varied by adding SA D1.9(g) as follows:

SA D1.9 Travel by non-fire-isolated stairways and ramps

- (g) In a *bulk grain storage facility*, the distance from any point on the floor to a point of egress to a road or *open space* by way of a non-*fire-isolated stairway*, non-*fire-isolated ramp* or ladder is not limited.

D1.16 is varied by adding SA D1.16(c) as follows:

SA D1.16 Plant rooms, lift machine rooms, electricity network substations and cell type silos: Concession

- (c) in a *bulk grain storage facility*, a stair or ladder complying with AS 1657 may be used as an alternative means of egress from a *cell type silo*.

Part D2 Construction of exits

D2.15 is varied by adding SA D2.15(e) as follows:

SA D2.15 Thresholds

- (e) Notwithstanding the requirements of [D2.15](#), where necessary due to the operational requirements of the building, a doorway serving an area in a *farm building* may incorporate a step that is not more than 700 mm above the finished floor level.

D2.18 is varied by adding SA D2.18(c) as follows:

SA D2.18 Fixed platforms, walkways, stairways and ladders

- (c) Areas within a *farm building*.

D2.20 is varied amending (b)(ii) and adding SA D2.20(b)(iii) as follows:

SA D2.20 Swinging doors

- (b) must swing in the direction of egress unless—
- (ii) it serves a *sanitary compartment* or airlock (in which case it may swing in either direction); or
 - (iii) it serves a *farm building*; and

Part D3 Access for people with a disability

Delete D3.1 and substitute:

SA D3.1 General building access requirements

Buildings and parts of buildings must be *accessible* as *required* by [Table D3.1](#) and [SA Table D3.1a](#), unless exempt by [D3.4](#).

SA Table D3.1a Additional requirements for access for people with a disability

Class of building	Access requirements
Class 2 In developments consisting of 20 or more residential <i>sole-occupancy units</i>	To and within one residential <i>sole-occupancy unit</i> or 5% of the total number of residential <i>sole-occupancy units</i> provided, whichever is the greater

D3.4 is varied by adding SA D3.4(d) as follows:

SA D3.4 Exemptions

- (d) In a *farm building* and a *bulk grain storage facility* it is not necessary to provide access for people with disabilities to any area if access would be inappropriate because of the particular purpose for which the area is used.

Section E Services and equipment

Part E1 Fire fighting equipment

E1.3 is varied by adding SA E1.3(c), (d), (e) and (f) as follows:

SA E1.3 Fire hydrants

- (c) In a *farm building*, in lieu of providing a fire hydrant system in accordance with E1.3(b)(i), the building may be provided with—
- (i) a fire hydrant system installed in accordance with AS 2419.1 with the following variations—
 - (A) in lieu of 4 hour water supply the minimum on-site water supply quantity must be as set out in Table SA E1.3 for the particular building group; and
 - (B) for Group A and B buildings over 1000 m² in floor area each tank used must have a capacity of not less than 72,000 litres; and
 - (C) for single tank systems compliance with clause 4.3.3 is not required; and
 - (D) compliance with clause 4.3.1 of AS 2419.1 is not required; and
 - (E) for buildings incorporating non-fire-resistant polystyrene sandwich panel construction, the minimum water supply quantities in Table SA E1.3 must be increased by 50%; and
 - (F) an on-site pumpset is not required if the design performance of section 2.3 of AS 2419.1 is achieved based on use of a fire truck pump with a capacity of 1,900 litres per minute at 1,000 kPa; and
 - (G) in lieu of the coverage specified in AS 2419.1, external fire hydrants are located so that every part of the perimeter of a building is within 100 m from a hydrant outlet measured along the shortest distance of travel between or around buildings; or
 - (ii) a water supply system comprising single or multiple on-site water storage tanks with connections for use by the fire brigade and complying with the requirements of AS 2419.1 for water supplies and water storage, except that—
 - (A) in lieu of a 4 hour water supply the minimum on-site water supply quantity must be as set out in Table SA E1.3 for the particular building group; and
 - (B) for Group A and B buildings over 1000 m² in floor area the minimum tank size must be not less than 72,000 litres; and
 - (C) for single tank systems compliance with clause 4.3.3 of AS 2419.1 is not required; and
 - (D) for buildings incorporating non-fire-resistant polystyrene sandwich panel construction, the minimum water supply quantities in Table SA E1.3 must be increased by 50%; and
 - (E) an on-site pumpset need not be provided; and
 - (F) for Group A or B buildings water storage tanks must be distributed so every part of the perimeter of a building is not more than 100 m from a tank suction point, measured along the shortest distance of travel between or around buildings; and
 - (G) for Group C buildings water storage tanks must be distributed so that every part of the perimeter of a building is within a 200 m radius of a tank suction point; and
 - (H) all pipes, valves and fittings for water storage tanks and connections must comply with section 5 and sections 8.2, 8.3, 8.6 and 8.7 of AS 2419.1 as relevant; and
 - (I) a hardstand area and vehicular approach from the site entrance, suitable for use by the fire brigade, must be provided adjacent to each water storage tank.
- (d) a dam may be regarded as a water storage tank if it complies with the requirements of section 5 of AS 2419.1 and the water level is maintained above the top of the highest fire brigade suction point at all times.
- (e) The requirements of (a), (b), SA E1.3(c) and SA E1.3(d) do not apply to a *farm shed*.

South Australia

Table SA E1.3 Minimum quantities for on-site site water supplies for farm buildings

Building group	Floor area	Minimum water supply quantity
Group A	500 m ² - 1,000 m ²	36,000 litres
	1,001 m ² - 2,000 m ²	72,000 litres
	2,001 m ² - 5,000 m ²	144,000 litres
Group B	500 m ² - 1,000 m ²	72,000 litres
	1,001 m ² - 2,000 m ²	144,000 litres
Group C	5 L/m ² or 36000 litres at each location, whichever is greater	

Note:

A single water supply with the minimum quantity outlined in [Table SA E1.3](#) can serve more than one building.

- (f) in a [bulk grain storage facility](#), on-site hydrants are not [required](#) where—
- (i) street hydrants are available adjacent to the site which can supply water at not less than 5 litres per second; or
 - (ii) a water supply system comprising single or multiple on-site water storage tanks with connections for use by the [fire brigade](#) and complying with the requirements of AS 2419.1 for water supplies and water storage, except that—
 - (A) in lieu of a 4 hour water supply, an on-site water storage tank containing not less than 25,000 litres is provided within 90 m of a dry booster connection ([Figure SA E1.3](#));
 - (B) one dry riser is provided for each [cell type silo](#) in a [bulk grain storage facility](#), located in the middle of the longest side of the facility and within 4 m of a [required exit](#);
 - (C) all areas to be protected are within 60 m of a riser outlet, measured around obstacles;
 - (D) metal or high pressure plastic pipe can used for the dry riser;
 - (E) all pipes, valves and fittings for water storage tanks and connections must comply with section 5 and sections 8.2, 8.3, 8.6 and 8.7 of AS 2419.1 as relevant; and
 - (F) a hardstand area and vehicular approach from the site entrance, suitable for use by the [fire brigade](#) must be provided adjacent each water storage tank.

Figure SA E1.3 Location of hydrants, tanks, booster connections and dry risers

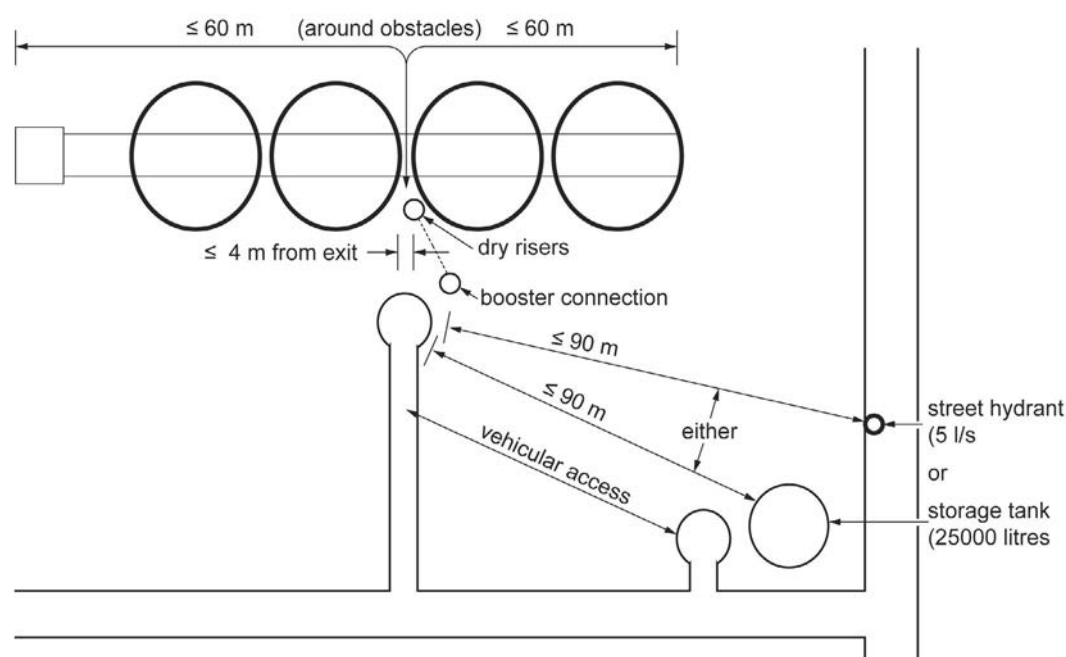

E1.4(a) is varied by adding SA E1.4(a)(v) and (vi) as follows:

SA E1.4(a)(v) Fire hose reels

(a) E1.4 does not apply to—

- (v) a *farm building* not used for hay storage exceeding 500 m² or 1,000 m³; or
- (vi) a *bulk grain storage facility*.

E1.6 is varied by adding SA E1.6(c) and (d) as follows:

SA E1.6 Portable fire extinguishers

(c) for Class A fire risks in a *farm building* the requirements of (a) need not be provided if—

- (i) portable fire extinguishers for Class A fire risks are provided in accordance with SA E1.6(d); or
- (ii) notwithstanding the exemption provided by SA E1.4(a)(v), a fire hose reel system is provided in accordance with Clause E1.4; or
- (iii) wash-down hoses or similar hoses that are—
 - (A) not more than 36 m long; and
 - (B) equipped with a spray nozzle suitable for fighting a fire at the incipient stage; and
 - (C) permanently connected to a water supply which is sufficient to supply two hoses discharging at the rate of 20 litres per minute for 60 minutes; and
 - (D) arranged to provide coverage to all points on the floor within the building.

(d) Portable fire extinguishers provided to comply with SA E1.6(c)(i) must be—

- (i) located at or adjacent to every *required exit* door; and
- (ii) in open walled *farm buildings*, one extinguisher is provided for every 500 m² of *floor area* or part thereof.

Part E2 Smoke hazard management

E2.4 is varied by adding SA E2.4 as follows:

SA E2.4 Smoke venting in bulk grain storage facilities

In a *bulk grain storage facility*—

- (a) suitable natural smoke venting by fixed vents must be provided at the top of elevator towers and overhead galleries in a *cell type silo*; and
- (b) in *storage sheds* smoke venting is not required.

Part E4 Emergency lighting, exit signs and warning systems

E4.2(b) is varied by adding SA E4.2(b)(iii)(A), (B), (C) and (D), and SA 4.2(j) is added as follows:

SA E4.2 Emergency lighting requirements

An emergency lighting system must be installed—

- (b) in every *storey* of a Class 5, 6, 7 or 8 building where the *storey* has a *floor area* more than 300 m²—
 - (iii) in any room having a *floor area* more than 300 m², except that—
 - (A) in a *farm building* any area primarily used for the storage of hay can be excluded when calculating the *floor area* of the *storey* or room of the building for the purpose of determining emergency lighting requirements; and
 - (B) emergency lighting is not *required* in a *farm building* where *automatic* back-up power is provided by a fuel-driven back-up generator or where no artificial lighting is provided in the building; and
 - (C) an emergency lighting system is not *required* in a—
 - (aa) a *farm shed*; or
 - (bb) a Group C *farm building*; or
 - (cc) at ground floor level in *cell type silos* or *storage sheds*; and
 - (D) in a *bulk grain storage facility* the spacing of emergency lights can be increased to twice the distance required for Class 7 Buildings; and
- (j) in an underground passage in a *bulk grain storage facility*;

E4.5 is varied by adding SA E4.5(e) as follows:

SA E4.5 Exit signs

An exit sign must be clearly visible to persons approaching the exit, and must be installed on, above or adjacent to each—

- (e) *required exit* in a *farm building*.

E4.8 is varied by adding SA E4.8(c) at the end of the clause as follows—

SA E4.8 Design and operation of exit signs

Every required exit sign must comply with—

- (c) except that the requirements of (a) and (b) do not apply to—
 - (i) a *farm building* where—
 - (A) the use of illuminated *exit* signs could adversely affect the behavior or welfare of animals being kept in the building; and
 - (B) non-illuminated *exit* signs are provided that comply with clauses 5.5, 5.6 and 5.8 of AS/NZS 2293.1; or
 - (ii) a *farm shed*.

Section F Health and amenity

Part F1 Damp and weatherproofing

Delete FP1.5 and add SA FP1.5 as follows:

Performance Requirements

SA FP1.5 Rising damp

- (a) Moisture from the ground must be prevented from causing—
 - (i) undue dampness or deterioration of building elements; and
 - (ii) unhealthy or dangerous conditions, or loss of amenity for occupants.
- (b) Barriers installed to prevent transfer of moisture from the ground must have—
 - (i) high resistance to moisture penetration; and
 - (ii) high resistance to damage during construction; and
 - (iii) high resistance to degradation by dissolved salts.

Delete FP1.6 add SA FP1.6 as follows:

SA FP1.6 Wet area overflows

Accidental water overflow from a bathroom, laundry facility or the like must be prevented from penetrating to adjoining rooms or spaces.

After FP1.7 add SA FP1.8 as follows:

SA FP1.8 Prevention of surface water accumulation

In laundries, bathrooms or rooms containing shower facilities the floors must be installed in a manner that will prevent accumulation of surface water which could create unhealthy or hazardous conditions.

Delete F1.0(b) and add SA F1.0(b) as follows:

SA F1.0 Deemed-to-Satisfy Provisions

- (b) Where a *Deemed-to-Satisfy Solution* is proposed, *Performance Requirements* FP1.1 to FP1.3, SA FP1.5, SA FP1.6, FP1.7 and SA FP1.8 are satisfied by complying with F1.1 to F1.6, SA F1.7, SA F1.9 to SA F1.11, F1.12 and F1.13.

Delete F1.7(a) and insert SA F1.7(a) as follows:

SA F1.7 Waterproofing of wet areas in buildings

- (a) In a Class 2 and 3 building and a Class 4 part of building, building elements in *wet areas* must—
 - (i) be *water resistant* or *waterproof* in accordance with Table F1.7, except that—
 - (A) in any room containing a washing machine, the wall area from finished floor to a minimum of 75 mm above and 75 mm each side of the washing machine tap outlets must be *water resistant*; and
 - (B) where a *vessel* is inset into a bench top in a kitchen, bar area, kitchenette or domestic food and beverage preparation area, the perimeter edges of the vessel must be *water resistant* for the extent of the vessel; and
 - (C) penetrations in horizontal surfaces for tap and spout outlets in kitchens, bar areas, kitchenettes or domestic food and beverage preparation areas must be *waterproof*; and
 - (ii) comply with AS 3740.

Delete F1.9(b) and insert SA F1.9(b) as follows:

SA F1.9 Damp-proofing

- (b) Damp-proof courses must exhibit long term resistance to degradation by dissolved salts in groundwater and consist of—
- (i) embossed black polyethylene film meeting the requirements of clause 7.6 of AS/NZS 2904; or
 - (ii) polyethylene coated aluminium meeting the requirements of clause 7.4 of AS/NZS 2904; or
 - (iii) bitumen impregnated materials of not less than 2.5 mm thickness, meeting the requirements of clause 7.5 of AS/NZS 2904, when used in walls not higher than 7.8 m above the level of the damp-proof course.

Delete F1.10 and insert SA F1.10 as follows:

SA F1.10 Damp-proofing of floors on the ground

- (a) If a floor of a room is laid on the ground or on fill, a damp-proofing membrane complying with Section 5.3.3 of AS 2870 must be installed.
- (b) A damp-proofing membrane need not be provided if—
- (i) weatherproofing is not *required*; or
 - (ii) the floor is the base of a stair, lift or similar *shaft* which is adequately drained by gravitation or mechanical means.

Delete F1.11 and insert SA F1.11 as follows:

SA F1.11 Provision of floor wastes

- (a) A *wet area* provided with a *vessel* in accordance with F2.1, F2.3 and F2.4 must have the floor graded to a floor waste to permit drainage of water.
- (b) With the exception of a bathroom or laundry located at any level above a sole-occupancy unit or public space in a Class 2 or 3 building or Class 4 part of a building, a floor need not be graded to a floor waste in accordance with (a) if—
- (i) all *vessels* in the *wet area* are provided with in-built overflow protection or have permanent open trapped connection to the plumbing and drainage system (such as a WC pan); or
 - (ii) the *vessel* is a clinical hand washing basin in a Class 9c building; or
 - (iii) the floor waste is provided solely for the connection of plumbing fixtures.
- (c) The fall of the floor surface to a floor waste *required* by (a) or (b) must be—
- (i) between 1:60 and 1:80 in the *shower area*; and
 - (ii) between 1:80 and 1:100 in other areas.

Part F2 Sanitary and other facilities

Delete F2.4(a) to F2.4(b) and insert SA F2.4(a) to SA F2.4(b) as follows:

SA F2.4 Accessible sanitary facilities

- (a) *Accessible* unisex *sanitary compartments* must be provided in *accessible* parts of the building in accordance with Table F2.4(a) and SA Table F2.4(a)(i); and

SA Table F2.4(a)(i) Additional accessible unisex sanitary compartments

Class of building	Minimum facility for use by people with a disability
Class 2 In every <i>sole-occupancy unit required</i> by SA Table D3.1a to be <i>accessible</i>	Not less than 1

- (b) *Accessible* unisex showers must be provided in accordance with Table F2.4(b) and SA Table F2.4(b)(i); and

South Australia

SA Table F2.4(b)(i) Additional accessible unisex showers

Class of building	Minimum facility for use by people with a disability
Class 2 In every <i>sole-occupancy unit required</i> by SA Table D3.1a to be <i>accessible</i>	Not less than 1

Part F4 Light and ventilation

F4.5(b) is varied and SA F4.5(c) is added as follows—

SA F4.5 Ventilation of rooms

- (b) a mechanical ventilation or air-conditioning system complying with AS 1668.2 and AS/NZS 3666.1; or
- (c) in a *storage shed* or *bulk grain storage facility*, a ventilation system that provides one air change every six hours using openings that have a total area of—
 - (i) 35 m²; or
 - (ii) one percent of the total floor area, whichever is less.

Section G Ancillary provisions

Part G1 Minor structures and components

add SA GP1.2 application and SA GP1.2(c) as follows:

Performance Requirements

SA GP1.2 Swimming pool access and water recirculation systems

Application:

GP1.2 only applies to a *swimming pool* associated with a Class 2 or 3 building or Class 4 part of a building, with a depth of water more than 300 mm.

After GP1.2(b), add SA GP1.2(c) as follows:

SA GP1.2(c)

- (c) a swimming pool must have prominent and visible signage that assists persons to provide first aid and to perform cardiopulmonary resuscitation on young children.

Add SA G1.1(d) as follows:

SA G1.1 Swimming pools

- (d) For the purpose of clause 6.1.1 of AS 1926.3, a skimmer box is an outlet, and must have a means of releasing the vacuum pressure should the suction become blocked.
- (e) A first aid and cardiopulmonary resuscitation sign must—
- (i) be attached to the safety barrier of the swimming pool, or displayed near the swimming pool; and
 - (ii) be at least 300 mm by 300 mm in size; and
 - (iii) be made of durable and weatherproof material; and
 - (iv) show information about the procedures for providing first aid, including performing cardiopulmonary resuscitation.

SA Part G7 Access for maintenance

Objective

SA G07

The Objectives of this Part are—

- (a) to safeguard people from injury while cleaning *windows*; and
- (b) to safeguard people from injury or illness resulting from the creation of hazardous spaces between buildings.

Functional Statements

SA GF7.1

SA GF7.1

A building is to provide people with safe conditions for carrying out *window* cleaning operations.

SA GF7.2

The space between buildings must not allow hazardous conditions to arise due to accumulation of rubbish that cannot readily be removed.

Performance Requirements

SA GP7.1

SA GP7.1

Where any part of a *window* in a building is more than 5.5 m above ground level, provision must be made for safe access to the external surface of the *window* for minor maintenance and cleaning.

SA GP7.2

The space between buildings must be sufficient to allow access for inspection and maintenance, to avoid hazardous conditions arising due to accumulation of rubbish that could—

- (a) bridge termite barriers; or
- (b) harbour vermin; or
- (c) create a *fire hazard*.

SA G7.0 Deemed-to-Satisfy Provisions

Performance Requirements SA GP7.1 and *SA GP7.2* are satisfied by complying with *SA G7.1* to *SA G7.3*.

SA G7.1 Application of Part

The following provisions apply to Class 2 to 9 buildings.

SA G7.2 Access for window cleaning

Where any part of a *window* in a building is more than 5.5 m above ground level, access to the external surface of the *window* for minor maintenance and cleaning must be provided. Any of the following methods are acceptable—

- (a) by means of a moveable gantry; or
- (b) by means of reversible pivoting sashes, each of which has catches that secure the sash in either the normal or reversed position and give visual indication that the *window* is secure, provided that where a *window* sill is less than 900 mm above floor level, safety anchorages are provided; or

- (c) by means of safety harness, having all anchorages—
 - (i) designed and installed in accordance with AS/NZS 1891.4; and
 - (ii) constructed of approved corrosion resistant metal; or
- (d) by means of opening sashes, in which case the maximum reach to the farthest part of the *window* must not exceed 500 mm upwards or 1 m sideways or downwards and provided that where the *window* sill is less than 900 mm above floor level, safety anchorages are provided.

SA G7.3 Access for inspection and maintenance between buildings

Every part of an *external wall* of a building must be not less than 600 mm from—

- (a) the *external wall* of any other building on the same allotment, unless the two buildings are abutting; or
- (b) any boundary of the allotment, unless that wall is on or abutting that boundary, unless the space between external columns is not infilled.

SA Part G8 Miscellaneous provisions

Performance Requirements

SA GP8.1

An attachment to a building must incorporate features that will—

- (a) protect it against corrosion; and
- (b) collect and discharge its rainwater run-off safely; and
- (c) prevent its projection affecting adjacent road safety conditions or pedestrian traffic; and
- (d) provide resistance to the spread of fire if it overhangs a street boundary,

to a degree necessary to avoid creating hazardous conditions that may cause injury to people passing below or driving past.

SA G8.0 Deemed-to-Satisfy Provisions

Performance Requirement SA GP8.1 is satisfied by complying with [SA G8.1](#) and [SA G8.2](#).

SA G8.1 Application of Part

The following provisions apply to Class 2 to 9 buildings.

SA G8.2 Attachments to buildings

- (a) An attachment to a building that is in the nature of a balcony or awning, bridge, gangway, hoarding or trade sign, sky sign, mast, flagpole, tower, aerial or antenna, lantern, cathead, crane, chimney, flue or duct, or an installation for cleaning and maintenance access must—
 - (i) have all metal parts of corrosion resistant metal, or other metal suitably protected;
 - (ii) not overhang any street boundary at a height less than 2.5 m above the footpath, or 4 m above the roadway; and
 - (iii) be provided with drainage to prevent rainwater or condensate falling onto or running across the footpath, unless either it is a retractable awning in the nature of a sun blind, or unless the total catchment area for run-off is less than 1.5 m².
- (b) A balcony or awning that overhangs a street boundary—
 - (i) must not extend closer than 450 mm to the kerb of the roadway; and
 - (ii) must be constructed of *non-combustible* or fire-retardant materials throughout, except that timber battens may be used to support the soffit lining.

Section H

Special use buildings

SA Part H3 Farm buildings

SA H3.1 Application of Part

This Part does not apply in South Australia, refer to individual clauses for SA variations that are applicable to farm buildings.

SA H3.2 Concessions and additions for farm buildings

Class 7 and 8 farm buildings complying with Minister's Specification SA H3.2 — 'Concessions for farm buildings' and all other relevant BCA *Deemed-to-Satisfy Provisions* not varied by the Minister's Specification are deemed to satisfy the *Performance Requirements* of the BCA.

Section J Energy efficiency

SA Part J1 Building fabric

After J1.3(b) insert SA J1.3(c) as follows:

SA J1.3 Roof and ceiling construction

- (c) If a Class 5, 6, 7, 8 or 9 building, or part of a building—
- (i) is constructed in *climate zone* 4 or 5; and
 - (ii) has a roof pitch of not more than 5 degrees; and
 - (iii) has a *conditioned space*,
- the roofing material must have an upper surface solar absorptance value of not more than 0.4.

Schedule 3 Definitions

SA Schedule 3 Definitions

Insert definition for *agriculture* as follows:

Agriculture means cropping, grazing, animal husbandry, intensive animal keeping, horticulture, aquaculture, wool shearing or dairy, but does not mean viticulture or forestry.

Vary definition for *assembly building* as follows:

Assembly building means a building where people may assemble for—

- (a) civic, theatrical, social, political or religious purposes including a library, theatre, public hall or place of worship; or
- (b) educational purposes in a *school*, *early childhood centre*, preschool, or the like; or
- (c) entertainment, recreational or sporting purposes including—
 - (i) a discotheque or nightclub; or
 - (ii) a cinema; or
 - (iii) a sports stadium, sporting or other club; or
- (d) transit purposes including a bus station, railway station, airport or ferry terminal.

Insert definition for *brush fence* as follows:

Brush fence means a fence or gate that is primarily constructed of Broombrush (*Melalueca Uncinata*).

Insert definition for *bulk grain storage facility* as follows:

Bulk grain storage facility means a building or structure used for the commercial bulk handling or storage of granular materials such as grain, ore, or the like, where only a small number of occupants are present at one time and includes *cell type silos* and *storage sheds*.

Figure SA A1.1.7 Two types of bulk grain storage facilities

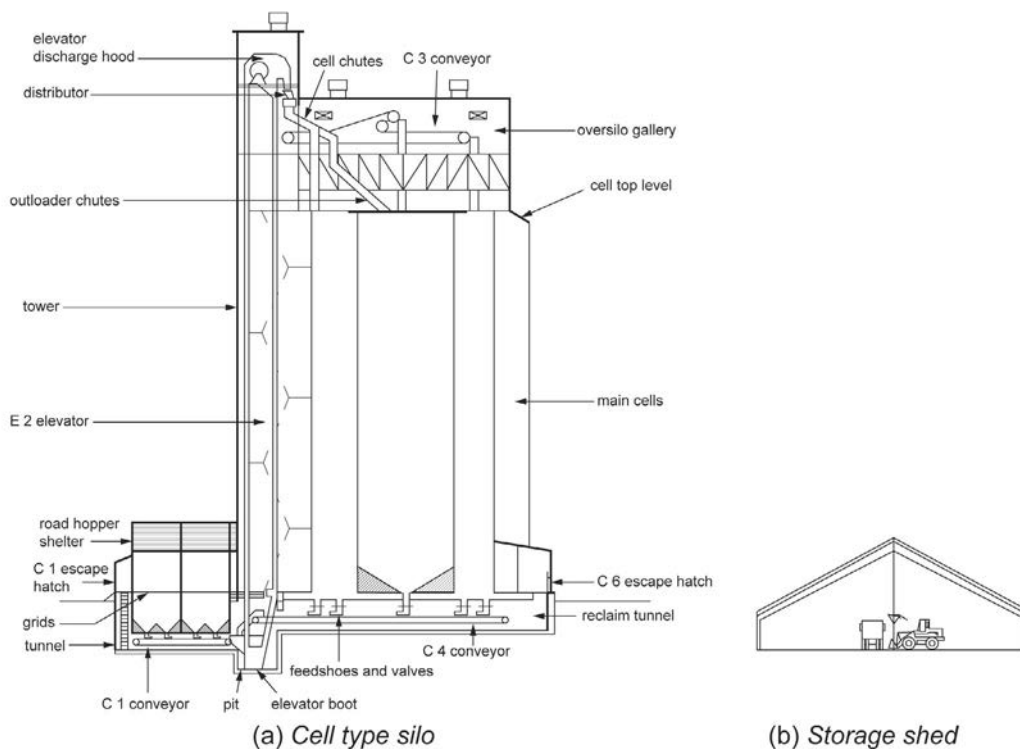

Insert definition for *cell type silo* as follows:

South Australia

Cell type silo means a type of *bulk grain storage facility* similar to that illustrated in Figure SA A1.1.7 (a).

Farm building means a single *storey* Class 7 or 8 building that is—

- (a) primarily associated with *agriculture* and located on land used primarily for *agriculture*; and
- (b) the total number of people accommodated in the building does not exceed one person per 200 m² of total *floor area*, or six people, whichever is greater; and
- (c) the *floor area* of each building does not exceed the maximum *floor area* and volume specified in SA Table 2 for the type of *farm building*; and
- (d) The building does not contain occupancies of excessive fire hazard as listed in Table E1.5; and
- (e) if the building is used for the storage of hay, an open space complying with C2.4(a) is provided around the perimeter of each building.

SA Table 2 Farm building categories and maximum floor area

Building group	Type of farm building	Maximum floor area	Maximum volume
Group A	Buildings used for the keeping, growing and/or harvesting of animals and/or plants. Includes greenhouses with rigid covering material and large implement/vehicle storage sheds.	5,000 m ²	30,000 m ³
Group B	Buildings used for packing, sorting and/or storage of produce and may include workshops	2,000 m ²	12,000 m ³
Group C	Greenhouses with non-rigid, plastic or fabric covering material	5,000 m ²	30,000 m ³

Insert definition for *small arts venue* as follows:

Small arts venue means the whole or the only part of a building that has a rise in storeys of not more than 2—

- (a) in which cultural activities including live music, visual arts displays, dancing, poetry and spoken word performances are provided to the public; and
- (b) the floor area used as a *small arts venue* does not exceed 300 m²; and
- (c) no pyrotechnics or theatrical smoke (smoke machines, hazers or the like) are used.

Insert definition for *storage shed* as follows:

Storage shed

means a type of *bulk grain storage facility* similar to that illustrated in Figure SA A1.1.7 (b).

Schedule 4 Referenced documents

Insert in Table 1 of [Schedule 4](#) additional standards as follows:

SA Schedule 4 Referenced documents

SA Table 1 Schedule of referenced documents

No.	Date	Title	Volume One
AS/NZS 1891 Part 4	2000	Industrial fall-arrest systems and devices: Selection, use and maintenance	SA G7.2

Footnote: Other legislation affecting buildings

In addition to any applicable provisions of the Development Act 1993, the Development Regulations 2008, the Planning, Development and Infrastructure Act 2016 and its associated regulations and this Code, there are a number of other legislative technical requirements affecting the design, construction and/or performance of buildings that practitioners may need to be aware of, including, but not necessarily limited to, the following list. Additional legislative instruments such as regulations, codes and standards may exist under the legislation listed.

1. Abattoirs

Administering agency

Department for Health and Wellbeing

Relevant legislation

Food Act 2001

Food Regulations 2017

2. Accommodation

Administering agency

Department for Human Services

Relevant legislation

Supported Residential Facilities Act 1992

Supported Residential Facilities Regulations 2009

3. Asbestos Removal

Administering agency

SafeWork SA, Department of the Premier and Cabinet

Relevant legislation

Work, Health and Safety Act 2012

Work, Health and Safety Regulations 2012

4. Children's Services

Administering agency

Department for Education

Relevant legislation

Children's Services Act 1985

5. Crown Land

Administering agency

Department for Environment and Water

Relevant legislation

Crown Land Management Act 2009

Crown Land Management Regulations 2010

6. Dangerous Goods

Administering agency

Department for Health and Wellbeing

Relevant legislation

Controlled Substances Act 1984

Controlled Substances (Pesticides) Regulations 2017

Controlled Substances (Poisons) Regulations 2011

Administering agency

Safework SA, Department of the Premier and Cabinet

Relevant legislation

Dangerous Substances Act 1979

Dangerous Substances (General) Regulations 2017

Explosives Act 1936

Explosives Regulations 2011

Explosives (Fireworks) Regulations 2016

Explosives (Security Sensitive Substances) Regulations 2006

7. Electrical Installations

Administering agency

Office of the Technical Regulator, Department for Industry and Skills

Relevant legislation

Electricity Act 1996

Electricity (General) Regulations 2012

Energy Products (Safety and Efficiency) Act 2000

Energy Products (Safety and Efficiency) Regulations 2012

8. Encroachments

Administering agency

Attorney-General's Department

Relevant legislation

Encroachments Act 1944

9. Fences

Administering agency

Attorney-General's Department

Relevant legislation

Fences Act 1975

Fences Regulations 2018

10. Fire Prevention in Existing Buildings

Administering agency

Department of Planning, Transport and Infrastructure

Relevant legislation

Development Act 1993

Development Regulations 2008

Administering agency

SA Fire and Emergency Services Commission

Relevant legislation

Fire and Emergency Services Act 2005

Fire and Emergency Services Regulations 2005

11. Food Premises

Administering agency

Department for Health and Wellbeing

Relevant legislation

Food Act 2001

Food Regulations 2017

12. Gas Installations**Administering agency**

Office of the Technical Regulator, Department for Industry and Skills

Relevant legislation

Gas Act 1997

Gas Regulations 2012

Energy Products (Safety and Efficiency) Act 2000

Energy Products (Safety and Efficiency) Regulations 2012

13. Historic Buildings**Administering agency**

Department for Environment and Water

Relevant legislation

Heritage Places Act 1993

Heritage Places Regulations 2005

14. Hospitals, Nursing Homes and Health Care Buildings**Administering agency**

Department for Health and Wellbeing

Relevant legislation

Health Care Act 2008

Health Care Regulations 2008

15. Housing**Administering agency**

Department of Human Services

Relevant legislation

Housing Improvement Act 2016

Housing Improvement Regulations 2017

16. Licensed Premises**Administering agency**

Office of Liquor and Gambling Commissioner, Attorney-General's Department

Relevant legislation

Liquor Licensing Act 1997

Liquor Licensing (General) Regulations 2012

17. Lift Installations**Administering agency**

Safework SA, Department of the Premier and Cabinet

Relevant legislation

Work, Health and Safety Act 2012

Work, Health and Safety Regulations 2012

18. Occupational Health and Safety

Administering agency

SafeWork SA, Department of the Premier and Cabinet

Relevant legislation

Work, Health and Safety Act 2012

Work, Health and Safety Regulations 2012

19. Pharmacies

Administering agency

Department for Health and Wellbeing

Relevant legislation

Health Practitioner Regulation National Law (South Australia) Act 2010

Health Practitioner Regulation National Law (South Australia) Regulations 2010

20. Radiation Safety

Administering agency

Environment Protection Authority

Relevant legislation

Radiation Protection and Control Act 1982

Radiation Protection and Control (Ionising Radiation) Regulations 2015

21. Sanitary Plumbing, Water Supply and Sewerage

Administering agency

Office of the Technical Regulator, Department for Industry and Skills

Relevant legislation

Water Industry Act 2012

Water Industry Regulations 2012

22. School (non-government)

Administering agency

Department for Education

Relevant legislation

Education Act 1972

Education Regulations 2012

23. Septic Tank and Grey Water Installations

Administering agency

Department for Health and Wellbeing

Relevant legislation

South Australian Public Health Act 2011

South Australian Public Health (Wastewater) Regulations 2013

South Australian Public Health (Legionella) Regulations 2013

24. Smoking Restrictions

Administering agency

Department for Health and Wellbeing

Relevant legislation

Tobacco Products Regulation Act 1997

Tobacco Products Regulations 2004

25. Subdivision of Property

Administering agency

Land Services Group, Department of Planning, Transport and Infrastructure

Relevant legislation

Community Titles Act 1996

Community Titles Regulations 2011

Real Property Act 1886

Real Property Regulations 2009

Strata Titles Act 1988

Strata Titles Regulations 2018

26. Waste Management and Environment Protection

Administering agency

Environment Protection Authority

Relevant legislation

Environment Protection Act 1993

Environment Protection Regulations 2009

Tasmania

Introduction

Section D Access and egress

Section E Services and equipment

Section F Health and amenity

Section G Ancillary provisions

Tas Part G2 * * * * *

Section H Special use buildings

Tas Part H101 * * * * *

Tas Part H102 Food premises

Tas Part H103 Dining rooms and bar rooms

Tas Part H104 * * * * *

Tas Part H105 * * * * *

Tas Part H106 Meat premises

Tas Part H107 Farm dairy premises

Tas Part H108 Pharmacies

Tas Part H109 Health service establishments

Tas Part H110	* * * * *
Tas Part H111	* * * * *
Tas Part H112	Mortuaries
Tas Part H113	Foundries
Tas Part H114	Premises for manufacture or processing of glass reinforced plastics
Tas Part H115	Premises for production or processing of isocyanates
Tas Part H116	Premises for electro-plating, electro-polishing, anodising or etching
Tas Part H117	Premises for lead processing
Tas Part H118	* * * * *
Tas Part H119	* * * * *
Tas Part H120	* * * * *
Tas Part H121	* * * * *
Tas Part H122	Early childhood centres and school age care facilities
Tas Part H123	Temporary structures
Tas Part H124	Premises where work is undertaken on gas-fuelled vehicles
Schedule 3	Definitions
Schedule 4	Referenced documents
Footnote:	Other legislation affecting buildings

Tasmania

Introduction

Section D Access and egress

Performance Requirements

Tas DP10

D3.0 Deemed-to-Satisfy Provisions

Tas D3.4 Exemptions

Tas D3.13 Compliance with Premises Standards

Section E Services and equipment

Performance Requirements

Tas EP1.7

Tas E1.0 Deemed-to-Satisfy Provisions

Tas E1.101 Fire detection and alarm system

Section F Health and amenity

Tas Table F2.3 Sanitary Facilities in Class 3, 5, 6, 7, 8 and 9 Buildings

Tas F2.101 Non-flushed Urinals

Tas F2.102 Installation of Closet Fixtures

Tas FP6.1 Condensation and water vapour management

Section G Ancillary provisions

Performance Requirements

Tas GP1.2 Swimming pool access and water recirculation systems

Tas GP1.6

Tas G1.0(b) Deemed-to-Satisfy Provisions

Tas G1.1 Swimming Pools

Tas Part G2 * * * * *

Section H Special use buildings

Tas Part H101 * * * * *

Tas Part H102 Food premises

Performance Requirements

Tas H102 P1

Tas H102 P2

Tas H102 P3

Tas H102 P4

Tas H102 P5

Tas H102 P6

Tas H102 P7

Tas H102 P8

Tas H102 P9

Tas H102 P10

Tas H102 P11

Tas H102 P12

Deemed-to-Satisfy provisions

- Tas H102.0 Application of Part
- Tas H102.1 Deemed-to-Satisfy Provisions
- Tas H102.2 General Requirements
- Tas H102.3 Pests and contaminants
- Tas H102.4 Drains and Pipes
- Tas H102.5 Offensive material and trade waste
- Tas H102.6 Ventilation
- Tas H102.7 Lighting
- Tas H102.8 Floors, walls and ceilings
- Tas H102.9 Separation of work place
- Tas H102.10 Washbasins
- Tas H102.11 Sinks
- Tas H102.12 Design, construction and installation of fixtures, fittings and equipment
- Tas H102.13 Storage of materials and equipment
- Tas H102.14 Food store
- Tas H102.15 Meat Premises
- Tas H102.16 Dairy produce
- Tas H102.17 Refrigerated and cooling chambers

Tas Part H103 Dining rooms and bar rooms

- Tas H103.1 Application of Part
- Tas H103.2 Sanitary facilities
- Tas H103.3 Separation from other areas

Tas Part H104 * * * * *

Tas Part H105 * * * * *

Tas Part H106 Meat premises

- Tas H106.1 Application of Part
- Tas H106.2 Premises Processing Animals and Meat

Tas Part H107 Farm dairy premises

- Tas H107.1 Application of this Part
- Tas H107.2 Milking Sheds and Holding Yards
- Tas H107.3 Milk Receiving Area and Milk Storage Room
- Tas H107.4 Water supply

Tas Part H108 Pharmacies

- Tas H108.1 Application of Part
- Tas H108.2 Definition
- Tas H108.3 Pharmacy premises
- Tas H108.4 Dispensary
- Tas H108.5 Security of dispensary

Tas Part H109 Health service establishments

- Tas H109.1 Application of Part
- Tas H109.2 Design and construction of health service establishments

Tas Part H110 * * * * *

Tas Part H111 * * * * *

Tas Part H112 Mortuaries

- Tas H112.1 Application of Part
- Tas H112.2 Layout of mortuary
- Tas H112.3 Construction of body preparation room
- Tas H112.4 Water supply and sewerage

Tas Part H113 Foundries

- Tas H113.1 Application of Part
- Tas H113.2 General
- Tas H113.3 Cupola charging platform
- Tas H113.4 Deep moulds and pits
- Tas H113.5 Pot furnaces

Tas Part H114 Premises for manufacture or processing of glass reinforced plastics

- Tas H114.1 Application of Part
- Tas H114.2 Separation from other buildings
- Tas H114.3 Rise in storeys
- Tas H114.4 Maximum floor areas
- Tas H114.5 Required exits
- Tas H114.6 Hand laminating and spray depositing
- Tas H114.7 Ventilation
- Tas H114.8 Smoke and heat roof vents

Tas Part H115 Premises for production or processing of isocyanates

- Tas H115.1 Application of Part
- Tas H115.2 Areas of work places
- Tas H115.3 Separation from other areas and buildings
- Tas H115.4 Rise in storeys
- Tas H115.5 Maximum floor areas
- Tas H115.6 Required exits
- Tas H115.7 Bulk stores for polyols and isocyanates
- Tas H115.8 Curing room

Tas Part H116 Premises for electro-plating, electro-polishing, anodising or etching

- Tas H116.1 Application of Part
- Tas H116.2 Floors
- Tas H116.3 Height of plating area
- Tas H116.4 Air space
- Tas H116.5 Ceiling construction

Tas Part H117 Premises for lead processing

- Tas H117.1 Application of Part
- Tas H117.2 Floors
- Tas H117.3 Height of lead processing areas
- Tas H117.4 Air space and floor space
- Tas H117.5 Interior of lead processing areas
- Tas H117.6 Dust collection
- Tas H117.7 Isolation of certain processes
- Tas H117.8 Drying room shelves
- Tas H117.9 Washing facilities
- Tas H117.10 Change rooms

Tas Part H118 * * * * *

Tas Part H119 * * * * *

Tas Part H120 * * * * *

Tas Part H121 * * * * *

Tas Part H122 Early childhood centres and school age care facilities

Performance Requirements

Tas H122 P1

Tas H122 P2

Tas H122 P3

Deemed-to-Satisfy Provisions

Tas H122.0 Application of Part

Tas H122.1 Deemed-to-Satisfy Provisions

Tas Part H123 Temporary structures

Performance Requirements

Tas H123 P1

Tas H123 P2

Tas H123 P3

Tas H123 P4

Tas H123 P5

Tas H123 P6

Tas H123 P7

Tas H123 P8

Tas H123 P9

Tas H123 P10

Tas H123 P11

Tas H123 P12

Tas H123 P13

Tas H123 P14

Tas H123 P15

Deemed-to-Satisfy Provisions

Tas H123.0 Application of Part

Tas H123.1 Deemed-to-Satisfy Provisions

Tas H123.2 * * * * *

Tas H123.3 * * * * *

Tas H123.4 Access

Tas H123.5 * * * * *

Tas H123.6 * * * * *

Tas H123.7 * * * * *

Tas H123.8 * * * * *

Tas H123.9 * * * * *

Tas H123.10 * * * * *

Tas H123.11 Lighting

Tas H123.12 Ventilation

Tas H123.13 Electrical

Tas H123.14 Heating appliances

Tas H123.15 * * * * *

Tas Part H124 Premises where work is undertaken on gas-fuelled vehicles

Tas H124.1 Application of Part

Tas H124.2 Working areas

Schedule 3 Definitions

Tas Schedule 3 Definitions

Schedule 4 Referenced documents

Tas Schedule 4 Referenced documents

Footnote: Other legislation affecting buildings

1. Work Places

Introduction

This Appendix contains variations and additions to the Building Code of Australia (BCA) provisions which are considered necessary for the effective application of the BCA in Tasmania and shall be treated as amendments to the Code.

Section D Access and egress

After DP9 add Tas DP10

Performance Requirements

Tas DP10

A building or part of a building must be *accessible* in accordance with the requirements of a Standard made under the *Disability Discrimination Act 1992 (Cth)*.

Part D3 Access for people with a disability

Delete D3.0 Deemed-to-Satisfy Provisions and substitute:

D3.0 Deemed-to-Satisfy Provisions

- (a) Where a *Deemed-to-Satisfy Solution* is proposed, *Performance Requirements DP1 to DP6, DP8, DP9 and Tas DP10* are satisfied by complying with—
- (i) *D1.1 to D1.16, D2.1 to D2.25, D3.1 to D3.12, and Tas D3.13*; and
 - (ii) in a building containing an *atrium, Part G3*; and
 - (iii) additional requirements for Class 9b buildings, *Part H1*; and
 - (iv) for public transport buildings, *Part H2*.
- (b) Where a *Performance Solution* is proposed, the relevant *Performance Requirements* must be determined in accordance with *A2.2(3)* and *A2.4(3)* as applicable.

After D3.4(c) add Tas D3.4(d)

Tas D3.4 Exemptions

- (d) The Class 2 parts of a building where—
- (i) the building is an existing building with a *rise in storeys* of two; and
 - (ii) the *storey* at ground level is Class 5 or 6; and
 - (iii) the upper *storey* is comprised of two or more Class 2 *sole-occupancy units* that are not made available for short-term rental.

After D3.12 add Tas D3.13

Tas D3.13 Compliance with Premises Standards

- (a) A building solution must comply with the Disability (Access to Premises – Buildings) Standards.
- (b) A building solution complies with *Tas D3.0(a)* if it complies with the applications, exceptions and concessions in the Disability (Access to Premises – Buildings) Standards.

Section E Services and equipment

Part E1 Fire fighting equipment

After EP1.6 insert *Performance Requirement* Tas EP1.7 as follows:

Performance Requirements

Tas EP1.7

An *automatic* fire detection system must be installed to the degree necessary to alert the *fire brigade* of fire so that fire fighting operations may be undertaken at the earliest possible time appropriate to—

- (a) the building functions and use; and
- (b) the *fire hazard*; and
- (c) the height of the building; and
- (d) the building *floor area*.

Limitation:

Tas EP1.7 only applies to:

- (a) a Class 5 building or Class 6 building having an aggregate *floor area* of more than 1000 m²; and
- (b) a Class 7 building having a *floor area* of more than 1000 m² in which furniture is stored; and
- (c) a Class 8 building which is a special *fire hazard* building and in which more than 25 persons are employed; and
- (d) a Class 9b building which is a *school* or *early childhood centre* or a creche which-
 - (i) is of more than 1 *storey*; or
 - (ii) has a storey with a *floor area* more than 500 m²; and
- (e) a Class 9b building which is a theatre.

Delete E1.0 and insert Tas E1.0 as follows:

Tas E1.0 Deemed-to-Satisfy Provisions

Performance Requirements EP1.1 to EP 1.6 and *Tas EP1.7* are satisfied by complying with E1.1 to E1.10, *Tas E1.101*, and for *farm buildings* and *farm sheds*, *Part H3*.

After E1.10 insert *Tas E1.101* as follows:

Tas E1.101 Fire detection and alarm system

An *automatic* fire detection and alarm system must comply with *Clauses 4* and *8* of *Specification E2.2a*.

Section F Health and amenity

Part F2 Sanitary facilities

Tas Table F2.3 Sanitary Facilities in Class 3, 5, 6, 7, 8 and 9 Buildings

Delete the Note in Table F2.3 alongside *early childhood centres* and replace it with the following:

Note: If the centre accommodates children under 4 years of age the facilities for use by those children must be—

- (a) junior pans; and
- (b) wash basins with a rim height not exceeding 600 mm.

After F2.8 insert Tas F2.101 as follows:

Tas F2.101 Non-flushed Urinals

Non-flushed urinals not connected to a sewerage system must comply with [Tas F2.102](#).

After Tas F2.101 insert Tas F2.102 as follows:

Tas F2.102 Installation of Closet Fixtures

- (a) If a sufficient sewerage system is not available, an authorised alternative means of disposal of sewage, may be installed.
- (b) If sanitary facilities are not water-flushed, the following provisions apply:
 - (i) A pit latrine, an incinerating toilet, a chemical toilet, a removable pan or a non-flushing urinal must not be within 2 m of a building containing habitable rooms.
 - (ii) The floor on which a removable pan is placed must be impervious.
 - (iii) A room containing a composting toilet must be separated from habitable rooms by way of a permanently ventilated air lock (which may be a circulation space).
 - (iv) The minimum ventilation *required* under (iii) shall be the greater of—
 - (A) 8000 mm²; or
 - (B) 1/500th of the *floor area* of the circulation space.
 - (v) Access for maintenance or removal of waste from a composting toilet must be by way of an access door which opens directly to the outside of the building.

Part F6 Condensation management

Tas FP6.1 Condensation and water vapour management

After FP6.1 insert the following:

Note:

Refer to the guidance in the “Condensation in Buildings Tasmanian Designers’ Guide - Version 2” that should be adhered to where possible.

Section G Ancillary provisions

Part G1 Minor structures and components

Delete GP1.2(a) and insert Tas GP1.2(a) as follows:

Performance Requirements

Tas GP1.2 Swimming pool access and water recirculation systems

- (a) A barrier must be provided to a *swimming pool* and must—
- (i) be continuous for the full extent of the hazard; and
 - (ii) be of a strength and rigidity to withstand the foreseeable impact of people; and
 - (iii) restrict the access of young children to the pool and the immediate pool surrounds; and
 - (iv) have any gates and doors fitted with latching devices not readily operated by young children, and constructed to automatically close and latch.

Application:

Tas GP1.2(a) only applies to a *swimming pool* associated with a Class 2 or 3 building or Class 4 part of a building, with a depth of water more than 300 mm.

After GP1.5 insert *Performance Requirements* Tas GP1.6 as follows:

Tas GP1.6

swimming pools must be suitable and safe to use and be provided with appropriate facilities.

Limitation:

Tas GP1.6 does not apply to a *swimming pool* associated with a Class 2 building.

Delete G1.0(b) and insert Tas G1.0(b) as follows:

Tas G1.0(b) Deemed-to-Satisfy Provisions

Performance Requirements GP1.2 to GP1.5, Tas GP1.2 and Tas GP1.6 are satisfied by complying with G1.1 to G1.3 and Tas G1.1.

After G1.1(c) insert Tas G1.1(d) to (i) as follows:

Tas G1.1 Swimming Pools

- (d) *Swimming pools* for the use of the public, a club, or an association, or in connection with Class 3, 5, 6, 7, 8 or 9 buildings must—
- (i) be constructed of durable materials with smooth finishes; and
 - (ii) have sides vertical; and
 - (iii) in that part of the pool where the water depth is not more than 1.5 m, have the bottom or floor slope not steeper than 1 vertical to 15 horizontal; and
 - (iv) have the depth of water marked clearly and conspicuously on each side of the pool (at the shallow end and at the deep end); and
 - (v) not have diving boards installed where the water depth is less than 3.5 m; and
 - (vi) have scum-gutters with opening not less than 150 mm if they are to provide hand-holds; and
 - (vii) have the floor or bottom of the pool, except for the guide lines, of such colours that the light reflectance is not less than 60%.
- (e) For a public *swimming pool* or pool in which competitions are held—
- (i) all steps into the pool must be recessed; and

Tasmania

- (ii) fittings must not project into the water area; and
 - (iii) piping must not be bracketed to the sides to provide hand-holds; and
 - (iv) surrounding concourses must be provided not less than 2 m wide, with a suitable non-slip surface, graded away from the pool and drained to waste; and
 - (v) dressing rooms with sanitary accommodation must be so located that bathers pass through that accommodation enroute to the *swimming pool*.
- (f) If the volume of a *swimming pool* exceeds 15 m³—
- (i) an adequate water recirculation, disinfection and filtration system must be installed; and
 - (ii) the inlet and outlet openings in a *swimming pool* for the purpose of water recirculation must be so located that water movement is continuous from inlet to outlet; and
 - (iii) * * * * *
 - (iv) recirculation of water in a *swimming pool* must be so designed that the pool contents are recirculated not less than once in the period shown in [Tas Table G1.1\(f\)](#); and
 - (v) water filtration rates must not exceed 12 250 L/m² of sand filter bed per hour, or an equivalent rate in other filter media.

Tas Table G1.1(f) Recirculation of water in swimming pools

Pool type	Period (hours)
Outdoor <i>swimming pool</i>	6 hours
Indoor <i>swimming pool</i>	4 hours
Wading pool	2 hours

- (g) Where no other suitable sanitary accommodation is provided, sanitary facilities must be provided in accordance with [Tas Table G1.1\(g\)](#).

Tas Table G1.1(g) Sanitary facilities at swimming pools

Gender	Maximum number served by 1 closet fixture	Maximum number served by each extra closet fixture	Maximum number served by 1 urinal	Maximum number served by each extra urinal	Maximum number served by 1 wash basin	Maximum number served by each extra wash basin
Males	60	60	60	60	60	60
Females	40	40	N/A	N/A	60	60

- (h) Where no other suitable shower facilities are provided, showers must be provided so that each shower serves up to 40 persons.

Tas Part G2

* * * * *

This Part has been deliberately left blank.

Section H

Special use buildings

Tas Part H101

* * * * *

This Part has deliberately been left blank.

Tas Part H102**Food premises****Performance Requirements****Tas H102 P1**

The design and construction of food premises must—

- (a) be appropriate for the activities for which the premises are used; and
- (b) provide adequate space for the activities to be conducted on the food premises and for the fixtures, fittings and equipment used for those activities; and
- (c) permit the food premises to be effectively cleaned and, if necessary, sanitized; and
- (d) to the extent that is practicable:
 - (i) exclude dirt, dust, odours, fumes, smoke and other contaminants; and
 - (ii) not permit the entry of pests; and
 - (iii) not provide harbourage for pests.
- (e) provide that the food premises is able to be used in such a manner that minimises opportunities for food contamination.

Tas H102 P2

- (a) Food premises must have an adequate supply of water if water is to be used at the food premises for any of the activities conducted on the food premises.
- (b) A food business must use potable water for all activities that use water that are conducted on the food premises.

Limitation:

If a food business demonstrates that the use of non-potable water for a purpose will not adversely affect the safety of the food handled by the food business, sub-clause (b) does not apply.

Tas H102 P3

Food premises must have a sewage and waste water disposal system that—

- (a) will effectively dispose of all sewage and waste water; and
- (b) is constructed and located so that there is no likelihood of the sewage and waste water polluting the water supply or contaminating food.

Tas H102 P4

Food premises must have facilities for the storage of garbage and recyclable matter that—

- (a) adequately contain the volume and type of garbage and recyclable matter on the food premises; and
- (b) enclose the garbage or recyclable matter, if this is necessary to keep pests and animals away from it; and
- (c) are designed and constructed so that they may be easily and effectively cleaned.

Tas H102 P5

Food premises must have sufficient natural or mechanical ventilation to remove fumes, smoke and vapours from the food premises.

Tas H102 P6

Food premises must have lighting systems that provide sufficient natural or artificial light for the activities conducted on the food premises.

Tas H102 P7

- (a) Floors must be designed and constructed in a way that is appropriate for the activities conducted on the food premises.
- (b) Floor must—
 - (i) be able to be effectively cleaned; and
 - (ii) be unable to absorb grease, food particles or water; and
 - (iii) be laid so that there is no ponding of water; and
 - (iv) to the extent that is practicable, be unable to provide harbourage for pests.

Application:

The requirements for floors apply to the floors of all areas used for food handling, cleaning, sanitizing and personal hygiene except the following areas—

- (a) dining areas; and
- (b) drinking areas; and
- (c) other areas to which members of the public usually have access.

Limitation:

The following floors do not have to comply with sub-clause (b)—

- (a) floors of temporary food premises, including ground surfaces, that are unlikely to pose any risk of contamination of food handled on the food premises; and
- (b) floors of food premises that are unlikely to pose any risk of contamination of food handled on the food premises provided the food business has obtained approval for their use.

Tas H102 P8

Walls and ceilings—

- (a) must be designed and constructed in a way that is appropriate for the activities conducted on the food premises; and
- (b) must be provided where they are necessary to protect food from contamination; and
- (c) provided in accordance with sub-clause (b) must be—
 - (i) sealed to prevent the entry of dirt, dust and pests; and
 - (ii) unable to absorb grease, food particles or water; and
 - (iii) be able to be easily and effectively cleaned; and
- (d) must—
 - (i) be able to be effectively cleaned; and
 - (ii) to the extent that is practicable, be unable to provide harbourage for pests.

Application:

The requirements for walls and ceilings apply to the walls and ceilings of all areas used for food handling, cleaning, sanitizing and personal hygiene except the following areas—

- (a) dining areas; and
- (b) drinking areas; and
- (c) other areas to which members of the public usually have access.

Tas H102 P9

- (a) Food premises must have hand washing facilities that are located where they can be easily accessed by food handlers—
 - (i) within areas where food handlers work if their hands are likely to be a source of contamination of food; and

- (ii) if there are toilets on the food premises—immediately adjacent to the toilets or toilet cubicles.
- (b) Hand washing facilities must be—
 - (i) permanent fixtures; and
 - (ii) provided with a supply of warm running potable water; and
 - (iii) of a size that allows easy and effective hand washing; and
 - (iv) clearly designated for the sole purpose of washing hands, arms and face.

Tas H102 P10

Fixtures, fittings and equipment must—

- (a) be adequate for the production of wholesome food; and
- (b) be fit for their intended use; and
- (c) be designed, constructed, located and installed, and equipment must be located and, if necessary, installed, so that—
 - (i) there is no likelihood that they will cause food contamination; and
 - (ii) they are able to be easily and effectively cleaned; and
 - (iii) adjacent floors, walls, ceilings and other surfaces are able to be easily and effectively cleaned; and
 - (iv) to the extent that is practicable, they do not provide harbourage for pests; and
- (d) have food contact surfaces—
 - (i) able to be easily and effectively cleaned and, if necessary, sanitized if there is a likelihood that they will cause food contamination; and
 - (ii) unable to absorb grease, food particles and water if there is a likelihood that they will cause food contamination; and
 - (iii) made of a material that will not contaminate food.

Tas H102 P11

Food premises must have adequate storage facilities—

- (a) for the storage of items that are likely to be the source of contamination of food, including chemicals, clothing and personal belongings; and
- (b) located where there is no likelihood of stored items contaminating food or food contact surfaces.

Tas H102 P12

All refrigerated or cooling chambers must be constructed so that stored products will not be contaminated.

Application:

- (a) [Tas H102 P1](#) to [P12](#) applies to any premises where food intended for human consumption is manufactured, processed, prepared, packed, stored or sold and to which the following apply—
 - (i) *Food Act*; or
 - (ii) *Liquor and Accommodation Act*; or
 - (iii) *Primary Produce Safety Act*; or
 - (iv) *Dairy Industry Act*.
- (b) [Tas H102 P1](#) to [P12](#) includes, but is not limited to—
 - (i) bakehouses; and
 - (ii) bar service areas; and
 - (iii) premises for boning, curing, canning, mincing, pre-packing or other similar processes of preparation of meat for sale; and
 - (iv) retail meat premises; and

- (v) eating houses and tea shops; and
 - (vi) fish shops; and
 - (vii) kitchens in eating houses, restaurants, guest houses, motels and hotels; and
 - (viii) rooms for processing, manufacturing, packing, etc of fruit and vegetables, dairy products, ice blocks, ices, meat-for-sale, or other fish; and
 - (ix) primary produce business premises regulated by or under a Food Safety Scheme made under the *Primary Produce Safety Act*; and
 - (x) take-away-food stores; and
 - (xi) breweries and wineries.
- (c) In [Tas H102 P1](#) to [P12](#), words and meaning as defined in the *Food Act*, *Food Standards Code* and *Liquor and Accommodation Act*, *Dairy Industry Act* and *Primary Produce Safety Act* apply.

Limitations:

[Tas H102 P1](#) to [P12](#) do not apply to—

- (a) domestic dwellings classified as Class 1 buildings; or
- (b) boarding houses or the like classified as Class 1 buildings; or
- (c) tents, buildings or other structures used temporarily for serving meals to the public at any fair, show, race meeting or other public sports, games or amusements; or
- (d) meat premises covered by [Tas H106](#); or
- (e) dairies covered by [Tas H107](#); or
- (f) live shellfish premises where live shellfish are being packed or handled for transport or transferral to shellfish processing premises; or
- (g) premises that only sell pre-packaged food that is not potentially hazardous.

Deemed-to-Satisfy provisions
Tas H102.0 Application of Part

- (a) This Part applies to any premises where food intended for human consumption is manufactured, processed or sold and to which the following apply—
- (i) *Food Act 2003*; or
 - (ii) *Liquor and Accommodation Act*; or
 - (iii) *Primary Produce Safety Act*; or
 - (iv) *Dairy Industry Act*.
- (b) This Part includes, but is not limited to—
- (i) bakehouses; and
 - (ii) bar service areas; and
 - (iii) premises for boning, curing, canning, mincing, pre-packing or other similar processes of preparation of meat for sale; and
 - (iv) retail meat premises; and
 - (v) eating houses and tea shops; and
 - (vi) fish shops; and
 - (vii) kitchens in eating houses, restaurants, guest-houses, motels and hotels; and
 - (viii) rooms for processing, manufacturing, packing, etc of fruit and vegetables, dairy products, ice blocks, ices, meat-for-sale or other fish; and
 - (ix) primary produce business premises regulated by or under a Food Safety Scheme made under the *Primary Produce Safety Act*; and
 - (x) take-away-food stores; and

- (xi) breweries and wineries.
- (c) This Part does not apply to—
 - (i) boarding houses or the like classified as Class 1 buildings; or
 - (ii) tents, buildings or other structures used temporarily for serving meals to the public at any fair, show, race meeting or other public sports, games or amusements; or
 - (iii) dairies covered by [Tas Part H107](#); or
 - (iv) live shellfish premises where live shellfish are being packed or handled for transport or transferral to shellfish processing premises; or
 - (v) premises that only sell pre-packaged food that is not potentially hazardous.
- (d) In this Part, words and meanings as defined in the *Food Act*, *Food Standards Code* and *Liquor and Accommodation Act*, *Dairy Industry Act* and *Primary Produce Safety Act* apply.

Tas H102.1 Deemed-to-Satisfy Provisions

[Performance Requirements Tas H102 P1](#) to [Tas H102 P12](#) are satisfied by complying with the relevant provisions of [Tas H102.0](#) to [Tas H102.17](#).

Tas H102.2 General Requirements

- (a) The provision of—
 - (i) close-fitting windows and doors; and
 - (ii) air intakes that do not draw in contaminated air; and
 - (iii) air locks and self-closing doors to separate toilet areas, laundries and living areas from food handling areas; or
 - (iv) mechanical ventilation that removes sources of contamination, satisfies [Tas H102 P1\(d\)\(i\)](#).
- (b) The provision of—
 - (i) self-closing or pest-screened external doors; and
 - (ii) mesh screens at opening windows or other ventilation openings; and
 - (iii) sealing to drains, grease traps and ventilation pipes; and
 - (iv) sealing to openings where pipes pass through external walls; and
 - (v) the installation of pest-proof flashings to doors, satisfies [Tas H102 P1\(d\)\(ii\)](#).
- (c) The provision of—
 - (i) vermin-proof sealing; or
 - (ii) filling; or
 - (iii) access for inspection and cleaning of boxed-in areas, satisfies [Tas H102 P1\(d\)\(iii\)](#).
- (d) The provision of a reticulated water supply from—
 - (i) a regulated entity; or
 - (ii) a private water supply with on-site treatment, which meets the Australian Drinking Water Guidelines, satisfies [Tas H102 P2\(b\)](#).

Note: 'Regulated entity' has the same meaning as the Water and Sewerage Industry Act.

Tas H102.3 Pests and contaminants

Premises where customers are served outside the premises through an opening, that has an appliance for the elimination of flies and mechanical ventilation adequate to exhaust air through the opening at a rate of not less than 5 litres per second for each square metre of opening, satisfies [Tas H102 P1\(d\)](#).

Tas H102.4 Drains and Pipes

Premises satisfy [Tas H102 P3](#) where—

- (a) A grease trap, a gully trap or an untrapped opening connected directly with a drain or sewer, is not installed in a room used for preparation, processing, packing or storing of food for sale; and
- (b) as far as is practicable, service pipes are concealed beneath the surface of walls, floors or ceilings, or are fixed clear of the wall, floor or ceiling, at such distance as to facilitate cleaning.

Tas H102.5 Offensive material and trade waste

Where offensive material or trade waste is stored, a separate area or room which—

- (a) is paved and easily cleanable; and
 - (b) is graded to drain to a suitable drainage system; and
 - (c) has available a supply of water under pressure,
- satisfies [Tas H102 P4](#).

Tas H102.6 Ventilation

A mechanical ventilating exhaust system complying with the requirements of AS/NZS 1668.1 and AS 1668.2 satisfies [Tas H102 P5](#).

Tas H102.7 Lighting

A lighting system that—

- (a) complies with AS 1680.1 and AS/NZS 1680.2.4; and
 - (b) in areas where open food is handled or stored, has light fittings which are—
 - (i) designed and constructed to prevent contamination of food should the globe or tube shatter; and
 - (ii) free from any features that would harbour dirt, dust, or insects or make the fitting difficult to clean,
- satisfies [Tas H102 P6](#).

Tas H102.8 Floors, walls and ceilings

- (a) Floors, walls and ceilings constructed in accordance with Section 3 of AS 4674, satisfy [Tas H102 P7](#) and [Tas H102 P8](#).
- (b) The wall and ceiling provisions of (a) do not apply to areas in which all food for sale is completely enclosed and otherwise protected from contamination by processing plants, other appliances or other means.

Tas H102.9 Separation of work place

- (a) A room where food for sale is processed, manufactured, prepared, deposited, treated, stored or packed, that does not have direct communication with a room containing sanitary facilities, living quarters, laundry, bathroom or garage or a room where animals are housed, satisfies [Tas H102 P8\(b\)](#).
- (b) 'Direct communication' means a doorway, a window or other opening in a wall between a food preparation or storage area opening directly onto a room described in (a). Access between those areas via another room, a hallway, or an airlock, satisfies [Tas H102 P8\(b\)](#).

Tas H102.10 Washbasins

- (a) Premises or places for preparation or storage of food for sale provided with not less than one washbasin complying with (b) within five metres of any activity where hands are likely to be a source of contamination of food, satisfies [Tas H102 P9](#).
- (b) Each washbasin must—
 - (i) have hot and cold water through a common outlet; and
 - (ii) have a capacity of at least 11 litres; and

- (iii) provide not less than 250 mm between the spout and the bottom of the basin; and
- (iv) be in a position that is not obstructed.

Tas H102.11 Sinks

- (a) Where equipment and utensils are required to be manually cleaned and sanitized, or food preparation requires a sink, premises that are provided with a suitably sized double bowl sink for equipment washing and a separate suitably sized sink for food preparation of stainless steel supplied with—
 - (i) hot and cold water; and
 - (ii) an integral drainer on at least one side or a third bowl, satisfies [Tas H102 P10](#).
- (b) A sink installed adjacent to a wall or other vertical surface, that is fitted with an integral flashing to that wall or vertical surface to a height of not less than 150 mm, satisfies [Tas H102 P10](#).
- (c) A sink provided with an integral surround not less than 150 mm wide except on sides with an integral flashing as in [\(b\)](#), satisfies [Tas H102 P10](#).
- (d) A cleaner's sink separated from food storage and handling areas provided for the emptying of cleaning water, satisfies [Tas H102 P10](#).

Tas H102.12 Design, construction and installation of fixtures, fittings and equipment

- (a) The provision of fixtures, fittings and equipment designed, constructed and installed in accordance with clause 4.2 and clause 4.3 of AS 4674 satisfies [Tas H102 P10](#).
- (b) The provision of—
 - (i) automatic equipment that uses water to sanitize utensils or other equipment and only operate for the purposes of sanitation when the water is at a temperature that will sanitize the utensils or equipment; or
 - (ii) a sink that meets [Tas H102.11](#), satisfies [Tas H102 P10](#).

Tas H102.13 Storage of materials and equipment

- (a) Separate areas for the storage of fuel, cleaning compounds and general maintenance equipment provided so as to prevent the contamination of the product in the event of a spillage or any other form of breakdown, satisfies [Tas H102 P11](#).
- (b) A separate area for the storage of staff clothing and personal effects, satisfies [Tas H102 P11](#).

Tas H102.14 Food store

An eating house provided with a dry-food store, satisfies [Tas H102 P11](#).

Tas H102.15 Meat Premises

- (a) Premises used for the preparation or sale of red meat, other than those licensed under the *Primary Produce Safety Act*, that comply with—
 - (i) [Tas Part H106](#); or
 - (ii) the provisions of [Tas H102.2](#) to [Tas H102.13](#) and [Tas H102.17](#), satisfy in relation to building construction, the requirements of [Tas H102 P1](#) to [P12](#).

Tas H102.16 Dairy produce

Definition:

- (a) **Dairy produce** products include milk, colostrum, liquid milk products, cream and thickened cream, butter, butter concentrate, buttermilk, concentrated buttermilk, dairy blend, ghee, anhydrous milk fat (butter oil), casein, caseinate, cheese, whey, whey cream, concentrated whey cream, cultured milk, yoghurt, ice cream, ice cream mix, buttermilk powder, lactose powder, milk sugar, powdered milk, skim milk powder, whey powder, milk protein powder and other milk concentrates.

- (b) Premises designed and constructed in compliance with the Export Control (Milk and Dairy) Orders, satisfy the special requirements of this code for premises to be used for the manufacture of *dairy produce*.

Tas H102.17 Refrigerated and cooling chambers

The construction of a refrigerated chamber or cooling chamber installed in premises for storage of food complying with the requirements for that premises, satisfies [Tas H102 P12](#) where they have—

- (a) internal and external panels adhered directly to the insulating core material to form an integral wall section with tight fitting edges resistant to penetration by liquids; and
- (b) every joint caulked with a water-resistant, flexible sealer and finished in such a manner as to prevent migration of liquids into the core; and
- (c) every intersection of walls with floors and walls with walls coved with a radius not less than 25 mm; and
- (d) exposed slot-head screws or open-headed pop rivets filled with sealer; and
- (e) service pipes and conduits concealed in floors, walls or ceilings, if practicable, or fixed on brackets to provide clearances of not less than 25 mm between the pipe and a wall and 100 mm between the pipe and a floor; and
- (f) fittings not fixed over exposed pipes nor in a position to make difficult the cleaning of the pipe and surrounding area; and
- (g) rat proof construction, and any inaccessible spaces between the low temperature room and surrounding walls, ceilings and fixtures proof against rats and vermin; and
- (h) floors graded, as shown in [Tas Table H102.17\(h\)](#), to drains located outside the chamber as near as practicable to the door opening; and
- (i) drainage from cooling units within the chamber constructed in accordance with [Tas Table H102.17\(i\)](#), draining to a trapped outlet located outside the chamber.

Tas Table H102.17(h) Floor drainage of refrigerated or cooling chambers

	Floor slope
Active chillers	not less than 1:50
Other chambers	not less than 1:100

Tas Table H102.17(i) Drainage from cooling units within refrigerated chambers or cooling chambers

Wall-mounted cooling units - drain water must be contained and removed by either a wall-mounted channel or a spoon drain located under the coil.
Floor-mounted cooling units - drain water must be confined by kerbs, of a height not less than 150 mm, and directed to a trapped drain outlet.
Ceiling-mounted cooling units - drain water must be confined by suitable insulated drip trays directly connected to the drainage system.

Tas Part H103**Dining rooms and bar rooms**

Tas H103.1 Application of Part

This Part applies to all dining rooms and bar rooms (excluding bar service areas) in licensed premises covered by the *Liquor and Accommodation Act*.

Dining rooms and bar rooms must provide for the comfort, convenience and health of customers.

Tas H103.2 Sanitary facilities

- (a) Separate sanitary facilities for males and females must be provided in close proximity to each dining room and bar room in licensed premises.
- (b) Where the sanitary facilities are not accessed from within the dining room or bar area, reasonable fixed protection from the elements must be provided.

Tas H103.3 Separation from other areas

A dining room must not have direct opening to living quarters, a laundry, bathroom or garage or a room where animals are housed.

Tas Part H104

* * * * *

This Part has been deliberately left blank.

Tas Part H105

* * * * *

This Part has been deliberately left blank.

Tas Part H106**Meat premises****Tas H106.1 Application of Part**

- (a) This Part is applicable to—
 - (i) meat premises processing animals, including game and poultry, and producing meat and meat products for human consumption; and
 - (ii) pet food works licensed under *Primary Produce Safety Act*.
- (b) Meat premises must be constructed in such a manner that—
 - (i) does not jeopardise animal welfare; and
 - (ii) provides for hygienic processing of animals; and
 - (iii) ensures the wholesomeness of meat and meat products.

Tas H106.2 Premises Processing Animals and Meat

Premises used for the processing of animals and meat for human consumption must comply with the relevant Parts and Sections of the Australian Standards listed below:

- (a) Hygienic Production and Transportation of Meat and Meat Products for Human Consumption, AS 4696 — Part 7, Sections 19 to 21.
- (b) Hygienic Production of Game Meat for Human Consumption, AS 4464 — Section 6 .
- (c) Construction of Premises and Hygienic Production of Poultry Meat for Human Consumption, AS 4465 — Part A, Sections 3 to 12.
- (d) Hygienic Production of Rabbit Meat for Human Consumption, AS 4466 — Section 5.
- (e) Hygienic Rendering of Animal Products, AS 5008 — Section 3.
- (f) Hygienic Production of Ratite (Emu/Ostrich) Meat for Human Consumption, AS 5010 — Section 5.
- (g) Hygienic Production of Natural Casings for Human Consumption, AS 5011 — Section 4.
- (h) Hygienic Production of Pet Meat, PISC – Technical Report 88 – Sections 6.1 – 6.7, 6.9 and 6.11.

Tas Part H107

Farm dairy premises

Tas H107.1 Application of this Part

This Part is applicable to every farm dairy as covered by the *Tasmanian Dairy Industry Act*.

Dairies must be constructed in such a manner that contamination of milk can be avoided.

Tas H107.2 Milking Sheds and Holding Yards

- (a) The walls (including the walls of the pit of a herringbone design milking shed) must be non absorbent and easy to clean.
- (b) The floor of a holding yard and a milking shed must be non absorbent, easy to clean and free-draining.
- (c) The lighting of a holding yard and a milking shed must be adequate for proper milking.
- (d) The working space in a milking shed is to be sufficient to minimise the risk of contamination of milk during milking.
- (e) Effluent from a holding yard and a milking shed is to be drained to a suitable point for disposal.
- (f) The requirements of (a), (b) and (c) are satisfied if—
 - (i) the walls are constructed of well-compacted smooth finish concrete or other material sealed to be impervious to moisture; and
 - (ii) the floors are constructed of well-compacted smooth finish concrete and graded to a drain; and
 - (iii) joints between wall sections and walls and floors are sealed to prevent entry of water and pests; and
 - (iv) artificial lighting is designed to comply with AS 1680.

Tas H107.3 Milk Receiving Area and Milk Storage Room

- (a) A Milk Receiving Area and Milk Storage Room must—
 - (i) have internal surfaces that are smooth, non-absorbent, free-draining and easy to clean; and
 - (ii) be constructed so as to prevent the entry of dust, insects, pests, birds and animals; and
 - (iii) have adequate artificial lighting that—
 - (A) is located to provide a clear view of the milk for grading and measuring purposes; and
 - (B) the lights over a bulk vat are to be protected to prevent glass entering the vat if the light is broken; and
 - (C) have switches appropriately located at the milk collection areas; and
 - (iv) have adequate ventilation to aid the drying of floors and walls between milkings.
- (b) The requirements of (a) are satisfied if—
 - (i) the floors are constructed of well-compacted smooth finish concrete and graded to a drain; and
 - (ii) the internal surfaces are smooth, sealed and washable; and
 - (iii) joints between wall sections and walls and floors are sealed to prevent entry of water and pests; and
 - (iv) artificial lighting is designed to comply with AS 1680; and
 - (v) all openings are fitted with doors, *windows* or screens; and
 - (vi) the milk is stored in a bulk storage tank which complies with AS 1187; and
 - (vii) ventilation is provided in accordance with [F4.5](#).

Tas H107.4 Water supply

An adequate and suitable supply of water must be available for plant sanitation, teat washing, milk cooling and vat rinsing.

Tas Part H108

Pharmacies

Tas H108.1 Application of Part

This Part applies to all pharmacy business premises registered under the *Pharmacy Control Act*.

Pharmacies must be able to be secured against entry and the interior must be able to be supervised by a pharmacist.

Tas H108.2 Definition

In this Part the following meaning applies—

Dispensary means the room or area within a pharmacy or other premises which a registered pharmaceutical chemist uses for the compounding or dispensing of prescriptions, medicines or drugs.

Tas H108.3 Pharmacy premises

(a) Each premises used as a pharmacy must have—

- (i) a *dispensary* for the compounding or dispensing of drugs and for the storage of material used in dispensing; and
- (ii) space for the storage of narcotic substances and poisons as *required* by the *Poisons Regulations*; and
- (iii) a place for unpacking containers or cases and goods; and
- (iv) a room for storing merchandise not used in dispensing.

(b) A pharmacy may have an area set aside for retailing merchandise that is not compounded or dispensed.

Tas H108.4 Dispensary

(a) A *dispensary* must be located—

- (i) within a pharmacy in a position to enable a person in the *dispensary* to supervise the *dispensary*, storage areas for narcotic substances and poisons, the entrances to unpacking areas and areas for storing other substances, and the retail area; and
- (ii) separate from any place where goods are unpacked or where general merchandise, not used in dispensing, is stored.

(b) Each *dispensary* must be provided with—

- (i) a sink and drainage board of impervious material moulded or manufactured in one piece; and
- (ii) a reticulated supply of hot and a cold water capable of providing to the sink adequate quantities of water for dispensing purposes; and
- (iii) space for a dispensing bench with a working area not less than 1.4 m².

Tas H108.5 Security of dispensary

(a) Every *dispensary* and enclosure set aside for the storage of narcotic substances and poisons must be able to be secured against entry.

(b) If a *dispensary* is located in a pharmacy that is capable of being secured against entry at all times while the *dispensary* is not in use, then the *dispensary* is deemed to be secured against entry.

Tas Part H109

Health service establishments

Tas H109.1 Application of Part

- (a) This Part applies to health service establishments as defined in the Health Service Establishment Act 2006 including—
- (i) a day procedure centre; or
 - (ii) a private hospital; or
 - (iii) a residential care service building.
- (b) Health service establishments must be able to be easily cleaned and must have adequate space for patients.

Tas H109.2 Design and construction of health service establishments

Every health service establishment must be constructed and maintained in accordance with the Health Service Establishments Code.

Tas Part H110

* * * * *

This Part has been deliberately left blank.

Tas Part H111

* * * * *

This Part has been deliberately left blank.

Tas Part H112**Mortuaries****Tas H112.1 Application of Part**

This Part applies to any premises used for the storage or preparation for burial, cremation or disposal by other means, of bodies of deceased persons.

Mortuaries must be constructed in a manner that will ensure the health of staff and the general public.

Tas H112.2 Layout of mortuary

- (a) A mortuary may be integral with the remainder of a building but must be separated physically from all public areas of that building.
- (b) Each mortuary at which bodies are prepared for burial, cremation or other disposal must be provided with a body preparation room—
 - (i) capable of being isolated from the remainder of the premises; and
 - (ii) having a *floor area* not less than 10 m².
- (c) A vehicle reception area or garage must be provided adjacent to and with direct access to the storage room or body preparation room to ensure that the transfer of uncoffined bodies is screened from public view.
- (d) Access to toilet and shower facilities from any other part of the mortuary premises must be only by way of an air lock.

Tas H112.3 Construction of body preparation room

- (a) The floor must be—
 - (i) of impervious material with a smooth, unbroken surface; and
 - (ii) uniformly graded to a floor drain.
- (b) All walls and partitions must be of concrete or masonry with a smooth, unbroken finish for ease of cleaning.
- (c) All joints between the floor, walls, partitions, ceiling, ventilation grilles, fittings, pipework, *windows* and light fittings must be sealed with impervious material for ease of cleaning.
- (d) All joints between the floor and walls or partitions must be coved for ease of cleaning.
- (e) The body preparation room must be provided with at least one washbasin, fitted with elbow or foot-operated taps, and an adequate supply of hot and cold water.
- (f) The body preparation room must be provided with refrigerated storage facilities—
 - (i) with sufficient capacity for the storage of at least two adult bodies; and
 - (ii) capable of maintaining an internal temperature between 1° and 5°C.

Tas H112.4 Water supply and sewerage

Each mortuary with a body preparation room must be connected to—

- (a) a permanent water supply with a physical discontinuity, provided by a registered break tank or reduced pressure zone device, between the water supply and all equipment, appliances, fittings and areas in the mortuary; and
- (b) a water carriage sewerage system.

Tas Part H113**Foundries****Tas H113.1 Application of Part**

This Part is applicable to every building or premises in which foundry operations are undertaken.

Foundries must provide for the comfort and safety of workers on the premises.

Tas H113.2 General

- (a) Every floor in a foundry must be level and, in places other than where molten metal is poured, must be composed of concrete or similar material or wooden blocks.
- (b) Every part of a foundry must be not less than 4.2 m high—
 - (i) where a ceiling is provided, measured from the floor to the ceiling; or
 - (ii) where a ceiling is not provided, measured from the floor to the lowest part of the roof.

Tas H113.3 Cupola charging platform

- (a) The floors of cupola charging platforms must be—
 - (i) of heavy timber or non-slip steel plate; and
 - (ii) securely fixed in position; and
 - (iii) level.
- (b) All parts of the cupola charging platform must be covered by a roof not less than 3 m above the platform.
- (c) A cupola charging platform must have—
 - (i) a wall, not less than 1 m high, measured from the floor of the platform, constructed to surround the platform; and
 - (ii) the sides between the top of the wall and the roof suitably waterproofed and ventilated.
- (d) A properly constructed access stair or ramp must be provided to give access to every cupola charging platform and must comply with AS 1657.

Tas H113.4 Deep moulds and pits

Deep moulds or pits, for permanent use—

- (a) must be lined with bricks, concrete, or other suitable material in such a manner as to provide adequate reinforcement and to keep the pit or mould in a dry condition; and
- (b) must be securely fenced by means of a wall of adequate construction, railings or chains and stanchions raised, in each case, to a height not less than 1 m above the surface of the surrounding floor.

Tas H113.5 Pot furnaces

Where pot furnaces are below ground level, the pit must be covered by a substantial grating at the point at which metal is removed from the furnace, and must at all other points be securely fenced as in [Tas H113.4\(b\)](#).

Tas Part H114

Premises for manufacture or processing of glass reinforced plastics

Tas H114.1 Application of Part

This Part is applicable to every building in which glass reinforced plastics are manufactured or processed.

Premises for manufacture or processing of glass reinforced plastic must—

- (a) provide for the safety and comfort of workers; and
- (b) be constructed in a manner that will avoid the spread of fire within the building and to other buildings.

Tas H114.2 Separation from other buildings

A building for manufacture or processing of glass fibre plastics must be—

- (a) separated from other buildings or parts of an occupancy by means of impervious walls with FRL at least 120/120/120; or
- (b) separated from all other buildings by a clear space of not less than 6 m.

Tas H114.3 Rise in storeys

The building must be of single *storey* construction.

Tas H114.4 Maximum floor areas

The *floor area* of any building or fire-separated section must not exceed the relevant maximum *floor area* set out in [Tas Table H114.4](#).

Tas Table H114.4 Maximum floor area (m²) of buildings for manufacture or processing of glass reinforced plastics or isocyanates

Type A building construction	Type B building construction	Type C building construction
Not Sprinklered: 1500 m ²	Not Sprinklered: 1200 m ²	Not Sprinklered: 1000 m ²
Sprinklered: 6000 m ²	Sprinklered: 5000 m ²	Sprinklered: 3000 m ²

Tas H114.5 Required exits

- (a) Each fire-separated section of a building which is a work place must have at least two *exits* for escape purposes and the number and location of the *exits* must be such that any point on the floor is not further than 20 m from one of the *exits*.
- (b) Only *exits* with vertically hinged swinging doors may be considered as *exits* for the purposes of this clause.

Tas H114.6 Hand laminating and spray depositing

The walls and floors of areas to be used for hand laminating and spray depositing must be constructed of *non-combustible* materials.

Tas H114.7 Ventilation

- (a) Mechanical or natural ventilation must be via low-level, exhaust ducting in a wall and a fixed, open, floor-level, fresh-air inlet ducting in the opposite wall such as to ensure a cross flow of the ventilation air over the complete working area.
- (b) Mechanical ventilation must provide not less than 6 air changes per hour.
- (c) The ventilation fan and exhaust ducting must be arranged in such a manner as to—
 - (i) produce a negative pressure within any exhaust ducting within the work place so that a leak in the ducting will not vent exhaust air back to the work place; and
 - (ii) vent the exhaust air to the atmosphere so as to prevent recirculation of that exhaust air.

Tas H114.8 Smoke and heat roof vents

Each fire-separated section must be provided with *automatic* smoke and heat roof vents.

Tas Part H115**Premises for production or processing of isocyanates****Tas H115.1 Application of Part**

This Part is applicable to every building in which isocyanate production or processing is undertaken.

Premises for the production or processing of isocyanates must—

- (a) provide for the safety and comfort of workers; and
- (b) be constructed in a manner that will avoid the spread of fire within the building and to other buildings.

Tas H115.2 Areas of work places

Work places in which an isocyanate industry is carried on must be divided into the following divisional areas:

- (a) Administration and staff amenities.
- (b) Workshop.
- (c) Bulk stores.
- (d) Curing room.
- (e) Processing plant.
- (f) Raw materials plant.
- (g) Manufacture.

Tas H115.3 Separation from other areas and buildings

- (a) Each of the divisional areas *required* by [Tas H115.2](#) other than the administration and staff amenities building, must be—
 - (i) separated from each of the other divisional areas by means of an impervious wall with an FRL not less than 120/120/120; or
 - (ii) separated from all other buildings by a clear space of not less than 6 m.
- (b) Notwithstanding the distance requirements of (a), bulk stores of polyols and bulk stores of isocyanates must comply with the requirements of the *Work Health and Safety Act*.

Tas H115.4 Rise in storeys

The building must be of single *storey* construction.

Tas H115.5 Maximum floor areas

The *floor area* of any building or fire-separated section must not exceed the area shown in [Tas Table H114.4](#).

Tas H115.6 Required exits

- (a) Every building or divisional area of a work place must have not less than 2 *exits* for escape purposes.
- (b) The number and location of the *exits* must be such that any point on the floor is not more than 20 m from one of the *exits*.
- (c) Only *exits* with vertically hinged swinging doors may be considered as *exits* for the purposes of this clause.

Tas H115.7 Bulk stores for polyols and isocyanates

- (a) A bulk store for polyols must be constructed from *non-combustible* materials and have a smooth impervious concrete floor and it must protect the polyols from direct exposure to the sun's radiation.
- (b) A bulk store for isocyanates must—
 - (i) be constructed from *non-combustible* materials, have a smooth impervious concrete floor, and must protect the isocyanate containers from direct exposure to the sun; and

Tasmania

- (ii) if it is used for storage of either TDI or HDI and is not an open sided building, be fitted with mechanical ventilation so that the TLV is not exceeded at any time provided that the ventilation must provide not less than 6 air changes per hour.
- (c) The area around both a polyol bulk store and an isocyanate bulk store must be bunded, the bund or bunds must ensure separation of the polyol and isocyanate areas and each bund must have a capacity of 10% more than the storage capacity of the largest tank it protects.

Tas H115.8 Curing room

The curing room for the storage of newly produced flexible polyurethane foam must be constructed of *non-combustible* materials with a smooth impervious concrete floor and fitted *automatic* fire vents in the roof.

Tas Part H116**Premises for electro-plating, electro-polishing, anodising or etching****Tas H116.1 Application of Part**

This Part is applicable to every building where any of the processes of electro-plating, electro-polishing, anodising or etching are undertaken.

Premises for electro-plating, electro-polishing, anodising or etching must—

- (a) provide for the safety and comfort of workers; and
- (b) be constructed in a manner that will prevent the escape of liquids and atmospheric contaminants to other areas of the building.

Tas H116.2 Floors

The floor of every plating area must be—

- (a) so graded as to—
 - (i) permit easy flushing with water; and
 - (ii) prevent liquids from flowing from the area into other parts of the work place; and
- (b) chemically resistant to the solutions used in the process.

Tas H116.3 Height of plating area

Every part of a plating area must be not less than 2.7 m in height—

- (a) measured from the floor to the ceiling if a ceiling is provided; or
- (b) measured from the floor to the lowest part of the roof if a ceiling is not provided.

Tas H116.4 Air space

In every plating area there must be not less than 14 m³ of air space for each person employed and, in the calculation of such space, the height taken into account must not exceed 4.2 m.

Tas H116.5 Ceiling construction

The ceiling of a plating area must be so constructed as to prevent, so far as is practicable, atmospheric contaminants from escaping into rooms or work places, situated above the level of the ceiling.

Tas Part H117**Premises for lead processing****Tas H117.1 Application of Part**

This Part is applicable to every building in which lead processes are used.

Premises for lead processing must—

- (a) provide for the safety and comfort of workers; and
- (b) be constructed in a manner that will minimise the lodgement of dust and must be capable of being flushed with water.

Tas H117.2 Floors

- (a) The floor of every work place where a lead process is used must be—
 - (i) so constructed of concrete or other suitable material as to be smooth and impervious to fluids; and
 - (ii) graded and properly drained to permit flushing with water.
- (b) The material of which the floor is constructed must be applied to the walls to a height of not less than 75 mm in such a fashion that the angle between the walls and the floor is coved for easy cleaning.

Tas H117.3 Height of lead processing areas

Every part of a lead processing area must be not less than 2.7 m in height—

- (a) where a ceiling is provided, measured from the floor to the ceiling; or
- (b) where a ceiling is not provided, measured from the floor to the lowest part of the roof.

Tas H117.4 Air space and floor space

- (a) In every lead processing area there must be not less than 14 m³ of air space for each person employed therein, and in the calculation of such space the maximum height taken must be not greater than 4.2 m; and
- (b) total floor space for the persons employed in such area, exclusive of space used for storage, must be not less than 3.3 m² for each person so employed.

Tas H117.5 Interior of lead processing areas

- (a) The inner surfaces of the walls of every lead processing area must be of a smooth material impervious to fluids and must not contain any projections on which dust may lodge; and
- (b) the interior construction of the ceiling or roof must, so far as is practicable, be such that dust will not settle on it.

Tas H117.6 Dust collection

Any areas in which dust-forming lead materials are manipulated, moved or treated must be served by a mechanical exhaust ventilation system capable of safely and effectively collecting all dust.

Tas H117.7 Isolation of certain processes

Where any process of pasting of electric accumulator plates or drying of paste plates, or melting down of pasted plates or of formation with tacking in the electric accumulator industry or of manipulation of dry oxide of lead, is to be carried on in the same room as any other lead process, the processes of pasting, drying, melting, formation or manipulation must be isolated from one another and from any other lead process—

- (a) by a partition extending from the floor to the ceiling in the case of a room having a ceiling not more than 3.6 m in height, or to a height of 2.7 m in any other case; or
- (b) by some other suitable method.

Tas H117.8 Drying room shelves

The racks or shelves provided in any drying room must not be more than 2.6 m from the floor nor more than 650 mm in width except that, in the case of racks or shelves set or drawn from both sides, the total width must not exceed 1.3 m.

Tas H117.9 Washing facilities

Washing facilities served with running hot and cold water for the use of all employees engaged in a lead process must be provided consisting of—

- (a) one washbasin for each 5 employees, or part thereof; and
- (b) one shower bath for each 8 employees, or part thereof.

Tas H117.10 Change rooms

In every work place in which lead is processed there must be provided two suitable furnished change rooms for the use of employees as follows—

- (a) one of the change rooms must be used for taking off, storing, and putting on of the street clothing of employees; and
- (b) the other of the change rooms must be used for the taking off, storing, and putting on of overalls and other clothing worn in any work room; and
- (c) each change room must be so constructed and situated as to prevent the entry into the room of dust or fumes generated in a workroom; and
- (d) each change room must be in close proximity to the washing facilities *required* in [Tas H117.9](#).

Tas Part H118

* * * * *

This Part has been deliberately left blank.

Tas Part H119

* * * * *

This Part has been deliberately left blank.

Tas Part H120

* * * * *

This Part has been deliberately left blank.

Tas Part H121

* * * * *

This Part has been deliberately left blank.

Tas Part H122

Early childhood centres and school age care facilities

Performance Requirements

Tas H122 P1

The design and construction of an *early childhood centre* and *school age care facility* must to the degree necessary, provide an environment that is spacious enough to prevent overcrowding, and supports a range of daily activities and routines including—

- (a) indoor playing; and
- (b) outdoor playing; and
- (c) sleeping.

Tas H122 P2

An *early childhood centre* and *school age care facility*, must to the degree necessary, have sufficient space and facilities to ensure a healthy, safe and comfortable environment for children, staff and parents including—

- (a) sanitary facilities; and
- (b) nappy changing facilities; and
- (c) laundry facilities; and
- (d) food preparation facilities; and
- (e) reception, administration and staff facilities; and
- (f) storage facilities; and
- (g) suitable—
 - (i) floor surfaces; and
 - (ii) lighting and ventilation; and
 - (iii) fire safety provisions; and
 - (iv) windows and glazing; and
 - (v) heating and cooling.

Tas H122 P3

An *early childhood centre* and *school age care facility* must to the degree necessary, have fencing around the perimeter of any outdoor play space, and any identified hazard isolated by fences, barriers and gates.

Application:

Tas H122 P1 to Tas H122 P3 apply to *early childhood centres* and *school age care facilities* approved under the *Education and Care Services National Law (Application) Act* or licensed under the *Child Care Act*.

Deemed-to-Satisfy Provisions

Tas H122.0 Application of Part

This Part applies to *early childhood centres* and *school age care facilities* approved under the *Education and Care Services National Law (Application) Act* or licensed under the *Child Care Act*.

Tas H122.1 Deemed-to-Satisfy Provisions

- (a) *Performance Requirements Tas H122 P1* is satisfied by complying with the relevant provisions of the Early Childhood Centre and School Age Care Facilities Code.
- (b) *Performance Requirement Tas H122 P2* is satisfied by complying with the relevant provisions of the Early Childhood

Tasmania

Centre and School Age Care Facilities Code.

- (c) *Performance Requirement Tas H122 P3* is satisfied by complying with the relevant provisions of the Early Childhood Centre and School Age Care Facilities Code.

Tas Part H123 Temporary structures**Performance Requirements****Tas H123 P1**

A *temporary structure* must, to the degree necessary, be capable of sustaining at an acceptable level of safety and serviceability the most adverse combination of loads and other actions to which it may reasonably be expected to be subjected.

Tas H123 P2

The material used in a *temporary structure* must, to the degree necessary, be capable of resisting the spread of fire to limit the generation of smoke and heat, and any toxic gases likely to be produced.

Tas H123 P3

- (a) Access must be provided to the degree necessary, to enable safe, equitable and dignified movement of people to and within a *temporary structure*.
- (b) So that people can move safely to and within a *temporary structure*, it must have—
 - (i) walking surfaces with safe gradients; and
 - (ii) stairways and ramps with slip-resistant walking surfaces; and
 - (iii) suitable handrails where necessary to assist and provide stability to people using a stairway or ramp.
- (c) Access for people with disabilities must be provided to and within a *temporary structure*, including to any public sanitary facilities and all areas normally used by the *public*.
- (d) If fixed seating is provided in a *temporary structure*, an appropriate number of wheelchair spaces must be provided.

Tas H123 P4

- (a) *Exits* must be provided to the degree necessary, from a *temporary structure* to enable the safe evacuation of occupants, with their number, location and dimensions being appropriate to the—
 - (i) travel distances to *exits*; and
 - (ii) number, mobility and other characteristics of the occupants; and
 - (iii) function or use of the structure.
- (b) So that occupants can safely evacuate a *temporary structure*, paths of travel to *exits* must have dimensions appropriate to the—
 - (i) number, mobility and other characteristics of the occupants; and
 - (ii) function or use of the structure.

Tas H123 P5

Where a person could fall 1 m or more, due to a sudden change of level within or associated with a *temporary structure*, a barrier must to the degree necessary, be provided which must be—

- (a) continuous and extend for the full extent of the hazard; and
- (b) of a height to protect the people from accidentally falling from the level; and
- (c) constructed to prevent the people from falling through the barrier; and
- (d) capable of restricting the passage of children; and
- (e) of strength and rigidity to withstand the foreseeable impact of the people and where appropriate, the static pressure of the people pressing against it.

Tas H123 P6

A level of illumination for safe evacuation from a *temporary structure* in an emergency must be provided, to the degree necessary, appropriate to the—

- (a) function or use of the structure; and
- (b) size of the structure; and
- (c) distance of travel to an *exit*.

Tas H123 P7

To facilitate evacuation from a *temporary structure* suitable signs or other means of identification must, to the degree necessary—

- (a) be provided to identify the location of *exits*; and
- (b) guide the occupants to *exits*; and
- (c) be clearly visible to the occupants; and
- (d) operate in the event of power failure for sufficient time for the occupants to safely evacuate.

Tas H123 P8

Fire equipment must be installed in a *temporary structure* to the degree necessary, to allow the occupants to undertake initial attack on a fire appropriate to the—

- (a) function or use of the structure; and
- (b) fire hazard.

Tas H123 P9

Sanitary facilities for personal hygiene must be provided in a convenient location associated with a *temporary structure*, to the degree necessary, appropriate to the—

- (a) function or use of the structure; and
- (b) number and gender of the occupants; and
- (c) disability or other particular needs of the occupants.

Tas H123 P10

A *temporary structure* must be provided with natural or artificial lighting to enable the safe use and movement of people using the structure. Lighting must be installed to the degree necessary, to provide a level of illumination appropriate to the function or use of a *temporary structure* to enable safe use and movement by the occupants.

Tas H123 P11

A *temporary structure* must be provided with a means of ventilation which will maintain adequate air quality. Ventilation must be provided to the degree necessary, to a level appropriate to the function or use of a *temporary structure*.

Tas H123 P12

Electrical services must be installed to the degree necessary, to provide a level of safety appropriate to the environment and function or use of a *temporary structure* by the occupants.

Tas H123 P13

Where provided in a *temporary structure*, a heating appliance and its associated components must be installed to the degree necessary—

- (a) to withstand the temperatures likely to be generated by the appliance; and
- (b) so that it does not raise the temperature of any structural element to a level that would adversely affect the element's physical or mechanical properties or function; and

- (c) so that hot products of combustion will not—
 - (i) escape through the walls of the associated components; and
 - (ii) discharge to a position that will cause fire to spread to nearby combustible materials or allow smoke to penetrate the *temporary structure*; and
- (d) to reduce the likelihood of fire and harmful emissions spreading beyond the appliance.

Tas H123 P14

A *temporary structure* of tiered seating must be designed and constructed to the degree necessary, to provide for the safety of the occupants and orderly means of evacuation in an emergency.

Tas H123 P15

A *temporary structure* must, to the degree necessary, be a safe and hazard free environment for the people using the structure.

Application:

Tas H123 P1 to P15 only applies to a *temporary structure* that—

- (a) is used by the *public* as a place of assembly as described in the *Public Health Act*; and
- (b) is a *temporary structure* as described in the *Building Act*.

Deemed-to-Satisfy Provisions

Tas H123.0 Application of Part

This Part only applies to a *temporary structure* that—

- (a) is used by the *public* as a place of assembly as described in the *Public Health Act*; and
- (b) is a *temporary structure* as described in the *Building Act*.

Tas H123.1 Deemed-to-Satisfy Provisions

Performance Requirements Tas H123 P1 to Tas H123 P14 are satisfied by complying with the provisions of the ABCB Temporary Structures Standard, except for the following:

- (a) Disability access requirements, which are included in Tas H123.4.
- (b) Lighting requirements, which are included in Tas H123.11.
- (c) Ventilation requirements, which are included in Tas H123.12.
- (d) Electrical requirements, which are included in Tas H123.13.
- (e) Heating appliance requirements, which are included in Tas H123.14.

Tas H123.2 * * * * *

Tas H123.3 * * * * *

Tas H123.4 Access

- (a) Access for people with disabilities must be provided to and within a *temporary structure* by means of a continuous path of travel.
- (b) Access for people with disabilities must be provided to—
 - (i) any public sanitary facilities; and
 - (ii) all areas normally used by the *public* but excluding those areas only used by persons working in the *temporary structure*.
- (c) If fixed seating is provided, in a *temporary structure*, wheelchair spaces must be provided not less than—
 - (i) 1 wheelchair space for up to 100 seats; and

- (ii) 2 wheelchair spaces for 100 - 200 seats; and
 - (iii) an additional wheelchair space for each additional 200 seats or part thereof.
- (d) Parts of the *temporary structure* required to be accessible must comply with AS 1428.1.

Tas H123.5 * * * * ***Tas H123.6 * * * * *****Tas H123.7 * * * * *****Tas H123.8 * * * * *****Tas H123.9 * * * * *****Tas H123.10 * * * * *****Tas H123.11 Lighting**

- (a) Natural or artificial lighting must be provided to all enclosed areas in a *temporary structure*.
- (b) Natural lighting must as far as practicable be not less than 10% of the floor area of the enclosed area.
- (c) The artificial lighting system must as far as practicable comply with the relevant provisions of AS 1680 Parts 1, 2.0, 2.1, 2.2 and 2.3.

Tas H123.12 Ventilation

- (a) Natural ventilation or mechanical ventilation must be provided to all enclosed areas in a *temporary structure*.
- (b) Natural ventilation must as far as is practicable consist of openings or devices which can be opened with an aggregate opening of not less than 5% of the floor area of the enclosed area.
- (c) Mechanical ventilation must as far as practicable comply with the relevant provisions of AS 1668.2.

Tas H123.13 Electrical

All electrical installations in a *temporary structure* must be installed in accordance with AS/NZS 3000.

Tas H123.14 Heating appliances

The installation of a stove, heater or similar appliance in a *temporary structure* must as far as practicable comply with the following standards:

- (a) Domestic oil-fired appliances – Installation: AS 1691.
- (b) Domestic solid-fuel burning appliances – Installation: AS/NZS 2918.
- (c) L P gas portable mobile appliances: AS 2658.

Tas H123.15 * * * * *

Tas Part H124

Premises where work is undertaken on gas-fuelled vehicles

Tas H124.1 Application of Part

This Part is applicable to every building where work is undertaken on gas-fuelled vehicles.

Tas H124.2 Working areas

The working area of a building where work is undertaken on a gas-fuelled vehicle is to be designed and constructed to comply with the requirement for premises in AS 2746 Working areas for gas-fuelled vehicles.

Schedule 3 Definitions

Tas Schedule 3 Definitions

Insert definition for *centre-based care class 4 facility* as follows:

Centre-based care class 4 facility is a facility as defined in Centre Based Care Class 4 Standards.

Insert definition for *centre-based care class 5 facility* as follows:

Centre-based care class 5 facility is a facility as defined in Centre Based Care Class 5 Standards.

Vary the definition for *early childhood centre* as follows:

Early childhood centre means any premises or part thereof providing or intending to provide a centre-based education and care service within the meaning of the Education and Care Services National Law Act 2010 (Vic), the Education and Care Services National Regulations and centre-based services that are licensed or approved under State and Territory children's services law, but excludes—

- (a) education and care primarily provided to school aged children in outside school hours settings; and
- (b) services licensed as *centre-based care class 4* under the Child Care Act.

Insert definition for *public* as follows:

Public includes any person working in an enclosed public place.

Insert definition for *Registered Testing Authority* as follows:

Registered Testing Authority means—

- (a) an organisation registered by the National Association of Testing Authorities (NATA) to test in the relevant field; or
- (b) an organisation outside Australia registered by an authority recognised by NATA through a mutual recognition agreement.

Insert definition for *School age care facility* as follows:

School age care facility is a facility providing care for children (primarily) 5 years or older in an outside of school hours setting, either approved or licenced under Education and Care Services National Law (Application) Act or the Child Care Act.

Insert definition for *temporary structure* as follows:

Temporary structure includes any—

- (a) booth, tent or other temporary enclosure, whether or not part of the booth, tent or enclosure is permanent; or
- (b) temporary seating structure; or
- (c) other structure prescribed under the *Building Act*.

Schedule 4 Referenced documents

Tas Schedule 4 Referenced documents

All legislation referenced in this Appendix is Tasmanian State legislation unless noted otherwise.

All referenced documents including legislation, codes, Australian Standards, guidelines and codes of practice are the version current at the time of project documentation approval, unless noted otherwise.

Insert in Table 1 of [Schedule 4](#) as follows:

Tas Table 1 Schedule of referenced documents

No.	Title	Volume One
AS 1187	Farm milk cooling and storage systems	Tas H107.3
AS 1657	Fixed platforms, walkways, stairways and ladders — Design, construction and installation	Tas H113.3
AS/NZS 1668 Part 1	The use of ventilation and air-conditioning in buildings: Fire and smoke control in multi-compartment buildings	Tas H102.6
AS 1668 Part 2	The use of ventilation and air-conditioning in buildings: Mechanical ventilation in buildings	Tas H102.6 , Tas H123.12
AS/NZS 1680 Part 1	Interior lighting: General principles and recommendations	Tas H102.7
AS/NZS 1680 Part 2.1	Interior lighting: Circulation spaces and other general areas	Tas H102.7
AS/NZS 1680 Part 2.2	Interior lighting: Office and screen based tasks	Tas H102.7
AS/NZS 1680 Part 2.3	Interior lighting: Education and training facilities	Tas H102.7
AS/NZS 1680 Part 2.4	Interior lighting: Industrial tasks and processes Amdt 1	Tas H102.7
AS/NZS 1680 Part 2.5	Interior lighting: Hospitals and medical tasks	Tas H102.7
AS 2658	LP Gas - Portable and mobile appliances	Tas H123.14
AS 2746	Working areas for gas fuelled vehicles	Tas H124.2
AS/NZS 3000	Electrical installations (known as the Australian / New Zealand Wiring Rules)	Tas H123.13
AS 4464	Hygienic production of game meat for human consumption	Tas H106.2
AS 4465	Construction of premises and hygienic production of poultry meat for human consumption	Tas H106.2
AS 4466	Hygienic production of rabbit meat for human consumption	Tas H106.2
AS 4674	Design, construction and fit-out of food premises (Clauses 4.2 and 4.3)	Tas H102.12
AS 4696	Hygienic production and transportation of meat and meat products for human consumption	Tas H106.2
AS 5008	Hygienic rendering of animal products	Tas H106.2

Tasmania

No.	Title	Volume One
AS 5010	Hygienic production of ratite (emu/ostrich) meat for human consumption	Tas H106.2
AS 5011	Hygienic production of natural casings for human consumption	Tas H106.2
ABCB	Temporary Structures Standard	Tas H123.1
Centre Based Care Class 4 Standards	Tasmanian Licencing Standards for Centre Based Child Care Class 4	Tas Schedule 3
Centre Based Care Class 5 Standards	Tasmanian Licencing Standards for Centre Based Child Care Class 5 (0-12 years)	Tas Schedule 3
Child Care Act (Tas)	N/A	Tas Schedule 3, Tas H122.0
Dairy Industry Act	N/A	Tas H102
Disability (Access to Premises – Buildings) Standards (Cwth)	N/A	Tas D3.13
Disability Discrimination Act (Cwth)	N/A	Tas DP10
Early Childhood Centre and School Age Care Facilities Code	N/A	Tas H122.0, Tas H122.1
Education and Care Services National Law (Application) Act	N/A	Tas Schedule 3, Tas H122.0
Export Control (Milk and Dairy) Orders	N/A	Tas H102.16
Health Service Establishments Act	N/A	Tas H109.1
Health Service Establishments Code	N/A	Tas H109.2
Hygienic Production of Pet Meat	Technical Report 88	Tas H106.2
Liquor and Accommodation Act	N/A	Tas H102 P12, Tas H102.0
Water and Sewerage Industry Act	N/A	Tas H102.2
Primary Produce Safety Act	N/A	Tas H102
N/A	Condensation in Buildings Tasmanian Designers' Guide - Version 2	Tas FP6.1

Footnote: Other legislation affecting buildings

In addition to any applicable provisions of the Building Act and other legislative and regulatory instruments under that Act, such as regulations, determinations, guidelines, codes and standards there are a number of other legislative technical requirements, and regulatory instruments affecting the design, construction and/or performance of buildings that practitioners may need to be aware of, including but not limited to, the following list. Additional legislative and regulatory instruments such as regulations, codes and standards may exist under the legislation and regulatory instruments listed.

1. Work Places

Administering agency

WorkSafe Tasmania – Department of Justice

Relevant Tasmanian legislation and regulatory instruments

Work Health and Safety Act

Code of Practice – Managing Risks of Hazardous Chemicals in the Workplace – WorkSafe Tasmania publication CP120

Code of Practice – Managing the Work Environment and Facilities – WorkSafe Tasmania publication CP124

Code of Practice – Safe Design of Structures – WorkSafe Tasmania publication CP128

Victoria

Introduction

Section B **Structure**

Section C **Fire resistance**

Section D **Access and egress**

Section E **Services and equipment**

Section F **Health and amenity**

Section G **Ancillary provisions**

Section H **Special use buildings**

Schedule 3 **Definitions**

Schedule 4 **Referenced documents**

Footnote: **Other legislation affecting buildings**

Victoria

Introduction

Section B Structure

Vic B1.6 Construction of buildings in flood hazard areas

Section C Fire resistance

Vic C1.10 Fire hazard properties

Section D Access and egress

Vic D1.4 Exit travel distances

Vic D1.6 Dimensions of exits and paths of travel to exits

Vic D2.21 Operation of latch

Section E Services and equipment

Vic Specification E1.5 Fire sprinkler systems

Vic Specification E1.5a Class 2 and 3 buildings not more than 25 m in effective height
2. System requirements

Vic Specification E2.2a Smoke detection and alarm systems

Section F Health and amenity

Performance Requirements

Deemed-to-Satisfy Provisions

Vic F2.0 Deemed-to-Satisfy Provisions

Vic F2.3 Facilities in Class 3 to 9 buildings

Vic F2.5 Construction of sanitary compartments

Vic F2.101 First aid rooms

Performance Requirements

Vic FP3.1 Habitable room or space sufficient size

Verification methods

Vic FV3.1

Deemed-to-Satisfy Provisions

Vic F3.0 Deemed-to-Satisfy Provisions

Vic F3.101 Children's services — size of rooms

Vic F3.102 Class 3 buildings — size of rooms

Vic F3.103 Class 3, 9a and 9c residential aged care buildings — size of rooms

Vic F4.1 Provision of natural light

Vic F4.2 Methods and extent of natural lighting

Section G Ancillary provisions

Performance Requirements

Vic GP1.2 Swimming pool access and water recirculation systems

Deemed-to-Satisfy Provisions

Vic G1.1 Swimming pools

Section H Special use buildings

Performance Requirements

Vic HP101.1

Vic HP101.2

Vic HP101.3

Deemed-to-Satisfy Provisions

Vic H101.0 Deemed-to-Satisfy Provisions
Vic H101.1 Application of Part
Vic H101.2 Doorway width
Vic H101.3 Windows
Vic H101.4 Grab rails
Vic H101.5 Heated water temperature
Vic H101.6 Electronic communications system
Vic H101.7 Electrical power outlets

Performance Requirements

Vic HP102.1
Vic HP102.2
Vic HP102.3

Deemed-to-Satisfy Provisions

Vic H102.0 Deemed-to-Satisfy Provisions
Vic H102.1 Application of Part
Vic H102.2 Temporary tiered seating, concourses and embankments
Vic H102.3 Motor vehicle racing
Vic H102.4 Sanitary and amenity facilities
Vic H103.1 Fire safety in Class 2 and Class 3 buildings

Performance Requirements

Vic HP104.1

Deemed-to-Satisfy Provisions

Vic H104.0 Deemed-to-Satisfy Provisions
Vic H104.1 Application of Part
Vic H104.2 Doorways to a children's room

Schedule 3 Definitions

Vic Schedule 3 Definitions

Schedule 4 Referenced documents

VIC Schedule 4 Referenced documents

Footnote: Other legislation affecting buildings

1. Abattoirs and Knackeries
2. Accommodation – Residential (Boarding Houses, Guest Houses, Hostels, Motels)
3. Accommodation — Supported Residential Services
4. Alpine Resorts
5. Asbestos Removal
6. Children's Services
7. Crematoria, Mausolea, Vaults, etc.
8. Crown Land
9. Dairies
10. Dangerous Goods
11. Electrical Installations
12. Fences - dividing
13. Fire Prevention in Existing Buildings
14. Food Premises
15. Gas Installations
16. Historic Buildings
17. Hospitals, Nursing Homes and Health Care Buildings
18. Lift Installations
19. Moveable Dwellings (in Caravan Parks)
20. Occupational Health and Safety
21. Pharmacies
22. Planning Controls

- 23. Prisons and Jails
- 24. Radiation Safety
- 25. Schools (Non-Government)
- 26. Sanitary Plumbing, Water Supply and Sewerage
- 27. Septic Tank Installations
- 28. Smoking Restrictions
- 29. Subdivision of Buildings

Introduction

This Appendix contains variations and additions to the Building Code of Australia (BCA) provisions which are considered necessary for the effective application of the Code in Victoria and shall be treated as amendments to the Code.

Section B Structure

Part B1 Structural provisions

Substitute B1.6 as follows:

Vic B1.6 Construction of buildings in flood hazard areas

- (a) A Class 2 or 3 building, Class 9a *health-care building*, Class 9c building or Class 4 part of a building, in a *flood hazard area* must comply with the ABCB Standard for Construction of Buildings in Flood Hazard Areas.
- (b) The definitions of *flood hazard area* and *freeboard* in the ABCB Standard for Construction of Buildings in Flood Hazard Areas are replaced with those in [Vic Schedule 3](#).
- (c) The definition of *defined flood level* in the ABCB Standard for Construction of Buildings in Flood Hazard Areas is replaced with that in [Schedule 3](#).

Section C Fire resistance

Part C1 Fire Resistance and Stability

Delete C1.10(c)(xv) as follows:

Vic C1.10 Fire hazard properties

- (c) The requirements of (a) do not apply to a material or assembly if it is—
(xv) * * * * *

Section D Access and egress

Part D1 Provision for escape

Substitute the lead-in to D1.4(d) as follows:

Vic D1.4 Exit travel distances

(d) **Class 9 buildings** — in a *patient care area* in a Class 9a building and in a *children's service*—

Delete D1.6(f)(iv) as follows:

Vic D1.6 Dimensions of exits and paths of travel to exits

(f)

(iv) (Deleted)

Part D2 Construction of exits

Substitute D2.21 (a) as follows:

Vic D2.21 Operation of latch

- (a) A door in a *required exit*, forming part of a *required exit* or in the path of travel to a *required exit* must be readily openable without a key from the side that faces a person seeking egress, by—
- (i) a single hand downward action on a single device which is located between 900 mm and 1.1 m from the floor and if serving an area *required* to be *accessible* by [Part D3](#)—
 - (A) be such that the hand of a person who cannot grip will not slip from the handle during the operation of the latch; and
 - (B) have a clearance between the handle and the back plate or door face at the centre grip section of the handle of not less than 35 mm and not more than 45 mm; or
 - (ii) a single hand pushing action on a single device which is located between 900 mm and 1.2 m from the floor; and
 - (iii) where the latch operation device referred to in (ii) is not located on the door leaf itself—
 - (A) manual controls to power-operated doors must be at least 25 mm wide, proud of the surrounding surface and located—
 - (aa) no closer than 500 mm from an internal corner; and
 - (bb) for a hinged door, between 1 m and 2 m from the door leaf in any position; and
 - (cc) for a sliding door, within 2 m of the doorway and clear of a surface mounted door in the open position; and
 - (B) braille and tactile signage complying with [Clause 3](#) and [6](#) of [Specification D3.6](#) must identify the latch operation device,

except that an exit door from a *children's service* which does not open to an outdoor space enclosed in accordance with [G1.3](#), must have the device located between 1.5 m and 1.65 m above the floor and the door must be *self-closing*.

Section E Services and equipment

Part E1 Fire fighting equipment

Delete references to Class 3 building used as a *residential care building* and Class 9a *health-care building* used as a *residential care building*. Add references to *residential care building (Vic)* and *shared accommodation building* in Table E1.5 and substitute Note 4 of Table E1.5 as follows:

Vic Table E1.5 Requirements for sprinklers

Occupancy	Where sprinklers are required
<i>Residential care building (Vic)</i>	Throughout the building.
<i>Shared accommodation building</i>	Throughout the building.

Notes to Vic Table E1.5:

4. For the purposes of this Table, occupancies of excessive *fire hazard* comprise buildings which contain—
 - a. hazardous process risks including the following:
 - i. Aircraft hangars.
 - ii. Electrical/electronic manufacturing and assembly (predominantly plastic components).
 - iii. Fire-lighter manufacturing.
 - iv. Fireworks manufacturing.
 - v. Flammable liquid spraying.
 - vi. Foam plastic goods manufacturing and/or processing.
 - vii. Foam rubber goods manufacturing and/or processing.
 - viii. Hydrocarbon based sheet product manufacturing and/or processing.
 - ix. Nitrocellulose and nitrocellulose goods manufacturing.
 - x. Paint and varnish works, solvent based.
 - xi. Plastic goods manufacturing and/or processing works.
 - xii. Resin and turpentine manufacturing.
 - xiii. Vehicle repair shops.
 - b. combustible goods with an aggregate volume exceeding 2000 m³ and stored to a height greater than 4 m such as the following:
 - i. Aerosol packs with flammable contents.
 - ii. Cartons and associated packing material excluding cartons with densely packed non-combustible content.
 - iii. Electrical appliances where the components are predominantly plastic.
 - iv. Foamed rubber or plastics including wrappings or preformed containers.
 - v. Paper products.
 - vi. Plastic, rubber, vinyl and other sheets in the form of offcuts, random pieces or rolls.
 - vii. Textiles raw and finished.
 - viii. Timber products.

Substitute Clause 2 of Specification E1.5 as follows:

Vic Specification E1.5 Fire sprinkler systems

2. Application of automatic fire sprinkler standards

Subject to this Specification, an *automatic* fire sprinkler system must comply with—

- (a) for a Class 5, 6, 7, 8 or 9b building: AS 2118.1; or
- (b) for a Class 2, 3, 4, 9a or 9c building: AS 2118.1, except clause 5.9.10 of AS 2118.1 does not apply and is replaced with 'Covered balconies shall be sprinkler protected.'; or

- (c) for a Class 2 or 3 building with an *effective height* of not more than 25 m and a *rise in storeys* of 4 or more: [Specification E1.5a](#) and the relevant provisions of this Specification as applicable; or
- (d) for Class 4, 5, 6, 7, 8, 9a (other than a *residential care building (Vic)*) or 9b parts of a building less than 25 m in *effective height*, which also contains Class 2 or 3 parts: a sprinkler system in accordance with [Specification E1.5a](#) as for a Class 2 or 3 building and the relevant provisions of this Specification except—
 - (i) a FPAA101D sprinkler system cannot be used where the Class 4, 5, 6, 7, 8, 9a (other than a *residential care building (Vic)*) or 9b parts—
 - (A) contain more than 2 *storeys*;
 - (B) are more than 25% of the total floor area of the building;
 - (C) are located above the fourth storey; and
 - (ii) an FPAA101D or FPAA101H sprinkler system cannot be used where the Class 7a part (other than an open deck carpark) accommodates more than 40 vehicles; or
- (e) for a Class 2 or 3 building with a *rise in storeys* of not more than 3: AS 2118.4 as applicable; or
- (f) for a combined sprinkler and fire hydrant system: AS 2118.6; or
- (g) for a Class 9a *health-care building* used as a *residential care building (Vic)*: AS 2118.4 as applicable; or
- (h) for a Class 9c building: AS 2118.4 as applicable.

Substitute Clause 2(a) of Specification E1.5a as follows:

Vic Specification E1.5a Class 2 and 3 buildings not more than 25 m in effective height

2. System requirements

- (a) A *required automatic* fire sprinkler system installed in a Class 2 or 3 building with an *effective height* of not more than 25 m and a *rise in storeys* of 4 or more must comply with—
 - (i) AS 2118.1 except clause 5.9.10 of AS 2118.1 does not apply and is replaced with ‘Covered balconies shall be sprinkler protected’; or
 - (ii) AS 2118.4, as applicable; or
 - (iii) FPAA101D—
 - (A) except for *residential care buildings (Vic)*; and
 - (B) except that clause 2.2.1 of FPAA101D applies as if the first paragraph is replaced with ‘Covered balconies shall be sprinkler protected’; or
 - (iv) FPAA101H—
 - (A) except for *residential care buildings (Vic)*; and
 - (B) except that clause 3.5.2.8 of FPAA101H applies as if the first paragraph is replaced with ‘Covered balconies shall be sprinkler protected’; and
 - (C) except that clause 3.5.3 of FPAA101H applies as if it is replaced with—

“3.5.3 Class 5, 6, 7, 8 and 9 parts of the building

The location and spacing of sprinklers in Class 5, 6, 7, 8 and 9b parts of the building shall be in accordance with Section 5 of AS 2118.1:2017.

The location and spacing of sprinklers in Class 9a and 9c parts of the building shall be in accordance with Section 5 of AS 2118.1:2017 except that clause 5.9.10 of AS 2118.1 does not apply and is replaced with ‘Covered balconies shall be sprinkler protected’.”.

Substitute Clause 4(d) of Specification E2.2a as follows:

Vic Specification E2.2a Smoke detection and alarm systems

4. Smoke detection system

- (d) In a Class 9c building—
 - (i) if the building accommodates more than 20 residents, manual call points must be installed in paths of

- travel so that no point on a floor is more than 30 m from a manual call point; and
- (ii) indication of the zone where the smoke detection system has actuated must be achieved by one of the following:
 - (A) (aa) remote automatic indication of each zone must be given in each smoke compartment; and
 - (bb) indication of (aa) must be indicated on remote annunciator panels with alpha-numeric displays with a minimum of 20 characters of 9 mm minimum height; or
 - (B) (aa) indication of the zone where the smoke detection system has actuated must be communicated via a suitable interface with the fire indicator panel to a portable remote communication device; and
 - (bb) at least one such portable remote communication device per smoke compartment must be provided to staff nominated by the owner or operator and properly instructed as to the duties and responsibilities involved; and
 - (cc) the portable remote communication device may be a pager with alpha-numeric display or portable telephone handset with capability of receiving alpha-numeric display.

Substitute Clause 8(b) and (c) of Specification E2.2a as follows:

8. System monitoring

- (b) A smoke detection system in a Class 9a *health-care building*, if the building accommodates more than 20 patients, unless the building is sprinklered and the sprinkler system is permanently connected to a fire station, or other approved monitoring service with a direct data link to a fire station, in accordance with Practice Note 07-2018.
- (c) (deleted).

Section F Health and amenity

Part F2 Sanitary and other facilities

Substitute application of *Performance Requirement* FP2.2 as follows:

Performance Requirements

Application:

FP2.2 only applies to—

- (a) a Class 2 building or a Class 4 part of a building; and
- (b) a Class 9a *health-care building*; and
- (c) a Class 9c building; and
- (d) an *early childhood centre* other than a *restricted children's service*.

Substitute Vic F2.0 as follows:

Deemed-to-Satisfy Provisions

Vic F2.0 Deemed-to-Satisfy Provisions

Performance Requirements FP2.1 to FP2.6 are satisfied by complying with F2.1 to F2.9 and Vic F2.101.

Substitute F2.3(h) as follows:

Vic F2.3 Facilities in Class 3 to 9 buildings

- (h) A Class 9b *early childhood centre*, other than a *children's service*, must be provided with—
 - (i) a kitchen or food preparation area with a kitchen sink, separate hand washing facilities, space for a refrigerator and space for cooking facilities, with—
 - (A) the facilities protected by a door or gate with child proof latches to prevent unsupervised access to the facilities by children younger than 5 years old; and
 - (B) the ability to facilitate supervision of children from the facilities if the *early childhood centre* accommodates children younger than 2 years old; and
 - (ii) one bath, shower or shower-bath; and
 - (iii) if the centre accommodates children younger than 3 years old—
 - (A) a laundry facility comprising a washtub and space in the same room for a washing machine; and
 - (B) a bench type baby bath, which is within 1 m of the nappy change bench; and
 - (C) a nappy changing bench which—
 - (aa) is within 1 m of separate adult hand washing facilities and bench type baby bath; and
 - (bb) must be not less than 0.9 m² in area and at a height of not less than 850 mm, but not more than 900 mm above the finished floor level; and
 - (cc) must have a space not less than 800 mm high, 500 mm wide and 800 mm deep for the storage of steps; and
 - (dd) is positioned to permit a staff member changing a nappy to have visibility of the play area at all times.
- (ha) A *children's service* must be provided with—
 - (i) a kitchen or facilities for the preparation and cooking of food for children including washing up facilities and a space for refrigerated food storage facilities; and
 - (ii) except in a *restricted children's service*, if the service accommodates children younger than 3 years of age—

Victoria

- (A) a laundry facility comprising a washtub and space in the same room for a washing machine; and
 - (B) a bench-type baby bath, with hot and cold water connected, and a nappy change bench in close proximity; and
- (iii) except in a *restricted children's service*, one bath or shower-bath.

Vary Table F2.3 as follows:

Vic Table F2.3 Sanitary Facilities in Class 3, 5, 6, 7, 8 and 9 Buildings

User Group	Closet Pans		Urinals		Washbasins	
	Design Occupancy	Number	Design Occupancy	Number	Design Occupancy	Number
Class 9b — <i>early childhood centre</i>						
Children	1 — 30	2			1 — 30	2
	> 30	Add 1 per 15			>30	Add 1 per 15

Note to Vic Table F2.3: Facilities for use by children must be—

- (a) junior closet pans, except that those in a *restricted children's service* may be adult height toilets if they are fitted with a removable seat suitable for children and a wide and stable step in front; and
- (b) washbasins with a rim height not exceeding 600 mm, except that those in a *restricted children's service* may be adult height washbasins if they are provided with a wide and stable step in front; and
- (c) except in a *children's service*, accessible from both indoor and outdoor play areas; and
- (d) in a *children's service*, other than a *restricted children's service*, the closet pans must be located in relation to children's rooms and outdoor play spaces so that children using toilets can be observed by staff from children's rooms and outdoor play space.

Substitute Vic F2.5(c) as follows:

Vic F2.5 Construction of sanitary compartments

- (c) In an *early childhood centre*, other than a *restricted children's service*, closet pans situated in a group for use by children must be separated from one another by means of a partition, which, except for the doorway, is opaque for a height of not less than 900 mm but not more than 1200 mm above the floor.

Add Vic F2.101 as follows:

Vic F2.101 First aid rooms

- (a) If an *assembly building*, place of public entertainment (as defined in the Building Act 1993) or an *open spectator stand* accommodates more than 5000 spectators at an arena, sportsground, showground, racecourse, cricket ground, football ground, coursing ground, motor racing arena, or the like, a suitable room or rooms must be provided in accordance with [Table F2.101](#) for use by para-medical attendants for first aid purposes.

Table F2.101 First aid rooms

Spectator capacity	Number of first aid rooms
5001–10 000 spectators	1 first aid room
10 001–15 000 spectators	2 first aid rooms
15 001–30 000 spectators	3 first aid rooms
each extra 15 000 spectators or part thereof	1 first aid room

- (b) **Conditions:** First aid rooms *required* by (a) must—
 - (i) be distributed as uniformly as possible throughout the *assembly building* or *open spectator stand*; and
 - (ii) be convenient to a public road; and
 - (iii) be readily accessible from within and outside the arena or ground; and
 - (iv) have a *floor area* of not less than 24 m²; and
 - (v) be provided with a suitable wash basin or sink.

Part F3 Room sizes

Substitute FP3.1 as follows:

Performance Requirements

Vic FP3.1 Habitable room or space sufficient size

A *habitable room* or space must have sufficient size to enable the room or space to fulfil its intended use.

Substitute FV3.1(a) as follows:

Verification methods

Vic FV3.1

- (a) Compliance with [FP3.1](#) is verified in relation to the height of a *habitable room* or space where the height of a *habitable room* or space provides an appropriate *activity support level* that does not unduly interfere with its intended function.

Substitute F3.0 as follows:

Deemed-to-Satisfy Provisions

Vic F3.0 Deemed-to-Satisfy Provisions

Performance Requirement Vic FP3.1 is satisfied by complying with [F3.1](#) and [Vic F3.101](#) to [Vic F3.103](#).

Add Vic F3.101 as follows:

Vic F3.101 Children's services — size of rooms

- (a) A children's room in a *children's service* must have a *floor area* allowing a clear space of at least 3.25 m² for each child using that room.
- (b) When calculating the clear space *required* by (a) any passageway or thoroughfare less than 3 metres wide, kitchen, toilet or shower area, storage area (including cupboards), areas through which doors may swing, cot rooms (including areas where fixed cots will be used or stored) or any other ancillary area must not be included.

Add Vic F3.102 as follows:

Vic F3.102 Class 3 buildings — size of rooms

A *habitable room* in a Class 3 building (other than a *residential aged care building*)—

- (a) must have a *floor area* of at least 7.5 m²; or
- (b) may have a *floor area* less than 7.5 m² provided the room has light and ventilation not less than that *required* for a room having a *floor area* of 7.5 m².

Add Vic F3.103 as follows:

Vic F3.103 Class 3, 9a and 9c residential aged care buildings — size of rooms

In a *residential aged care building*—

- (a) each bedroom must have a *floor area* of not less than 12 m² per occupant; and
- (b) all other common *habitable rooms* (other than kitchens) must have a *floor area* of not less than 7.5 m² with—
- (i) in a Class 3 hostel or supported residential services building or Class 9c building an aggregate *floor area* of not less than 3.5 m² per occupant; or
 - (ii) in a Class 9a nursing home an aggregate *floor area* of not less than 2.5 m² per occupant.

Part F4 Light and ventilation

Delete F4.1(d) and insert Vic F4.1(d) as follows:

Vic F4.1 Provision of natural light

- (d) **Class 9b buildings** — to all general purpose classrooms in primary or secondary *schools* and all playrooms or the like for the use of children in an *early childhood centre* other than a *restricted children's service*.

Substitute F4.2(b) and F4.2(d) and delete F4.2(c) as follows:

Vic F4.2 Methods and extent of natural lighting

- (b) In a Class 2, 3 or 9 building or Class 4 part of a building a *required window* that faces a boundary of an adjoining allotment or a wall of the same building or another building on the allotment must not be less than a horizontal distance from that boundary or wall that is the greater of—
- (i) generally — 1 m; and
 - (ii) in a *patient care area* or other room used for sleeping purposes in a Class 9a or Class 9c building — 3 m; and
 - (iii) 50% of the square root of the exterior height of the wall in which the *window* is located, measured in metres from its sill.
- (c) (deleted).
- (d) In a Class 9b *early childhood centre*, other than a d, the sills of 50% of *windows* in children's rooms must be located not more than 500 mm above the floor level.

Section G Ancillary provisions

Part G1 Minor structures and components

Delete GP1.2(a) and insert Vic GP1.2(a) as follows:

Performance Requirements

Vic GP1.2 Swimming pool access and water recirculation systems

- (a) A barrier must be provided to a *swimming pool* and must—
- (i) be continuous for the full extent of the hazard; and
 - (ii) be of a strength and rigidity to withstand the foreseeable impact of people; and
 - (iii) restrict the access of young children to the pool and the immediate pool surrounds; and
 - (iv) have any gates and doors fitted with latching devices not readily operated by young children, and constructed to automatically close and latch.

Application:

Vic GP1.2(a) only applies to a *swimming pool* with a depth of water more than 300 mm associated with—

- (a) a Class 2 or 3 building or Class 4 part of a building; or
- (b) a *children's service*.

Delete G1.1(a) and Insert Vic G1.1(a) as follows:

Deemed-to-Satisfy Provisions

Vic G1.1 Swimming pools

- (a) A *swimming pool* associated with a *children's service*, with a depth of water more than 300 mm, must have fencing or other barriers in accordance with AS 1926.1 and AS 1926.2.

Section H Special use buildings

Add Vic Part H101 as follows:

Vic Part H101 Class 3 and Class 9a residential aged care buildings and Class 9c buildings

Application:

This Part only applies to Class 3 and Class 9a *residential aged care buildings* and Class 9c buildings.

Note.

Vic Part H101 — Class 3 and Class 9a *residential aged care buildings* and Class 9c buildings contains additional *Deemed-to-Satisfy Provisions* for Sections D and F for Class 3 and Class 9a *residential aged care buildings* and Class 9c buildings as well as additional *Performance Requirements* and associated *Deemed-to-Satisfy Provisions*.

Performance Requirements

Vic HP101.1

The temperature of water supplied to baths and showers for use by residents must be controlled to avoid the risk of scalding whilst ensuring the stored water temperature does not encourage the growth of Legionella Bacteria.

Vic HP101.2

An electronic communication system must be provided to enable residents and staff to summon assistance in *habitable rooms* (other than kitchens), water closets, shower rooms and bathrooms.

Vic HP101.3

Sufficient general purpose outlets must be provided for electrical appliances in bedrooms in locations that obviate the need for extension leads.

Deemed-to-Satisfy Provisions

Vic H101.0 Deemed-to-Satisfy Provisions

Performance Requirements Vic HP101.1 to HP101.3 and relevant *Performance Requirements* in Sections D and F are satisfied by complying with Vic H101.1 to Vic H101.7.

Vic H101.1 Application of Part

The *Deemed-to-Satisfy Provisions* of this Part apply to Class 3 and Class 9a *residential aged care buildings* and Class 9c buildings.

Vic H101.2 Doorway width

- (a) The clear width of all bedroom entrance doorways must be not less than 900 mm.
- (b) The clear width of all other doorways must be not less than 800 mm.

Vic H101.3 Windows

- (a) The sill height of *windows* in *habitable rooms* (except kitchens) must be not more than 900 mm above the floor.
- (b) Openable *windows* must be provided with flyscreens.

Vic H101.4 Grab rails

Grab rails must be provided in association with every closet pan, shower or bath in accordance with AS 1428.1.

Vic H101.5 Heated water temperature

Heated water must be stored and delivered to baths and showers for use by residents in accordance with the requirements for new heated water installations under the Plumbing Regulations 2008.

Vic H101.6 Electronic communications system

A communication system must—

- (a) contain a back-up power supply; and
- (b) have a control that enables the call to be cancelled manually at the point of origin only; and
- (c) incorporate a device at the point of origin that indicates the system has operated; and
- (d) incorporate an indication panel in the manager's office or staff area that clearly identifies the point of origin of a call; and
- (e) have an audible tone that has a continuous signal until deactivated at the point of origin; and
- (f) be operational at all times; and
- (g) have two call points in each en-suite or combined shower/water closet with one call point located in the shower recess and the other on the wall beside the closet pan ahead of the bowl rim; and
- (h) have call points (other than those mentioned in (g)) which are located—
 - (i) within the reach of a resident whilst in bed; and
 - (ii) in all common *habitable rooms*; and
 - (iii) in all bathrooms, *sanitary compartments* and shower rooms where the call point must be of waterproof construction and within reach of any fallen resident.

Vic H101.7 Electrical power outlets

General purpose outlets must be provided as follows:

- (a) In bedrooms with one occupant—two general purpose outlets provided on a minimum of two walls.
- (b) For each additional occupant—two general purpose outlets provided at the head of each additional bed.

Add Vic Part H102 as follows:

Vic Part H102 Places of public entertainment

Application:

This Part applies to all places of public entertainment as defined in the Building Act 1993 and prescribed in regulation 206 of the Building Regulations 2018.

Note.

Vic Part H102 — Places of Public Entertainment contains additional deemed-to-satisfy and *Performance Requirements* for Sections B, D and F for places of public entertainment.

Performance Requirements

Vic HP102.1

Temporary tiered seating stands and embankments must be designed using engineering principles and constructed to provide for the safety of the patrons and orderly means of evacuation in an emergency.

Vic HP102.2

Every place of public entertainment where motor vehicle racing takes place must be provided with suitable barriers and guard rails to protect the public from injury.

Vic HP102.3

Sufficient sanitary and amenity facilities must be provided at places of public entertainment for use by patrons.

Deemed-to-Satisfy Provisions
Vic H102.0 Deemed-to-Satisfy Provisions

Performance Requirements Vic HP102.1 to HP102.3 are satisfied by complying with Vic H102.1 to Vic H102.4.

Vic H102.1 Application of Part

The *Deemed-to-Satisfy Provisions* of this Part apply to all places of public entertainment.

Vic H102.2 Temporary tiered seating, concourses and embankments

Temporary tiered seating stands and embankments must be designed and constructed as follows:

- (a) Temporary tiered seating, concourses and embankments must comply with the *Deemed-to-Satisfy Provisions* of [Section B](#), [Section D](#) and [Clause H1.4\(a\)\(ii\)](#), [\(iii\)](#) and [\(b\)](#).
- (b) The maximum slope of tiered seating must not exceed 34 degrees when measured from the horizontal plane.
- (c) Aisles must be evenly spaced throughout the structure and have—
 - (i) a minimum width of 1 m; and
 - (ii) the aggregate of aisle widths leading to an *exit* must be not less than the *required* width of that *exit*; and
 - (iii) no one aisle may serve more than—
 - (A) 120 patrons where individual seating with backs is provided; or
 - (B) 200 patrons in any other case.
- (d) When applying the balustrading requirements of the *Deemed-to-Satisfy Provisions* of [Section D](#), the height of plat balustrading that directly abuts seating (i.e. with no aisle between the seat and the balustrading) must be measured from the plat or seat base whichever is the higher.
- (e) Transverse aisles must be provided at a horizontal distance of not more than 10 m between any row of seats.
- (f) All individual moveable seats must be—
 - (i) fixed in groups of not less than four; and
 - (ii) not used in stepped or ramped seating areas.
- (g) For any spectators' embankment—
 - (i) where the rear slope exceeds 1 in 5, a guard rail must be installed with no openings except at the heads of steps or ramps; and
 - (ii) where the forward or front slope exceeds 1 in 8, the embankment must be stepped with plats not less than 500 mm wide and risers not greater than 230 mm high.
- (h) Guard rails must be installed to protect any fence, balustrade or railing associated with stepped or ramped standing spaces where excess pressure is expected from spectators.

Vic H102.3 Motor vehicle racing

Motor vehicle racing barriers and guard rails must be provided so as to comply with the following:

- (a) CAMS "Track Operators Safety Guide".
- (b) For stock car racing, barriers installed—
 - (i) on the outer margin of the track: a continuous concrete, close boarding or long guard barrier having a height of not less than 900 mm; and
 - (ii) on all curved sections of the track within 3 m of the barrier described in [\(i\)](#): a stout welded or woven wire mesh fence adequately supported having a height of not less than 1.8 m above the adjacent spectators viewing areas; and

- (iii) between the public viewing area and the fence described in (ii): a suitable crowd barrier that will prevent spectators entering within 1.2 m of that fence.

Vic H102.4 Sanitary and amenity facilities

Sanitary and amenity facilities in places of public entertainment must be provided as follows:

- (a) In places other than buildings:
 - (i) One closet fixture for every 200 female patrons or part thereof.
 - (ii) One closet fixture or urinal for every 200 male patrons or part thereof, at least 30% of which must be in the form of closet fixtures.
 - (iii) One washbasin for every 200 patrons or part thereof.
 - (iv) For use by disabled persons, one unisex facility within the meaning of Part F2 of the BCA for every 100 closet fixtures or part thereof *required* under (i) and (ii).
 - (v) One drinking fountain or drinking tap for every washbasin *required* under (iii).
 - (vi) First aid facilities in accordance with Vic F2.101.
- (b) In buildings, as *required* to comply with Part F2.

Add Vic Part H103 as follows:

Vic Part H103 Fire safety in Class 2 and Class 3 buildings

Note:

There are no *Performance Requirements* for Vic Part H103 — Fire Safety in Class 2 and Class 3 Buildings as the Part contains only additional *Deemed-to-Satisfy Provisions* for Sections C, D and E for Class 2 and Class 3 buildings.

Vic H103.1 Fire safety in Class 2 and Class 3 buildings

- (a) A Class 2 or Class 3 building not more than 25 m in *effective height* with a *rise in storeys* of not more than 3 that has a sprinkler system (other than a FPAA101D or FPAA101H system) complying with *Specification E1.5* installed throughout the building may be constructed in accordance with (b), except where the building is constructed using *fire-protected timber* building elements, provided that—
 - (i) where a sprinkler system complying with AS 2118.4, as applicable, is installed in the building, the system must be permanently connected with a direct data link or other approved monitoring system to a fire station or fire station dispatch centre in accordance with Practice Note 07-2018 if—
 - (A) it has more than 100 sprinkler heads; or
 - (B) in the case of a *residential care building (Vic)*, the building will accommodate more than 32 residents; and
 - (ii) the sprinkler system is fitted with sprinklers complying with Clauses 4.4, 4.5 and 5.5.2 of AS 2118.4 in bedrooms; and
 - (iii) an *automatic* smoke detection and alarm system is installed in accordance with *Specification E2.2a*, except that it need not be connected to a fire station and in the case of a *residential care building (Vic)* must be installed in accordance with—
 - (A) *Specification E2.2a Clause 4*; or
 - (B)
 - (aa) *Specification E2.2a Clause 3* provided *Clause 3 (b)(ii)* is applied as if the building was not protected with a sprinkler system; and
 - (bb) Practice Note 07-2018; and
 - (iv) in a *residential care building (Vic)*, the *automatic* smoke detection and alarm system and the sprinkler system are connected to an alarm panel constructed in accordance with Practice Note 07-2018; and
 - (v) fire orders are provided in a Class 3 building in accordance with G4.9.
- (b) Subject to compliance with (a), the following concessions are permissible:
 - (i) C3.11 — deletion of the requirement for *self-closing* fire doors or solid-core doors (except those opening to

fire-isolated *exits*).

- (ii) **Specification C1.1** — deletion of the requirement for *internal walls* to have an FRL subject to compliance with **Clause 2.2 of Specification C1.1**, except that walls bounding *public corridors* must be—
 - (A) clad in *non-combustible* material; and
 - (B) extend to the underside of a *non-combustible* roof covering or to the underside of the ceiling and be designed to minimise smoke spread to the corridor; and
 - (C) not incorporate any penetrations above door head height unless the penetrations are adequately stopped to prevent the free passage of smoke.
- (iii) **D1.3** — deletion of the requirement for stairways that serve not more than 5 *storeys* to be *fire-isolated stairways* provided—
 - (A) the stairway is smoke enclosed with construction that complies with **D2.6** (except **D2.6(a)** and **(b)(i)**); and
 - (B) in a Class 3 building, *storeys* 4 and 5 are served by a minimum of 2 smoke enclosed stairways.
- (iv) **D1.4(a)(i)(A)** — except in a *residential care building (Vic)*, the maximum distance of travel may be increased from 6 m to 12 m.
- (v) **D1.5(c)(i)** — except in a *residential care building (Vic)*, the maximum distance between alternative *exits* may be increased from 45 m to 60 m.
- (vi) **E1.3** — deletion of the requirement for internal fire hydrants in buildings that have a *rise in storeys* of not more than 5 provided—
 - (A) an external fire hydrant is installed in accordance with **E1.3** except that in a *residential care building (Vic)*, the nozzle at the end of the length of hose need only reach the entry door of any *sole-occupancy unit* to be considered as covering the floor area within the *sole-occupancy unit*; or
 - (B) a dry fire main fitted with standard fire hydrant heads is installed in the building provided that—
 - (aa) each fire hydrant head is located in accordance with **E1.3** and fitted with a blank cap or plug; and
 - (bb) the pipework is installed in accordance with **E1.3** (as if it were a fire main suitable for that building) except that it does not need to be connected to a water supply; and
 - (cc) a booster inlet connection is provided in accordance with **E1.3**; and
 - (dd) an external fire hydrant is located within 60 m of the booster connection.
- (vii) * * * * *
- (viii) **E4.9** — deletion of the requirement for a sound system and intercom system for emergency purposes in a *residential care building (Vic)* provided an intercom system with override public address facility is installed in accordance with Practice Note 08-2018.

Add Vic Part H104 as follows:

Vic Part H104 Class 9b Children’s Services

Application:

This Part only applies to Class 9b *children’s services*.

Note:

Vic Part H104 — Class 9b Children’s Services contains an additional *Performance Requirement* and *Deemed-to-Satisfy Provisions* for **Section D** for Class 9b *children’s services*.

Performance Requirements

Vic HP104.1

The number and location of doorways to a children’s room must take into account the mobility of children in the event that emergency egress or entry is required.

Deemed-to-Satisfy Provisions

Vic H104.0 Deemed-to-Satisfy Provisions

Performance Requirement Vic HP104.1 and relevant *Performance Requirements* in *Section D* are satisfied by complying with *Vic H104.1* and *Vic H104.2*.

Vic H104.1 Application of Part

The *Deemed-to-Satisfy Provisions* of this Part apply to Class 9b *children's services*.

Vic H104.2 Doorways to a children's room

A children's room must have a doorway, or in the case of every such room accommodating more than 21 children at least two doorways as widely separated as possible, providing direct access to or from—

- (a) an outdoor play area; or
- (b) a passage leading to the outside; or
- (c) a fire-isolated *exit*.

Schedule 3 Definitions

Vary [Schedule 3](#) as follows:

Vic Schedule 3 Definitions

Add the definition of [children's service](#) as follows:

Children's service has the same meaning as it has under the Children's Services Act 1996, but excludes a service where education and care is primarily provided to school aged children.

Substitute the definition of [early childhood centre](#) as follows:

Early childhood centre means—

- (a) any premises, or part thereof, providing or intending to provide a centre-based education and care service within the meaning of the Education and Care Services National Law Act 2010, and the Education and Care Services National Regulations, excluding a service where education and care is primarily provided to school aged children; and
- (b) a [children's service](#).

Substitute the definition of [flood hazard area](#) as follows:

Flood hazard area means the [site](#) (whether or not mapped) encompassing land in an area liable to flooding within the meaning of regulation 153 of the Building Regulations 2018.

Substitute the definition of [freeboard](#) as follows:

Freeboard means the minimum height of the level of the lowest floor of a building above the [defined flood level](#), regulated by the relevant planning scheme, or specified or otherwise determined by the relevant council under Regulation 153 of the Building Regulations 2018.

Add the definition of [hotel offering shared accommodation](#) as follows:

Hotel offering shared accommodation means a hotel which has any [sole-occupancy units](#) that can be shared by unrelated persons.

Add the definition of [residential care building \(Vic\)](#) as follows:

Residential care building (Vic) means a building which is a place of residence where 10% or more of persons who reside there need physical assistance in conducting their daily activities and to evacuate the building during an emergency (including any residential care service, State funded residential care service or supported residential service as defined in the Supported Residential Services (Private Proprietors) Act 2010 and an [aged care building](#)) *but does not include—*

- (a) a hospital; or
- (b) a dwelling in which 2 or more members of the same family and not more than 2 other persons would ordinarily be resident; or
- (c) a place of residence where only one resident needs physical assistance in conducting their daily activities and to evacuate the building during an emergency.

Add the definition of [restricted children's service](#) as follows:

Restricted children's service means a [children's service](#) that is—

- (a) a limited hours Type 1 service; or
- (b) a limited hours Type 2 service; or
- (c) a short term Type 1 service; or
- (d) a short term Type 2 service,
as defined in the Children's Services Regulations 2009; or
- (e) an associated children's service within the meaning of the Children's Services Act 1996 approved to be operated by an approved provider at the same place as an approved education and care service that is required to meet the conditions of a limited hours Type 1 service, a limited hours Type 2 service, a short term Type 1 service, or a short term Type 2 service.

Add the definition of [shared accommodation building](#) as follows:

Shared accommodation building means a Class 3 building having—

Victoria

-
- (a) more than one *sole-occupancy unit* of which any *sole-occupancy unit* has sleeping facilities capable of accommodating 3 or more unrelated persons; or
 - (b) sleeping facilities capable of accommodating 13 or more unrelated persons,

that is a boarding-house, chalet, guest house, lodging-house, backpacker accommodation or the like, or a residential part of a *hotel offering shared accommodation* but does not include a *residential care building (Vic)*, a motel or a residential part of a *school*, *health-care building* or detention centre.

Schedule 4 Referenced documents

Insert in Table 1 of [Schedule 4](#) the following additional and revised clause references and additional documents:

VIC Schedule 4 Referenced documents

Vic Table 1 Schedule of referenced documents

No.	Date	Title	Volume One
AS 1428.1	2009	Design for access and mobility, Part 1: General requirements for access— New building work (incorporating amendments 1 and 2)	Vic H101.4
AS 1926.1	2012	Swimming pool safety, Part 1: Safety barriers for swimming pools	Vic G1.1(a)
AS 1926.2	2007	Swimming pool safety, Part 2: Location of safety barriers for swimming pools (incorporating amendments 1 and 2)	Vic G1.1(a)
AS 2118.1	2017	Automatic fire sprinkler systems, Part 1: General systems (incorporating amendment 1)	Vic Spec E1.5 , Vic Spec E1.5a
AS 2118.4	2012	Automatic fire sprinkler systems, Part 4: Sprinkler protection for accommodation buildings not exceeding four storeys in height	Vic Spec E1.5 , Vic Spec E1.5a , Vic H103.1
AS 2118.6	2012	Automatic fire sprinkler systems, Part 6: Combined sprinkler and hydrant systems in multistorey buildings	Vic Spec E1.5
ABCB Standard for Construction of Buildings in Flood Hazard Areas, Version 2012.3	2012	Standard for Construction of Buildings in Flood Hazard Areas	Vic B1.6
CAMS Track operator's safety guide, Version 3	June 2012	CAMS (Confederation of Australian Motor Sport)— Track operator's safety guide	Vic H102.3
FPAA101D	2018	Automatic Fire Sprinkler System Design and Installation — Drinking Water Supply	Vic Spec E1.5 , Vic Spec E1.5a , Vic H103.1
FPAA101H	2018	Automatic Fire Sprinkler System Design and Installation — Hydrant Water Supply	Vic Spec E1.5 , Vic Spec E1.5a , Vic H103.1
Practice Note 07-2018	June 2018	Victorian Building Authority Practice Note 07-2018 — Residential fire safety	Vic Spec E2.2a , Vic H103.1

Victoria

No.	Date	Title	Volume One
		systems	
Practice Note 08-2018	June 2018	Victorian Building Authority Practice Note 08-2018 — Emergency communication systems	Vic H103.1

Footnote: Other legislation affecting buildings

In addition to any applicable provisions of the Building Act 1993, Building Regulations 2018 and this Code, there are a number of other legislative technical requirements affecting the design, construction and/or performance of buildings that practitioners may need to be aware of, including, but not necessarily limited to, the following list. Additional legislative instruments such as regulations, codes and standards may exist under the legislation listed.

1. Abattoirs and Knackeries**Administering Agency**

Department of Environment and Primary Industries

Relevant Legislation

Meat Industry Act 1993

2. Accommodation – Residential (Boarding Houses, Guest Houses, Hostels, Motels)**Administering Agency**

Department of Health and Human Services

Consumer Affairs Victoria

Municipal council

Relevant Legislation

Public Health and Wellbeing Act 2008

Public Health and Wellbeing Regulations 2009

Residential Tenancies Act 1997

Residential Tenancies (Rooming House Standards) Regulations 2012

3. Accommodation — Supported Residential Services**Administering Agency**

Department of Health and Human Services

Relevant Legislation

Supported Residential Services (Private Proprietors) Act 2010

Supported Residential Services (Private Proprietors) Regulations 2012

4. Alpine Resorts**Administering Agency**

Department of Environment, Land, Water and Planning

Alpine Resorts Management Boards

Relevant Legislation

Alpine Resorts (Management) Act 1997

5. Asbestos Removal**Administering Agency**

Victorian WorkCover Authority

Environment Protection Authority

Relevant Legislation

Occupational Health and Safety Act 2004

Environment Protection Act 1970

6. Children's Services**Administering Agency**

Department of Education and Training

Relevant Legislation

Children's Services Act 1996

Children's Services Regulations 2009

Education and Care Services National Law Act 2010

Education and Care Services National Regulations

7. Crematoria, Mausolea, Vaults, etc.

Administering Agency

Department of Health and Human Services, Cemeteries and Crematoria Regulation Unit

Cemetery Trusts

Relevant Legislation

Cemeteries and Crematoria Act 2003

Cemeteries and Crematoria Regulations 2015

8. Crown Land

Administering Agency

Department of Environment, Land, Water and Planning

Crown Land committees of management

Relevant Legislation

Crown Land (Reserves) Act 1978

9. Dairies

Administering Agency

Dairy Food Safety Victoria

Relevant Legislation

Dairy Act 2000

10. Dangerous Goods

Administering Agency

Victorian WorkCover Authority

Relevant Legislation

Dangerous Goods Act 1985

Dangerous Goods (Explosives) Regulations 2011

Dangerous Goods (HCDG) Regulations 2016

Dangerous Goods (Storage and Handling) Regulations 2012

Codes of practice published by the Victorian WorkCover Authority

11. Electrical Installations

Administering Agency

Energy Safe Victoria

Electrical transmission and distribution companies

Relevant Legislation

Electricity Industry Act 2000

Electricity Industry (Residual Provisions) Act 1993

Electricity Safety Act 1998

State Electricity Commission Act 1958

Electricity Safety (Installations) Regulations 2009

Standards Australia Wiring Rules, AS/NZS 3000/3013

12. Fences - dividing

Administering Agency

Department of Justice and Regulation
Dispute Settlement Centre of Victoria

Relevant Legislation

Fences Act 1968

13. Fire Prevention in Existing Buildings

Administering Agency

Municipal council

Relevant Legislation

Building Act 1993
Building Regulations 2018

14. Food Premises

Administering Agency

Department of Health and Human Services
Municipal council

Relevant Legislation

Food Act 1984

15. Gas Installations

Administering Agency

Energy Safe Victoria

Relevant Legislation

Gas Industry Act 2001
Gas Safety Act 1997
Gas Safety (Gas Installation) Regulations 2008
AS/NZS 5601 Gas Installations

16. Historic Buildings

Administering Agency

Department of Environment, Land, Water and Planning
Executive Director under the Heritage Act 2017

Relevant Legislation

Heritage Act 2017

17. Hospitals, Nursing Homes and Health Care Buildings

Administering Agency

Department of Health and Human Services

Relevant Legislation

Public Health and Wellbeing Act 2008

18. Lift Installations

Administering Agency

Victorian WorkCover Authority

Relevant Legislation

Occupational Health and Safety Act 2004
Occupational Health and Safety Regulations 2017
AS1735 Lifts, escalators and moving walks

19. Moveable Dwellings (in Caravan Parks)**Administering Agency**

Department of Environment, Land, Water and Planning
Municipal council

Relevant Legislation

Residential Tenancies Act 1997
Residential Tenancies (Caravan Parks and Moveable Dwellings Registration and Standards) Regulations 2010

20. Occupational Health and Safety**Administering Agency**

Victorian WorkCover Authority

Relevant Legislation

Occupational Health and Safety Act 2004
Occupational Health and Safety Regulations 2017
Codes of practice published by the Victorian WorkCover Authority

21. Pharmacies**Administering Agency**

Department of Health and Human Services
Victorian Pharmacy Authority

Relevant Legislation

Pharmacy Regulation Act 2010
Victorian Pharmacy Authority Guidelines

22. Planning Controls**Administering Agency**

Department of Environment, Land, Water and Planning
Municipal council

Relevant Legislation

Planning and Environment Act 1987
Planning schemes

23. Prisons and Jails**Administering Agency**

Department of Justice and Regulation
Corrections Victoria

Relevant Legislation

Corrections Act 1986

24. Radiation Safety**Administering Agency**

Department of Health and Human Services

Relevant Legislation

Radiation Act 2005

Radiation Regulations 2017

25. Schools (Non-Government)

Administering Agency

Department of Education and Training

Victorian Registration and Qualifications Authority

Relevant Legislation

Education and Training Reform Act 2006

26. Sanitary Plumbing, Water Supply and Sewerage

Administering Agency

Victorian Building Authority

Relevant Legislation

Building Act 1993

Plumbing Regulations 2018

National Construction Code Volume Three Plumbing Code of Australia

AS/NZS 3500 Plumbing and Drainage

27 Septic Tank Installations

Administering Agency

Environment Protection Authority

Municipal council

Relevant Legislation

Environment Protection Act 1970

Guidelines For Environmental Management: Code of Practice - Onsite wastewater management

28. Smoking Restrictions

Administering Agency

Department of Health and Human Services

Municipal council

Relevant Legislation

Tobacco Act 1987

29. Subdivision of Buildings

Administering Agency

Department of Environment, Land, Water and Planning

Municipal council

Relevant Legislation

Subdivision Act 1988

Western Australia

Introduction

Section H **Special use buildings**

WA Part H101 **Public buildings**

Schedule 3 **Definitions**

Footnote: **Other legislation affecting buildings**

Western Australia

Introduction

Section H Special use buildings

WA Part H101 Public buildings

- WA H101.0 Deemed-to-Satisfy Provisions
- WA H101.1 Application of Part
- WA H101.2 Additional exits
- WA H101.3 Goings and risers
- WA H101.4 Handrails to ramps, flights and landings
- WA H101.5 Artificial lighting
- WA H101.6 Fixed seating

Schedule 3 Definitions

WA Schedule 3 Definitions

Footnote: Other legislation affecting buildings

1. Building
2. Caravan Parks and Camping Grounds
3. Child Care
4. Fences
5. Health
6. Heritage
7. Hospitals and Health Services
8. Housing
9. Land
10. Occupational Health and Safety
11. Planning Controls
12. Public Works

Introduction

This Appendix contains variations and additions to the Building Code of Australia (BCA) provisions which are considered necessary for the effective application of the Code in Western Australia.

These additional provisions are a consolidation of existing building related requirements from the Health (Public Building) Regulations 1992 into the Western Australian Appendix of the BCA.

Section H Special use buildings

Insert WA Part H101 as follows:

WA Part H101

Public buildings

Note:

WA Part H101 contains *Deemed-to-Satisfy Solutions* for *WA public buildings* that are additional to those contained in Sections D, F and H.

WA H101.0 Deemed-to-Satisfy Provisions

- (a) Where a *Deemed-to-Satisfy Solution* is proposed, *Performance Requirements DP1, DP2, DP3, DP4, DP6 and FP4.2* are satisfied by complying with—
- (i) *Part D1, Part D2 and F4.4*; and
 - (ii) for additional requirements for *WA public buildings, WA Part H101*.
- (b) Where a *Performance Solution* is proposed, the relevant *Performance Requirements* must be determined in accordance with *A2.2(3)* and *A2.4(3)* as applicable.

WA H101.1 Application of Part

The *Deemed-to-Satisfy Provisions* of this Part apply to a *WA public building* or part of a building.

WA H101.2 Additional exits

In a *WA public building*, each *storey* that accommodates more than 50 persons must have more than one *exit* from that *storey*.

WA H101.3 Goings and risers

- (a) Steps serving a *WA public building* must have *risers* not more than 180 mm and *goings* not less than 280 mm.
- (b) The requirements of (a) do not apply to steps in a *fire-isolated stairway*.

WA H101.4 Handrails to ramps, flights and landings

- (a) For a *WA public building*, handrails must be located along—
- (i) both sides of a ramp or *flight*; and
 - (ii) each side of a landing, except for that part of a side that is interrupted by a ramp or *flight*.
- (b) The requirements of (a) do not apply to—
- (i) handrails referred to in *D2.18*; or
 - (ii) handrails located within a *fire-isolated stairway* or *fire-isolated ramp*.

WA H101.5 Artificial lighting

- (a) Artificial lighting must be provided along the external path of travel (including steps, landings, ramps or paths) to a road or *open space* associated with each *exit* from a *WA public building*.
- (b) The artificial lighting system *required* by (a) must—
- (i) provide a minimum illuminance of 1 lux at ground level; and
 - (ii) be connected to circuits separate from those supplying lighting for foyers, entry porches, emergency escape passages or areas providing entry or egress to the *WA public building*; and
 - (iii) be connected over two circuits where two or more lights are required; and
 - (iv) have switches that are not able to be operated by members of the public.

WA H101.6 Fixed seating

Where fixed seating in a Class 9b *WA public building* is arranged in more than one row—

- (a) Aisles must be provided on both sides of every row that contains 10 or more seats; and

- (b) The number of seats in a row between aisles must not exceed 42.

Schedule 3 Definitions

Vary [Schedule 3](#) as follows:

WA Schedule 3 Definitions

Insert definition for [WA public building](#) as follows:

WA public building means a Class 6 [licensed premises](#) or 9b building where persons may assemble for—

- (a) civic, theatrical, social, political or religious purposes; or
- (b) educational purposes; or
- (c) entertainment, recreational or sporting purposes; or
- (d) business purposes.

Insert definition for [licensed premises](#) as follows:

Licensed premises means—

- (a) premises in respect of which a cabaret licence as defined by the Liquor Control Act 1988 has been granted under that Act; or
- (b) premises in respect of which a tavern licence, a hotel restricted licence or any other kind of hotel licence as defined by the Liquor Control Act 1988 has been granted under that Act; or
- (c) a cabaret, hotel or tavern—
 - (i) in respect of which a special facility licence as defined by the Liquor Control Act 1988 has been granted under that Act; and
 - (ii) in respect of which paragraph (a) or (b) does not apply.

Footnote: Other legislation affecting buildings

In addition to any applicable provisions of the Building Act 2011, Building Regulations 2012 and this Code, there are a number of other legislative technical requirements affecting the design, construction and/or performance of buildings that practitioners may need to be aware of, including, but not necessarily limited to, the following list. Additional legislative instruments such as regulations, codes and standards may exist under the legislation listed.

1. Building

Administering Agency

Department of Mines, Industry Regulation and Safety

Relevant Legislation

Building Services (Complaint Resolution and Administration) Act 2011

Building Services (Complaint Resolution and Administration) Regulations 2011

Building Services (Registration) Act 2011

Building Services (Registration) Regulations 2011

2. Caravan Parks and Camping Grounds

Administering Agency

Department of Local Government, Sport and Cultural Industries

Relevant Legislation

Caravan Park and Camping Grounds Act 1995

Caravan Park and Camping Grounds Regulations 1997

3. Child Care

Administering Agency

Department of Communities

Relevant Legislation

Child Care Services Act 2007

Child Care Services Regulations 2007

Child Care Services (Child Care) Regulations 2006

4. Fences

Administering Agency

Department of Mines, Industry Regulation and Safety

Relevant Legislation

Dividing Fences Act 1961

5. Health

Administering Agency

Department of Health

Relevant Legislation

Health (Miscellaneous Provision) Act 1911

Health Act (Laundries & Bathrooms) Regulations

Health Act (Swimming Pools) Regulations 1964

Health (Air Handling and Water Systems) Regulations 1994

Health (Asbestos) Regulations 1992

Health (Aquatic Facilities) Regulations 2007

Health (Construction Work) Regulations 1973

Construction Camp Regulations
Health (Public Buildings) Regulations 1992
Health (Treatment of Sewage and Disposal of Effluent and Liquid Waste) Regulations 1974
Health (Rottnest Island) By-laws 1989
Sewerage (Lighting, Ventilation and Construction) Regulations 1971
Health Local Laws where adopted by Local Government

6. Heritage

Administering Agency

Heritage Council of Western Australia

Relevant Legislation

Heritage of Western Australia Act 1990
Heritage of Western Australia Regulations 1991

7. Hospitals and Health Services

Administering Agency

Department of Health

Relevant Legislation

Private Hospitals and Health Services Act 1927

8. Housing

Administering Agency

Department of Communities

Relevant Legislation

Housing Act 1980

9. Land

Administering Agency

Western Australian Land Information Authority

Relevant Legislation

Strata Titles Act 1985

10. Occupational Health and Safety

Administering Agency

Department of Mines, Industry Regulation and Safety

Relevant Legislation

Occupational Safety and Health Act 1984

11. Planning Controls

Administering Agency

Department of Planning, Lands and Heritage

Relevant Legislation

Planning and Development Act 2005
Planning and Development (Consequential and Transitional Provisions) Act 2005

12. Public Works

Administering Agency

Department of Finance, Building Management and Works

Relevant Legislation

Public Works Act 1902

Abbreviations and symbols

Schedule 2 Abbreviations and symbols

Schedule 2 Abbreviations and symbols

Schedule 2 Abbreviations and symbols

Schedule 2 Abbreviations and symbols

Abbreviations and symbols used in the NCC include:

Abbreviations

Abbreviation	Definition
ABCB	Australian Building Codes Board
AC	Alternating Current
ACP	Aluminium Composite Panel
AS	Australian Standard
ASET	Available Safe Egress Time
ASTM	American Society for Testing and Materials
BCA	Building Code of Australia
BE	Fire blocks evacuation route
CCT	Correlated Colour Temperature
CF	Challenging fire
CHF	Critical Heat Flux
CRF	Critical Radiant Flux
CRI	Colour Rendering Index
CS	Fire starts in a concealed space
C_{SHGC}	Constant for solar heat gain
CSIRO	Commonwealth Scientific and Industrial Research Organisation
C_U	Constant for conductance
DC	Direct Current
FED	Fractional Effective Dose
FI	Fire brigade intervention
FRL	Fire Resistance Level
GRP	Glass fibre reinforced polyester
HRR	Heat Release Rate
HS	Horizontal fire spread
IS	Rapid fire spread involving internal surface linings
ISO	International Organisation for Standardisation
LED	Light-Emitting Diode
MEPS	Minimum Energy Performance Standards
NABERS	National Australian Built Environment Rating System
NATA	National Association of Testing Authorities
NatHERS	Nationwide House Energy Rating Scheme
NCC	National Construction Code
PBDB	Performance-based design brief
PCA	Plumbing Code of Australia
PMV	Predicted Mean Vote
ppm	Parts per million
PVC	Polyvinyl chloride
RC	Robustness check
RSET	Required Safe Egress Time
R_w	Weighted sound reduction index
SF	Smouldering fire
SHGC	Solar Heat Gain Coefficient
SS	Structural stability and other property
STC	Sound Transmission Class

Abbreviations and symbols

Abbreviation	Definition
UF	Unexpected catastrophic failure
UPVC	Unplasticized polyvinyl chloride
UT	Fire in normally unoccupied room threatening occupants of other rooms
U-Value	Thermal transmittance
VS	Vertical fire spread involving external cladding or external openings

Symbols

Symbol	Definition
°	degree(s)
°C	degree(s) Celsius
°CDB	degree(s) Celsius Dry Bulb
°CWB	degree(s) Celsius Wet Bulb
-e/MJ	equivalent per Megajoule(s)
µm	micrometre
dB(A)	decibels "A" scale weighting network
J	Joule(s)
J/kg.K	Joules per kilogram degree Kelvin
J/s.m ²	Joules per second square metre
K	Kelvin(s)
kg	kilogram(s)
kg/m	kilogram(s) per metre
kg/m ²	kilogram(s) per square metre
kg/m ³	kilogram(s) per cubic metre
kJ/m ² .hour	kilojoules per square metre hour
km	kilometre(s)
kPa	kilopascal(s)
kW/m ²	kilowatt(s) per square metre
kW _{heating}	kilowatt(s) of heating
kWr	kilowatt(s) of refrigeration
L	litre(s)
L/min	litre(s) per minute
L/s	litre(s) per second
L/s.m ²	litre(s) per second square metre
Lumens/W	Lumens per Watt
lx	lux
m	metre(s)
m/s	metre(s) per second
m ²	square metre(s)
m ² .K/W	square metre Kelvin(s) per Watt
m ³	cubic metre(s)
m ³ /hour	cubic metre(s) per hour
m ³ /s	cubic metre(s) per second
mcd/m ²	millicandelas per square metre
min	minute(s)
MJ/hour	Megajoules per hour
MJ/m ² .annum	Megajoules per square metre annum
mm	millimetre(s)
mm ²	square millimetre(s)

Abbreviations and symbols

Symbol	Definition
MW	megawatt(s)
N	newton(s)
Pa	pascal(s)
Pa/m	pascal(s) per metre
s	second(s)
V	Volt(s)
W	Watt(s)
$W_{\text{input power}}$	Watts of input power
$W_r/W_{\text{input power}}$	Watts of thermal refrigeration per watt of input power
W/kW_{rej}	Watts per kilowatt of heat rejected
W/m.K	Watts per metre degree Kelvin
W/m ²	Watts per square metre
°south	degree south
%	percent
>	greater than
<	less than
≤	less than or equal to
≥	equal to or more than

Definitions

Schedule 3 Definitions

Schedule 3 Definitions

Schedule 3 Definitions

Definitions

Schedule 3 Definitions

Definitions

Note: States and Territories may vary or add to the definitions contained in [Schedule 3](#) at the relevant State or Territory Appendix.

In the NCC unless the contrary intention appears—

Accessible means having features to enable use by people with a disability.

Accessway means a continuous [accessible](#) path of travel (as defined in AS 1428.1) to, into or within a building.

Accredited Testing Laboratory means—

- (a) an organisation accredited by the National Association of Testing Authorities (NATA) to undertake the relevant tests; or
- (b) an organisation outside Australia accredited to undertake the relevant tests by an authority recognised by NATA through a mutual recognition agreement; or
- (c) an organisation recognised as being an [Accredited Testing Laboratory](#) under legislation at the time the test was undertaken.

Activity support level means the degree to which occupants can undertake activities with respect to the likely [activity traits](#) and [occupant traits](#).

Explanatory information:

This term is used to articulate whether the height of a room or space is sufficient and by what degree. This is achieved by having regard to the room or space's intended use by occupants, through consideration of the defined terms '[activity traits](#)' and '[occupant traits](#)'.

Activity traits, for the purposes of Volume One, means the features of the activities that will be undertaken in a [habitable room](#) or space.

Activity traits, for the purposes of Volume Two, means the features of the activities that will be undertaken in a room or space.

Explanatory information:

This term is used to describe the characteristics of the activities that will be undertaken in a room or space.

For example, the activities likely to be undertaken in a bedroom, and the associated features are—

- sleeping — a person laying horizontally; and
- resting — a person laying horizontally or sitting upright on the bed; and
- leisure activities, such as reading a book — a person sitting upright on the bed, with enough space to stretch their arms vertically; and
- dressing/changing clothes — a person standing with enough space to stretch their arms vertically.

Administering body means the body responsible for administering the [WaterMark Certification Scheme](#).

Aged care building means a Class 9c building for residential accommodation of aged persons who, due to varying degrees of incapacity associated with the ageing process, are provided with [personal care services](#) and 24 hour staff assistance to evacuate the building during an emergency.

Air-conditioning, for the purposes of [Section J](#) of Volume One, means a [service](#) that actively cools or heats the air within a space, but does not include a [service](#) that directly

- (a) cools or heats cold or hot rooms; or
- (b) maintains specialised conditions for equipment or processes, where this is the main purpose of the [service](#).

Alarm zone, for the purposes of [Specification E2.2d](#) of Volume One, means an area of a building protected by one or more smoke alarms connected to one alarm circuit.

Alpine area means an area given in [Figure 1](#) and in [Table 1](#) for specific locations, and is—

- (a) likely to be subject to significant snowfalls; and
- (b) in New South Wales, A.C.T. or Victoria more than 1200 m above the Australian Height Datum; and
- (c) in Tasmania more than 900 m above the Australian Height Datum.

Definitions

Figure 1 Alpine areas

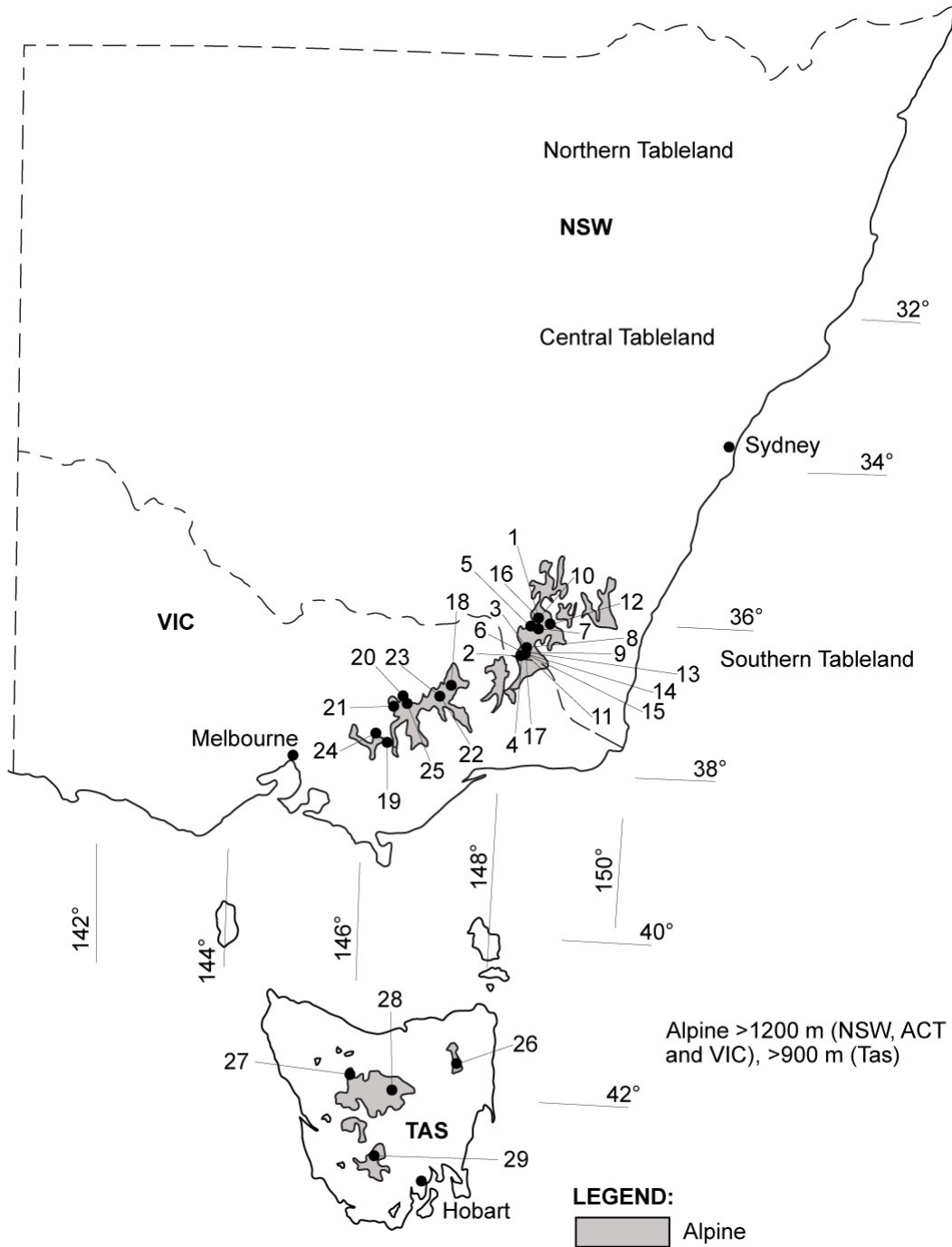

Note:

This map is approximate only and altitude above Australian Height Datum must be used to determine whether the building falls into an *alpine area* region.

Table 1 Alpine areas where snow loads are significant

Location	Map identifier
Kiandra (NSW)	1
Mount Kosciuszko (NSW)	2
Perisher Valley (NSW)	3
Thredbo (NSW)	4
Cabramurra (NSW)	5
Charlotte Pass Village (NSW)	6
Diggers Creek (NSW)	7

Definitions

Location	Map identifier
Guthega Village (NSW)	8
Mount Blue Cow (NSW)	9
Mount Selwyn (NSW)	10
Perisher Range (NSW)	11
Rules Point (NSW)	12
Sawpit Creek (NSW)	13
Smiggin Holes (NSW)	14
Smiggin Range (NSW)	15
Three Mile Dam (NSW)	16
Wilsons Valley (NSW)	17
Falls Creek (Vic.), including Summit Area, Sun Valley and Village Bowl	18
Mount Baw Baw (Vic.)	19
Mount Buffalo (Vic.), including Chalet, Dingo Dell and Tatra	20
Mount Buller (Vic.), including Baldy and Village	21
Mount Hotham (Vic.), including Davenport and Village Centre	22
Dinner Plain (Vic.)	23
Lake Mountain (Vic.)	24
Mount Stirling (Vic.)	25
Ben Lomond Ski Field (Tas.)	26
Cradle Valley (Tas.)	27
Great Lake Area (Tas.)	28
Mount Field Ski Field (Tas.)	29

Explanatory information:

Alpine areas are located in New South Wales, Victoria and Tasmania.

Alpine areas are areas 1200 m or more above Australian Height Datum (AHD) for New South Wales, Australian Capital Territory and Victoria, and 900 m or more above AHD for Tasmania, as shown in [Figure 1](#).

Alpine areas are considered to receive significant snowfalls (snowfalls that result in an average snow accumulation on the ground of 175 mm or greater). Regions in New South Wales, the Australian Capital Territory and Victoria between 600–1200 m AHD are considered to be sub-*alpine areas* and may receive significant snowfalls, however unlike *alpine areas* the snow is unlikely to accumulate.

It is recommended that the *appropriate authority* be consulted to determine whether the building is located in an *alpine area*. AS/NZS 1170.3 also contains further detail in the identification of *alpine areas* and the altitude of the alpine regions of Australia.

In the Australian Capital Territory, Canberra is not designated as an *alpine area* as snow loads are not considered significant.

Alteration in relation to a building, includes an addition or extension to a building.

Aluminium Composite Panel (ACP) means flat or profiled aluminium sheet material in composite with any type of materials.

Amenity means an attribute which contributes to the health, physical independence, comfort and well-being of people.

Ancillary element means an element that is secondary to and not an integral part of another element to which it is attached.

Annual greenhouse gas emissions means the theoretical amount of greenhouse gas emissions attributable to the energy used annually by a building's *services*, excluding kitchen exhaust and the like.

Appropriate authority means the relevant authority with the statutory responsibility to determine the particular matter.

State and Territory variations

For Volume One see [\(NSW, Appropriate authority\)](#)

For Volume Two see [\(NSW, Appropriate authority\)](#)

Appropriate Authority, for the purposes of [Schedule 7](#), means the relevant authority with the statutory responsibility to determine the particular matter satisfies the relevant *Performance Requirement*.

Definitions

Explanatory information:

The *Appropriate Authority* is typically the building surveyor or building certifier charged with the statutory responsibility to determine building compliance and issue the building permit / approval and occupancy certificate / approval.

Appropriately qualified person means a person recognised by the *appropriate authority* as having qualifications and/or experience in the relevant discipline in question.

Approved disposal system means a system for the disposal of sewage, sullage or stormwater approved by an authority having jurisdiction.

Articulated masonry means masonry construction in which special provisions have been made for movement by articulation.

Assembly building means a building where people may assemble for—

- (a) civic, theatrical, social, political or religious purposes including a library, theatre, public hall or place of worship; or
- (b) educational purposes in a *school*, *early childhood centre*, preschool, or the like; or
- (c) entertainment, recreational or sporting purposes including—
 - (i) a discotheque, nightclub or a bar area of a hotel or motel providing live entertainment or containing a dance floor; or
 - (ii) a cinema; or
 - (iii) a sports stadium, sporting or other club; or
- (d) transit purposes including a bus station, railway station, airport or ferry terminal.

State and Territory variation

For Volume One see (*NSW, Assembly building*) and (*SA, Assembly building*)

Assessment Method means a method that can be used for determining that a *Performance Solution* or *Deemed-to-Satisfy Solution* complies with the *Performance Requirements*.

Atrium means a space within a building that connects 2 or more *storeys* and—

- (a) is enclosed at the top by a floor or roof (including a glazed roof structure); and
- (b) includes any adjacent part of the building not separated by an appropriate barrier to fire; but
- (c) does not include a stairwell, rampwell or the space within a *shaft*; and
- (d) for the purposes of (a) a space is considered enclosed if the area of the enclosing floor or roof is greater than 50% of the area of the space, measured in plan, of any of the *storeys* connected by the space.

Atrium well means a space in an *atrium* bounded by the perimeter of the openings in the floors or by the perimeter of the floors and the *external walls*.

Automatic means designed to operate when activated by a heat, smoke or fire sensing device.

Available safe egress time (ASET) means the time between ignition of a fire and the onset of untenable conditions in a specific part of a building. This is the calculated interval between the time of ignition of a fire and the time at which conditions become such that the occupant is unable to take effective action to escape to a place of safety.

Average daylight factor means the ratio of the illumination level within a room provided by daylight to the level of daylight outside the building during overcast conditions.

Average recurrence interval, applied to rainfall, means the expected or average interval between exceedances for a 5 minute duration rainfall intensity.

Average specific extinction area means the *average specific extinction area* for smoke as determined by AS 5637.1.

Backflow prevention device means an air gap, break tank or mechanical device that is designed to prevent the unplanned reversal of flow of water or *contaminants* into the water service or a *Network Utility Operator's* water supply.

Backpressure means a reversal of water flow caused by the downstream pressure becoming greater than the supply pressure.

Backsiphonage means a reversal of flow of water caused by negative pressure in the distributing pipes of a water service or supply.

Backstage means a space associated with, and adjacent to, a *stage* in a Class 9b building for scenery, props, equipment, dressing rooms, or the like.

Battery system means one or more chemical cells connected in series, parallel or a combination of the two for the purpose of electrical energy storage.

Blockage means an obstruction within a *drainage* system.

Boiler means a vessel or an arrangement of vessels and interconnecting parts, wherein steam or other vapour is

Definitions

generated, or water or other liquid is heated at a pressure above that of the atmosphere, by the application of fire, the products of combustion, electrical power, or similar high temperature means, and—

- (a) includes superheaters, reheaters, economisers, *boiler* piping, supports, mountings, valves, gauges, fittings, controls, the *boiler* settings and directly associated equipment; but
- (b) excludes a fully flooded or pressurised system where water or other liquid is heated to a temperature lower than the normal atmospheric boiling temperature of the liquid.

Breaking surf means any area of salt water in which waves break on an average of at least 4 days per week but does not include white caps or choppy water.

Explanatory information:

Breaking surf normally occurs in areas exposed to the open sea. *Breaking surf* does not normally occur in sheltered areas, such as that which occurs around Port Phillip Bay, Sydney Harbour, Swan River, Derwent River and similar locations.

Burnout means exposure to fire for a time that includes *fire growth*, full development, and decay in the absence of intervention or automatic suppression, beyond which the fire is no longer a threat to building elements intended to perform *loadbearing* or fire separation functions, or both.

Carpark means a building that is used for the parking of motor vehicles but is neither a *private garage* nor used for the servicing of vehicles, other than washing, cleaning or polishing.

Cavity means a void between 2 leaves of masonry, or in masonry veneer construction, a void between a leaf of masonry and the supporting frame.

Cavity wall, for the purposes of [FV1.1](#) in Volume One and [V2.2.1](#) in Volume Two, means a wall that incorporates a drained cavity.

Certificate of Accreditation means a certificate issued by a State or Territory accreditation authority stating that the properties and performance of a building material or method of construction or design fulfil specific requirements of the BCA.

Certificate of Conformity means a certificate issued under the ABCB scheme for products and systems certification stating that the properties and performance of a building material or method of construction or design fulfil specific requirements of the NCC.

Certification body means a person or organisation operating in the field of material, product, form of construction or design certification that has been accredited by the Joint Accreditation System of Australia and New Zealand (JAZ-ANZ), and is accredited for a purpose other than as part of the CodeMark Australia Certification Scheme or [WaterMark Certification Scheme](#).

Characteristic means the occupant data to be used in the modelling of access solutions which define how an occupant interacts with a building, i.e. occupant movement speeds, turning ability, reach capability, perception of luminance contrast and hearing threshold.

Clad frame means timber or metal frame construction with exterior timber or sheet wall cladding that is not sensitive to minor movement and includes substructure masonry walls up to 1.5 m high.

Climate zone means an area defined in [Figure 2](#) and in [Table 2](#) for specific locations, having energy efficiency provisions based on a range of similar climatic characteristics.

Definitions

Figure 2 Climate zones for thermal design

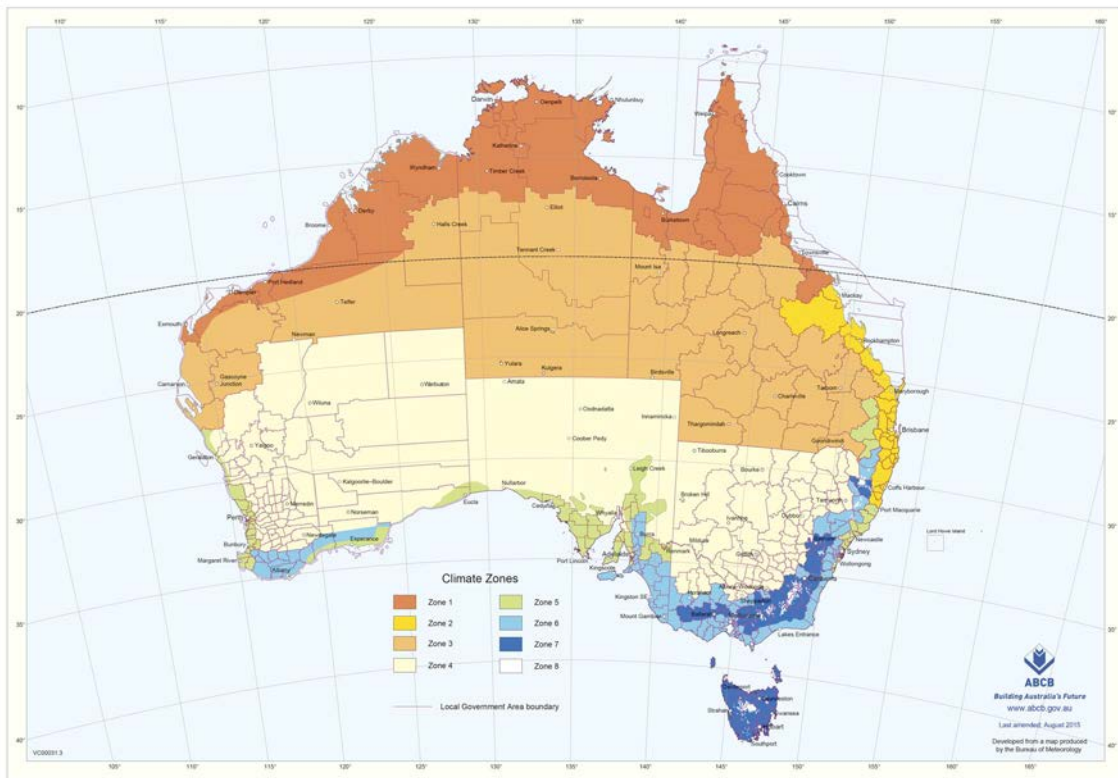

Notes:

1. This map can be viewed in enlargeable form on the ABCB website at www.abcb.gov.au.
2. A Zone 4 area in South Australia, other than a council area, at an altitude greater than 300 m above the Australian Height Datum is to be considered as Zone 5.
 These areas have been defined in an enlarged format on the following maps produced by the Department of Planning, Transport and Infrastructure:
Adelaide Hills Council Climate Zone Map
Barossa Council Climate Zone Map
Regional Council of Goyder Climate Zone Map
 These maps can be viewed on the Government of South Australia website at www.sa.gov.au.
3. Locations in *climate zone 8* are in *alpine areas*.

Table 2 Climate zones for thermal design—Various locations

Location	Climate zone	Location	Climate zone	Location	Climate zone	Location	Climate zone
Australian Capital Territory				Canberra	7		
New South Wales							
Albury	4	Byron Bay	2	Lord Howe Island	2	Sydney West	6
Armidale	7	Cobar	4	Moree	4	Tamworth	4
Batemans Bay	6	Coffs Harbour	2	Newcastle	5	Thredbo	8
Bathurst	7	Dubbo	4	Nowra	6	Wagga Wagga	4
Bega	6	Goulburn	7	Orange	7	Williamstown	5
Bellingen Shire	7	Grafton	2	Perisher	8	Wollongong	5
Dorrigo Plateau	-			Smiggins			

Definitions

Location	Climate zone	Location	Climate zone	Location	Climate zone	Location	Climate zone
Bellingen Shire - Valley & seaboard	2	Griffith	4	Port Macquarie	5	Yass	6
Bourke	4	Ivanhoe	4	Sydney East	5		
Broken Hill	4	Lismore	2				
Northern Territory							
Alice Springs	3	Elliot	3	Renner Springs	3		
Darwin	1	Katherine	1	Tennant Creek	3		
Queensland							
Birdsville	3	Gladstone	2	Mount Isa	3		
Brisbane	2	Hervey Bay	2	Normanton	1	Townsville	1
Bundaberg	2	Hughenden	3	Rockhampton	2	Warwick	5
Cairns	1	Longreach	3	Roma	3	Weipa	1
Cooktown	1	Mackay	2	Southport	2		
Cunnamulla	3			Toowoomba	5		
South Australia							
Adelaide	5	Kingscote	6	Marree	4	Port Lincoln	5
Bordertown	6	Leigh Creek	5	Mount Gambier	6	Renmark	5
Ceduna	5	Lobethal	6	Murray Bridge	6	Tarcoola	4
Cook	4	Loxton	5	Oodnadatta	4	Victor Harbour	6
Elliston	5	Naracoorte	6	Port Augusta	4	Whyalla	4
Tasmania							
Burnie	7	Flinders Island	7	Launceston	7	Rossarden	7
Bicheno	7	Hobart	7	New Norfolk	7	Smithton	7
Deloraine	7	Huonville	7	Oatlands	7	St Marys	7
Devonport	7	King Island	7	Orford	7	Zeehan	7
Victoria							
Anglesea	6	Bright	7	Horsham	6	Swan Hill	4
Ararat	7	Colac	6	Melbourne	6	Traralgon	6
Bairnsdale	6	Dandenong	6	Mildura	4	Wangaratta	7
Ballarat	7	Echuca	4	Portland	6	Warrnambool	6
Benalla	6	Geelong	6	Sale	6	Wodonga	6
Bendigo	6	Hamilton	7	Shepparton	4		
Western Australia							
Albany	6	Cocos Island	1	Kalgoorlie-Boulder	4	Port Hedland	1
Balladonia	4	Derby	1	Karratha	1	Wagin	4
Broome	1	Esperance	5	Meekatharra	4	Wyndham	1
Bunbury	5	Exmouth	1	Northam	4		
Carnarvon	3	Geraldton	5	Pemberton	6		
Christmas Island	1	Halls Creek	3	Perth	5		

Combustible means—

- (a) applied to a material — *combustible* as determined by AS 1530.1; and
- (b) applied to construction or part of a building — constructed wholly or in part of *combustible* materials.

Common wall, for the purposes of Volume One, means a wall that is common to adjoining buildings.

Common wall, for the purposes of Volume Two, means a wall that is common to adjoining buildings other than Class 1 buildings.

Condensation means the formation of moisture on the surface of a building element or material as a result of moist air

Definitions

coming into contact with a surface which is at a lower temperature.

Conditioned space, for the purposes of Volume One, means a space within a building, including a ceiling or under-floor supply air plenum or return air plenum, where the environment is likely, by the intended use of the space, to have its temperature controlled by [air-conditioning](#).

Conditioned space, for the purposes of Volume Two, means a space within a building that is heated or cooled by the building's [domestic services](#), excluding a non-[habitable room](#) in which a heater with a capacity of not more than 1.2 kW or 4.3 MJ/hour is installed.

Containment protection means the installation of a [backflow prevention device](#) at the [point of connection](#) of a [Network Utility Operator's](#) water supply to a site.

Contaminant means any substance (including gases, liquids, solids or micro-organisms), energy (excluding noise) or heat, that either by itself or in combination with the same, similar or other substances, energy or heat, changes or is likely to change the physical, chemical or biological condition of water.

Construction activity actions means actions due to stacking of building materials or the use of equipment, including cranes and trucks, during construction or actions which may be induced by floor to floor propping.

Controlled fill means material that has been placed and compacted in layers with compaction equipment (such as a vibrating plate) within a defined moisture range to a defined density requirement.

Cooling load means the calculated amount of energy removed from the cooled spaces of the building annually by artificial means to maintain the desired temperatures in those spaces.

Critical radiant flux (CRF) means the critical heat flux at extinguishment (CHF in kW/m²) as determined by AS ISO 9239.1.

Cross-connection means any actual or potential connection between a water supply and any [contaminant](#).

Curtain wall means a non-[loadbearing external wall](#) that is not a [panel wall](#).

Damp-proof course (DPC) means a continuous layer of impervious material placed in a masonry wall or pier, or between a wall or pier and a floor, to prevent the upward or downward migration of water.

Deemed-to-Satisfy Provisions means provisions which are deemed to satisfy the [Performance Requirements](#).

Deemed-to-Satisfy Solution means a method of satisfying the [Deemed-to-Satisfy Provisions](#).

Defined flood event (DFE) means the flood event selected for the management of flood hazard for the location of specific development as determined by the [appropriate authority](#).

Defined flood level (DFL) means the flood level associated with a [defined flood event](#) relative to a specified datum (see [Figure 3](#)).

Figure 3 Identification of defined flood level, flood hazard level and freeboard

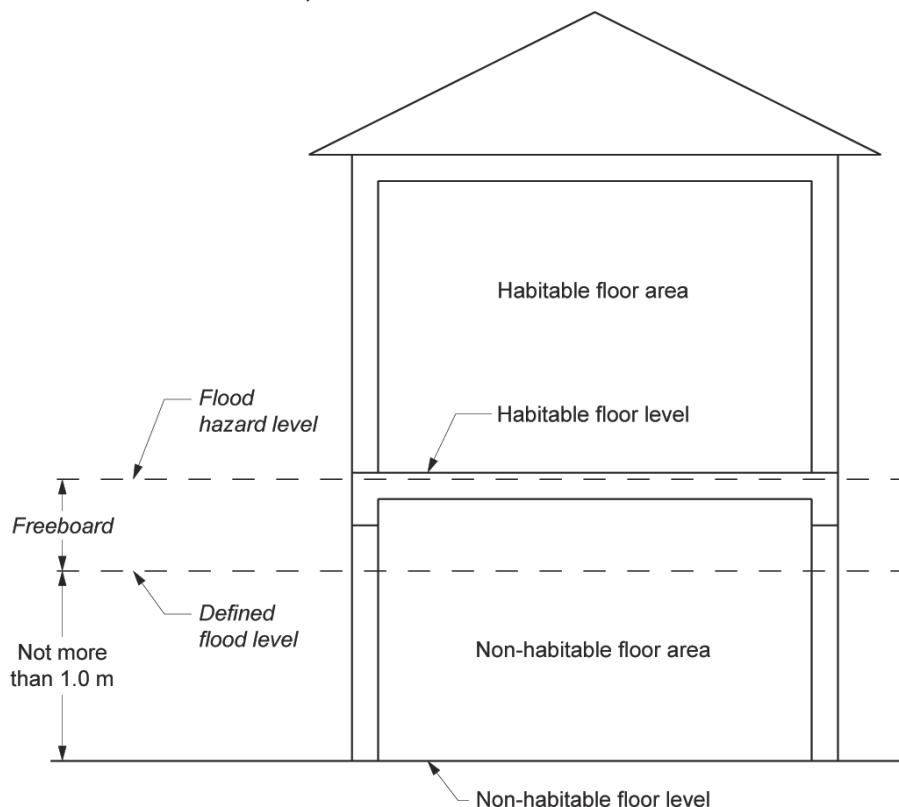

Design fire means the quantitative description of a representation of a fire within the [design scenario](#).

Definitions

Design scenario means the specific scenario of which the sequence of events is quantified and a *fire safety engineering* analysis is conducted against.

Design wind speed means the design gust wind speed for the area where the building is located, calculated in accordance with AS/NZS 1170.2 or AS 4055 (see [Table 3](#) for wind classes).

Table 3 Wind classes

Non-cyclonic Region A and B	Cyclonic Region C and D
N1, N2, N3	C1
N4, N5, N6 (these wind classes are covered by Volume Two Part 3.0 , Structural provisions).	C2, C3, C4 (these wind classes are covered by Volume Two Part 3.0 , Structural provisions).

Notes:

1. Wind classification map identifying wind regions is contained in Volume Two [Part 3.0](#) (see [Figure 3.0.1](#)).
2. Information on wind classes for particular areas may be available from the *appropriate authority*.
3. “N” = non-cyclonic winds and “C” = cyclonic winds.

Designated bushfire prone area means land which has been designated under a power of legislation as being subject, or likely to be subject, to bushfires.

State and Territory variations

For Volume One see ([NSW, Designated bushfire prone area](#))

For Volume Two see ([NSW, Designated bushfire prone area](#))

Detention centre means a building in which persons are securely detained by means of the built structure including a prison, remand centre, juvenile *detention centre*, holding cells or psychiatric *detention centre*.

Direct fix cladding wall, for the purposes of [FV1.1](#) in Volume One and [V2.2.1](#) in Volume Two, means a wall with cladding attached directly to the wall framing without the use of a drained cavity.

Discontinuous construction means the following:

- (a) A wall having a minimum 20 mm cavity between 2 separate leaves, and—
 - (i) for masonry, where wall ties are used to connect leaves, the ties are of the resilient type; and
 - (ii) for other than masonry, there is no mechanical linkage between the leaves, except at the periphery.
- (b) A staggered stud wall is not deemed to be *discontinuous construction*.

Display glazing means *glazing* used to display retail goods in a shop or showroom directly adjacent to a walkway or footpath, but not including that used in a café or restaurant.

Domestic services means the basic engineering systems that use energy or control the use of energy; and—

- (a) includes—
 - (i) heating, air-conditioning, mechanical ventilation and artificial lighting; and
 - (ii) pumps and heaters for *swimming pools* and spa pools; and
 - (iii) heated water systems; but
- (b) excludes cooking facilities and portable appliances.

Drainage means any sanitary *drainage*, liquid trade waste *drainage* or stormwater *drainage* system.

Drinking water means water intended primarily for human consumption but which has other domestic uses.

Explanatory Information:

See also the Australian Drinking Water Guidelines produced by the National Health and Medical Research Council.

Early childhood centre means any premises or part thereof providing or intending to provide a centre-based education and care service within the meaning of the Education and Care Services National Law Act 2010 (Vic), the Education and Care Services National Regulations and centre-based services that are licensed or approved under State and Territory children’s services law, but excludes education and care primarily provided to school aged children in outside school hours settings.

State and Territory variations

For Volume One see ([Tas, Early childhood centre](#)) and ([Vic, Early childhood centre](#))

Definitions

Effective height means the vertical distance between the floor of the lowest *storey* included in the calculation of *rise in storeys* and the floor of the topmost *storey* (excluding the topmost *storey* if it contains only heating, ventilating, lift or other equipment, water tanks or similar service units).

Electric passenger lift means a power-operated lift for raising or lowering people in a car in which the motion of the car is obtained from an electric motor mechanically coupled to the hoisting mechanism.

Electricity network substation means a building in which high voltage supply is converted or transformed and which is controlled by a licensed network service provider designated under a power of legislation.

Electrohydraulic passenger lift means a power-operated lift for raising or lowering people in a car in which the motion of the car is obtained from the action of liquid under pressure acting on a piston or ram, the pressure being generated by a pump driven by an individual electric motor.

Envelope, for the purposes of [Section J](#) in Volume One, means the parts of a building's *fabric* that separate a *conditioned space* or *habitable room* from—

- (a) the exterior of the building; or
- (b) a non-*conditioned space* including—
 - (i) the floor of a rooftop plant room, lift-machine room or the like; and
 - (ii) the floor above a *carpark* or warehouse; and
 - (iii) the *common wall* with a *carpark*, warehouse or the like.

Envelope, for the purposes of [Part 2.6](#) and [Part 3.12](#) in Volume Two, means the parts of a building's *fabric* that separate artificially heated or cooled spaces from—

- (a) the exterior of the building; or
- (b) other spaces that are not artificially heated or cooled.

Equivalent means equivalent to the level of health, safety and amenity provided by the *Deemed-to-Satisfy Provisions*.

Evacuation route means the continuous path of travel (including *exits*, *public corridors* and the like) from any part of a building, including within a *sole-occupancy unit* in a Class 2 or 3 building or Class 4 part, to a *safe place*.

Evacuation time means the time calculated from when the emergency starts for the occupants of the building to evacuate to a *safe place*.

Exit means—

- (a) any, or any combination of the following if they provide egress to a road or *open space*:
 - (i) An internal or external stairway.
 - (ii) A ramp.
 - (iii) A *fire-isolated passageway*.
 - (iv) A doorway opening to a road or *open space*.
- (b) A *horizontal exit* or a *fire-isolated passageway* leading to a *horizontal exit*.

Expert Judgement means the judgement of an expert who has the qualifications and experience to determine whether a *Performance Solution* or *Deemed-to-Satisfy Solution* complies with the *Performance Requirements*.

Explanatory Information:

Contemporary and relevant qualifications and/or experience are necessary to determine whether a *Performance Solution* complies with the *Performance Requirements*. The level of qualification and/or experience may differ depending on the complexity of the proposal and the requirements of the regulatory authority. Practitioners should seek advice from the authority having jurisdiction or *appropriate authority* for clarification as to what will be accepted.

State and Territory variation:

For Volume Three see ([Tas, Expert Judgement](#))

External wall, for the purposes of Volume One, means an outer wall of a building which is not a *common wall*.

External wall, for the purposes of Volume Two, means an outer wall of a building which is not a *separating wall*.

Extra-low voltage means a *voltage* not exceeding 50 V AC or 120 V ripple-free DC.

Fabric means the basic building structural elements and components of a building including the roof, ceilings, walls, glazing and floors.

Farming means—

- (a) cultivating, propagating and harvesting plants or fungi or their products or parts, including seeds, spores, bulbs

Definitions

- or the like, but does not include forestry; or
- (b) maintaining animals in any physical environment for the purposes of—
 - (i) breeding them; or
 - (ii) selling them; or
 - (iii) acquiring and selling their bodily produce such as milk, wool, eggs or the like; or
 - (c) a combination of (a), and (b),
- but does not include forestry or maintaining animals for sport or recreational purposes.

Farm building means a Class 7 or 8 building located on land primarily used for *farming*—

- (a) that is—
 - (i) used in connection with *farming*; or
 - (ii) used primarily to store one or more *farm vehicles*; or
 - (iii) a combination of (i) and (ii); and
- (b) in which the total number of persons accommodated at any time does not exceed one person per 200 m² of *floor area* or part thereof, up to a maximum of 8 persons; and
- (c) with a total *floor area* of not more than 3500 m².

State and Territory variation

For Volume One see (*SA, Farm building*)

Farm shed means a single *storey* Class 7 or 8 building located on land primarily used for *farming*—

- (a) that is—
 - (i) used in connection with *farming*; or
 - (ii) used primarily to store one or more *farm vehicles*; or
 - (iii) a combination of (i) and (ii); and
- (b) occupied neither frequently nor for extended periods by people; and
- (c) in which the total number of persons accommodated at any time does not exceed 2; and
- (d) with a total *floor area* of more than 500 m² but not more than 2000 m².

Farm vehicle means a vehicle used in connection with *farming*.

Finished ground level, for the purposes of [Part 3.2](#) in Volume Two, means the ground level adjacent to footing systems at the completion of construction and landscaping.

Fire brigade means a statutory authority constituted under an Act of Parliament having as one of its functions, the protection of life and property from fire and other emergencies.

Fire brigade station for the purposes of [E1.3\(a\)\(ii\)](#) and [H3.9](#) in Volume One, means a state or territory government operated premises which is a station for a *fire brigade*.

Fire compartment means—

- (a) the total space of a building; or
- (b) when referred to in—
 - (i) the *Performance Requirements* — any part of a building separated from the remainder by barriers to fire such as walls and/or floors having an appropriate resistance to the spread of fire with any openings adequately protected; or
 - (ii) the *Deemed-to-Satisfy Provisions* — any part of a building separated from the remainder by walls and/or floors each having an FRL not less than that *required* for a *fire wall* for that type of construction and where all openings in the separating construction are protected in accordance with the *Deemed-to-Satisfy Provisions* of the relevant Part.

Fire growth means the stage of fire development during which the *heat release rate* and the temperature of the fire are generally increasing.

Fire hazard means the danger in terms of potential harm and degree of exposure arising from the start and spread of fire and the smoke and gases that are thereby generated.

Fire hazard properties means the following properties of a material or assembly that indicate how they behave under specific fire test conditions:

Definitions

- (a) *Average specific extinction area*, *critical radiant flux* and *Flammability Index*, determined as defined in [Schedule 3](#).
- (b) *Smoke-Developed Index*, *smoke development rate* and *Spread-of-Flame Index*, determined in accordance with [Schedule 6](#).
- (c) *Group number* and *smoke growth rate index* (SMOGR_{RC}), determined in accordance with [Specification C1.10](#) of Volume One.

Fire intensity means the rate of release of calorific energy in watts, determined either theoretically or empirically, as applicable.

Fire-isolated passageway means a corridor, hallway or the like, of *fire-resisting construction*, which provides egress to or from a *fire-isolated stairway* or *fire-isolated ramp* or to a road or *open space*.

Fire-isolated ramp means a ramp within a *fire-resisting* enclosure which provides egress from a *storey*.

Fire-isolated stairway means a stairway within a *fire-resisting shaft* and includes the floor and roof or top enclosing structure.

Fire load means the sum of the net calorific values of the *combustible* contents which can reasonably be expected to burn within a *fire compartment*, including furnishings, built-in and removable materials, and building elements. The calorific values must be determined at the ambient moisture content or humidity. (The unit of measurement is MJ.)

Fire-protected timber means *fire-resisting* timber building elements that comply with Volume One [Specification C1.13a](#).

Fire-protective covering means—

- (a) 13 mm fire-protective grade plasterboard; or
- (b) 12 mm cellulose cement flat sheeting complying with AS/NZS 2908.2 or ISO 8336; or
- (c) 12 mm fibrous plaster reinforced with 13 mm x 13 mm x 0.7 mm galvanised steel wire mesh located not more than 6 mm from the exposed face; or
- (d) other material not less fire-protective than 13 mm fire-protective grade plasterboard, fixed in accordance with the normal trade practice for a *fire-protective covering*.

Fire-resistance level (FRL) means the grading periods in minutes determined in accordance with [Schedule 5](#), for the following criteria—

- (a) *structural adequacy*; and
- (b) *integrity*; and
- (c) *insulation*,

and expressed in that order.

Note:

A dash means that there is no requirement for that criterion. For example, 90/-/- means there is no requirement for an FRL for *integrity* and *insulation*, and -/-/- means there is no requirement for an FRL.

Fire-resisting, for the purposes of Volume One, applied to a building element, means having an FRL appropriate for that element.

Fire-resisting, for the purposes of Volume Two, applied to a *structural member* or other part of a building, means having the FRL *required* for that *structural member* or other part.

Fire-resisting construction, for the purposes of Volume One, means one of the Types of construction referred to in [Part C1](#) of Volume One.

Fire safety engineering means application of engineering principles, rules and *expert judgement* based on a scientific appreciation of the fire phenomenon, often using specific *design scenarios*, of the effects of fire and of the reaction and behaviour of people in order to—

- (a) save life, protect property and preserve the environment and heritage from destructive fire; and
- (b) quantify the hazards and risk of fire and its effects; and
- (c) mitigate fire damage by proper design, construction, arrangement and use of buildings, materials, structures, industrial processes and transportation systems; and
- (d) evaluate analytically the optimum protective and preventive measures, including design, installation and maintenance of active and passive fire and life safety systems, necessary to limit, within prescribed levels, the consequences of fire.

Fire safety system means one or any combination of the methods used in a building to

Definitions

- (a) warn people of an emergency; or
 - (b) provide for safe evacuation; or
 - (c) restrict the spread of fire; or
 - (d) extinguish a fire,
- and includes both active and passive systems.

Fire-source feature means—

- (a) the far boundary of a road, river, lake or the like adjoining the allotment; or
- (b) a side or rear boundary of the allotment; or
- (c) an *external wall* of another building on the allotment which is not a Class 10 building.

Fire wall means a wall with an appropriate resistance to the spread of fire that divides a *storey* or building into *fire compartments*.

Fixed wired, for the purposes of [Specification E2.2d](#) in Volume One, means a system of electrical wiring (either AC or DC), in which cables are fixed or supported in position.

Flammability Index means the index number as determined by AS 1530.2.

Flashing means a strip or sleeve of impervious material dressed, fitted or built-in to provide a barrier to moisture movement, or to divert the travel of moisture, or to cover a joint where water would otherwise penetrate to the interior of a building.

Flashover in relation to *fire hazard properties*, means a *heat release rate* of 1 MW.

Flight means that part of a stair that has a continuous series of *risers*, including *risers* of *winders*, not interrupted by a *landing* or floor (for Volume Two, see [Figure 4](#)).

Explanatory information for Volume Two:

A *flight* is the part of a stair that has a continuous slope created by the nosing line of treads. The length of a *flight* is limited to restrict the distance a person could fall down a stair. Quarter *landings*, as shown in [Figure 4](#), are considered sufficient to halt a person's fall and therefore are considered for the purposes of Volume Two not to be part of the *flight*.

Figure 4 Identification of stair flights — Plan view

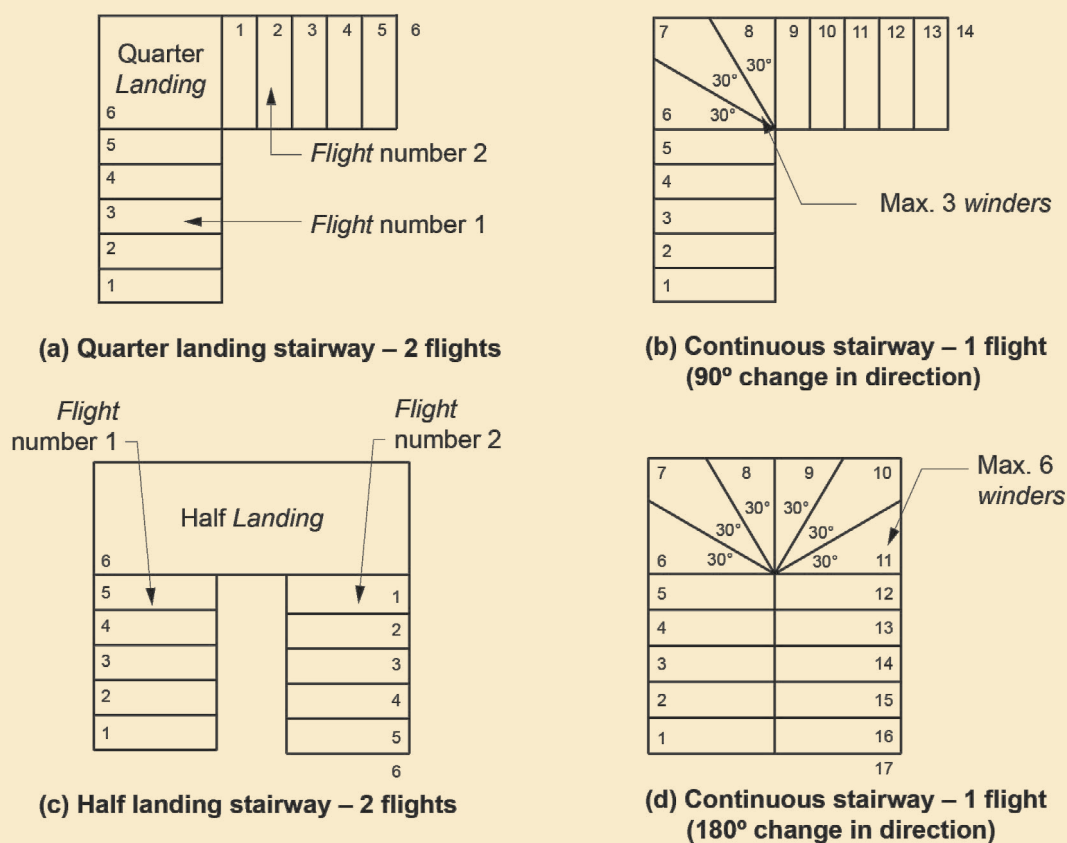

Flood hazard area means the *site* (whether or not mapped) encompassing land lower than the *flood hazard level* which has been determined by the *appropriate authority*.

State and Territory variations

For Volume One see (*Vic, Flood hazard area*)

For Volume Two see (*Vic, Flood hazard area*)

Flood hazard level (FHL) means the flood level used to determine the height of floors in a building and represents the *defined flood level* plus the *freeboard* (see *Figure 3*).

Floor area, for the purposes of Volume One, means—

- (a) in relation to a building — the total area of all *storeys*; and
- (b) in relation to a *storey* — the area of all floors of that *storey* measured over the enclosing walls, and includes—
 - (i) the area of a *mezzanine* within the *storey*, measured within the finished surfaces of any *external walls*; and
 - (ii) the area occupied by any *internal wall* or partitions, any cupboard, or other built-in furniture, fixture or fitting; and
 - (iii) if there is no enclosing wall, an area which has a use that—
 - (A) contributes to the *fire load*; or
 - (B) impacts on the safety, health or amenity of the occupants in relation to the provisions of the BCA; and
- (c) in relation to a room — the area of the room measured within the finished surfaces of the walls, and includes the area occupied by any cupboard or other built-in furniture, fixture or fitting; and
- (d) in relation to a *fire compartment* — the total area of all floors within the *fire compartment* measured within the finished surfaces of the bounding construction, and if there is no bounding construction, includes an area which has a use which contributes to the *fire load*; and
- (e) in relation to an *atrium* — the total area of all floors within the *atrium* measured within the finished surfaces of the bounding construction and if no bounding construction, within the *external walls*.

Definitions

Floor area, for the purposes of Volume Two, means in relation to a room, the area of the room measured within the finished surfaces of the walls, and includes the area occupied by any cupboard or other built-in furniture, fixture or fitting (see [Figure 5](#)).

Figure 5 Identification of floor area of a room

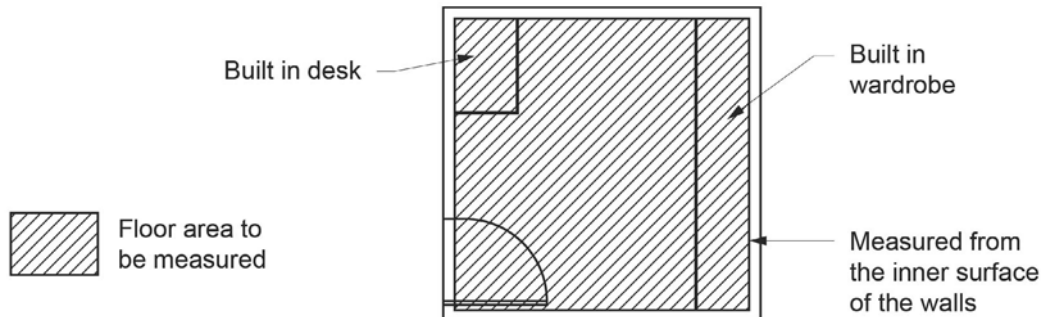

Foundation means the ground which supports the building (see [Figure 6](#)).

Figure 6 Identification of foundation

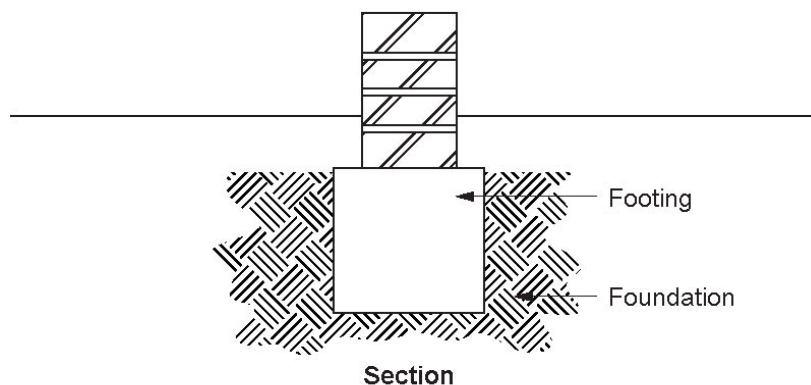

Fractional effective dose (FED) means the fraction of the dose (of thermal effects) that would render a person of average susceptibility incapable of escape.

Explanatory information:

The definition for *FED* has been modified from the ISO definition to be made specific for [Schedule 7](#). The use of CO or CO₂ as part of *FED* is not part of that [Verification Method](#). This is because the ability to measure CO in a repeatable test varies by two orders of magnitude for common cellulosic fuel.

Freeboard means the height above the [defined flood level](#) as determined by the [appropriate authority](#), used to compensate for effects such as wave action and localised hydraulic behaviour.

State and Territory variations

For Volume One see ([Vic, Freeboard](#))

For Volume Two see ([Vic, Freeboard](#))

Fully developed fire means the state of total involvement of the majority of available combustible materials in a fire.

Glazing, for the purposes of [Section J](#) in Volume One, means a transparent or translucent element and its supporting frame located in the [envelope](#), and includes a [window](#) other than a [roof light](#).

Glazing, for the purposes of [Part 2.6](#) and [Part 3.12](#) in Volume Two, means a transparent or translucent element and its supporting frame located in the external [fabric](#) of the building, and includes a [window](#) other than a [roof light](#).

Green Star means the building sustainability rating scheme managed by the Green Building Council of Australia.

Going means the horizontal dimension from the front to the back of a tread less any overhang from the next tread or [landing](#) above (see [Figure 3.9.1.4](#)).

Group number means the number of one of 4 groups of materials used in the regulation of [fire hazard properties](#) and

Definitions

applied to materials used as a finish, surface, lining, or attachment to a wall or ceiling.

Habitable room means a room used for normal domestic activities, and—

- (a) includes a bedroom, living room, lounge room, music room, television room, kitchen, dining room, sewing room, study, playroom, family room, home theatre and sunroom; but
- (b) excludes a bathroom, laundry, water closet, pantry, walk-in wardrobe, corridor, hallway, lobby, photographic darkroom, clothes-drying room, and other spaces of a specialised nature occupied neither frequently nor for extended periods.

Hazard Rating means a rating of either *Low Hazard*, *Medium Hazard* or *High Hazard* determined in accordance with [Specification B5.1](#) in Volume Three, for any *Deemed-to-Satisfy Solution*.

Health-care building means a building whose occupants or patients undergoing medical treatment generally need physical assistance to evacuate the building during an emergency and includes—

- (a) a public or private hospital; or
- (b) a nursing home or similar facility for sick or disabled persons needing full-time care; or
- (c) a clinic, day surgery or procedure unit where the effects of the predominant treatment administered involve patients becoming non-ambulatory and requiring supervised medical care on the premises for some time after the treatment.

Heated water means water that has been intentionally heated. It is normally referred to as hot water or warm water.

Heating load means the calculated amount of energy delivered to the heated spaces of the building annually by artificial means to maintain the desired temperatures in those spaces.

Heat release means the thermal energy produced by combustion (kJ).

Heat release rate (HRR) means the rate of thermal energy production generated by combustion (kW (preferred) or MW).

High Hazard means any condition, device or practice which, in connection with a water supply, has the potential to cause death.

High wind area means a region that is subject to *design wind speed* more than N3 or C1 (see [Table 3](#)).

Horizontal exit means a *required* doorway between 2 parts of a building separated from each other by a *fire wall*.

Hours of operation means the number of hours when the occupancy of the building is greater than 20% of the peak occupancy.

House energy rating software, for the purposes of Volume One, means software accredited under the Nationwide House Energy Rating Scheme.

House energy rating software, for the purposes of Volume Two—

- (a) applied to [V2.6.2.2](#)—means software accredited or previously accredited under the Nationwide House Energy Rating Scheme and the additional functionality provided in non-regulatory mode; and
- (b) applied to [3.12.0.1](#)—means software accredited under the Nationwide House Energy Rating Scheme.

Explanatory information:

The Nationwide House Energy Rating Scheme (NatHERS) refers to the Australian governments' scheme that facilitates consistent energy ratings from software tools which are used to assess the potential thermal efficiency of dwelling envelopes.

Housing Provisions means the requirements for Class 1 and 10 buildings contained in Volume Two of the National Construction Code as published by the Australian Building Codes Board.

Illuminance means the luminous flux falling onto a unit area of surface.

Illumination power density (W/m²) means the total of the power that will be consumed by the lights in a space, including any lamps, ballasts, current regulators and control devices other than those that are plugged into socket outlets for intermittent use such as floor standing lamps, desk lamps or work station lamps, divided by the area of the space.

Explanatory information:

- *Illumination power density* relates to the power consumed by the lighting system and includes the light source or luminaire and any control device. The power for the lighting system is the illumination power load. This approach is more complicated than the *lamp power density* approach but provides more flexibility for a dwelling with sophisticated control systems.
- The area of the space refers to the area the lights serve. This could be considered a single room, open plan space, verandah, balcony or the like, or the total area of all these spaces.

Inclined lift means a power-operated device for raising or lowering people within a carriage that has one or more rigid

Definitions

guides on an inclined plane.

Individual protection means the installation of a [backflow prevention device](#) at the point where a water service connects to a single fixture or appliance.

Insulation, in relation to an FRL, means the ability to maintain a temperature on the surface not exposed to the furnace below the limits specified in AS 1530.4.

Integrity, in relation to an FRL, means the ability to resist the passage of flames and hot gases specified in AS 1530.4.

Internal wall, for the purposes of Volume One, excludes a [common wall](#) or a party wall.

Internal wall, for the purposes of Volume Two, excludes a [separating wall](#), [common wall](#) or party wall.

Interstitial condensation means the [condensation](#) of moisture on surfaces between material layers inside the building component.

JAS-ANZ means the Joint Accreditation System of Australia and New Zealand.

Lamp power density (W/m²) means the total of the maximum power rating of the lamps in a space, other than those that are plugged into socket outlets for intermittent use such as floor standing lamps, desk lamps or work station lamps, divided by the area of the space.

Explanatory information:

- [Lamp power density](#) is a simple means of setting energy consumption at an efficient level for Class 1 and associated Class 10a buildings.
- Lamp refers to the globe or globes that are to be installed in a permanently wired light fitting. The maximum power of a lamp is usually marked on the fitting as the maximum allowable wattage.
- The area of the space refers to the area the lights serve. This could be considered a single room, open plan space, verandah, balcony or the like, or the total area of all these spaces.

Landing means an area at the top or bottom of a [flight](#) or between two [flights](#).

Latent heat gain means the heat gained by the vapourising of liquid without change of temperature.

Lightweight construction means construction which incorporates or comprises—

- (a) sheet or board material, plaster, render, sprayed application, or other material similarly susceptible to damage by impact, pressure or abrasion; or
- (b) concrete and concrete products containing pumice, perlite, vermiculite, or other soft material similarly susceptible to damage by impact, pressure or abrasion; or
- (c) masonry having a width of less than 70 mm.

Loadbearing means intended to resist vertical forces additional to those due to its own weight.

Loadbearing wall, for the purposes of [Part 3.2](#) in Volume Two, means any wall imposing on the footing a load greater than 10 kN/m.

Loss means either: physical damage, financial loss or loss of [amenity](#).

Low Hazard means any condition, device or practice which, in connection with a water supply, would constitute a nuisance by colour, odour or taste but does not have the potential to injure or endanger health.

Low rainfall intensity area means an area with a 5 minute rainfall intensity for an [average recurrence interval](#) of 20 years of not more than 125 mm/hour.

Explanatory information:

Rainfall intensity figures can be obtained from [Tables 3.5.3.1a to 3.5.3.1h](#) in Volume Two.

Low-rise, low-speed constant pressure lift means a power-operated low-rise, low-speed device for raising or lowering people with limited mobility on a carriage that is controlled by the application of constant pressure to a control.

Low-rise platform lift means a power-operated device for raising or lowering people with limited mobility on a platform, that is controlled automatically or by the application of constant pressure to a control.

Low voltage means a [voltage](#) exceeding [extra-low voltage](#), but not exceeding 1000 V AC or 1500 V DC.

Luminance contrast means the light reflected from one surface or component, compared to the light reflected from another surface or component.

Massive timber means an element not less than 75 mm thick as measured in each direction formed from solid and laminated timber.

Medium Hazard means any condition, device or practice which, in connection with a water supply, has the potential to injure or endanger health.

Minimum Energy Performance Standards (MEPS) means the Minimum Energy Performance Standards for equipment and appliances established through the Greenhouse and Energy Minimum Standards Act 2012.

Definitions

Mixed construction means a building consisting of more than one form of construction, particularly in double-storey buildings.

Mezzanine means an intermediate floor within a room.

Mould means a fungal growth that can be produced from conditions such as dampness, darkness, or poor ventilation.

NABERS Energy for Offices means the National Australia Built Environment Rating Systems for office energy efficiency, which is managed by the New South Wales Government.

Network Utility Operator means a person who—

- (a) undertakes the piped distribution of *drinking water* or *non-drinking water* for supply; or
- (b) is the operator of a sewerage system or a stormwater *drainage* system.

Explanatory information:

A *Network Utility Operator* in most States and Territories is the water and sewerage authority licensed to supply water and receive sewage and/or stormwater. The authority operates or proposes to operate a network that undertakes the distribution of water for supply and undertakes to receive sewage and/or stormwater drainage. This authority may be a licensed utility, local government body or council.

State and Territory variation

For Volume Three see (*Tas, Network Utility Operator*)

Non-combustible means—

- (a) applied to a material — not deemed *combustible* as determined by AS 1530.1 — Combustibility Tests for Materials; and
- (b) applied to construction or part of a building — constructed wholly of materials that are not deemed *combustible*.

Non-drinking water means water which is not *drinking water*.

Occupant traits, for the purposes of Volume One, means the features, needs and profile of the occupants in a *habitable room* or space.

Occupant traits, for the purposes of Volume Two, means the features, needs and profile of the occupants in a room or space.

Explanatory information:

This term is used to describe the characteristics of the occupants and their associated requirements in relation to a room or space.

For example, in relation to a bedroom, the following occupant characteristics and associated requirements should be considered:

- Characteristics: height, mobility and how often the space will be used.
- Requirements: a sleeping space and a space to undertake leisure activities.

Occupiable outdoor area means a space on a roof, balcony or similar part of a building—

- (a) that is open to the sky; and
- (b) to which access is provided, other than access only for maintenance; and
- (c) that is not *open space* or directly connected with *open space*.

On-site wastewater management system means a system installed on premises that receives and/or treats wastewater generated on the premises and applies the resulting effluent to an *approved disposal system* or re-use system.

State and Territory variation

For Volume Three see (*Tas, On-site wastewater management system*)

Open-deck carpark means a carpark in which all parts of the parking *storeys* are cross-ventilated by permanent unobstructed openings in not fewer than 2 opposite or approximately opposite sides, and—

- (a) each side that provides ventilation is not less than $\frac{1}{6}$ of the area of any other side; and
- (b) the openings are not less than $\frac{1}{2}$ of the wall area of the side concerned.

Open space means a space on the allotment, or a roof or similar part of a building adequately protected from fire, open to the sky and connected directly with a public road.

Open spectator stand means a tiered stand substantially open at the front.

Definitions

Other property means all or any of the following—

- (a) any building on the same or an adjoining allotment; and
- (b) any adjoining allotment; and
- (c) a road.

Outdoor air means air outside the building.

Outdoor air economy cycle is a mode of operation of an *air-conditioning* system that, when the *outdoor air* thermodynamic properties are favourable, increases the quantity of *outdoor air* used to condition the space.

Outfall means that part of the disposal system receiving *surface water* from the drainage system and may include a natural water course, kerb and channel, or soakage system.

Overflow devices means a device that provides relief to a water service, sanitary *plumbing* and *drainage* system, *rainwater harvesting system* or stormwater system to avoid the likelihood of *uncontrolled discharge*.

Panel wall means a non-*loadbearing external wall*, in frame or similar construction, that is wholly supported at each *storey*.

Patient care area means a part of a *health-care building* normally used for the treatment, care, accommodation, recreation, dining and holding of patients including a *ward area* and *treatment area*.

Performance-based design brief (PBDB) means the process and the associated report that defines the scope of work for the performance-based analysis, the technical basis for analysis, and the criteria for acceptance of any relevant *Performance Solution* as agreed by stakeholders.

Performance Requirement means a requirement which states the level of performance which a *Performance Solution* or *Deemed-to-Satisfy Solution* must meet.

Performance Solution means a method of complying with the *Performance Requirements* other than by a *Deemed-to-Satisfy Solution*.

Perimeter of building, for the purposes of *Part 3.6* in Volume Two, means the external envelope of a building.

Personal care services means any of the following:

- (a) The provision of nursing care.
- (b) Assistance or supervision in—
 - (i) bathing, showering or personal hygiene; or
 - (ii) toileting or continence management; or
 - (iii) dressing or undressing; or
 - (iv) consuming food.
- (c) The provision of direct physical assistance to a person with mobility problems.
- (d) The management of medication.
- (e) The provision of substantial rehabilitative or development assistance.

Piping, for the purposes of *Section J* in Volume One or *Part 3.12* in Volume Two, means an assembly of pipes, with or without valves or other fittings, connected together for the conveyance of liquids and gases.

Pliable building membrane means a water barrier as classified by AS/NZS 4200.1.

Plumbing means any water *plumbing*, roof *plumbing*, sanitary *plumbing* system or heating, ventilation and air-conditioning *plumbing*.

Plumbing or Drainage Solution means a solution which complies with the *Performance Requirements* and is a—

- (a) *Performance Solution*; or
- (b) *Deemed-to-Satisfy Solution*; or
- (c) combination of (a) and (b).

Point of connection —

- (a) for a *heated water* service means the point where the water heater connects to the cold water service downstream of the isolation valve; and
- (b) for sewage disposal means the point where the on-site *drainage* system connects to the *Network Utility Operator's* sewerage system or to an *on-site wastewater management system*; and
- (c) for stormwater disposal means the point where the on-site *drainage* system connects to the *Network Utility Operator's* stormwater system or to an *approved disposal system*; and
- (d) for a water service means the point where the service pipe within the premises connects to the *Network Utility Operator's* property service or to an alternative water supply system.

Definitions

Predicted Mean Vote (PMV) means the Predicted Mean Vote of the thermal perception of building occupants determined in accordance with ANSI/ASHRAE Standard 55.

Pressure vessel means a vessel subject to internal or external pressure. It includes interconnected parts and components, valves, gauges and other fittings up to the first point of connection to connecting piping, and—

- (a) includes fire heaters and gas cylinders; but
- (b) excludes—
 - (i) any vessel that falls within the definition of a *boiler*; and
 - (ii) storage tanks and equipment tanks intended for storing liquids where the pressure at the top of the tank is not exceeding 1.4 kPa above or 0.06 kPa below atmospheric pressure; and
 - (iii) domestic-type hot water supply heaters and tanks; and
 - (iv) pressure vessels installed for the purposes of fire suppression or which serve a fire suppression system.

Primary building element, for the purposes of Volume One, means a member of a building designed specifically to take part of the loads specified in [B1.2](#) and includes roof, ceiling, floor, stairway or ramp and wall framing members including bracing members designed for the specific purpose of acting as a brace to those members.

Primary building element, for the purposes of [Part 3.1.4](#) in Volume Two, means a member of a building designed specifically to take part of the building loads and includes roof, ceiling, floor, stairway or ramp and wall framing members including bracing members designed for the specific purpose of acting as a brace to those members.

Explanatory information:

The loads to which a building may be subjected are dead, live, wind, snow and earthquake loads. Further information on building loads can be found in the AS 1170 series of Standards.

State and Territory variation

For Volume Two see ([Qld, Primary building element](#))

Private bushfire shelter means a structure associated with, but not attached to, or part of a Class 1a dwelling that may, as a last resort, provide shelter for occupants from immediate life threatening effects of a bushfire.

Private garage, for the purposes of Volume One, means—

- (a) any garage associated with a Class 1 building; or
- (b) any single *storey* of a building of another Class containing not more than 3 vehicle spaces, if there is only one such *storey* in the building; or
- (c) any separate single *storey* garage associated with another building where such garage contains not more than 3 vehicle spaces.

Private garage, for the purposes of Volume Two, means—

- (a) any garage associated with a Class 1 building; or
- (b) any separate single *storey* garage associated with another building where such garage contains not more than 3 vehicle spaces.

Product means *plumbing* and *drainage* items within the scope of the PCA including but not limited to:

- (a) Materials, fixtures and components used in a *plumbing* or *drainage* installation.
- (b) Appliances and equipment connected to a *plumbing* or *drainage* system.

Product Technical Statement means a form of documentary evidence stating that the properties and performance of a building material, product or form of construction fulfil specific requirements of the NCC, and describes—

- (a) the application and intended use of the building material, product or form of construction: and
- (b) how the use of the building material, product or form of construction complies with the requirements of the NCC Volume One and Volume Two; and
- (c) any limitations and conditions of the use of the building material, product or form of construction relevant to (b).

Professional engineer means a person who is—

- (a) if legislation is applicable — a registered *professional engineer* in the relevant discipline who has appropriate experience and competence in the relevant field; or
- (b) if legislation is not applicable—

Definitions

- (i) registered in the relevant discipline on the National Engineering Register (NER) of the Institution of Engineers Australia (which trades as 'Engineers Australia'); or
- (ii) eligible to become registered on the Institution of Engineers Australia's NER and has appropriate experience and competence in the relevant field.

State and Territory variation

For Volume Three see (*Tas, Professional engineer*)

Public corridor means an enclosed corridor, hallway or the like which—

- (a) serves as a means of egress from 2 or more *sole-occupancy units* to a *required exit* from the *storey* concerned; or
- (b) is *required* to be provided as a means of egress from any part of a *storey* to a *required exit*.

R-Value (m².K/W) means the thermal resistance of a component calculated by dividing its thickness by its thermal conductivity.

Rapid roller door means a door that opens and closes at a speed of not less than 0.5 m/s.

Rainwater harvesting system means a *plumbing* installation that comprises—

- (a) any *plumbing* that connects a rainwater tank to any *drinking water* or *non-drinking water* outlets; and
- (b) any top-up line that conveys *drinking water* from a *Network Utility Operator's* water supply to a rainwater tank.

Recognised expert means a person with qualifications and experience in the area of *plumbing* or *drainage* in question recognised by the authority having jurisdiction.

Explanatory information:

A *recognised expert* is a person recognised by the authority having jurisdiction as qualified to provide evidence under *A5.3(5)*. Generally, this means a hydraulic consultant or engineer, however the specific requirements are determined by the authority having jurisdiction.

Under *A5.3(5)*, a report from a *recognised expert* may be used as evidence of suitability that a *product* listed on the *WaterMark Schedule of Excluded Products*, or a *plumbing* or *drainage* system, complies with a *Performance Requirement* or *Deemed-to-Satisfy Provision*.

State and Territory variation

For Volume Three see (*Tas, Recognised expert*)

Reference building, for the purposes of Volume One, means a hypothetical building that is used to calculate the maximum allowable *annual greenhouse gas emissions* and determine the *Thermal comfort level* for the proposed building.

Reference building, for the purposes of Volume Two, means a hypothetical building that is used to determine the maximum allowable *heating load* and *cooling load* for the proposed building.

Reflective insulation means a building membrane with a reflective surface such as a reflective foil laminate, reflective barrier, foil batt or the like capable of reducing radiant heat flow.

Explanatory information for Volume Two:

- (a) Typical *R-Values* achieved by adding *reflective insulation* are given in the explanatory information accompanying *Figures 3.12.1.1, 3.12.1.3 and 3.12.1.4*. Information on specific products may be obtained from *reflective insulation* manufacturers.
- (b) The surface of *reflective insulation* may be described in terms of its emittance (or infra-red emittance) or in terms of its reflectance (or solar reflectance). Generally, for the surface of a particular *reflective insulation* –
- (c) emittance + reflectance = 1.
- (d) Some types of *reflective insulation* may also serve the purposes of waterproofing or vapour proofing.

Regulated energy means the energy consumed by a building's *services* minus the amount of *renewable energy* generated and used on *site*.

Reinforced masonry means masonry reinforced with steel reinforcement that is placed in a bed joint or grouted into a core to strengthen the masonry.

Renewable energy means energy that is derived from sources that are regenerated, replenished, or for all practical purposes cannot be depleted and the energy sources include, but are not limited to, solar, wind, hydroelectric, wave action and geothermal.

Required means *required* to satisfy a *Performance Requirement* or a *Deemed-to-Satisfy Provision* of the NCC as

Definitions

appropriate.

Required safe egress time (RSET) means the time required for safe evacuation of occupants to a place of safety prior to the onset of untenable conditions.

Residential aged care building means a Class 3 or 9a building whose residents, due to their incapacity associated with the ageing process, are provided with physical assistance in conducting their daily activities and to evacuate the building during an emergency.

Residential care building means a Class 3, 9a or 9c building which is a place of residence where 10% or more of persons who reside there need physical assistance in conducting their daily activities and to evacuate the building during an emergency (including any *aged care building* or *residential aged care building*) but does not include a hospital.

Resident use area means part of a Class 9c building normally used by residents, and—

- (a) includes *sole-occupancy units*, lounges, dining areas, activity rooms and the like; but
- (b) excludes offices, storage areas, commercial kitchens, commercial laundries and other spaces not for the use of residents.

Resistance to the incipient spread of fire, in relation to a ceiling membrane, means the ability of the membrane to insulate the space between the ceiling and roof, or ceiling and floor above, so as to limit the temperature rise of materials in this space to a level which will not permit the rapid and general spread of fire throughout the space.

Explanatory information:

Resistance to the incipient spread of fire refers to the ability of a ceiling to prevent the spread of fire and thermally insulate the space between the ceiling and the roof or floor above. “*Resistance to the incipient spread of fire*” is superior to “fire-resistance” because it requires a higher standard of heat insulation.

The definition is used in Volume Two for separating floors/ceilings for a Class 1a dwelling located above a non-appurtenant *private garage*.

Rise in storeys means the greatest number of *storeys* calculated in accordance with [C1.2 of Volume One](#).

Riser means the height between consecutive treads and between each *landing* and continuous tread.

Roof light, for the purposes of [Section J](#) and [Part F4](#) in Volume One, and [Parts 2.6, 3.8.4 and 3.12](#) in Volume Two, means a skylight, *window* or the like installed in a roof—

- (a) to permit natural light to enter the room below; and
- (b) at an angle between 0 and 70 degrees measured from the horizontal plane.

Rolled fill means material placed in layers and compacted by repeated rolling by an excavator.

Safe place means—

- (a) a place of safety within a building—
 - (i) which is not under threat from a fire; and
 - (ii) from which people must be able to safely disperse after escaping the effects of an emergency to a road or *open space*; or
- (b) a road or *open space*.

Sanitary compartment means a room or space containing a closet pan or urinal (see [Figure 7](#)).

Figure 7 Identification of a sanitary compartment

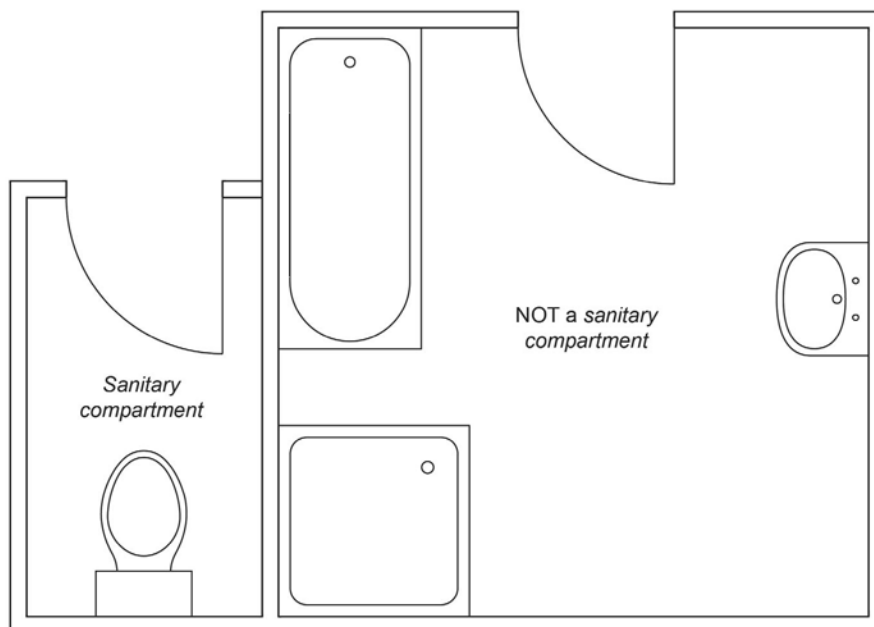
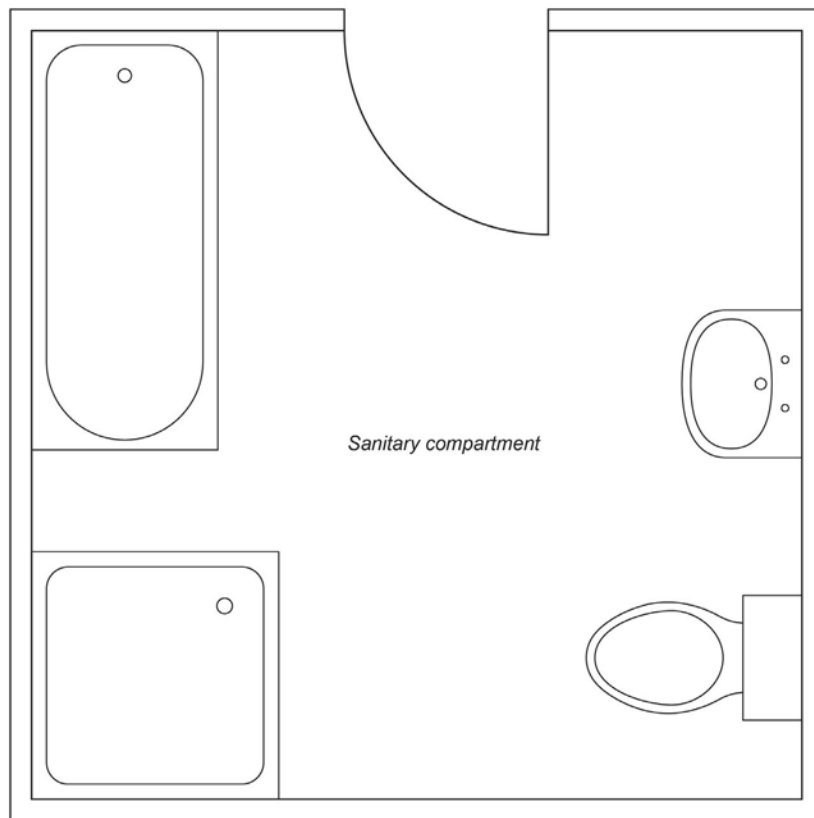

Sarking-type material means a material such as a *reflective insulation* or other flexible membrane of a type normally used for a purpose such as waterproofing, vapour management or thermal reflectance.

School includes a primary or secondary *school*, college, university or similar educational establishment.

Self-closing, for the purposes of Volume One, applied to a door, means equipped with a device which returns the door to the fully closed position immediately after each opening.

Self-closing, for the purposes of Volume Two, applied to a door or *window*, means equipped with a device which returns the door or *window* to the fully closed and latched position immediately after each manual opening.

Definitions

Sensible heat gain means the heat gained which causes a change in temperature

Separating element means a barrier that exhibits fire *integrity*, *structural adequacy*, *insulation*, or a combination of these for a period of time under specified conditions (often in accordance with AS 1530.4).

Separating wall means a wall that is common to adjoining Class 1 buildings (see [Figure 8](#)).

Figure 8 Separating wall

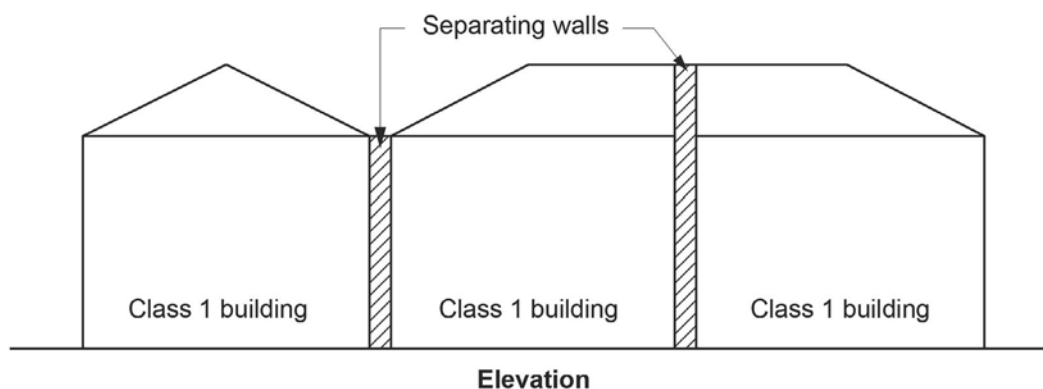

Note:

In Volume Two may also be known as a party wall and typically is *required* to be *fire-resisting* construction (see [Parts 3.7.2](#) and [3.7.3](#)).

Service, for the purposes of [Section J](#) in Volume One, means a mechanical or electrical system that uses energy to provide *air-conditioning*, mechanical ventilation, heated water supply, artificial lighting, vertical transport and the like within a building, but which does not include—

- (a) systems used solely for emergency purposes; and
- (b) cooking facilities; and
- (c) portable appliances.

Service station means a garage which is not a *private garage* and is for the servicing of vehicles, other than only washing, cleaning or polishing.

Shaft means the walls and other parts of a building bounding—

- (a) a well, other than an *atrium well*; or
- (b) a vertical chute, duct or similar passage, but not a chimney or flue.

Shower area means the area affected by water from a shower, including a shower over a bath.

Single leaf masonry means outer walls constructed with a single thickness of masonry unit.

Site means the part of the allotment of land on which a building stands or is to be erected.

Sitework means work on or around a *site*, including earthworks, preparatory to or associated with the construction, *alteration*, demolition or removal of a building.

Small-scale Technology Certificate means a certificate issued under the Commonwealth Government's Small-scale Renewable Energy Scheme.

Small-sized, low-speed automatic lift means a restricted use power-operated device for the infrequent raising or lowering of people with limited mobility on a platform that is controlled automatically but has the capability of being electrically isolated by a key-lockable control.

Smoke-and-heat vent means a vent, located in or near the roof for smoke and hot gases to escape if there is a fire in the building.

Smoke-Developed Index means the index number for smoke as determined by AS/NZS 1530.3.

Smoke development rate means the development rate for smoke as determined by testing flooring materials in accordance with AS ISO 9239.1.

Smoke growth rate index (SMOGR_{RC}) means the index number for smoke used in the regulation of *fire hazard properties* and applied to materials used as a finish, surface, lining or attachment to a wall or ceiling.

Definitions

Solar admittance means the fraction of incident irradiance on a *wall-glazing construction* that adds heat to a building's space.

Sole-occupancy unit means a room or other part of a building for occupation by one or joint owner, lessee, tenant, or other occupier to the exclusion of any other owner, lessee, tenant, or other occupier and includes—

- (a) a dwelling; or
- (b) a room or suite of rooms in a Class 3 building which includes sleeping facilities; or
- (c) a room or suite of associated rooms in a Class 5, 6, 7, 8 or 9 building; or
- (d) a room or suite of associated rooms in a Class 9c building, which includes sleeping facilities and any area for the exclusive use of a resident.

Spandrel panel, for the purposes of [Section J](#) of Volume One, means the opaque part of a façade in curtain wall construction which is commonly adjacent to, and integrated with, *glazing*.

Spiral stairway means a stairway with a circular plan, winding around a central post with steps that radiate from a common centre or several radii (see [Figures 3.9.1.2\(a\)](#) and [\(b\)](#)).

Spread-of-Flame Index means the index number for spread of flame as determined by AS/NZS 1530.3.

Sprinkler alarm switch, for the purposes of [Specification E2.2d](#) of Volume One, means a device capable of sending an electrical signal to activate an alarm when a residential sprinkler head is activated (e.g. a flow switch).

Stage means a floor or platform in a Class 9b building on which performances are presented before an audience.

Stairway platform lift means a power-operated device for raising or lowering people with limited mobility on a platform (with or without a chair) in the direction of a stairway.

Standard Fire Test means the Fire-resistance Tests of Elements of Building Construction as described in AS 1530.4.

Storey means a space within a building which is situated between one floor level and the floor level next above, or if there is no floor above, the ceiling or roof above, but not—

- (a) a space that contains only—
 - (i) a lift *shaft*, stairway or meter room; or
 - (ii) a bathroom, shower room, laundry, water closet, or other *sanitary compartment*; or
 - (iii) accommodation intended for not more than 3 vehicles; or
 - (iv) a combination of the above; or
- (b) a *mezzanine*.

Structural adequacy, in relation to an FRL, means the ability to maintain stability and adequate *loadbearing* capacity as determined by AS 1530.4.

Structural member means a component or part of an assembly which provides vertical or lateral support to a building or structure.

Surface water means all naturally occurring water, other than sub-*surface water*, which results from rainfall on or around the *site* or water flowing onto the *site*.

Swimming pool means any excavation or structure containing water and principally used, or that is designed, manufactured or adapted to be principally used for swimming, wading, paddling, or the like, including a bathing or wading pool, or spa.

Tapered tread means a stair tread with a walking area that grows smaller towards one end.

Thermal comfort level means the level of thermal comfort in a building expressed as a *PMV* sensation scale.

Total R-Value (m².K/W), for the purposes of Volume One, means the sum of the *R-Values* of the individual component layers in a composite element including any building material, insulating material, airspace, thermal bridging and associated surface resistances.

Total R-Value (m².K/W), for the purposes of Volume Two, means the sum of the *R-Values* of the individual component layers in a composite element including any building material, insulating material, airspace and associated surface resistances.

Total System Solar Heat Gain Coefficient (SHGC), for the purposes of Volume One, means the fraction of incident irradiance on a *wall-glazing construction* or a *roof light* that adds heat to a building's space.

Total System Solar Heat Gain Coefficient (SHGC), for the purposes of Volume Two, means the fraction of incident irradiance on *glazing* or a *roof light* that adds heat to a building's space.

Total System U-Value (W/m².K), for the purposes of Volume One, means the thermal transmittance of the composite element allowing for the effect of any airspaces, thermal bridging and associated surface resistances.

Total System U-Value (W/m².K), for the purposes of Volume Two, means the thermal transmittance of the composite element allowing for the effect of any airspaces and associated surface resistances.

Definitions

Treatment area means an area within a *patient care area* such as an operating theatre and rooms used for recovery, minor procedures, resuscitation, intensive care and coronary care from which a patient may not be readily moved.

Uncontrolled discharge means any unintentional release of fluid from a *plumbing* and *drainage* system and includes leakage and seepage.

Unique wall, for the purposes of *FV1.1* in Volume One and *V2.2.1* in Volume Two, means a wall which is neither a *cavity wall* nor a *direct fix cladding wall*.

Unobstructed opening, for the purposes of *Part 3.6* in Volume Two, means a glazed area that a person could mistake for an open doorway or clearway and walk into the glazed panel.

Unreinforced masonry means masonry that is not reinforced.

Vapour pressure means the pressure at which water vapour is in thermodynamic equilibrium with its condensed state.

Ventilation opening means an opening in the *external wall*, floor or roof of a building designed to allow air movement into or out of the building by natural means including a permanent opening, an openable part of a *window*, a door or other device which can be held open.

Verification Method means a test, inspection, calculation or other method that determines whether a *Performance Solution* complies with the relevant *Performance Requirements*.

Vessel, for the purposes of Volume One and *Part 3.8.1* in Volume Two, means an open, pre-formed, pre-finished concave receptacle capable of holding water, usually for the purpose of washing, including a basin, sink, bath, laundry tub and the like.

Visibility means the maximum distance at which an object of defined size, brightness and contrast can be seen and recognised.

Voltage means a difference of potential, measured in Volts (V) and includes *extra-low voltage* and *low voltage*.

Waffle raft means a stiffened raft with closely spaced ribs constructed on the ground and with slab panels supported between ribs.

Wall-glazing construction, for the purposes of *Section J* in Volume One, means the combination of wall and *glazing* components comprising the *envelope* of a building, excluding—

- (a) *display glazing*; and
- (b) opaque non-glazed openings such as doors, vents, penetrations and shutters.

Ward area means that part of a *patient care area* for resident patients and may contain areas for accommodation, sleeping, associated living and nursing facilities.

Water control layer means a *pliable building membrane* or the exterior cladding when no *pliable building membrane* is present.

WaterMark Conformity Assessment Body (WMCAB) means a conformity assessment body registered with and accredited by the *JAS-ANZ* to conduct evaluations leading to *product* certification and contracted with the *administering body* to issue the *WaterMark Licence*.

WaterMark Certification Scheme means the ABCB scheme for certifying and authorising *plumbing* and *drainage products*.

WaterMark Licence means a licence issued by a *WaterMark Conformity Assessment Body*.

WaterMark Schedule of Excluded Products means the list maintained by the *administering body* of *products* excluded from the *WaterMark Certification Scheme*.

WaterMark Schedule of Products means the list maintained by the *administering body* of *products* included in the *WaterMark Certification Scheme*, and the specifications to which the *products* can be certified.

Explanatory Information:

The *WaterMark Schedule of Products* and the *WaterMark Schedule of Excluded Products* can be viewed on the ABCB website at www.abcb.gov.au.

Waterproof means the property of a material that does not allow moisture to penetrate through it.

Water resistant means the property of a system or material that restricts moisture movement and will not degrade under conditions of moisture.

Water sensitive materials means materials that have an inherent capacity to absorb water vapour and include timber, plasterboard, plywood, oriented strand board and the like.

Watertight means will not allow water to pass from the inside to the outside of the component or joint and vice versa.

Wet area means an area within a building supplied with water from a water supply system, which includes bathrooms, showers, laundries and *sanitary compartments* and excludes kitchens, bar areas, kitchenettes or domestic food and beverage preparation areas.

Definitions

Winders means treads within a straight *flight* that are used to change direction of the stair (see [Figure 4](#)).

Window includes a *roof light*, glass panel, glass block or brick, glass louvre, glazed sash, glazed door, or other device which transmits natural light directly from outside a building to the room concerned when in the closed position.

Yield means the mass of a combustion product generated during combustion divided by the mass loss of the test specimen as specified in the *design fire*.

Zone protection means the installation of a *backflow prevention device* at the point where a water service is connected to multiple fixtures or appliances, with no *backflow prevention device* installed as *individual protection* downstream of this point.

Referenced documents

Schedule 4 Referenced documents

Schedule 4 Referenced documents

Schedule 4 Referenced documents

Schedule of referenced documents

State and Territory variations for Volume One—Schedule of referenced documents

State and Territory variations for Volume Two—Schedule of referenced documents

State and Territory variations for Volume Three—Schedule of referenced documents

Referenced documents

Schedule 4 Referenced documents

Schedule of referenced documents

The Standards and other documents listed in [Schedule 4](#) are referred to in the NCC.

Table 1 Schedule of referenced documents

No.	Date	Title	Volume One	Volume Two	Volume Three
AS/NZS ISO 717 Part 1	2004	Acoustics — Rating of sound insulation in buildings and of building elements — Airborne sound insulation See Note 1	FV5.1 , FV5.2 , FV5.3 , FV5.4 , F5.2	V2.4.6 , 3.8.6.3	N/A
AS ISO 717 Part 2	2004	Acoustics — Rating of sound insulation in buildings and of building elements — Impact sound insulation	FV5.1 , FV5.3 , F5.3	N/A	N/A
AS 1056 Part 1	1991	Storage water heaters — General requirements (incorporating amendments 1, 2, 3, 4 and 5)	N/A	N/A	B2.2
AS/NZS 1170 Part 0	2002	Structural design actions — General principles (incorporating amendments 1, 3 and 4)	BV1 , B1.1 , Spec B1.2	V2.1.1 , 3.0.2 , 3.5.1.0	N/A
AS/NZS 1170 Part 1	2002	Structural design actions — Permanent, imposed and other actions (incorporating amendments 1 and 2)	B1.2	3.0.3 , 3.0.4 , 3.9.1.2 , 3.9.1.3 , 3.9.2 , 3.9.2.3 ,	N/A
AS/NZS 1170 Part 2	2011	Structural design actions — Wind actions (incorporating amendments 1, 2, 3, 4 and 5)	B1.2 , B1.4 , Spec B1.2 , FV1.1 , Schedule 3	V2.2.1 , 3.0.3 , 3.5.1.0 , Schedule 3	Schedule 3
AS/NZS 1170 Part 3	2003	Structural design actions — Snow and ice actions (incorporating amendments 1 and 2)	B1.2 , Schedule 3	3.0.3 , Schedule 3	Schedule 3
AS 1170 Part 4	2007	Structural design actions — Earthquake actions in Australia (incorporating amendments 1 and 2)	B1.2	3.0.3 , 3.3.5.1 , 3.3.6.1 , 3.4.4.1 , 3.10.2.0	N/A
AS 1191	2002	Acoustics — Method for laboratory measurement of airborne sound transmission insulation of building elements	Spec F5.5	N/A	N/A
AS 1273	1991	Unplasticized PVC (UPVC) downpipe and fittings for rainwater	N/A	3.5.3.2	N/A
AS 1288	2006	Glass in buildings — Selection and	B1.4 , Spec C2.5 , Spec C3.4	3.6.0 , 3.6.1 , 3.6.3 ,	N/A

Referenced documents

No.	Date	Title	Volume One	Volume Two	Volume Three
		installation (incorporating amendments 1, 2 and 3)			
AS 1289.6.3.3	1997	Methods of testing soils for engineering purposes — Method 6.3.3: Soil strength and consolidation tests — Determination of the penetration resistance of a soil — Perth sand penetrometer test (incorporating amendment 1)	N/A	3.2.2.2	N/A
AS 1397	2011	Continuous hot-dip metallic coated steel sheet and strip — Coatings of zinc and zinc alloyed with aluminium and magnesium (incorporating amendment 1)	N/A	3.5.1.2	N/A
AS 1428 Part 1	2009	Design for access and mobility — General requirements for access — New building work (incorporating amendments 1 and 2)	D2.10 , D2.15 , D2.17 , D3.1 , D3.2 , D3.3 , D3.6 , D3.9 , D3.10 , D3.12 , Spec D3.10 , E3.8 , F2.4 , G4.5 , Schedule 3	Schedule 3	Schedule 3 , E1.2
AS 1428 Part 1	2001	Design for access and mobility — General requirements for access — New building work	H2.7 , H2.8 , H2.10 , H2.15	N/A	E1.2
AS 1428 Part 1 (Supplement 1)	1993	Design for access and mobility — General requirements for access — Buildings — Commentary	H2.2	N/A	N/A
AS 1428 Part 2	1992	Design for access and mobility — Enhanced and additional requirements — Buildings and facilities	H2.2 , H2.3 , H2.4 , H2.5 , H2.7 , H2.10 , H2.11 , H2.12 , H2.13 , H2.14	N/A	E1.2
AS 1428 Part 4	1992	Design for access and mobility — Tactile ground surface indicators for the orientation of people with vision impairment	H2.11	N/A	N/A
AS/NZS 1428 Part 4.1	2009	Design for access and mobility — Means to assist the orientation of people with vision impairment — Tactile ground surface indicators (incorporating	D3.8	N/A	N/A

Referenced documents

No.	Date	Title	Volume One	Volume Two	Volume Three
		amendments 1 and 2)			
AS 1530 Part 1	1994	Methods for fire tests on building materials, components and structures — Combustibility test for materials See Note 2	Schedule 3	Schedule 3	Schedule 3
AS 1530 Part 2	1993	Methods for fire tests on building materials, components and structures — Test for flammability of materials (incorporating amendment 1) See Note 2	Schedule 3	Schedule 3	Schedule 3
AS/NZS 1530 Part 3	1999	Methods for fire tests on building materials, components and structures — Simultaneous determination of ignitability, flame propagation, heat release and smoke release	Schedule 3 , Schedule 6	Schedule 3 , Schedule 6	Schedule 3 , Schedule 6
AS 1530 Part 4	2014	Methods for fire tests on building materials, components and structures — Fire-resistance tests for elements of construction See Note 2	A5.6 , C3.15 , C3.16 , Spec C1.13 , Spec C1.13a , Spec C3.15 , Spec D1.12 , Schedule 3 , Schedule 6	A5.6 , 3.7.3.3 , Schedule 3 , Schedule 6	A5.6 , Schedule 3 , Schedule 6
AS 1562 Part 1	2018	Design and installation of sheet roof and wall cladding — Metal See Note 3	B1.4 , F1.5	3.5.1.0 , 3.5.5.0	N/A
AS/NZS 1562 Part 2	1999	Design and installation of sheet roof and wall cladding — Corrugated fibre-reinforced cement	F1.5	N/A	N/A
AS/NZS 1562 Part 3	1996	Design and installation of sheet roof and wall cladding — Plastic	B1.4 , F1.5	3.5.1.0	N/A
AS 1657	2018	Fixed platforms, walkways, stairways and ladders — Design, construction and installation	D1.16 , D1.17 , D2.18 , H1.6 , H3.5	N/A	N/A
AS/NZS 1664 Part 1	1997	Aluminium structures — Limit state design (incorporating amendment 1)	B1.4	3.0.4	N/A
AS/NZS 1664 Part 2	1997	Aluminium structures — Allowable stress design (incorporating	B1.4	3.0.4	N/A

Referenced documents

No.	Date	Title	Volume One	Volume Two	Volume Three
		amendment 1)			
AS 1668 Part 1	2015	The use of ventilation and air conditioning in buildings — Fire and smoke control in buildings (incorporating amendment 1)	C2.12, C3.15, Spec C2.5, D1.7, Spec E1.8, E2.2, E2.3, F4.12, Spec E2.2b, Spec G3.8	N/A	N/A
AS 1668 Part 2	2012	The use of ventilation and airconditioning in buildings — Mechanical ventilation in buildings (incorporating amendments 1 and 2)	E2.3, FV4.1, F4.5, F4.11, F4.12, J5.3	V2.4.5, 3.8.5.0	N/A
AS 1668 Part 4	2012	The use of ventilation and airconditioning in buildings — Natural ventilation of buildings	F4.11	N/A	N/A
AS 1670 Part 1	2018	Fire detection, warning, control and intercom systems — System design, installation and commissioning — Fire See Note 4	C3.5, C3.6, C3.7, C3.8, C3.11, D2.21, E2.3, G4.8, Spec C3.4, E2.2, Spec E2.2a, Spec E2.2d, Spec G3.8	3.7.5.2, 3.7.5.6	N/A
AS 1670 Part 3	2018	Fire detection, warning, control and intercom systems — System design, installation and commissioning — Fire alarm monitoring See Note 4	Spec E2.2a, Spec E2.2d	N/A	N/A
AS 1670 Part 4	2018	Fire detection, warning, control and intercom systems — System design, installation and commissioning — Emergency warning and intercom systems See Note 4	EV3.2, E4.9, Spec G3.8	N/A	N/A
AS/NZS 1680 Part 0	2009	Interior lighting — Safe movement	F4.4	3.8.4.3	N/A
AS 1684 Part 2	2010	Residential timber-framed construction — Non-cyclonic areas (incorporating amendments 1 and 2)	B1.4, B1.5, F1.12	3.0.5, 3.2.5.6, 3.4.0.2, 3.4.1.2, 3.4.3.0, 3.5.4.2, 3.5.4.3, 3.5.4.4	N/A
AS 1684 Part 3	2010	Residential timber-framed construction — Cyclonic areas (incorporating amendment 1)	B1.4, B1.5, F1.12	3.0.5, 3.2.5.6, 3.4.0.2, 3.4.1.2, 3.4.3.0, 3.5.4.2, 3.5.4.3, 3.5.4.4	N/A
AS 1684 Part 4	2010	Residential timber-framed construction — Simplified — Non-cyclonic areas (incorporating amendment 1)	B1.4, B1.5, F1.12	3.0.5, 3.2.5.6, 3.4.0.2, 3.4.1.2, 3.4.3.0, 3.5.4.2, 3.5.4.3, 3.5.4.4	N/A

Referenced documents

No.	Date	Title	Volume One	Volume Two	Volume Three
AS 1720 Part 1	2010	Timber structures — Design methods (incorporating amendments 1, 2 and 3)	BV1, B1.4	V2.1.1, 3.4.3.0	N/A
AS 1720 Part 4	2006	Timber structures — Fire resistance for structural adequacy of timber members	Schedule 5	Schedule 5	Schedule 5
AS 1720 Part 5	2015	Timber structures — Nailplated timber roof trusses	B1.4	3.4.3.0	N/A
AS 1735 Part 11	1986	Lifts, escalators and moving walks — Fire-rated landing doors	C3.10	N/A	N/A
AS 1735 Part 12	1999	Lifts, escalators and moving walks — Facilities for persons with disabilities (incorporating amendment 1)	E3.6, H2.6	N/A	N/A
AS/NZS 1859 Part 4	2018	Reconstituted wood-based panels — Specifications — Wet process fibreboard See Note 5	N/A	3.5.4.3, 3.5.4.4	N/A
AS 1860 Part 2	2006	Particleboard flooring — Installation (incorporating amendment 1)	B1.4	3.4.3.0	N/A
AS 1905 Part 1	2015	Components for the protection of openings in fire-resistant walls — Fire-resistant doorsets (incorporating amendment 1)	C3.6, Spec C3.4	N/A	N/A
AS 1905 Part 2	2005	Components for the protection of openings in fire-resistant walls — Fire-resistant roller shutters	Spec C3.4	N/A	N/A
AS 1926 Part 1	2012	Swimming pool safety — Safety barriers for swimming pools	G1.1, G1.3	3.10.1.0	N/A
AS 1926 Part 2	2007	Swimming pool safety — Location of safety barriers for swimming pools (incorporating amendments 1 and 2)	G1.1	3.10.1.0	N/A
AS 1926 Part 3	2010	Swimming pool safety — Water recirculation systems (incorporating amendment 1)	G1.1	3.10.1.0	N/A
AS 2047	2014	Windows and external glazed doors in buildings (incorporating amendments 1 and 2) See Note 6	B1.4, FV1.1, F1.13, J3.4	V2.2.1, 3.6.0, 3.6.1, 3.12.3.3	N/A

Referenced documents

No.	Date	Title	Volume One	Volume Two	Volume Three
AS 2049	2002	Roof tiles (incorporating amendment 1)	F1.5	3.5.2.1	N/A
AS 2050	2018	Installation of roof tiles	B1.4, F1.5	3.5.2.0, 3.5.2.2	N/A
AS 2118 Part 1	2017	Automatic fire sprinkler systems — General systems (incorporating amendment 1)	CV3, E1.3, Spec E1.5, Spec E1.5a	N/A	N/A
AS 2118 Part 4	2012	Automatic fire sprinkler systems — Sprinkler protection for accommodation buildings not exceeding four storeys in height	E1.3, Spec E1.5, Spec E1.5a	N/A	N/A
AS 2118 Part 6	2012	Automatic fire sprinkler systems — Combined sprinkler and hydrant systems in multistorey buildings	E1.3, Spec E1.5	N/A	N/A
AS 2159	2009	Piling — Design and installation (incorporating amendment 1)	B1.4	3.2.0	N/A
AS/NZS 2179 Part 1	2014	Specifications for rainwater goods, accessories and fasteners — Metal shape or sheet rainwater goods, and metal accessories and fasteners	N/A	3.5.3.2	N/A
AS/NZS 2269 Part 0	2012	Plywood — Structural — Specifications (incorporating amendment 1)	N/A	3.5.4.4	N/A
AS/NZS 2293 Part 1	2018	Emergency lighting and exit signs for buildings — System design, installation and operation	E4.4, E4.8, Spec E4.8, H3.15	N/A	N/A
AS/NZS 2327	2017	Composite structures — Composite steel-concrete construction in buildings	B1.4, Schedule 5	3.0.4, Schedule 5	Schedule 5
AS 2419 Part 1	2005	Fire hydrant installations — System design, installation and commissioning (incorporating amendment 1)	C2.12, E1.3, Spec E1.5a, H3.9	N/A	N/A
AS 2441	2005	Installation of fire hose reels (incorporating amendment 1)	E1.4	N/A	N/A
AS 2444	2001	Portable fire extinguishers and fire blankets — Selection and location	E1.6, H3.11	N/A	N/A
AS 2665	2001	Smoke/heat venting	Spec E2.2c, Spec	N/A	N/A

Referenced documents

No.	Date	Title	Volume One	Volume Two	Volume Three
		systems — Design, installation and commissioning	G3.8		
AS/NZS 2699 Part 1	2000	Built-in components for masonry construction — Wall ties	N/A	3.3.5.10	N/A
AS/NZS 2699 Part 3	2002	Built-in components for masonry construction — Lintels and shelf angles (durability requirements)	N/A	3.3.5.12	N/A
AS 2870	2011	Residential slabs and footings	F1.10	3.1.1.0, 3.1.3.4, 3.1.4.4, 3.2.0, 3.2.1, 3.2.2.4, 3.2.2.6, 3.2.3.2, 3.2.4.1, 3.2.5, 3.2.5.2, 3.2.5.6	N/A
AS/NZS 2890 Part 6	2009	Parking facilities — Off-street parking for people with disabilities	D3.5	N/A	N/A
AS/NZS 2904	1995	Damp-proof courses and flashings (incorporating amendments 1 and 2)	F1.9	3.3.5.7, 3.5.4.6, 3.10.6.3	N/A
AS/NZS 2908 Part 1	2000	Cellulose-cement products — Corrugated sheets	B1.4, F1.5	N/A	N/A
AS/NZS 2908 Part 2	2000	Cellulose-cement products — Flat sheets	Schedule 3	3.5.4.3, 3.5.4.4, 3.5.4.5, Schedule 3	Schedule 3
AS/NZS 2918	2018	Domestic solid fuel burning appliances — Installation See Note 11	G2.2	3.10.7.0, 3.10.7.4, 3.10.7.5	N/A
AS/NZS 3013	2005	Electrical installations — Classification of the fire and mechanical performance of wiring system elements	C2.13	N/A	N/A
AS/NZS 3500 Part 0	2003	Plumbing and drainage — Glossary of terms	A1.0	A1.0	A1.0
AS/NZS 3500 Part 1	2018	Plumbing and drainage — Water services	N/A	N/A	B1.4, B3.3, B4.2, B5.2, B5.3, B5.4, BS5.1.2, B6.4, B6.5,
AS/NZS 3500 Part 2	2018	Plumbing and drainage — Sanitary plumbing and drainage	N/A	N/A	C1.3, CV2.2, C2.3, C2.4,
AS/NZS 3500 Part 3	2018	Plumbing and drainage — Stormwater drainage	F1.1	3.1.3.0, 3.1.3.4, 3.5.3.0, 3.5.3.3, 3.5.3.5	N/A
AS/NZS 3500 Part 4	2018	Plumbing and drainage — Heated water services (incorporating amendment 1)	N/A	N/A	B2.2, B2.6, B2.7, B2.8, B2.9
AS 3600	2018	Concrete structures (incorporating	BV1, B1.4, Schedule 5	V2.1.1, 3.0.4, 3.1.4.4, 3.2.2.4,	Schedule 5

Referenced documents

No.	Date	Title	Volume One	Volume Two	Volume Three
		amendment 1)		3.2.3.1, 3.2.5.6, Schedule 5	
AS 3660 Part 1	2014	Termite management — New building work (incorporating amendment 1)	B1.4, F1.9	3.1.4.2, 3.1.4.3	N/A
AS 3660 Part 3	2014	Termite management — Assessment criteria for termite management systems	N/A	3.1.4.3	N/A
AS/NZS 3666 Part 1	2011	Air-handling and water systems of buildings — Microbial control — Design, installation and commissioning	F2.7, F4.5	N/A	N/A
AS 3700	2018	Masonry structures	B1.4, Schedule 5	3.3.1.0, 3.3.2.0, 3.3.3.0, 3.3.4.0, 3.3.5.0, 3.3.5.4, 3.3.6.0, 3.3.6.1, Schedule 5	Schedule 5
AS 3740	2010	Waterproofing of domestic wet areas (incorporating amendment 1)	F1.7	3.8.1.2	N/A
AS 3786	2014	Smoke alarms using scattered light, transmitted light or ionization (incorporating amendment 1 and 2) See Note 7	Spec E2.2a	3.7.5.2, 3.7.5.6	N/A
AS/NZS 3823 Part 1.2	2012	Performance of electrical appliances — Airconditioners and heat pumps — Ducted airconditioners and air-to-air heat pumps — Testing and rating for performance	Spec JVa, J5.11	N/A	N/A
AS 3959	2018	Construction of buildings in bushfire-prone areas	G5.2	3.10.5.0	N/A
AS/NZS 4020	2018	Testing of products for use in contact with drinking water See Note 8	A5.3	A5.3	A5.3, A5.6
AS 4055	2012	Wind loads for housing (incorporating amendment 1)	Schedule 3	3.0.3, Schedule 3	Schedule 3
AS 4072 Part 1	2005	Components for the protection of openings in fire-resistant separating elements — Service penetrations and control joints (incorporating amendment 1) See Note 9	C3.15	3.7.3.3	N/A
AS 4100	1998	Steel structures	B1.4, Schedule 5	3.2.5.6, 3.3.5.12,	Schedule 5

Referenced documents

No.	Date	Title	Volume One	Volume Two	Volume Three
		(incorporating amendment 1)		3.4.2.0, 3.4.4.0, 3.10.6.2, Schedule 5	
AS/NZS 4200 Part 1	2017	Pliable building membranes and underlays — Materials	F1.6, F6.2, Schedule 3	3.5.2.4, 3.5.4.2, 3.5.4.8, 3.8.7.2, Schedule 3	Schedule 3
AS 4200 Part 2	2017	Pliable building membranes and underlays — Installation requirements (incorporating amendment 1)	F1.6, F6.2	3.8.7.2	N/A
AS/NZS 4234	2008	Heated water systems — Calculation of energy consumption (incorporating amendments 1, 2 and 3)	N/A	N/A	BV2.1, B2.2
AS 4254 Part 1	2012	Ductwork for air-handling systems in buildings — Flexible duct	Spec C1.10, J5.6	3.7.1.2, 3.12.5.3	N/A
AS 4254 Part 2	2012	Ductwork for air-handling systems in buildings — Rigid duct	Spec C1.10, J5.4, J5.6	3.12.5.3	N/A
AS/NZS 4256 Part 1	1994	Plastic roof and wall cladding materials — General requirements	F1.5	N/A	N/A
AS/NZS 4256 Part 2	1994	Plastic roof and wall cladding materials — Unplasticized polyvinyl chloride (uPVC) building sheets	F1.5	N/A	N/A
AS/NZS 4256 Part 3	1994	Plastic roof and wall cladding materials — Glass fibre reinforced polyester (GRP)	F1.5	N/A	N/A
AS/NZS 4256 Part 5	1996	Plastic roof and wall cladding materials — Polycarbonate	F1.5	N/A	N/A
AS/NZS 4284	2008	Testing of building facades	FV1.1	V2.2.1	N/A
AS/NZS 4505	2012	Garage doors and other large access doors (incorporating amendment 1)	B1.4	3.0.4	N/A
AS 4552	2005	Gas fired water heaters for hot water supply and/or central heating	N/A	N/A	B2.2
AS 4586	2013	Slip resistance classification of new pedestrian surface materials (incorporating amendment 1) See Note 10	D2.10, D2.13, D2.14, Spec F2.9	3.9.1.4	N/A
AS 4597	1999	Installation of roof slates and shingles (Non-interlocking type)	B1.4, F1.5	3.5.2.0	N/A

Referenced documents

No.	Date	Title	Volume One	Volume Two	Volume Three
AS/NZS 4600	2018	Cold-formed steel structures	B1.4, Schedule 5	3.4.2.0, 3.4.4.0, Schedule 5	Schedule 5
AS 4654 Part 1	2012	Waterproofing membranes for external above-ground use — Materials	F1.4	3.8.1.3	N/A
AS 4654 Part 2	2012	Waterproofing membranes for external above-ground use — Design and installation	F1.4	3.8.1.3	N/A
AS 4678	2002	Earth-retaining structures	N/A	3.1.2.0	N/A
AS 4773 Part 1	2015	Masonry in small buildings — Design (incorporating amendment 1)	N/A	3.3.1.0, 3.3.2.0, 3.3.3.0, 3.3.4.0, 3.3.5.0, 3.3.5.4, 3.3.6.0	N/A
AS 4773 Part 2	2015	Masonry in small buildings — Construction	N/A	3.3.1.0, 3.3.2.0, 3.3.3.0, 3.3.4.0, 3.3.5.0, 3.3.5.4, 3.3.6.0	N/A
AS/NZS 4859 Part 1	2018	Thermal insulation materials for buildings — General criteria and technical provisions	J1.2, J5.5, J5.8	3.12.1.1, 3.12.1.5, 3.12.5.1, 3.12.5.2, 3.12.5.3	N/A
AS/NZS 4859 Part 2	2018	Thermal insulation materials for buildings — Design	J1.2, Spec J1.5a	N/A	N/A
AS 5113	2016	Classification of external walls of buildings based on reaction-to-fire performance (incorporating amendment 1)	CV3	N/A	N/A
AS 5146 Part 1	2015	Reinforced autoclaved aerated concrete — Structures (incorporating amendment 1)	B1.4	3.5.4.0	N/A
AS 5216	2018	Design of post-installed and cast-in fastenings in concrete	B1.4	3.0.4	N/A
AS 5637 Part 1	2015	Determination of fire hazard properties — Wall and ceiling linings	Spec C1.10, Schedule 3	Schedule 3	Schedule 3
AS ISO 9239 Part 1	2003	Reaction to fire tests for floorings — Determination of the burning behaviour using a radiant heat source	Schedule 3	Schedule 3	Schedule 3
AS/NZS ISO 9972	2015	Thermal performance of buildings — Determination of air permeability of buildings — Fan pressurization method	JV4	V2.6.2.3	N/A
AIRAH-DA09	1998	Air conditioning load estimation	Spec JVc	N/A	N/A
AIRAH-DA28	2011	Building management	Spec JVb	N/A	N/A

Referenced documents

No.	Date	Title	Volume One	Volume Two	Volume Three
		and control systems			
ANSI/ASHRAE Standard 55	2013	Thermal environmental conditions for human occupancy	Schedule 3	Schedule 3	Schedule 3
ANSI/ASHRAE Standard 140	2007	Standard method of test for the evaluation of building energy analysis computer programs	JV1, JV2, JV3	V2.6.2.2	N/A
ASTM E2073-10	2010	Standard Test Method for Photopic Luminance of Photoluminescent (Phosphorescent) Markings	Spec E4.8	N/A	N/A
ASTM E72-15	2015	Standard Test Methods of Conducting Strength Tests of Panels for Building Construction	Spec C1.8	N/A	N/A
ASTM E695-03	2003	Standard Test Method of Measuring Relative Resistance of Wall, Floor and Roof Construction to Impact Loading	Spec C1.8	N/A	N/A
ASTM E903	2012	Standard Test Method for Solar Absorptance, Reflectance, and Transmittance of Materials Using Integrating Spheres	N/A	3.12.1.2	N/A
AHRI 460	2005	Performance rating of remote mechanical-draft air-cooled refrigerant condensers	J5.12	N/A	N/A
AHRI 551/591	2015	Performance rating of water-chilling and heat pump water-heating packages using the vapor compression cycle.	Spec JVa, J5.10	N/A	N/A
ABCB	2011	Protocol for Structural Software, Version 2011.2	B1.5	3.0.5, 3.4.0.2	N/A
ABCB	2012	Standard for Construction of Buildings in Flood Hazard Areas, Version 2012.3	B1.6	3.10.3.0	N/A
ABCB	2019	Standard for NatHERS Heating and Cooling Load Limits, Version 2019.1	J0.2	3.12.0.1	N/A
CIBSE Guide A	2015	Environmental design	Spec JVb, Spec JVc, J1.2, J1.6	N/A	N/A
Disability Standards for Accessible Public Transport	2002		F2.9, H2.1	N/A	N/A

Referenced documents

No.	Date	Title	Volume One	Volume Two	Volume Three
Education and Care Services National Law Act (Vic)	2010		Schedule 3	Schedule 3	Schedule 3
European Union Commission Regulation 547/2012	2012	Ecodesign requirements for water pumps	J5.7	N/A	N/A
European Union Commission Regulation 622/Annex II, point 2	2012	Eco-design requirements for glandless standalone circulators and glandless circulators integrated in products	J5.7	N/A	N/A
FPAA101D	2018	Automatic Fire Sprinkler System Design and Installation — Drinking Water Supply	CV3, C1.5, C1.13, C2.1, C2.6, C2.7, C3.5, C3.6, C3.7, C3.8, C3.11, Spec C1.1, Spec C1.10, D1.3, D1.12, D2.21, D2.25, E1.3, Spec E1.5, Spec E1.5a, E2.2, Spec E2.2a, G3.1, G3.6, Spec G3.8, H1.2	N/A	B4.2
FPAA101H	2018	Automatic Fire Sprinkler System Design and Installation — Hydrant Water Supply	CV3, C1.5, C1.13, C2.1, C2.6, C2.7, Spec C1.1, Spec C1.10, E1.3, Spec E1.5, Spec E1.5a, E2.2, Spec E2.2a, G3.1, G3.6, Spec G3.8, H1.2	N/A	B4.2
ISO 140 Part 6	1998E	Acoustics — Measurement of sound insulation in buildings and of building elements — Laboratory measurements of impact sound insulation of floors	Spec F5.5	N/A	N/A
ISO 540	2008	Hard coal and coke — Determination of ash fusibility	Spec C3.15	N/A	N/A
ISO 8336	1993E	Fibre-cement flat sheets	Schedule 3	3.5.4.3, 3.5.4.4, 3.5.4.5, Schedule 3	Schedule 3
ISO 25745 Part 2	2015	Energy performance of lifts, escalators and moving walks: Energy calculation and classification for lifts (elevators)	J6.7	N/A	N/A
NASH Standard	2014	Steel Framed	N/A	3.10.5.0	N/A

Referenced documents

No.	Date	Title	Volume One	Volume Two	Volume Three
		Construction in Bushfire Areas (incorporating amendment A)			
NASH Standard Part 1	2005	Residential and Low-Rise Steel Framing — Design Criteria (incorporating amendments A, B and C)	B1.4	3.4.2.0	N/A
NASH Standard Part 2	2014	Residential and Low-Rise Steel Framing — Design Solutions (incorporating amendment A)	B1.4, B1.5, F1.12	3.0.5, 3.4.0.2, 3.4.1.2, 3.4.2.0, 3.5.4.4	N/A
N/A	N/A	Northern Territory Deemed to Comply Standards Manual	N/A	3.0.4	N/A
SA TS 5344	2019	Permanent labelling for Aluminium Composite Panel (ACP) products	A5.7	A5.7	A5.7
TN 61		Cement Concrete and Aggregates Australia — Technical note — Articulated walling	N/A	3.2.1	N/A

Notes associated with [Table 1](#):

- (1) For AS/NZS ISO 717.1:
 - (a) Test reports based on AS 1276—1979 and issued prior to AS/NZS 1276.1—1999 being referenced in the NCC remain valid.
 - (b) The STC values in reports based on AS 1276—1979 shall be considered to be equivalent to R_w values.
 - (c) Test reports based on AS/NZS 1276.1 prepared after the NCC reference date for AS/NZS 1276.1—1999 must be based on that version.
 - (d) Test reports based on ISO 717-1—1996 and issued prior to AS/NZS ISO 717.1—2004 being referenced in the NCC remain valid.
 - (e) Reports based on AS/NZS ISO 717.1 relating to tests carried out after the NCC reference date for AS/NZS ISO 717.1—2004 must relate to the amended Standard.
- (2) For AS 1530 Parts 1 to 4:
 - (a) Until 1 September 2022, subject to the note to AS 4072.1, reports relating to tests carried out under earlier editions of AS 1530 Parts 1 to 4 remain valid.
 - (b) Reports relating to tests carried out after the date of an amendment to a Standard must relate to the amended Standard.
- (3) For AS 1562.1, tests carried out based on AS 1562.1—1992 and issued prior to AS 1562.1—2018 being referenced in the NCC remain valid. Reports relating to tests carried out after the NCC reference date for AS 1562.1 must relate to the revised Standard.
- (4) For AS 1670.1, AS 1670.3 and AS 1670.4, notwithstanding A4.0(5), until the adoption of NCC 2025 the editions of the documents listed in Table 1.8 of AS 1670.1, AS 1670.3 and AS 1670.4 may be used to meet the requirements of AS 1670.1, AS 1670.3 and AS 1670.4 as applicable.
- (5) For AS/NZS 1859.4, the 2004 edition has been retained for a transitional period ending on 30 April 2020.

Referenced documents

- (6) For AS 2047:
- (a) Tests carried out under earlier editions of AS 2047 remain valid.
 - (b) Reports based on AS 2047 relating to tests carried out after the NCC reference date for AS 2047—2014 Amendment 2 must relate to the amended Standard.
- (7) For AS 3786:
- (a) Tests carried out under AS 3786—2014 Amendment 1 remain valid.
 - (b) Reports based on AS 3786 relating to tests carried out after the NCC reference date for AS 3786—2014 Amendment 2 must relate to the amended Standard.
- (8) Test reports based on the 2005 edition of AS/NZS 4020 will continue to be accepted until 1 May 2024. Test reports prepared after the NCC reference date for the 2018 edition of AS/NZS 4020 must be based on the 2018 edition.
- (9) For AS 4072.1, until 1 September 2022, systems tested to AS 1530.4 prior to 1 January 1995 need not be retested to comply with the provisions of AS 4072.1.
- (10) For AS 4586:
- (a) Test reports based on the 2004 edition of AS/NZS 4586 and issued prior to the 2013 edition of AS 4586 being referenced in the NCC remain valid.
 - (b) Test reports prepared after the NCC reference date of the 2013 edition of AS 4586 must be based on that version.
 - (c) For the purposes of assessing compliance, the slip-resistance classifications of V, W and X in reports based on the 2004 edition of AS/NZS 4586 may be considered to be equivalent to slip-resistance classifications of P5, P4 and P3 respectively in the 2013 edition of AS 4586.
 - (d) Test reports based on Appendix D of AS 4586—2013 and issued prior to the NCC reference date for AS 4586—2013 (incorporating Amendment 1) remain valid.
 - (e) Test reports based on Appendix D of AS 4586—2013 and prepared after the NCC reference date for AS 4586—2013 (incorporating Amendment 1) must be based on that version.
- (11) Tests carried out based on AS/NZS 2918—2001 and issued prior to AS/NZS 2918—2018 being referenced in the BCA remain valid. Reports relating to tests carried out after the NCC reference date for AS/NZS 2918 must relate to the revised Standard.

State and Territory variations for Volume One—Schedule of referenced documents

ACT, NSW, NT, Qld, SA, Tas, Vic

State and Territory variations for Volume Two—Schedule of referenced documents

ACT, NSW, NT, Qld, SA, Tas, Vic, WA

State and Territory variations for Volume Three—Schedule of referenced documents

ACT, SA, Tas

Fire-resistance of building elements

Schedule 5 Fire-resistance of building elements

Schedule 5 Fire-resistance of building elements

Schedule 5 Fire-resistance of building elements

1. Scope
2. Rating
3. FRLs determined by calculation
4. Interchangeable materials
5. Columns covered with lightweight construction
6. Non-loadbearing elements

Schedule 5 Fire-resistance of building elements

1. Scope

This Schedule sets out the procedures for determining the FRL of building elements.

2. Rating

A building element meets the requirements of this Schedule if—

- (a) it is listed in, and complies with [Table 1](#) of this Schedule; or
- (b) it is identical with a prototype that has been submitted to the [Standard Fire Test](#), or an equivalent or more severe test, and the FRL achieved by the prototype without the assistance of an active fire suppression system is confirmed in a report from an [Accredited Testing Laboratory](#) which—
 - (i) describes the method and conditions of the test and the form of construction of the tested prototype in full; and
 - (ii) certifies that the application of restraint to the prototype complied with the [Standard Fire Test](#); or
- (c) it differs in only a minor degree from a prototype tested under (b) and the FRL attributed to the building element is confirmed in a report from an [Accredited Testing Laboratory](#) which—
 - (i) certifies that the building element is capable of achieving the FRL despite the minor departures from the tested prototype; and
 - (ii) describes the materials, construction and conditions of restraint which are necessary to achieve the FRL; or
- (d) it is designed to achieve the FRL in accordance with—
 - (i) AS/NZS 2327, AS 4100 and AS/NZS 4600 if it is a steel or composite structure; or
 - (ii) AS 3600 if it is a concrete structure; or
 - (iii) AS 1720.4 if it is a timber element other than [fire-protected timber](#); or
 - (iv) AS 3700 if it is a masonry structure; or
- (e) the FRL is determined by calculation based on the performance of a prototype in the [Standard Fire Test](#) and confirmed in a report in accordance with [Clause 3](#); or
- (f) for [fire-protected timber](#), it complies with [Specification C1.13a](#) where applicable.

3. FRLs determined by calculation

If the FRL of a building element is determined by calculation based on a tested prototype—

- (a) the building element may vary from the prototype in relation to—
 - (i) length and height if it is a wall; and
 - (ii) height if it is a column; and
 - (iii) span if it is a floor, roof or beam; and
 - (iv) conditions of support; and
 - (v) to a minor degree, cross-section and components; and
- (b) the report must demonstrate by calculation that the building element would achieve the FRL if it is subjected to the regime of the [Standard Fire Test](#) in relation to—
 - (i) [structural adequacy](#) (including deflection); and
 - (ii) [integrity](#); and
 - (iii) [insulation](#); and
- (c) the calculations must take into account—
 - (i) the temperature reached by the components of the prototype and their effects on strength and modulus of elasticity; and

Fire-resistance of building elements

- (ii) appropriate features of the building element such as support, restraint, cross-sectional shape, length, height, span, slenderness ratio, reinforcement, ratio of surface area to mass per unit length, and fire protection; and
- (iii) features of the prototype that influenced its performance in the *Standard Fire Test* although these features may not have been taken into account in the design for dead and live load; and
- (iv) features of the conditions of test, the manner of support and the position of the prototype during the test, that might not be reproduced in the building element if it is exposed to fire; and
- (v) the design load of the building element in comparison with the tested prototype.

4. Interchangeable materials

- (a) Concrete and plaster — An FRL achieved with any material of Group A, B, C, D or E as an ingredient in concrete or plaster, applies equally when any other material of the same group is used in the same proportions:
- Group A: Any portland cement.
- Group B: Any lime.
- Group C: Any dense sand.
- Group D: Any dense calcareous aggregate, including any limestone or any calcareous gravel.
- Group E: Any dense siliceous aggregate, including any basalt, diorite, dolerite, granite, granodiorite or trachyte.
- (b) Perlite and vermiculite — An FRL achieved with either gypsum-perlite plaster or gypsum-vermiculite plaster applies equally for each plaster.

5. Columns covered with lightweight construction

If the *fire-resisting* covering of a steel column is *lightweight construction*, the construction must comply with C1.8 and C3.17.

6. Non-loadbearing elements

If a non-*loadbearing* element is able to be used for a purpose where the *Deemed-to-Satisfy Provisions* prescribe an FRL for *structural adequacy*, *integrity* and *insulation*, that non-*loadbearing* element need not comply with the *structural adequacy* criteria.

Table 1 FRLs Deemed to be achieved by certain building element

Building element	Minimum thickness (mm) of principal material for FRLs					Annexure reference
Wall						
	60/60/60	90/90/90	120/120/120	180/180/180	240/240/240	Clause
Masonry						
Ashlar	–	–	–	–	300	1, 2, 5, 6
Calcium silicate		see 2(d)(iv) of this Specification				
Concrete		see 2(d)(iv) of this Specification				
Fired clay (inc terracotta)		see 2(d)(iv) of this Specification				
Concrete						
No-fines	–	–	–	150	170	1, 5, 6
Prestressed		see 2(d)(ii) of this Specification				
Reinforced		see 2(d)(ii) of this Specification				
Plain	–	–	–	150	170	1, 5, 6
Solid gypsum blocks	75	90	100	110	125	1, 5, 6
Gypsum — perlite or Gypsum vermiculite-plaster on metal lath and channel (non-loadbearing walls only)	50	50	65	–	–	1, 5, 7
Concrete column						
	60/60/60	90/90/90	120/120/120	180/180/180	240/240/240	Clause
Prestressed		see 2(d)(ii) of this Specification				

Fire-resistance of building elements

Building element	Minimum thickness (mm) of principal material for FRLs					Annexure reference
Reinforced	see 2(d)(ii) of this Specification					
Hot-rolled steel column						
	60/60/60	90/90/90	120/120/120	180/180/180	240/240/240	Clause
(inc. a fabricated column) exposed on no more than 3 sides:						8
Fire protection of Concrete — Cast in-situ— <i>loadbearing</i>	25	30	40	55	75	9, 11, 12
non- <i>loadbearing</i> — unplastered	25	30	40	50	65	9, 11, 12
plastered 13 mm—	25	25	30	40	50	1, 6, 9, 11, 12
Gypsum — Cast in-situ Gypsum — perlite or Gypsum-vermiculite plaster	—	—	—	—	50	9, 11, 12
sprayed to contour	20	25	35	50	55	1, 11
sprayed on metal lath	20	20	25	35	45	1, 7
Hot-rolled steel column						
	60/60/60	90/90/90	120/120/120	180/180/180	240/240/240	Clause
(inc. a fabricated column) exposed on no more than 3 sides and with column spaces filled:						8, 9
Fire protection of— Solid calcium-silicate masonry	50	50	50	50	65	1, 3, 11, 12
Solid clay masonry	50	50	50	65	90	1, 3, 11, 12
Solid concrete masonry	50	50	50	65	90	1, 3, 11, 12
Solid gypsum blocks	50	50	50	50	65	1, 3, 11, 12
Hollow terracotta blocks plastered 13 mm	50	50	50	65	90	1, 3, 6, 10., 11, 12
Hot-rolled steel column						
	60/60/60	90/90/90	120/120/120	180/180/180	240/240/240	Clause
(inc. a fabricated column) exposed on no more than 3 sides and with column spaces unfilled:						8
Fire protection of— Solid calcium- silicate masonry	50	50	50	—	—	1, 3, 11, 12
Solid clay masonry	50	50	65	—	—	1, 3, 11, 12
Solid concrete masonry	50	50	65	—	—	1, 3, 11, 12
Solid gypsum blocks	50	50	50	—	—	1, 3, 11, 12
Hollow terracotta blocks— plastered 13 mm	50	50	65	—	—	1, 3, 6, 10, 11, 12
Hot-rolled steel column						
	60/-/-	90/-/-	120/-/-	180/-/-	240/-/-	Clause
(inc. a fabricated column) exposed on 4 sides:						8
Fire protection of— Concrete — Cast in-situ— <i>loadbearing</i>	25	40	45	65	90	9, 11, 12
non- <i>loadbearing</i> unplastered	25	30	40	50	65	9, 11, 12
plastered 13 mm	25	25	30	40	50	1, 6, 9, 11, 12
Gypsum — Cast in-situ Gypsum-perlite or	—	—	—	—	50	9, 11, 12

Fire-resistance of building elements

Building element	Minimum thickness (mm) of principal material for FRLs					Annexure reference
	60/-/-	90/-/-	120/-/-	180/-/-	240/-/-	
Gypsum-vermiculite plaster						
sprayed to contour	25	30	40	55	65	1, 11
sprayed on metal lath	20	20	30	40	50	1, 7
Hot-rolled steel column						
	60/-/-	90/-/-	120/-/-	180/-/-	240/-/-	Clause
(inc. a fabricated column) exposed on 4 sides and with column spaces filled:						8, 9
Fire protection of—						
Solid calcium-silicate masonry	50	50	50	65	75	1, 3, 11, 12
Solid clay masonry	50	50	50	75	100	1, 3, 11, 12
Solid concrete masonry	50	50	50	75	100	1, 3, 11, 12
Solid gypsum blocks	50	50	50	65	75	1, 3, 11, 12
Hollow terracotta blocks— plastered 13 mm	50	50	50	75	100	1, 3, 6, 10, 11, 12
Hot-rolled steel column						
	60/-/-	90/-/-	120/-/-	180/-/-	240/-/-	Clause
(inc. a fabricated column) exposed on 4 sides and with column spaces unfilled:						8
Fire protection of—						
Solid calcium-silicate masonry	50	50	50	—	—	1, 3, 11, 12
Solid clay masonry	50	50	65	—	—	1, 3, 11, 12
Solid concrete masonry	50	50	65	—	—	1, 3, 11, 12
Solid gypsum blocks	50	50	50	—	—	1, 3, 11, 12
Hollow terracotta blocks— plastered 13 mm	50	50	65	—	—	1, 3, 6, 10, 11, 12
Beam						
	60/-/-	90/-/-	120/-/-	180/-/-	240/-/-	Clause
Concrete—						
Prestressed		see 2(d)(ii) of this Specification				
Reinforced		see 2(d)(ii) of this Specification				
Hot-rolled Steel (inc. an open-web joist girder truss etc) exposed on no more than 3 sides:						8
Fire protection of—						
Concrete — Cast in-situ	25	30	40	50	65	11, 12
Gypsum-perlite or Gypsum-vermiculite plaster						
sprayed to contour	20	25	35	50	55	1, 11
sprayed on metal lath	20	20	25	35	45	1, 7
Hot-rolled Steel (inc. an open-web joist girder truss etc) exposed on 4 sides:						8
Fire protection of—						
Concrete — Cast in-situ	25	40	45	65	90	11, 12
Gypsum-perlite or Gypsum-vermiculite plaster—						
sprayed to contour	25	30	40	55	65	1, 11
sprayed on metal lath	20	20	30	40	50	1, 7
Floor, roof or ceiling						
	60/60/60	90/90/90	120/120/120	180/180/180	240/240/240	Clause
Concrete—						
Prestressed		see 2(d)(ii) of this Specification				

Fire-resistance of building elements

Building element	Minimum thickness (mm) of principal material for FRLs		Annexure reference
Reinforced		see 2(d)(ii) of this Specification	

Annexure to Table 1

1. Mortar, plaster and plaster reinforcement

1.1 Mortar for masonry

Masonry units of ashlar, calcium silicate, concrete or fired clay (including terracotta blocks) must be laid in cement mortar or composition mortar complying with the relevant provisions of AS 3700.

1.2 Gypsum blocks

Gypsum blocks must be laid in gypsum-sand mortar or lime mortar.

1.3 Gypsum-sand mortar and plaster

Gypsum-sand mortar and gypsum-sand plaster must consist of either—

- (a) not more than 3 parts by volume of sand to 1 part by volume of gypsum; or
- (b) if lime putty is added, not more than 2.5 parts by volume of sand to 1 part by volume of gypsum and not more than 5% of lime putty by volume of the mixed ingredients.

1.4 Gypsum-perlite and gypsum-vermiculite plaster

Gypsum-perlite or gypsum-vermiculite plaster must be applied—

- (a) in either one or 2 coats each in the proportions of 1 m³ of perlite or vermiculite to 640 kg of gypsum if the *required* thickness of the plaster is not more than 25 mm; and
- (b) in 2 coats if the *required* thickness is more than 25 mm, the first in the proportions of 1 m³ of perlite or vermiculite to 800 kg of gypsum and the second in the proportions of 1 m³ of perlite or vermiculite to 530 kg of gypsum.

1.5 Plaster of cement and sand or cement, lime and sand

Plaster prescribed in [Table 1](#) must consist of—

- (a) cement and sand or cement, lime and sand; and
- (b) may be finished with gypsum, gypsum-sand, gypsum-perlite or gypsum-vermiculite plaster or with lime putty.

1.6 Plaster reinforcement

If plaster used as fire protection on walls is more than 19 mm thick—

- (a) it must be reinforced with expanded metal lath that—
 - (i) has a mass per unit area of not less than 1.84 kg/m²; and
 - (ii) has not fewer than 98 meshes per metre; and
 - (iii) is protected against corrosion by galvanising or other suitable method; or
- (b) it must be reinforced with 13 mm x 13 mm x 0.7 mm galvanised steel wire mesh, and with the reinforcement must be securely fixed at a distance from the face of the wall of not less than 1/3 of the total thickness of the plaster.

2. Ashlar stone masonry

Ashlar masonry must not be used in a part of the building containing more than 2 *storeys*, and must not be of—

- (a) aplite, granite, granodiorite, quartz dacite, quartz diorite, quartz porphyrite or quartz porphyry; or
- (b) conglomerate, quartzite or sandstone; or
- (c) chert or flint; or
- (d) limestone or marble.

3. Dimensions of masonry

The thicknesses of masonry of calcium-silicate, concrete and fired clay are calculated as follows:

3.1 Solid units

For masonry in which the amount of perforation or coring of the units does not exceed 25% by volume (based on the overall rectangular shape of the unit) the thickness of the wall must be calculated from the manufacturing dimensions of the units and the specified thickness of the joints between them as appropriate.

3.2 Hollow units

For masonry in which the amount of perforation or coring of the units exceeds 25% by volume (based on the overall rectangular shape of the unit) the thickness of the wall must be calculated from the equivalent thicknesses of the units and the specified thickness of the joints between them as appropriate.

3.3 Equivalent thickness

The equivalent thickness of a masonry unit is calculated by dividing the net volume by the area of one vertical face.

4. * * * * *

This Clause has deliberately been left blank.

5. Height-to-thickness ratio of certain walls

The ratio of height between lateral supports to overall thickness of a wall of ashlar, no-fines concrete, unreinforced concrete, solid gypsum blocks, gypsum-perlite or gypsum-vermiculite plaster on metal lath and channel, must not exceed—

- (a) 20 for a *loadbearing* wall; or
- (b) 27 for a non-*loadbearing* wall.

6. Increase in thickness by plastering

6.1 Walls

If a wall of ashlar, solid gypsum blocks or concrete is plastered on both sides to an equal thickness, the thickness of the wall for the purposes of [Table 1](#) (but not for the purposes of [Annexure Clause 5](#)) may be increased by the thickness of the plaster on one side.

6.2 Columns

Where [Table 1](#) indicates that column-protection is to be plastered, the tabulated thicknesses are those of the principal material. They do not include the thickness of plaster which must be additional to the listed thickness of the material to which it is applied.

7. Gypsum-perlite or gypsum-vermiculite plaster on metal lath

7.1 Walls

In walls fabricated of gypsum-perlite or gypsum-vermiculite plaster on metal lath and channel—

- (a) the lath must be securely wired to each side of 19 mm x 0.44 kg/m steel channels (used as studs) spaced at not more than 400 mm centres; and
- (b) the gypsum-perlite or gypsum-vermiculite plaster must be applied symmetrically to each exposed side of the lath.

7.2 Columns

For the fire protection of steel columns with gypsum-perlite or gypsum-vermiculite on metal lath—

- (a) the lath must be fixed at not more than 600 mm centres vertically to steel furring channels, and—
 - (i) if the plaster is to be 35 mm thick or more — at least 12 mm clear of the column; or
 - (ii) if the plaster is to be less than 35 mm thick — at least 6 mm clear of the column; or

Fire-resistance of building elements

- (b) the plaster may be applied to self-furring lath with furring dimples to hold it not less than 10 mm clear of the column, and
the thickness of the plaster must be measured from the back of the lath.

7.3 Beams

For the fire protection of steel beams with gypsum-perlite or gypsum-vermiculite on metal lath—

- (a) the lath must be fixed at not more than 600 mm centres to steel furring channels and at least 20 mm clear of the steel; and
- (b) the thickness of the plaster must be measured from the back of the lath.

8. Exposure of columns and beams

8.1 Columns

A column incorporated in or in contact on one or more sides with a wall of solid masonry or concrete at least 100 mm thick may be considered to be exposed to fire on no more than 3 sides.

8.2 Beams

A beam, open-web joist, girder or truss in direct and continuous contact with a concrete slab or a hollow block floor or roof may be considered to be exposed to fire on no more than 3 sides.

9. Filling of column spaces

- (a) The spaces between the fire-protective material and the steel (and any re-entrant parts of the column itself) must be filled solid with a fire-protective material like concrete, gypsum or grout.
- (b) The insides of hollow sections, including pipes, need not be filled.

10. Hollow terracotta blocks

The proportion of cored holes or perforations in a hollow terracotta block (based on the overall rectangular volume of the unit) must not exceed the following:

- (a) For blocks up to 75 mm thick — 35%.
- (b) For blocks more than 75 mm but not more than 100 mm thick — 40%.
- (c) For blocks more than 100 mm — 50%.

11. Reinforcement for column and beam protection

11.1 Masonry

Masonry of calcium-silicate, fired clay and concrete for the protection of steel columns must have steel-wire or mesh reinforcement in every second course and lapped at the corners.

11.2 Gypsum blocks and hollow terracotta blocks

Gypsum blocks and hollow terracotta blocks for the protection of steel columns must have steel-wire or mesh reinforcement in every course and lapped at corners.

11.3 Structural concrete and poured gypsum

If a steel column or a steel beam is to be protected with structural concrete or poured gypsum, the concrete or gypsum must be reinforced with steel-wire mesh or steel-wire binding placed about 20 mm from its outer surface, and—

- (a) for concrete or gypsum less than 50 mm thick, the steel wire must be—
 - (i) not less than 3.15 mm in diameter; and
 - (ii) spaced at not more than 100 mm vertically; or
- (b) for concrete or gypsum not less than 50 mm thick, the steel wire must be either—
 - (i) of a diameter and spacing in accordance with (a); or
 - (ii) not less than 5 mm in diameter and spaced at not more than 150 mm vertically.

Fire-resistance of building elements

11.4 Gypsum-perlite or gypsum-vermiculite plaster sprayed to contour

- (a) If a steel column or steel beam is protected with either gypsum-perlite or gypsum-vermiculite plaster sprayed to contour and the construction falls within the limits of [Table 11.4](#), the plaster must be reinforced with—
 - (i) expanded metal lath complying with [Clause 1.6 of this Annexure](#); or
 - (ii) galvanised steel wire mesh complying with [Clause 1.6 of this Annexure](#).
- (b) The reinforcement must be placed at a distance from the face of the plaster of at least 1/3 of the thickness of the plaster and must be securely fixed to the column or beam at intervals of not more than the relevant listing in [Table 11.4](#).
- (c) For the purposes of [Table 11.4](#)—
 - (i) “vertical” includes a surface at not more than 10° to the vertical; and
 - (ii) “horizontal” includes a surface at not more than 10° to the horizontal; and
 - (iii) “underside” means the underside of any horizontal or non-vertical surface.

Table 11.4 Reinforcement of gypsum-perlite or gypsum-vermiculite plaster sprayed to contour

Surface to be protected	Reinforcement required if smaller dimension of surface exceeds (mm)	Max spacing of fixings of the mesh to surface (mm)
Vertical members with H or I cross-section	450	450
Non-vertical members with H or I cross-section	300	300
Underside members with H or I cross section	300	300
Upper sides of horizontal surface members with H or I cross-section	Not required	N/A
Vertical members with other shapes	Any size	450
Non-vertical members with other shapes	Any size	300
Underside members with other shapes	Any size	300
Upper side of horizontal surface members with other shapes	Not required	N/A

12. Thickness of column and beam protection

12.1 Measurement of thickness

The thickness of the fire protection to steel columns and steel beams (other than fire protection of gypsum-perlite or gypsum-vermiculite plaster sprayed on metal lath or sprayed to contour) is to be measured from the face or edge of the steel, from the face of a splice plate or from the outer part of a rivet or bolt, whichever is the closest to the outside of the fire-protective construction, except that—

- (a) if the thickness of the fire protection is 40 mm or more, rivet heads may be disregarded; and
- (b) if the thickness of the fire protection is 50 mm or more—
 - (i) any part of a bolt (other than a high-tensile bolt) may be disregarded; and
 - (ii) a column splice plate within 900 mm of the floor may encroach upon the fire protection by up to a 1/4 of the thickness of the fire protection; and
- (c) the flange of a column or beam may encroach by up to 12 mm upon the thickness of the fire protection at right angles to the web if—
 - (i) the column or beam is intended to have an FRL of 240/240/240 or 240/—/—; and
 - (ii) the flange projects 65 mm or more from the web; and
 - (iii) the thickness of the edge of the flange (inclusive of any splice plate) is not more than 40 mm.

Fire hazard properties

Schedule 6 Fire hazard properties

Schedule 6 Fire hazard properties

Schedule 6 Fire hazard properties

1. Scope
2. Assemblies
 - 2.1 General requirement
 - 2.2 Form of test
 - 2.3 Test specimens
 - 2.4 Concession
 - 2.5 Smaller specimen permitted

Schedule 6 Fire hazard properties

1. Scope

This Schedule sets out the procedures for determining the *fire hazard properties* of assemblies tested to AS/NZS 1530.3.

2. Assemblies

2.1 General requirement

The *fire hazard properties* of assemblies and their ability to screen their core materials as *required* under [Specification C1.10](#) must be determined by testing in accordance with this Clause.

2.2 Form of test

Tests must be carried out in accordance with—

- (a) for the determination of the *Spread-of-Flame Index* and *Smoke-Developed Index* — AS/NZS 1530.3; and
- (b) for the determination of the ability to prevent ignition and to screen its core material from free air — AS 1530.4.

2.3 Test specimens

Test specimens must incorporate—

- (a) all types of joints; and
- (b) all types of perforations, recesses or the like for pipes, light switches or other fittings, which are proposed to be used for the member or assembly of members in the building.

2.4 Concession

[Clause 2.3](#) does not apply to joints, perforations, recesses or the like that are larger than those in the proposed application and have already been tested in the particular form of construction concerned and found to comply with the conditions of the test.

2.5 Smaller specimen permitted

A testing laboratory may carry out the test specified in [Clause 2.2\(b\)](#) at pilot scale if a specimen (which must be not less than 900 mm x 900 mm) will adequately represent the proposed construction in the building, but the results of that test do not apply to construction larger than limits defined by the laboratory conducting the pilot examination.

Fire Safety Verification Method

- 1.0 Preface**
- 1.1 Purpose**
- 1.2 How to use this Verification Method**
- 1.3 Performance-based design**
- 1.4 Design scenarios: NCC Performance Requirements**
- 1.5 Fire modelling to determine ASET**
- 2.1 Design scenario (BE)**
- 2.2 Design scenario (UT)**
- 2.3 Design scenario (CS)**
- 2.4 Design scenario (SF)**
- 2.5 Design scenario (HS)**
- 2.6 Design scenario (VS)**
- 2.7 Design scenario (IS)**
- 2.8 Design scenario (FI)**
- 2.9 Design scenario (UF)**
- 2.10 Design scenario (CF)**

2.11 Design scenario (RC)

2.12 Design Scenario (SS)

Schedule 7 Fire Safety Verification Method

- 1.0 Preface
- 1.1 Purpose
- 1.2 How to use this Verification Method
- 1.3 Performance-based design
 - 1.3.1 Performance-based design brief (PBDB)
 - 1.3.2 Final report
- 1.4 Design scenarios: NCC Performance Requirements
- 1.5 Fire modelling to determine ASET
- 2.1 Design scenario (BE)
 - 2.1.1 Design scenario description
 - 2.1.2 Typical method or solution
- 2.2 Design scenario (UT)
 - 2.2.1 Design scenario description
 - 2.2.2 Typical method or solution
- 2.3 Design scenario (CS)
 - 2.3.1 Design scenario description
 - 2.3.2 Typical method or solution
- 2.4 Design scenario (SF)
 - 2.4.1 Design scenario description
 - 2.4.2 Typical method or solution
- 2.5 Design scenario (HS)
 - 2.5.1 Design scenario description
 - 2.5.2 Typical method or solution
- 2.6 Design scenario (VS)
 - 2.6.1 Design scenario description
 - 2.6.2 Method
- 2.7 Design scenario (IS)
 - 2.7.1 Design scenario description
 - 2.7.2 Typical method or solution
- 2.8 Design scenario (FI)
 - 2.8.1 Design scenario description
 - 2.8.2 Typical method or solution
- 2.9 Design scenario (UF)
 - 2.9.1 Design scenario description
 - 2.9.2 Typical method or solution
- 2.10 Design scenario (CF)
 - 2.10.1 Design scenario description

2.10.2 Typical method or solution

2.11 Design scenario (RC)

2.11.1 Design scenario description

2.11.2 Typical method or solution

2.12 Design Scenario (SS)

2.12.1 Design scenario description

2.12.2 Typical method or solution

1.0 Preface

Note:

[Schedule 7](#) does not take effect until 1 May 2020.

This Fire Safety Verification Method provides a process for engineering the design of fire safety *Performance Solutions*. The document provides the flexibility required to develop *Performance Solutions* while still maintaining the level of safety required by the NCC.

To ensure that the level of safety *required* by the NCC is maintained, the level of safety achieved using this *Verification Method* must be at least equivalent to the relevant NCC Volume One *Deemed-to-Satisfy Provisions*.

Section 1 of this document provides an introduction to the *Verification Method* and its application.

Section 2 describes the *design fire* scenarios.

1.1 Purpose

This *Verification Method* presents specific *design scenarios* that must be considered in order to demonstrate that the fire safety aspects of a building design comply with the fire safety *Performance Requirements* of NCC Volume One set out in [Table 1.1](#). The level of safety achieved by the building design must be at least equivalent to the relevant *Deemed-to-Satisfy Provisions*.

For the purposes of developing a *Performance Solution*, this *Verification Method* must only be used by fire safety engineers who are suitably qualified and experienced, and—

- have demonstrated competency in *fire safety engineering*; and
- are proficient in the use of fire engineering modelling methods; and
- are familiar with fire testing and validation of computational data.

This *Verification Method* is not a comprehensive guide to fire safety. The International Fire Engineering Guidelines (2005), provides more comprehensive guidelines on fire safety calculation procedures. The ABCB Fire Safety Verification Method Handbook provides specific guidance on the following as relevant to this *Verification Method*:

- Occupant characteristics.
- Rules and parameters of *design scenarios*.
- Guidelines on modelling.
- Documentation.

Explanatory information:

This *Verification Method* is one way, but not the only way, to demonstrate compliance with the *Performance Requirements* set out in [Table 1.1](#). *Performance Solutions* developed from first principles, or meeting the relevant *Deemed-to-Satisfy Provisions*, remain acceptable ways to demonstrate compliance.

Also, other *Performance Requirements* not covered by this *Verification Method* may need to be considered in order to comply with [A2.2\(3\)](#) and [A2.4\(3\)](#) as applicable.

1.2 How to use this Verification Method

This *Verification Method* sets out twelve *design scenarios* that must be considered in order to demonstrate that a building incorporating one or more *Performance Solutions* satisfies the *Performance Requirements* set out in [Table 1.1](#).

Each *design scenario* must consider one or more locations in the building that capture the range of reasonable possibilities in relation to the threat to safety. The level of safety that the building design achieves must be at least equivalent to the relevant *Deemed-to-Satisfy Provisions*.

All *design scenarios* applicable to a *Performance Requirement* must be assessed to demonstrate compliance with that *Performance Requirement*.

Explanatory information:

In many cases the location that is the most challenging for a particular *design scenario* will be easily determined. Where it is not easily determined, the particular *design scenario* should be run in multiple locations to ensure the most challenging location is modelled.

1.3 Performance-based design

1.3.1 Performance-based design brief (PBDB)

When using this *Verification Method*, the fire safety engineer must undertake a *performance-based design brief (PBDB)* that must involve all stakeholders relevant to the building design. The *PBDB* must also outline the fire strategy to be adopted.

While full agreement on all aspects of the *PBDB* is the preferred outcome, it is acknowledged that in some instances this may not be possible to obtain. In the event that full agreement cannot be achieved through the *PBDB*, dissenting views must be appropriately recorded and carried throughout the process and considered as part of the due processes of the *appropriate authority* when determining compliance and providing approval.

Consideration of whether a peer review (by an independent fire safety engineer) of some or all of the proposed *Performance Solutions* and the supporting analysis is required or not, must be undertaken at this *PBDB* stage.

Explanatory information:

When developing a *Performance Solution*, a *PBDB* is an important step in the process. It allows all relevant stakeholders to be involved in the development of the building design and its *fire safety system*.

A *PBDB* is a documented process that defines the scope of work for the fire engineering analysis. Its purpose is to set down the basis, as agreed by the relevant stakeholders, on which the fire safety analysis of the proposed building and its *Performance Solutions* will be undertaken.

Relevant stakeholders will vary from design to design. However, some examples of relevant stakeholders are: a fire safety engineer, architect, developer, client, *appropriate authority* (some state legislation prevents *appropriate authorities* from being involved in the design process), fire authority and other stakeholders that fire safety design may affect such as insurers. Further information on the relevant stakeholders is provided in Clause 1.3.1.2.

Guidance on the development of a *PBDB* is presented in the International Fire Engineering Guidelines (2005) and referred to as a Fire Engineering Brief in that document.

1.3.1.1 Fire strategy

The *PBDB* must cover the fire safety strategy for the building, outlining the philosophy and approach that will be adopted to achieve the required level of performance. The fire safety strategy must pay particular attention to the evacuation strategy to be used and the management regimes necessary.

1.3.1.2 Stakeholder involvement

The *PBDB* must be developed collaboratively by the relevant stakeholders in the particular project. The following parties must be involved:

- Client or client's representative (such as project manager)
- Fire engineer
- Architect or designer
- Various specialist consultants
- Fire service (public or private)
- *Appropriate authority* (Authority Having Jurisdiction – subject to state legislation)
- Tenants or tenants representative for the proposed building (if available)
- Building operations management (if available).

Conducting a simple stakeholder analysis can be used to determine who must be involved in the *PBDB* process. This analysis must identify stakeholders with a high level of interest in the design process, and/or likely to be affected by the consequences of a fire should it occur in the building.

1.3.1.3 Required level of safety

Given the absence of specific safety targets in the NCC and the qualitative nature of the NCC fire safety *Performance Requirements*, for this *Verification Method* to ensure the level of safety expected, the proposed building design must be at least equivalent to the relevant *Deemed-to-Satisfy Provisions*.

As the NCC *Deemed-to-Satisfy Provisions* evolved originally from State and Territory regulations and are regularly

Fire Safety Verification Method

updated to reflect technical advances and experience they are commonly accepted as providing an acceptable benchmark. It is accepted that the NCC *Deemed-to-Satisfy Provisions* reflect societal expectations in terms of fire safety, which address individual risk, societal risk and the robustness in the design by adopting a defence in depth approach.

In the majority of *design scenarios* the *Verification Method* requires a demonstration that the proposed level of safety is at least equivalent to the *Deemed-to-Satisfy Provisions*. In relation to the required level of safety the *PBDB* process must—

- (a) identify the relevant *Deemed-to-Satisfy Provisions* to be used in the equivalency process to determine whether the relevant *Performance Requirements* have been met; and
- (b) consider the specific size, complexity and use of the building with regards to the *Deemed-to-Satisfy Provisions* to be used in the equivalency process; and
- (c) consider the specific occupant profile of the building, paying particular attention to occupants with a disability and the vulnerable, in regards to the *Deemed-to-Satisfy Provisions* to be used in the equivalency process.

1.3.2 Final report

Once the analysis of all relevant *design scenarios* for all the required *Performance Solutions* has been completed, the fire safety engineer must prepare a final report that includes the following:

- The agreed *PBDB*.
- All modelling and analysis.
- Analysis required to demonstrate that the proposed building provides a level of safety at least equivalent to the relevant *Deemed-to-Satisfy Provisions*.
- Any other information required to clearly demonstrate that the building and its *fire safety system* satisfies the relevant *Performance Requirements* as set out in *Table 1.1*.

1.4 Design scenarios: NCC Performance Requirements

This *Verification Method* presents specific *design scenarios* that must be considered in order to demonstrate that the fire safety aspects of a building design comply with the fire safety *Performance Requirements* set out in [Table 1.1](#).

The *design scenarios* specified in Section 2 are summarised in [Table 1.1](#).

Table 1.1 Key features of design scenarios

<i>Design scenario</i>	<i>Performance Requirement</i> Note 1	<i>Outcome required</i> Note 3	<i>Typical method or solution</i>
BE Fire blocks <i>evacuation route</i> (2.1). [A fire blocks an <i>evacuation route</i>]	CP1, CP2, CP3, CP8, DP4, DP5, DP6, DP7 ^{Note 2} , EP1.4, EP2.1, EP2.2, EP4.1, EP4.2, EP4.3	Demonstrate that the level of safety is at least equivalent to the <i>Deemed-to-Satisfy Provisions</i> .	Demonstrate that a viable <i>evacuation route</i> (or multiple <i>evacuation routes</i> where necessary) has been provided for building occupants.
UT Fire in a normally unoccupied room threatens occupants of other rooms (2.2). [A fire starts in a normally unoccupied room and can potentially endanger a large number of occupants in another room]	CP1, CP2, CP3, CP8, DP4, DP5, EP1.4, EP2.1, EP2.2, EP4.1, EP4.2, EP4.3	Demonstrate that the level of safety is at least equivalent to the <i>Deemed-to-Satisfy Provisions</i> .	<i>ASET / RSET</i> analysis or provide separating construction or fire suppression complying with a specified Standard. Solutions might include the use of <i>separating elements</i> or fire suppression to confine the fire to the room of origin.
CS Fire starts in concealed space (2.3). [A fire starts in a concealed space that can facilitate fire spread and potentially endanger a large number of people in a room]	CP1, CP2, CP3, CP6, CP8, DP4, DP5, DP6, EP1.4, EP2.1, EP2.2, EP4.1, EP4.2, EP4.3	Demonstrate that fire spread via concealed spaces will not endanger occupants; and Demonstrate that the level of safety is at least equivalent to the <i>Deemed-to-Satisfy Provisions</i> .	Solutions might include providing separating construction or fire suppression or <i>automatic</i> detection complying with a specified Standard.
SF Smouldering fire (2.4). [A fire is smouldering in close proximity to a sleeping area]	CP2, CP3, CP8, DP4, DP5, DP6, EP1.1, EP1.2, EP1.3, EP1.4, EP2.1, EP2.2, EP4.1, EP4.2, EP4.3	Demonstrate that the level of safety is at least equivalent to the <i>Deemed-to-Satisfy Provisions</i> .	Solutions might include providing <i>automatic</i> detection and alarm system complying with a recognised Standard.
HS Horizontal fire spread (2.5). [A <i>fully developed fire</i> in a building exposes the <i>external walls</i> of a neighbouring building]	CP2	Demonstrate that the risk of fire spread between buildings is not greater than buildings complying with the <i>Deemed-to-Satisfy Provisions</i> .	CV1, CV2.
VS Vertical fire spread involving cladding or arrangement of openings in walls (2.6). [A fire source exposes a wall and leads to significant vertical fire spread]	CP2, CP4, CP7, CP8, EP2.2	Demonstrate that the building's external cladding / facade and arrangement of openings in the building do not increase the risk to life resulting from a fire beyond that for a similar building complying with the <i>Deemed-to-Satisfy Provisions</i> .	CV3.
IS Fire spread involving	CP2, CP4, DP4, DP5, DP6, EP1.1, EP1.4, EP2.1,	Maintain tenable conditions to allow time for evacuation	<i>ASET / RSET</i> analysis or equivalent growth and

Fire Safety Verification Method

Design scenario	Performance Requirement Note 1	Outcome required Note 3	Typical method or solution
internal finishes (2.7). [Interior surfaces are exposed to a growing fire that potentially endangers occupants].	EP2.2, EP4.1, EP4.2, EP4.3	of occupants and to facilitate <i>fire brigade</i> intervention; and Demonstrate that the level of safety is at least equivalent to the <i>Deemed-to-Satisfy Provisions</i> .	species production rates.
FI <i>Fire brigade</i> intervention (2.8). [Consider <i>fire brigade</i> intervention]	CP1, CP2, CP5, CP7, CP9, DP5, EP1.3, EP1.6, EP2.2, EP3.2	Demonstrate consideration of potential <i>fire brigade</i> intervention; and Demonstrate that the level of safety is at least equivalent to the <i>Deemed-to-Satisfy Provisions</i> .	Facilitate <i>fire brigade</i> intervention to the degree necessary.
UF Unexpected Catastrophic Failure (2.9). [A building must not unexpectedly collapse during a fire event]	CP1, CP2, CP9	Demonstrate that the building, its critical elements and the <i>fire safety system</i> provide sufficient robustness such that unexpected catastrophic failure is unlikely; and Demonstrate that the level of safety is at least equivalent to the <i>Deemed-to-Satisfy Provisions</i> .	Undertake review or risk assessment of critical elements within a building to determine unexpected catastrophic failure is unlikely.
CF Challenging fire (2.10). [Worst credible fire]	CP1, CP2, CP3, CP8, DP4, DP5, DP6, EP1.1, EP1.2, EP1.3, EP1.4, EP2.1, EP2.2, EP4.1, EP4.2, EP4.3	Demonstrate that the level of safety is at least equivalent to the <i>Deemed-to-Satisfy Provisions</i> .	<i>ASET / RSET</i> analysis.
RC Robustness check (2.11). [Failure of a critical part of the <i>fire safety systems</i> will not result in the design not meeting the Objectives of the BCA]	CP1, CP2, CP3, CP8, DP4, DP5, DP7 ^{Note 2} , EP1.1, EP1.2, EP1.3, EP1.4, EP2.1, EP2.2, EP4.1, EP4.2, EP4.3	Demonstrate that if a key component of the <i>fire safety system</i> fails, the design is sufficiently robust that a disproportionate spread of fire does not occur (e.g. <i>ASET / RSET</i> for the remaining floors or <i>fire compartments</i> is satisfied); and Demonstrate that the level of safety is at least equivalent to the <i>Deemed-to-Satisfy Provisions</i> .	Modified <i>ASET / RSET</i> analysis.
SS Structural Stability and other properties (2.12). [Building does not present risk to other properties in a fire event]	CP1, CP5	Demonstrate that the building does not present an unacceptable risk to other property due to collapse or barrier failure resulting from a fire; and Demonstrate that the level of safety is at least equivalent to the <i>Deemed-to-Satisfy Provisions</i> .	Undertake analysis of structure and <i>fire safety systems</i> .

Notes to Table 1.1:

- Not all of these requirements will always be applicable to this *design scenario*. The project specific *Performance Requirements* must be determined as part of the *performance-based design brief* process.

Fire Safety Verification Method

2. Appropriate analysis of DP7 is also required where a lift is intended to be used to assist occupants to evacuate.
3. When *required* to demonstrate that the level of safety is at least equivalent to the *Deemed-to-Satisfy Provisions* refer to [Clause 1.3.1.3](#).

Table 1.2 List of Performance Requirements and relevant design scenario

<i>Performance Requirement</i>	<i>Design scenario</i>
CP1	BE, UT, CS, FI, UF, CF, RC, SS
CP2	BE, UT, CS, SF, HS, IS, FI, CF, RC, UF, VS
CP3	BE, UT, CS, SF, CF, RC
CP4	IS, VS
CP5	FI, SS
CP6	CS
CP7	FI, VS
CP8	BE, UT, CS, SF, CF, RC, VS
CP9	FI, UF
DP4	BE, UT, CS, SF, IS, CF, RC
DP5	BE, UT, CS, SF, IS, FI, CF, RC
DP6	BE, CS, SF, IS, CF, RC
DP7	BE, RC
EP1.1	SF, IS, CF, RC
EP1.2	SF, CF, RC
EP1.3	SF, FI, CF, RC
EP1.4	BE, UT, CS, SF, IS, CF, RC
EP1.6	FI
EP2.1	BE, UT, CS, SF, IS, CF, RC
EP2.2	BE, UT, CS, SF, IS, FI, CF, RC, VS
EP3.2	FI
EP4.1	BE, UT, CS, SF, IS, CF, RC
EP4.2	BE, UT, CS, SF, IS, CF, RC
EP4.3	BE, UT, CS, SF, IS, CF, RC

1.5 Fire modelling to determine ASET

For particular *design scenarios*, the designer must demonstrate that the occupants have sufficient time to evacuate the building before being overcome by the effects of fire.

In *fire safety engineering* terms, the *ASET* must be greater than the *RSET*.

ASET is defined as the time between ignition of the *design fire* and the time when the first tenability criterion is exceeded in a specified room within the building. The tenability parameters measured at a height of 2 m above floor level, are—

- (a) a *FED* of thermal effects greater than 0.3; or
- (b) conditions where, due to smoke obscuration, *visibility* is less than 10 m except in rooms of less than 100 m² or where the distance to an *exit* is 5 m or less, where *visibility* may fall to 5 m.

Explanatory information:

Visibility is generally the first tenability criterion exceeded in calculations unless any exception is applied.

Calculate the *ASET* by modelling the fire using the *design fire* as specified. In most cases there will be a number of locations for the fire that could produce the lowest *ASET* for a given escape route. Check a number of rooms to determine the limiting case.

It must be demonstrated that the proposed level of safety is at least equivalent to that provided by a building compliant with the *Deemed-to-Satisfy Provisions*.

2.1 Design scenario (BE)

Fire blocks evacuation route

Design scenario in brief

A fire starts in an *evacuation route* and can potentially block the *evacuation route*.

Required outcome

Demonstrate that the level of safety is at least equivalent to the *Deemed-to-Satisfy Provisions*.

2.1.1 Design scenario description

This *design scenario* addresses the concern that an *evacuation route* may be blocked due to proximity of the fire source. For each room/space within the building, assume that the fire source is located near the primary *evacuation route* and that it prevents occupants from leaving the building by that route. Fire in *evacuation routes* can be the result of an accidental or deliberately lit fire.

In order to be regarded as alternative *evacuation routes*, the *evacuation routes* must be separated from each other and must remain separated until reaching a final *exit* in accordance with D1.5, or as demonstrated equivalent through analysis.

Active and passive *fire safety systems* in the building must be assumed to perform as intended by the design.

Explanatory information:

The fire safety engineer needs to consider fire source locations that prevent the use of *exits* in *evacuation routes*.

Fire characteristics (e.g. HRR) and analysis need not be considered in this *design scenario* as the fire is assumed to physically block the *evacuation route*. It may be assumed that occupant tenability criteria cannot be met where fire plumes and flames block an *evacuation route*.

2.1.2 Typical method or solution

The requirements of this *design scenario* can be demonstrated by analysis that checks whether or not a second *evacuation route* is required.

2.2 Design scenario (UT)

Fire in normally unoccupied room threatening occupants of other rooms

Design scenario in brief

A fire starts in a normally unoccupied room and can potentially endanger a large number of occupants in another room.

Required outcome

Demonstrate that the level of safety is at least equivalent to the *Deemed-to-Satisfy Provisions*.

2.2.1 Design scenario description

This *design scenario* only applies to buildings with rooms or spaces that could be threatened by a fire occurring in another normally unoccupied space. Such rooms or spaces must include those rooms or spaces physically adjacent to the unoccupied room as well as rooms or spaces that are a farther distance and are not fire separated; or rooms or spaces from which occupants or slower evacuees have to pass through a potentially threatened room or space adjacent to the unoccupied room. It does not need to be satisfied for any other rooms or spaces in the building.

A fire starting in an unoccupied space can grow to a significant size undetected and then spread to other areas where people may be present or where people are young, elderly or have a disability and will take longer to evacuate. This *design scenario* is intended to address concern regarding fire starting in a normally unoccupied room and then migrating into space(s) potentially holding occupants.

The analysis must assume that the target space containing occupants is filled to capacity under normal use or otherwise contains occupants with longer evacuation times.

For analysis, select a *design fire* for the applicable occupancy. Active and passive *fire safety systems* in the building must be assumed to perform as intended by the design.

2.2.2 Typical method or solution

Either—

- (a) carry out *ASET* / *RSET* analysis to show that the occupants within target spaces are not exposed to untenable conditions, or
- (b) include *separating elements* or fire suppression to confine the fire to the room of origin.

2.3 Design scenario (CS)

Fire starts in a concealed space

Design scenario in brief

A fire starts in a concealed space that can potentially endanger people in another room or in the room of fire origin.

Required outcome

Demonstrate that fire spread via concealed spaces will not endanger occupants located in other rooms / spaces; and
Demonstrate that the proposed level of safety is at least equivalent to the *Deemed-to-Satisfy Provisions*.

2.3.1 Design scenario description

This *design scenario* only applies to buildings with rooms or spaces that could be threatened by a fire occurring in a concealed space. Such rooms or spaces must include those rooms or spaces physically adjacent to the concealed space as well as rooms or spaces that are a farther distance and are not fire separated; or rooms or spaces where slower evacuees have to pass through a potentially threatened room or space adjacent to the concealed space. It does not need to be satisfied for any other rooms or spaces in the building.

A fire starting in a concealed space can develop undetected and spread to endanger a large number of occupants in another room. This *design scenario* addresses concern that a fire originating in a non-separated concealed space without either a detection system or suppression system could spread into a room within the building potentially holding a large number of occupants.

Assume that active and passive *fire safety systems* in the building perform as intended by the design.

Explanatory information:

Fire spreading in concealed spaces may also compromise the ability of firefighters to assess the threat to themselves whilst undertaking rescue and firefighting operations.

2.3.2 Typical method or solution

If a calculation approach using this *Verification Method* is used, the expected solution will most likely be to—

- (a) use *separating elements* or suppression to confine fire to the concealed space, or
- (b) include *automatic* detection of heat or smoke to provide early warning of fire within the concealed space, or
- (c) a combination of (a) and (b).

2.4 Design scenario (SF)

Smouldering fire

Design scenario in brief

A fire is smouldering in close proximity to a sleeping area.

Required outcome

Provide a safe sleeping area.

Demonstrate that the level of safety be at least equivalent to the *Deemed-to-Satisfy Provisions*.

2.4.1 Design scenario description

This *design scenario* addresses the concern regarding a slow, smouldering fire that causes a threat to sleeping occupants. Assume that active and passive *fire safety systems* in the building perform as intended by the design.

2.4.2 Typical method or solution

The expected methodology is to either—

- (a) use *separating elements* to confine the fire to the space of origin (assuming it is a separate space from the sleeping area), or
- (b) include *automatic* detection of smoke in adjacent spaces to provide early warning of fire within an adjoining space.

The *separating elements* must prevent all smoke ingress which, for almost all situations requires a pressure differential between the two spaces in addition to a physical barrier. The pressure differential will have to be sufficient to prevent smoke ingress to the sleeping area.

If the *automatic* detection methodology is chosen, then an *automatic* smoke detection and alarm system must be installed throughout the sleeping and adjoining spaces.

2.5 Design scenario (HS)

Horizontal fire spread

Design scenario in brief

A *fully developed fire* in a building exposes the *external walls* of a neighbouring building or *fire compartment* and a *fully developed fire* in the neighbouring building exposing the opening in the *external walls* of the building.

Required outcome

Demonstrate that the risk of fire spread between buildings is not greater than buildings complying with the *Deemed-to-Satisfy Provisions*.

2.5.1 Design scenario description

This *design scenario* describes the requirements for a building to prevent horizontal fire spread to and from an adjacent building or *fire compartment*.

2.5.2 Typical method or solution

Demonstrate compliance with *CV1* and *CV2*.

2.6 Design scenario (VS)

Vertical fire spread involving external cladding or external openings

Design scenario in brief

A fire source exposes the *external wall* or arrangement of openings in a building and leads to significant vertical fire spread.

Required outcome

Demonstrate that the building's external cladding / facade and arrangement of openings in the building do not increase the risk to life resulting from a fire beyond that for a similar building complying with the *Deemed-to-Satisfy Provisions*.

2.6.1 Design scenario description

This *design scenario* applies to all buildings where there is a risk of vertical fire spread.

Comment:

This *design scenario* is not concerned with building-to-building fire spread across a relevant boundary, as this is addressed in the *design scenario*: HS (see 2.5).

2.6.2 Method

Demonstrate compliance with *CV3*.

2.7 Design scenario (IS)

Rapid fire spread involving internal surface linings

Design scenario in brief

Interior surfaces are exposed to a growing fire that potentially endangers building occupants.

Required outcome

Demonstrate that the level of safety be at least equivalent to the [Deemed-to-Satisfy Provisions](#).

2.7.1 Design scenario description

The performance criteria required for lining materials will depend on their location within a building, and the use of the building.

2.7.2 Typical method or solution

Linings, materials and assemblies in Class 2 to 9 buildings must comply with the appropriate provisions in NCC Volume One Specification C1.10 [Table 1](#) or be demonstrated to provide equivalent performance with respect to the performance criteria prescribed in the referenced test standards.

2.8 Design scenario (FI)

Fire brigade intervention

Design scenario in brief

This *design scenario* allows for *fire brigade* intervention.

Required outcome

Demonstrate that the *fire brigade* can undertake *fire brigade* intervention until completion of search and rescue activities; and

Demonstrate that the level of safety be at least equivalent to the *Deemed-to-Satisfy Provisions*.

2.8.1 Design scenario description

The purpose of this *design scenario* is to describe—

- (a) the fire event the *fire brigade* is expected to face at its estimated time of arrival; and
- (b) the scope of available fire-fighting facilities relative to the risk to building occupant safety and adjacent buildings; and
- (c) the ability for the *fire brigade* to complete search and rescue activities relevant to the available firefighting activities; and
- (d) the ability of the *fire brigade* to control or suppress a fire.

Explanatory information:

This *design scenario* is intended to be used in conjunction with the UF *design scenario* (See 2.9). These two *design scenarios* will demonstrate that facilities for *fire brigade* intervention are appropriately incorporated.

2.8.2 Typical method or solution

This *design scenario* only applies to buildings located within 50 km road travel of a fire station.

Compliance with this *design scenario* is demonstrated via application of the Australasian Fire and Emergency Service Authorities Council's (AFAC) Fire Brigade Intervention Model and modelling the fire and smoke development, in accordance with the CF *design scenario* (2.10).

Facilities for firefighting must be provided in accordance with Table 2.8, appropriate to the fire and smoke development at the estimated time of suppression activities.

Table 2.8 Facilities for fire brigade intervention

Facilities for fire brigade intervention	Building with sprinkler protection	Building without sprinkler protection
<i>Fire brigade</i> external access	Yes	Yes
Tenability to enable identification and access to seat of fire	Yes	Yes
Fire hydrants – internal required	Yes if > than 100 m to all points, and / or > 3 levels	Yes if > than 70 m to all points, and / or > 3 levels
Fire hydrants – external required	Yes	Yes
Command and control provisions	Yes if > 3 levels	Yes
Access to normally occupied areas for search and rescue	Yes if more than 50 persons occupy building	Yes

2.9 Design scenario (UF)

Unexpected catastrophic failure

Design scenario in brief

The design will be suitably robust to prevent catastrophic structural failure in a fire.

Required outcome

Demonstrate that disproportionate failure does not occur for the duration of the fire event; and
Demonstrate that the level of safety be at least equivalent to the *Deemed-to-Satisfy Provisions*.

2.9.1 Design scenario description

The fundamental principles of the UF *design scenario* are that the building structure and/or critical elements should not suffer unexpected disproportionate failure during a fire event. This *design scenario* for the prevention of unexpected catastrophic failure aligns with the principles of structural robustness.

The unexpected catastrophic failure *design scenario* is intended to prevent unexpected catastrophic failure of a building component as a result of a fire event.

This *design scenario* assessment must be undertaken in conjunction with the structural engineer, to ensure that unexpected catastrophic failure should not occur for all critical elements. Ductility of the structure must also be considered so that visual cues that act as a warning occur prior to collapse.

Comment:

This *design scenario* is intended to be used in conjunction with the fire brigade intervention (FI) *design scenario*. These two *design scenarios* will ensure that facilities for *fire brigade* intervention are appropriately incorporated.

2.9.2 Typical method or solution

Compliance with this *design scenario* is achieved by demonstrating that the building structure and components have considered the following elements during a fire event:

- (a) Assessment of the building structure and critical components such that upon the notional removal, in isolation, due to the fire event the probability of unexpected catastrophic failure of the entire element, or a significant proportion, is unlikely to occur.
- (b) Demonstrating that if a component of the building is relied upon to carry a significant portion of the total structure, a systematic risk assessment of the building is undertaken and critical high risk components are identified. High risk components are designed to cope with the identified hazard or protective measures chosen to minimise the risk during a fire event. The proportion of the structure that triggers this analysis will have a range that the designer will have to identify and justify.

2.10 Design scenario (CF)

Challenging fire

Design scenario in brief

A fire starts in a normally occupied space and presents a challenge to the building's *fire safety systems*, threatening the safety of occupants.

Required outcome

Demonstrate that the level of safety be at least equivalent to the *Deemed-to-Satisfy Provisions*.

2.10.1 Design scenario description

The challenging fires are intended to represent the credible worst case *design scenario* in normally occupied spaces that will challenge the fire protection features of the building.

This *design scenario* requires the use of *design fires* in various locations within the building.

The *design fires* must be characterised with a steady state fire, or a power law HRR, peak HRR and FLED. Design values for *yields* are specified for soot/smoke.

The *design fires* must be modified during an analysis (depending on the methodology used) to account for building ventilation and the effects of *automatic* fire suppression systems (if any) on the fire. The *design scenario* RC (2.11) will require the overall robustness of the design to be examined separately.

The designer must—

- (a) for each location of the challenging fire, use a single fire source to evaluate the building's protection measures; and
- (b) consider the impact on occupants who may be using escape routes external to the building as well as internal routes; and
- (c) assume that active and passive *fire safety systems* in the building will perform as intended by the design.

Explanatory information:

Both CF and SS *design scenarios* refer to credible worst case *design fires*. These may not necessarily be the same *design fire*, as they relate to different safety systems of the building.

2.10.2 Typical method or solution

This *design scenario* requires the *ASET / RSET* analysis of the impact on all building occupants with *design fires* located in various locations within the building, except for those rooms or spaces excluded in the *design scenario* described above.

The designer must calculate the fire environment in the *evacuation routes* over the period of time the occupants require to escape. Assess the fire environment based on the *FED* and *visibility* at the location of the occupants.

The designer must select a fire calculation model appropriate to the complexity and size of the building/space that allows the *FED* and *visibility* to be determined.

2.11 Design scenario (RC)

Robustness check

Design scenario in brief

The fire design will be checked to ensure that the failure of a critical part of the *fire safety system* will not result in the design not meeting the *Performance Requirements*.

Required outcome

Demonstrate that if a single *fire safety system* fails, the design is sufficiently robust that disproportionate spread of the fire does not occur (e.g. *ASET* / *RSET* for the remaining floors or *fire compartments* is satisfied); and

Demonstrate that the level of safety be at least equivalent to the *Deemed-to-Satisfy Provisions*.

2.11.1 Design scenario description

This *design scenario* applies where failure of a key *fire safety system* could expose occupants to untenable conditions. The key fire safety systems must be agreed as part of the *PBDB*.

Comment:

The key fire safety systems to be considered must be agreed as part of the *PBDB*.

This particular *design scenario* focuses on the *ASET* / *RSET* life safety calculations performed as part of the *design scenario* CF challenging fire (2.10).

The robustness of the design must be tested by considering the *design fire* with each key *fire safety system* rendered ineffective in turn.

Where the probability of failure of a single system failure is low and it is impractical to provide additional redundancies it may be acceptable to accept some exposure of occupants to untenable conditions. An appropriate deemed-to-satisfy building should be used to provide a benchmark.

Explanatory information:

Ideally, a comprehensive quantitative probabilistic risk assessment would be used to assess the safety of a design. However, the risk assessment tools and supporting data have not been included in this *Verification Method*. The framework currently permits a simple deterministic *ASET* / *RSET* approach with additional checks and balances.

As a general rule, when calculating *ASET* times, *fire safety systems* may be assumed to operate as designed, provided they are manufactured and installed in accordance with recognised national or international standards. However, in the situations designed above, additional *fire safety systems* provide the redundancy and robustness to fire safety designs.

2.11.2 Typical method or solution

In the circumstances described in the *design scenario*, assume the failure of each key *fire safety system* in turn as determined by the *PBDB*. If *ASET* cannot be shown to be greater than *RSET* for the building, apart from the room of fire origin, then the design must be altered until the requirements for *ASET* and *RSET* are achieved.

2.12 Design Scenario (SS)

Structural stability and other property

Design scenario in brief

The fire design is used to demonstrate that the structural response of a building in a credible worst case *design scenario* does not present an unacceptable risk to *other property*.

Required outcome

Demonstrate that the building does not present an unacceptable risk to *other property* due to collapse or barrier failure resulting from a fire; and

Demonstrate that the level of safety be at least equivalent to the *Deemed-to-Satisfy Provisions*.

2.12.1 Design scenario description

Comment:

A fundamental requirement of CP1 and CP2 is that a building should not present a risk to *other property* in a fire event. The purpose of this *design scenario* is to demonstrate that a building does not present a risk to *other property* during a fire event that has the potential to impact on the building's structure.

Unlike the CF *design scenario*, the worst credible case fire for this *design scenario* must be located within any space of the building rather than only within an occupied space. It is likely that several different fire design locations will be required to be tested to determine the location of the worst credible case fire.

The designer must—

- (a) for each location of the *design fire*, use a single fire source to evaluate the building's protection measures; and
- (b) consider the impact on occupants who may be using *evacuation routes* external to the building as well as internal routes.

Explanatory information:

Both CF and SS *design scenarios* refer to credible worst case *design fires*. These may not necessarily be the same *design fire*, as they relate to different safety systems of the building.

2.12.2 Typical method or solution

The impact of a fully developed fire in the worst-case location on the structural stability of a building must be assessed.

Simultaneous and individual failures of active fire suppression systems (if provided), delayed *fire brigade* intervention and premature failure of structural fire protection should be considered and probabilities assigned to the occurrence of each of the events and the outcomes predicted.

If a simplistic approach is adopted the outcomes and probabilities of each combination of outcomes should be predicted and compared with a deemed-to-satisfy benchmark building.

Explanatory information:

Typically the fire safety engineer, with the assistance of a structural engineer, would demonstrate that appropriate features have been incorporated into the building which either—

- (a) ensure the risk of collapse is equivalent or less than a similar deemed-to-satisfy structure; and
- (b) there is no increased risk from outward structural collapse compared to a similar deemed-to-satisfy structure; and
- (c) the risk to life for the subject building is no greater than that for a similar deemed-to-satisfy structure.

History of adoption

History of adoption

History of adoption

History of adoption

- 1.0 Adoption of BCA96
- 1.1 Amendment No. 1
- 1.2 Amendment No. 2
- 1.3 Amendment No. 3
- 1.4 Amendment No. 4
- 1.5 Amendment No. 5
- 1.6 Amendment No. 6
- 1.7 Amendment No. 7
- 1.8 Amendment No. 8
- 1.9 Amendment No. 9
- 1.10 Amendment No. 10
- 1.11 Amendment No. 11
- 1.12 Amendment No. 12
- 1.13 Amendment No. 13
- 2.0 Adoption of BCA 2004
- 3.0 Adoption of BCA 2005
- 4.0 Adoption of BCA 2006
- 5.0 Adoption of BCA 2007
- 6.0 Adoption of BCA 2008
- 7.0 Adoption of BCA 2009
- 8.0 Adoption of BCA 2010
- 9.0 Adoption of BCA 2011
- 10.0 Adoption of BCA 2012
- 11.0 Adoption of BCA 2013
- 12.0 Adoption of BCA 2014
- 13.0 Adoption of BCA 2015
- 14.0 Adoption of NCC Volume One 2016
- 14.1 Amendment No. 1
- 15.0 Adoption of NCC Volume One 2019
- 15.1 Amendment No. 1

History of adoption

1.0 Adoption of BCA96

The 1996 edition of the BCA was adopted as set out in Table Amdt 1.0.

Table 1.0 History of adoption of BCA96

Administration	Adoption Date
Australian Government	1 July 1997
Australian Capital Territory	1 July 1997
New South Wales	1 July 1997
Northern Territory	7 January 1998
Queensland	1 July 1997
South Australia	1 January 1998
Tasmania	1 July 1997
Victoria	1 August 1997
Western Australia	1 July 1997

1.1 Amendment No. 1

(a) Amendment No. 1 of the 1996 edition of the BCA was adopted as set out in Table 1.1.

Table 1.1 History of adoption of Amendment No. 1 of the BCA96

Administration	Adoption Date
Australian Government	1 July 1997
Australian Capital Territory	1 July 1997
New South Wales	1 July 1997
Northern Territory	7 January 1998
Queensland	1 July 1997
South Australia	1 January 1998
Tasmania	1 July 1997
Victoria	1 August 1997
Western Australia	1 July 1997

(b) The purpose of Amendment No. 1 is to—

- (i) correct minor typographical errors including spelling, punctuation and layout; and
- (ii) include reference to a Certificate of Conformity issued by the ABCB in A2.2; and
- (iii) change the reference to the Standards Mark Certificate to refer to JAS–ANZ in A2.2; and
- (iv) update references to Standards.

Note:

Only substantive typographical corrections are noted in the margin.

1.2 Amendment No. 2

(a) Amendment No. 2 of the 1996 edition of the BCA was adopted as set out in Table 1.2.

Table 1.2 History of adoption of Amendment No. 2 of the BCA96

Administration	Adoption Date
Australian Government	1 January 1998
Australian Capital Territory	1 January 1998

History of adoption

Administration	Adoption Date
New South Wales	27 February 1998
Northern Territory	7 January 1998
Queensland	1 January 1998
South Australia	1 January 1998
Tasmania	1 January 1998
Victoria	1 January 1998
Western Australia	1 January 1998

- (b) The purpose of Amendment No. 2 is to—
- (i) correct minor typographical errors; and
 - (ii) update references to Standards.

1.3 Amendment No. 3

- (a) Amendment No. 3 of the 1996 edition of the BCA was adopted as set out in Table 1.3.

Table 1.3 History of adoption of Amendment No. 3 of the BCA96

Administration	Adoption Date
Australian Government	1 July 1998
Australian Capital Territory	1 July 1998
New South Wales	1 July 1998
Northern Territory	1 July 1998
Queensland	1 July 1998
South Australia	13 July 1998
Tasmania	1 July 1998
Victoria	1 July 1998
Western Australia	1 July 1998

- (b) The purpose of Amendment No. 3 is to—
- (i) incorporate the outcomes of the 1997 ABCB Variations Conference; and
 - (ii) update references to Standards; and
 - (iii) include minor technical changes.

1.4 Amendment No. 4

- (a) Amendment No. 4 of the 1996 edition of the BCA was adopted by the Australian Government, States and Territories as set out in Table 1.4.

Table 1.4 History of adoption of Amendment No. 4 of the BCA96

Administration	Adoption Date
Australian Government	1 January 1999
Australian Capital Territory	17 May 1999
New South Wales	1 February 1999
Northern Territory	1 January 1999
Queensland	1 January 1999
South Australia	1 January 1999
Tasmania	1 January 1999
Victoria	1 January 1999
Western Australia	1 January 1999

- (b) The purpose of Amendment No. 4 is to—
- (i) update references to Standards; and

History of adoption

- (ii) include minor technical changes.

Note:

Only substantive typographical corrections are noted in the margin.

1.5 Amendment No. 5

- (a) Amendment No. 5 of the 1996 edition of the BCA was adopted as set out in Table 1.5.

Table 1.5 History of adoption of Amendment No. 5 of the BCA96

Administration	Adoption Date
Australian Government	1 July 1999
Australian Capital Territory	3 November 1999
New South Wales	1 August 1999
Northern Territory	1 July 1999
Queensland	1 July 1999
South Australia	1 July 1999
Tasmania	1 July 1999
Victoria	1 July 1999
Western Australia	1 July 1999

- (b) The purpose of Amendment No. 5 is to—
- (i) update references to Standards; and
 - (ii) include minor technical changes; and
 - (iii) amend clauses to improve clarity and to reduce the possibility of differences in interpretation; and
 - (iv) expand on the requirements for subfloor ventilation based on climatic conditions.

Note:

Only substantive typographical corrections are noted in the margin.

1.6 Amendment No. 6

- (a) Amendment No. 6 of the 1996 edition of the BCA was adopted as set out in Table 1.6.

Table 1.6 History of adoption of Amendment No. 6 of the BCA96

Administration	Adoption Date
Australian Government	1 January 2000
Australian Capital Territory	10 February 2000
New South Wales	1 January 2000
Northern Territory	1 January 2000
Queensland	1 January 2000
South Australia	17 January 2000
Tasmania	1 January 2000
Victoria	1 January 2000
Western Australia	1 January 2000

- (b) The purpose of Amendment No. 6 is to—
- (i) update references to Standards; and
 - (ii) expand on the requirements for carparking for people with disabilities; and
 - (iii) replace Sound Transmission Class (STC) with weighted sound reduction index (R_w) within Part F5; and
 - (iv) include minor technical changes.

History of adoption

Note:

Only substantive typographical corrections are noted in the margin.

1.7 Amendment No. 7

(a) Amendment No. 7 of the 1996 edition of the BCA was adopted as set out in Table 1.7.

Table 1.7 History of adoption of Amendment No. 7 of the BCA96

Administration	Adoption Date
Australian Government	1 July 2000
Australian Capital Territory	10 July 2000
New South Wales	1 July 2000
Northern Territory	1 July 2000
Queensland	1 July 2000
South Australia	1 July 2000
Tasmania	1 July 2000
Victoria	1 July 2000
Western Australia	1 July 2000

(b) The purpose of Amendment No. 7 is to—

- (i) update references to Standards; and
- (ii) include requirements for non-required and private stairways; and
- (iii) include minor technical changes.

Note:

Only substantive typographical corrections are noted in the margin.

1.8 Amendment No. 8

(a) Amendment No. 8 of the 1996 edition of the BCA was adopted as set out in Table 1.8.

Table 1.8 History of adoption of Amendment No. 8 of the BCA96

Administration	Adoption Date
Australian Government	1 January 2001
Australian Capital Territory	11 January 2001
New South Wales	1 January 2001
Northern Territory	1 January 2001
Queensland	1 January 2001
South Australia	1 January 2001
Tasmania	1 January 2001
Victoria	1 January 2001
Western Australia	1 January 2001

(b) The purpose of Amendment No. 8 is to—

- (i) update references to Standards; and
- (ii) include minor technical changes; and
- (iii) achieve greater consistency between both Volumes of the BCA for stairway construction.

Note:

Only substantive typographical corrections are noted in the margin.

History of adoption

1.9 Amendment No. 9

(a) Amendment No. 9 of the 1996 edition of the BCA was adopted as set out in Table 1.9.

Table 1.9 History of adoption of Amendment No. 9 of the BCA96

Administration	Adoption Date
Australian Government	1 July 2001
Australian Capital Territory	12 July 2001
New South Wales	1 July 2001
Northern Territory	1 July 2001
Queensland	1 July 2001
South Australia	2 July 2001
Tasmania	1 July 2001
Victoria	1 July 2001
Western Australia	1 July 2001

(b) The purpose of Amendment No. 9 is to—

- (i) update references to Standards; and
- (ii) include minor technical changes; and
- (iii) clarify which glazed assemblies must comply with AS 2047 and which must comply with AS 1288.

Note:

Only substantive typographical corrections are noted in the margin.

1.10 Amendment No. 10

(a) Amendment No. 10 of the 1996 edition of the BCA was adopted as set out in Table 1.10.

Table 1.10 History of adoption of Amendment No. 10 of the BCA96

Administration	Adoption Date
Australian Government	1 January 2002
Australian Capital Territory	1 January 2002
New South Wales	1 January 2002
Northern Territory	1 January 2002
Queensland	1 January 2002
South Australia	1 January 2002
Tasmania	1 January 2002
Victoria	1 January 2002
Western Australia	1 January 2002

(b) The purpose of Amendment No. 10 is to—

- (i) update references to Standards; and
- (ii) clarify that windows must comply with AS 2047 for resistance to water penetration; and
- (iii) subject to certain conditions, allow a non-fire-isolated stairway to connect an additional storey; and
- (iv) update signage required for people with disabilities, including the need for signs to contain Braille and tactile information; and
- (v) include minor technical changes.

Note:

Only substantive typographical corrections are noted in the margin.

History of adoption

1.11 Amendment No. 11

(a) Amendment No. 11 of the 1996 edition of the BCA was adopted as set out in Table 1.11.

Table 1.11 History of adoption of Amendment No. 11 of the BCA96

Administration	Adoption Date
Australian Government	1 July 2002
Australian Capital Territory	1 July 2002
New South Wales	1 July 2002
Northern Territory	1 July 2002
Queensland	1 July 2002
South Australia	1 July 2002
Tasmania	1 July 2002
Victoria	1 July 2002
Western Australia	1 July 2002

(b) The purpose of Amendment No. 11 is to—

- (i) update references to Standards; and
- (ii) transfer public policy matters, with respect to structural adequacy, from the AS 1170 series to the BCA; and
- (iii) introduce Class 7a, 7b and 9c classifications; and
- (iv) update the provisions for residential buildings used for the accommodation of the aged to align with the Commonwealth Aged Care Act, 1997; and
- (v) include minor technical changes.

Note:

Only substantive typographical corrections are noted in the margin.

1.12 Amendment No. 12

(a) Amendment No. 12 of the 1996 edition of the BCA was adopted as set out in Table 1.12.

Table 1.12 History of adoption of Amendment No. 12 of the BCA96

Administration	Adoption Date
Australian Government	1 January 2003
Australian Capital Territory	1 January 2003
New South Wales	1 January 2003
Northern Territory	1 January 2003
Queensland	1 January 2003
South Australia	1 January 2003
Tasmania	1 January 2003
Victoria	1 January 2003
Western Australia	1 January 2003

(b) The purpose of Amendment No. 12 is to—

- (i) update references to Standards; and
- (ii) apply the swimming pool safety provisions to swimming pools associated with Class 4 parts as well as Class 2 and 3 buildings; and
- (iii) allow the use of either the 1989 editions or the 2002 editions of the 1170 series of standards; and
- (iv) include minor technical changes.

Note:

History of adoption

Only substantive typographical corrections are noted in the margin.

1.13 Amendment No. 13

(a) Amendment No. 13 of the 1996 edition of the BCA was adopted as set out in Table 1.13.

Table 1.13 History of adoption of Amendment No. 13 of the BCA96

Administration	Adoption Date
Australian Government	1 July 2003
Australian Capital Territory	1 July 2003
New South Wales	1 July 2003
Northern Territory	1 July 2003
Queensland	1 July 2003
South Australia	To be advised
Tasmania	1 July 2003
Victoria	1 July 2003
Western Australia	1 July 2003

(b) The purpose of Amendment No. 13 is to—

- (i) update references to Standards; and
- (ii) reform the provisions for fire hazard properties of materials; and
- (iii) revise a requirement for the use of non-combustible materials; and
- (iv) include additional requirements for the protection of electrical switchboards which sustain electricity supply to emergency equipment; and
- (v) include minor changes to the requirements for aged care buildings; and
- (vi) include minor technical changes.

Note:

Only substantive typographical corrections are noted in the margin.

2.0 Adoption of BCA 2004

(a) The 2004 edition of the BCA was adopted as set out in Table 2.0.

Table 2.0 History of adoption of BCA 2004

Administration	Adoption Date
Australian Government	1 May 2004
Australian Capital Territory	1 May 2004
New South Wales	1 May 2004
Northern Territory	1 May 2004
Queensland	1 May 2004
South Australia	1 May 2004
Tasmania	1 May 2004
Victoria	1 May 2004
Western Australia	1 May 2004

(b) The purpose of BCA 2004 is to—

- (i) update references to Standards; and
- (ii) update references from BCA 96 to BCA 2004; and
- (iii) include a Performance Requirement considering human impact with glazing; and
- (iv) reform the provisions for sound insulation; and

History of adoption

- (v) reform the maintenance provisions; and
- (vi) include minor technical changes.

3.0 Adoption of BCA 2005

- (a) The 2005 edition of the BCA was adopted as set out in Table 3.0.

Table 3.0 History of adoption of BCA 2005

Administration	Adoption Date
Australian Government	1 May 2005
Australian Capital Territory	1 May 2005
New South Wales	1 May 2005
Northern Territory	1 May 2005
Queensland	1 May 2005
South Australia	1 May 2005
Tasmania	1 May 2005
Victoria	1 May 2005
Western Australia	1 May 2005

- (b) The purpose of BCA 2005 is to—
- (i) update references to Standards; and
 - (ii) clarify when fire sprinklers are required to be installed in buildings; and
 - (iii) update the provisions for waterproofing of wet areas; and
 - (iv) include energy efficiency measures for Class 2 and 3 buildings and Class 4 parts; and
 - (v) more closely align the requirements for lifts with those of Occupational Health and Safety legislation; and
 - (vi) include minor technical changes.

4.0 Adoption of BCA 2006

- (a) The 2006 edition of the BCA was adopted as set out in Table 4.0.

Table 4.0 History of adoption of BCA 2006

Administration	Adoption Date
Australian Government	1 May 2006
Australian Capital Territory	1 May 2006
New South Wales	1 May 2006 (except that the date for mandatory compliance with Section J provisions for Class 5 to 9 buildings is 1 November 2006)
Northern Territory	1 May 2006
Queensland	1 May 2006
South Australia	1 May 2006, except for Part I2 and Section J which were adopted on 1 August 2006
Tasmania	1 May 2006
Victoria	1 May 2006
Western Australia	1 May 2006

- (b) The purpose of BCA 2006 is to—
- (i) update schedule of referenced documents; and
 - (ii) include a national testing regime for cladding in cyclonic areas; and
 - (iii) withdraw of AS1530.3 tests on floor materials and floor coverings and wall and ceiling linings; and
 - (iv) include energy efficiency measures for Class 5 to 9 buildings; and

History of adoption

- (v) include minor technical changes.

5.0 Adoption of BCA 2007

- (a) The 2007 edition of the BCA was adopted by the Commonwealth, States and Territories as set out in Table 5.0.

Table 5.0 History of adoption of BCA 2007

Administration	Adoption Date
Australian Government	1 May 2007
Australian Capital Territory	1 May 2007
New South Wales	1 May 2007
Northern Territory	1 May 2007
Queensland	1 May 2007
South Australia	1 May 2007
Tasmania	1 May 2007
Victoria	1 May 2007
Western Australia	1 May 2007

- (b) The purpose of BCA 2007 is to—
- (i) update references to other documents; and
 - (ii) update energy efficiency provisions including providing additional information; and
 - (ii) include minor technical changes.

6.0 Adoption of BCA 2008

- (a) The 2008 edition of the BCA was adopted by the Commonwealth, States and Territories as set out in Table 6.0.

Table 6.0 History of adoption of BCA 2008

Administration	Adoption Date
Australian Government	1 May 2008
Australian Capital Territory	1 May 2008
New South Wales	1 May 2008
Northern Territory	1 May 2008
Queensland	1 May 2008
South Australia	1 May 2008
Tasmania	1 May 2008
Victoria	1 May 2008
Western Australia	1 May 2008

- (b) The purpose of BCA 2008 is to—
- (i) update references to other documents; and
 - (ii) due to changes in the types of detectors now available, rather than only allowing the use of a heat detectors when smoke detector would be unsuitable in the atmosphere, to also allow the use of any type of detector deemed suitable by AS 1670.1; and
 - (iii) clarify the intent of the BCA when a service penetrates a building element required to have an FRL; and
 - (iv) amend the requirements for door handle heights to be consistent with AS 1428.1; and
 - (v) align some BCA terms with current industry terminology; and
 - (vi) include lists of other Commonwealth, State and Territory legislation affecting buildings; and
 - (vii) include suitable provisions for swimming pool water recirculation systems; and
 - (viii) include minor technical changes.

History of adoption

7.0 Adoption of BCA 2009

(a) The 2009 edition of the BCA was adopted by the Commonwealth, States and Territories as set out in Table 7.0.

Table 7.0 History of adoption of BCA 2009

Administration	Adoption Date
Australian Government	1 May 2009
Australian Capital Territory	1 May 2009
New South Wales	1 May 2009
Northern Territory	1 May 2009
Queensland	1 May 2009
South Australia	1 May 2009
Tasmania	1 May 2009
Victoria	1 May 2009
Western Australia	1 May 2009

(b) The purpose of BCA 2009 is to—

- (i) update references to other documents; and
- (ii) after expiry of the agreed transition period, except for the 1993 edition of AS 1170.4, delete all references to the older loading standards contained in the AS 1170 series and consequently, all provisions referring to them; and
- (iii) clarify the application of the vertical separation provisions; and
- (iv) clarify the intent of separation of equipment; and
- (v) simplify the wire balustrade provisions, including the addition of a *Verification Method*; and
- (vi) clarify the provisions for the construction of sanitary compartments to enable an unconscious occupant to be removed; and
- (vii) clarify the height of rooms in an attic and with a sloping ceiling; and
- (viii) further update the energy efficiency provisions; and
- (ix) include minor technical changes.

8.0 Adoption of BCA 2010

(a) The 2010 edition of the BCA was adopted by the Commonwealth, States and Territories as set out in Table 8.0.

Table 8.0 History of adoption of BCA 2010

Administration	Adoption Date
Australian Government	1 May 2010
Australian Capital Territory	1 May 2010
New South Wales	1 May 2010
Northern Territory	1 May 2010
Queensland	1 May 2010
South Australia	1 May 2010 except for Section J, which was adopted on 1 September 2010, and the restriction on child resistant door sets in G1.1 and the additional bushfire requirements for 'excluded areas' prescribed in SA G5.2(d) and (e), which were adopted on 2 December 2010.
Tasmania	1 May 2010
Victoria	1 May 2010
Western Australia	1 May 2010

(b) The purpose of BCA 2010 is to—

- (i) update references to other documents; and

History of adoption

- (ii) delete reference to the 1993 edition of AS 1170.4 and consequently all provisions referring to it; and
- (iii) increase the stringency of the energy efficiency provisions and, as part of reducing greenhouse gas emissions, introduce provisions for the greenhouse gas intensity of the energy source for services such as water and space heaters; and
- (iv) update **Part G5**, as a consequence of referencing the 2009 edition of AS 3959 construction in bushfire-prone areas, to include provisions which apply to a Class 10a building or deck associated with a Class 2 or 3 building located in a *designated bushfire prone area*; and
- (v) include minor technical changes.

9.0 Adoption of BCA 2011

- (a) The 2011 edition of the BCA was adopted by the Commonwealth, States and Territories as set out in **Table 9.0**.

Table 9.0 History of adoption of BCA 2011

Administration	Adoption Date
Australian Government	1 May 2011
Australian Capital Territory	1 May 2011
New South Wales	1 May 2011
Northern Territory	1 May 2011
Queensland	1 May 2011
South Australia	1 May 2011
Tasmania	1 May 2011
Victoria	1 May 2011
Western Australia	1 May 2011

- (b) The purpose of BCA 2011 is to—
- (i) update references to other documents; and
 - (ii) align the BCA with the Access Code in the Disability (Access to Premises — Buildings) Standards; and
 - (iii) restructure the fire hazard property provisions; and
 - (iv) include minor technical changes.

10.0 Adoption of BCA 2012

- (a) The 2012 edition of the BCA was adopted by the Commonwealth, States and Territories as set out in **Table 10.0**.

Table 10.0 History of adoption of BCA 2012

Administration	Adoption Date
Australian Government	1 May 2012
Australian Capital Territory	1 May 2012
New South Wales	1 May 2012
Northern Territory	1 May 2012
Queensland	1 May 2012
South Australia	1 May 2012
Tasmania	1 May 2012
Victoria	1 May 2012
Western Australia	1 May 2012

- (b) The purpose of BCA 2012 is to—
- (i) update references to other documents; and
 - (ii) include revised provisions aimed at reducing slips, trips and falls in buildings; and
 - (iii) include a Verification Method for emergency lighting; and
 - (iv) align the BCA with changes to the National Quality Standard for early childhood education and care; and

History of adoption

- (v) include exemptions for Class 8 electricity network substations; and
- (vi) include minor technical changes.

11.0 Adoption of BCA 2013

- (a) The 2013 edition of the BCA was adopted by the Commonwealth, States and Territories as set out in [Table 11.0](#).

Table 11.0 History of adoption of BCA 2013

Administration	Adoption Date
Australian Government	1 May 2013
Australian Capital Territory	1 May 2013
New South Wales	1 May 2013
Northern Territory	1 May 2013
Queensland	1 May 2013
South Australia	1 May 2013
Tasmania	1 May 2013
Victoria	1 May 2013
Western Australia	1 May 2013

- (b) The purpose of BCA 2013 is to—
- (i) update references to other documents; and
 - (ii) include new provisions for openable windows to reduce falls in buildings; and
 - (iii) include a Performance Requirement and reference a Standard for construction in flood hazard areas; and
 - (iv) consolidate the building related components of the AS 1735 lift series into the BCA; and
 - (v) enhance the egress provisions for people with disability; and
 - (vi) include minor technical changes.

12.0 Adoption of BCA 2014

- (a) The 2014 edition of the BCA was adopted by the Commonwealth, States and Territories as set out in [Table 12.0](#).

Table 12.0 History of adoption of BCA 2014

Administration	Adoption Date
Australian Government	1 May 2014
Australian Capital Territory	1 May 2014
New South Wales	1 May 2014
Northern Territory	1 May 2014
Queensland	1 May 2014
South Australia	1 May 2014
Tasmania	1 May 2014
Victoria	1 May 2014
Western Australia	1 May 2014

- (b) The purpose of BCA 2014 is to—
- (i) update references to other documents; and
 - (ii) quantify slip resistance on ramps, stairways and landings; and
 - (iii) include provisions for photoluminescent exit signs; and
 - (iv) expand the fire-resistance concession for timber-framed construction to include Class 3 buildings; and
 - (v) remove the requirement for fire hose reels in a Class 2 or Class 3 building or a Class 4 part of a building; and
 - (vi) include minor technical changes.

History of adoption

13.0 Adoption of BCA 2015

(a) The 2015 edition of the BCA was adopted by the Commonwealth, States and Territories as set out in [Table 13.0](#).

Table 13.0 History of adoption of BCA 2015

Administration	Adoption Date
Australian Government	1 May 2015
Australian Capital Territory	1 May 2015
New South Wales	1 May 2015
Northern Territory	1 May 2015
Queensland	1 May 2015
South Australia	1 May 2015
Tasmania	1 May 2015
Victoria	1 May 2015
Western Australia	1 May 2015

(b) The purpose of BCA 2015 is to—

- (i) update references to other documents; and
- (ii) include a Verification Method for structural reliability; and
- (iii) improve the usability of the barrier provisions; and
- (iv) expand the requirements for sprinkler protection to aged care buildings; and
- (v) include a Verification Method for weatherproofing of external walls; and
- (vi) improve the usability of energy efficiency provisions for air-conditioning and ventilation systems.

14.0 Adoption of NCC Volume One 2016

(a) The 2016 edition of NCC Volume One was adopted by the Commonwealth, States and Territories as set out in [Table 14.0](#).

Table 14.0 History of adoption of NCC Volume One 2016

Administration	Adoption Date
Australian Government	1 May 2016
Australian Capital Territory	1 May 2016
New South Wales	1 May 2016
Northern Territory	1 May 2016
Queensland	1 May 2016
South Australia	1 May 2016
Tasmania	1 May 2016
Victoria	1 May 2016
Western Australia	1 May 2016

(b) The purpose of NCC Volume One 2016 is to—

- (i) update references to other documents; and
- (ii) amend the “Introduction” and “General Requirements” as part of the initiative to increase the use of Performance Solutions; and
- (iii) include new Verification Methods for structural robustness and indoor air quality; and
- (iv) include provisions for fire-protected timber; and
- (v) include requirements for farm-type buildings; and
- (vi) include minor technical changes.

History of adoption

14.1 Amendment No. 1

- (a) Amendment 1 to the 2016 edition of NCC Volume One was adopted by the Commonwealth, States and Territories as set out in [Table 14.1](#).

Table 14.1 History of adoption of NCC 2016 Volume One Amendment 1

Administration	Adoption Date
Australian Government	12 March 2018
Australian Capital Territory	12 March 2018
New South Wales	12 March 2018
Northern Territory	12 March 2018
Queensland	12 March 2018
South Australia	12 March 2018
Tasmania	12 March 2018
Victoria	12 March 2018
Western Australia	12 March 2018

- (b) the purpose of NCC Volume One Amendment 1 is to—
- (i) introduce a new Verification method, [CV3](#), for limiting fire spread via external wall assemblies; and
 - (ii) include reference to the revised edition of AS 2118.1; and
 - (iii) clarify provisions relating to the use of external wall claddings and attachments; and
 - (iv) revise the evidence of suitability provisions.

15.0 Adoption of NCC Volume One 2019

- (a) The 2019 edition of NCC Volume One was adopted by the Commonwealth, States and Territories as set out in [Table 15.0](#).

Table 15.0 History of adoption of NCC Volume One 2019

Administration	Adoption Date
Australian Government	1 May 2019
Australian Capital Territory	1 May 2019
New South Wales	1 May 2019
Northern Territory	1 May 2019
Queensland	1 May 2019
South Australia	1 May 2019
Tasmania	1 May 2019
Victoria	1 May 2019
Western Australia	1 May 2019

- (b) The purpose of NCC Volume One 2019 is to—
- (i) include the Governing Requirements, that result from revision of Section A to improve readability and are common to all volumes; and
 - (ii) introduce the use of schedules that are common to all volumes; and
 - (iii) include new Verification Methods, including the Fire Safety Verification Method; and
 - (iv) clarify provisions, including provisions relating to measurement of distance between required alternative exits; and
 - (v) expand the requirements for sprinkler protection to residential buildings; and
 - (vi) introduce requirements for accessible adult change facilities; and
 - (vii) introduce requirements for management of water vapour and condensation; and
 - (viii) introduce requirements for occupiable outdoor areas; and

History of adoption

- (ix) increase stringency of energy efficiency requirements; and
- (x) update references to other documents; and
- (xi) include minor technical changes.

15.1 Amendment No. 1

- (a) Amendment 1 to the 2019 edition of NCC Volume One was adopted by the Commonwealth, States and Territories as set out in [Table 15.1](#).

Table 15.1 History of adoption of NCC 2019 Volume One Amendment 1

Administration	Adoption Date
Australian Government	1 July 2020
Australian Capital Territory	1 July 2020
New South Wales	1 July 2020
Northern Territory	1 July 2020
Queensland	1 July 2020
South Australia	1 July 2020
Tasmania	1 July 2020
Victoria	1 July 2020
Western Australia	1 July 2020

- (b) The purpose of NCC Volume One Amendment 1 is to—
- (i) require that a process be followed to improve the quality of and documentation for Performance Solutions; and
 - (ii) include a new provision regarding egress from early childhood centres; and
 - (iii) require labelling of Aluminium Composite Panels; and
 - (iv) clarify the concession that permits timber framing for low-rise Class 2 and 3 buildings.

List of amendments

List of amendments—NCC 2019—Volume One Amendment 1

List of amendments

List of amendments—NCC 2019—Volume One Amendment 1

List of amendments—NCC 2019—Volume One Amendment 1

This list has been prepared by the Australian Building Codes Board to assist National Construction Code (NCC) users in identifying changes incorporated in Amendment 1 to the 2019 edition of NCC Volume One. The notes provide a description of major changes made from the previous edition of Volume One.

While the Australian Building Codes Board has attempted to include all major changes made from the previous edition of Volume One, the Board does not give any warranty nor accept any liability in relation to the contents of this list of amendments.

List of Amendments

Reference	Changes and Commentary
A2.2(4)	A new sub-clause has been added to require a process be followed when undertaking a Performance Solution.
A5.7	A new provision has been added to require labelling of Aluminium Composite Panels.
Specification C1.1 Clause 3.10(a)	The concession has been amended to clarify its application.
Specification C1.1 Clause 4.3(a)	The concession has been amended to clarify its application.
D1.18	A new provision has been added for egress from early childhood centres.
Schedule 2	An abbreviation, 'ACP', has been added for Aluminium Composite Panel.
Schedule 3	A defined term, 'Aluminium Composite Panel (ACP)', has been added.
Schedule 3	The defined term 'Performance-based design brief (PBDB)' has been amended on account of the introduction of A2.2(4).
Schedule 4	The 2019 edition of SA TS 5344 'Permanent labelling for Aluminium Composite Panel (ACP) products' has been referenced.